







# DOM-550-GSO

## 5G IIoT Gateway



### Key Features

 <b>5G SA &amp; NSA</b>	 <b>Dual-SIM Failover</b>
 <b>Modbus TCP/RTU/ASCII</b>	 <b>Wi-Fi AC1200</b>
 <b>Industrial Grade Design</b>	 <b>IT/OT Integration</b>

The DOM-550-GSO 5G IIoT Gateway offers dual-mode 5G NR and 4G LTE connectivity, delivering download speeds of up to 3.4 Gbps. It includes three Gigabit Ethernet ports—one configurable as an Ethernet WAN—for seamless switching between broadband and cellular networks. With Wi-Fi 5 (AC1200) support, it suits a broad range of IIoT deployments. The gateway also provides flexible I/O options, including one RS-232/485 port, two digital inputs, two digital outputs, two analog inputs, as well as USB 2.0 and SD card slots, making it ideal for diverse IT/OT integration scenarios.

### Optimize Operations with IT/OT Integration

Leverage the DOM-550-GSO 5G IIoT Gateway to seamlessly integrate business operations with production processes, enabling enhanced decision-making, greater process automation, and increased productivity. Powered by high-speed 5G connectivity, it ensures rapid integration with remote sensors, devices, and machinery—delivering a significant competitive edge. With versatile interfaces including RS-232/485 and digital I/O, the DOM-550-GSO dynamically responds to input from IoT sensors, boosting automation and real-time responsiveness in industrial environments. This results in streamlined operations and improved efficiency, making it a vital asset for modernizing and optimizing industrial systems.

### Advanced Event Management for Efficient IIoT Operations

The DOM-550-GSO 5G IIoT Gateway significantly streamlines event management by responsive event trigger capabilities. It is engineered to provide immediate notifications through SMS or email when IIoT sensor readings exceed pre-set thresholds, allowing the control center to monitor and control IIoT sensor status remotely via SMS. This feature enhances the efficiency of IIoT monitoring, automation, and timesensitive applications.

### Applications

- Factory Automation
- Solar Power Station
- Environmental Monitoring
- Power Plant
- Traffic/Street Lights
- Elevator
- Gas Station

### Revolutionize Industrial Automation Connectivity with 5G

The DOM-550-GSO 5G IIoT Gateway delivers high-speed, low-latency 5G connectivity for real-time automation, reducing errors and downtime while boosting efficiency. With multi-interface support and seamless Modbus protocol conversion, it enables easy integration between IT and OT systems, transforming industrial operations.

### Connection Diagram

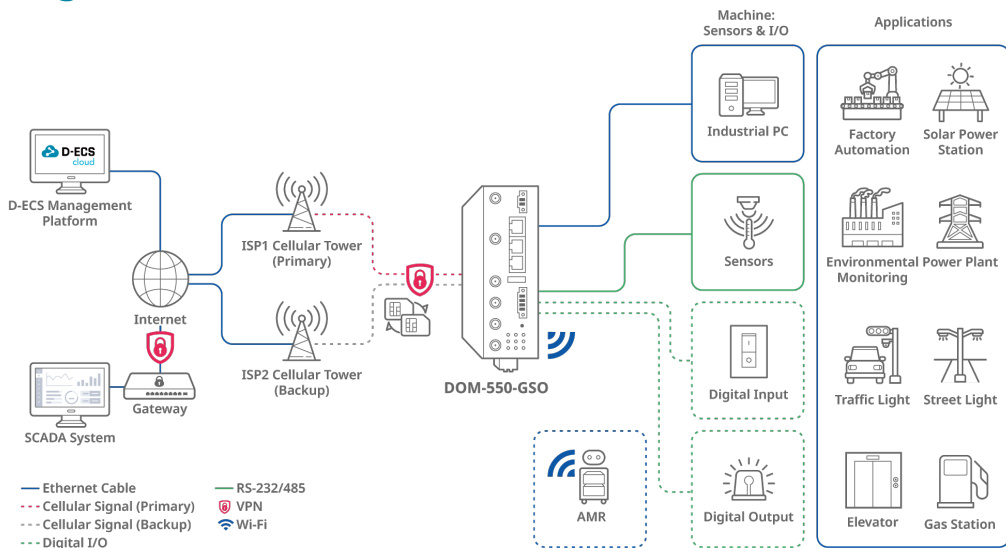

# Specifications

## Device Interface

- Cellular: 3GPP Rel. 16, 5G (sub-6 GHz), 4G (DL Cat 19/UL Cat 18)
- SIM Slot: 2 x SIM (Micro SIM) with auto failover, optional eSIM
- Ethernet: 1 x GE WAN/LAN port, 2 x GE LAN ports
- Wi-Fi: Wi-Fi 5 AC1200 (2.4 GHz/5 GHz)
- Serial Ports:
  - 1 x RS-232 or RS-485 terminal block
  - 2 x DI (isolated, logic 0: 0-2 V, logic 1: 5-30 V)
  - 2 x DO (isolated, non-relayed output, 24 V/300 mA per port) terminal block
- Log Storage: Micro SD slot, USB 2.0 type A
- Power Input: DC 9-36 V terminal block
- Antenna Connectors: 4 x SMA (F) cellular, 2 x SMA (RP-F) Wi-Fi

## Performance<sup>1</sup>

- Maximum Cellular Data Throughput:
  - 5G NSA: 3.4 Gbps (DL) / 550 Mbps (UL)
  - 5G SA: 2.4 Gbps (DL) / 900 Mbps (UL)
  - LTE: 1.6 Gbps (DL) / 200 Mbps (UL)
- Maximum Wi-Fi Data Rate:
  - 2.4 GHz: Up to 300 Mbps
  - 5 GHz: Up to 866 Mbps

## WAN

- WAN Interface: Cellular, Ether-WAN
- Multi-WAN Function: Failover, load balance
- Cellular: NAT, bridge
- Ether-WAN: Dynamic IP, static IP, PPPoE
- Connection Monitoring: Ping/DNS query reboot

## Network

- LAN & VLAN: DHCP server/relay, port/tag-based VLAN
- Routing: Static, dynamic RIPv1/v2, OSPF, BGP
- DDNS: DynDNS, No-IP, dynamic DO
- QoS: Traffic priority queuing by source/destination, service

## Wi-Fi

- Function: Multi SSID, WIDS, AP router mode
- Security: WPA2-PSK, WPA2, WPA-PSK/WPA2-PSK, 802.1x
- Encryption: WEP, AES, TKIP/AES

## Services

- Cellular Toolkit: Data usage, SMS, SIM PIN, network scan
- Event Management: SMS, e-mail, digital I/O

## VPN

- VPN Tunnel: IPSec, OpenVPN, PPTP, L2TP, GRE, WireGuard
- VPN Pass Through: IPSec, PPTP, L2TP

## Security

- Firewall: SPI firewall, IPS, port forward
- Access Control: MAC/IP filter, URL blocking

## Administration

- Management: SNMPv1/2/3, D-Link D-ECS<sup>2</sup>
- Maintenance: Web UI, diagnostic tools via ping/tracert
- System: FW upgrade, backup and restore config, reboot and reset
- Logging: System log, external syslog server, Modbus data

## Monitoring

- Device Status: CPU/memory usage, WAN status, client list
- Cellular Status: IMSI, ICCID, operator, band, RSSI, SINR, RSRP, RSRQ
- Security: VPN status, firewall status
- Statistics and Reports: Cellular signal, cellular usage

## Field Communication

- Virtual COM: TCP client, TCP server, UDP
- Modbus: Modbus TCP/RTU/ASCII master/slave access

## Operating Environment

- Operating Temperature: -30 to 70°C (-22°F to 158°F)
- Storage Temperature: -40 to 85°C (-40°F to 185°F)
- Operating Humidity: 10% to 95% non-condensing
- Storage Humidity: 0 to 95% non-condensing
- Dimensions: 160 x 130.8 x 62 mm

## Certifications and Approvals

- Certifications: CE, UKCA
- Cyber Security: EN 18031-1, EN 18031-2, EN 303645

## Package Contents (Standard)

- 4 x Cellular SMA Antennas
- 2 x Wi-Fi RP-SMA Antennas
- 1 x RJ-45 Cable
- 1 x Power Adapter
- 1 x Terminal Block (2-pin)
- 1 x Terminal Block (4-pin)
- 1 x Terminal Block (10-pin)
- 1 x DIN-Rail Kit

# Available Versions

## EU SKU (HW: A1)

5G NR	n1/n3/n5/n7/n8/n20/n28/n38/n40/n41/n71/n75/n76/n77/n78
4G LTE	FDD: B1/B3/B5/B7/B8/B20/B28/B32/B71
	TDD: B38/B40/B41/B42/B43

## Global SKU (HW: A2)

5G NR	n1/n2/n3/n5/n7/n8/n12/n13/n14/n18/n20/n25/n26/n28/n29/n30/n38/n40/n41/n48/n66/n70/n71/n75/n76/n77/n78/n79
4G LTE	FDD: B1/B2/B3/B4/B5/B7/B8/B12/B13/B14/B17/B18/B19/B20/B25/B26/B28/B29/B30/B32/B66/B71
	TDD: B34/B38/B39/B40/B41/B42/B43/B46(LAA)/B48

<sup>1</sup> Data rates are theoretical. Data transfer rate depends on network capacity and signal strength.  
<sup>2</sup> You only have to pay a M2M device license fee required when applying for D-ECS license.

# Hardware

## Front View

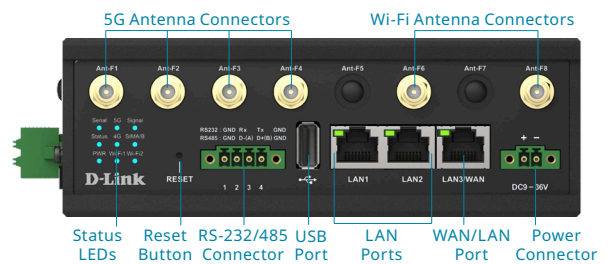

## Side View

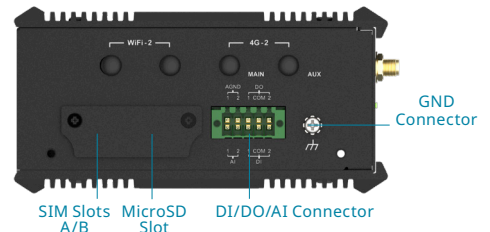

Actual performances may vary due to settings, cabling, temperature, network configuration, interface, device compatibility, environmental and on-site conditions, and other similar factors. References to power capability, signal or processing speed, signal range or distance, data encryption, storage capacity, display properties, or other performance metrics are based on optimal conditions derived from industry standards and provided for informational purposes only. Specifications may be subject to change without prior notice.

# Spatial Measurement

The following diagrams provide the product's physical dimensions measured from top, front, left, and right views for installation and integration reference.

Unit: mm

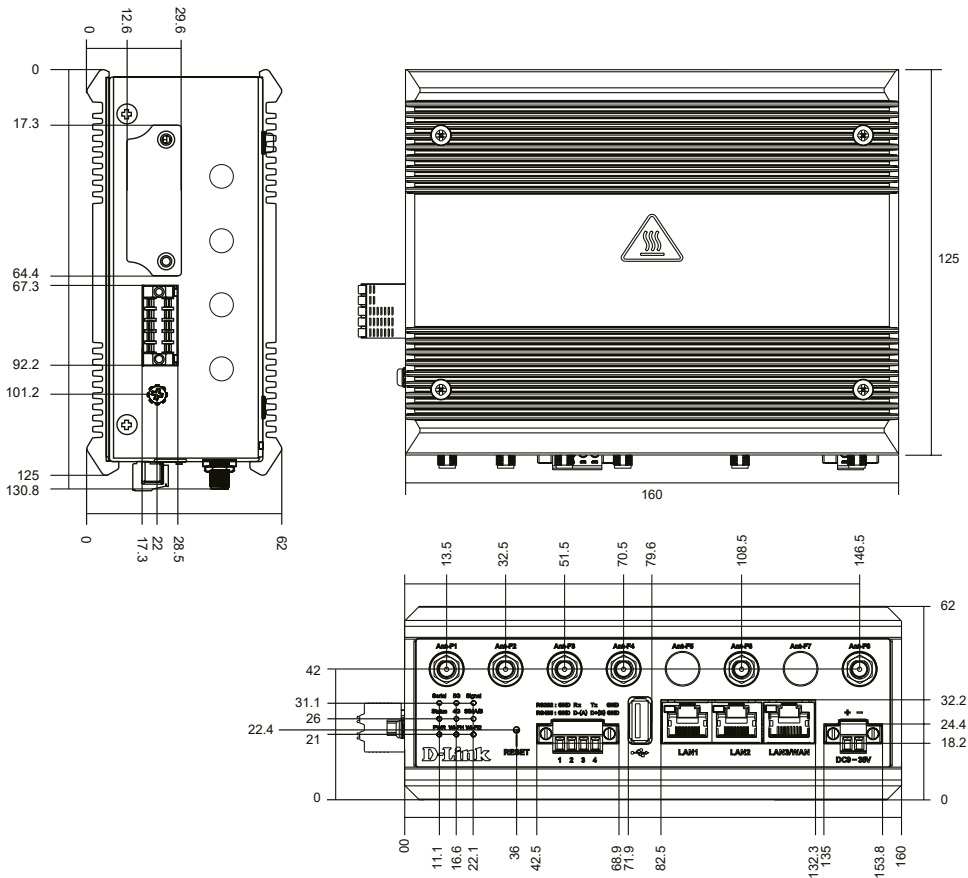

## Mounting Space Requirements

