



## Quick Installation Guide 802.11n Dual-Band Unified Access Point

This document will guide you through the basic installation process for your new D-Link Unified Wireless Access Point.

**DWL-6700AP**



## ENGLISH

### IMPORTANT INFORMATION

This product should **ONLY** be installed by an experienced installer who is familiar with local building and safety codes and, where applicable, is licensed by the appropriate authorities. Failure to employ an experienced installer may render the D-Link product warranty void and may also expose the end user or the service provider to legal and financial liabilities. D-Link and its resellers or distributors expressly disclaim any and all liabilities for injury, damage, or violation of regulations due to the improper installation of outdoor units or antennas.

A safety grounding system is necessary to protect your outdoor installation from lightning strikes and the build-up of static electricity. Direct grounding of an outdoor AP is very important and can protect your networks from brutal outdoor environments and devastating ESD attacks. The grounding system must comply with the National Electrical Code and safety standards that apply in your country and/ or region. Always check with a qualified electrician if you are in doubt as to whether your outdoor installation is properly grounded.

## DEUTSCH

### WICHTIGE INFORMATIONEN

Dieses Produkt darf **AUSSCHLIESSLICH** von einer erfahrenen Installationsfachkraft installiert werden, die mit den Gebäude- und Sicherheitsvorschriften vor Ort vertraut ist und über die entsprechende Lizenz der zuständigen Behörden verfügt. Wird dem nicht nachgekommen und es wird keiner erfahrenen Installationsfachkraft der Auftrag erteilt, erlischt seitens D-Link gegebenenfalls die Garantie für das Produkt und es kann darüber hinaus für den Endbenutzer oder den Dienstleister rechtliche und finanzielle Haftungsansprüche zur Folge haben. D-Link und seine Fachhändler oder Vertriebspartner schließen ausdrücklich jegliche Haftung für entstandene Verletzungen, Schäden oder Verstöße gegen Vorschriften aus, die sich eventuell auf Grund einer unsachgemäßen Installation der Geräte oder Antennen in Außenbereichen ergeben.

Zum Schutz Ihrer Außeninstallation vor Blitzschlägen und zum Schutz vor elektrostatischer Aufladung ist ein Erdungssystem erforderlich. Eine direkte Erdung des Access Point in Außenbereichen ist sehr wichtig und kann Ihre Netzwerke vor äußeren Einflüssen und elektrostatischen Entladungen schützen. Das Erdungssystem muss den entsprechenden nationalen und/oder regionalen elektrotechnischen Sicherheitsvorschriften und Sicherheitsstandards entsprechen. Bitten Sie einen qualifizierten Elektriker um eine entsprechende Prüfung und/oder Bestätigung, wenn Sie nicht sicher sind, ob Ihre Außeninstallation ordnungsgemäß geerdet ist.

## FRANÇAIS

### RENSEIGNEMENTS IMPORTANTS

Ce produit ne doit être installé **QUE** par un installateur expérimenté, familier avec les codes de sécurité et les normes locales du bâtiment, si applicables, et détenteur d'une licence délivrée par les autorités compétentes. Le non-respect de cette consigne peut rendre la garantie du produit D-Link nulle et exposer aussi l'utilisateur ou le prestataire de service à des poursuites légales et financières. D-Link et ses revendeurs ou distributeurs renoncent à toute responsabilité relative aux blessures, aux dommages ou aux infractions aux règlements potentiellement associés à l'installation d'appareils ou d'antennes en extérieur.

Un système de protection de mise à la terre est nécessaire pour protéger votre installation extérieure des foudroiements et de l'accumulation d'électricité statique. La mise à la terre directe d'un Point d'accès extérieur est très importante et peut protéger vos réseaux des environnements extérieurs brutaux et des attaques ESD (décharges électrostatiques) dévastatrices. Le système de mise à la terre doit être conforme au Code d'électricité national et aux normes de sécurité en vigueur dans votre pays et/ou région. Toujours vérifier auprès d'un électricien qualifié si vous avez des doutes quant à savoir si votre installation extérieure est correctement mise à la terre.

## ESPAÑOL

### INFORMACIÓN IMPORTANTE

Este producto debe ser instalado ÚNICAMENTE por un instalador experimentado que esté familiarizado con las normas de construcción y seguridad locales y, cuando corresponda, esté autorizado por las autoridades pertinentes. No emplear un instalador experimentado puede invalidar la garantía del producto D-Link y, asimismo, exponer al usuario final o al proveedor del servicio a responsabilidades jurídicas y financieras. D-Link y sus proveedores o distribuidores rechazan expresamente todas y cada una de las responsabilidades por las lesiones, los daños o la violación de normativas debidas a la instalación incorrecta de unidades o antenas para exteriores.

Es necesario un sistema de conexión a tierra de seguridad para proteger la instalación exterior de los rayos y de la acumulación de electricidad estática. La conexión a tierra directa de un AP externo es muy importante y puede proteger las redes frente a entornos externos brutales y ataques de ESD desastrosos. El sistema de conexión a tierra debe cumplir el Código eléctrico nacional y las normas de seguridad aplicables en su país o región. Consulte siempre con un electricista cualificado si tiene dudas sobre si la instalación de exterior cuenta con la toma de tierra adecuada.

## ITALIANO

### INFORMAZIONI IMPORTANTI

Questo prodotto deve essere installato SOLO da personale altamente specializzato che abbia la necessaria esperienza con le regole di sicurezza e che abbia il regolare permesso di installazione fornito dagli enti competenti. L'installazione eseguita da personale non specializzato può invalidare la garanzia del prodotto D-Link, nonché esporre l'utente finale a sanzioni legali e pecuniarie. D-Link e i propri rivenditori o distributori non riconoscono espressamente nessun tipo di responsabilità per lesioni, danni o violazione delle norme associate all'installazione errata di unità esterne o antenne.

Per proteggere l'installazione esterna dai fulmini e dall'accumulo di elettricità statica, è necessario un sistema di messa a terra di sicurezza. La messa a terra diretta di un punto di accesso per esterni è estremamente importante e può proteggere le reti in caso di condizioni esterne sfavorevoli e attacchi ESD di particolare rilevanza. Il sistema di messa a terra deve essere conforme al National Electrical Code e agli standard di sicurezza in vigore nel proprio paese e/o area geografica. Consultare sempre un elettricista qualificato in caso di dubbi sulla corretta messa a terra dell'installazione esterna.

# Before You Begin

This chapter describes safety precautions and product information you have to know and check before installing DWL-6700AP.

## Professional Installation Required

1. Please seek assistance from a professional installer who is well trained in the RF installation and knowledgeable in the local regulations.
2. The DWL-6700AP is distributed through distributor and system installer with professional technicians and will not be sold directly through retail store. To keep you safe and install the hardware properly, please read and follow these safety precautions.

## Safety Precautions

To keep you safe and install the hardware properly, please read and follow these safety precautions.

1. If you are installing an antenna for the first time, for your safety as well as others', please seek assistance from a professional installer who has received safety training on the hazards involved.
2. Keep safety as well as performance in mind when selecting your installation site, especially where there are electric power and phone lines.
3. When installing your antenna, note the following:
  - Do not use a metal ladder;
  - Do not work on a wet or windy day;
  - Wear shoes with rubber soles and heels, rubber gloves, long sleeved shirt or jacket.
4. When the system is operational, avoid standing directly in front of the antenna. Strong RF fields are present when the transmitter is on.
5. A safety grounding system is necessary to protect your outdoor installation from lightning strikes and the build-up of static electricity. When mounting the Outdoor AP on the antenna mast, you have to connect the Outdoor AP to the same grounding system\* with the AC wall outlet.
6. Always check with a qualified electrician if you are in doubt as to whether your outdoor installation is properly grounded.

## About This Guide

This installation guide provides basic instructions for installing the DWL-6700AP Wireless Access Point on your network. For additional information about how to use the Access Point, please see the User Manual, which is available on the CD included in this package or from the D-Link support website.

## System Requirements

- CD-ROM Drive
- Windows®, Macintosh®, or Linux-based operating system
- Ethernet port or installed Ethernet adapter
- Internet Explorer 7.0, Safari 5.0, Firefox 4.0, or higher

## Unpacking the Product

Open the shipping carton and carefully unpack its contents. Please consult the packing list below to make sure all items are present and undamaged. If any item is missing or damaged, please contact your local D-Link reseller for a replacement.

- DWL-6700AP 802.11n Unified Access Point
- Power Cord
- PoE adapter (24 V / 1 A)
- Shielded Cat 5E Ethernet Cable
- Mounting Ties (Qty. 2)
- Wall Mount Base
- CD-ROM
- Grounding Wire

**Note:** Using a different PoE adapter from the one included with the DWL-6700AP may cause damage and will void the warranty for this product.

## Optional Accessories

- N/A

Note: These accessories are not included in the package. If any of these items are required, please contact your reseller to order it.

## Hardware Overview

### LEDs

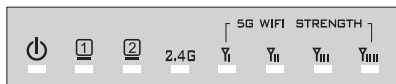

Figure 1. DWL-6700AP LEDs

**Status (Green):** Blinks if there is a system error. When the completes booting, the LED will be solid green.

### 5 GHz WiFi Strength

#### WDS Mode:

**LED1 (red):** Signal strength 20%

**LED2 (amber):** Signal strength 40%

**LED3 (green):** Signal strength 60%

**LED4 (green):** Signal strength 80%

#### AP Mode:

**LED1 (red):** The radio is up, LED is solid red, and blinks whenever is data transmitting/receiving.

**LED2 (amber):** Off

**LED3 (green):** Off

**LED4 (green):** Off

**2.4 GHz (green):** The radio is up, LED is solid green, and blinks whenever is data transmitting/receiving.

**LAN1 (PoE in) (green):** The physical connection is up, LED is solid green, and blinks whenever is data transmitting/receiving.

**LAN2 (PoE in) (green):** The physical connection is up, LED is solid green, and blinks whenever is data transmitting/receiving.

## Interfaces

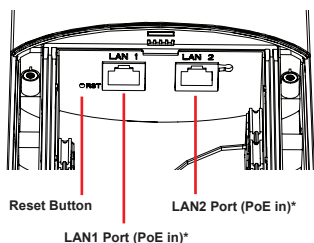

Figure 2. DWL-6700AP Rear Panel

\* DWL-6700AP can be powered by the included PoE adapter from either LAN1 or LAN2

## Installation

### Power on the access point

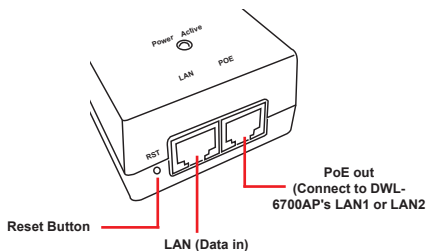

Figure 3. PoE Adapter Panel

To power on the DWL-6700AP, you can only use the proprietary PoE adapter included with the DWL-6700AP.

1. Connect the supplied PoE adapter and power cord to the AC power source.
2. Plug one end of an Ethernet cable into the LAN1 (or LAN2) port of the DWL-6700AP and the other end into a PoE out from a PoE adapter.

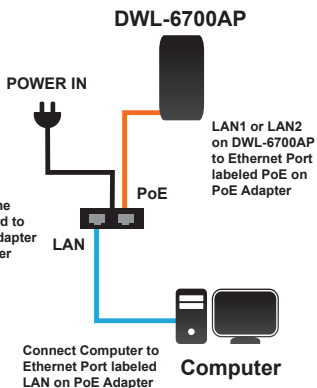

Figure 4. Deployment Example

### Configure the access point

To set up and manage the DWL-6700AP, use one of the following methods:

- LAN1 or LAN2 on DWL-6700AP to Ethernet Port labeled POE on PoE Adapter
- Connect the Power Cord to the PoE Adapter and a power outlet
- Connect Computer to Ethernet Port labeled LAN on PoE Adapter



- Manage the access point from the computer: Connect the access point and your computer directly via a straight-through Ethernet cable.

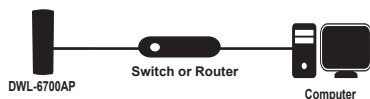

- Manage the access point from the computer via the Switch or Router: Connect the access point and your computer to the same switch or router.

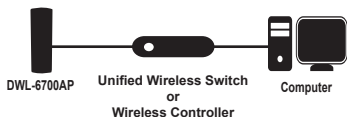

- Manage the access point from the computer via the Unified Wireless Switch or Wireless Controller: Connect the access point to a Unified Wireless Switch or Wireless Controller. Connect your computer to the same network as that of the Unified Wireless Switch or Wireless Controller.

## Mounting Options

Pole Mount and Wall Mount are options for the DWL-6700AP.

### Cable Requirement

Use a Cat 5 cable with an even sheath. The Ethernet ports on the DWL-6700AP access point cannot accept a Cat 5 cable that has an uneven sheath; the RJ-45 connector on the cable will not fit properly into the receptacle on the access point.

**Warning:** The DWL-6700AP is designed to receive PoE power only from the proprietary PoE adapter (24 V/1 A) included with the DWL-6700AP. The DWL-6700AP is **NOT** an 802.3af-compliant device. Connecting an access point to a Power over Ethernet (PoE) device that is not approved by D-Link can damage the equipment.

## Pole Mounting Installation

### Installation

1. Open the bottom panel with a Hex screwdriver (T8).

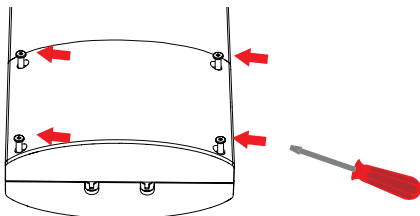

2. Plug the one end of Cat 5 cable into the LAN1 or LAN2 port on DWL-6700AP, and the other end to the port labeled PoE on the PoE Adapter.

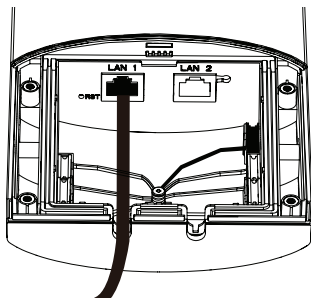

3. Choose a gasket (6 mm or 4 mm) to fit the Ethernet cable; if LAN2 is not in-use, please take off the black gasket.

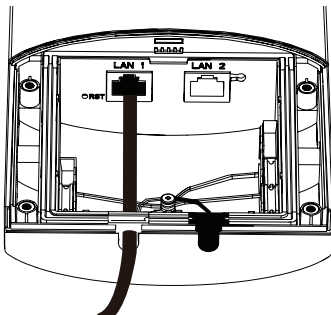

4. Close the bottom panel with a Hex screwdriver (T8).

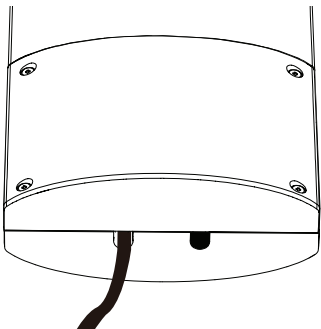

5. Attach a grounding wire.

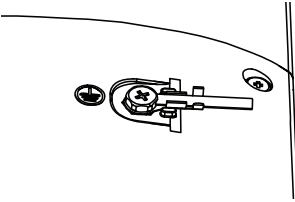

7. Fasten the mounting ties.

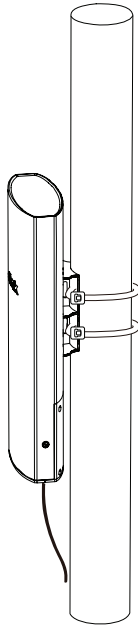

6. Attach access point to a pole

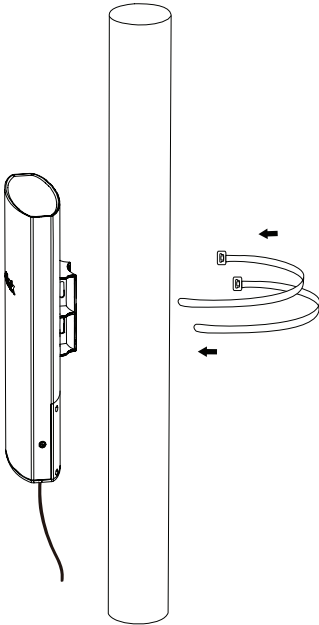



# Wall Mounting Installation

## Installation

1. Use the supplied screws to attach the Wall Mount Base to the wall.

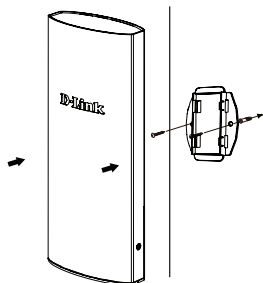

2. Attach DWL-6700AP to the Wall Mount Base. Thread and fasten the Mounting Ties.

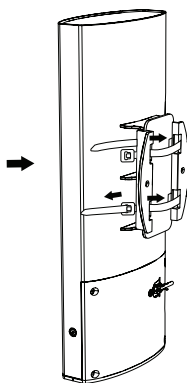

## Appendix A - Statements

### Federal Communication Commission Interference Statement

This equipment has been tested and found to comply with the limits for a Class B digital device, pursuant to Part 15 of the FCC Rules. These limits are designed to provide reasonable protection against harmful interference in a residential installation. This equipment generates, uses and can radiate radio frequency energy and, if not installed and used in accordance with the instructions, may cause harmful interference to radio communications. However, there is no guarantee that interference will not occur in a particular installation. If this equipment does cause harmful interference to radio or television reception, which can be determined by turning the equipment off and on, the user is encouraged to try to correct the interference by one of the following measures:

- Reorient or relocate the receiving antenna.
- Increase the separation between the equipment and receiver.
- Connect the equipment into an outlet on a circuit different from that to which the receiver is connected.
- Consult the dealer or an experienced radio/TV technician for help.

**FCC Caution:** Any changes or modifications not expressly approved by the party responsible for compliance could void the user's authority to operate this equipment.

This device complies with Part 15 of the FCC Rules. Operation is subject to the following two conditions: (1) This device may not cause harmful interference, and (2) this device must accept any interference received, including interference that may cause undesired operation.

### **IMPORTANT NOTE:**

#### **Radiation Exposure Statement:**

This equipment complies with FCC radiation exposure limits set forth for an uncontrolled environment. This equipment should be installed and operated with minimum distance 20cm between the radiator & your body.

This transmitter must not be co-located or operating in conjunction with any other antenna or transmitter.

Country Code selection feature to be disabled for products marketed to the US/CANADA

### Professional installation instruction

Please be advised that due to the unique function supplied by this product, the device is intended for use with our interactive entertainment software and licensed third-party only. The product will be distributed through controlled distribution channel and installed by trained professional and will not be sold directly to the general public through retail store.

#### 1. Installation personal

This product is designed for specific application and needs to be installed by a qualified personal who has RF and related rule knowledge. The general user shall not attempt to install or change the setting.

#### 2. Installation location

The product shall be installed at a location where the radiating antenna can be kept 20cm from nearby person in normal operation condition to meet regulatory RF exposure requirement.

#### 3. External antenna

Use only the antennas which have been approved by the applicant. The non-approved antenna(s) may produce unwanted spurious or excessive RF transmitting power which may lead to the violation of FCC/IC limit and is prohibited.

#### 4. Installation procedure

Please refer to user's manual for the detail.

#### 5. Warning

Please carefully select the installation position and make sure that the final output power does not exceed the limit set force in relevant rules. The violation of the rule could lead to serious federal penalty.

#### Industry Canada statement

This device complies with Industry Canada's licence-exempt RSSs. Operation is subject to the following two conditions:

(1) This device may not cause interference; and (2) This device must accept any interference, including interference that may cause undesired operation of the device.

Cet appareil est conforme aux CNR exemptes de licence d'Industrie Canada. Son fonctionnement est soumis aux deux conditions suivantes:

(1) Ce dispositif ne peut causer d'interférences; et(2) Ce dispositif doit accepter toute interférence, y compris les interférences qui peuvent causer un mauvais fonctionnement de l'appareil.

#### Caution:

(i) the maximum antenna gain permitted for devices in the bands 5250-5350 MHz and 5470-5725 MHz shall comply with the e.i.r.p. limit; and

(ii) the maximum antenna gain permitted for devices in the band 5725-5825 MHz shall comply with the e.i.r.p. limits specified for point-to-point and non point-to-point operation as appropriate.

(iii) Users should also be advised that high-power radars are allocated as primary users (i.e. priority users) of the bands 5250-5350 MHz and 5650-5850 MHz and that these radars could cause interference and/or damage to LE-LAN devices.

#### Avertissement:

(i) le gain maximal d'antenne permis pour les dispositifs utilisant les bandes 5 250-5 350 MHz et 5 470-5 725 MHz doit se conformer à la limite de p.i.r.e.;

(ii) le gain maximal d'antenne permis (pour les dispositifs utilisant la bande 5 725-5 825 MHz) doit se conformer à la limite de p.i.r.e. spécifiée pour l'exploitation point à point et non point à point, selon le cas.

(iii) De plus, les utilisateurs devraient aussi être avisés que les utilisateurs de radars de haute puissance sont désignés utilisateurs principaux (c.-à-d., qu'ils ont la priorité) pour les bandes 5 250-5 350 MHz et 5 650-5 850 MHz et que ces radars pourraient causer du brouillage et/ou des dommages aux dispositifs LAN-EL.

#### Radiation Exposure Statement:

This equipment complies with IC radiation exposure limits set forth for an uncontrolled environment. This equipment should be installed and operated with minimum distance 20cm between the radiator & your body.

#### Déclaration d'exposition aux radiations:

Cet équipement est conforme aux limites d'exposition aux rayonnements IC établies pour un environnement non contrôlé. Cet équipement doit être installé et utilisé avec un minimum de 20 cm de distance entre la source de rayonnement et votre corps.

**Instructions d'installation professionnelle**

Veillez noter que l'appareil est dédié à une fonction unique, il doit être utilisé avec notre logiciel propriétaire de divertissement interactif. Ce produit sera proposé par un réseau de distribution contrôlé et installé par des professionnels; il ne sera pas proposé au grand public par le réseau de la grande distribution.

**1. Installation**

Ce produit est destiné à un usage spécifique et doit être installé par un personnel qualifié maîtrisant les radiofréquences et les règles s'y rapportant. L'installation et les réglages ne doivent pas être modifiés par l'utilisateur final.

**2. Emplacement d'installation**

En usage normal, afin de respecter les exigences réglementaires concernant l'exposition aux radiofréquences, ce produit doit être installé de façon à respecter une distance de 20 cm entre l'antenne émettrice et les personnes.

**3. Antenne externe.**

Utiliser uniquement les antennes approuvées par le fabricant. L'utilisation d'autres antennes peut conduire à un niveau de rayonnement essentiel ou non essentiel dépassant les niveaux limites définis par FCC/IC, ce qui est interdit.

**4. Procédure d'installation**

Consulter le manuel d'utilisation.

**5. Avertissement**

Choisir avec soin la position d'installation et s'assurer que la puissance de sortie ne dépasse pas les limites en vigueur. La violation de cette règle peut conduire à de sérieuses pénalités fédérales.

**NCC 警語：**

電磁波曝露量MPE標準值(MPE) 1mW/cm<sup>2</sup>，送測產品實值為0.178mW/cm<sup>2</sup>

經型式認證合格之低功率射頻電機，非經許可，公司、商號或使用者均不得擅自變更頻率、加大功率或變更原設計之特性及功能。

低功率射頻電機之使用不得影響飛航安全及干擾合法通信；經發現有干擾現象時，應立即停用，並改善至無干擾時方得繼續使用。

前項合法通信，指依電信法規定作業之無線電通信。低功率射頻電機須忍受合法通信或工業、科學及醫療用電波輻射性電機設備之干擾。

**無線傳輸設備 (UNII)**

無線資訊傳輸設備忍受合法通信之干擾且不得干擾合法通信；如造成干擾，應立即停用，俟無干擾之虞，始得繼續使用。

無線資訊傳輸設備的製造廠商應確保頻率穩定性，如依製造廠商使用手冊上所述正常操作，發射的信號應維持於操作頻帶中。

本器材須經專業工程人員安裝及設定，始得設置使用，且不得直接販售給一般消費者

Conducted power for each antenna (dBm)		
Mode	Saw Filter Source	
	1	2
11b, 1TX	24.76	24.90
11b, 2TX	26.48	26.53
11g, 1TX	29.03	29.30
11g, 2TX	29.80	29.98
HT20	29.90	29.93
HT40	29.58	29.68
11a, 1TX	25.52	25.52
11a, 2TX	27.12	27.12
HT20	26.84	26.84
HT40	26.79	26.79

**CE Mark Warning:**

This is a Class B product. In a domestic environment, this product may cause radio interference, in which case the user may be required to take adequate measures.

**DWL-6700AP****Power Usage**

This device is an Energy Related Product (ErP) with High Network Availability (HiNA), and automatically switches to a power-saving Network Standby mode within 1 minute of no packets being transmitted. If it is not needed during certain periods of time, it can be unplugged to save energy.

Network Standby: 3.90 watts

TECHNICAL SUPPORT	<a href="http://dlink.com/support">dlink.com/support</a>
TECHNISCHE UNTERSTÜTZUNG	
ASSISTANCE TECHNIQUE	
ASISTENCIA TÉCNICA	
SUPPORTO TECNICO	
TECHNISCHE ONDERSTEUNING	
POMOC TECHNICZNA	
TECHNICKÁ PODPORA	
TECHNICKÁ PODPORA	
TECHNIKAI TÁMOGATÁS	
TEKNISK SUPPORT	
TEKNISK SUPPORT	
TEKNISK STØTTE	
TEKNINEN TUKI	
ASSISTÊNCIA TÉCNICA	
ΤΕΧΝΙΚΗ ΥΠΟΣΤΗΡΙΞΗ	
TEHNIČKA PODRŠKA	
TEHNIČNA PODPORA	
SUPPORT TEHNIC	
ТЕХНИЧЕСКА ПОДДРЪЖКА	