



User Manual

AC5300 Ultra Wi-Fi Router

DIR-895L

Preface

D-Link reserves the right to revise this publication and to make changes in the content hereof without obligation to notify any person or organization of such revisions or changes.

Manual Revisions

Revision	Date	Description
1.00	February 4, 2016	Initial release
1.10	October 13, 2016	New firmware release 1.12 new QoS, AP Mode, VLAN Bridging

Trademarks

D-Link and the D-Link logo are trademarks or registered trademarks of D-Link Corporation or its subsidiaries in the United States or other countries. All other company or product names mentioned herein are trademarks or registered trademarks of their respective companies.

Apple®, Apple logo®, Safari®, iPhone®, iPad®, iPod touch® and Macintosh® are trademarks of Apple Inc., registered in the U.S. and other countries. App Store is a service mark of Apple Inc.

Chrome™ browser, Google Play™ and Android™ are trademarks of Google Inc.

Internet Explorer®, Windows® and the Windows logo are trademarks of the Microsoft group of companies.

Copyright © 2016 by D-Link Corporation, Inc.

All rights reserved. This publication may not be reproduced, in whole or in part, without prior expressed written permission from D-Link Corporation, Inc.

Power Usage

This device is an Energy Related Product (ErP) with High Network Availability (HiNA), and automatically switches to a power-saving Network Standby mode within 1 minute of no packets being transmitted. It can also be turned off through a power switch to save energy when it is not needed.

Network Standby: 10.10 watts

Switched Off: 0.11 watts

Table of Contents

Product Overview.....	1	Hardware Setup	32
Package Contents.....	1	Change to Media Bridge Mode.....	33
System Requirements	2	Configuration - Router Mode.....	35
Introduction	3	Home	36
Features.....	5	Internet.....	36
LEDs	6	DIR-895L.....	37
Hardware Overview	7	Connected Clients	38
Connections	7	USB Device	39
Choosing an Operation Mode	8	Settings	40
Router Mode	9	Wizard	40
Extender Mode	10	Internet.....	40
Installation - Router.....	13	IPv6	52
Before you Begin.....	13	Wireless	70
Wireless Installation Considerations.....	14	Guest Zone.....	73
Hardware Setup	15	Network.....	74
Completing Setup	18	SharePort	76
QRS Mobile App	19	Create User.....	77
Setup Wizard	20	mydlink.....	78
Installation - Access Point	26	Features.....	79
Before you Begin.....	26	QoS Engine.....	79
Wireless Installation Considerations.....	27	Manage by Application	80
Hardware Setup	28	Manage by Devices	81
Installation - Media Bridge	30	Firewall Settings.....	82
Before you Begin.....	30	IPv4/IPv6 Rules	84
Wireless Installation Considerations.....	31	Port Forwarding	85
		Virtual Server	86

Website Filter.....	87	Create User.....	112
Static Routes.....	88	Management.....	113
IPv4	88	Time & Schedule	113
IPv6	89	Time	113
Dynamic DNS	90	Schedule	114
IPv6 Host.....	91	System Log.....	115
Quick VPN.....	92	Admin	117
Management.....	93	System	118
Time & Schedule	93	Upgrade	119
Time	93	Applications	120
Schedule	94	mydlink Lite Mobile App.....	120
System Log.....	95	mydlink SharePort.....	121
Admin	97	Using the mydlink SharePort™ app for iPad®, iPhone®,	
System	98	and iPod touch®	121
Upgrade	99	Main Menu	126
Statistics	100	Documents.....	127
Configuration - Extender Mode.....	101	Pictures	129
Settings	101	Videos.....	131
Home	102	Music	133
DIR-895L.....	103	Folders	136
Connected Clients	104	Favorites	139
USB Device	105	Using the mydlink SharePort™ app for Android™	140
Settings	106	Main Menu	145
Extender.....	106	Documents.....	146
Wireless.....	107	Pictures	148
Wireless - Smart Connect Disabled	108	Videos.....	150
Network.....	110	Music	152
SharePort	111	Folders	155

Favorites	159	Wireless Basics	212
SharePort Plus	160	What is Wireless?	213
Share a USB Printer.....	160	Wireless Modes.....	216
Windows PC Configuration	161	Networking Basics	217
Mac Configuration.....	163	Check your IP address.....	217
Share a USB Storage Device.....	165	Statically Assign an IP address	218
How to Safely Disconnect a USB Storage Device.	168	Wireless Security	219
Quick VPN.....	170	What is WPA?	219
Important Information	171	Technical Specifications	220
Quick VPN Server Setup Instructions	172	Regulatory Information	221
iOS Devices	173		
Mac OS X.....	177		
Windows 7.....	180		
Windows 8.1/8	184		
Windows 10	190		
Android	193		
Connecting a Wireless Client to your Router	197		
WPS Button	197		
Windows® 10	198		
Windows® 8.....	200		
WPA/WPA2	200		
Windows® 7.....	202		
WPA/WPA2	202		
Windows Vista®	205		
WPA/WPA2	206		
Troubleshooting	208		

Package Contents

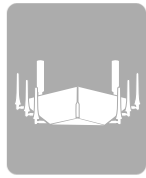

DIR-895L



Ethernet Cable

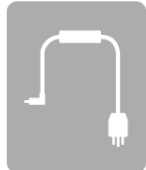

Power Adapter



Wi-Fi Configuration Card



Quick Installation Card



D-Link Cloud Service Mobile Apps Guide



CD-ROM

If any of the above items are missing, please contact your reseller.

Note: Using a power supply with a different voltage rating than the one included with the DIR-895L will cause damage and void the warranty for this product.

System Requirements

Network Requirements	<ul style="list-style-type: none">• An Ethernet-based cable or DSL modem• IEEE 802.11 ac/n/g/b/a wireless clients• 10/100 Ethernet connection
Web-based Configuration Utility Requirements	<p>Computer with the following:</p> <ul style="list-style-type: none">• Windows®, Macintosh, or Linux-based operating system• An installed Ethernet adapter <p>Browser Requirements:</p> <ul style="list-style-type: none">• Internet Explorer 10 or higher• Firefox 28 or higher• Safari 6 or higher• Chrome 28 or higher <p>Windows® Users: Make sure you have the latest version of Java installed. Visit www.java.com to download the latest version.</p>
QRS Mobile Requirements	<ul style="list-style-type: none">• iPhone, iPad, Android, or Windows smartphone or tablet (please refer to the mobile app's store page to check whether your device is compatible)

Introduction

The D-Link DIR-895L AC5300 Ultra Wi-Fi Router shares your Internet connection over a blazing-fast Gigabit Wireless AC connection of up to 5300 Mbps (Up to 4300 Mbps 5 GHz Wireless AC and up to 1000 Mbps 2.4 GHz Wireless N)¹, using advanced AC beamforming technology to significantly outperform 802.11n and other 802.11ac devices. Equipped with one Gigabit WAN/Internet port and four Gigabit LAN ports to provide speeds up to 10 times faster than standard 10/100 ports, the DIR-895L creates the best networking experience to date.

Featuring eight antennas and a 4 x 4 Multiple In Multiple Out (MIMO) antenna configuration, the DIR-895L offers better data rates, fewer dead-spots, more coverage, and higher reliability. Operating exclusively in the 5 GHz band, the DIR-895L's 802.11ac wireless connections avoid the crowded 2.4 GHz band, allowing you faster speeds while still maintaining backwards compatibility with older 802.11n/g/b devices. The DIR-895L prepares your home to become a Connected Home by bringing Wi-Fi to places your old signal can't reach. A stronger Wi-Fi signal means you can install more wireless surveillance cameras, baby monitors, sensors, and alarms in the places where you need them.

The DIR-895L's Smart Connect Technology makes connecting to wireless networks easy by eliminating the confusion of multiple networks. Ever since the introduction of 5 GHz multi-band wireless technology, users have had to guess whether the 5 GHz or 2.4 GHz band network would provide them with better range and speed. Smart Connect simplifies this by only presenting a single wireless network for you to connect to. Behind the scenes, when a connection is initiated, the DIR-895L's advanced algorithms determine the best band for your device to connect to, automatically distributing devices to the optimal band, thereby ensuring a faster, more reliable, and hassle-free experience for all of your users and devices.

The AC5300 Ultra Wi-Fi Router is also mydlink-enabled, which gives you access to your home network no matter where you go. Now you can monitor and manage your home network right from your laptop, iPhone®, iPad®, Android™ device, or Windows Phone™. All mydlink-enabled routers can be configured to send an email to keep you informed anywhere, anytime when new devices are connecting to your network or unwanted access is detected. Monitor in real-time websites that are being visited with recent browser history displayed on the mydlink™ Lite app – which is great for parents. Also, mydlink features Zero Configuration, allowing you to simply install a camera and have it automatically appear in your mydlink account.

SharePort technology lets you take advantage of the USB 3.0 port found on the back of your DIR-895L (as well as an additional USB 2.0 port). Plug in a USB storage drive and you can use the mydlink SharePort™ app for iPad®, iPhone®, iPod touch®, and Android™ device to access files, stream videos, view photos, or listen to music on your laptop or mobile devices.

We've all come to expect a fast, click-and-get-it Internet, but as you add more users and devices to your home network, choppy video and delays is often the result. D-Link's Intelligent Quality of Service (iQoS) Technology makes your Internet work better when your connection is pushed to its limit. Before iQoS, configuring QoS was a frustrating process, but now you can quickly prioritize Internet traffic using D-Link's easy-to-use drag and drop graphical interface. With iQoS you're just a few clicks away from enjoying smoother 3D/4K video streaming, gaming, and VoIP calls while your low-priority downloads and devices don't consume your bandwidth.

Introduction (continued)

This router is equipped with D-Link's Quick VPN technology. Using Quick VPN allows you to securely connect your computer or mobile device to places with free, untrusted Wi-Fi hotspots by encrypting and relaying your connection through your home Internet connection. This extra 'hop' reduces the chances of hackers stealing your information, such as logins, passwords, and credit card numbers. When traveling, Quick VPN lets you watch sports and use video streaming services without experiencing blackouts or filtering. You can surf the whole Internet unfiltered and unblocked, just as you would at home.

The DIR-895L supports the latest wireless security features to help prevent unauthorized access, be it from over a wireless network or the Internet. Support for WPA™ and WPA2™ standards ensure that you will be able to use the best possible encryption regardless of your client devices. In addition, this router is equipped with a dual-active firewall (SPI and NAT) to prevent potential attacks over the Internet.

The DIR-895L AC5300 Ultra Wi-Fi Router provides incredible speeds, smart antenna technology, fast ports, cloud features, and terrific security features. It also features an innovative design and easy installation options.

- 1 Maximum wireless signal rate derived from IEEE Standard 802.11a, 802.11g, 802.11n and 802.11ac specifications. Actual data throughput will vary. Network conditions and environmental factors, including volume of network traffic, building materials and construction, and network overhead, lower actual data throughput rate. Environmental conditions will adversely affect wireless signal range.

Features

- **Superior Wireless Networking** - The DIR-895L provides Gigabit wireless speeds of up to a combined 5300 Mbps (4300 Mbps 802.11ac 5 GHz, plus 1000 Mbps 802.11n 2.4 GHz)¹. This capability rivals wired connections, allowing users to participate in real-time activities online, such as HD video communication, online gaming, and use mobile devices from anywhere in your home while still offering full 802.11n/g/b backward compatibility.
- **Extreme Wired LAN and WAN Networking** - With four 10/100/1000 Gigabit Ethernet LAN ports, and a 10/100/1000 Gigabit Ethernet WAN port, the DIR-895L has an enormous amount of bandwidth to take full advantage of the highest speed broadband connections available.
- **Smart Connect** - Creates a 'single' wireless network for your devices to connect to. Behind the scenes, the DIR-895L automatically determines whether to connect a device to the 2.4 or 5 GHz band, thereby providing the best speed and range for each device and optimally distributing devices to each network.
- **Cloud Features** - The DIR-895L supports the QRS Mobile (Quick Router Setup) app to set up the router using a mobile device. It is also mydlink-enabled so you can remotely access and manage your DIR-895L from a mobile device using the mydlink Lite app. The mydlink SharePort™ app can be used to share files, stream videos, view photos, and play music. SharePort Plus also lets you share a printer.
- **IPv6 Support** - The DIR-895L fully supports IPv6 and includes support for a variety of IPv6 connection types including: SLAAC/DHCPv6, 6to4, 6rd, Static IPv6, IPv6 PPPoE, IPv6 in IPv4 tunneling, and local connectivity.
- **Advanced Firewall Features** - The web-based user interface displays a number of advanced network management features. Easily apply content filtering based on MAC address, URL, and/or domain name. Schedule these filters to be active on certain days or for a duration of hours or minutes.
- **Secure Multiple/Concurrent Sessions** - The DIR-895L can pass through VPN sessions. It supports multiple and concurrent IPSec and PPTP sessions, so users behind the DIR-895L can securely access corporate networks.
- **User-friendly Setup Wizard** - Through its easy-to-use web-based user interface or QRS Mobile application, the DIR-895L lets you quickly configure and secure your router to your specific settings in minutes.

¹ Maximum wireless signal rate derived from IEEE Standard 802.11a, 802.11g, 802.11n and 802.11ac specifications. Actual data throughput will vary. Network conditions and environmental factors, including volume of network traffic, building materials and construction, and network overhead, lower actual data throughput rate. Environmental conditions will adversely affect wireless signal range.

Hardware Overview

LEDs

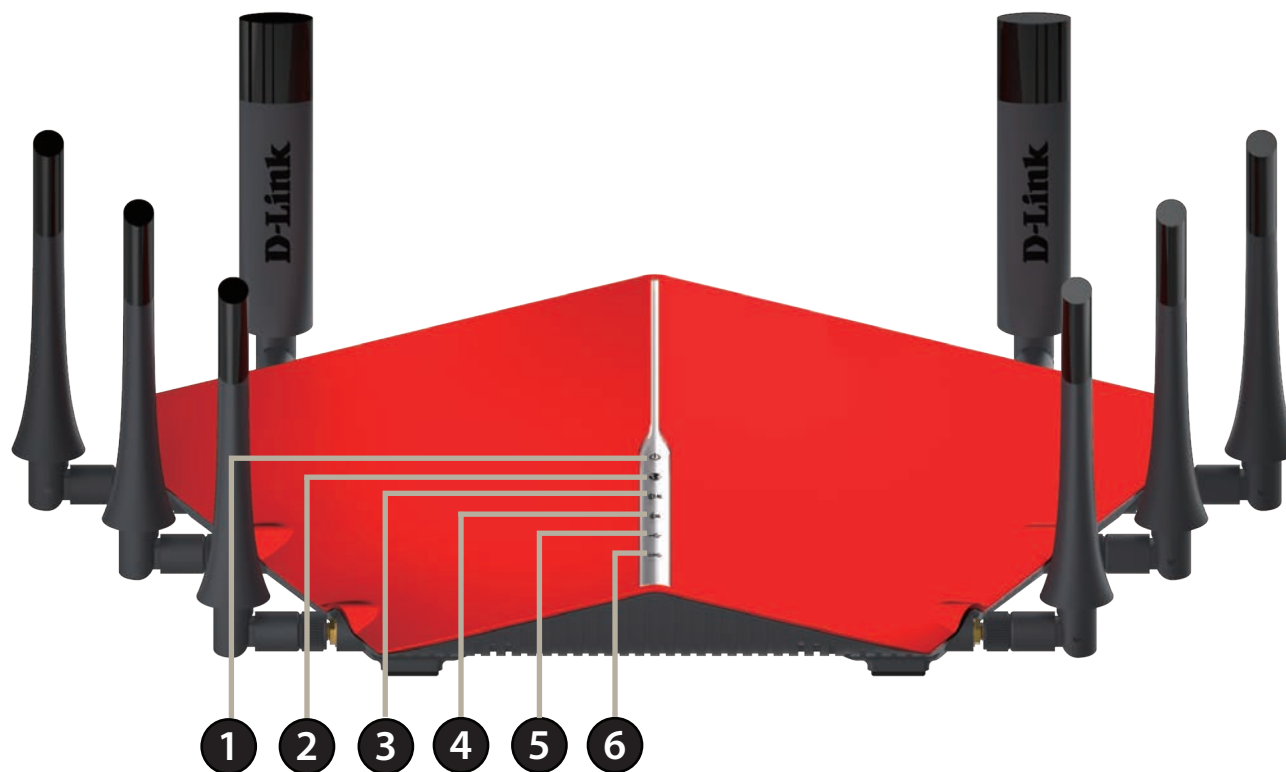

1	Power LED	A solid white light indicates a proper connection to the power supply. The light will be a solid orange during boot up.
2	Internet LED	A solid light indicates connection on the Internet port. If the LED is orange, the connection is good but the router cannot connect to the Internet.
3	Wireless (2.4 GHz) LED	A solid white light indicates that the 2.4 GHz wireless band is enabled.
4	Wireless (5 GHz) LED	A solid white light indicates that the 5 GHz wireless band is enabled.
5	USB 2.0 LED	A solid white light indicates that a USB device is connected to the USB 2.0 port.
6	USB 3.0 LED	A solid white light indicates that a USB device is connected to the USB 3.0 port.

Hardware Overview

Connections

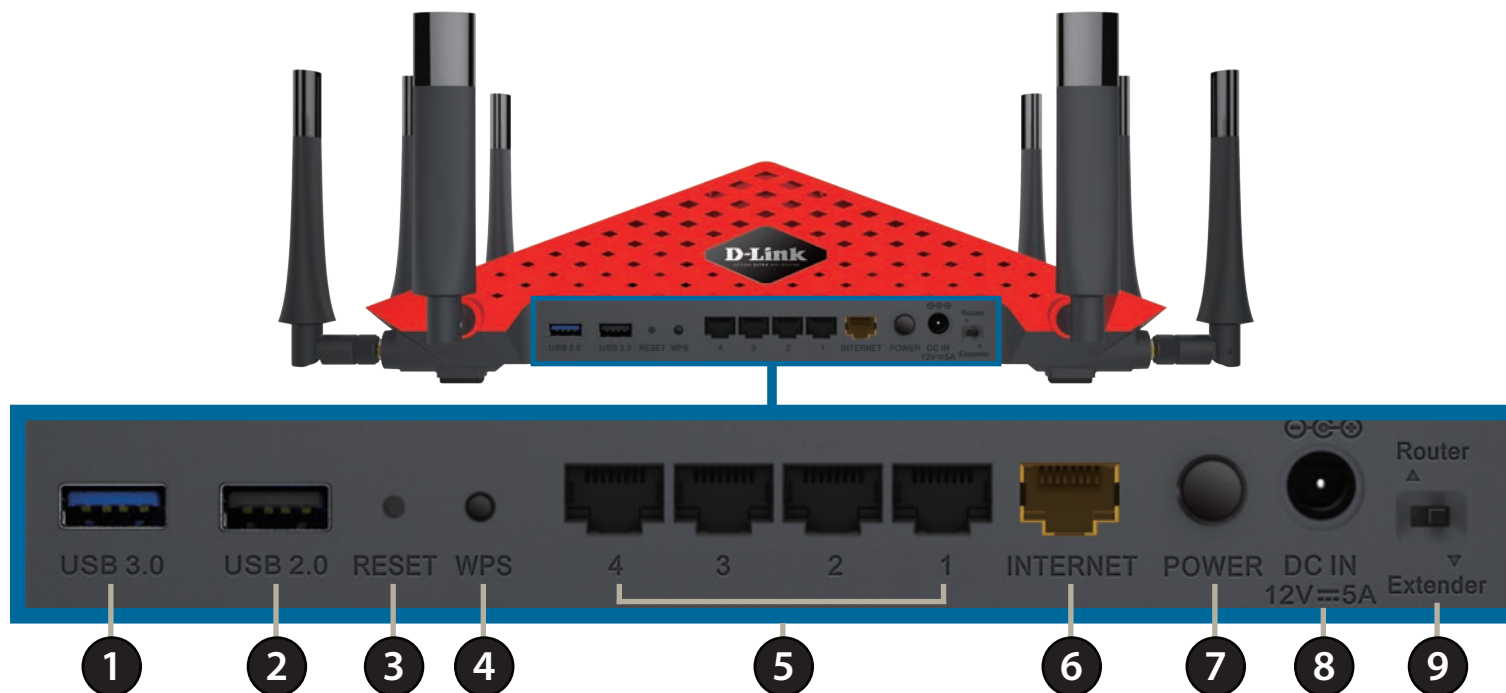

1	USB 3.0 Port	Connect a USB flash drive to share content , or connect it to a USB printer to share it on your network.
2	USB 2.0 Port	Connect a USB flash drive to share content , or connect it to a USB printer to share it on your network.
3	Reset Button	Insert a paperclip in the hole, wait for 10 seconds, and release to reset the router to default settings.
4	WPS Button	Press to start the WPS process and automatically create a secure connection to a WPS client.
5	Gigabit LAN Ports (1-4)	Connect Ethernet devices such as computers, switches, storage (NAS) devices and game consoles.
6	Gigabit Internet Port	Using an Ethernet cable, connect your broadband modem to this port.
7	Power Button	Press the power button to power the device on and off.
8	Power Connector	Connector for the supplied power adapter.
9	Mode Switch	Select between Router and Extender modes. To change modes, move the switch to the desired position and after 5 seconds the router will reboot into the desired mode. Router is the default mode.

Choosing an Operation Mode

The DIR-895L is equipped with a software mode switch to give you more flexibility in how to configure your network. You may choose to operate this device in either **Router Mode** or **Extender Mode**.



- **Router Mode** shares your Internet connection. This is the factory default setting suitable for most users.
- **Extender Mode** extends your existing network. You may configure the DIR-895L to operate as an Access Point or a Media Bridge.

Determine your desired type of operation and adjust the mode switch before you begin your installation.

The following pages contain information about the DIR-895L's operation modes to help you determine how you wish to use it. This information includes usage scenarios, cable diagrams, and network configuration information.

Note: If the mode switch is adjusted while powered on, the DIR-895L will reboot into the new mode after five seconds.

Router Mode

In **Router Mode**, the DIR-895L AC5300 Ultra Wi-Fi Router operates as the central device of your network. This is the most common type of installation and is the factory default setting suitable for most users. The DIR-895L connects to your cable modem, DSL modem, or other Internet source and shares your Internet connection with your wired and wireless devices.

Create a Home Network (Router Mode)

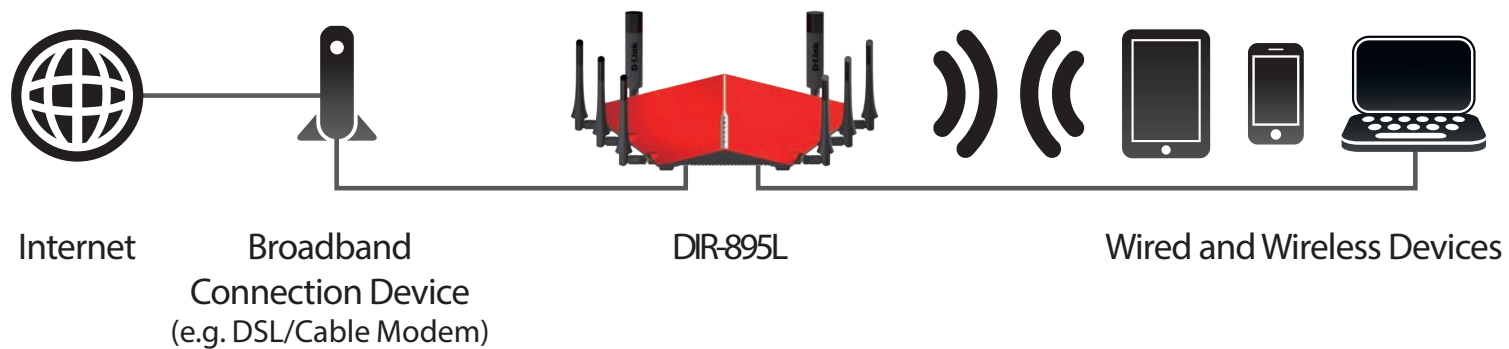

Use this mode for:

- Setting up a network for the first time.
- Replacing an existing router or network equipment.
- Adding a router to share a broadband connection which was previously connected to a single computer.

Place your DIR-895L near your broadband Internet connection device (e.g. DSL/Cable modem) and connect to it via Ethernet cable.

To use your DIR-895L as a **Router**, refer to **Installation - Router** on page 13.

Extender Mode

What is an Extender?

In **Extender mode**, the DIR-895L may work with your existing networking equipment in two different ways:

In **Access Point Mode**, the DIR-895L works with your existing networking equipment to provide Wi-Fi for parts of your home or office that may have poor or no reception. You may use the DIR-895L as a wireless access point by connecting it to an uplink network via an Ethernet cable. This can be useful if you already have an existing router without built-in wireless capabilities or if your existing wireless signal can't bridge the distance. Devices connected to the DIR-895L obtain IP addresses from the existing uplink network. To use your DIR-895L as an access point, install it in an area where you wish to get Wi-Fi, but is reachable by Ethernet cable from your uplink network.

Existing Wi-Fi Coverage

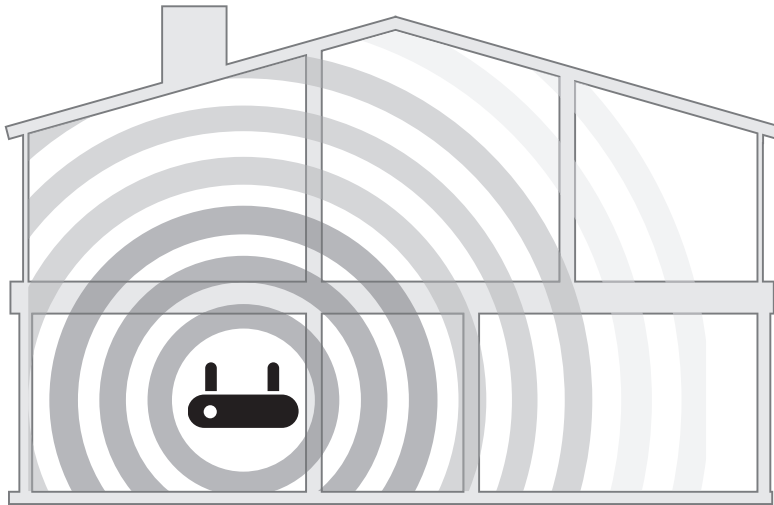

Wi-Fi Coverage with DIR-895L

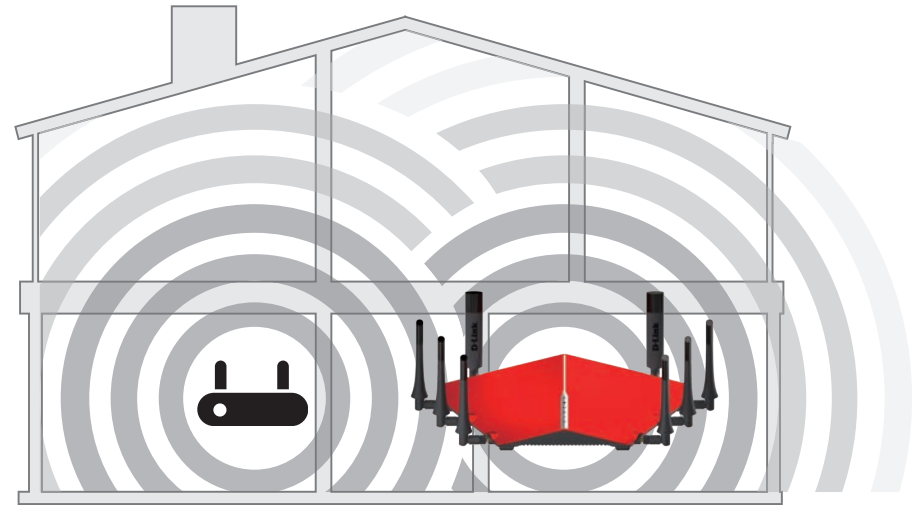

In **Media Bridge Mode**, the DIR-895L connects to your existing network wirelessly to provide connectivity to Ethernet devices. This can be useful if you cannot install Ethernet cable to your desired location or have devices which do not have wireless Ethernet. Devices connected to the DIR-895L obtain IP addresses from the existing uplink network. To use your DIR-895L as a media bridge, install it in an area where you can receive your wireless network signal.

Access Point

Create a Wireless Network using Ethernet

The DIR-895L operates as an **Access Point** when the mode switch is in the **Extender** position, the **Existing Network** is configured as **Ethernet** using the web configuration utility, and an Ethernet cable is connected from the WAN Ethernet Port to an uplink network.

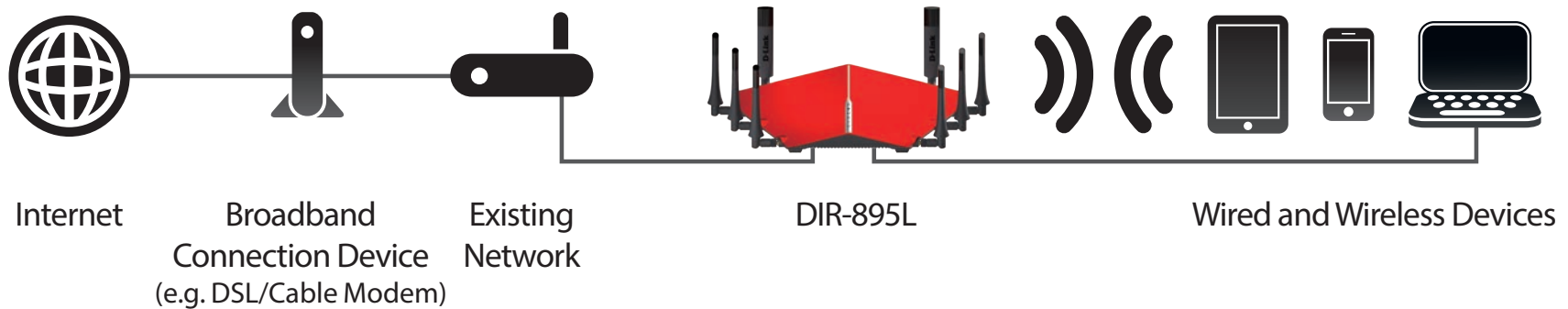

Use this mode for:

- Extending your current network.
- Providing better signal for parts of your home or office that may have poor reception.
- Bringing Wi-Fi to an area it doesn't currently reach.
- Adding Wi-Fi to a wired network.
- Maximizing bandwidth.
- Creating a Wi-Fi pocket away from your existing network.

Note: Extending a network to a desired location via Ethernet may require additional cable. The maximum length of Category 5/5E cables is limited to 100 meters (330 feet). Use a Gigabit-capable Ethernet connection where possible to ensure the best networking experience.

To use your DIR-895L as an **Access Point**, refer to **Installation - Access Point** on page 26.

Media Bridge

Use Wireless to Connect Ethernet Devices

The DIR-895L operates as a **Media Bridge** when the mode switch is in the **Extender** position, the **Existing Network** is configured as **Media Bridge** using the web configuration utility, and is connected wirelessly to an uplink network.

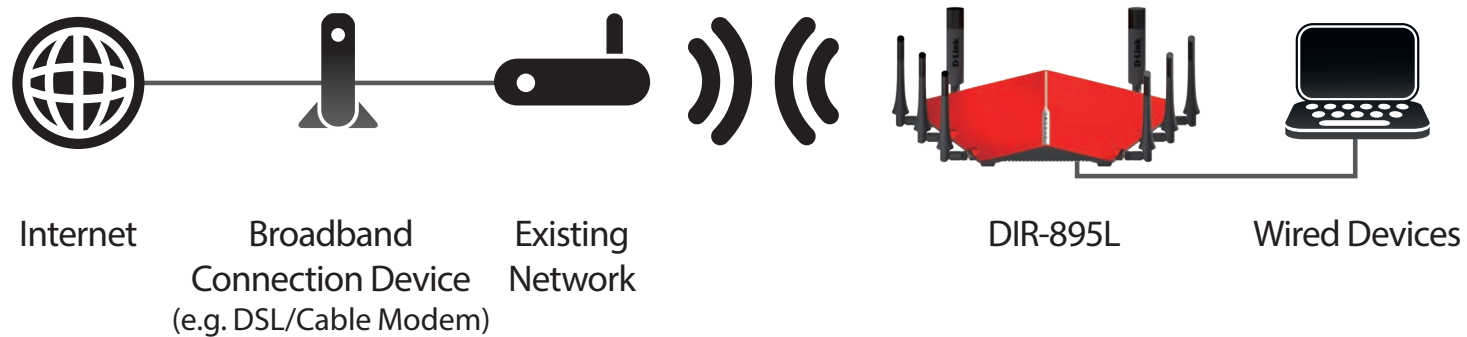

Use this mode for:

- Extending your current network.
- Using Wi-Fi to bring network connectivity where you cannot install Ethernet cable.
- Creating a pocket away from your existing network.

Note: For each additional devices connected to the media bridge, total available amount of wireless bandwidth required increases.

To use your DIR-895L as a **Media Bridge**, refer to **Installation - Media Bridge** on page **30**.

Installation - Router

This section will walk you through the installation of the DIR-895L as a router using **Router Mode**.

Before you Begin

- Placement of the router is very important. Do not place the router in an enclosed area such as a closet, cabinet, attic, or garage.
- Configure the router with the computer that was last connected directly to your Internet connection. Verify that it is connected to the Internet before connecting additional devices.
- If your ISP provided you with a modem/router combo, you will need to set it to “bridge” mode so the router can work properly. Please contact your Internet Service Provider (ISP) or refer to the user manual for your modem/router device.
- You can only use the Ethernet port on your modem. If you were using the USB connection before using the router, then you must turn off your modem, disconnect the USB cable and connect an Ethernet cable to the Internet port on the router, and then turn the modem back on. In some cases, you may need to call your ISP to change connection types (USB to Ethernet).
- If connecting to a DSL modem, make sure to have your DSL service information provided by your Internet Service Provider handy. This information is likely to include your DSL account's username and password. Your ISP may also supply you with additional WAN configuration settings which might be necessary to establish a connection.
- If you are connecting a considerable amount of networking equipment, it may be a good idea to take the time to label each cable or take a picture of your existing setup before making any changes.
- If you have DSL and are connecting via PPPoE, make sure you disable or uninstall any PPPoE software such as WinPoET, BroadJump, or EnterNet 300 from your computer or you will not be able to connect to the Internet.

Wireless Installation Considerations

The D-Link wireless router lets you access your network using a wireless connection from virtually anywhere within the operating range of your wireless network. Keep in mind that the number, thickness and location of walls, ceilings, or other objects that the wireless signals must pass through may limit the range. Typical ranges vary depending on the types of materials and background RF (radio frequency) noise in your home or business. The key to maximizing wireless range is to follow these basic guidelines:

1. Keep the number of walls and ceilings between the D-Link router and other network devices to a minimum - each wall or ceiling can reduce your adapter's range from 1 to 30 meters (3 to 90 feet). Position your devices so that the number of walls or ceilings is minimized.
2. Be aware of the direct line between network devices. A wall that is 0.5 meters (1.5 feet) thick, at a 45-degree angle appears to be almost 1 meter (3 feet) thick. At a 2-degree angle it looks over 14 meters (42 feet) thick! Position devices so that the signal will travel straight through a wall or ceiling (instead of at an angle) for better reception.
3. Building materials make a difference. A solid metal door or aluminum studs may have a negative effect on range. Try to position access points, wireless routers, and computers so that the signal passes through drywall or open doorways. Materials and objects such as glass, steel, metal, walls with insulation, water (fish tanks), mirrors, file cabinets, brick, and concrete will degrade your wireless signal.
4. Keep your product away at least 1 to 2 meters (3 to 6 feet) from electrical devices or appliances that generate RF noise.
5. If you are using 2.4 GHz cordless phones or X-10 (wireless products such as ceiling fans, lights, and home security systems), your wireless connection may degrade dramatically or drop completely. Make sure your 2.4 GHz phone base is as far away from your wireless devices as possible. The base transmits a signal even if the phone is not in use.

Hardware Setup

1. The DIR-895L is designed to give you the fastest, most stable network connection possible. In order to maximize performance, fully extend the antennas to provide optimal wireless coverage. Keep the router in an open area for better wireless coverage. Inspect the mode switch to ensure that it is in the factory default ROUTER position. Adjust the switch if necessary.

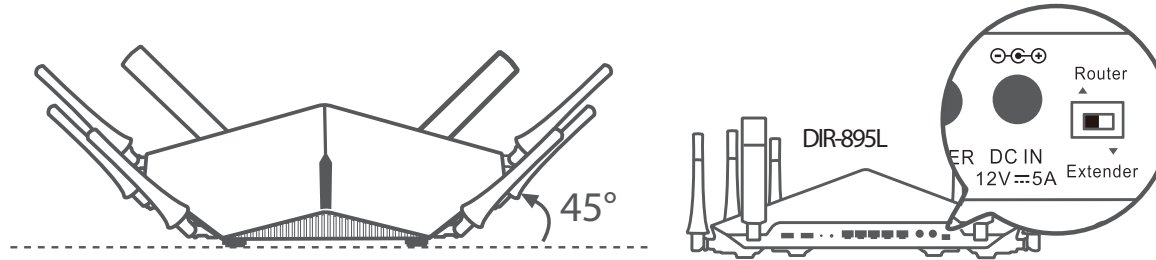

2. Position your DIR-895L near your Internet-connected modem. Place it in an open area for better wireless coverage.

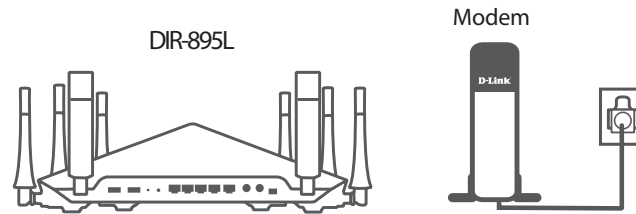

3. Turn off and unplug the power and Ethernet cable to your cable or DSL broadband modem. This is required. In some cases, you may need to turn it off for up to five minutes.

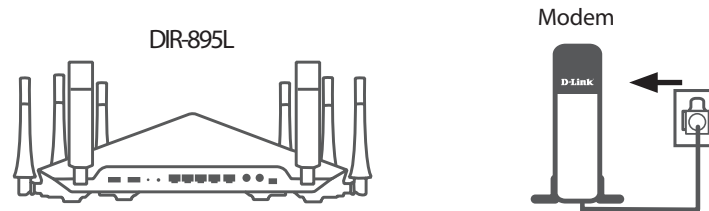

Hardware Setup (continued)

4. Use the included Ethernet cable to connect your modem to the yellow port labeled **INTERNET** on the router.

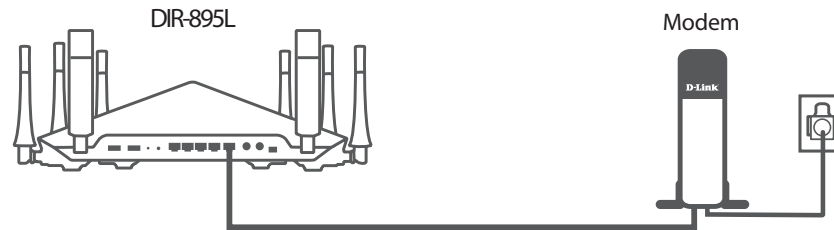

5. Turn on or plug your modem back in and wait approximately one minute before proceeding onward.

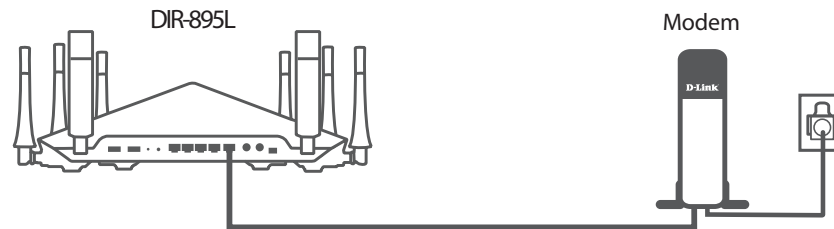

6. Connect the supplied power adapter to the router and a power outlet, press the power button, and verify that the power LED is lit. Allow 1 minute for the router to boot up.

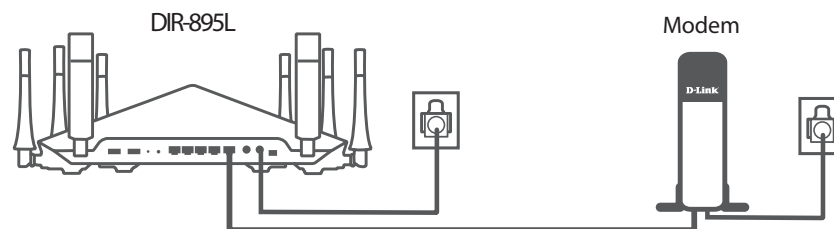

Note: This unit is to be used with power supply model DA-60N12.

Hardware Setup (continued)

7. If you are configuring the DIR-895L wirelessly from a PC, connect to a Wi-Fi network printed on the included Wi-Fi configuration card. You can also find the Wi-Fi network names and passwords printed on the label attached to the bottom of your router.

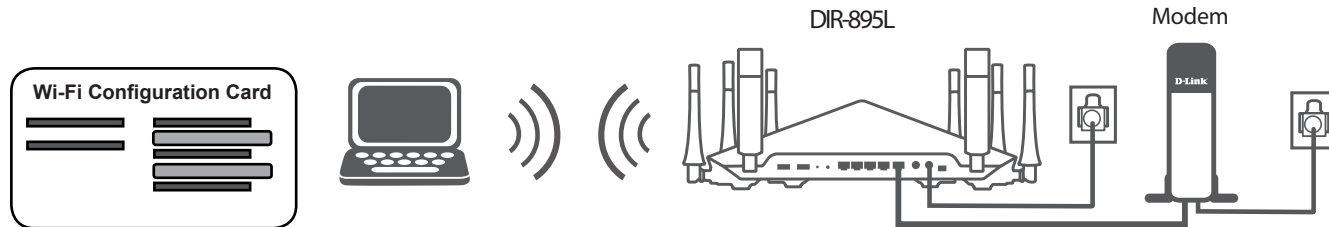

- If you are configuring the DIR-895L from a PC with a wired Ethernet connection, plug one end of an Ethernet cable into the port labeled 1 on the back of the router, and the other end into the Ethernet port on your computer.

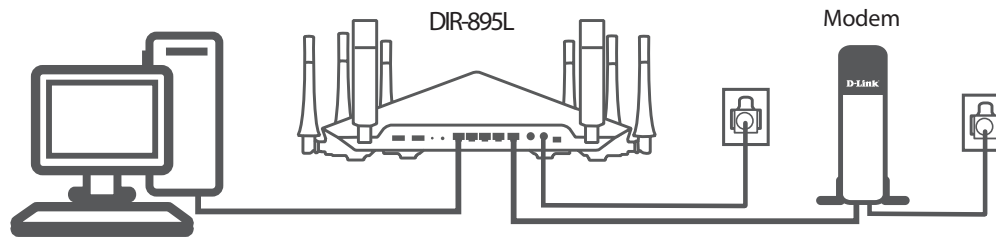

8. If you are connecting to a broadband service that uses a dynamic connection (not PPPoE), you may be online already. Try opening a web browser and connecting to a website. If the website does not load, proceed to **Completing Setup** on page 18.

Completing Setup

There are several different ways you can configure your router to connect to the Internet and connect to your clients:

- **QRS Mobile App** - Use your Android device, iPhone, iPad, or iPod touch to configure your router, refer to **QRS Mobile App** on page **19**.
- **D-Link Setup Wizard** - This wizard will launch when you log into the router for the first time, refer to **Setup Wizard** on page **20**.
- **Manual Setup** - Log into the router and manually configure your router, refer to **Router Mode** on page **9**.

QRS Mobile App

The QRS Mobile app allows you to install and configure your router from your mobile device.

Note: The screenshots may be different depending on your mobile device's OS version.

Step 1

Search for the free **QRS Mobile App** on the App Store or Google Play.



Step 2

Once your app is installed, you may now configure your router. Connect to the router wirelessly by going to your wireless utility on your device. Scan for the Wi-Fi name (SSID) as listed on the supplied info card. Select and then enter your Wi-Fi password.

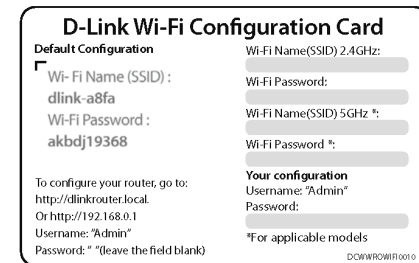

Step 3

Once you connect to the router, launch the QRS Mobile app from the Home screen of your device and follow the on-screen instructions.



QRS Mobile

Setup Wizard

If this is your first time installing the router, open your web browser and enter **http://dlinkrouter.local/** in the address bar. Alternatively, enter the IP address of the router (default: **http://192.168.0.1**).

The wizard is designed to guide you through a step-by-step process to configure your new D-Link router and connect to the Internet.

Click **Next** to continue.

Please wait while your router detects your Internet connection type. If the router detects your Internet connection, you may need to enter your ISP information such as username and password.

If the router does not detect a valid Internet connection, a list of connection types to choose from will be displayed.

Select your Internet connection type (this information can be obtained from your Internet Service Provider) and click **Next** to continue.

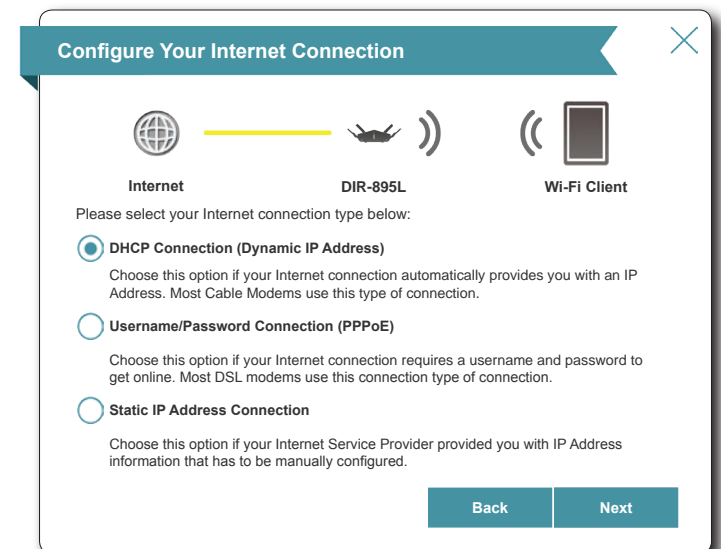
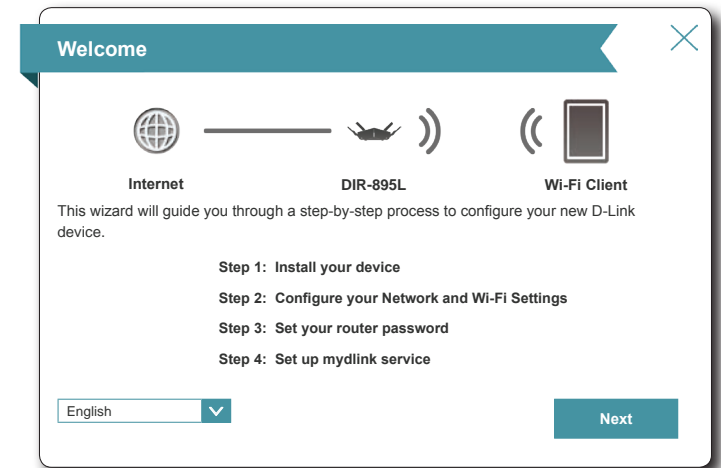

Setup Wizard (continued)

If the router detected or you selected **PPPoE**, enter your PPPoE username and password and click **Next** to continue.

Note: Make sure to remove your PPPoE software from your computer. The software is no longer needed and will not work through a router.

The screenshot shows the 'PPPoE' configuration screen. At the top, there is a teal header with the text 'PPPoE' and a close button (X). Below the header, there are three icons: a globe labeled 'Internet', a router labeled 'DIR-895L', and a smartphone labeled 'Wi-Fi Client'. A yellow line connects the Internet and DIR-895L icons. Below the icons, there is a paragraph of text: 'To setup this Internet connection, you will need to have a User Name from your Internet Service Provider. If you do not have this information, please contact your ISP.' Underneath this text are two input fields: 'Username:' and 'Password:'. At the bottom right, there are two buttons: 'Back' and 'Next'.

If the router detected or you selected **Static**, enter the IP and DNS settings supplied by your ISP. Click **Next** to continue.

The screenshot shows the 'Static IP' configuration screen. At the top, there is a teal header with the text 'Static IP' and a close button (X). Below the header, there are three icons: a globe labeled 'Internet', a router labeled 'DIR-895L', and a smartphone labeled 'Wi-Fi Client'. A yellow line connects the Internet and DIR-895L icons. Below the icons, there is a paragraph of text: 'To set up this connection you will need to have a complete list of IP information by your Internet Service Provider. If you have a Static IP connection and do not have this information, please contact your ISP.' Underneath this text are five input fields: 'IP Address:', 'Subnet Mask:', 'Gateway Address', 'Primary DNS Address', and 'Secondary DNS Address'. At the bottom right, there are two buttons: 'Back' and 'Next'.

Setup Wizard (continued)

Create a Wi-Fi password (between 8-63 characters). Your wireless clients will need to have this passphrase or key entered to be able to connect to your wireless network.

Click **Next** to continue.

Note: The DIR-895L's Smart Connect feature presents a single wireless network. When connecting clients to an extension network, they will be automatically added to the best band, either 2.4 GHz or 5 GHz. To disable the Smart Connect feature and individually configure 2.4 GHz and 5 GHz networks, refer to **Wireless** on page **70**.

Wi-Fi Settings
✕



Internet

DIR-895L

Wi-Fi Client

To setup a Wi-Fi network you will need to give your Wi-Fi network a name (SSID) and password.

Wi-Fi Network Name:

The Wi-Fi Network Name is up to 32 characters. You will need to join your Wi-Fi network using this Network Name (SSID).

Wi-Fi Password:

The password must contain at least 8 characters. You will need to join your Wi-Fi network using this password.

Back
Next

In order to secure the router, please enter a new password. You will be prompted for this password every time you want to use the router's web configuration utility. Click **Next** to continue.

Device Admin Password
✕



Internet

DIR-895L

Wi-Fi Client

By default, your new D-Link device does not have a password configured for administrator access to the Web-based configuration utility. To secure your new device, please create a password below.

Device Admin Password:

Back
Next

Setup Wizard (continued)

You will be presented with a summary of your settings. Click **Next** to finalize the settings or **Back** to make changes.

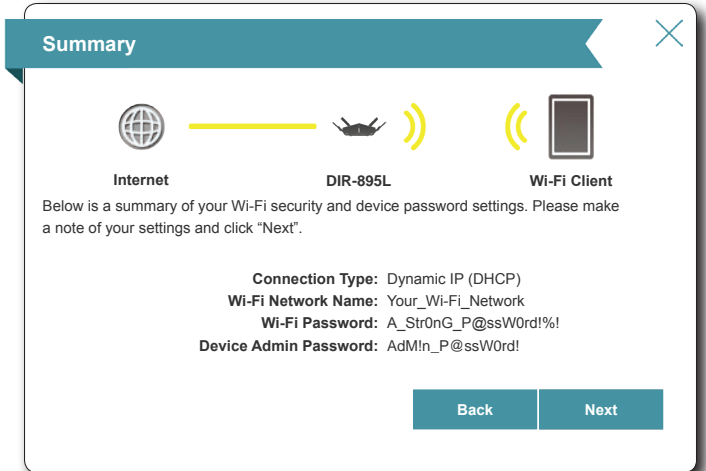

To use the mydlink service (mydlink.com or the mydlink Lite app), you must have an account. Select **Yes** if you have a mydlink account already, or **No** if you want to create one. Click **Next** to continue.

If you do not want to register at this time, click **Skip**.

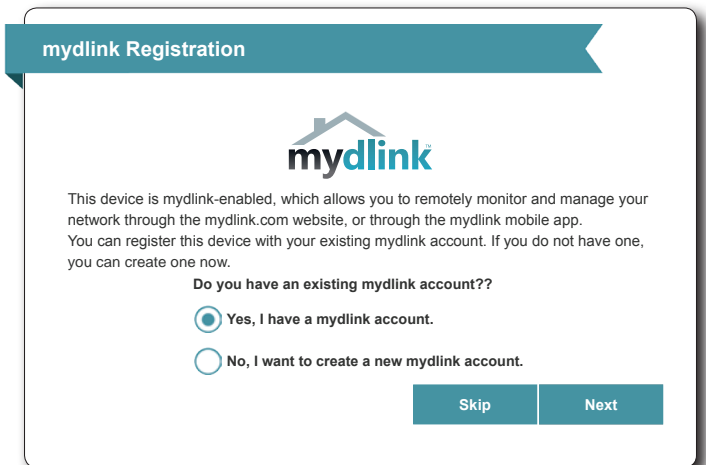

Setup Wizard (continued)

If you clicked **Yes**, enter your mydlink account name (email address) and password. Click **Next** to register your mydlink account with the router.

The screenshot shows a registration window titled "mydlink Registration". At the top center is the mydlink logo, which consists of a house icon above the text "mydlink". Below the logo are two input fields: "E-mail Address (Account Name):" and "Password:". At the bottom right, there are two buttons: "Skip" and "Next".

If you clicked **No**, fill out the requested information and click **Next** to create your mydlink account.

The screenshot shows a registration window titled "mydlink Registration". At the top center is the mydlink logo. Below the logo are four input fields: "E-mail Address (Account Name):", "Password:", "First Name:", and "Last Name:". Below these fields is a checkbox with the text "I accept the mydlink [terms and conditions.](#)". At the bottom right, there are two buttons: "Back" and "Next".

Setup Wizard (continued)

At the end of the wizard, you will be presented with a final summary of your settings. Click **Finish** to close the wizard. The device will reboot.

Congratulations, your device has been successfully configured!

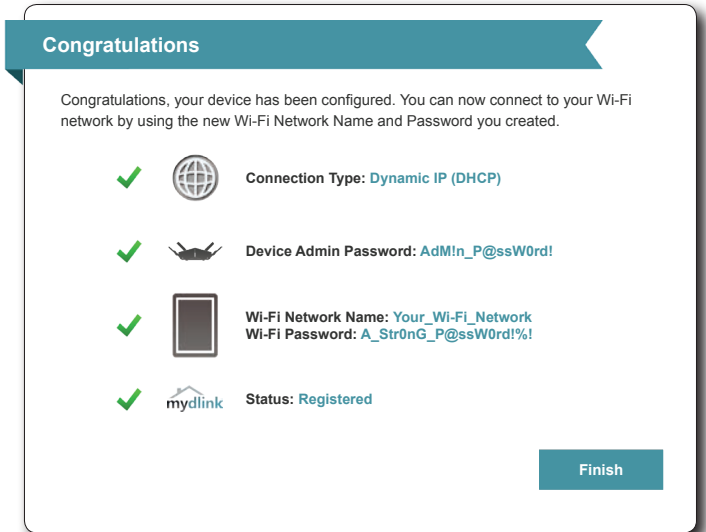

Installation - Access Point

This section will walk you through the installation of the DIR-895L as an access point.

Before you Begin

- Configure the DIR-895L with the computer that was last connected directly to your Internet connection. Verify that it is connected to the Internet before connecting additional devices.
- If you are connecting a considerable amount of networking equipment, it may be a good idea to take the time to label each cable or take a picture of your existing setup before making any changes.

Wireless Installation Considerations

The D-Link wireless router lets you access your network using a wireless connection from virtually anywhere within the operating range of your wireless network. Keep in mind that the number, thickness and location of walls, ceilings, or other objects that the wireless signals must pass through may limit the range. Typical ranges vary depending on the types of materials and background RF (radio frequency) noise in your home or business. The key to maximizing wireless range is to follow these basic guidelines:

1. Keep the number of walls and ceilings between the D-Link router and other network devices to a minimum - each wall or ceiling can reduce your adapter's range from 1 to 30 meters (3 to 90 feet). Position your devices so that the number of walls or ceilings is minimized.
2. Be aware of the direct line between network devices. A wall that is 0.5 meters (1.5 feet) thick, at a 45-degree angle appears to be almost 1 meter (3 feet) thick. At a 2-degree angle it looks over 14 meters (42 feet) thick! Position devices so that the signal will travel straight through a wall or ceiling (instead of at an angle) for better reception.
3. Building materials make a difference. A solid metal door or aluminum studs may have a negative effect on range. Try to position access points, wireless routers, and computers so that the signal passes through drywall or open doorways. Materials and objects such as glass, steel, metal, walls with insulation, water (fish tanks), mirrors, file cabinets, brick, and concrete will degrade your wireless signal.
4. Keep your product away at least 1 to 2 meters (3 to 6 feet) from electrical devices or appliances that generate RF noise.
5. If you are using 2.4 GHz cordless phones or X-10 (wireless products such as ceiling fans, lights, and home security systems), your wireless connection may degrade dramatically or drop completely. Make sure your 2.4 GHz phone base is as far away from your wireless devices as possible. The base transmits a signal even if the phone is not in use.

Hardware Setup

1. The DIR-895L is designed to give you the fastest, most stable network connection possible. In order to maximize performance, fully extend the antennas to provide optimal wireless coverage. Position your DIR-895L near where you wish to extend Wi-Fi to. Place it in an open area for better wireless coverage, but is still within range of your existing wired network using an Ethernet cable. Inspect the mode switch to ensure that it is in **EXTENDER** position. Adjust the switch if necessary.

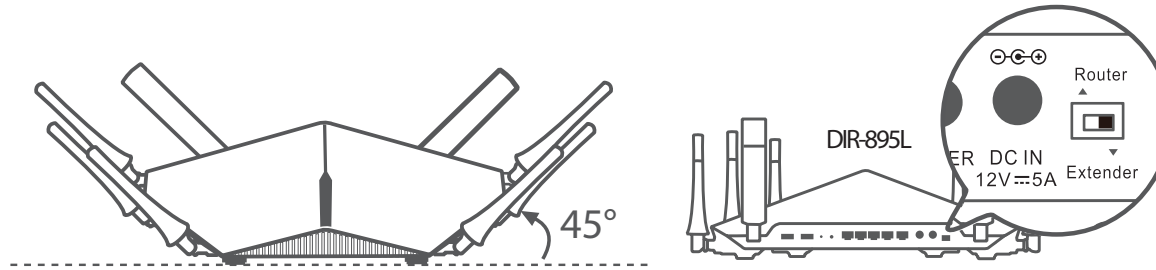

2. Connect the supplied power adapter to the DIR-895L and a power outlet.

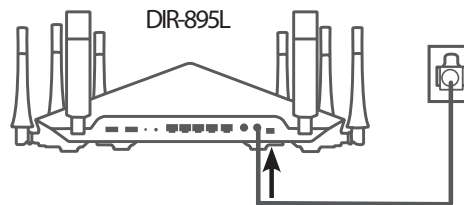

Note: Extending the network to your desired location via Ethernet may require the purchase of additional cable. Maximum CAT5e cable length is limited to 100 meters. Use a Gigabit-capable Ethernet connection where possible to ensure the best networking experience. This unit is to be used with power supply model DA-60N12.

3. Press the power button, and verify that the power LED is lit. Allow 1 minute for the router to boot up.

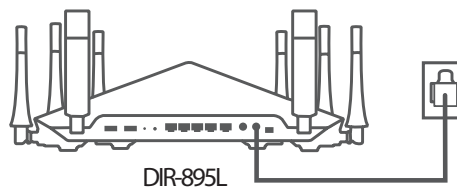

Hardware Setup (continued)

4. Connect wired devices to the LAN ports on your DIR-895L. Connect wireless devices to the Wi-Fi network printed on the included Wi-Fi Configuration Card. You can also find the Wi-Fi network names and passwords printed on the label attached to the bottom of your DIR-895L.

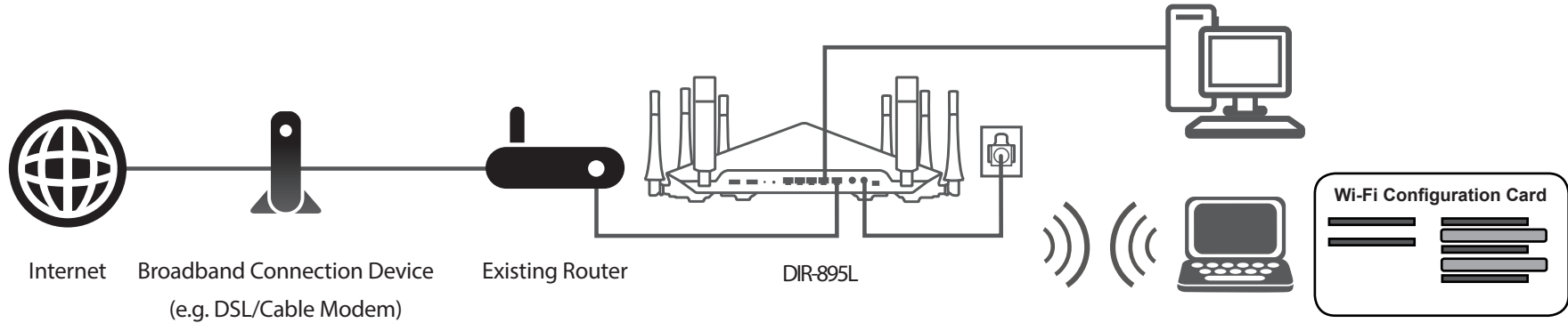

Congratulations, your device has been successfully configured!

If you wish to change the default wireless network names or passwords, refer to **Configuration - Extender Mode** on page **101** for more information.

Installation - Media Bridge

This section will walk you through the installation of the DIR-895L as a Media Bridge.

Before you Begin

- Configure the DIR-895L with the computer that was last connected directly to your Internet connection. Verify that it is connected to the Internet before connecting additional devices.
- If you are connecting a considerable amount of networking equipment, it may be a good idea to take the time to label each cable or take a picture of your existing setup before making any changes.
- You may need to use trial and error to determine an acceptable placement location within range of your existing wireless network.

Wireless Installation Considerations

The D-Link wireless router lets you access your network using a wireless connection from virtually anywhere within the operating range of your wireless network. Keep in mind that the number, thickness and location of walls, ceilings, or other objects that the wireless signals must pass through may limit the range. Typical ranges vary depending on the types of materials and background RF (radio frequency) noise in your home or business. The key to maximizing wireless range is to follow these basic guidelines:

1. Keep the number of walls and ceilings between the D-Link router and other network devices to a minimum - each wall or ceiling can reduce your adapter's range from 1 to 30 meters (3 to 90 feet). Position your devices so that the number of walls or ceilings is minimized.
2. Be aware of the direct line between network devices. A wall that is 0.5 meters (1.5 feet) thick, at a 45-degree angle appears to be almost 1 meter (3 feet) thick. At a 2-degree angle it looks over 14 meters (42 feet) thick! Position devices so that the signal will travel straight through a wall or ceiling (instead of at an angle) for better reception.
3. Building materials make a difference. A solid metal door or aluminum studs may have a negative effect on range. Try to position access points, wireless routers, and computers so that the signal passes through drywall or open doorways. Materials and objects such as glass, steel, metal, walls with insulation, water (fish tanks), mirrors, file cabinets, brick, and concrete will degrade your wireless signal.
4. Keep your product away at least 1 to 2 meters (3 to 6 feet) from electrical devices or appliances that generate RF noise.
5. If you are using 2.4 GHz cordless phones or X-10 (wireless products such as ceiling fans, lights, and home security systems), your wireless connection may degrade dramatically or drop completely. Make sure your 2.4 GHz phone base is as far away from your wireless devices as possible. The base transmits a signal even if the phone is not in use.

Hardware Setup

1. The DIR-895L is designed to give you the fastest, most stable network connection possible. In order to maximize performance, fully extend the antennas to provide optimal wireless coverage. Position your DIR-895L near where you wish to extend Wi-Fi to. Place it in an open area for better wireless coverage, but is still within range of your existing wired network using an Ethernet cable. Inspect the mode switch to ensure that it is in **EXTENDER** position. Adjust the switch if necessary.

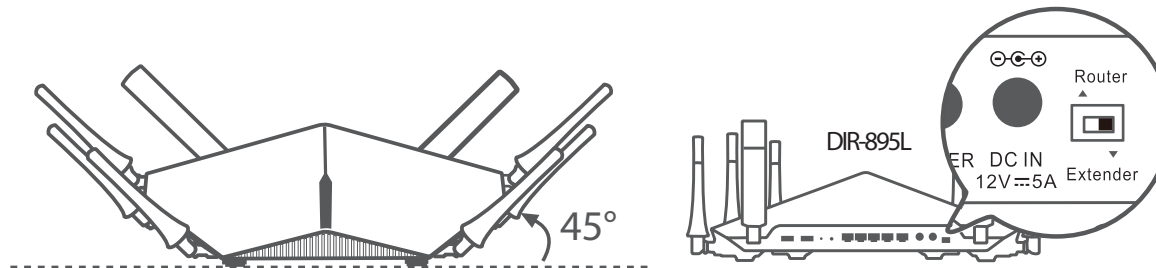

2. Connect the supplied power adapter to the DIR-895L and a power outlet.

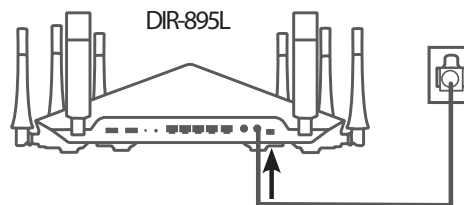

Note: Extending the network to your desired location via Ethernet may require the purchase of additional cable. Maximum CAT5e cable length is limited to 100 meters. Use a Gigabit-capable Ethernet connection where possible to ensure the best networking experience. This unit is to be used with power supply model DA-60N12.

3. Press the power button, and verify that the power LED is lit. Allow 1 minute for the router to boot up.

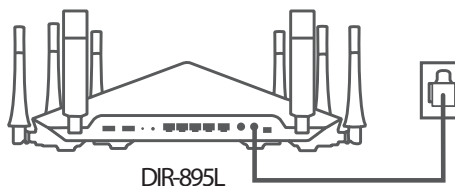

Hardware Setup (continued)

4. Connect wired devices to the LAN ports on your DIR-895L.

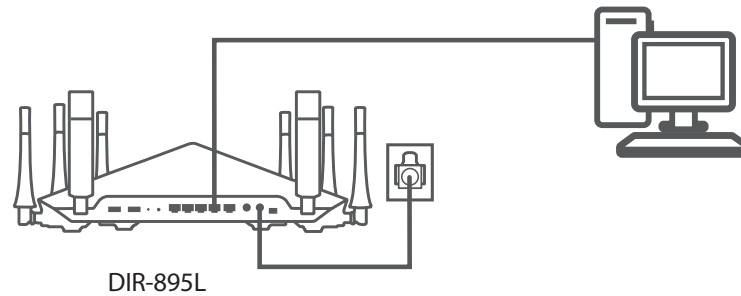

Change to Media Bridge Mode

To access the configuration utility, open a web-browser such as Internet Explorer and enter **http://dlinkrouter.local/** or you may also connect by typing the IP address* of the DIR-895L in the address bar. The web configuration utility may also be accessed at the IP address **192.168.0.50** when in Extender Mode, accessing this address requires setting static IP address for your computer in the **192.168.0.x** subnet.

*By default the DIR-895L in extender mode uses DHCP to obtain an IP address from your uplink network. If you are using multiple DIR-895Ls or D-Link devices, go to **http://dlinkrouterxxxx.local/** as shown on the included Wi-Fi Configuration Card, with "xxxx" being the last four digits of the DIR-895L's MAC address. The MAC address is also printed on the label on the bottom of the device.

If this is your first time configuring the DIR-895L, cancel out of the Setup Wizard by clicking on the X in the upper right hand corner. The Setup Wizard can only configure the device as an access point as of firmware 1.12.

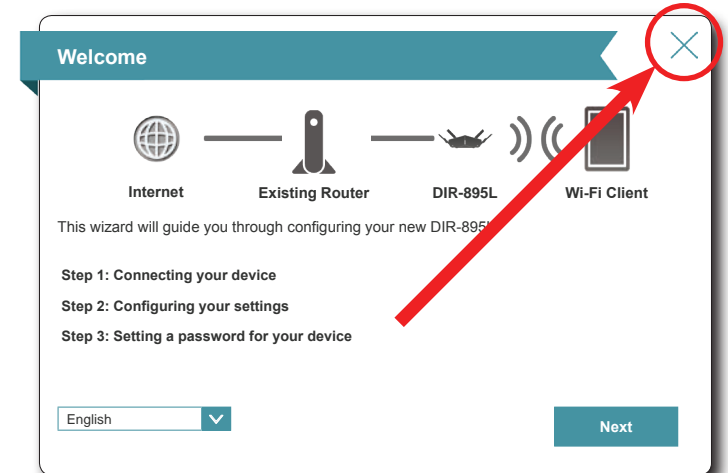

Hardware Setup (continued)

The Home Page will open, click the **Settings** menu and select **Extender**.

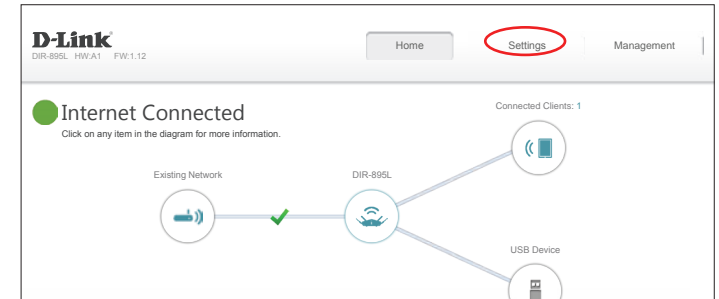

Select **Media Bridge** from **Existing Network**.

You may either manually enter the SSID of the wireless network you would like to connect to or click the **Scan** button to search for available nearby networks.

Select the type of security the uplink network uses. Only **None** and **WPA/WPA2-Personal** are supported.

Enter the password for the uplink network and click Save. Allow approximately one minute for the device to reboot.

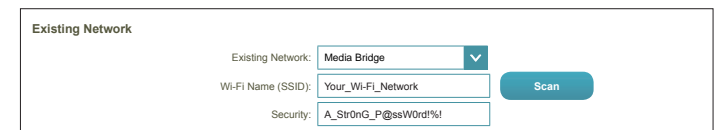
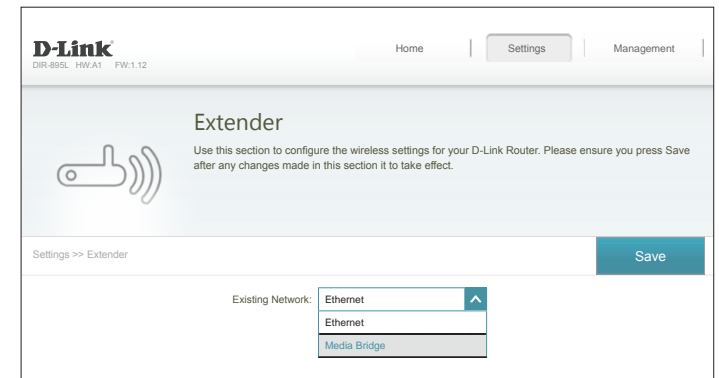

Congratulations, your device has been successfully configured. You may now connect additional wired devices to your DIR-895L.



Configuration - Router Mode

To access the configuration utility, open a web browser such as Internet Explorer and enter **http://dlinkrouter.local/** or you may also connect by typing the IP address of the router (by default this is **http://192.168.0.1**) in the address bar.

Enter your password. If you previously followed the setup wizard, please use the admin password you entered during the wizard. Otherwise, leave the password blank. Click **Log In** to proceed.

Note: If you cannot remember your password and cannot log in, press the reset button on the back of the device for longer than 10 seconds to restore the router to its default settings.

If you are having trouble logging in or experiencing trouble with the configuration utility, try clearing your browser cache or try using your web browsers 'private browser' or incognito mode.

The router's home page will open displaying its current connection status.

The bar at the top of the page has quick access to Settings and Management functions. You may quickly jump back Home at any time.

Note: The system will automatically log out after a period of inactivity.

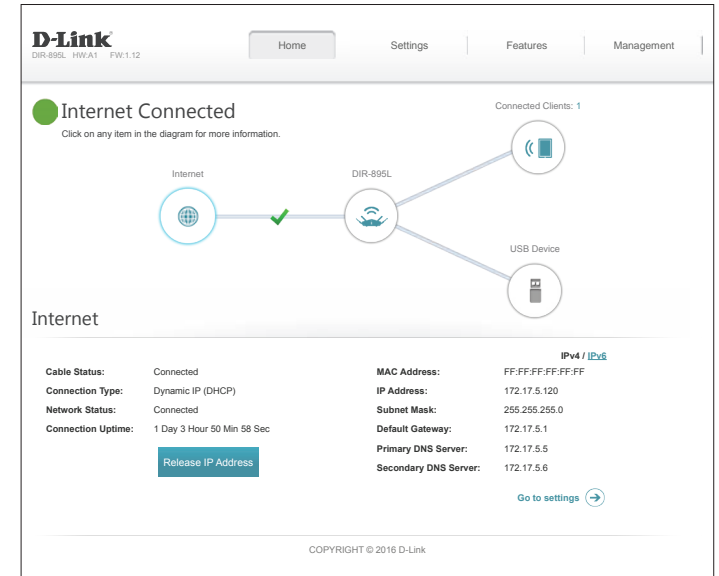
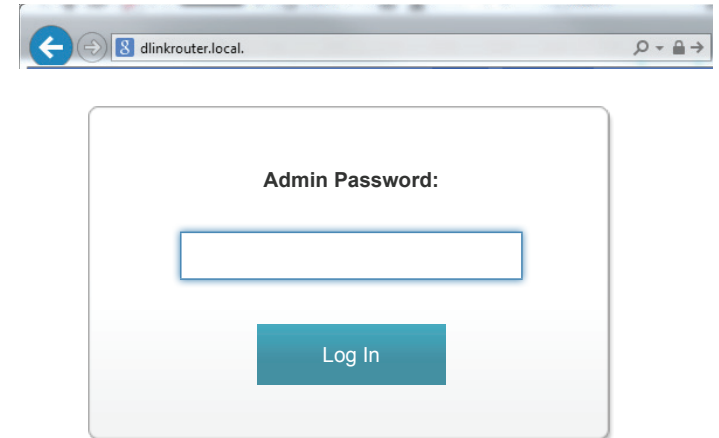

Home

The Home page displays the current status of the router in the form of an interactive diagram. You can click each icon to display information about each part of the network at the bottom of the screen. The menu bar at the top of the page will allow you to quickly navigate to other pages.

The Home page displays the status of the router's Internet connection. If it is disconnected, click **Click to repair** to bring up the setup wizard, refer to **Setup Wizard** on page 20 for more information.

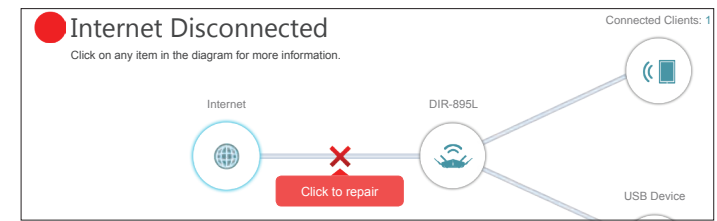
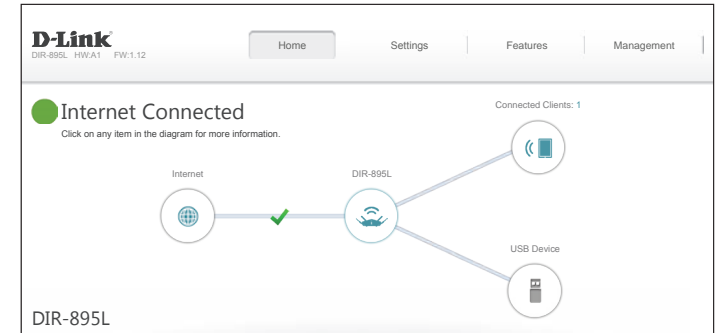

Internet

To bring up more details about your Internet connection, click on the **Internet** icon. Click **IPv4** or **IPv6** to see details of the IPv4 connection and IPv6 connection respectively.

Click **Release** to disconnect from the Internet. If you do this and wish to reconnect, click **Renew**.

To reconfigure the Internet settings, refer to **Internet** on page 40.

The screenshot shows the D-Link DIR-895L Internet settings page. At the top, there is a navigation menu with 'Home', 'Settings', 'Features', and 'Management'. Below the menu, the status is 'Internet Connected' with a green circle icon. A diagram shows the Internet connected to the DIR-895L router, which is then connected to a wireless client and a USB Device. The text 'Connected Clients: 1' is visible in the top right corner.

Below the diagram, there is a section titled 'Internet' with the following details:

Cable Status:	Connected	MAC Address:	FF:FF:FF:FF:FF:FF
Connection Type:	Dynamic IP (DHCP)	IP Address:	172.17.5.120
Network Status:	Connected	Subnet Mask:	255.255.255.0
Connection Uptime:	1 Day 3 Hour 50 Min 58 Sec	Default Gateway:	172.17.5.1
		Primary DNS Server:	172.17.5.5
		Secondary DNS Server:	172.17.5.6

At the bottom of the page, there is a 'Go to settings' button and a copyright notice: 'COPYRIGHT © 2016 D-Link'.

DIR-895L

Click on the **DIR-895L** icon to view details about the router and its wireless settings.

Here you can see the router's current Wi-Fi network name and password, as well as the router's MAC address, IPv4 address, and IPv6 address.

To reconfigure the network settings, either click **Go to settings** on the lower left, or click **Settings** (at the top of the page) and then **Network** on the menu that appears. Refer to **Network** on page **74** for more information.

To reconfigure the wireless settings, either click **Go to settings**, on the lower right, or click **Settings** (at the top of the page) and then **Wireless** on the menu that appears. Refer to **Wireless** on page **70** for more information.

The screenshot displays the D-Link DIR-895L web interface. At the top, there is a navigation bar with 'Home', 'Settings', 'Features', and 'Management' tabs. Below the navigation bar, the status 'Internet Connected' is shown with a green checkmark and a note to click on any item in the diagram for more information. A network diagram shows 'Internet' connected to 'DIR-895L', which is then connected to 'Connected Clients: 1' and a 'USB Device'. Below the diagram, the 'DIR-895L' section provides network details:

IPv4 Network		Wi-Fi	
MAC Address:	FF:FF:FF:FF:FF:FF	Status:	Enabled
Router IP Address:	192.168.0.1	Wi-Fi Name (SSID):	dlink-DIR-895L
Subnet Mask:	255.255.255.0	Password:	A_Str0nG_P@ssW0rd!%
IPv6 Network			
Link-Local Address:	FE80::FF00:FF00:FF00:FF00		
Router IPv6 Address:	2001:B021:23:10::1/64		
DHCP-PD:	Disabled		

At the bottom of the network details section, there are two 'Go to settings' buttons with arrows. The footer of the page reads 'COPYRIGHT © 2016 D-Link'.

Connected Clients

Click on the **Connected Clients** icon to view details about the router and its wireless settings.

On this page you can see all the clients currently connected to the router, and their IP addresses.

To edit each client's settings, click the pencil icon on the client you want to edit.

You may also add rules for currently disconnected or powered off devices.

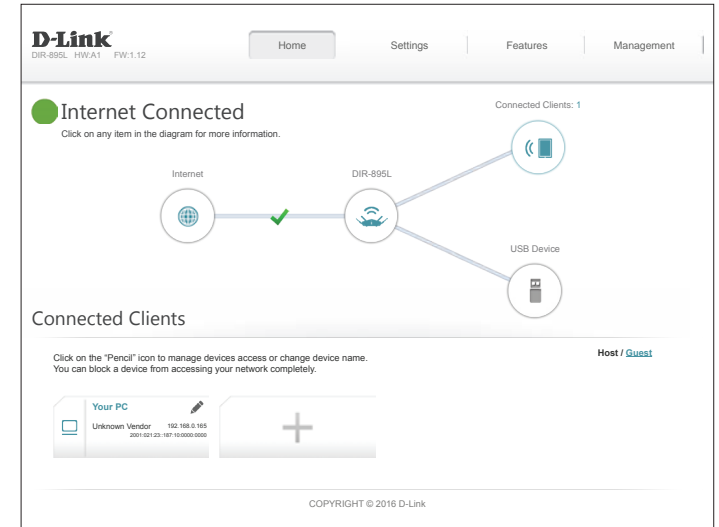

Name: Enter a custom name for this client.

Vendor: Displays the vendor of the device.

MAC Address: Displays the MAC address of the device.

IP Address: Displays the current IP address of this client.

Reserve IP: Enable to reserve this IP address for this client.

IP Address (Reserved): Specify an IP address for the DIR-895L's DHCP server to assign each time the device is detected.

Parental Control: Allow or block access to the router.

Click **Save** when you are done.

Edit Rule

✕

Name:

Vendor: Unknown Vendor

MAC Address: ff:ff:ff:ff:ff:ff

IP Address: 192.168.0.165

Reserve IP:

IP Address (Reserved):

Parental Control:

Schedule: ▼

USB Device

Click on the USB Device icon to view details about the currently connected USB device, DLNA media server, SharePort, and Windows File Sharing.

If you have a USB device connected, you can see its name and how much free space it has.

To reconfigure the SharePort settings, either click **Go to settings** on the lower right, or click **Settings** (at the top of the page) and then **SharePort** on the menu that appears. Refer to **SharePort** on page **76** for more information.

The screenshot shows the D-Link DIR-895L web interface. At the top, there are navigation tabs: Home, Settings, Features, and Management. Below the navigation, it indicates 'Internet Connected' with a green checkmark and 'Connected Clients: 1'. A network diagram shows the DIR-895L router connected to the Internet and a USB Device. The 'USB Device' section is titled 'USB Port: Not Available' and includes an image of a USB drive and the text 'No USB device detected'. To the right, there are three service status cards: 'DLNA Media Server' (Status: Disabled, Service Name: DIR-895L_DMS), 'SharePort' (Status: Disabled), and 'Windows File Sharing' (Status: Disabled). A 'Go to settings' button is located at the bottom right of the USB Device section. The footer contains 'COPYRIGHT © 2016 D-Link'.

The screenshot shows the D-Link DIR-895L web interface with a USB device connected. The 'USB Device' section is titled 'USB Port: Your USB Device' and includes an image of a USB drive. It displays the following information: 'Available Space: 13.515 GB' and 'Total Space: 27.03 GB'. A progress bar shows 50% usage. To the right, there are three service status cards: 'DLNA Media Server' (Status: Disabled, Service Name: DIR-895L_DMS), 'SharePort' (Status: Disabled), and 'Windows File Sharing' (Status: Disabled). A 'Go to settings' button is located at the bottom right of the USB Device section. The footer contains 'COPYRIGHT © 2016 D-Link'.

Settings Wizard

In the Settings menu on the bar on the top of the page, click **Wizard** to open the setup wizard. This is the same wizard that appears when you start the router for the first time. Refer to **Setup Wizard** on page **20** for details.

Internet

In the Settings menu on the bar on the top of the page, click **Internet** to see the Internet configuration options.

My Internet Connection Is: Choose your Internet connection type from the drop-down menu. You will be presented with the appropriate options for your connection type.

For **Dynamic IP (DHCP)** refer to page **41**.

For **Static IP** refer to page **42**.

For **PPPoE** refer to page **43**.

For **PPTP** refer to page **45**.

For **L2TP** refer to page **47**.

For **DS-Lite** refer to page **49**.

To configure an IPv6 connection, click the **IPv6** link. Refer to page **52**.

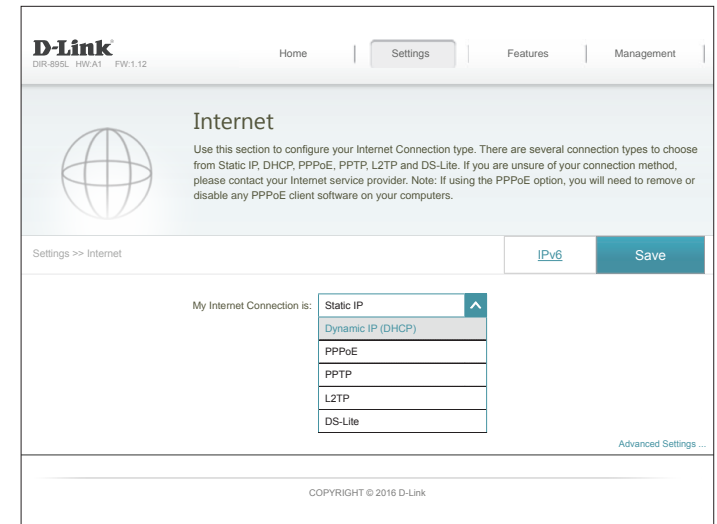

Dynamic IP (DHCP)

Select **Dynamic IP (DHCP)** to obtain IP address information automatically from your Internet Service Provider (ISP). Select this option if your ISP does not specify an IP address to use.

My Internet Connection Is: **Dynamic IP (DHCP)**

Advanced Settings

Host Name: The host name is optional but may be required by some ISPs. Leave it blank if you are not sure.

Primary DNS Server: Enter the primary DNS server IP address assigned by your ISP. This address is usually obtained automatically from your ISP.

Secondary DNS Server: Enter the secondary DNS server IP address assigned by your ISP. This address is usually obtained automatically from your ISP.

MTU: Maximum Transmission Unit - you may need to change the MTU for optimal performance with your ISP.

MAC Address Clone: The default MAC address is set to the Internet port's physical interface MAC address on the router. You can use the drop-down menu to replace the Internet port's MAC address with the MAC address of a connected client.

VLAN: For more information on enabling the VLAN feature, refer to **VLAN Bridging** on page 51.

Click **Save** when you are done.

The screenshot shows the D-Link router's web interface for configuring the Internet connection. The page title is 'Internet'. Below the title, there is a brief instruction: 'Use this section to configure your Internet Connection type. There are several connection types to choose from Static IP, DHCP, PPPoE, PPTP, LZTP and DS-Lite. If you are unsure of your connection method, please contact your Internet service provider. Note: If using the PPPoE option, you will need to remove or disable any PPPoE client software on your computers.' The 'My Internet Connection is:' dropdown is set to 'Dynamic IP (DHCP)'. Other fields include 'Host Name' (dlinkrouter), 'Primary DNS Server', 'Secondary DNS Server', 'MTU' (Auto), 'Mac Address Clone' (with a '<< MAC Address' dropdown), and 'VLAN' (Disabled). A 'Save' button is visible at the top right.

Static IP

Select **Static IP** if your IP information is provided by your Internet Service Provider (ISP).

My Internet Connection Is:

IP Address: Enter the IP address provided by your ISP.

Subnet Mask: Enter the subnet mask provided by your ISP.

Default Gateway: Enter the default gateway address provided by your ISP.

Primary DNS Server: Enter the primary DNS server IP address assigned by your ISP.

Advanced Settings

Secondary DNS Server: Enter the secondary DNS server IP address assigned by your ISP.

MTU: Maximum Transmission Unit - you may need to change the MTU for optimal performance with your ISP.

MAC Address Clone: The default MAC address is set to the Internet port's physical interface MAC address on the router. You can use the drop-down menu to replace the Internet port's MAC address with the MAC address of a connected client.

VLAN: For more information on enabling the VLAN feature, refer to **VLAN Bridging** on page 51.

Click **Save** when you are done.

The screenshot shows the D-Link web interface for the DIR-895L router. The page is titled 'Internet' and contains the following configuration options:

- My Internet Connection is:** Static IP (selected from a dropdown menu)
- IP Address:** [Empty text box]
- Subnet Mask:** [Empty text box]
- Default Gateway:** [Empty text box]
- Primary DNS Server:** [Empty text box]
- Advanced Settings ...** (expandable section):
 - Secondary DNS Server:** [Empty text box]
 - MTU:** Auto (selected from a dropdown menu)
 - Mac Address Clone:** << MAC Address (selected from a dropdown menu)
 - VLAN:** Disabled (selected from a dropdown menu)
- Save** button

At the bottom of the page, it says 'COPYRIGHT © 2016 D-Link'.

PPPoE

Select **PPPoE** if your ISP provides and requires you to enter a PPPoE username and password in order to connect to the Internet.

My Internet Connection Is: **PPPoE**

Username: Enter the username provided by your ISP.

Password: Enter the password provided by your ISP.

Reconnect Mode: Select either **Always-on**, **On-Demand**, or **Manual**.

Maximum Idle Time: Enter a maximum idle time during which the Internet connection is maintained during inactivity. To disable this feature, enable Auto-reconnect.

Advanced Settings

Address Mode: Select **Static IP** if your ISP assigned you the IP address, subnet mask, gateway, and DNS server addresses. In most cases, select **Dynamic IP**.

Dynamic IP

Service Name: Enter the ISP service name (optional).

Primary DNS Server: Enter the primary DNS server IP address assigned by your ISP.

Secondary DNS Server: Enter the secondary DNS server IP address assigned by your ISP.

MTU: Maximum Transmission Unit - you may need to change the MTU for optimal performance with your ISP. The recommended setting is **Auto**.

The screenshot shows the 'Internet' configuration page in the D-Link router's web interface. The 'My Internet Connection is:' dropdown is set to 'PPPoE'. The 'Username:' and 'Password:' fields are empty. The 'Reconnect Mode:' dropdown is set to 'On demand'. The 'Maximum Idle Time:' is set to 5 minutes. There are 'IPv6' and 'Save' buttons. The footer shows 'COPYRIGHT © 2016 D-Link'.

The screenshot shows the 'Advanced Settings' page for Dynamic IP. The 'Address Mode:' dropdown is set to 'Dynamic IP'. Below this are input fields for 'Service Name:', 'Primary DNS Server:', and 'Secondary DNS Server:'. The 'MTU:' dropdown is set to 'Auto'. The 'Mac Address Clone:' field is empty, and the 'VLAN:' dropdown is set to 'Disabled'. There is a '<< MAC Address' button. The footer shows 'COPYRIGHT © 2016 D-Link'.

PPPoE (continued)

MAC Address Clone: The default MAC address is set to the Internet port's physical interface MAC address on the router. You can use the drop-down menu to replace the Internet port's MAC address with the MAC address of a connected client.

VLAN: For more information on enabling the VLAN feature, refer to **VLAN Bridging** on page 51.

Click **Save** when you are done.

The screenshot shows the PPPoE configuration interface. The 'Address Mode' dropdown is set to 'Dynamic IP'. Other fields include 'Service Name', 'Primary DNS Server', 'Secondary DNS Server', 'MTU' (set to 'Auto'), 'Mac Address Clone' (with a '<< MAC Address' dropdown), and 'VLAN' (set to 'Disabled'). A copyright notice 'COPYRIGHT © 2016 D-Link' is visible at the bottom.

Static IP

IP Address: Enter the IP address provided by your ISP.

Service Name: Enter the ISP service name (optional).

Primary DNS Server: Enter the primary DNS server IP address assigned by your ISP.

Secondary DNS Server: Enter the secondary DNS server IP address assigned by your ISP.

MTU: Maximum Transmission Unit - you may need to change the MTU for optimal performance with your ISP.

MAC Address Clone: The default MAC address is set to the Internet port's physical interface MAC address on the router. You can use the drop-down menu to replace the Internet port's MAC address with the MAC address of a connected client.

VLAN: For more information on enabling the VLAN feature, refer to **VLAN Bridging** on page 51.

Click **Save** when you are done.

The screenshot shows the PPPoE configuration interface. The 'Address Mode' dropdown is set to 'Static IP'. Other fields include 'IP Address', 'Service Name', 'Primary DNS Server', 'Secondary DNS Server', 'MTU' (set to 'Auto'), 'Mac Address Clone' (with a '<< MAC Address' dropdown), and 'VLAN' (set to 'Disabled'). A copyright notice 'COPYRIGHT © 2016 D-Link' is visible at the bottom.

PPTP

Choose PPTP (Point-to-Point-Tunneling Protocol) if your Internet Service Provider (ISP) uses a PPTP connection. Your ISP will provide you with a username and password.

My Internet PPTP Connection Is:

PPTP Server IP Address: Enter the PPTP server IP address provided by your ISP.

Username: Enter the username provided by your ISP.

Password: Enter the password provided by your ISP.

Reconnect Mode: Select either **Always-on**, **On-Demand**, or **Manual**.

Maximum Idle Time: Enter a maximum idle time during which the Internet connection is maintained during inactivity. To disable this feature, enable Auto-reconnect.

Advanced Settings

Address Mode: Select **Static IP** if your ISP assigned you the IP address, subnet mask, gateway, and DNS server addresses. In most cases, select **Dynamic IP**.

The screenshot shows the D-Link router's web interface for configuring the Internet connection. The page title is "Internet" and it includes a navigation bar with "Home", "Settings", "Features", and "Management". A globe icon is next to the title. Below the title, there is a brief instruction: "Use this section to configure your Internet Connection type. There are several connection types to choose from Static IP, DHCP, PPPoE, PPTP, LZTP and DS-Lite. If you are unsure of your connection method, please contact your Internet service provider. Note: If using the PPPoE option, you will need to remove or disable any PPPoE client software on your computers." The main configuration area has a breadcrumb "Settings >> Internet" and a "Save" button. The "My Internet Connection is:" dropdown is set to "PPTP". The "PPTP Server IP Address:" field is empty with the placeholder "IP or Domain name". The "Username:" and "Password:" fields are also empty. The "Reconnect Mode:" dropdown is set to "On Demand". The "Maximum Idle Time:" is set to "5" minutes. There is an "Advanced Settings ..." link at the bottom right of the form area. The footer of the page reads "COPYRIGHT © 2016 D-Link".

PPTP (continued)

Dynamic IP

Primary DNS Server: Enter the primary DNS server IP address assigned by your ISP.

Secondary DNS Server: Enter the secondary DNS server IP address assigned by your ISP.

MTU: Maximum Transmission Unit - you may need to change the MTU for optimal performance with your ISP. The recommended setting is **Auto**.

The screenshot shows the Dynamic IP configuration page. It features a dropdown menu for 'Address Mode' set to 'Dynamic IP', two empty text input fields for 'Primary DNS Server' and 'Secondary DNS Server', and a dropdown menu for 'MTU' set to 'Auto'. A copyright notice 'COPYRIGHT © 2016 D-Link' is visible at the bottom.

Static IP

PPTP IP Address: Enter the IP address provided by your ISP.

PPTP Subnet Mask: Enter the subnet mask provided by your ISP.

PPTP Gateway IP Address: Enter the gateway IP address provided by your ISP.

Primary DNS Server: Enter the primary DNS server IP address assigned by your ISP.

Secondary DNS Server: Enter the secondary DNS server IP address assigned by your ISP.

MTU: Maximum Transmission Unit - you may need to change the MTU for optimal performance with your ISP. The recommended setting is **Auto**.

Click **Save** when you are done.

The screenshot shows the Static IP configuration page. It features a dropdown menu for 'Address Mode' set to 'Static IP', four empty text input fields for 'PPTP IP Address', 'PPTP Subnet Mask', 'PPTP Gateway IP Address', and 'Primary DNS Server', one empty text input field for 'Secondary DNS Server', and a dropdown menu for 'MTU' set to 'Auto'. A copyright notice 'COPYRIGHT © 2016 D-Link' is visible at the bottom.

L2TP

Choose L2TP (Layer 2 Tunneling Protocol) if your Internet Service Provider (ISP) uses a L2TP connection. Your ISP will provide you with a username and password.

My Internet Connection Is: **L2TP**

L2TP Server IP Address: Enter the L2TP server IP address provided by your ISP.

Username: Enter the username provided by your ISP.

Password: Enter the password provided by your ISP.

Reconnect Mode: Select either **Always-on**, **On-Demand**, or **Manual**.

Maximum Idle Time: Enter a maximum idle time during which the Internet connection is maintained during inactivity. To disable this feature, enable Auto-reconnect.

Advanced Settings

Address Mode: Select **Static IP** if your ISP assigned you the IP address, subnet mask, gateway, and DNS server addresses. In most cases, select **Dynamic IP**.

The screenshot shows the D-Link router's web interface for configuring the Internet connection. The page title is 'Internet'. Below the title, there is a globe icon and a paragraph of instructions. The main configuration area includes a breadcrumb 'Settings >> Internet', a 'IPv6' toggle, and a 'Save' button. The 'My Internet Connection is:' dropdown is set to 'L2TP'. Below this, there are input fields for 'L2TP Server IP Address', 'Username', and 'Password'. The 'Reconnect Mode:' dropdown is set to 'On Demand'. The 'Maximum Idle Time:' is set to '5 minutes'. There is an 'Advanced Settings...' link at the bottom right of the form area. The footer of the page reads 'COPYRIGHT © 2016 D-Link'.

L2TP (continued)

Dynamic IP

Primary DNS Server: Enter the primary DNS server IP address assigned by your ISP.

Secondary DNS Server: Enter the secondary DNS server IP address assigned by your ISP.

MTU: Maximum Transmission Unit - you may need to change the MTU for optimal performance with your ISP. The recommended setting is **Auto**.

Static IP

L2TP IP Address: Enter the IP address provided by your ISP.

L2TP Subnet Mask: Enter the subnet mask provided by your ISP.

L2TP Gateway IP Address: Enter the gateway IP address provided by your ISP.

Primary DNS Server: Enter the primary DNS server IP address assigned by your ISP.

Secondary DNS Server: Enter the secondary DNS server IP address assigned by your ISP.

MTU: Maximum Transmission Unit - you may need to change the MTU for optimal performance with your ISP. The recommended setting is **Auto**.

Click **Save** when you are done.

DS-Lite

DS-Lite is an IPv6 connection type. After selecting DS-Lite, the following parameters will be available for configuration:

My Internet Connection Is: **DS-Lite**

Advanced Settings

DS-Lite Configuration: Select **DS-Lite DHCPv6 Option** to let the router allocate the AFTR IPv6 address automatically. Select **Manual Configuration** to enter the AFTR IPv6 address manually.

DS-Lite DHCPv6

B4 IPv4 Address: Enter the B4 IPv4 address value used here.

WAN IPv6 Address: Once connected, the WAN IPv6 address will be displayed here.

IPv6 WAN Default Gateway: Once connected, the IPv6 WAN default gateway address will be displayed here.

Manual

AFTR IPv6 Address: Enter the AFTR IPv6 address used here.

B4 IPv4 Address: Enter the B4 IPv4 address value used here.

WAN IPv6 Address: Once connected, the WAN IPv6 address is displayed here.

D-Link DIR-895L HW v1 FW:1.12

Home | Settings | Features | Management

Internet

Use this section to configure your Internet Connection type. There are several connection types to choose from Static IP, DHCP, PPPoE, PPTP, L2TP and DS-Lite. If you are unsure of your connection method, please contact your Internet service provider. Note: If using the PPPoE option, you will need to remove or disable any PPPoE client software on your computers.

Settings >> Internet

IPv6 Save

My Internet Connection is: **DS-Lite**

COPYRIGHT © 2016 D-Link

DS-Lite Configuration: **DS-Lite DHCPv6 Option**

B4 IPv4 Address: 192.0.0.

WAN IPv6 Address: N/A

IPv6 WAN Default Gateway: N/A

COPYRIGHT © 2016 D-Link

DS-Lite Configuration: **Manual Configuration**

AFTR IPv6 Address:

B4 IPv4 Address: 192.0.0.

WAN IPv6 Address: N/A

IPv6 WAN Default Gateway: N/A

COPYRIGHT © 2016 D-Link

DS-Lite (continued)

IPv6 WAN Default Gateway: Once connected, the IPv6 WAN default gateway address is displayed here.

Click **Save** when you are done.

DS-Lite Configuration: ▼

AFTR IPv6 Address:

B4 IPv4 Address: 192.0.0.

WAN IPv6 Address: N/A

IPv6 WAN Default Gateway: N/A

COPYRIGHT © 2016 D-Link

VLAN Bridging

The VLAN bridging feature allows advanced users to enable 802.1Q VLAN tagging on the WAN interface. If you have an Ultra Fast Broadband (UFB) fiber optic connection, your ISP may offer High Priority Committed Information Rate (CIR). This guarantees the bandwidth required for real time voice and video applications.

In order to utilize the CIR, you must know the proper 802.1Q VLAN tags that your ISP uses. To enable this functionality, define the VLAN IDs, apply the VLAN to the desired interface, and connect your devices. Additional 802.1p tag configuration options will be available via future firmware update.

VLAN Bridge

Internet Vlan ID: Enter the Vlan ID for Internet traffic.

IPTV VLAN ID: Enter the VLAN ID for IPTV traffic.

VoIP VLAN ID: Enter the VLAN ID for VoIP traffic.

WAN Connection: Select the VLAN to apply to the corresponding interface.

VLAN Bridge

Internet Vlan ID: (2~4094)

IPTV Vlan ID: (2~4094)

VoIP Vlan ID: (2~4094)

Interface	WAN Connection
LAN Port1	<div style="border: 1px solid #ccc; padding: 2px;"> <div style="background-color: #0070c0; color: white; padding: 2px;">Internet</div> <div style="background-color: #eee; padding: 2px;">Internet</div> <div style="padding: 2px;">IPTV</div> <div style="padding: 2px;">VoIP</div> </div>
LAN Port2	<div style="border: 1px solid #ccc; padding: 2px;">Internet</div>
LAN Port3	<div style="border: 1px solid #ccc; padding: 2px;">Internet</div>
LAN Port4	<div style="border: 1px solid #ccc; padding: 2px;">Internet</div>
Wireless	<div style="border: 1px solid #ccc; padding: 2px;">Internet</div>
Wireless Guest Zone	<div style="border: 1px solid #ccc; padding: 2px;">Internet</div>

IPv6

To configure an IPv6 connection, click the **IPv6** link. To return to the IPv4 settings, click **IPv4**.

My Internet Connection Is: Choose your IPv6 connection type from the drop-down menu. You will be presented with the appropriate options for your connection type. Click **Advanced Settings...** to see additional configuration options.

For **Auto Detection** refer to page **53**.

For **Static IPv6** refer to page **55**.

For **Auto Configuration (SLAAC/DHCPv6)** refer to page **57**.

For **PPPoE** refer to page **59**.

For **IPv6 in IPv4 Tunnel** refer to page **62**.

For **6 to 4** refer to page **65**.

For **6rd** refer to page **67**.

For **Local Connectivity Only** refer to page **69**.

Auto Detection

Select **Auto Detection** to automatically detect the IPv6 connection method used by your Internet Service Provider (ISP). If Auto Detection fails, you can manually select another IPv6 connection type.

IPv6 DNS Settings

DNS Type: Select either **Obtain DNS server address automatically** or **Use the following DNS address**.

If **Use the following DNS address** is selected:

Primary DNS Server: Enter the primary DNS server address.

Secondary DNS Server: Enter the secondary DNS server address.

LAN IPv6 Address Settings

LAN IPv6 Address: Displays the router's LAN IPv6 Address link-local address.

LAN IPv6 Link-Local Address: Displays the router's LAN link-local address.

Auto Detection (continued)

Advanced Settings - Address Autoconfiguration Settings

Enable Automatic IPv6 Address Assignment: Enable or disable the Automatic IPv6 Address Assignment feature.

Enable Automatic DHCP-PD in LAN: Enable or disable DHCP-PD for other IPv6 routers connected to the LAN interface. **Note:** This feature requires a smaller subnet prefix than /64 (i.e. allowing for a larger address allocation), such as /63. Contact your ISP for more information.

Autoconfiguration Type: Select **SLAAC+RDNSS**, **SLAAC+Stateless DHCP**, or **Stateful DHCPv6**.

If you selected **SLAAC+RDNSS** or **SLAAC+Stateless DHCP** as the Autoconfiguration Type:

Router Advertisement Lifetime: Enter the router address advertisement lifetime (in minutes).

If you selected **Stateful DHCPv6** as the Autoconfiguration Type:

IPv6 Address Range (Start): Enter the starting IPv6 address for the DHCP server's IPv6 assignment.

IPv6 Address Range (End): Enter the ending IPv6 address for the DHCP server's IPv6 assignment.

IPv6 Advertisement Lifetime: Enter the IPv6 address lifetime (in minutes).

Click **Save** when you are done.

ADDRESS AUTOCONFIGURATION SETTINGS

Enable Automatic IPv6 Address Assignment: Enabled

Enable Automatic DHCP-PD in LAN: Enabled

Autoconfiguration Type: SLAAC+Stateless DHCP

Router Advertisement Lifetime: minutes

ADDRESS AUTOCONFIGURATION SETTINGS

Enable Automatic IPv6 Address Assignment: Enabled

Enable Automatic DHCP-PD in LAN: Enabled

Autoconfiguration Type: SLAAC+RDNSS

Router Advertisement Lifetime: minutes

ADDRESS AUTOCONFIGURATION SETTINGS

Enable Automatic IPv6 Address Assignment: Enabled

Autoconfiguration Type: Stateful DHCPv6

IPv6 Address Range (Start): xxxx :00

IPv6 Address Range (End): xxxx :00

Router Advertisement Lifetime: minutes

Static IPv6

Select **Static IP** if your IPv6 information is provided by your Internet Service Provider (ISP).

Use Link-Local Address: Enable or disable link-local address use.

Default Gateway: Enter the default gateway for your IPv6 connection.

Primary DNS Server: Enter the primary DNS server address.

Secondary DNS Server: Enter the secondary DNS server address.

If **Use Link-Local Address** is disabled these additional parameters are available for configuration:

IPv6 Address: Enter the address supplied by your ISP.

Subnet Prefix Length: Enter the subnet prefix length supplied by your ISP.

LAN IPv6 Address Settings

LAN IPv6 Address: Enter the LAN (local) IPv6 address for the router.

LAN IPv6 Link-Local Address: Displays the router's LAN link-local address.

The screenshot displays the IPv6 configuration interface on a D-Link router. At the top, there are navigation tabs for Home, Settings, Features, and Management. The main heading is 'IPv6', with a sub-note: 'All of your IPv6 Internet and network connection details are displayed on this page.' Below this, there's a breadcrumb trail: 'Settings >> Internet >> IPv6'. A 'Save' button is visible. The configuration is set to 'Static IPv6'. The 'Use Link-Local Address' option is currently 'Enabled'. There are input fields for 'Default Gateway', 'Primary DNS Server', and 'Secondary DNS Server'. A second section shows 'Use Link-Local Address' set to 'Disabled', with input fields for 'IPv6 Address', 'Subnet Prefix Length', 'Default Gateway', 'Primary DNS Server', and 'Secondary DNS Server'. A third section, 'LAN IPv6 ADDRESS SETTINGS', shows 'LAN IPv6 Address' and 'LAN IPv6 Link-Local Address: Not Available'. A link for 'Advanced Settings ...' is at the bottom right.

Static IPv6 (continued)

Advanced Settings - Address Autoconfiguration Settings

Enable Automatic IPv6 Address Assignment: Enable or disable the Automatic IPv6 Address Assignment feature.

Autoconfiguration Type: Select **SLAAC+RDNSS**, **SLAAC+Stateless DHCP**, or **Stateful DHCPv6**.

If you selected **SLAAC+RDNSS** or **SLAAC+Stateless DHCP** as the Autoconfiguration Type:

Router Advertisement Lifetime: Enter the router address advertisement lifetime (in minutes).

If you selected **Stateful DHCPv6** as the Autoconfiguration Type:

IPv6 Address Range (Start): Enter the starting IPv6 address for the DHCP server's IPv6 assignment.

IPv6 Address Range (End): Enter the ending IPv6 address for the DHCP server's IPv6 assignment.

IPv6 Advertisement Lifetime: Enter the IPv6 address lifetime (in minutes).

Click **Save** when you are done.

ADDRESS AUTOCONFIGURATION SETTINGS

Enable Automatic IPv6 Address Assignment: Enabled

Autoconfiguration Type: ▼

IPv6 Advertisement Lifetime: minutes

ADDRESS AUTOCONFIGURATION SETTINGS

Enable Automatic IPv6 Address Assignment: Enabled

Autoconfiguration Type: ▼

IPv6 Advertisement Lifetime: minutes

ADDRESS AUTOCONFIGURATION SETTINGS

Enable Automatic IPv6 Address Assignment: Enabled

Autoconfiguration Type: ▼

IPv6 Address Range (Start): xxxx :00

IPv6 Address Range (End): xxxx :00

Router Advertisement Lifetime: minutes

Auto Configuration (SLAAC/DHCPv6)

Select **Auto Configuration** if your ISP assigns your IPv6 address when your router requests one from the ISP's server. Some ISPs require you to adjust settings on your side before your router can connect to the IPv6 Internet.

IPv6 DNS Settings

DNS Type: Select either **Obtain DNS server address automatically** or **Use the following DNS address**.

If **Use the following DNS address** is selected:

Primary DNS Server: Enter the primary DNS server address.

Secondary DNS Server: Enter the secondary DNS server address.

LAN IPv6 Address Settings

Enable DHCP-PD: Enable or disable prefix delegation services.

LAN IPv6 Address: If you disabled DHCP-PD, enter the LAN (local) IPv6 address for the router.

LAN IPv6 Link-Local Address: Displays the router's LAN link-local address.

Auto Configuration (SLAAC/DHCPv6) (continued)

Advanced Settings - Address Autoconfiguration Settings

Enable Automatic IPv6 Address Assignment: Enable or disable the Automatic IPv6 Address Assignment feature.

If DHCP-PD is available and enabled in LAN IPv6 Address Settings:

Enable Automatic DHCP-PD in LAN: Enable or disable DHCP-PD for other IPv6 routers connected to the LAN interface. **Note:** This feature requires a smaller subnet prefix than /64 (i.e. allowing for a larger address allocation), such as /63. Contact your ISP for more information.

Autoconfiguration Type: Select **SLAAC+RDNSS**, **SLAAC+Stateless DHCP**, or **Stateful DHCPv6**.

If you selected **SLAAC+RDNSS** or **SLAAC+Stateless DHCP** as the Autoconfiguration Type:

Router Advertisement Lifetime: Enter the router address advertisement lifetime (in minutes).

If you selected **Stateful DHCPv6** as the Autoconfiguration Type:

IPv6 Address Range (Start): Enter the starting IPv6 address for the DHCP server's IPv6 assignment.

IPv6 Address Range (End): Enter the ending IPv6 address for the DHCP server's IPv6 assignment.

IPv6 Advertisement Lifetime: Enter the IPv6 address lifetime (in minutes).

Click **Save** when you are done.

ADDRESS AUTOCONFIGURATION SETTINGS

Enable Automatic IPv6 Address Assignment: Enabled

Enable Automatic DHCP-PD in LAN: Enabled

Autoconfiguration Type: ▼

IP Advertisement Lifetime: minutes

ADDRESS AUTOCONFIGURATION SETTINGS

Enable Automatic IPv6 Address Assignment: Enabled

Enable Automatic DHCP-PD in LAN: Enabled

Autoconfiguration Type: ▼

IP Advertisement Lifetime: minutes

ADDRESS AUTOCONFIGURATION SETTINGS

Enable Automatic IPv6 Address Assignment: Enabled

Enable Automatic DHCP-PD in LAN: Enabled

Autoconfiguration Type: ▼

IPv6 Address Range (Start):

IPv6 Address Range (End):

IP Advertisement Lifetime: minutes

ADDRESS AUTOCONFIGURATION SETTINGS

Enable Automatic IPv6 Address Assignment: Enabled

Enable Automatic DHCP-PD in LAN: Enabled

Autoconfiguration Type: ▼

IPv6 Address Range (Start):

IPv6 Address Range (End):

Router Advertisement Lifetime: minutes

PPPoE

Select **PPPoE** if your ISP provides and requires you to enter a PPPoE username and password in order to connect to the Internet.

PPPoE Session: Choose **Share with IPv4** to reuse your IPv4 PPPoE username and password, or **Create a new session**.

If you selected **Share with IPv4** configure the following options:

Address Mode: Select **Static IP** if your ISP assigned you an IP address. In most cases, select **Dynamic IP**.

IP Address: Enter the IP address provided by your ISP. (Static IP only)

MTU: Maximum Transmission Unit - you may need to change the MTU for optimal performance with your ISP.

If you selected **Create a new session**, configure the following options:

Username: Enter the username provided by your ISP.

Password: Enter the password provided by your ISP.

Address Mode: Select **Static IP** if your ISP assigned you an IP address. In most cases, select **Dynamic IP**.

IP Address: Enter the IP address provided by your ISP. (Static IP only)

Service Name: Enter the ISP service name (optional).

Reconnect Mode: Select either **Always On** or **Manual**.

MTU: Maximum Transmission Unit - you may need to change the MTU for optimal performance with your ISP.

D-Link
DIR-895L HW:V1 FW:1.12

Home | Settings | Features | Management

IPv6

All of your IPv6 Internet and network connection details are displayed on this page.

Settings >> Internet >> IPv6 IPv4 Save

My Internet Connection is: PPPoE

PPPoE Session: Share with IPv4

Address Mode: Dynamic IP

MTU: 1492 bytes

PPPoE Session: Share with IPv4

Address Mode: Static IP

IP Address:

MTU: 1492 bytes

PPPoE Session: Create a new session

Username:

Password:

Address Mode: Dynamic IP

Service Name:

Reconnect Mode: Always On

MTU: 1492 bytes

PPPoE Session: Create a new session

Username:

Password:

Address Mode: Static IP

IP Address:

Service Name:

Reconnect Mode: Always On

MTU: 1492 bytes

PPPoE(continued)

IPv6 DNS Settings

DNS Type: Select either **Obtain DNS server address automatically** or **Use the following DNS address**.

If **Use the following DNS address** is selected:

Primary DNS Server: Enter the primary DNS server address.

Secondary DNS Server: Enter the secondary DNS server address.

LAN IPv6 Address Settings

Enable DHCP-PD: Enable or disable prefix delegation services. This option is only available if you selected **Dynamic IP** for address mode.

LAN IPv6 Address: If DHCP-PD is disabled or static address mode is selected, enter the LAN (local) IPv6 address for the router.

LAN IPv6 Link-Local Address: Displays the router's LAN link-local address.

IPv6 DNS SETTINGS

DNS Type: ▼

IPv6 DNS SETTINGS

DNS Type: ▼

Primary DNS Server:

Secondary DNS Server:

LAN IPv6 ADDRESS SETTINGS

Enable DHCP-PD: Enabled

LAN IPv6 Link-Local Address: Not Available

[Advanced Settings ...](#)

LAN IPv6 ADDRESS SETTINGS

Enable DHCP-PD: Disabled

LAN IPv6 Address: /64

LAN IPv6 Link-Local Address: Not Available

[Advanced Settings ...](#)

PPPoE(continued)

Advanced Settings - Address Autoconfiguration Settings

Enable Automatic IPv6 Address Assignment: Enable or disable the Automatic IPv6 Address Assignment feature.

If **DHCP-PD** is available and enabled in LAN IPv6 Address Settings:

Enable Automatic DHCP-PD in LAN: Enable or disable DHCP-PD for other IPv6 routers connected to the LAN interface. **Note:** This feature requires a smaller subnet prefix than /64 (i.e. allowing for a larger address allocation), such as /63. Contact your ISP for more information.

Autoconfiguration Type: Select **SLAAC+RDNSS**, **SLAAC+Stateless DHCP**, or **Stateful DHCPv6**.

If you selected **SLAAC+RDNSS** or **SLAAC+Stateless DHCP** as the Autoconfiguration Type:

Router Advertisement Lifetime: Enter the router address advertisement lifetime (in minutes).

If you selected **Stateful DHCPv6** as the Autoconfiguration Type:

IPv6 Address Range (Start): Enter the starting IPv6 address for the DHCP server's IPv6 assignment.

IPv6 Address Range (End): Enter the ending IPv6 address for the DHCP server's IPv6 assignment.

IPv6 Advertisement Lifetime: Enter the IPv6 address lifetime (in minutes).

Click **Save** when you are done.

ADDRESS AUTOCONFIGURATION SETTINGS

Enable Automatic IPv6 Address Assignment: Enabled

Enable Automatic DHCP-PD in LAN: Enabled

Autoconfiguration Type: ▼

Router Advertisement Lifetime: minutes

ADDRESS AUTOCONFIGURATION SETTINGS

Enable Automatic IPv6 Address Assignment: Enabled

Enable Automatic DHCP-PD in LAN: Enabled

Autoconfiguration Type: ▼

Router Advertisement Lifetime: minutes

ADDRESS AUTOCONFIGURATION SETTINGS

Enable Automatic IPv6 Address Assignment: Enabled

Enable Automatic DHCP-PD in LAN: Enabled

Autoconfiguration Type: ▼

IPv6 Address Range (Start): xxxx::00

IPv6 Address Range (End): xxxx::00

Router Advertisement Lifetime: minutes

IPv6 in IPv4 Tunnel

The user can configure the IPv6 connection to run in IPv4 Tunnel mode. IPv6 over IPv4 tunnelling encapsulates IPv6 packets in IPv4 packets so that IPv6 packets can be sent over an IPv4 infrastructure.

Remote IPv4 Address: Enter the IPv4 remote address you will use.

Remote IPv6 Address: Enter the IPv6 remote address you will use.

Local IPv4 Address: Displays the current local IPv4 address.

Local IPv6 Address: Enter the IPv6 local address you will use.

Subnet Prefix Length: Enter the subnet prefix length supplied by your ISP.

IPv6 DNS Settings

DNS Type: Select either **Obtain DNS server address automatically** or **Use the following DNS address**.

If **Use the following DNS address** is selected:

Primary DNS Server: Enter the primary DNS server address.

Secondary DNS Server: Enter the secondary DNS server address.

The screenshot shows the D-Link router's web interface for IPv6 configuration. The top navigation bar includes 'Home', 'Settings', 'Features', and 'Management'. The main heading is 'IPv6' with a sub-note: 'All of your IPv6 Internet and network connection details are displayed on this page.' Below the heading is a breadcrumb trail: 'Settings >> Internet >> IPv6'. A 'Save' button is visible. The 'My Internet Connection is:' dropdown is set to 'IPv6 in IPv4 tunnel'. The 'Remote IPv4 Address' and 'Remote IPv6 Address' fields are empty. The 'Local IPv4 Address' is 'Not Available'. The 'Local IPv6 Address' and 'Subnet Prefix Length' fields are also empty. The 'IPv6 DNS SETTINGS' section has 'DNS Type' set to 'Obtain a DNS server address automatically'. The 'IPv6 DNS SETTINGS' section has 'DNS Type' set to 'Use the following DNS address', with empty fields for 'Primary DNS Server' and 'Secondary DNS Server'.

IPv6 in IPv4 Tunnel (continued)

LAN IPv6 Address Settings

Enable DHCP-PD: Enable or disable prefix delegation services.

LAN IPv6 Address: If you disabled DHCP-PD, enter the LAN (local) IPv6 address for the router.

LAN IPv6 Link-Local Address: Displays the router's LAN link-local address.

LAN IPv6 ADDRESS SETTINGS

Enable DHCP-PD: Enabled

LAN IPv6 Link-Local Address: Not Available

Advanced Settings ...

LAN IPv6 ADDRESS SETTINGS

Enable DHCP-PD: Disabled

LAN IPv6 Address: /64

LAN IPv6 Link-Local Address: Not Available

Advanced Settings ...

Advanced Settings - Address Autoconfiguration Settings

Enable Automatic IPv6 Address Assignment: Enable or disable the Automatic IPv6 Address Assignment feature.

If DHCP-PD is available and enabled in LAN IPv6 Address Settings:

Enable Automatic DHCP-PD in LAN: Enable or disable DHCP-PD for other IPv6 routers connected to the LAN interface. **Note:** *This feature requires a smaller subnet prefix than /64 (i.e. allowing for a larger address allocation), such as /63. Contact your ISP for more information.*

Autoconfiguration Type: Select **SLAAC+RDNSS**, **SLAAC+Stateless DHCP**, or **Stateful DHCPv6**.

If you selected **SLAAC+RDNSS** or **SLAAC+Stateless DHCP** as the Autoconfiguration Type:

ADDRESS AUTOCONFIGURATION SETTINGS

Enable Automatic IPv6 Address Assignment: Enabled

Enable Automatic DHCP-PD in LAN: Enabled

Autoconfiguration Type: ▼

Router Advertisement Lifetime: minutes

ADDRESS AUTOCONFIGURATION SETTINGS

Enable Automatic IPv6 Address Assignment: Enabled

Enable Automatic DHCP-PD in LAN: Enabled

Autoconfiguration Type: ▼

Router Advertisement Lifetime: minutes

ADDRESS AUTOCONFIGURATION SETTINGS

Enable Automatic IPv6 Address Assignment: Enabled

Enable Automatic DHCP-PD in LAN: Enabled

Autoconfiguration Type: ▼

IPv6 Address Range (Start): xxxx :00

IPv6 Address Range (End): xxxx :00

Router Advertisement Lifetime: minutes

Router Advertisement Lifetime: Enter the router address advertisement lifetime (in minutes).

IPv6 in IPv4 Tunnel (continued)

If you selected **Stateful DHCPv6** as the Autoconfiguration Type:

IPv6 Address Range (Start): Enter the starting IPv6 address for the DHCP server's IPv6 assignment.

IPv6 Address Range (End): Enter the ending IPv6 address for the DHCP server's IPv6 assignment.

IPv6 Advertisement Lifetime: Enter the IPv6 address lifetime (in minutes).

Click **Save** when you are done.

ADDRESS AUTOCONFIGURATION SETTINGS

Enable Automatic IPv6 Address Assignment: Enabled

Enable Automatic DHCP-PD in LAN: Enabled

Autoconfiguration Type: SLAAC+RDNSS

Router Advertisement Lifetime: minutes

ADDRESS AUTOCONFIGURATION SETTINGS

Enable Automatic IPv6 Address Assignment: Enabled

Enable Automatic DHCP-PD in LAN: Enabled

Autoconfiguration Type: SLAAC+Stateless DHCP

Router Advertisement Lifetime: minutes

ADDRESS AUTOCONFIGURATION SETTINGS

Enable Automatic IPv6 Address Assignment: Enabled

Enable Automatic DHCP-PD in LAN: Enabled

Autoconfiguration Type: Stateful DHCPv6

IPv6 Address Range (Start): xxxx::00

IPv6 Address Range (End): xxxx::00

Router Advertisement Lifetime: minutes

6to4

In this section the user can configure the IPv6 6 to 4 connection settings. 6to4 is an IPv6 address assignment and automatic tunneling technology that is used to provide unicast IPv6 connectivity between IPv6 sites and hosts across the IPv4 Internet.

6to4 Address: Displays the 6 to 4 address.

6to4 Relay: Enter the 6 to 4 relay supplied by your ISP.

Primary DNS Server: Enter the primary DNS server address.

Secondary DNS Server: Enter the secondary DNS server address.

LAN IPv6 Address Settings

LAN IPv6 Address: Enter the LAN (local) IPv6 address for the router.

LAN IPv6 Link-Local Address: Displays the router's LAN link-local address.

The screenshot shows the D-Link IPv6 configuration interface. At the top, there is a navigation bar with 'Home', 'Settings', 'Features', and 'Management'. Below this, the 'IPv6' section is displayed with a sub-header 'All of your IPv6 Internet and network connection details are displayed on this page.' The main configuration area includes a breadcrumb trail 'Settings >> Internet >> IPv6' and a 'Save' button. The 'My Internet Connection is:' dropdown is set to '6to4'. Below this, the '6to4 Address' is 'Not Available', the '6to4 Relay' is '192.88.99.1', and the 'Primary DNS Server' and 'Secondary DNS Server' fields are empty. The 'LAN IPv6 ADDRESS SETTINGS' section shows the 'LAN IPv6 Address' as 'FFFF:FFFF:FFFF: [] ::1 /64' and the 'LAN IPv6 Link-Local Address' as 'Not Available'. An 'Advanced Settings ...' link is located at the bottom right.

6to4 (continued)

Advanced Settings - Address Autoconfiguration Settings

Enable Automatic IPv6 Address Assignment: Enable or disable the Automatic IPv6 Address Assignment feature.

Autoconfiguration Type: Select **SLAAC+RDNSS**, **SLAAC+Stateless DHCP**, or **Stateful DHCPv6**.

If you selected **SLAAC+RDNSS** or **SLAAC+Stateless DHCP** as the Autoconfiguration Type:

Router Advertisement Lifetime: Enter the router address advertisement lifetime (in minutes).

If you selected **Stateful DHCPv6** as the Autoconfiguration Type:

IPv6 Address Range (Start): Enter the starting IPv6 address for the DHCP server's IPv6 assignment.

IPv6 Address Range (End): Enter the ending IPv6 address for the DHCP server's IPv6 assignment.

IPv6 Advertisement Lifetime: Enter the IPv6 address lifetime (in minutes).

Click **Save** when you are done.

ADDRESS AUTOCONFIGURATION SETTINGS

Enable Automatic IPv6 Address Assignment: Enabled

Autoconfiguration Type: ▼

IPv6 Advertisement Lifetime: minutes

ADDRESS AUTOCONFIGURATION SETTINGS

Enable Automatic IPv6 Address Assignment: Enabled

Autoconfiguration Type: ▼

IPv6 Advertisement Lifetime: minutes

ADDRESS AUTOCONFIGURATION SETTINGS

Enable Automatic IPv6 Address Assignment: Enabled

Autoconfiguration Type: ▼

IPv6 Address Range (Start): xxxx :00

IPv6 Address Range (End): xxxx :00

Router Advertisement Lifetime: minutes

6rd

If your ISP uses the 6rd protocol for IPv6 connectivity, configure it using these options.

Assign IPv6 Prefix: Currently unsupported.

Primary DNS Server: Enter the primary DNS server address.

Secondary DNS Server: Enter the secondary DNS server address.

6rd Manual Configuration

Enable Hub and Spoke Mode: Enable if you want to minimize the number of routes to the destination by using a hub and spoke method of networking.

6rd Configuration: Choose the **6rd DHCPv4 Option** to automatically discover and populate the data values, or **Manual Configuration** to enter the settings yourself.

If you selected **Manual configuration**, configure the following options:

6rd IPv6 Prefix: Enter the 6rd IPv6 prefix and mask length supplied by your ISP.

WAN IPv4 Address Displays the router's IPv4 address.

6rd Border Relay IPv4 Address: Enter the 6rd border relay IPv4 address settings supplied by your ISP.

LAN IPv6 Address Settings

LAN IPv6 Address: Displays the router's LAN IPv6 Address link-local address.

LAN IPv6 Link-Local Address: Displays the router's LAN link-local address.

6rd (continued)

Advanced Settings - Address Autoconfiguration Settings

Enable Automatic IPv6 Address Assignment: Enable or disable the Automatic IPv6 Address Assignment feature.

Autoconfiguration Type: Select **SLAAC+RDNSS**, **SLAAC+Stateless DHCP**, or **Stateful DHCPv6**.

If you selected **Stateful DHCPv6** as the Autoconfiguration Type:

IPv6 Address Range (Start): Enter the starting IPv6 address for the DHCP server's IPv6 assignment.

IPv6 Address Range (End): Enter the ending IPv6 address for the DHCP server's IPv6 assignment.

IPv6 Advertisement Lifetime: Enter the IPv6 address lifetime (in minutes).

Click **Save** when you are done.

ADDRESS AUTOCONFIGURATION SETTINGS

Enable Automatic IPv6 Address Assignment: Enabled

Autoconfiguration Type: SLAAC+Stateless DHCP

IPv6 Advertisement Lifetime: minutes

ADDRESS AUTOCONFIGURATION SETTINGS

Enable Automatic IPv6 Address Assignment: Enabled

Autoconfiguration Type: SLAAC+RDNSS

IPv6 Advertisement Lifetime: minutes

ADDRESS AUTOCONFIGURATION SETTINGS

Enable Automatic IPv6 Address Assignment: Enabled

Autoconfiguration Type: Stateful DHCPv6

IPv6 Address Range (Start): xxxx :00 3

IPv6 Address Range (End): xxxx :00 16

Router Advertisement Lifetime: minutes

Local Connectivity Only

Local Connectivity Only allows you to set up a local IPv6 connection that does not connect to the Internet.

Advanced Settings

IPv6 ULA Settings

Enable ULA: Click here to enable Unique Local IPv6 Unicast Addresses (ULA) settings.

If you selected **Enable ULA** and **Disabled Default ULA Prefix:**

ULA Prefix: Enter your own ULA prefix.

Current IPv6 ULA Settings

Current ULA Prefix: Displays the current ULA prefix.

LAN IPv6 ULA: Displays the LAN's IPv6 ULA.

Click **Save** when you are done.

Wireless

From this page you can configure your wireless network settings.

Smart Connect

Smart Connect: When Smart Connect is enabled, the router automatically assigns devices to the ideal wireless network to improve performance.

Wi-Fi Name (SSID): Create a name for your wireless network using up to 32 characters.

Password: Create a password to use for wireless security. Wireless clients will need to enter this password to successfully connect to the network.

Advanced Settings

Security Mode: Choose **None**, **WEP**, or **WPA/WPA2-Personal** (recommended).

Transmission Power: Select the desired wireless transmission power.

Schedule: Use the drop-down menu to select a schedule to apply. The schedule may be set to **Always Enable**, or you can create your own schedules in the **Schedules** section. Refer to **Schedule** on page **94** for more information.

Wi-Fi Protected Setup

The easiest way to connect your wireless devices to the router is with Wi-Fi Protected Setup (WPS). Using WPS-PIN disabled by default due to security vulnerabilities.

WPS-PBC Status: Enable or disable WPS-PBC functionality.

WPS-PIN Status: Enable or disable WPS-PIN functionality.

Refer to the next page if you wish to disable Smart Connect or click **Save** when you are done.

The screenshot displays the D-Link router's configuration interface for wireless settings. At the top, the D-Link logo and model number (DIR-895L HW:V1 FW:1.12) are visible, along with navigation tabs for Home, Settings, Features, and Management. The main heading is 'Wireless', with a sub-instruction: 'Use this section to configure the wireless settings for your D-Link Router. Please make sure that any changes made in this section will need to be updated on your wireless device.' Below this, there are two main sections: 'Smart Connect' and 'Advanced Settings'. In the 'Smart Connect' section, 'Smart Connect' is set to 'Enabled', 'Wi-Fi Name (SSID)' is 'Your_Wi-Fi_Network', and 'Password' is 'A_Str0nG_P@ssW0rd!%t'. The 'Advanced Settings' section includes 'Security Mode' (WPA/WPA2-Personal), 'Transmission Power' (High), and 'Schedule' (Always Enable). At the bottom, the 'Wi-Fi Protected Setup' section shows 'WPS-PBC Status' as 'Enabled' and 'WPS-PIN Status' as 'Locked'. A 'Save' button is located at the top right of the configuration area.

Wireless - Smart Connect Disabled

If Smart Connect is **Disabled** the following options are available:

2.4GHz / Primary 5GHz / Secondary 5GHz

Status: Enable or disable the 2.4 GHz and 5 GHz wireless networks.

Wi-Fi Name (SSID): Create a name for your wireless network using up to 32 characters.

Password: Create a password to use for wireless security.

Advanced Settings

Security Mode: Choose **None**, **WEP**, or **WPA/WPA2-Personal** (recommended).

802.11 Mode (2.4 GHz): Select the desired wireless networking standards to use. The available options for the 2.4 GHz wireless network are **Mixed 802.11b/g/n**, **Mixed 802.11g/n**, **802.11n only**.

802.11 Mode (5 GHz): Select the desired wireless networking standards to use. The available options for the 5 GHz wireless network are **Mixed 802.11a/n/ac**, **Mixed 802.11n/ac**, **802.11ac only**, **Mixed 802.11a/n**, **Mixed 802.11n only**, or **802.11a only**.

Wi-Fi Channel: Select the desired channel. The default is **Auto** (recommended).

Transmission Power: Select the desired wireless transmission power.

Channel Width (2.4 GHz): Select **Auto 20/40** if you are using both 802.11n and non-802.11n devices, or select **20 MHz** if you are not using any 802.11n devices.

Channel Width (5 GHz): Select **Auto 20/40/80** if you are using 802.11ac, 802.11n, and 802.11a devices, select **Auto 20/40** if you are using 802.11n and 802.11a devices, or select **20 MHz** if you are only using 802.11a devices.

HT20/40 Coexistence: (2.4 GHz): Enable or disable HT20/40 Coexistence.

Visibility Status: The default setting is **Visible**. Select **Invisible** if you do not want to broadcast the SSID of your wireless network.

Schedule: Use the drop-down menu to select a schedule to apply. The schedule may be set to **Always Enable**, or you can create your own schedules in the **Schedules** section. Refer to **Schedule** on page **94** for more information.

Wi-Fi Protected Setup

The easiest way to connect your wireless devices to the router is with Wi-Fi Protected Setup (WPS). Using WPS-PIN disabled by default due to security vulnerabilities.

WPS-PBC Status: Enable or disable WPS-PBC functionality.

WPS-PIN Status: Enable or disable WPS-PIN functionality.

Click **Save** when you are done.

Secondary 5GHz

Status: Enabled

Wi-Fi Name (SSID):

Password:

[Advanced Settings ...](#)

Security Mode: ▼

802.11 Mode: ▼

Wi-Fi Channel: ▼

Transmission Power: ▼

Channel Width: ▼

Visibility Status: ▼

Schedule: ▼

Wi-Fi Protected Setup

WPS-PBC Status: Enabled

WPS-PIN Status: Locked

Guest Zone

The guest zone feature will allow you to create temporary zones that can be used by guests to access the Internet. These zones will be separate from your main wireless network. In the Settings menu on the bar on the top of the page, click **Wireless**, then click the **Guest Zone** link.

If **Smart Connect** is enabled the following options will be available:

Smart Connect

Status: Enable or disable the Guest wireless network.

Wi-Fi Name (SSID): Create a name for your wireless network using up to 32 characters.

Password: Create a password to use for wireless security.

If **Smart Connect** is disabled the following options will be available:

2.4GHz / Primary 5GHz / Secondary 5GHz

Status: Enable or disable the 2.4 GHz and 5 GHz wireless networks.

Wi-Fi Name (SSID): Create a name for your wireless network using up to 32 characters.

Password: Create a password to use for wireless security.

Home Network Access

Internet Access Only: Enabling this option will confine connectivity to the Internet, disallowing guests from accessing other local network devices.

Click **Save** when you are done.

The screenshot displays the D-Link router's web interface for configuring the Guest Zone. At the top, there's a navigation bar with 'Home', 'Settings', 'Features', and 'Management'. The 'Settings' menu is active, and the 'Guest Zone' page is open. Below the navigation, there's a header with the D-Link logo and model number (DIR-895L HW:V1 FW:1.12). The main content area is titled 'Guest Zone' and includes a brief description: 'This page lets you enable and configure a Wi-Fi Guest Zone. Users connected to a Guest Zone cannot communicate or detect devices on your home network unless Internet Access Only is disabled under Home Network Access.' Below this, there's a breadcrumb trail 'Settings >> Wireless >> Guest Zone' and a 'Wi-Fi' button. The configuration is divided into several sections: 'Smart Connect' (Status: Enabled, Wi-Fi Name: dlink-guest, Password: A_Str0nG_P@ssW0rd!%), '2.4GHz' (Status: Enabled, Wi-Fi Name: dlink-guest, Password: A_Str0nG_P@ssW0rd!%), 'Primary 5GHz' (Status: Enabled, Wi-Fi Name: dlink-guest, Password: A_Str0nG_P@ssW0rd!%), 'Secondary 5GHz' (Status: Enabled, Wi-Fi Name: dlink-guest, Password: A_Str0nG_P@ssW0rd!%), and 'Home Network Access' (Internet Access Only: Enabled). A 'Save' button is located at the top right of the configuration area.

Network

This section will allow you to change the local network settings of the router and to configure the DHCP settings. In the Settings menu on the bar on the top of the page, click **Network**. Click **Advanced Settings...** to expand the list and see all of the options.

Network Settings

LAN IP Address: Enter the IP address of the router. The default IP address is **192.168.0.1**. If you change the IP address, once you click **Save**, you will need to enter the new IP address in your browser to get back into the configuration utility.

Subnet Mask: Enter the subnet mask of the router. The default subnet mask is **255.255.255.0**.

Management Link: The default address to access the router's configuration is **http://dlinkrouter.local/**. Here, you can replace **dlinkrouter** with a name of your choice.

Local Domain Name: Enter the domain name (optional).

Enable DNS Relay: Disable to transfer the DNS server information from your ISP to your computers. If enabled, your computers will use the router for a DNS server.

The screenshot shows the D-Link web interface for the DIR-895L router. The top navigation bar includes 'Home', 'Settings', 'Features', and 'Management'. The main heading is 'Network'. Below the heading is a brief instruction: 'Use this section to configure the network settings for your device. You can enter a name for your device in the management link field, and use the link to access web UI in a web browser. Recommend to change the management link if there are more than one D-Link devices within the network.' A 'Save' button is located in the top right corner of the settings area.

Network Settings

LAN IP Address:

Subnet Mask:

Management Link:

Local Domain Name:

Enable DNS Relay: Enabled

[Advanced Settings ...](#)

DHCP Server

Status: Enabled

DHCP IP Address Range: to

DHCP Lease Time: minutes

Always Broadcast: Enabled
(compatibility for some DHCP Clients)

Advanced Settings

WAN Port Speed:

UPnP: Enabled

IPv4 Multicast Streams: Enabled

IPv6 Multicast Streams: Enabled

COPYRIGHT © 2016 D-Link

Network (continued)

Advanced Settings - DHCP Server

Status: Enable or disable the DHCP server.

DHCP IP Address Range: Enter the starting and ending IP addresses for the DHCP server's IP assignment.

Note: *If you statically (manually) assign IP addresses to your computers or devices, make sure the IP addresses are outside of this range or you may have an IP conflict.*

DHCP Lease Time: Enter the length of time for the IP address lease in minutes.

Always Broadcast: Enable this feature to broadcast your network's DHCP server to LAN/WLAN clients.

Advanced Settings

WAN Port Speed: You may set the port speed of the Internet port to **10 Mbps**, **100 Mbps**, **1000 Mbps**, or **Auto** (recommended).

UPnP: Enable or disable Universal Plug and Play (UPnP). UPnP provides compatibility with networking equipment, software, and peripherals.

IPv4 Multicast Stream: Enable to allow IPv4 multicast traffic to pass through the router from the Internet.

IPv6 Multicast Stream: Enable to allow IPv6 multicast traffic to pass through the router from the Internet.

Click **Save** when you are done.

The screenshot shows the D-Link web interface for the DIR-895L router. The top navigation bar includes 'Home', 'Settings', 'Features', and 'Management'. The main heading is 'Network'. Below this, there is a 'Save' button and a 'Settings >> Network' breadcrumb. The 'Network Settings' section includes fields for LAN IP Address (192.168.0.1), Subnet Mask (255.255.255.0), Management Link (http://dlinkrouter.local/), Local Domain Name, and Enable DNS Relay (Enabled). The 'DHCP Server' section shows Status (Enabled), DHCP IP Address Range (192.168.0.100 to 192.168.0.199), DHCP Lease Time (10080 minutes), and Always Broadcast (Enabled). The 'Advanced Settings' section includes WAN Port Speed (Auto), UPnP (Enabled), IPv4 Streams (Enabled), and IPv6 Multicast Streams (Enabled). The footer contains the copyright notice 'COPYRIGHT © 2016 D-Link'.

SharePort

This page will allow you to set up access to files on an external USB device plugged into the router. You can do this through the local network or from the Internet using either a web browser or an app on your smartphone or tablet. In the Settings menu on the bar on the top of the page, click **SharePort**.

DLNA Media Server

Status: Enable or disable the DLNA media server function, allowing connected clients access to media files over the network.

DLNA Media Server: Choose a name for your DLNA media server so that it can be found.

Windows File Sharing (SAMBA)

Status: Enable or disable the Windows File Sharing function, allowing connected clients access to media files over the network.

Windows File Sharing: Choose either **Allow all users to access (no password)** or **Require router's admin password** to specify whether the router's password will be required for access.

Web File Access

Web File Access: Enable or disable remote access to files stored on a USB device plugged into the router through a web browser.

Direct Links: This area will display the HTTP and HTTPS links to connect to your SharePort drive through a web browser from a device on your network.

Click **Save** when you are done.

The screenshot shows the D-Link SharePort configuration interface. At the top, there is a navigation bar with 'Home', 'Settings', 'Features', and 'Management'. The 'Settings' menu is active. Below the navigation bar, there is a 'SharePort' section with a brief description: 'SharePort allows you to share photos, music, movies and files simply by connecting a USB drive to your router. Access your files locally and remotely using the free mydlink SharePort app for your iOS or Android devices, or access them on a computer through the SharePort Web Access. The built-in Digital Living Network Alliance (DLNA) media server allows you to stream multimedia content to any DLNA compliant devices such as smart TVs and games consoles.' Below this, there are three main configuration sections: 'DLNA Media Server', 'Windows File Sharing (SAMBA)', and 'Web File Access'. Each section has a 'Status' dropdown set to 'Enabled' and a 'Save' button. The 'DLNA Media Server' section also has a text input field for the server name, which is currently 'DIR-895L_DMS'. The 'Windows File Sharing (SAMBA)' section has a dropdown menu for 'Windows File Sharing' set to 'Require router's admin password'. The 'Web File Access' section has a 'Direct Links' field displaying 'http://shareport.local/' and 'https://shareport.local/'. At the bottom of the page, there is a copyright notice: 'COPYRIGHT © 2016 D-Link'.

Create User

The Create User page allows you to manage SharePort user accounts. This page lists active user accounts, their current permissions, and access paths. Users without accounts are restricted to guest access which only has access to the "Guest" folder on the media server. A maximum of ten accounts (including "Admin" can be registered at any given time.

If you wish to remove an account, click on the corresponding trash can icon in the Delete column. If you wish to edit an account, click on the corresponding pencil icon in the Edit column. If you wish to create a new account, click the **Create User** button. If you edit or create a user, the following options appear:

Create New User

- User Name:** Enter the desired user name for the new account.
- Password:** Enter the password which the user will need to enter when logging in.
- Permission:** Select either **Read Only** or **Read/Write** to control whether the user can edit, add, or delete files on the device.
- Folder:** Choose the parent folder for the user. Files and folders on a higher level will be unavailable. Giving a user "root" allows access to all files on the device. To change the selected folder, click **Browse** and browse to the desired folder.

Click **OK** when you are done. The new user should be added to the list of user accounts. To save the new list, click **Save**. To return to the SharePort page, click **SharePort**.

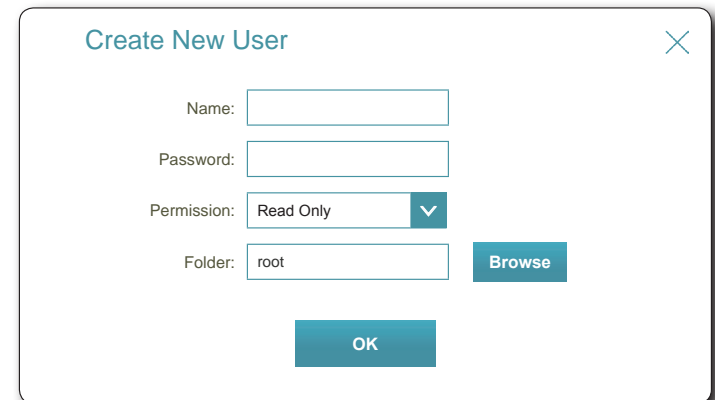
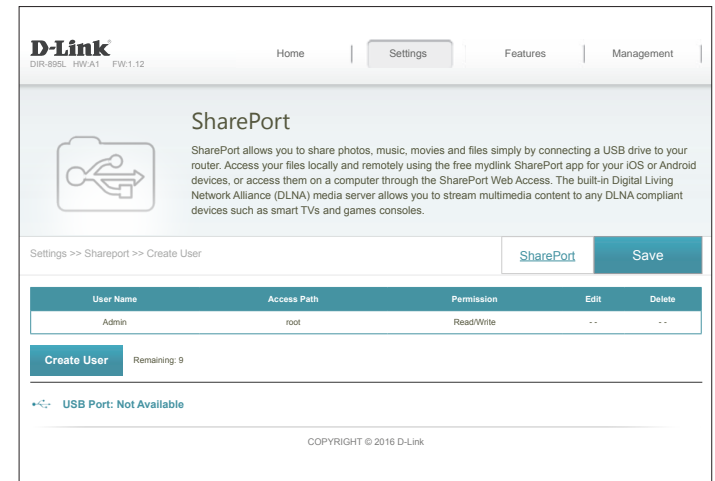

mydlink

Enabling mydlink allows you to access and manage the mydlink-compatible devices on your network. This can be done either through a web browser or via the mydlink smartphone app.

This page allows you to sign in to an existing mydlink account, or sign up for a new account. In the Settings menu on the bar on the top of the page, click **mydlink**.

If you do not already have a mydlink account, click **No, I want to create a new mydlink account**. Enter out your email address (which will also function as your username), create a password, and enter your first and last name. Then, click **Sign Up** to create your new mydlink account.

If you already have a mydlink account, click **Yes, I have a mydlink account**. Enter your email address (which is also your username) and password. Then, click **Sign In** to register your existing mydlink account with your router.

The screenshot shows the D-Link mydlink registration page. At the top, there is a navigation bar with 'Home', 'Settings', 'Features', and 'Management'. Below the navigation bar, the 'mydlink' logo is displayed, followed by a brief description of the service. The main content area is titled 'mydlink Registration' and contains a form. The form asks 'Do you have an existing mydlink account?' with two radio button options: 'Yes, I have a mydlink account.' and 'No, I want to create a new mydlink account.' The 'No' option is selected. Below this, there are four input fields: 'E-mail Address (Account Name):', 'Password:', 'First Name:', and 'Last Name:'. At the bottom of the form, there is a checkbox labeled 'I accept the mydlink terms and conditions.' and a 'Sign up' button. The footer of the page reads 'COPYRIGHT © 2016 D-Link'.

The screenshot shows the D-Link mydlink registration page. At the top, there is a navigation bar with 'Home', 'Settings', 'Features', and 'Management'. Below the navigation bar, the 'mydlink' logo is displayed, followed by a brief description of the service. The main content area is titled 'mydlink Registration' and contains a form. The form asks 'Do you have an existing mydlink account?' with two radio button options: 'Yes, I have a mydlink account.' and 'No, I want to create a new mydlink account.' The 'Yes' option is selected. Below this, there are two input fields: 'E-mail Address (Account Name):' and 'Password:'. At the bottom of the form, there is a checkbox labeled 'I accept the mydlink terms and conditions.' and a 'Sign In' button. The footer of the page reads 'COPYRIGHT © 2016 D-Link'.

Features

QoS Engine

This device features an advanced, yet easy-to-use Intelligent Quality of Service (iQoS) Engine. QoS allows you to prioritize Internet traffic to ensure a better web browsing experience in situations where bandwidth is limited or large numbers of devices are in use. The QoS Engine allows you to prioritize Internet traffic by selecting to either **Manage by Application** or **Manage by Device**. The drag and drop interface allows you to arrange which traffic is given higher priority.

When using **Manage by Application**, you can prioritize traffic across all of your devices. For example, you can give streaming media a higher priority than file downloads.

When using **Manage by Devices**, you can create a device hierarchy to give a higher priority to specific devices. For example, you can give a desktop computer a more responsive Internet experience than a tablet or mobile device.

Management type: Select either **Manage by Application**, **Manage by Devices**, or **Off**.

Uplink Speed (Mbps): This number indicates the maximum upload speed for determining the QoS rules. You may manually input or adjust this number.

Downlink Speed (Mbps): This number indicates the maximum download speed for determining the QoS rules. You may manually input or adjust this number.

Detect Bandwidth: Click this button to automatically test your Internet connection speed. After the test is complete, the Uplink Speed and Downlink Speed values populate automatically. Alternatively, you may manually set these numbers based on information provided by your ISP.

The following pages provide more detail and usage scenarios to help you improve your Internet experience.

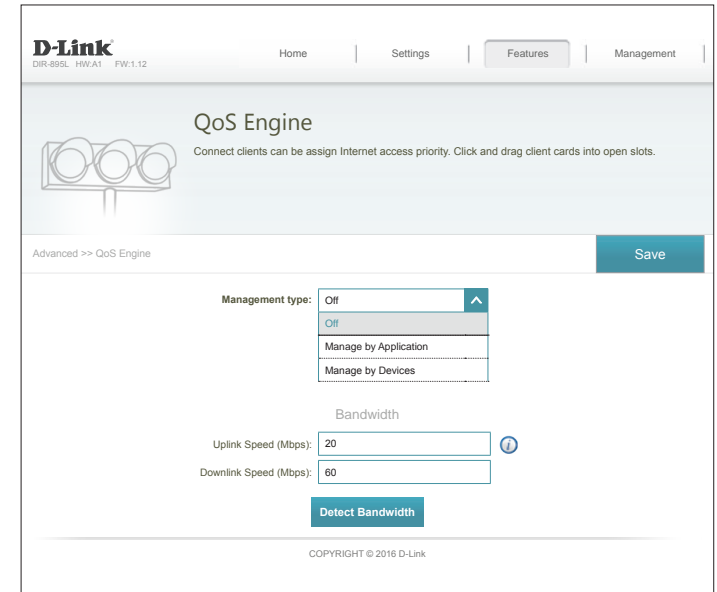

Manage by Application

Manage by Application lets you prioritize specific kinds of traffic across all connected devices to optimize your Internet experience. Under Applications, there are six types of traffic cards: Streaming Media, Online Chat & Mail, Games, Web & Social Network, File Transfer & P2P, and Others. If some are off-screen, you can use the arrow icons on either side of the page to scroll through the cards.

One application can be assigned **Highest** priority.

Two applications can be assigned **High** priority.

Three applications can be assigned **Medium** priority.

If no applications types are explicitly assigned a priority, they will all be treated with equal priority. If some devices are not assigned a priority and others are, the unassigned application types will be treated with the lowest priority.

To assign a priority level to an application type, drag the desired card from the Applications list over an empty slot and release the mouse button. The card will remain in the slot. If you want to remove a priority assignment from an application type and return it to the Applications list, click the x icon in the top right of the card.

For example, if you are experiencing poor quality VoIP phone calls or video chat due to excessive downloads, you can use the configuration displayed to the right to prioritize your calls and chats over other application types.

Be sure to keep your router firmware updated as new application traffic definitions are included.

Click **Save** when you are done.

The screenshot displays the D-Link QoS Engine configuration interface. At the top, the navigation bar includes 'Home', 'Settings', 'Features', and 'Management'. The main heading is 'QoS Engine' with a sub-note: 'Connect clients can be assign Internet access priority. Click and drag client cards into open slots.' Below this, the 'Management type' is set to 'Manage by Application'. The 'Bandwidth' section shows 'Uplink Speed (Mbps)' at 20 and 'Downlink Speed (Mbps)' at 60, with a 'Detect Bandwidth' button. The 'Applications' section features a scrollable list of application cards: 'File Transfer & P2P', 'Others', 'Online Chat & Mail' (dragged to the 'Highest' priority slot), 'Streaming Media' (dragged to the 'High' priority slot), 'Games' (dragged to the 'High' priority slot), and 'Web & Social Network' (dragged to the 'Medium' priority slot). A 'Save' button is located in the top right corner of the configuration area.

Manage by Devices

Manage by Devices lets you to prioritize Internet access on your network by device to ensure an optimum Internet experience. Under **Connected Clients** you can see cards which represent each device connected to your router. The arrow icons allow you to see any devices which may be off screen. Refer to **Connected Clients** on page 38 for information on renaming devices.

One device can be assigned **Highest** priority.

Two devices can be assigned **High** priority.

Six devices can be assigned **Medium** priority.

If no devices are explicitly assigned a priority, all devices are all treated with equal priority. If only some devices are assigned priorities, all unassigned devices are treated with the lowest priority.

To assign a priority level to a device, click and drag the device card from the **Connected Clients** list over an empty slot and release the mouse button. The card will remain in the slot. If you want to remove a priority assignment from a device and return it to the All Devices list, click the x icon in the top right of the device card.

In the example to the right **Your PC** is assigned highest priority, **Your Home Theater PC** and **Your Mobile Phone** are assigned high priority, **Your Server** is assigned medium priority, and the **Excessive Downloader**'s traffic is assigned to the lowest priority queue. In this scenario, the router allocates bandwidth to your **Your PC** first, then **Your Home Theater PC** and **Your Mobile Phone**, and then **Your Server**. Any remaining bandwidth is given to the **Excessive Downloader**.

Manage by Devices utilizes the unique MAC address of each device to enforce QoS rules.

Click **Save** when you are done.

The screenshot displays the D-Link QoS Engine configuration interface. At the top, navigation links for Home, Settings, Features, and Management are present. The main heading is 'QoS Engine' with a sub-instruction: 'Connect clients can be assign Internet access priority. Click and drag client cards into open slots.' Below this, the 'Management type' is set to 'Manage by Devices'. Bandwidth settings are shown as Uplink Speed (Mbps): 20 and Downlink Speed (Mbps): 60, with a 'Detect Bandwidth' button. The 'Connected Clients' section shows a list of devices and three priority queues: 'Highest' (yellow), 'High' (blue), and 'Medium' (grey). 'Your PC' (D-LINK, 192.168.0.165) is assigned to the Highest queue. 'Your Home Theater PC' (Vendor, 192.168.0.155) and 'Your Mobile Phone' (Vendor, 192.168.0.155) are assigned to the High queue. 'Your Server' (Vendor, 192.168.0.155) is assigned to the Medium queue. An 'Excessive Downloader' (D-LINK, 192.168.0.175) is listed but not assigned. A 'Save' button is located in the top right corner.

Firewall Settings

The router's firewall protects your network from malicious attacks over the Internet. In the Features menu on the bar on the top of the page, click **Firewall Settings**. Click **Advanced Settings...** to expand the list and see all of the options.

Enable DMZ: Enable or disable the Demilitarized Zone (DMZ). Enabling DMZ is not recommended.

DMZ IP Address: If DMZ is enabled, enter the IP address of the client you wish to expose, or use the drop-down menu to quickly select it.

Enable SPI IPv4: Enabling Stateful Packet Inspection (SPI) helps prevent cyber attacks by validating that the traffic passing through the session conforms to known patterns.

Enable Anti-Spoof Checking: Enable this feature to protect your network from certain kinds of "spoofing" attacks.

IPv6 Simple Security: Enable or disable IPv6 simple security.

IPv6 Ingress Filtering: Enable or disable IPv6 ingress filtering.

D-Link
DIR-895L HW:V1 FW:1.12

Home | Settings | **Features** | Management

Firewall Settings

Your router's high-performance firewall feature continuously monitors Internet traffic, protecting your network and connected devices from malicious Internet attacks.

Features >> Firewall Settings >> Advanced

IPv4 Rules | IPv6 Rules | Save

Enable DMZ: Enabled

DMZ IP Address: << Computer Name

Enable SPI IPv4: Disabled

Enable Anti-spoof Checking: Disabled

IPv6 Simple Security: Disabled

IPv6 Ingress Filtering: Disabled

[Advanced Settings ...](#)

Application Level Gateway (ALG) Configuration

PPTP: Enabled

IPSec (VPN): Enabled

RTSP: Enabled

SIP: Enabled

COPYRIGHT © 2016 D-Link

Firewall Settings (continued)

Advanced Settings - Application Level Gateway (ALG) Configuration

PPTP: Allows multiple machines on the LAN to connect to their corporate network using the Point-to-Point Tunneling protocol (PPTP) based VPNs.

IPSec (VPN): Allows VPN clients to connect to their corporate IPSec-based network. Some VPN clients support traversal of IPSec through NAT. This Application Level Gateway (ALG) may interfere with the operation of such VPN clients. If you are having trouble connecting with your corporate network, try turning this ALG off. Please check with the system administrator of your corporate network whether your VPN client supports NAT traversal.

RTSP: Allows applications that use Real Time Streaming Protocol (RTSP) to receive streaming media from the Internet.

SIP: Enabling Session Initiation Protocol (SIP) allows devices and applications using VoIP (Voice over IP). Some VoIP applications and devices have the ability to discover NAT devices and work around them. This ALG may interfere with the operation of such devices. If you are having trouble making VoIP calls, try turning this ALG off.

Click **Save** when you are done.

D-Link
DIR-895L HW:V1 FW:1.12

Home | Settings | **Features** | Management

Firewall Settings

Your router's high-performance firewall feature continuously monitors Internet traffic, protecting your network and connected devices from malicious Internet attacks.

Features >> Firewall Settings >> Advanced

IPv4 Rules | IPv6 Rules | **Save**

Enable DMZ: **Enabled**

DMZ IP Address: << Computer Name

Enable SPI IPv4: **Disabled**

Enable Anti-spoof Checking: **Disabled**

IPv6 Simple Security: **Disabled**

IPv6 Ingress Filtering: **Disabled**

[Advanced Settings ...](#)

Application Level Gateway (ALG) Configuration

PPTP: **Enabled**

IPSec (VPN): **Enabled**

RTSP: **Enabled**

SIP: **Enabled**

COPYRIGHT © 2016 D-Link

IPv4/IPv6 Rules

The IPv4/IPv6 Rules page contains advanced options that let you set rules to restrict IP traffic across your network or from your network to the Internet. To configure IPv4 rules, click **IPv4 Rules** from the Firewall Settings page. To configure IPv6 rules, click **IPv6 Rules** from the Firewall Settings page. To return to the main Firewall Settings page, click **Advanced**.

Use the drop-down menu to select whether you want to **ALLOW** or **DENY** the rules you create. You can also choose to turn filtering **OFF**.

If you wish to remove a rule, click on the corresponding trash can icon in the Delete column. If you wish to edit a rule, click on the corresponding pencil icon in the Edit column. If you wish to create a new rule, click the **Add Rules** button. Click **Save** when you are done. If you edit or create a rule, the following options will appear:

Create New Rule

Name: Enter a name for the rule.

Source IP Address Range: Enter the source IP address range that the rule will apply to, and using the drop-down menu, specify whether it is a **WAN** or **LAN** IP address.

Destination IP Address Range: Enter the destination IP address range that the rule will apply to, and using the drop-down menu, specify whether it is a **WAN** or **LAN** IP address.

Port Range: Select the protocol of the traffic to allow or deny (**Any**, **TCP**, or **UDP**) and then enter the range of ports that the rule will apply to.

Schedule: Use the drop-down menu to select a schedule to apply. The schedule may be set to **Always Enable**, or you can create your own schedules in the **Schedules** section. Refer to **Schedule** on page **94** for more information.

Click **Save** when you are done.

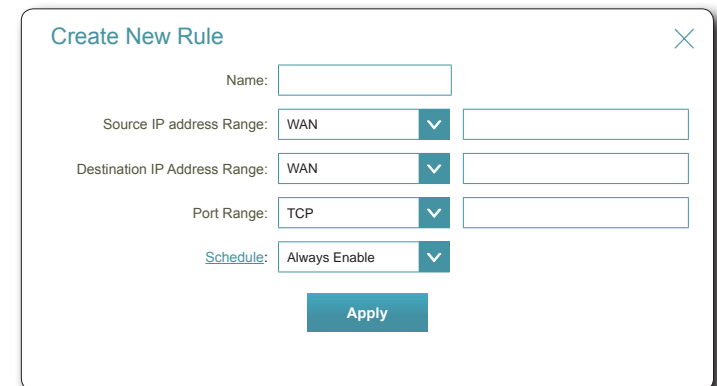
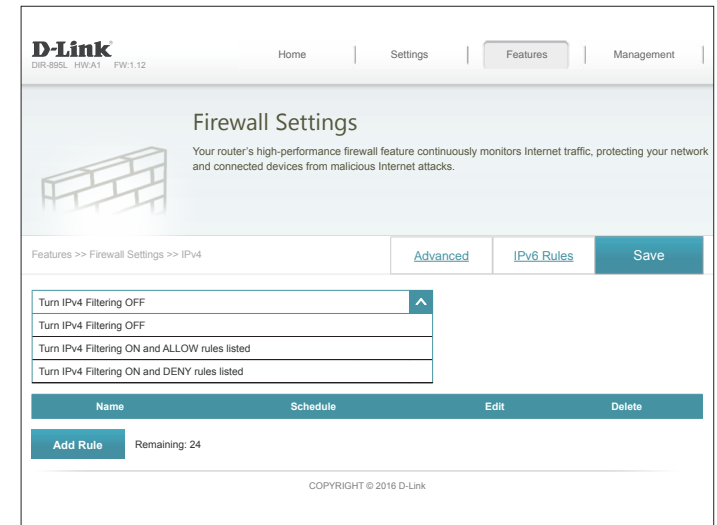

Port Forwarding

Port forwarding allows you to specify a port or range of ports to open for specific devices on the network. This might be necessary for certain applications to connect through the router. In the Features menu on the bar on the top of the page, click **Port Forwarding**.

If you wish to remove a rule, click on its trash can icon in the Delete column. If you wish to edit a rule, click on its pencil icon in the Edit column. If you wish to create a new rule, click the **Add Rules** button. Click **Save** when you are done. If you edit or create a rule, the following options will appear:

Create New Rule

Name: Enter a name for the rule.

Local IP: Enter the IP address of the device on your local network which you wish to forward traffic to. Alternatively, select the device from the drop-down menu.

TCP Port: Enter the TCP ports to forward. You can enter a single port or a range of ports. Separate ports with a comma (for example: 24,1009,3000-4000).

UDP Port: Enter the UDP ports to forward. You can enter a single port or a range of ports. Separate ports with a comma (for example: 24,1009,3000-4000).

Schedule: Use the drop-down menu to select a schedule to apply. The schedule may be set to **Always Enable**, or you can create your own schedules in the **Schedules** section. Refer to **Schedule** on page **94** for more information.

Click **Save** when you are done.

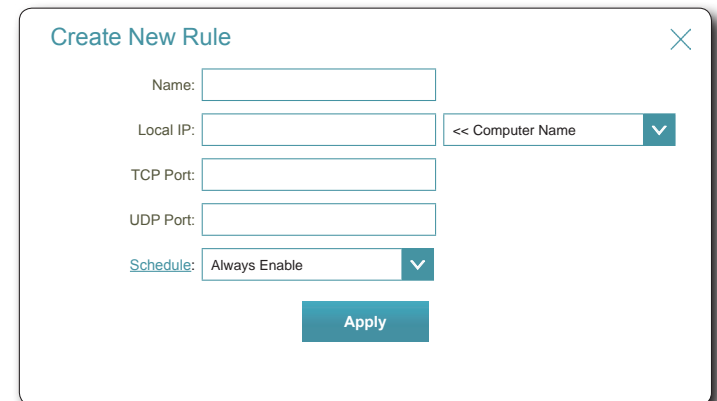
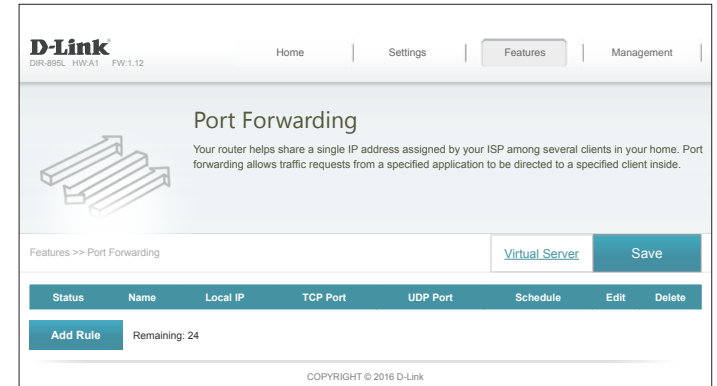

Virtual Server

In some cases you may have two applications running on different devices which require the same public port. Virtual server allows you to remap a different external port to each device. To configure the virtual server, from the Port Forwarding page click **Virtual Server**. To return to the main Port Forwarding page, click **Port Forwarding**.

If you wish to remove a rule, click on its trash can icon in the Delete column. If you wish to edit a rule, click on its pencil icon in the Edit column. If you wish to create a new rule, click the **Add Rules** button. Click **Save** when you are done. If you edit or create a rule, the following options will appear:

Create New User

Name: Enter a name for the rule. Alternatively, select the protocol/Application from the drop-down menu.

Local IP: Enter the IP address of the computer on your local network that you want to allow the incoming service to. Alternatively, select the device from the drop-down menu.

Protocol: Select the protocol of the traffic to allow or deny (**TCP**, **UDP**, **Both**, or **Other**).

Protocol Number: If you entered **Other** above, enter the protocol number.

External Port: Enter the public port you want to open.

Internal Port: Enter the private port you want to open.

Schedule: Use the drop-down menu to select a schedule to apply. The schedule may be set to **Always Enable**, or you can create your own schedules in the **Schedules** section. Refer to **Schedule** on page **94** for more information.

Click **Save** when you are done.

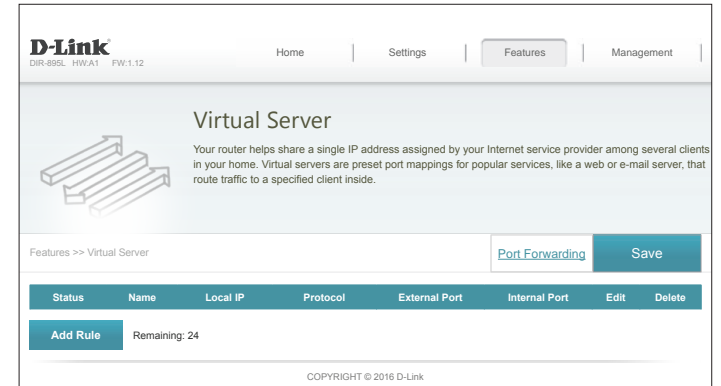

Create New Rule
✕

Name: << Application Name ▼

Local IP: << Computer Name ▼

Protocol: TCP ▼

External Port:

Internal Port:

Schedule: Always Enable ▼

Apply

Website Filter

The website filter settings allow you to block access to certain web sites. You can either create a list of sites to block, or create a list of sites to allow (with all other sites being blocked).

In the Features menu on the bar on the top of the page, click **Website Filter**.

If you want to create a list of sites to block, select **DENY computers access to ONLY these sites** from the drop-down menu. All other sites will be accessible. If you want to specify a list of sites to allow, select **ALLOW computers access to ONLY these sites** from the drop-down menu. All other sites will be blocked.

You may specify a maximum of fifteen web sites. To add a new site to the list, click **Create New Rule**. Next, under Website URL/Domain enter the URL or domain. If you wish to remove a rule, click on its trash can icon in the Delete column. If you wish to edit a rule, simply replace the URL or domain.

Click **Save** when you are done.

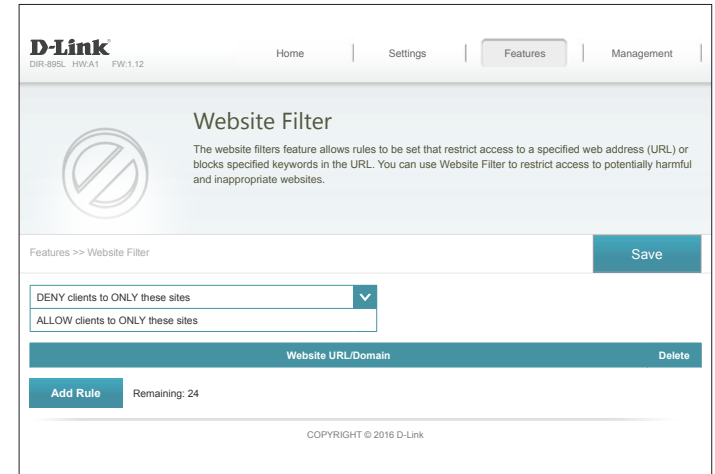

Static Routes

IPv4

The Static Routes section allows you to define custom routes to control how data traffic is moved around your network.

In the Features menu on the bar on the top of the page, click **Static Routes**. To configure IPv6 rules, click **IPv6** and refer to **IPv6** on page **89**. To return to the main IPv4 static routes page, click **IPv4**.

If you wish to remove a rule, click on its trash can icon in the Delete column. If you wish to edit a rule, click on its pencil icon in the Edit column. If you wish to create a new rule, click the **Add Rules** button. Click **Save** when you are done. If you edit or create a rule, the following options will appear:

Create New Rule

Name: Enter a name for the rule.

Destination Network: Enter the IP address of packets that will take this route.

Mask: Enter the netmask of the route.

Gateway: Enter your next hop gateway to be taken if this route is used.

Metric: The route metric is a value from 1 to 16 that indicates the cost of using this route. A value 1 is the lowest cost and 15 is the highest cost.

Interface: Select the interface that the IP packet must use to transit out of the router when this route is used.

Click **Save** when you are done.

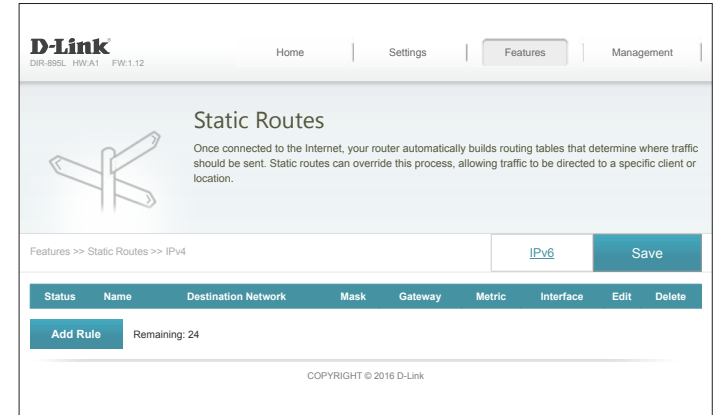

Create New Route ✕

Name:

Destination Network:

Mask:

Gateway:

Metric:

Interface: ▼

IPv6

To configure IPv6 rules, on the Static Routes page click **IPv6**. To return to the main IPv4 static routes page, click **IPv4**.

If you wish to remove a rule, click on its trash can icon in the Delete column. If you wish to edit a rule, click on its pencil icon in the Edit column. If you wish to create a new rule, click the **Add Rules** button. Click **Save** when you are done. If you edit or create a rule, the following options will appear:

Create New Rule

Name: Enter a name for the rule.

DestNetwork: This is the IP address of the router used to reach the specified destination.

PrefixLen: Enter the IPv6 address prefix length of the packets that will take this route.

Gateway: Enter your next hop gateway to be taken if this route is used.

Metric: Enter the metric value for this rule here.

Interface: Select the interface that the IP packet must use to transit out of the router when this route is used.

Click **Save** when you are done.

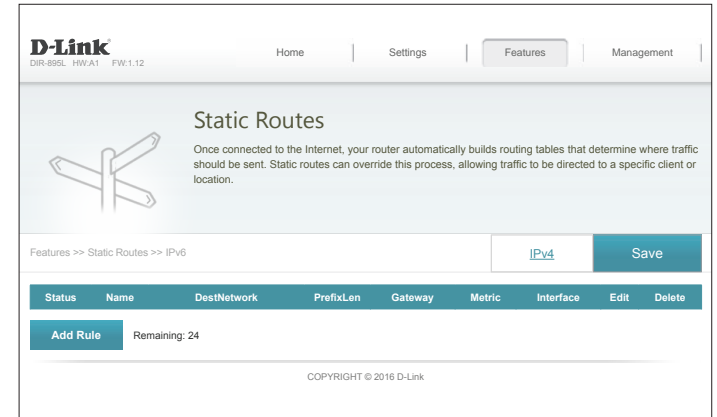

Create New Route ✕

Name:

DestNetwork:

PrefixLen:

Gateway:

Metric:

Interface: ▼

Dynamic DNS

Most Internet Service Providers (ISPs) assign dynamic (changing) IP addresses. Using a Dynamic Domain Name Server (DDNS) service provider, people can enter your domain name in their web browser to connect to your server no matter what your IP address is. Owners of D-Link routers can use the dlinkdns service. In the Features menu on the bar on the top of the page, click **Dynamic DNS**.

Enable Dynamic DNS: Enabling dynamic DNS reveals further configuration options.

If you **Enabled Dynamic DNS**, the following options are available:

Status: Displays the current DDNS connection status.

Server Address: Enter the address of your DDNS server, or select one from the drop-down menu.

Host Name: Enter the host name that you registered with your DDNS service provider.

User Name: Enter your DDNS username.

Password: Enter your DDNS password.

Time Out: Enter a timeout time (in hours).

Click **Save** when you are done.

At the bottom of the page are the IPv6 host settings. To configure an IPv6 dynamic DNS host, refer to **IPv6 Host** on page **91**.

The screenshot shows the D-Link Dynamic DNS configuration interface. At the top, there's a navigation bar with 'Home', 'Settings', 'Features', and 'Management'. The main heading is 'Dynamic DNS'. Below it, a description states: 'Dynamic Domain Name Service allows your router to associate an easy-to-remember domain name such as [YourDomainName].com with the regularly changing IP address assigned by your Internet Service provider. This feature is helpful when running a virtual server.' A 'Save' button is located in the top right corner of the configuration area.

The configuration options are as follows:

- Enable Dynamic DNS: **Enabled**
- Status: **Disconnected**
- Server Address: **dyndns.com** (selected from a dropdown menu)
- Host Name:
- User Name:
- Password:
- Time Out: **24** hours

At the bottom, there is a table with the following structure:

Status	Host Name	IPv6 Address	Edit	Delete
Add Record	Remaining: 10			

The footer of the page contains the text: 'COPYRIGHT © 2016 D-Link'.

IPv6 Host

The IPv6 host settings are found at the bottom of the Dynamic DNS page.

If you wish to remove a rule, click on its trash can icon in the Delete column. If you wish to edit a rule, click on its pencil icon in the Edit column. If you wish to create a new rule, click the **Add Record** button. Click **Save** when you are done. If you edit or create a rule, the following options will appear:

D-Link
DIR-895L HW:V1 FW:1.12

Home | Settings | Features | Management

Dynamic DNS

Dynamic Domain Name Service allows your router to associate an easy-to-remember domain name such as [YourDomainName].com with the regularly changing IP address assigned by your Internet Service provider. This feature is helpful when running a virtual server.

Features >> Dynamic DNS Save

Enable Dynamic DNS: Enabled

Status: Disconnected

Server Address:

Host Name:

User Name:

Password:

Time Out: hours

Status	Host Name	IPv6 Address	Edit	Delete
<input checked="" type="checkbox"/>	Test	2001::	<input type="button" value="pencil"/>	<input type="button" value="trash"/>

Remaining: 9

COPYRIGHT © 2016 D-Link

Create New Record

Host Name: Enter the host name that you registered with your dynamic DNS service provider.

IPv6 Address: Enter the IPv6 address of the dynamic DNS server. Alternatively, select the server device in the drop-down menu.

Click **Save** when you are done.

Create New Record

Host Name:

IPv6 Address:

Quick VPN

This page will help you configure the Quick VPN feature of your router. For more information refer to **Quick VPN** on page **170**. Before proceeding, ensure that your Internet connection is working properly. We recommend configuring Dynamic DNS before proceeding with Quick VPN setup. If your router is assigned an IP address from your ISP using DHCP, it may frequently change, requiring clients credentials to be set up again and a simple DDNS address will be easier than an IP address.

Configure the following options:

L2TP over IPsec: Enable or disable the Quick VPN server.

If you enable **Quick VPN**, the following options are available:

Username: Enter a username between 1 and 15 characters

Password: Enter a password between 1 and 15 characters.

PSK: Enter a passkey between 6 and 64 characters.

Save Configuration To Local Hard Drive: **For Apple iOS devices and OS X:** From a computer browser click this button to export a profile to simplify setup. E-mail this file as an attachment to your Apple mobile device or open the file in OS X.

Authentication Protocol: Choose the authentication protocol type: **MSCHAPv2**, **PAP**, or **CHAP**. **MSCHAPv2** is the default.

MPPE: Select the encryption cipher strength: **none**, **RC4-40**, or **RC4-128**. **RC4-128** is the default.

Click **Save** when you are done.

D-Link
DIR-895L HW:V1 FW:1.12

Home | Settings | **Features** | Management

Quick VPN

Quickly and easily create a profile for secure remote access to a Local Area Network (LAN). This profile can be used to configure other devices to connect to your LAN via a secure VPN tunnel.

Features >> Quick VPN Save

General

L2TP over IPsec: Enabled

Username:

Password:

PSK:

Save Configuration To Local Hard Drive:

[Advanced Settings ...](#)

Advanced

Authentication Protocol:

MPPE:

COPYRIGHT © 2016 D-Link

Management Time & Schedule Time

The Time page allows you to configure, update, and maintain the correct time on the internal system clock. From here you can set the time zone, the Network Time Protocol (NTP) server, and enable or disable daylight saving time.

In the Management menu on the bar on the top of the page, click **Time & Schedule**.

Time Configuration

Time Zone: Select your time zone from the drop-down menu.

Time: Displays the current date and time of the router.

Daylight Saving: Enable or disable daylight saving time.

Automatic Time Configuration

Update Time Using an NTP Server: Enable or disable to allow an NTP server on the Internet to synchronize the time and date with your router. If you enable this option, select an NTP server from the drop-down menu. To configure the router's time and date manually, disable this option and use the drop-down menus that appear to input the time and date.

Click **Save** when you are done.

To configure and manage your schedules, click **Schedule** and refer to **Schedule** on page **94**.

D-Link
DIR-895L HW:V1 FW:1.12

Home | Settings | Features | Management

Time

Your router's internal clock is used for data logging and schedules for features. The date and time can be synchronized with a public time server on the Internet, or set manually.

Management >> System Time Schedule Save

Time Configuration

Time Zone: (GMT-05:00) Eastern Time (US & Canada) ▼

Time: 2016/08/07 07:34:06 PM

Enable Daylight Saving: Disabled

Automatic Time Configuration

Update Time Using an NTP Server: Enabled

NTP Server: D-Link NTP Server ▼

COPYRIGHT © 2016 D-Link

Automatic Time Configuration

Update Time Using an NTP Server: Disabled

Manual Time Configuration

Date: 2016 ▼ 08 ▼ 10 ▼ (Year/Month/Day)

Time: 10 ▼ 28 ▼ (Hour/Minute)

Schedule

Some router functions can be controlled by can be set according to a pre-configured schedule. To create, edit, or delete schedules, from the Time page click **Schedule**. To return to the Time page, click **Time**.

If you wish to create a new rule, click the **Add Rules** button. If you wish to edit a rule, click on the corresponding pencil icon in the Edit column. If you wish to remove a rule, click on the corresponding trash can icon in the Delete column. Click **Save** when you are done. If you edit or create a rule, the following screen will appear:

First, enter the name of your schedule in the **Name** field.

Each box represents one hour, with the time at the top of each column. To add a time period to the schedule, simply click on the start hour and drag to the end hour. You can add multiple days and periods of time to the schedule.

To remove a time period from the schedule, click on the x icon.

Click **Save** when you are done.

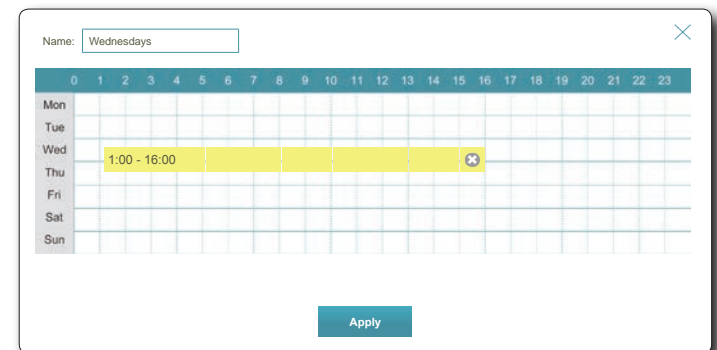
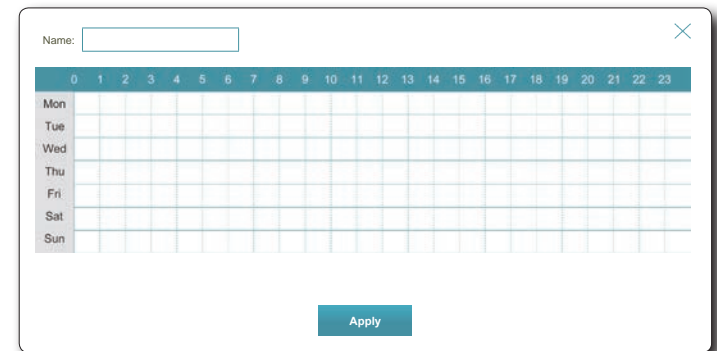
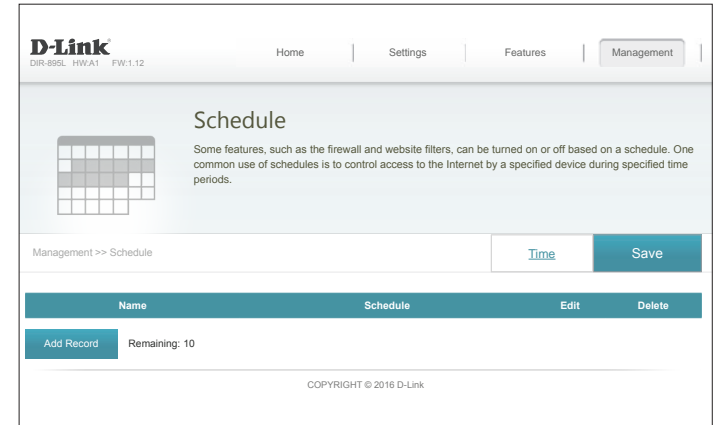

System Log

The router can keep a running log of events. This log can be sent to a Syslog server, or sent to your email address. In the Management menu on the bar on the top of the page, click **System Log**.

Log Settings

System Log: Click the **Check System Log** button to download a text file containing the system log.

SysLog Settings

Enable Logging to Syslog Server: Check this box to send the router logs to a SysLog Server.

If Logging to the Syslog Server is **Enabled**:

Syslog Server IP Address: Enter the IP address for the Syslog server. If the Syslog server is connected to the device, select it from the drop-down menu to automatically populate the field.

Email Settings

Enable Email Notification: If you want the logs to be automatically sent to an email address, enable this option.

If Email notification is **Enabled**:

From E-mail Address: Enter the email address your SysLog messages will be sent from.

To E-mail Address: Enter the email address your SysLog messages will be sent to.

SMTP Server Address: Enter your SMTP server address.

The screenshot shows the D-Link System Log configuration interface. At the top, there's a navigation bar with 'Home', 'Settings', 'Features', and 'Management'. The main heading is 'System Log' with a sub-heading 'On-board diagnostics run continually in the background to monitor the health of your router. The results are recorded in the system log if it is enabled. This info can be used to diagnose common problems or help Customer Support resolve issues more quickly.' Below this, there's a 'Save' button. The 'SysLog Settings' section includes a 'System Log' dropdown set to 'Check System Log'. The 'SysLog Settings' section has 'Enable Logging to Syslog Server' set to 'Enabled', a text field for 'SysLog Server IP Address', and a dropdown menu set to '<< Computer Name'. The 'E-mail Settings' section has 'Enable E-mail Notification' set to 'Enabled', text fields for 'From E-mail Address', 'To E-mail Address', 'SMTP Server Address', and 'SMTP Server Port' (set to 25), 'Enabled Authentication' set to 'Enabled', and text fields for 'Account Name' and 'Password'. The 'E-mail Log When Full or On Schedule' section has 'Send When Log Full' set to 'Enabled', 'Send on Schedule' set to 'Enabled', and a 'Schedule' dropdown set to 'Always Enable'. At the bottom, there's a copyright notice: 'COPYRIGHT © 2016 D-Link'.

System Log (continued)

SMTP Server Port: Enter your SMTP server port.

Enable Authentication: Check this box if your SMTP server requires authentication.

Account Name: Enter your SMTP account name.

Password: Enter your SMTP account's password.

E-mail Log When Full or On Schedule

Send On Full: If enabled, this option will set the router to send the log when it is full.

Send On Schedule: If is enabled, this option will set the router to send according to a set schedule.

Schedule: If you enable **Send On Schedule**, use the drop-down menu to select a schedule to apply. The schedule may be set to **Always Enable**, or you can create your own schedules in the **Schedules** section. Refer to **Schedule** on page **94** for more information.

Click **Save** when you are done.

D-Link
DIR-895L HWA1 FW:1.12

Home | Settings | Features | Management

System Log

On-board diagnostics run continually in the background to monitor the health of your router. The results are recorded in the system log if it is enabled. This info can be used to diagnose common problems or help Customer Support resolve issues more quickly.

Management >> System Log Save

SysLog Settings

System Log:

SysLog Settings

Enable Logging to Syslog Server: Enabled

SysLog Server IP Address: << Computer Name

E-mail Settings

Enable E-mail Notification: Enabled

From E-mail Address:

To E-mail Address:

SMTP Server Address:

SMTP Server Port:

Enabled Authentication: Enabled

Account Name:

Password:

E-mail Log When Full or On Schedule

Send When Log Full: Enabled

Send on Schedule: Enabled

Schedule:

COPYRIGHT © 2016 D-Link

Admin

This page will allow you to change the administrator (Admin) password and enable remote management. In the Management menu on the bar on the top of the page, click **Admin**. To load, save, reset settings, or reboot the router, click **System** and refer to **System** on page 98.

Admin Password

Password: Enter a new password for the administrator account. You will need to enter this password whenever you configure the router using a web browser.

Enable Graphical Authentication (CAPTCHA): Enables a challenge-response test to require users to type letters or numbers from a distorted image displayed on the screen to prevent hackers and unauthorized users from gaining access to your router's network settings.

Advanced Settings - Administration

Enable HTTPS Server: Check to enable HTTPS to connect to the router securely. Instead of using **http://dlinkrouter.local./**, you must use **https://dlinkrouter.local./** to connect to your router.

Enable Remote Management: Remote management allows the DIR-895L to be configured from the Internet by a web browser. A password is still required to access the web management interface.

Remote Admin Port: Enter the port number you wish to use to access the DIR-895L's web configuration utility. Example: **http://x.x.x.x:8080** where x.x.x.x is the Internet IP address of the DIR-895L and 8080 is the port used for the web management interface.

Note: If you enabled **HTTPS Server** and wish to access the router remotely and securely, you must enter **https://** at the beginning of the address.

Click **Save** when you are done.

The screenshot shows the D-Link Admin configuration page. At the top, there is a navigation bar with 'Home', 'Settings', 'Features', and 'Management' (selected). Below the navigation bar, the page title is 'Admin'. A key icon is shown next to the title. The text below the title reads: 'The admin account can change all router settings. To keep your router secure, you should give the admin account a strong password.'

Below the title, there is a breadcrumb trail 'Management >> Admin' and two buttons: 'System' and 'Save'. The main content area is divided into two sections:

- Admin Password:** This section contains a 'Password' field with a masked input (*****), an 'Enable Graphical Authentication (CAPTCHA)' checkbox which is currently 'Disabled', and a link for 'Advanced Settings ...'.
- Administration:** This section contains three settings:
 - 'Enable HTTPS Server:' with a toggle set to 'Enabled'.
 - 'Enable Remote Management:' with a toggle set to 'Enabled'.
 - 'Remote Admin Port:' with a text input field containing '8081' and a 'Use HTTPS:' toggle set to 'Enabled'.

At the bottom of the page, there is a copyright notice: 'COPYRIGHT © 2016 D-Link'.

System

This page allows you to save the DIR-895L's current configuration, load a previously saved configuration, reset the router to its factory default settings, or reboot the DIR-895L.

From the Admin page, click **System**. To return to the Admin page, click **Admin**.

System

Save Settings To Local Hard Drive: This option allows you to save the current router configuration settings to a file on your computer.

Load Settings From Local Hard Drive: This option allows you to load a previously saved router configuration file. This will overwrite the router's current configuration.

Restore To Factory Default Settings: This option allows you to restore all configuration settings back to the settings that were in effect at the time the router was shipped from the factory. Any settings that have not been saved will be lost, including any rules that you have created. If you want to save the current router configuration settings, use the **Save Settings To Local Hard Drive** button above.

Auto Reboot Configuration

Reboot The Device: Click to reboot the router immediately.

Auto Reboot: You may set the DIR-895L to automatically reboot at a set time. The options are **Never**, **Daily**, **Weekly**. You may set the hour using a 24 hour format, the minute, and the day you wish to have the DIR-895L automatically reboot.

Click **Save** when you are done.

Upgrade

This page allows you to upgrade the DIR-895L's firmware or language pack, either automatically or manually. To manually upgrade the firmware or language pack, you must first download the relevant file from <http://support.dlink.com>.

In the Management menu on the bar on the top of the page, click **Upgrade**.

Firmware

Firmware Information: The current firmware's version and date is displayed.

Check for New Firmware: Click this button to prompt the router to automatically check for a new firmware version. If a newer version is found, you will be prompted to install it.

Upgrade Manually

Upgrade Firmware: If you wish to upgrade the firmware manually, first download the firmware file you wish to upgrade to. Next, click the **Upgrade Firmware** button and browse to the file to install the new firmware. You can also browse to a language pack file to install a new language pack.

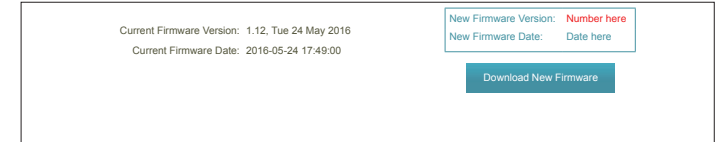
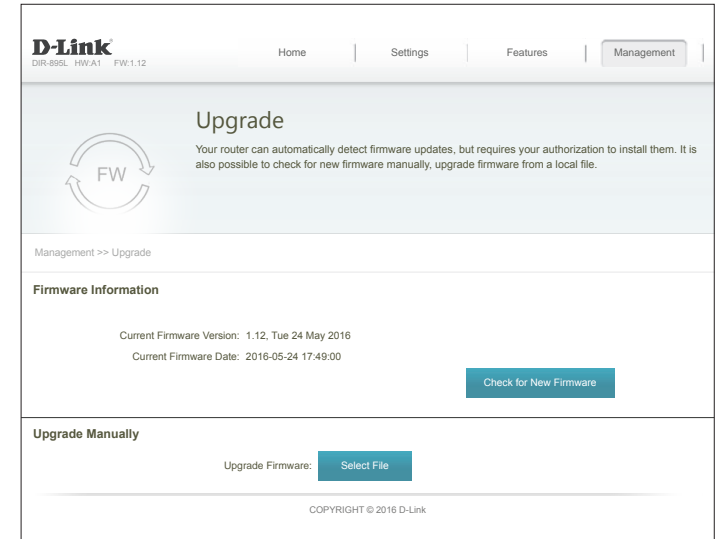

Statistics

On the Statistics page you can view the amount of traffic that has passed through the router on the WAN, LAN, and wireless segments.

In the Management menu on the bar on the top of the page, click **Statistics**.

You can view the **Internet**, **LAN**, **Wi-Fi 2.4 GHz**, or **Wi-Fi 5 GHz** statistics by clicking on the respective tabs at the top. The graph will update in real time. To clear the information on the graph, click **Clear**.

The traffic counter will reset if the device is rebooted.

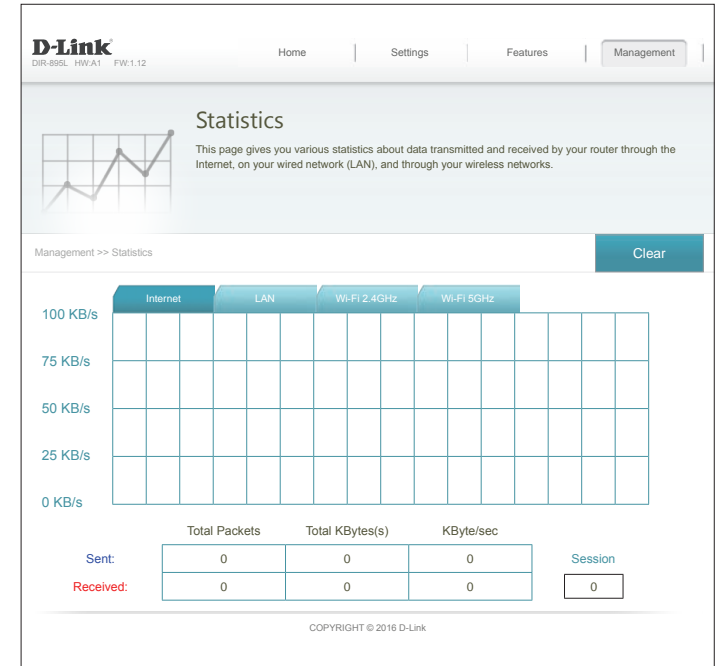

Configuration - Extender Mode Settings

To access the configuration utility, open a web browser such as Internet Explorer and enter **http://dlinkrouter.local./** or you may also connect by typing the IP address* of the DIR-895L in the address bar.

* By default the DIR-895L in access point mode will use DHCP to obtain an IP address from your uplink network. If you are using multiple DIR-895Ls or D-Link devices, go to **http://dlinkrouterxxxx.local./** as shown on the included Wi-Fi Configuration Card, with "xxxx" being the last four digits of the DIR-895L's MAC address. The MAC address is also printed on the label on the bottom of the device. The web configuration utility may also be accessed at the IP address **192.168.0.50** when in Extender Mode.

Enter your password. If you previously followed the setup wizard, please use the admin password you entered during the wizard. Otherwise, leave the password blank. Click **Log In** to proceed.

Note: If you cannot remember your password and cannot log in, press the reset button on the back of the device for longer than 10 seconds to restore the router to its default settings.

If you are having trouble logging in or experiencing trouble with the configuration utility, try clearing your browser cache or try using your web browser's 'private browser' or incognito mode.

The device's Home Page will open, giving you quick access to the DIR-895L's current status. The bar at the top of the page has quick access to the Home, Settings, and Management functions.

Note: The system will automatically log out after a period of inactivity.

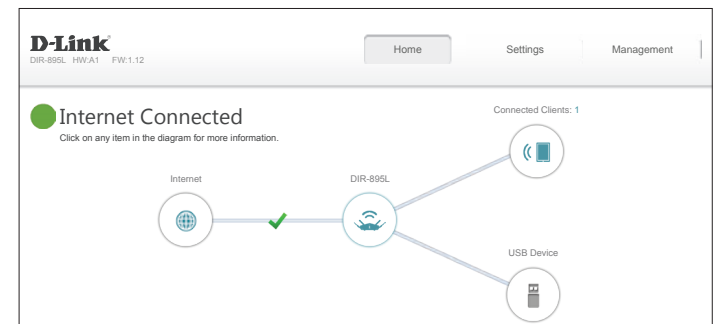
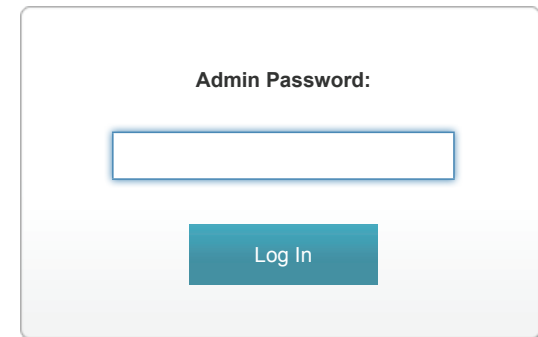

Home

The Home page displays the current status of the DIR-895L in the form of an interactive diagram. You can click each icon to display information about each part of the network at the bottom of the screen. The menu bar at the top of the page will allow you to quickly navigate to other pages.

The Home page displays the status of the access point's Internet connection.

The Home page displays the status of the connection to the uplink network. If it is disconnected, click **Click to repair** to bring up the setup wizard. The Setup Wizard only configures the device to operate as an access point.

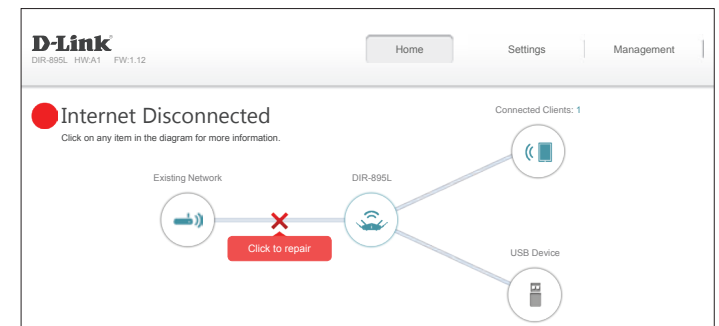
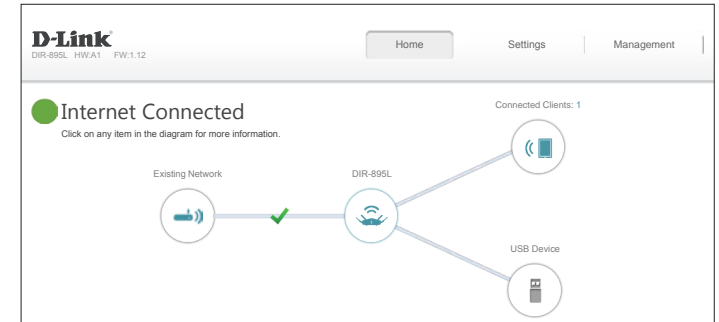

The screenshot shows the 'Welcome' screen of the Setup Wizard. It features a teal header with the word 'Welcome' and a close button. Below the header, there are four icons representing the network components: Internet (globe), Existing Router (tower), DIR-895L (extender), and Wi-Fi Client (smartphone). Below these icons, the text reads: 'This wizard will guide you through configuring your new DIR-895L.' The steps listed are: 'Step 1: Connecting your device', 'Step 2: Configuring your settings', and 'Step 3: Setting a password for your device'. At the bottom, there is a language dropdown menu set to 'English' and a 'Next' button.

DIR-895L

To see additional connection details, click on the **DIR-895L** icon. Your **Network** and **Wireless Network** settings are displayed at the bottom of the page.

Your DIR-895L's MAC address, IPv4 address, and subnet mask are displayed. To reconfigure the network settings, click **Go to settings** and refer to **Network** on page **110**.

The image to the right shows an example wireless network configuration with Smart Connect enabled. The wireless network status, names (SSIDs), and passwords are shown. To reconfigure the wireless settings click **Go to settings** and refer to **Wireless** on page **107**.

The screenshot displays the D-Link DIR-895L web interface. At the top, there is a navigation bar with 'Home', 'Settings', and 'Management' tabs. Below the navigation bar, a green circle indicates 'Internet Connected'. A network diagram shows the DIR-895L router connected to an 'Existing Network' and a 'USB Device'. The 'Connected Clients' section shows 1 client. Below the diagram, the 'DIR-895L' settings are displayed:

IPv4 Network		Wi-Fi	
MAC Address:	FF:FF:FF:FF:FF:FF	Status:	Enabled
Router IP Address:	192.168.0.1	Wi-Fi Name (SSID):	dlink-DIR-895L
Subnet Mask:	255.255.255.0	Password:	A_Str0nG_P@ssW0rd!%#
IPv6 Network			
Link-Local Address:	FE80::FF00:FF00:FF00:FF00		
Router IPv6 Address:	2001:B021:23:10::1:64		
DHCP-PD:	Disabled		

At the bottom of the settings section, there are two 'Go to settings' buttons with arrows. The footer of the page reads 'COPYRIGHT © 2016 D-Link'.

Connected Clients

Click on the **Connected Clients** icon to view details about the DIR-895L and its wireless settings.

On this page you can see all the clients currently connected to the DIR-895L, and their IP addresses.

To edit each client's settings, click the pencil icon on the client you want to edit.

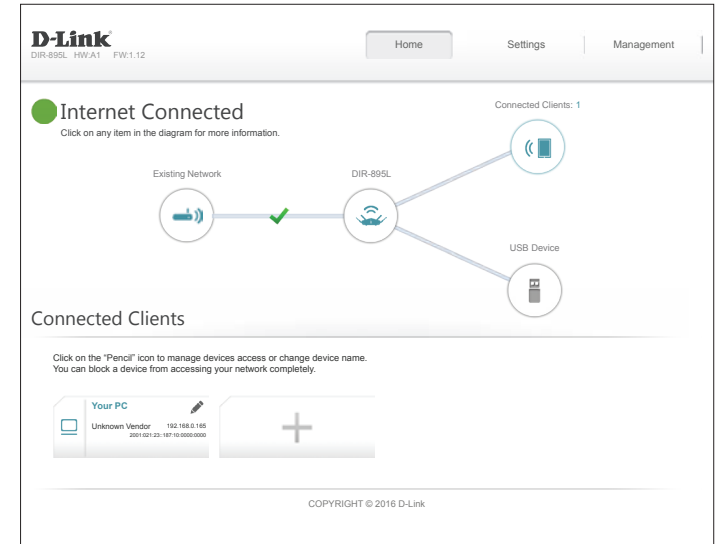

Name: Enter a custom name for this client.

Vendor: Displays the vendor of the device.

MAC Address: Displays the MAC address of the device.

IP Address: Displays the current IP address of this client.

Reserve IP: Enable to reserve this IP address for this client.

IP Address (Reserved): Specify an IP address for the DIR-895L's DHCP server to assign each time the device is detected.

Parental Control: Allow or block access to the router.

Click **Save** when you are done.

Edit Rule ✕

Name:

Vendor: Unknown Vendor

MAC Address: ff:ff:ff:ff:ff:ff

IP Address: 192.168.0.165

Reserve IP: Enabled

IP Address (Reserved):

Parental Control: Enabled

Schedule: ▼

USB Device

Click on the USB Device icon to view details about the currently connected USB device, DLNA media server, SharePort, and Windows File Sharing.

If you have a USB device connected, you can see its name and how much free space it has.

To reconfigure the SharePort settings, either click **Go to settings**, on the lower right, or click **Settings** (at the top of the page) and then **SharePort** on the menu that appears. Refer to **SharePort** on page 111 for more information.

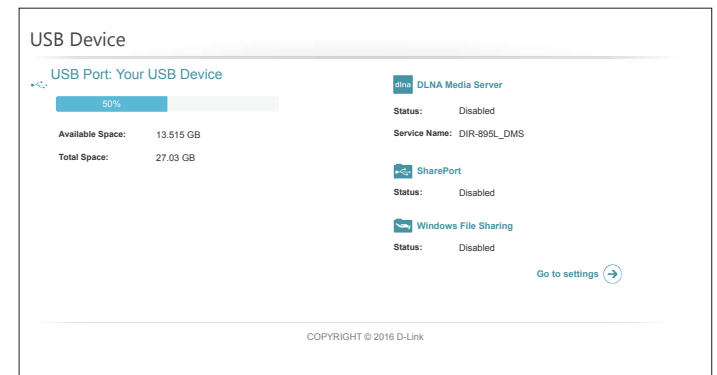
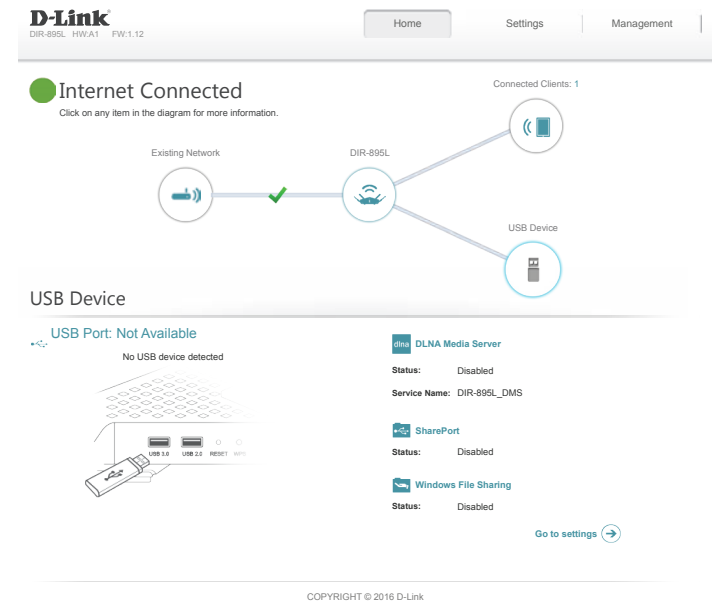

Settings Extender

In the Settings menu on the bar on the top of the page, click **Extender** to see the extender mode configuration options. You may configure the Extender to operate as either an **Access Point** or **Media Bridge** from this page.

Existing Network

Existing Network: Select either **Ethernet** (Access Point) or **Media Bridge**.

If you select **Ethernet** (Access Point Mode) refer to **Wireless** on page 107.

If you select **Media Bridge** configure the following options:

Wi-Fi Name (SSID): You may manually enter the SSID of the wireless network you would like to connect to or click the **Scan** button to search for available nearby networks.

Security: Select the type of security the uplink network uses. Only **None** and **WPA/WPA2-Personal** are supported.

If **Security** is set to **WPA/WPA2-Personal**, enter the uplink network password:

Password: Enter the password for the uplink network.

Click **Save** when you are done. Please note that the DIR-895L's IP address may change, requiring you to log in again.

The screenshot shows the D-Link Extender configuration page. At the top, there is a navigation bar with 'Home', 'Settings', and 'Management'. The main heading is 'Extender' with a sub-heading: 'Use this section to configure the wireless settings for your D-Link Router. Please ensure you press Save after any changes made in this section it to take effect.' Below this, there is a 'Settings >> Extender' breadcrumb and a 'Save' button. The 'Existing Network' dropdown menu is open, showing 'Ethernet' (selected), 'Ethernet', and 'Media Bridge' options.

This screenshot shows the 'Existing Network' section of the configuration page. The 'Existing Network' dropdown is set to 'Ethernet'. Below it are fields for 'Wi-Fi Name (SSID)' and 'Security'. The 'Smart Connect' section is visible, with a toggle for 'Smart Connect' set to 'Enabled'. Below this are fields for 'Wi-Fi Name (SSID)' (containing 'Your_Wi-Fi_Network') and 'Password' (containing 'A_Str0nG_P@ssW0rd!%#'). An 'Advanced Settings...' link is at the bottom right.

This screenshot shows the 'Existing Network' section with the 'Existing Network' dropdown set to 'Media Bridge'. The 'Wi-Fi Name (SSID)' field contains 'Your_Wi-Fi_Network' and the 'Security' field contains 'A_Str0nG_P@ssW0rd!%#'. A blue 'Scan' button is visible to the right of the SSID field.

Wireless

Smart Connect

Smart Connect: When Smart Connect is enabled, the router automatically assigns devices to the ideal wireless network to improve performance.

Wi-Fi Name (SSID): Create a name for your wireless network using up to 32 characters.

Password: Create a password to use for wireless security. Wireless clients will need to enter this password to successfully connect to the network.

Advanced Settings

Security Mode: Choose **None**, **WEP**, or **WPA/WPA2-Personal** (recommended).

Transmission Power: Select the desired wireless transmission power.

Schedule: Use the drop-down menu to select a schedule to apply. The schedule may be set to **Always Enable**, or you can create your own schedules in the **Schedules** section. Refer to **Schedule** on page **94** for more information.

Wi-Fi Protected Setup

The easiest way to connect your wireless devices to the router is with Wi-Fi Protected Setup (WPS). Using WPS-PIN is disabled by default due to security vulnerabilities.

WPS-PBC Status: Enable or disable WPS-PBC functionality.

WPS-PIN Status: Enable or disable WPS-PIN functionality.

Refer to the next page if you wish to disable Smart Connect or click **Save** when you are done.

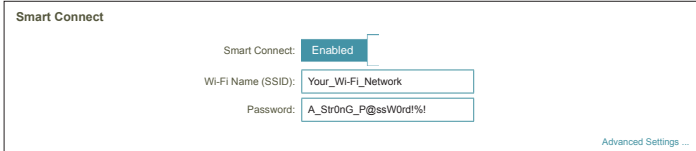

Smart Connect

Smart Connect: Enabled

Wi-Fi Name (SSID):

Password:

[Advanced Settings ...](#)

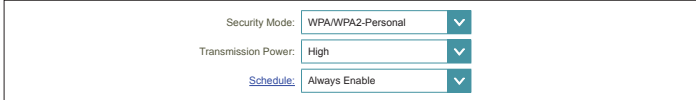

Security Mode: ▼

Transmission Power: ▼

Schedule: ▼

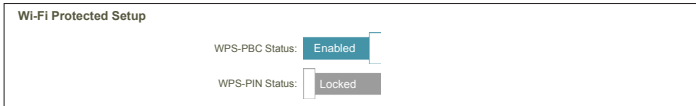

Wi-Fi Protected Setup

WPS-PBC Status: Enabled

WPS-PIN Status: Locked

Wireless - Smart Connect Disabled

If Smart Connect is **Disabled** the following options are available:

2.4GHz / Primary 5GHz / Secondary 5GHz

Status: Enable or disable the 2.4 GHz and 5 GHz wireless networks.

Wi-Fi Name (SSID): Create a name for your wireless network using up to 32 characters.

Password: Create a password to use for wireless security.

Advanced Settings

Security Mode: Choose **None**, **WEP**, or **WPA/WPA2-Personal** (recommended).

802.11 Mode (2.4 GHz): Select the desired wireless networking standards to use. The available options for the 2.4 GHz wireless network are **Mixed 802.11b/g/n**, **Mixed 802.11g/n**, **802.11n only**.

802.11 Mode (5 GHz): Select the desired wireless networking standards to use. The available options for the 5 GHz wireless network are **Mixed 802.11a/n/ac**, **Mixed 802.11n/ac**, **802.11ac only**, **Mixed 802.11a/n**, **Mixed 802.11n only**, or **802.11a only**.

Wi-Fi Channel: Select the desired channel. The default is **Auto** (recommended).

Transmission Power: Select the desired wireless transmission power.

Channel Width (2.4 GHz): Select **Auto 20/40 MHz** if you are using both 802.11n and non-802.11n devices, or select **20 MHz** if you are not using any 802.11n devices.

Smart Connect

Smart Connect: Disabled

2.4GHz

Status: Enabled

Wi-Fi Name (SSID):

Password:

[Advanced Settings ...](#)

Security Mode:

802.11 Mode:

Wi-Fi Channel:

Transmission Power:

Channel Width:

HT20/40 Coexistence: Enabled

Visibility Status:

[Schedule:](#)

Primary 5GHz

Status: Enabled

Wi-Fi Name (SSID):

Password:

[Advanced Settings ...](#)

Security Mode:

802.11 Mode:

Wi-Fi Channel:

Transmission Power:

Channel Width:

Visibility Status:

[Schedule:](#)

Channel Width (5 GHz): Select **Auto 20/40/80 MHz** if you are using 802.11ac, 802.11n, and 802.11a devices, select **Auto 20/40 MHz** if you are using 802.11n and 802.11a devices, or select **20 MHz** if you are only using 802.11a devices.

HT20/40 Coexistence: (2.4 GHz): Enable or disable HT20/40 Coexistence.

Visibility Status: The default setting is **Visible**. Select **Invisible** if you do not want to broadcast the SSID of your wireless network. Making your network invisible is not a form of security alone.

Schedule: Use the drop-down menu to select a schedule to apply. The schedule may be set to **Always Enable**, or you can create your own schedules in the **Schedules** section. Refer to **Schedule** on page **94** for more information.

Wi-Fi Protected Setup

The easiest way to connect your wireless devices to the router is with Wi-Fi Protected Setup (WPS). Using WPS-PIN disabled by default due to security vulnerabilities.

WPS-PBC Status: Enable or disable WPS-PBC functionality.

WPS-PIN Status: Enable or disable WPS-PIN functionality.

Click **Save** when you are done.

The screenshot shows two sections of the router's configuration interface. The top section is titled "Secondary 5GHz" and contains the following settings:

- Status: Enabled
- Wi-Fi Name (SSID): Your_2nd_5G_Wi-Fi_Network
- Password: A_Str0nG_P@ssW0rd!%!
- Advanced Settings ...
- Security Mode: WPA/WPA2-Personal
- 802.11 Mode: Mixed 802.11a/n/ac
- Wi-Fi Channel: Auto
- Transmission Power: High
- Channel Width: Auto 20/40/80 MHz
- Visibility Status: Visible
- Schedule: Always Enable

The bottom section is titled "Wi-Fi Protected Setup" and contains the following settings:

- WPS-PBC Status: Enabled
- WPS-PIN Status: Locked

Network

This section allows you to change the local network settings of the extender, such as the configuration management link and device IP settings. In the Settings menu on the bar on the top of the page, click **Network**. Click **Advanced Settings...** to expand the list and see all of the options.

Network Settings

Management Link: The default address to access the router's configuration is **http://dlinkrouter.local/**. Here, you can replace **dlinkrouter** with a name of your choice.

Advanced Settings - IPv4 Device Management Interface

My LAN Connection is: Select your device IP assignment type, either **Dynamic IP (DHCP)** or **Static IP**. If you select DHCP there is no further configuration.

If you select **Static IP**, configure the following IP information.

IP Address: Enter an IP address on the same subnet as your uplink router.

Subnet Mask: Enter the subnet mask used by your uplink router.

Default Gateway: Enter the IP address of your uplink router.

Primary DNS Server: Enter the IP address of your preferred primary DNS server, usually the IP address of your uplink router.

Secondary DNS Server: Enter the IP address of your preferred secondary DNS server, usually the IP address of your uplink router.

Click **Save** when you are done.

The screenshot shows the D-Link web interface for network configuration. At the top, there's a navigation bar with 'Home', 'Settings', and 'Management'. The main heading is 'Network'. Below the heading, there's a brief instruction: 'Use this section to configure the network settings for your device. You can enter a name for your device in the management link field, and use the link to access web UI in a web browser. Recommend to change the management link if there are more than one D-Link devices within the network.' A 'Save' button is visible on the right. Below this is the 'Network Settings' section with a 'Management Link' field containing 'dlinkrouter.local'. At the bottom, the 'IPv4 Device Management Interface' section is shown, with a dropdown menu for 'My LAN Connection is:' set to 'Dynamic IP (DHCP)'. Below the dropdown are input fields for 'IP Address:', 'Subnet Mask:', 'Default Gateway:', 'Primary DNS Server:', and 'Secondary DNS Server:'.

SharePort

This page will allow you to set up access to files on an external USB device plugged into the router. You can do this through the local network or from the Internet using either a web browser or an app on your smartphone or tablet. In the Settings menu on the bar on the top of the page, click **SharePort**.

DLNA Media Server

Status: Enable or disable the DLNA media server function, allowing connected clients access to media files over the network.

DLNA Media Server: Choose a name for your DLNA media server so that it can be found.

Windows File Sharing (SAMBA)

Status: Enable or disable the Windows File Sharing function, allowing connected clients access to media files over the network.

Windows File Sharing: Choose either **Allow all users to access (no password)** or **Require router's admin password** to specify whether the router's password will be required for access.

Web File Access

Web File Access: Enable or disable remote access to files stored on a USB device plugged into the router through a web browser.

Direct Links: This area will display the HTTP and HTTPS links to connect to your SharePort drive through a web browser from a device on your network.

Click **Save** when you are done.

D-Link
DIR-895L HW:V1 FW:1.12

Home | Settings | Management

SharePort

SharePort allows you to share photos, music, movies and files simply by connecting a USB drive to your router. Access your files locally and remotely using the free mydlink SharePort app for your iOS or Android devices, or access them on a computer through the SharePort Web Access. The built-in Digital Living Network Alliance (DLNA) media server allows you to stream multimedia content to any DLNA compliant devices such as smart TVs and games consoles.

Settings >> Shareport Create User Save

DLNA Media Server

Status: Enabled

DLNA Media Server:

Windows File Sharing (SAMBA)

Status: Enabled

Windows File Sharing: ▼

Web File Access

Status: Enabled

Direct Links: <http://shareport.local/>
<https://shareport.local/>

COPYRIGHT © 2016 D-Link

Create User

The Create User page allows you to manage SharePort user accounts. This page lists active user accounts, their current permissions, and access paths. Users without accounts are restricted to guest access which only has access to the "Guest" folder on the media server. A maximum of ten accounts (including "Admin" can be registered at any given time.

If you wish to remove an account, click on the corresponding trash can icon in the Delete column. If you wish to edit an account, click on the corresponding pencil icon in the Edit column. If you wish to create a new account, click the **Create User** button. If you edit or create a user, the following options appear:

Create New User

- User Name:** Enter the desired user name for the new account.
- Password:** Enter the password which the user will need to enter when logging in.
- Permission:** Select either **Read Only** or **Read/Write** to control whether the user can edit, add, or delete files on the device.
- Folder:** Choose the parent folder for the user. Files and folders on a higher level will be unavailable. Giving a user "root" allows access to all files on the device. To change the selected folder, click **Browse** and browse to the desired folder.

Click **OK** when you are done. The new user should be added to the list of user accounts. To save the new list, click **Save**. To return to the SharePort page, click **SharePort**.

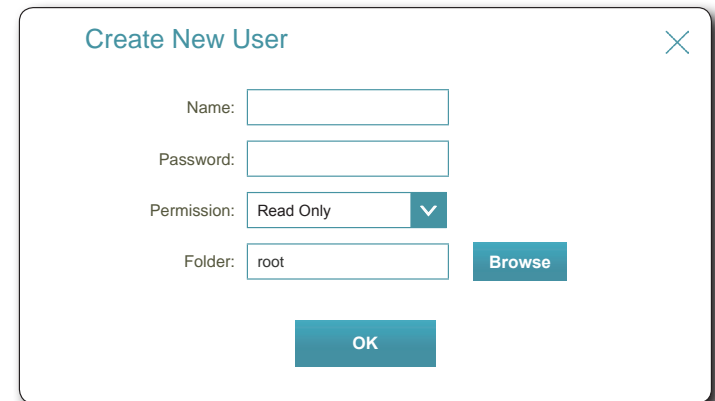
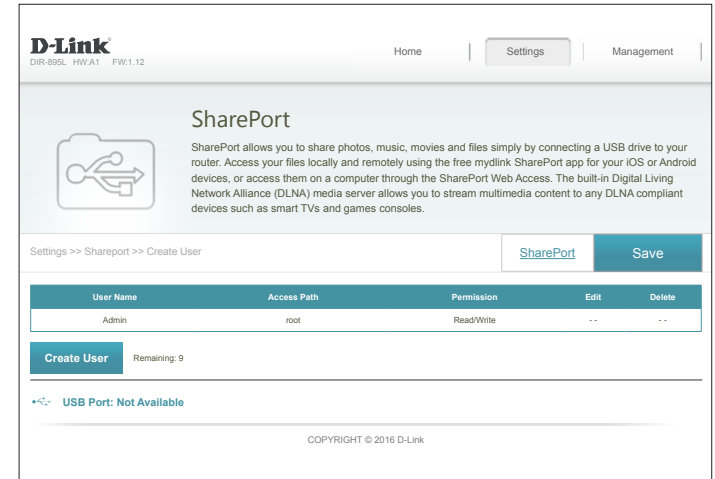

Management Time & Schedule Time

The Time page allows you to configure, update, and maintain the correct time on the internal system clock. From here you can set the time zone, the Network Time Protocol (NTP) server, and enable or disable daylight saving time.

In the Management menu on the bar on the top of the page, click **Time & Schedule**.

Time Configuration

Time Zone: Select your time zone from the drop-down menu.

Time: Displays the current date and time of the router.

Daylight Saving: Enable or disable daylight saving time.

Automatic Time Configuration

Update Time Using an NTP Server: Enable or disable to allow an NTP server on the Internet to synchronize the time and date with your router. If you enable this option, select an NTP server from the drop-down menu. To configure the router's time and date manually, disable this option and use the drop-down menus that appear to input the time and date.

Click **Save** when you are done.

To configure and manage your schedules, click **Schedule** and refer to **Schedule** on page 114.

D-Link
DIR-895L HW:V1 FW:1.12

Home | Settings | Management

Time

Your router's internal clock is used for data logging and schedules for features. The date and time can be synchronized with a public time server on the Internet, or set manually.

Management >> System Time Schedule Save

Time Configuration

Time Zone: (GMT-05:00) Eastern Time (US & Canada) ▼

Time: 2016/08/07 07:34:06 PM

Enable Daylight Saving: Disabled

Automatic Time Configuration

Update Time Using an NTP Server: Enabled

NTP Server: D-Link NTP Server | D-Link NTP Server ▼

COPYRIGHT © 2016 D-Link

Automatic Time Configuration

Update Time Using an NTP Server: Disabled

Manual Time Configuration

Date: 2016 ▼ | 08 ▼ | 10 ▼ (Year/Month/Day)

Time: 10 ▼ | 28 ▼ (Hour/Minute)

Schedule

Some access point functions can be controlled by a pre-configured schedule. To create, edit, or delete schedules, from the Time page click **Schedule**. To return to the Time page, click **Time**.

If you wish to create a new rule, click the **Add Rules** button. If you wish to edit a rule, click on the corresponding pencil icon in the Edit column. If you wish to remove a rule, click on the corresponding trash can icon in the Delete column. Click **Save** when you are done. If you edit or create a rule, the following screen will appear:

First, enter the name of your schedule in the **Name** field.

Each box represents one hour, with the time at the top of each column. To add a time period to the schedule, simply click on the start hour and drag to the end hour. You can add multiple days and periods of time to the schedule.

To remove a time period from the schedule, click on the x icon.

Click **Save** when you are done.

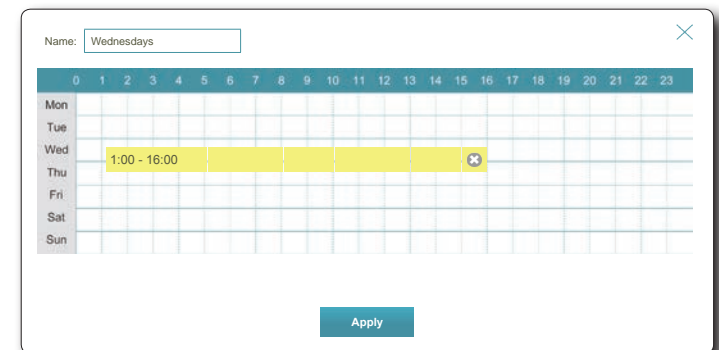
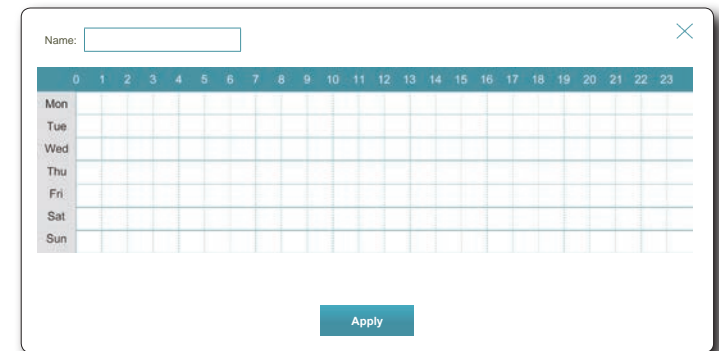
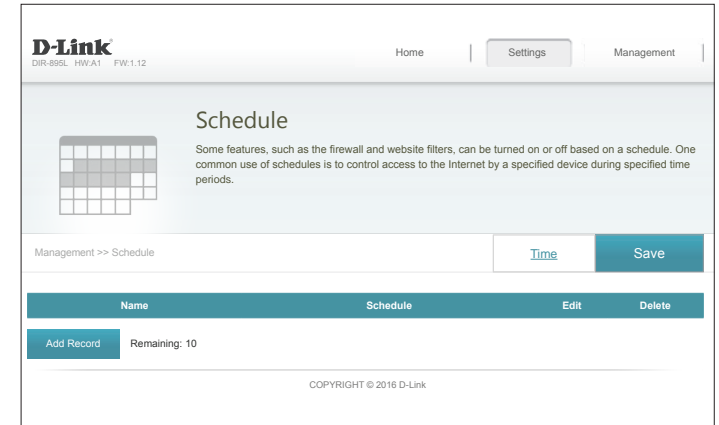

System Log

The router can keep a running log of events. This log can be sent to a Syslog server, or sent to your email address. In the Management menu on the bar on the top of the page, click **System Log**.

Log Settings

System Log: Click the **Check System Log** button to download a text file containing they system log.

SysLog Settings

Enable Logging to Syslog Server: Check this box to send the router logs to a SysLog Server.

If Logging to the Syslog Server is **Enabled**:

Syslog Server IP Address: Enter the IP address for the Syslog server. If the Syslog server is connected to the DIR-895L, select it from the drop-down menu to automatically populate the field.

Email Settings

Enable Email Notification: If you want the logs to be automatically sent to an email address, enable this option.

If Email notification is **Enabled**:

From E-mail Address: Enter the email address your SysLog messages will be sent from.

To E-mail Address: Enter the email address your SysLog messages will be sent to.

SMTP Server Address: Enter your SMTP server address.

The screenshot shows the D-Link System Log configuration interface. At the top, there's a navigation bar with 'Home', 'Settings', and 'Management'. The main heading is 'System Log' with a sub-heading 'On-board diagnostics run continually in the background to monitor the health of your router. The results are recorded in the system log if it is enabled. This info can be used to diagnose common problems or help Customer Support resolve issues more quickly.' Below this, there's a 'Save' button. The 'SysLog Settings' section has a 'System Log:' label and a 'Check System Log' button. The 'SysLog Settings' section includes 'Enable Logging to Syslog Server' (Enabled), 'SysLog Server IP Address' (empty), and a dropdown menu for 'Computer Name'. The 'E-mail Settings' section includes 'Enable E-mail Notification' (Enabled), 'From E-mail Address' (empty), 'To E-mail Address' (empty), 'SMTP Server Address' (empty), 'SMTP Server Port' (25), 'Enabled Authentication' (Enabled), 'Account Name' (empty), and 'Password' (empty). The 'E-mail Log When Full or On Schedule' section includes 'Send When Log Full' (Enabled), 'Send on Schedule' (Enabled), and 'Schedule' (Always Enable). At the bottom, there's a copyright notice: 'COPYRIGHT © 2016 D-Link'.

System Log (continued)

SMTP Server Port: Enter your SMTP server port.

Enable Authentication: Check this box if your SMTP server requires authentication.

Account Name: Enter your SMTP account name.

Password: Enter your SMTP account's password.

E-mail Log When Full or On Schedule

Send On Log Full: If enabled, this option will set the router to send the log when it is full.

Send On Schedule: If is enabled, this option will set the router to send according to a set schedule.

Schedule: If you enable **Send On Schedule**, use the drop-down menu to select a schedule to apply. The schedule may be set to **Always Enable**, or you can create your own schedules in the **Schedules** section. Refer to **Schedule** on page **94** for more information.

Click **Save** when you are done.

D-Link
DIR-895L HW:V1 FW:1.12

Home | Settings | Management

System Log

On-board diagnostics run continually in the background to monitor the health of your router. The results are recorded in the system log if it is enabled. This info can be used to diagnose common problems or help Customer Support resolve issues more quickly.

Management >> System Log Save

SysLog Settings

System Log: Check System Log

SysLog Settings

Enable Logging to Syslog Server: Enabled

SysLog Server IP Address: << Computer Name ▼

E-mail Settings

Enable E-mail Notification: Enabled

From E-mail Address:

To E-mail Address:

SMTP Server Address:

SMTP Server Port:

Enabled Authentication: Enabled

Account Name:

Password:

E-mail Log When Full or On Schedule

Send When Log Full: Enabled

Send on Schedule: Enabled

Schedule: Always Enable ▼

COPYRIGHT © 2016 D-Link

Admin

This page will allow you to change the administrator (Admin) password and enable remote management. In the Management menu on the bar on the top of the page, click **Admin**. To load, save, reset settings, or reboot the router, click **System** and refer to **System** on page **118**.

Admin Password

Password: Enter a new password for the administrator account. You will need to enter this password whenever you configure the router using a web browser.

Enable Graphical Authentication (CAPTCHA): Enables a challenge-response test to require users to type letters or numbers from a distorted image displayed on the screen to prevent hackers and unauthorized users from gaining access to your router's network settings.

Advanced Settings - Administration

Enable HTTPS Server: Check to enable HTTPS to connect to the router securely. Instead of using **http://dlinkrouter.local./**, you must use **https://dlinkrouter.local./** to connect to your router.

Enable Remote Management: Remote management allows the DIR-895L to be configured from the Internet by a web browser. A password is still required to access the web management interface.

Remote Admin Port: Enter the port number you wish to use to access the DIR-895L's web configuration utility. Example: **http://x.x.x.x:8080** where x.x.x.x is the Internet IP address of the DIR-895L and 8080 is the port used for the web management interface.

Note: If you enabled **HTTPS Server** and wish to access the router remotely and securely, you must enter **https://** at the beginning of the address.

Click **Save** when you are done.

The screenshot displays the D-Link Admin interface. At the top, there's a navigation bar with 'Home', 'Settings', and 'Management'. The main heading is 'Admin', with a sub-note: 'The admin account can change all router settings. To keep your router secure, you should give the admin account a strong password.' Below this, there's a breadcrumb 'Management >> Admin' and buttons for 'System' and 'Save'. The 'Admin Password' section contains a 'Password' field with masked characters, an 'Enable Graphical Authentication (CAPTCHA)' checkbox (currently disabled), and a link for 'Advanced Settings...'. The 'Administration' section features three settings: 'Enable HTTPS Server' (checked/Enabled), 'Enable Remote Management' (checked/Enabled), and 'Remote Admin Port' (8081). A 'Use HTTPS' checkbox is also checked/Enabled. The footer shows 'COPYRIGHT © 2016 D-Link'.

System

This page allows you to save the DIR-895L's current configuration, load a previously saved configuration, reset the router to its factory default settings, or reboot the DIR-895L.

From the Admin page, click **System**. To return to the Admin page, click **Admin**.

System

Save Settings To Local Hard Drive: This option allows you to save the current router configuration settings to a file on your computer.

Load Settings From Local Hard Drive: This option allows you to load a previously saved router configuration file. This will overwrite the router's current configuration.

Restore To Factory Default Settings: This option allows you to restore all configuration settings back to the settings that were in effect at the time the router was shipped from the factory. Any settings that have not been saved will be lost, including any rules that you have created. If you want to save the current router configuration settings, use the **Save Settings To Local Hard Drive** button above.

Auto Reboot Configuration

Reboot The Device: Click to reboot the router immediately.

Auto Reboot: You may set the DIR-895L to automatically reboot at a set time. The options are **Never**, **Daily**, **Weekly**. You may set the hour using a 24 hour format, the minute, and the day you wish to have the DIR-895L automatically reboot.

Click **Save** when you are done.

The screenshot shows the D-Link System configuration page. At the top, there is a navigation bar with 'Home', 'Settings', and 'Management'. The main heading is 'System'. Below the heading, there is a description: 'This page lets you save your router's current settings to a file, restore your settings from a file, restore your router to factory default settings, or reboot the device. Please note that restoring the settings to the factory defaults will erase all settings, including any rules you have created.' Below this, there are three buttons: 'Save', 'Select File', and 'Restore'. The 'Auto Reboot Configuration' section is partially visible, showing a 'Reboot' button and an 'Auto Reboot' dropdown menu set to 'Never'.

The screenshot shows the 'Auto Reboot Configuration' section. It includes a 'Reboot The Device:' button labeled 'Reboot'. Below it, the 'Auto Reboot:' dropdown menu is set to 'Daily'. The 'Time:' field is set to '00' (Hour/Minute).

The screenshot shows the 'Auto Reboot Configuration' section. It includes a 'Reboot The Device:' button labeled 'Reboot'. Below it, the 'Auto Reboot:' dropdown menu is set to 'Weekly'. The 'Date:' dropdown menu is set to 'Mon'. The 'Time:' field is set to '00' (Hour/Minute).

Upgrade

This page allows you to upgrade the DIR-895L's firmware or language pack, either automatically or manually. To manually upgrade the firmware or language pack, you must first download the relevant file from <http://support.dlink.com>.

In the Management menu on the bar on the top of the page, click **Upgrade**.

Firmware

Firmware Information: The current firmware's version and date is displayed.

Check for New Firmware: Click this button to prompt the router to automatically check for a new firmware version. If a newer version is found, you will be prompted to install it.

Upgrade Manually

Upgrade Firmware: If you wish to upgrade the firmware manually, first download the firmware file you wish to upgrade to. Next, click the **Upgrade Firmware** button and browse to the file to install the new firmware. You can also browse to a language pack file to install a new language pack.

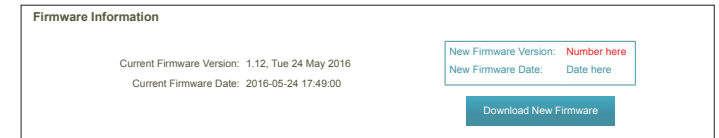
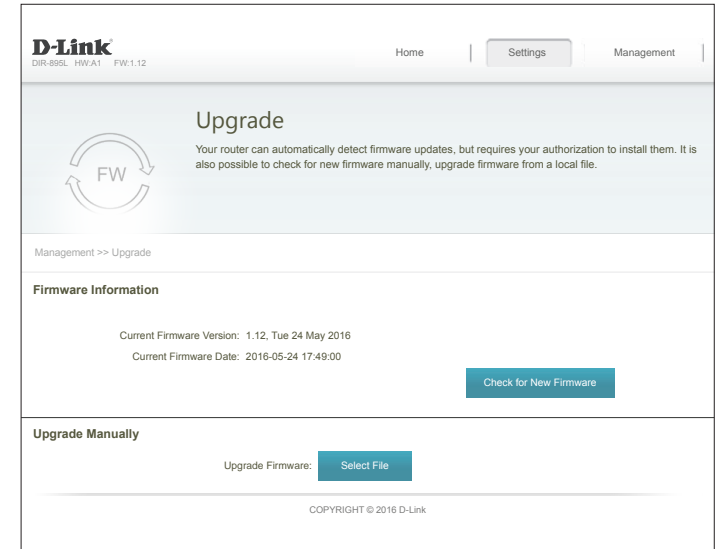

Applications

mydlink Lite Mobile App

The DIR-895L is mydlink-enabled, which gives you access to your home network no matter where you go. Now you can monitor and manage your home network right from your, iPhone®, iPad®, Android™ device, or Windows Phone. mydlink-enabled routers can be configured to send an email to keep you informed anywhere, anytime when new devices are connecting to your network or unwanted access is detected. Monitor in real-time websites that are being visited with recent browser history displayed on the mydlink™ Lite app – which is great for parents.

Download the free **mydlink Lite** app on your smartphone or tablet by scanning the QR code to the right, or by searching for **mydlink Lite** in the app store for your device.

Launch the mydlink Lite app, then create a new account or log in to your existing account.

The app will guide you through the rest of the configuration process.



mydlink SharePort

Using the mydlink SharePort™ app for iPad®, iPhone®, and iPod touch®

The mydlink SharePort™ app is a streamlined mobile application that allows you to conveniently stream media and share files stored on a removable storage connected to your router. Once the router is set up, you can start the app and easily connect from a local network or through the Internet to access your photos, videos, music, and documents. It allows you to create your own personal cloud storage. You can upload files and photos from your mobile device to the removable storage via the app from anywhere in the world!

Note: In order to ensure smooth streaming performance, you will need a minimum of 2 Mbit/s upload bandwidth for your router's Internet connection. Streaming performance will vary depending on the quality of your Internet connection.

Note: If you choose to skip the mydlink SharePort registration during the initial setup of your DIR-895L, you may begin the registration process anytime by accessing the mydlink SharePort feature from within the router configuration. Please see page 73 for details on how to begin the mydlink shareport registration process.

If you are connecting remotely through the mydlink SharePort™ app from the Internet, you will need a **mydlink** account.

Make sure the device is powered on. Then plug your USB drive into the USB port of the device.

Note: If you connect a removable storage with many files or a large capacity, it may take a while for the router to scan and catalog your files.

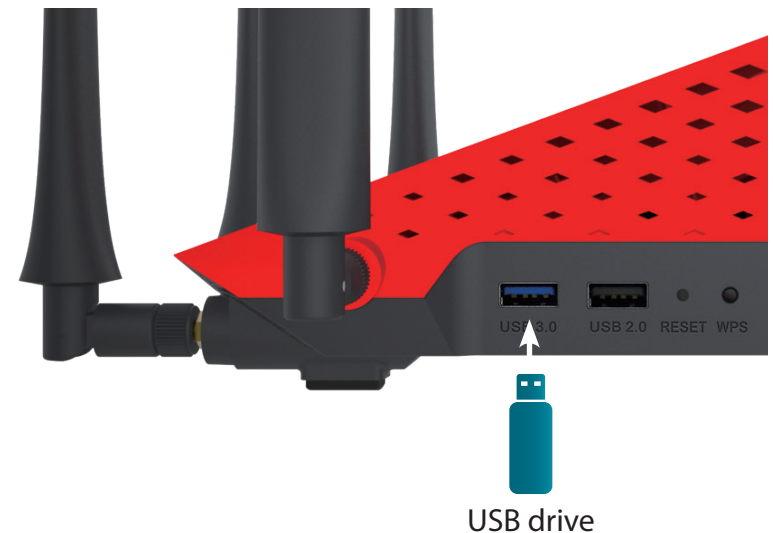

Use your iPhone, iPad or iPod touch to search for and download the free **mydlink SharePort** app from the App Store.



If you have a QR code reader, you can scan the code for **mydlink SharePort** to the right.



Tap the **mydlink SharePort** icon, and the app will load.



Tap **Set up** to go to Settings and enter the Admin password and your mydlink Account Login information when the pop-up displays. Tap **Done** when your information is entered. (The Admin password is only for local access, if you can connect through the Internet, then you can leave the Admin password blank)

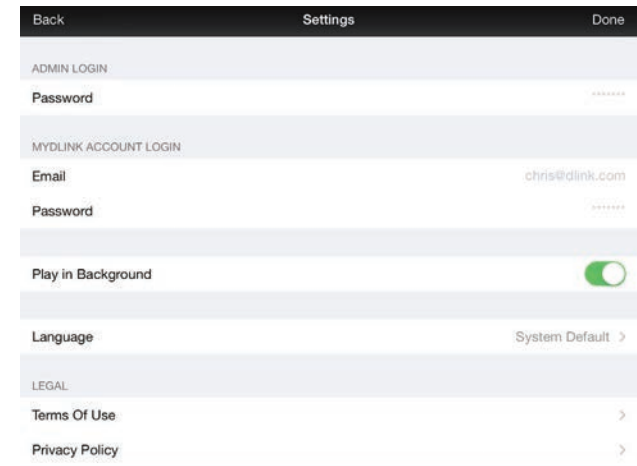

You can now use the mydlink SharePort app interface to stream media and access files stored on your removable drive. The wireless icon at the bottom will be lit green to indicate you are connected to the router through Remote Access. If you need to change your settings, tap the gear icon at the top right corner to enter the settings page.

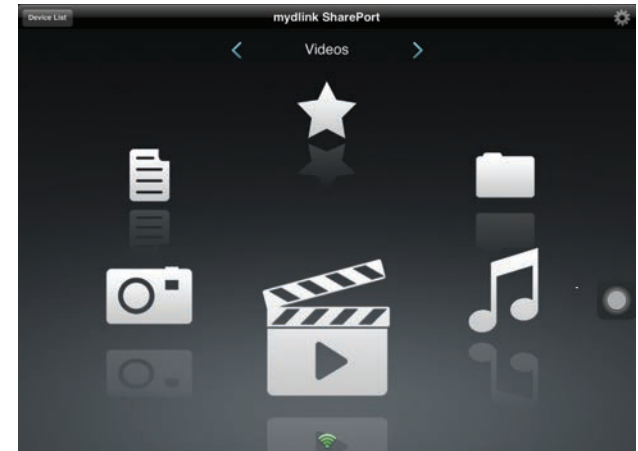

If you have more than one device registered to your mydlink account, you can tap **Device List** (in the top-left corner) and you will be prompted to select the device you wish to use.

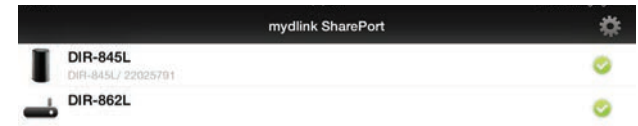

Note: If you see a red wireless icon, your router's network environment may not be suitable for a direct network connection and you may experience slow network speeds.

Using mydlink SharePort in a local network:

Make sure the device is powered on. Then plug your USB drive into the USB port of the device.

Note: If you connect a removable storage with many files or a large capacity, it may take a while for the router to scan and catalog your files.

Use your iPhone, iPad or iPod touch to search for and download the free **mydlink SharePort** app from the App Store.

If you have a QR code reader, you can scan the code for **mydlink SharePort** to the right.



On your mobile device, go to your Wi-Fi settings and connect to your router's wireless network using the default Wi-Fi settings. Locate the Wi-Fi name (SSID) and password for your device as printed on the included Wi-Fi Configuration Card.



Tap the **mydlink SharePort** icon, and the app will load.



Tap **Set up** to enter the Admin password for your router when the pop-up displays.



Enter your Admin Login in the Password field and tap **Done**

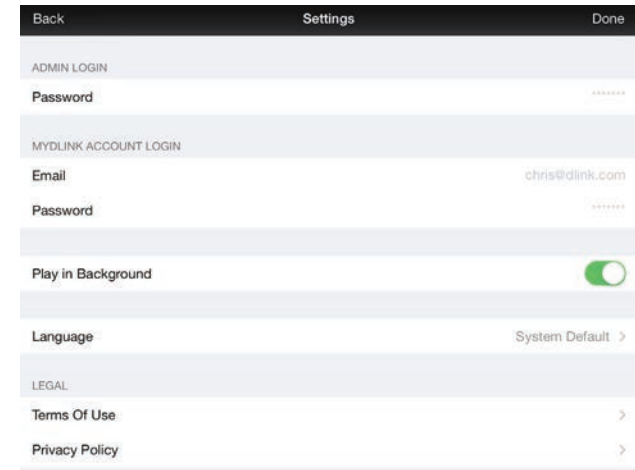

You can now use the mylink SharePort app interface to stream media and access files stored on your removable drive. The wireless icon at the bottom will be lit blue to indicate a Local Access connection. If you need to change your settings, tap the gear icon at the top right corner to enter the settings page.

Note: If you see a red wireless icon, your router's network environment may not be suitable for a direct network connection and you may experience slow network speeds.



Main Menu

The mydlink SharePort main menu has different sections that let you see all the documents, photos, movies, or music stored on your removable storage. Tap < or >, or swipe left or right to move between the different sections. The Wi-Fi icon at the bottom indicates an active local network connection (blue) or remote connection (green/red). Tap **Log In** if it is not lit, or **Log Out** to return to the login page.



Tap on the document icon to view documents.



Tap the camera icon to view photos.



Tap on the movie icon to play videos.

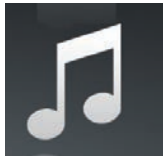

Tap on the music icon to play audio files.



Tap on the folder icon to browse all files in a folder view.

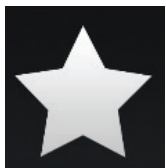

Tap on the star icon to access your favorite files.

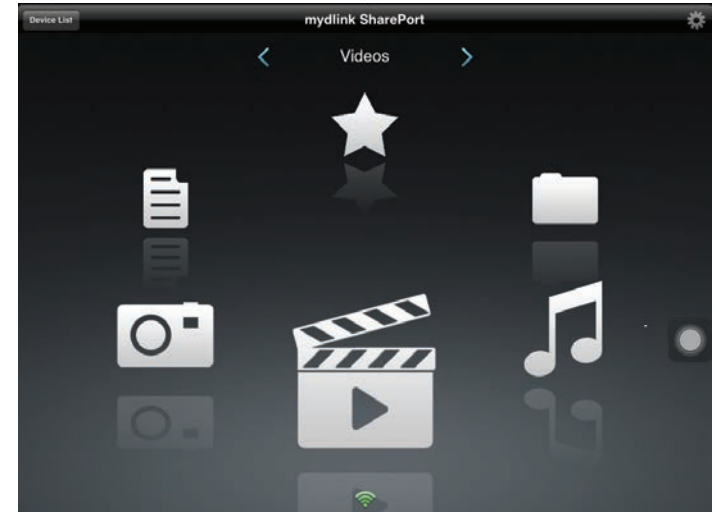

Documents

The Documents section allows you to share, print, and view documents streamed from your DIR-895L to your mobile device. Tap the document icon on the main menu to browse the documents on your mobile device.



Search Bar: Enter a filename here to search your storage.



Tap to mark files for deletion.



Tap the star icon next to each file to download it to your device and add it into your Favorites section.



Tapping this icon gives you additional options:

- **Mail:** Tap to e-mail the file.
- **iCloud:** Tap to store the file on iCloud.
- **AirPrint:** Tap to print the file.
- **Open In....:** Tap to use a third-party app to open the file.

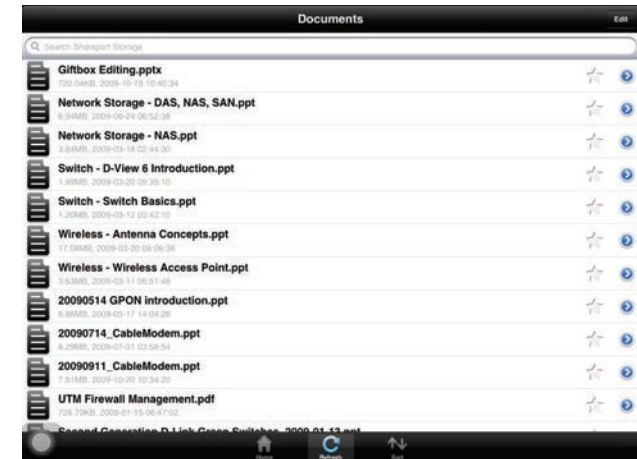

The bottom menu bar includes these options:



Tap to go back to the main menu.





Tap to update the list of files.



Tap to reorder the files alphabetically.

Tap on a file to start the document viewer. In the viewer:

 Tap to add/remove the file from your Favorites.

 Tap to bring up the same options as >.

Note: Some files may require a third-party app to view them.

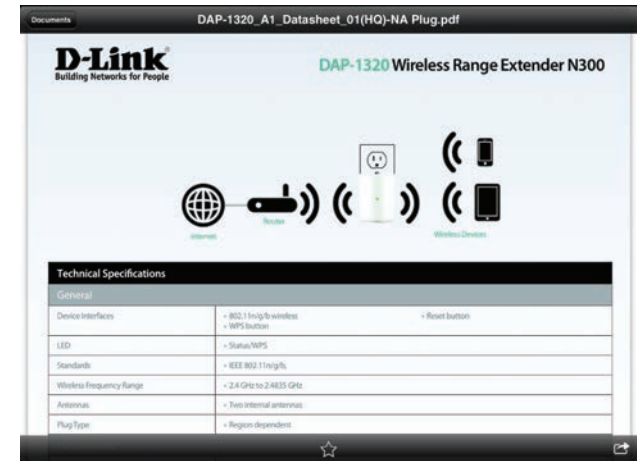

Pictures

The Pictures section allows you to stream images from your DIR-895L to your mobile device. Tap the camera icon on the main menu to browse your photo collection on your removable storage.



Search Bar: Enter a filename here to search your storage.

 Tap to mark files for deletion.

 Tap the star icon next to each file to download it to your device and add it into your Favorites section.

-  Tapping this icon gives you additional options:
- **Mail:** Tap to e-mail the image.
 - **iCloud:** Tap to store the image on iCloud.
 - **AirPrint:** Tap to print the image.
 - **Facebook:** Tap to upload the image to your Facebook account.
 - **Twitter:** Tap to upload the image to your Twitter account.
 - **Open In...:** Tap to use a third-party app to open the file.

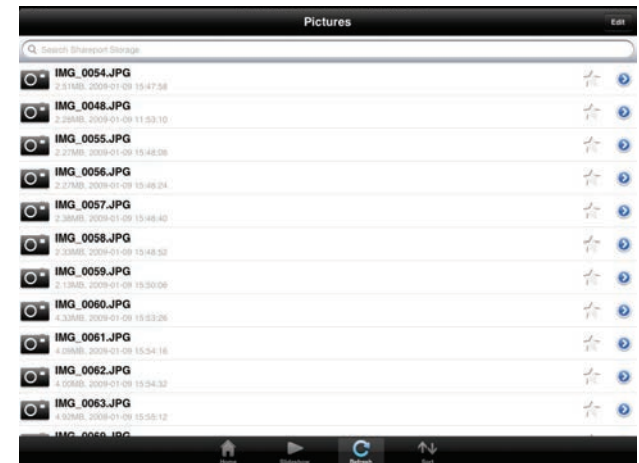

The bottom menu bar includes these options:



 Tap to go back to the main menu.

 Tap to start a slideshow of your photos. Tap the screen again to bring up the menu.

 Tap to update the list of files.

 Tap to reorder the files alphabetically.

Tap on a file to start the photo viewer. In the viewer:

-  Tap to add/remove the current image from your Favorites.
-  Tap to start the slideshow.
-  Tap to bring up the same options as >.

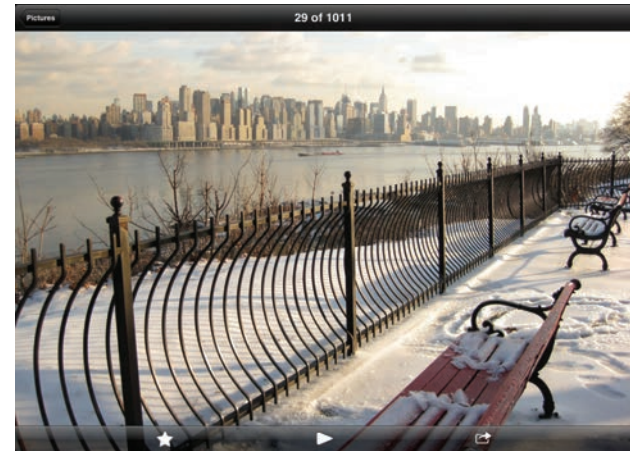



Videos

The Videos section allows you to stream video clips and movies from your DIR-895L to your mobile device. Tap the movie icon on the main menu to browse your videos on your removable storage.



Search Bar: Enter a filename here to search for a specific file.

 Tap to mark files for deletion.

 Tap the star icon next to a file to download it to your device and add it into your Favorites section.

 Tapping this icon gives you additional options:

- **Mail:** Lets you e-mail the file.
- **iCloud:** Lets you store the file on iCloud.
- **Open In...:** Lets you use a third-party app to open the file.

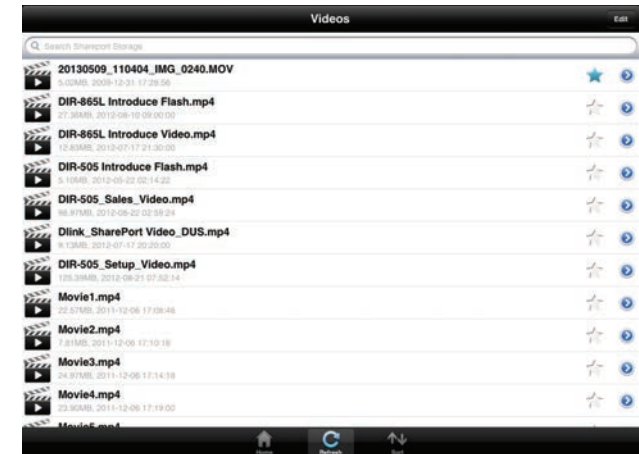





The bottom menu bar includes these options:

 Tap to go back to the main menu.

 Tap to update the list of files.

 Tap to reorder the files alphabetically.

Tap on a file to start playing it. In the player:

-  Tap to play/pause the video. You can scroll to any time on the time line by holding and sliding your finger.
-  Tap to enter/exit fullscreen mode.
-  Tap to add/remove the file from your Favorites.
-  Tapping this icon gives you additional options:
 - **Mail:** Lets you e-mail the video.
 - **iCloud:** Lets you store the video on iCloud.
 - **Open In...:** Lets you use a third-party app to open the file.



Music

The Music section allows you to stream songs from your DIR-895L to your mobile device. Tap the music icon on the main menu to browse your music collection on your removable storage.

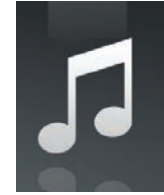

Search Bar: Enter a filename here to search your storage.



Tap to create a playlist and mark files for deletion.



Tap the star icon next to each file to download it to your device and add it into your Favorites section.



Tapping this icon gives you additional options:

- **Mail:** Lets you e-mail the file.
- **iCloud:** Lets you store the file on iCloud.
- **Open In...:** Lets you use a third-party app to open the file.



The bottom menu bar includes these options:



Tap to go back to the main menu.







Tap to update the list of files.



Tap to reorder the files alphabetically.

Tap on a file to start playing it. In the player:

  Tap to repeat all. Tap again to repeat a single song.

  Tap to skip to the previous/next song.

 Tap to enable/disable shuffle mode.



To create a playlist:

Tap **Edit** > **Add Playlist**.

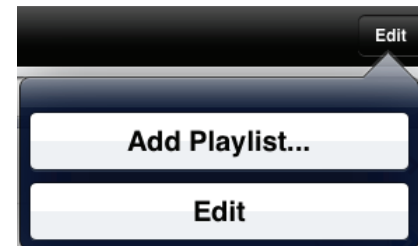

Enter a name for the playlist, then tap **Save**.

The name of the playlist will appear in the browser next to the  icon.

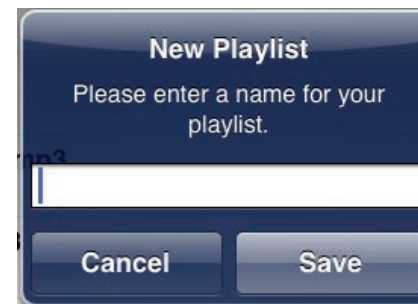

To add songs to a playlist:

Tap the playlist in the browser.

Tap **Add Music...** to add songs to the current playlist.

Tick the songs you wish to add and tap **Done**.

To delete songs from the playlist:

Tap **Edit** in the playlist browser and mark the files to be deleted.

Tap **Delete**.

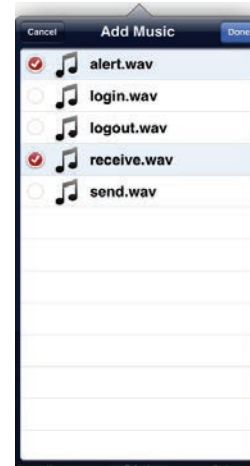



Folders

You can browse your removable storage in a folder view in the folders section. Tapping the filename will open the viewer/player for that file type as described in the previous pages. You can also upload files from your mobile device to the removable storage attached to your router.





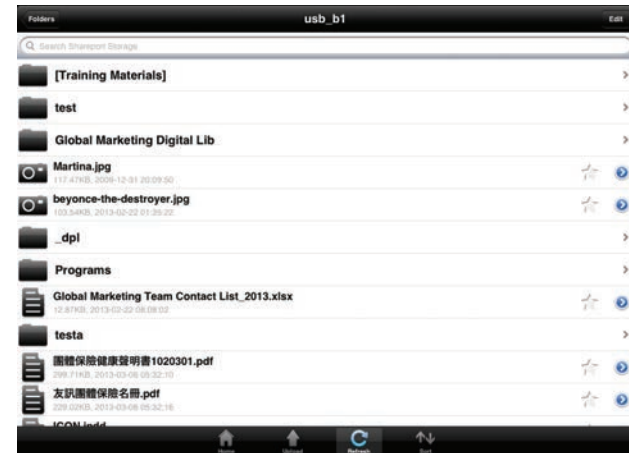

Search Bar: Enter a filename here to search your storage.

-  Tap to take you to the editing screen where you can add a folder and mark files for deletion or copying.
-  Tap the star icon next to each file to download it to your device and add it into your Favorites section.
-  Tapping the > icon gives you additional options depending on the file type.



The bottom menu bar includes these options:

-  Tap to go back to the main menu.
-  Tap to upload files from your device to your removable storage.
-  Tap to update the list of files.
-  Tap to reorder the files alphabetically.

To delete files:

Tap **Edit** at the top right.

Tick the circle next to a file to mark it for deletion.

Tap on **Delete** at the bottom to delete the file.

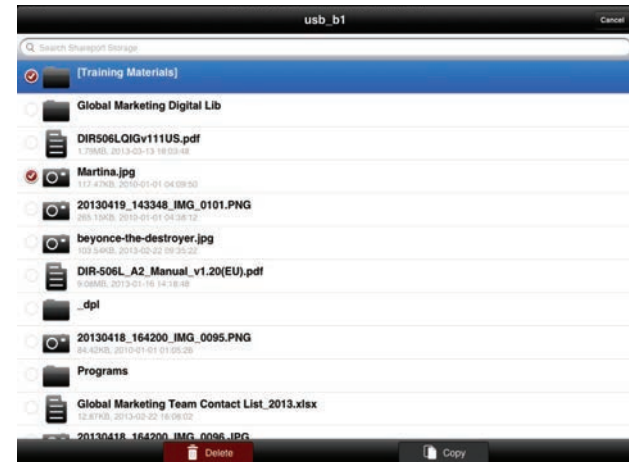

To copy files:

Tap on **Copy** to bring up a window where you can select the folder to copy to.

Browse to the directory you want to copy the marked files to and tap **Paste**.

You can also tap **Add Folder** to create a new folder.

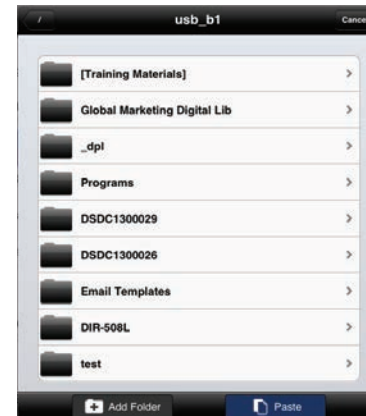

To create a new folder:

Browse to the directory you wish to create a new folder in.

Tap **Edit** at the top right.

Tap **Add Folder** to add a new folder.

Enter the name of the new folder, then tap **Save**.

Tap **OK** to confirm folder creation.



To upload images and videos from your mobile device:

Browse to the folder you wish to upload to.

Tap **Upload** at the bottom.

Select the photos/videos you wish to upload.

Tap **Done**.



During the upload process, the size of the file and the upload progress will be displayed.

To upload more files, tap the + icon at the top right and repeat the steps listed above.

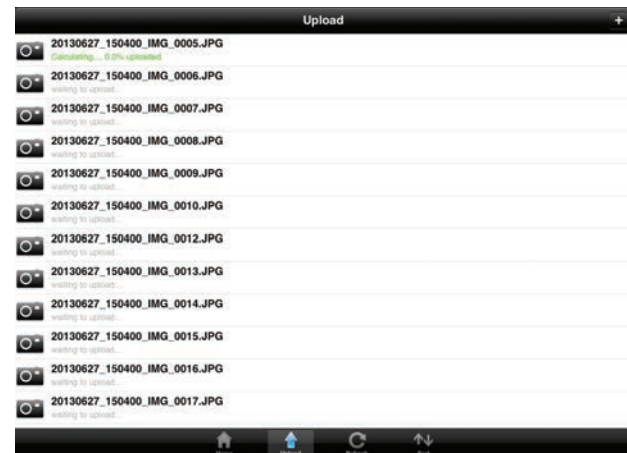

Favorites

The Favorites section allows you to quickly access your most often used files, no matter what file type, in a special section. Files added to the Favorites section will be copied here for playback in a centralized location.





 Tap to mark files for deletion from the local storage in Favorites. The file will still be accessible in other mydlink SharePort sections.

 Tapping this icon gives you additional options depending on the file type.

The bottom menu bar includes these options:

 Tap to go back to the main menu.

 Tap to update the list of files.

 Tap to reorder the files alphabetically.

Tap on a file to start the file viewer. In the viewer:

 Tap to add/remove the file from your Favorites.

 Tap to bring up additional options.

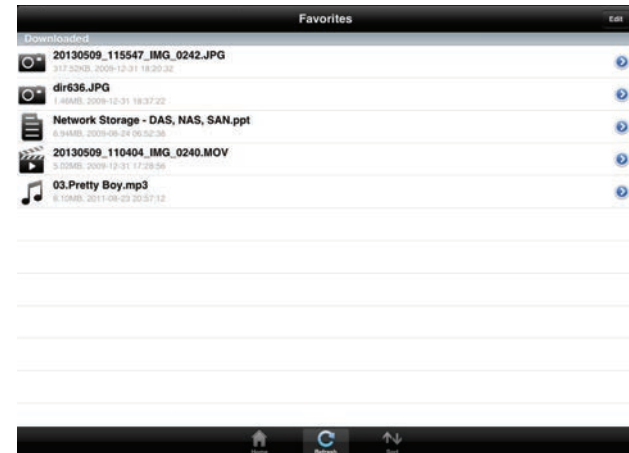

Note: The file options available will vary depending on the file type.

Using the mydlink SharePort™ app for Android™

The mydlink SharePort™ app is a streamlined mobile application that allows you to conveniently stream media and share files stored on a removable storage connected to your router. Once the router is set up, you can start the app and easily connect from a local network or through the Internet to access your photos, videos, music, and documents. It allows you to create your own personal cloud storage; you can upload files and photos from your mobile device to the removable storage via the app from anywhere in the world!

Note: In order to ensure smooth streaming performance, you will need a minimum of 2 Mbit/s upload bandwidth for your router's Internet connection. Streaming performance will vary depending on the quality of your Internet connection.

If you are connecting remotely through the mydlink SharePort™ app from the Internet, you will need a **mydlink** account.

Make sure the device is powered on. Then plug your USB drive into the USB port of the device.

Note: If you connect a removable storage with many files or a large capacity, it may take a while for the router to scan and catalog your files.

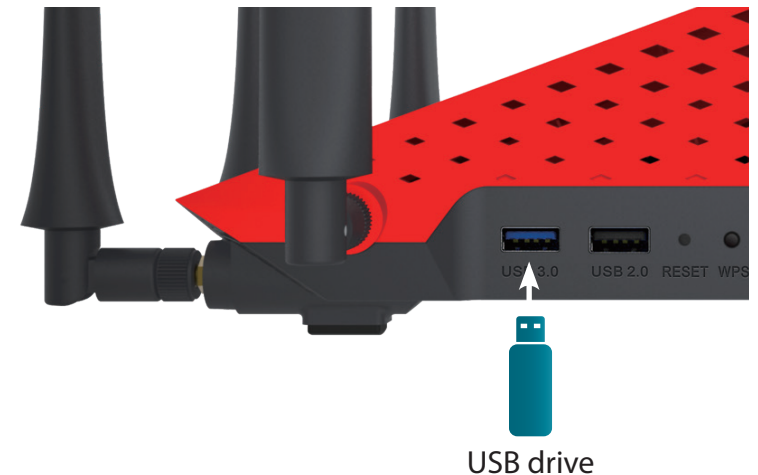

3. Use your Android mobile device to search for and download the free **mydlink SharePort** app from Google Play™.

If you have a QR code reader, you can scan the code for **mydlink SharePort** to the right.



4. Tap the **mydlink SharePort** icon, and the app will load.

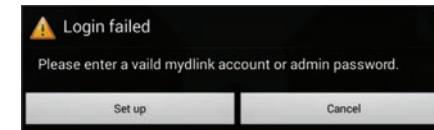

5. Tap **Set up** to go to Settings and enter the Admin password and your mydlink Account Login information when the pop-up displays. Tap **Apply** when your information is entered. (The Admin password is only for local access, if you can connect through the Internet, then you can leave the Admin password blank)

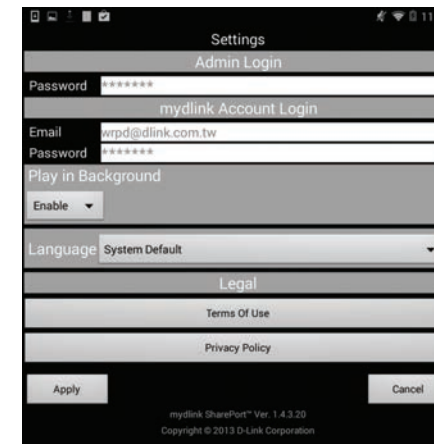

You can now use the mydlink SharePort app interface to stream media and access files stored on your removable drive. The wireless icon at the bottom will be lit green to indicate you are connected to the router through Remote Access.

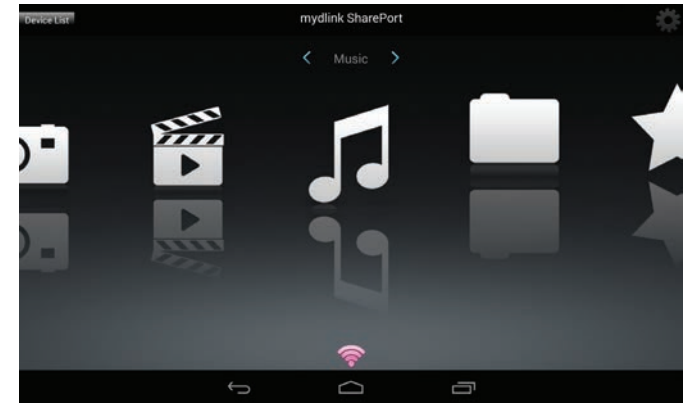

If you have more than one device registered to your mydlink account, you can tap **Device List** (in the top-left corner) and you will be prompted to select the device you wish to use.

Note: If you see a red wireless icon, your router's network environment may not be suitable for a direct network connection and you may experience slow network speeds.



Using mydlink SharePort in a local network:

1. Make sure the device is powered on. Then plug your USB drive into the USB port of the device.

Note: If you connect a removable storage with many files or a large capacity, it may take a while for the router to scan and catalog your files.

2. Use your Android mobile device to search for and download the free **mydlink SharePort** app from Google Play™.

If you have a QR code reader, you can scan the code for **mydlink SharePort** to the right.



3. On your mobile device, go to your Wi-Fi settings and connect to your router's wireless network using the default Wi-Fi settings. Locate the Wi-Fi name (SSID) and password for your device as printed on the included Wi-Fi Configuration Card.

Note: If you see a red wireless icon, your router's network environment may not be suitable for a direct network connection and you may experience slow network speeds.

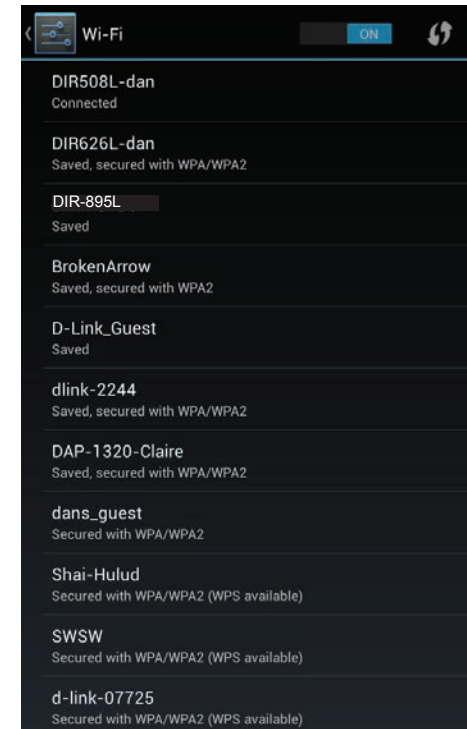

4. Tap the **mydlink SharePort** icon, and the app will load.



5. Tap **Set up** to enter the Admin password for your router when the pop-up displays.

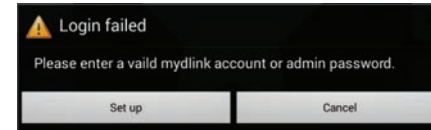

6. Enter your Admin Login in the Password field and tap **Apply**. You will be taken back to the device list where you can select the device for use with mydlink SharePort.

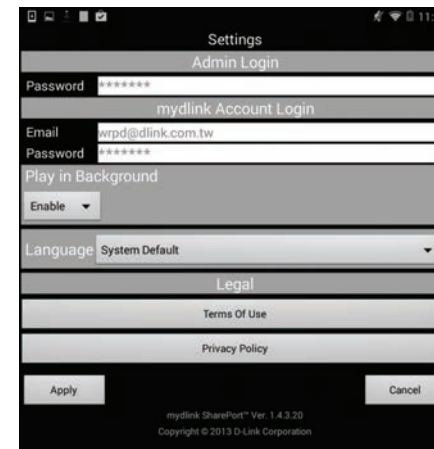

7. You can now use the mydlink SharePort app interface to stream media and access files stored on your removable drive. The wireless icon at the bottom will be lit blue to indicate a Local Access connection.

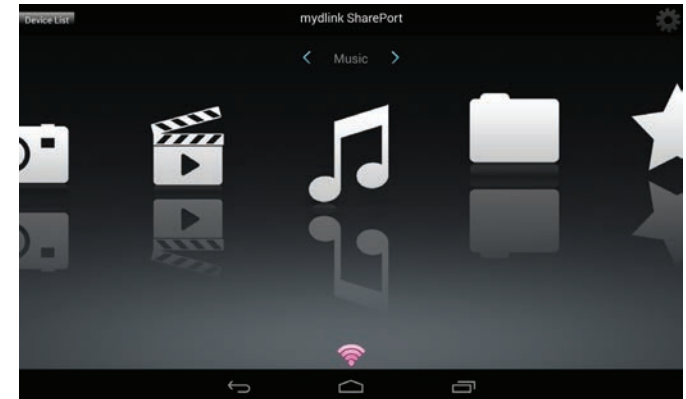

Note: If you see a red wireless icon, your router's network environment may not be suitable for a direct network connection and you may experience slow network speeds.

Main Menu

The mydlink SharePort main menu has different sections that let you see all the documents, photos, movies, or music stored on your removable storage. Tap < or >, or swipe left or right to move between the different sections. The Wi-Fi icon at the bottom indicates an active local network connection (blue) or remote connection (green/red). Tap **Log In** if it is not lit, or **Log Out** to return to the login page.



Tap on the document icon to view documents.



Tap the camera icon to view pictures.



Tap on the movie icon to play videos.

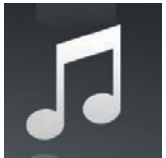

Tap on the music icon to play audio files.



Tap on the folder icon to browse all files in a folder view.



Tap on the star icon to access your favorite files.

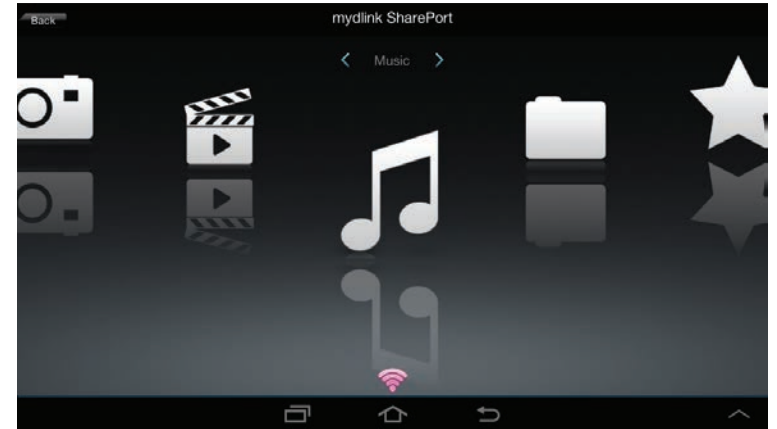

Note: Available features may differ depending on the Android OS version of your device.

Documents

The Documents section allows you to share, print, and view documents streamed from your DIR-895L to your mobile device. Tap the document icon on the main menu to browse the files on your mobile device.

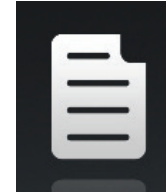

Search Bar: Type in the name of a file to search for it.



Tap to return to the main menu.



Tap to refresh, sort, or mark files for deletion.



Tap the star icon next to each file to download it to your device and add it into your Favorites section.

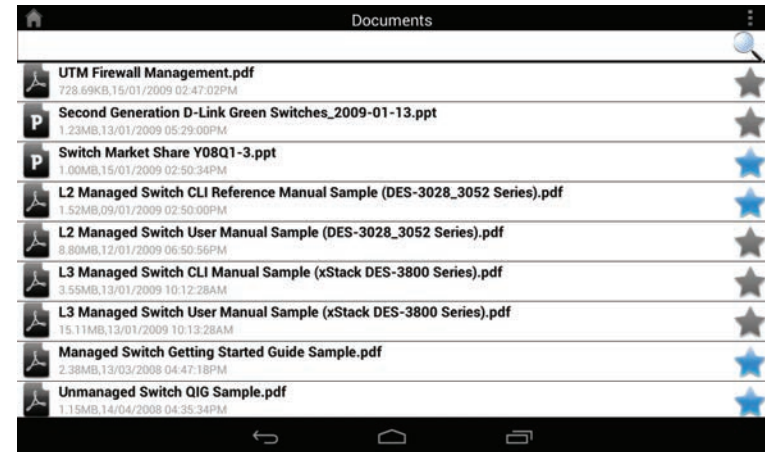

Tap  for additional options:



Tap to return to the main menu.



Tap to update the list of files.



Tap to sort the files by name, size, type, or date.



Check a file then tap to delete it.

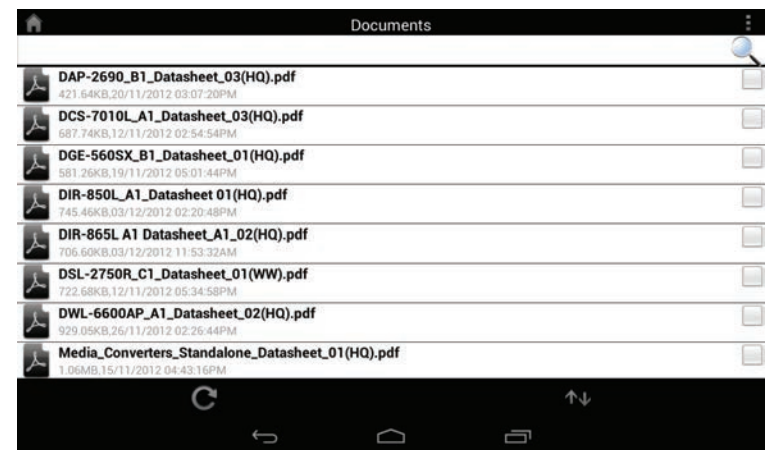

Tap on a file to start the document viewer. In the viewer:

Tap the screen to bring up zoom in/out buttons.

Drag the screen up or down to scroll between pages.

Tap  to perform File, Find, Zoom, Reading View, Go To Page, and Bookmarks actions.

Note: Available actions may differ depending on your Android OS.



Pictures

The Pictures section allows you to view images streamed from your DIR-895L to your mobile device. Tap the camera icon on the main menu to browse your photo collection on your removable storage.



Search Bar: Type in the name of a file to search for it.



Tap to return to the main menu.



Tap to start a slideshow.



Tap to refresh, sort, or mark files for deletion.



Tap the star icon next to each file to download it to your device and add it into your Favorites section.

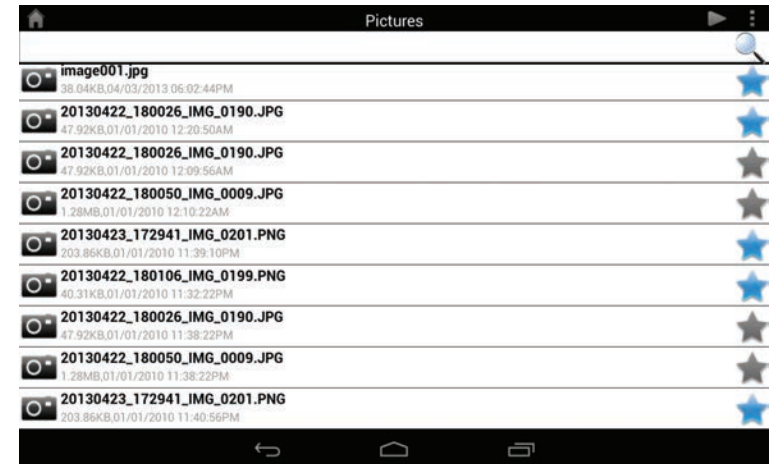

Tap for additional options:



Tap to return to the main menu.



Tap to update the list of files.







Tap to sort the files by name, size, type, or date.

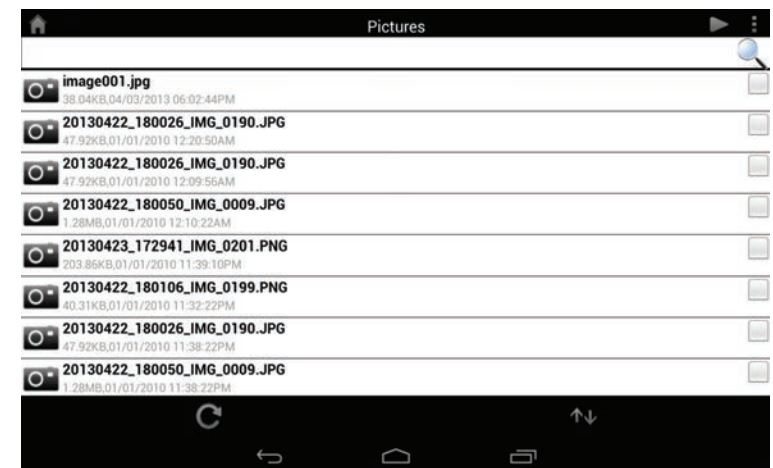

Check a file then tap to delete it.



Tap on an image file to start the image viewer. In the viewer:

-  Tap the star icon to download it to your device and add it into your Favorites section.
-  Tap to start a slideshow. Tap the image to stop the slideshow.
-  Tap to delete the current image. Tap **OK** to confirm.
-  Tap to bring up additional options using other applications.
-  Tap to access the image editor.

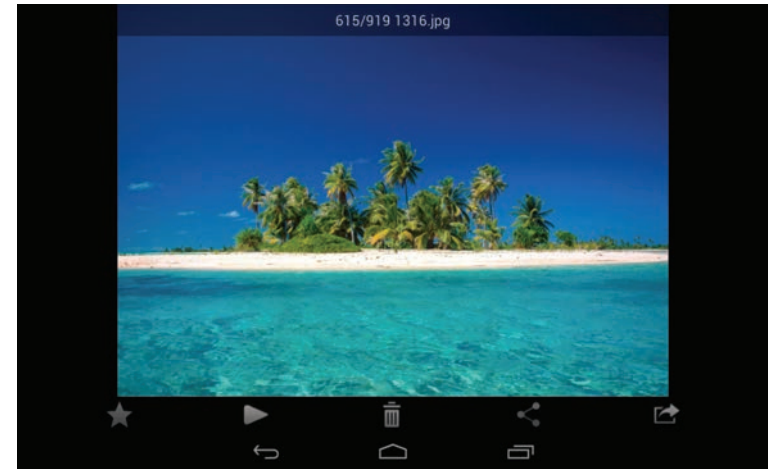

Note: This function may vary depending on the version of your Android OS.

Videos

The Videos section allows you to stream video clips and movies from your DIR-895L to your mobile device. Tap the movie icon on the main menu to browse your videos on your removable storage.



Search Bar: Type in the name of a file to search for it.



Tap to return to the main menu.



Tap to refresh, sort, or mark files for deletion.



Tap the star icon next to a file to download it to your device and add it into your Favorites section.



Tap  for additional options:



Tap to return to the main menu.



Tap to update the list of files.



Tap to sort the files by name, size, type, or date.



Check a file then tap this icon to delete it.



Tap on a file to start playing it. Tap on the screen to bring up the scroll bar, pause button, and play button.

 Tap to resume playback.

 Tap to pause the video.

Note: Available features may vary depending on the Android OS version installed on your device.

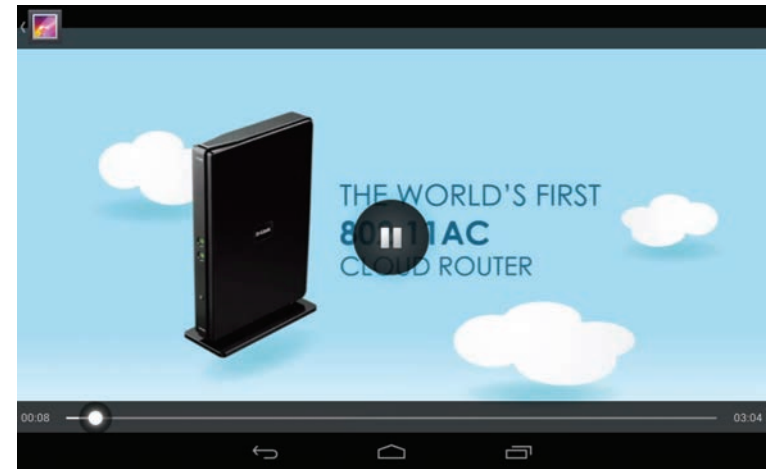

Music

The Music section allows you to stream songs from your DIR-895L to your mobile device. Tap the music icon on the main menu to browse your music collection on your removable storage.

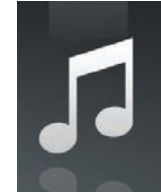

Search Bar: Type in the name of a file to search for it.



Tap to return to the main menu.



Tap to refresh, sort, or mark files for deletion.



Tap to browse your playlists.



Tap the star icon next to a file to download it to your device and add it into your Favorites section.

Tap for additional options:



Tap to return to the main menu.



Tap to update the list of files.



Tap to sort the files by name, size, type, or date.





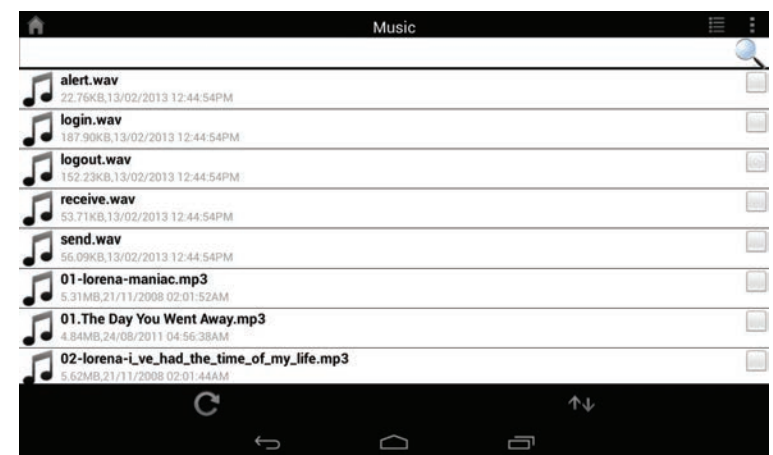
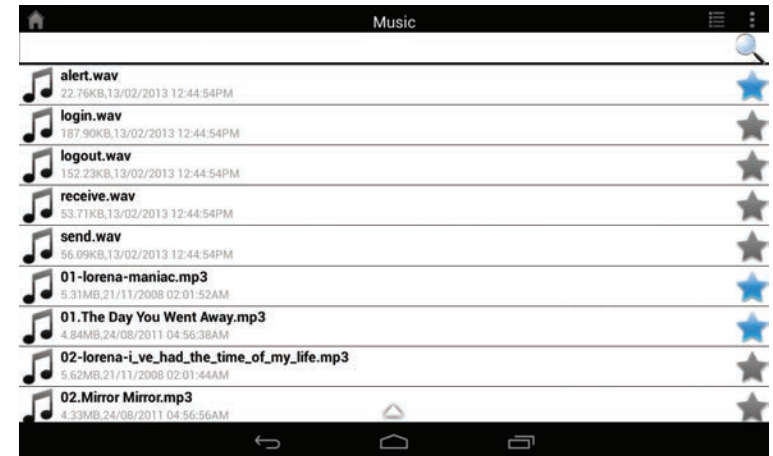

Check a file then tap this icon to delete it.



Tap on a file to start playing it. In the player:

 Tap on the up/down arrow to show/hide the player controls.

  Tap to repeat all. Tap again to repeat a single song.

  Tap to skip to the previous/next song.

 Tap to play or pause the song.

 Tap to enable/disable shuffle mode.

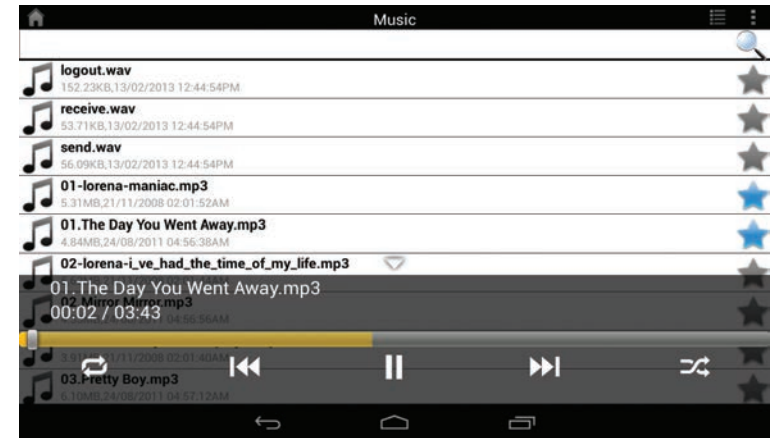

To create a playlist:

Tap 

Tap **Add new playlist...**

Enter a name for the playlist, then tap **OK**. The name of the playlist will appear in the browser next to the  icon.

You can tap  then  to refresh the playlist page.

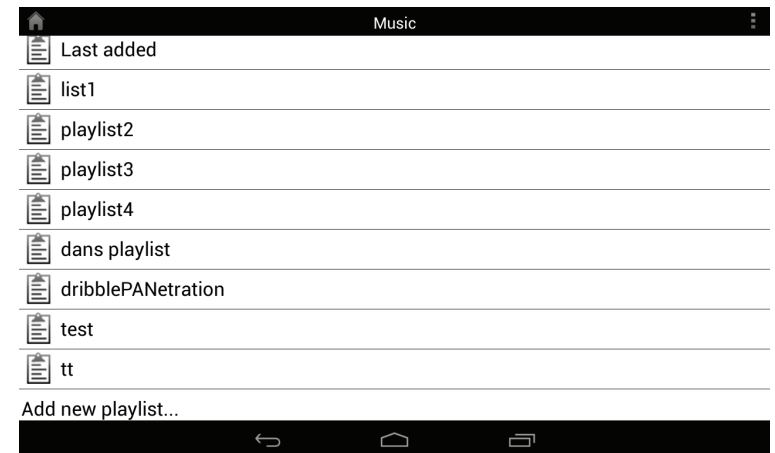

To add songs to a playlist:

Tap a playlist to see its contents.

Tap **Add Music...** to add songs to the current playlist.

Tick the songs you wish to add and tap  to save.

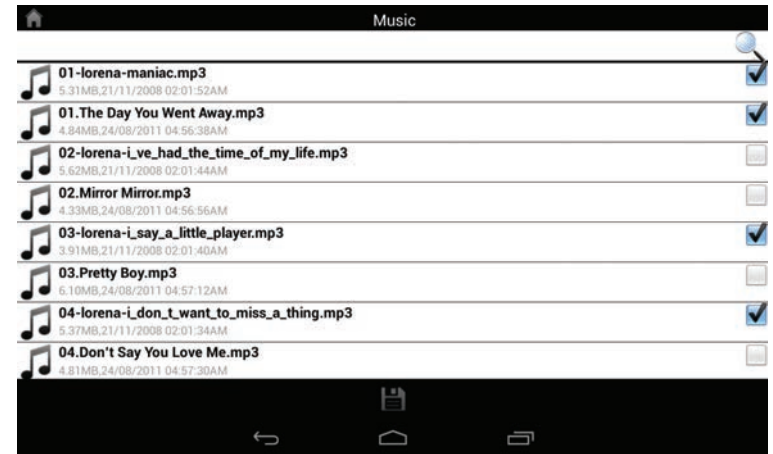

To delete songs from the playlist:

Tap **Edit** in the playlist browser and mark the files to be deleted.

Tap  then tap **OK** to confirm.

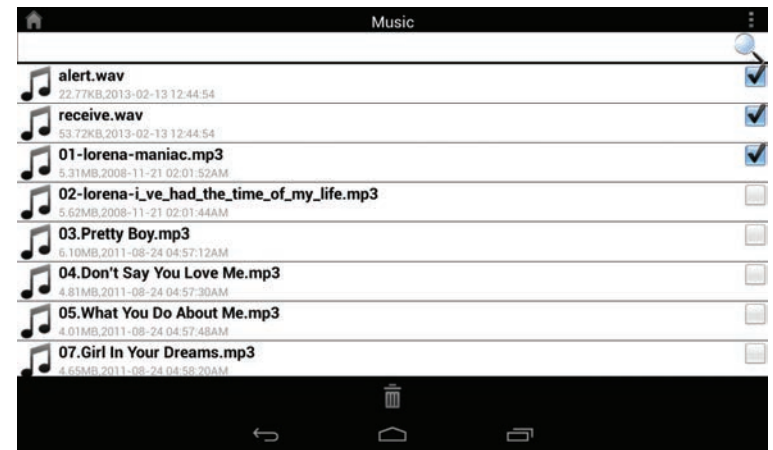

Folders

You can browse your removable storage in a folder view in the folders section. Tapping the filename will open the viewer/player for that file type as described in the previous pages. You can also upload files from your mobile device to the removable storage attached to your router.

Search Bar: Type in the name of a file to search for it.



Tap to return to the main menu.



Tap to access file options.

In the file browser:



Tap to return to the main menu.







Tap to upload files.



Tap to refresh, sort, create a new folder, or mark files for deletion and copying.





Tap  to select files and perform the following actions:

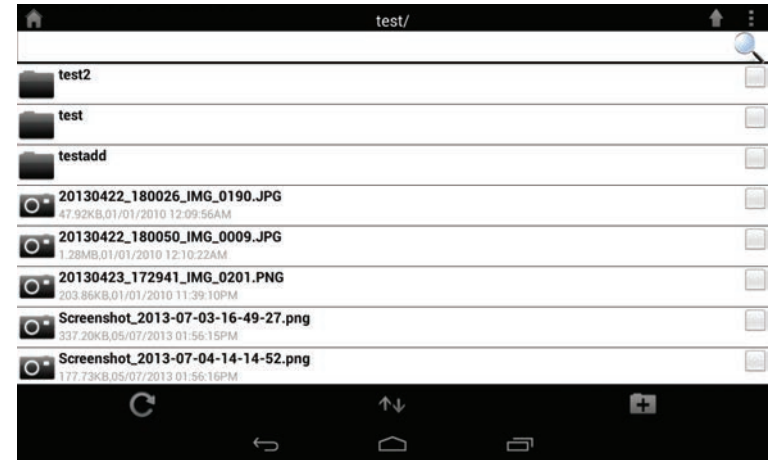

-  Tap to update the list of files.
-  Tap to sort the files by name, size, type, or date.
-  Tap to create a new folder.
-  Mark a file then tap this icon to delete it.
-  Mark a file then tap this icon to copy it.



To delete files:

- Tap on  and tick the box next to a file for deletion.
- Tap on  to delete your selected files. Tap **OK** to confirm.

To copy files:

- Tap on  to select files for copying. Tick the box next to each file for copying.
- Tap on  to browse to the destination.



Tap **Paste** or **Cancel**.

You can also tap **New Folder** if you wish to create a folder in the current directory.

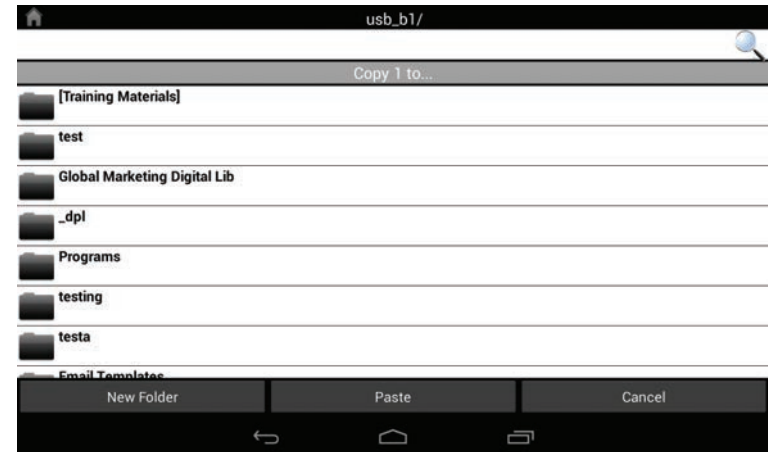

To create a new folder:

Browse to the directory you wish to create a new folder in.

Tap  then .

Enter the name of the folder in the box, then tap **OK**.

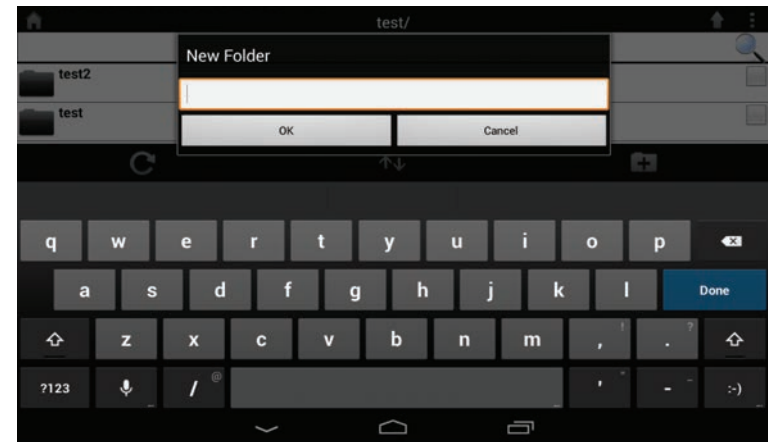

To upload images and videos from your mobile device:

Browse to the folder you wish to upload to.

Tap  and browse to the file or files you wish to upload from the local device.

Tick the box next to each of the files you wish to upload.

Tap **Upload**.



During the upload process, the size of the file and the upload progress will be displayed under the file name.

To remove a file from the upload queue, tap the X next to it.

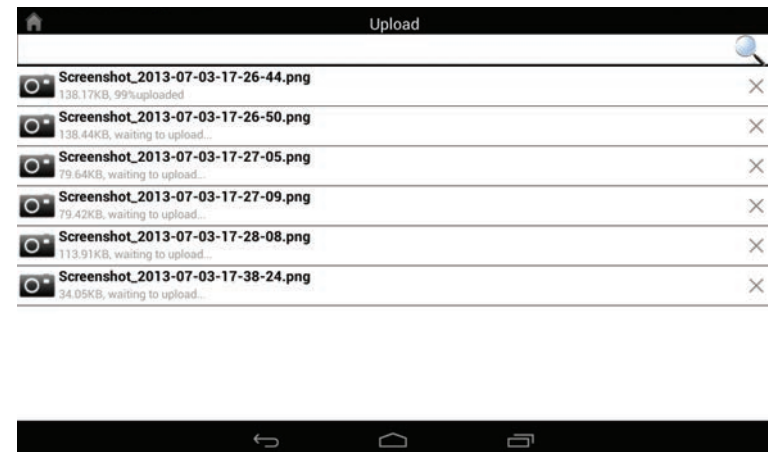

Favorites

The Favorites section allows you to quickly access your most often used files, no matter what file type, in a special section. Files added to the Favorites section will be copied here for playback in a centralized location.



Search Bar: Type in the name of a file to search for it.



Tap to return to the main menu.



Tap to refresh, sort, or mark files for deletion.

Tap  for additional options:



Tap to return to the main menu.



Tap to update the list of files.



Tap to sort the files by name, size, type, or date.



Check a file then tap to delete it.

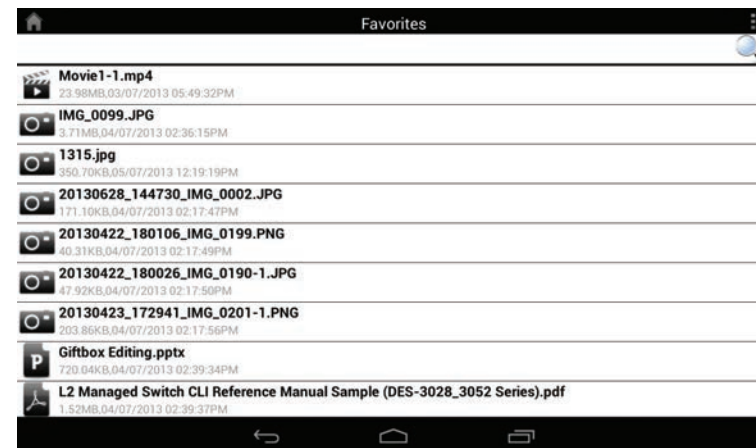

SharePort Plus

After you have successfully installed and configured your D-Link DIR-895L, you are ready to enjoy the benefits of D-Link's SharePort Plus technology. D-Link's SharePort Plus enabled devices allow you to quickly and easily share a USB printer or USB storage device among several PCs using D-Link's SharePort Plus Utility Software.

Share a USB Printer

Note: To share a wireless printer, please refer to your printer's installation documentation.

Install Your Printer To Each Computer

Before attaching your printer to your D-Link DIR-895L, directly install your USB printer to each of the computers you wish to share it with. Follow the setup instructions provided by your printer manufacturer. This ensures that your operating system installs the software drivers and utilities required for your printer to function properly with the SharePort Plus Utility.

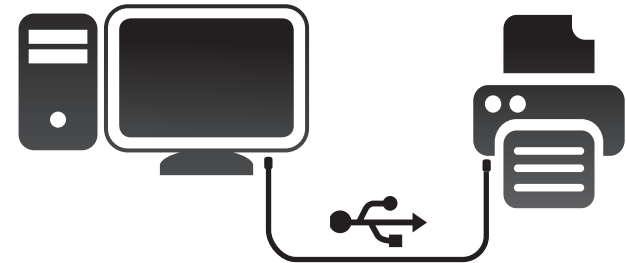

Connect Your Printer To Your D-Link SharePort Plus Enabled DIR-895L

Move your printer near your D-Link SharePort Plus enabled DIR-895L. Plug in your printer's power cord, turn it on, load some paper, and connect the printer's USB cable to your DIR-895L's USB port.

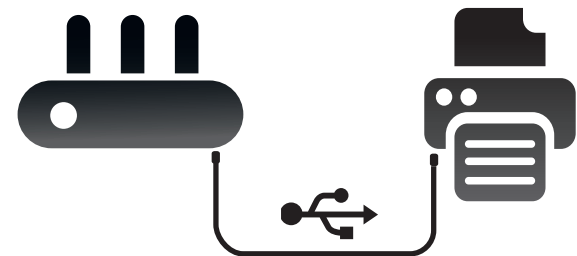

Windows PC Configuration

Install the SharePort Plus Utility on each Windows PC:

Visit dlink.com to download and install the latest version of the D-Link SharePort Plus Installation Utility.

Upon successful installation, the SharePort Plus Utility will launch. Your PC will automatically attempt to connect to your D-Link SharePort Enabled DIR-895L and once successful, a list of connected USB devices will be displayed. If your printer is among the listed devices, a dialog box will automatically appear asking, "Would you like to configure auto print connect for this printer?"

To quickly set up your printer, click **Yes**.



The SharePort Plus utility will automatically configure your PC to print to the printer attached to your SharePort Plus enabled DIR-895L's USB port. A green check mark (✓) indicates that the printer is connected to your PC.



Congratulations, you are now ready to print! Remember, that only one PC or Mac may connect to the printer at a time.

If you need troubleshooting or wish to use the advanced configuration settings, please visit dlink.com to download the SharePort Plus User Manual.

Mac Configuration

Install the SharePort Plus Utility on each Mac:

Visit **dlink.com** to download and install the latest version of the D-Link SharePort Plus Installation Utility. Upon successful installation, the SharePort Plus Utility will launch. Your Mac will automatically try to connect to your D-Link SharePort Enabled DIR-895L and once successful a list of connected USB devices will be displayed. If your printer is among the listed devices, a dialog box will automatically appear, asking, "Would you like to configure auto print connect for this printer?"

To quickly set up your printer, click **Yes**.



The SharePort Plus utility will automatically configure your computer to print to the printer attached to your SharePort Plus enabled DIR-895L's USB port. A green check mark (✓) indicates that the printer is connected to your Mac.

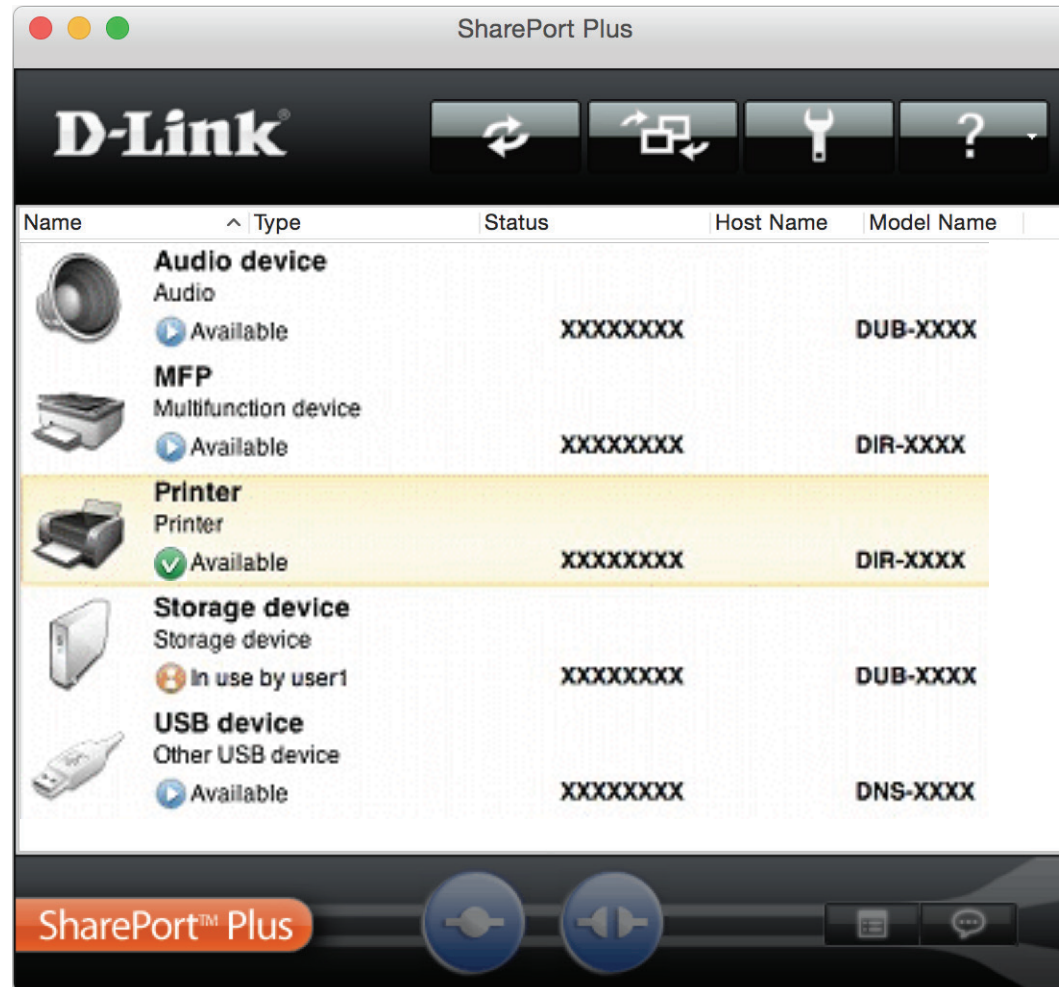

Congratulations, you are now ready to print! Remember, that only one PC or Mac may connect to the printer at a time.

If you need troubleshooting or wish to use the advanced configuration settings, please visit dlink.com to download the SharePort Plus user manual.

Share a USB Storage Device

The SharePort Plus Utility turns your USB Storage Device into a network drive that, once connected, will allow you to copy, move, delete, and edit files like you would with any ordinary drive attached to your computer.

Connect Your USB Storage Device To Your D-Link DIR-895L

Directly connect your USB storage device to your D-Link SharePort Plus enabled DIR-895L's USB port.

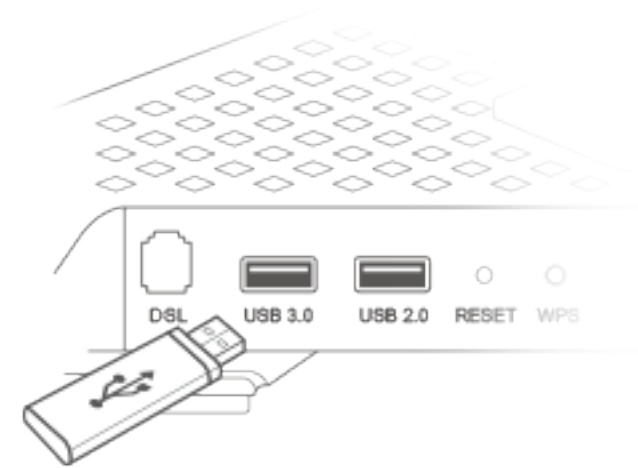

Install the SharePort Plus Utility on each Windows PC or Mac:

Visit dlink.com to download and install the latest version of the D-Link SharePort Plus Installation Utility. Upon successful installation, the SharePort Plus Utility will launch. Your PC or Mac will automatically try to connect to your D-Link SharePort Enabled DIR-895L and once successful, a list of connected USB devices will be displayed.



Connecting to your USB Storage Device from a Windows PC:

To access your files, right click your storage device and select **Open** or **Map network drive**. The drive's contents will be displayed in Windows Explorer.

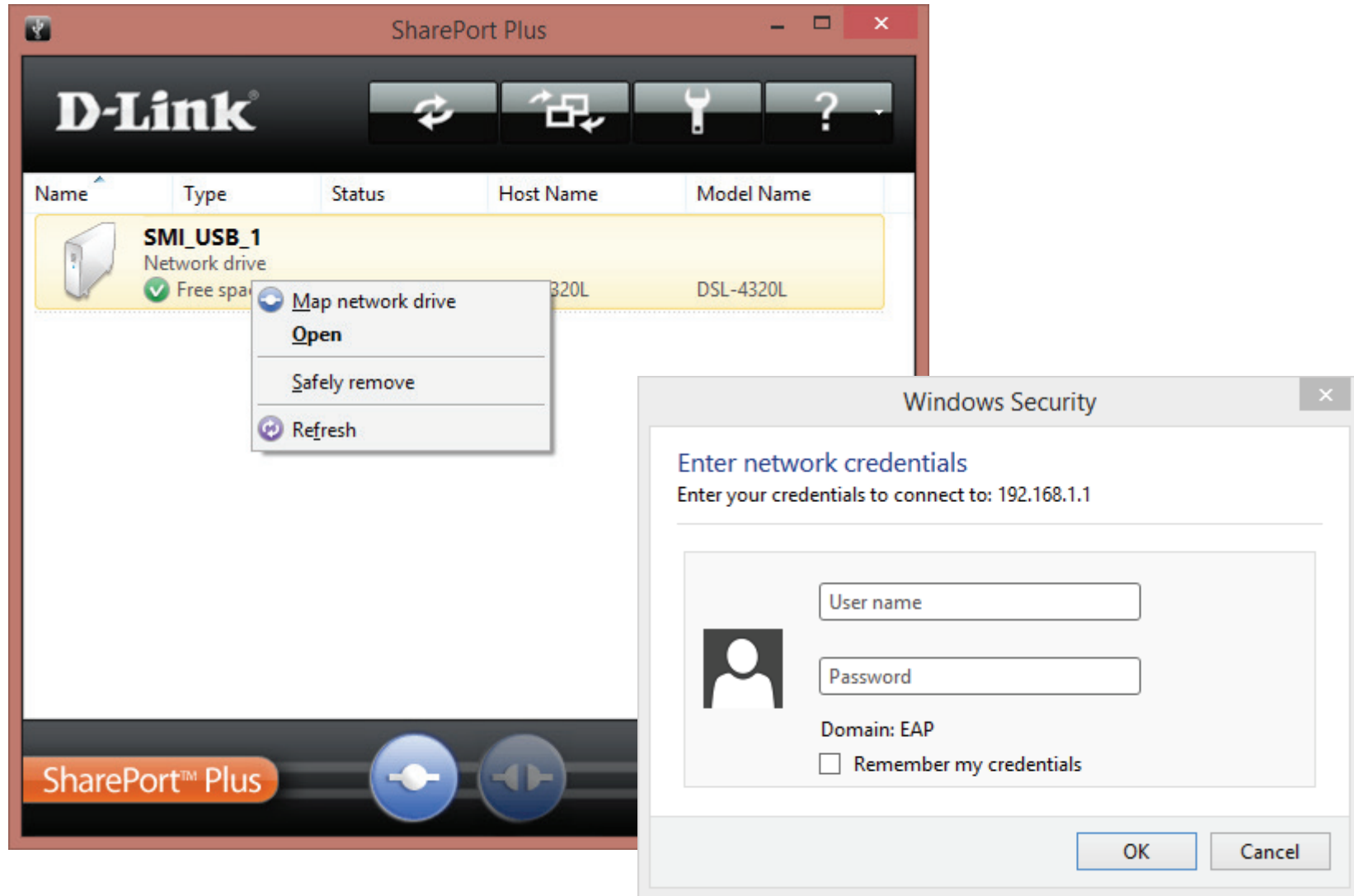

If a login prompt appears, enter your DIR-895L's web configuration utility's username and password you created when you set up your router.

Connecting to your USB Storage Device from a Mac:

To access your files, click on your storage device and press the connect button. The drive's contents will be displayed in Finder.

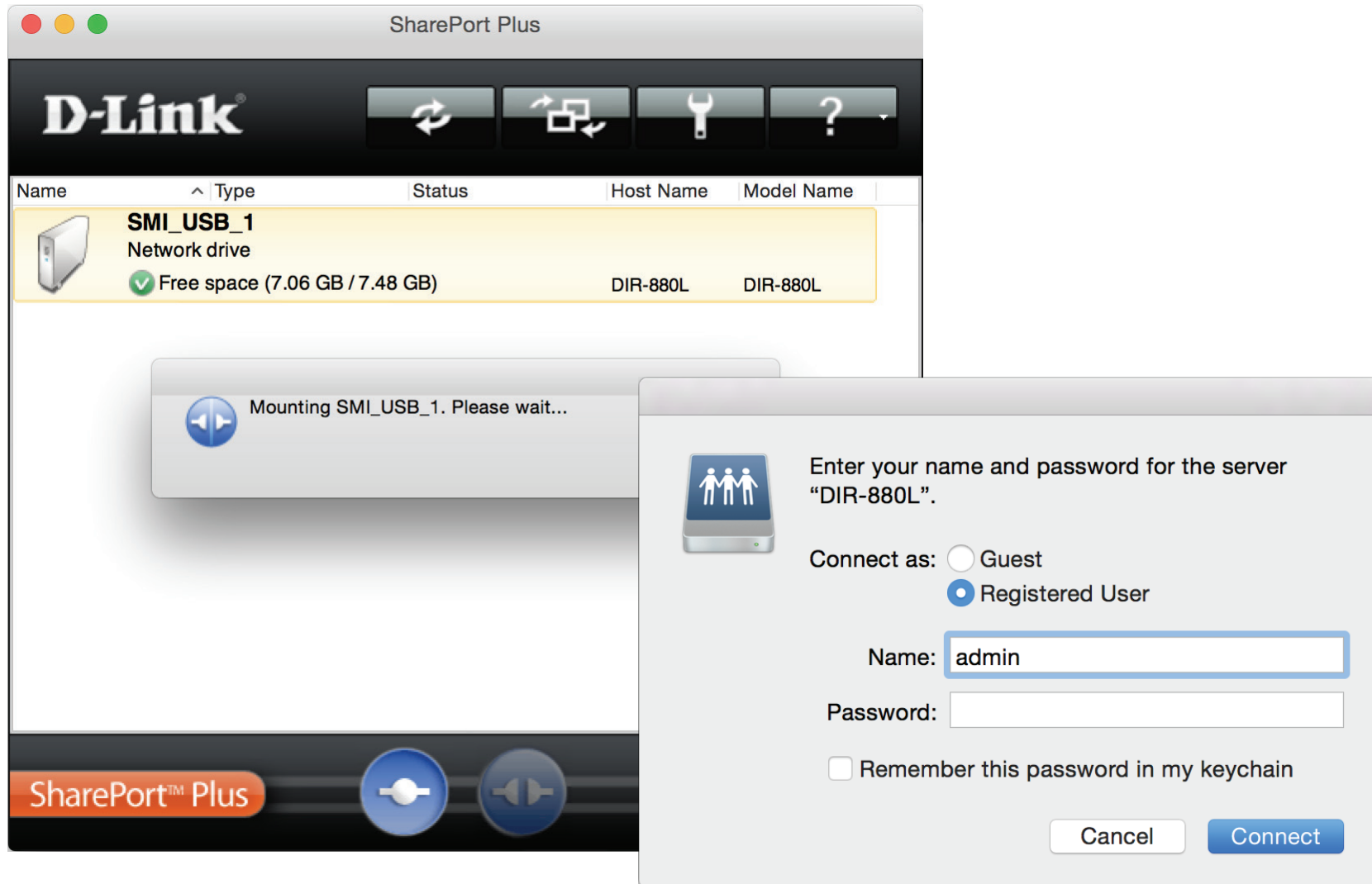

If a login prompt appears, enter your DIR-895L's web configuration utility's username and password you created when you set up your router.

How to Safely Disconnect a USB Storage Device

From Each Windows Computer:

When you wish to disconnect your USB drive from your D-Link SharePort Plus enabled DIR-895L and ensure that no data is lost or corrupted, right click on the USB device in the SharePort Plus application and select **Safely remove**. You may then physically disconnect your USB storage device from your D-Link SharePort Plus device's USB port.



From Each Mac:

When you wish to disconnect your USB drive from your D-Link SharePort Plus enabled DIR-895L and ensure that no data is lost or corrupted, click on the USB storage device in the SharePort Plus application and press the disconnect button.



Click yes to confirm you wish to stop using the device. You may then physically disconnect your USB storage device from your D-Link SharePort Plus device's USB port.

Quick VPN

This router is equipped with D-Link's Quick VPN technology. Virtual Private Networking (VPN) creates a connection between devices across the Internet. Using Quick VPN allows you to securely connect your computer or mobile device to places with free, untrusted Wi-Fi hotspots in places like coffee shops and hotels by encrypting and relaying it through your home Internet connection. This extra 'hop' reduces the chances of hackers stealing your information, such as logins, passwords, and credit card numbers. When traveling, Quick VPN lets you watch sports and use video streaming services without experiencing blackouts or filtering. You can surf the whole Internet unfiltered and unblocked, just as you would at home.

Without Quick VPN

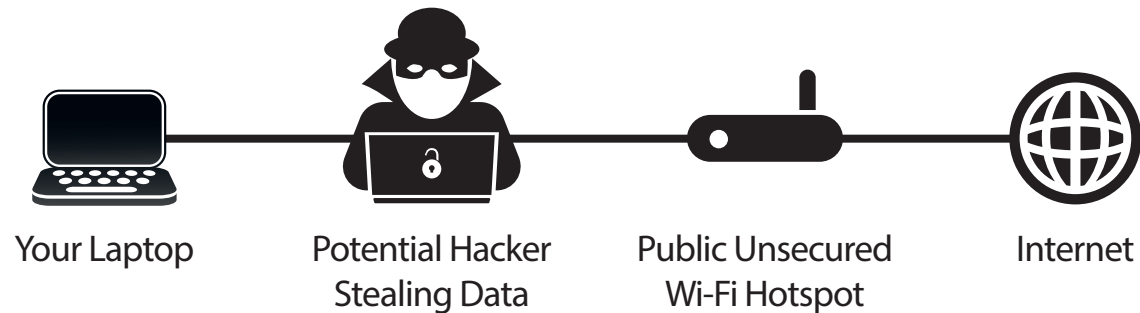

With Quick VPN

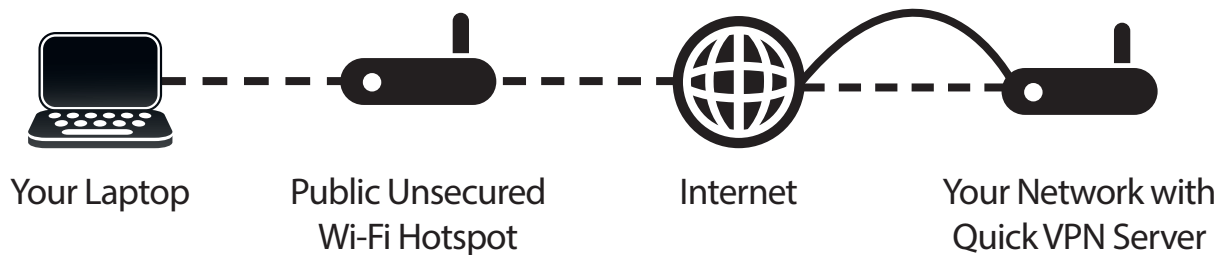

————— Unencrypted Data
- - - - - Encrypted Data

Important Information

The following instructions explain and help you to configure your D-Link Quick VPN enabled router and devices to create a Virtual Private Network (VPN). This feature is provided for advanced users who wish to connect remotely and use their router's Internet connection to add a layer of security while using untrusted networks. Configure the Quick VPN Server on your router first and then set up client devices to connect through your router's WAN connection.

- Quick VPN only provides an added layer of security against specific types of snooping attacks and does not guarantee complete data integrity or protection. Only traffic in the tunnel between your router and device will be encrypted, WAN traffic will leave your D-Link Quick VPN enabled router unencrypted.
- Keep your Quick VPN Username, Password, and Passkey safe. Keep your Quick VPN Username, Password, and Passkey safe. It is recommended that you change these credentials periodically.
- A device connected via Quick VPN tunnel may experience lower data throughput and higher latency due to a number of factors including: Internet conditions, local and remote network Wi-Fi and WAN bandwidth limitations, and increased latency. This may negatively impact real time voice and video communication.
- Quick VPN supports up to five concurrent VPN client sessions using the same login and password are supported. Quick VPN uses L2TP/IPsec with MSCHAPv2, PAP, or CHAP authentication.
- Your device may warn you that your information may be intercepted, since you control the Quick VPN server, you may ignore this.
- UDP Ports 500, 4500, 1701 and IP Port 50 must be open in order for Quick VPN to work.
- L2TP/IPsec VPN usage may be restricted in some countries and on some networks. If you have trouble using Quick VPN on some networks, but not others and are not violating network access rules, try contacting your ISP or network administrator.
- Devices connected via Quick VPN are assigned addresses on a separate subnet (ex. 192.168.1.x). Some network resources may be unavailable when connecting via Quick VPN.
- If your Internet connection uses DHCP, it is strongly recommended that you first set up Dynamic DNS (DDNS), such as D-Link DDNS, to eliminate the need to reconfigure client devices in the event your ISP assigns you a new WAN IP address.

Quick VPN Server Setup Instructions

Configure the following options:

L2TP over IPsec: Enable or disable the Quick VPN server.

If you enable **Quick VPN**, the following options are available:

Username: . Enter a username between 1 and 15 characters

Password: Enter a password between 1 and 15 characters.

PSK: Enter a passkey between 6 and 64 characters.

Save Configuration To Local Hard Drive: **For Apple iOS devices and OS X:** From a computer browser click this button to export a profile to simplify setup. E-mail this file as an attachment to your Apple mobile device or open the file in OS X.

Authentication Protocol: Choose the authentication protocol type: **MSCHAPv2**, **PAP**, or **CHAP**. **MSCHAPv2** is the default.

MPPE: Select the encryption cipher strength: **none**, **RC4-40**, or **RC4-128**. **RC4-128** is the default.

Click **Save** when you are done.

Click **Save** and proceed to client setup pages.

The screenshot displays the D-Link Quick VPN configuration interface. At the top, the D-Link logo and model information (DIR-895L HWv1 FW:1.12) are visible, along with navigation tabs for Home, Settings, Features, and Management. The main heading is 'Quick VPN', with a sub-description: 'Quickly and easily create a profile for secure remote access to a Local Area Network (LAN). This profile can be used to configure other devices to connect to your LAN via a secure VPN tunnel.' Below this, there is a 'Save' button. The configuration is organized into sections: 'Features >> Quick VPN' (with a 'Save' button), 'General', and 'Advanced'. In the 'General' section, 'L2TP over IPsec' is set to 'Enabled'. The 'Username' field contains 'VPN_Username', the 'Password' field contains 'A_Str0nG_P@ssW0rd!%', and the 'PSK' field contains 'A_Str0nG_P@ssK3y!%'. A 'Save Configuration To Local Hard Drive' button is located below these fields. In the 'Advanced' section, the 'Username' dropdown is set to 'MSCHAPv2' and the 'MPPE' dropdown is set to 'RC4-128'. A 'Save' button is also present at the bottom right of the 'Advanced' section. The footer of the page reads 'COPYRIGHT © 2016 D-Link'.

iOS Devices VPN Setup Instructions

This section provides Quick VPN setup instructions for iOS devices using the **Export Profile** function. Refer to **Quick VPN Server Setup Instructions** on page 172 for more information.

Open the e-mail containing your Quick VPN profile.

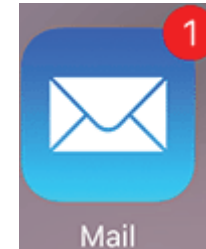

Open the attachment.

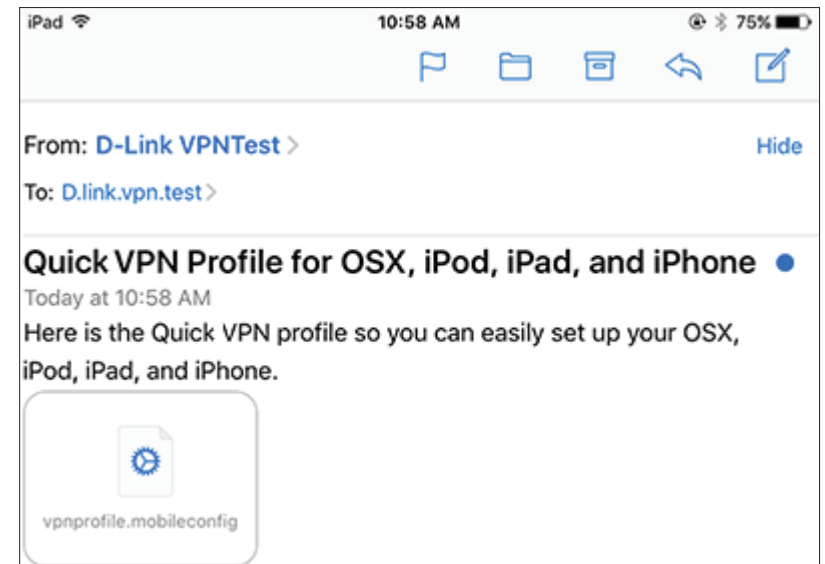

VPN Setup Instructions (Continued)

The Install Profile dialog will appear, tap **Install** in the upper right hand corner of your screen.

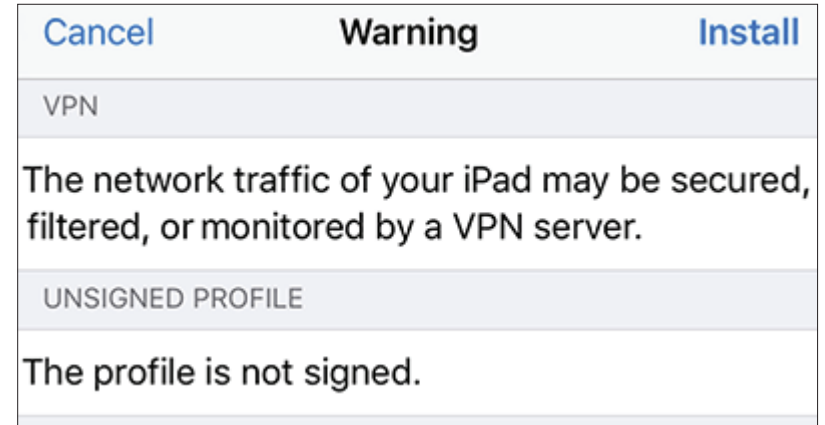

Enter your device's passcode when prompted.

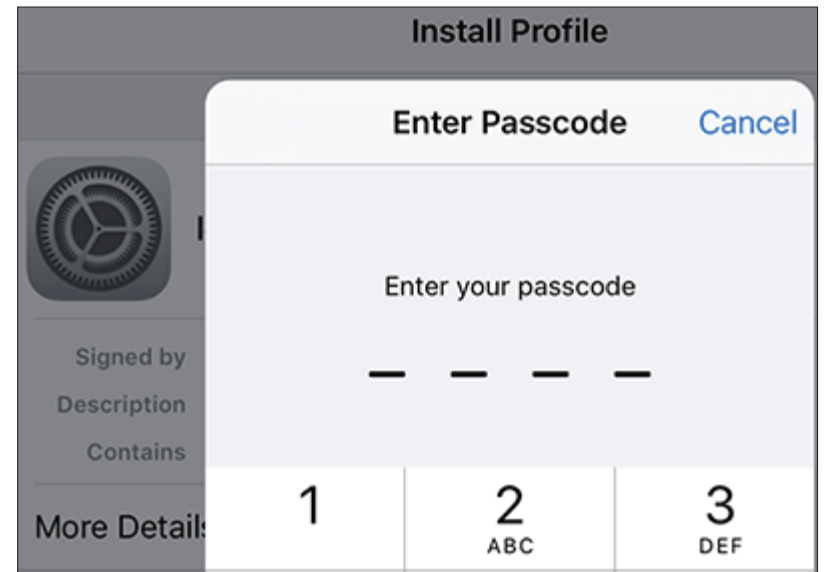

VPN Setup Instructions (Continued)

Acknowledge the disclaimer by tapping **Install** in the upper right hand corner. Tap the red **Install** button.

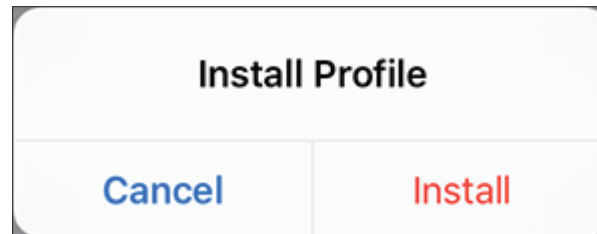

Enter the Shared Secret (**PSK**) from the Quick VPN configuration page. Tap **Done**.

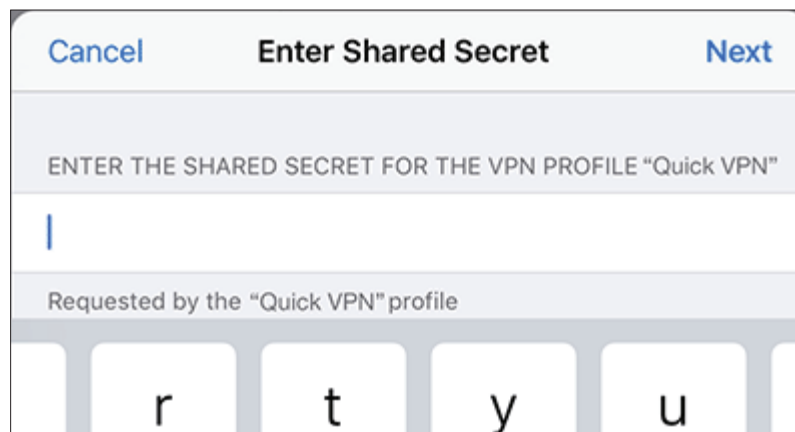

Your iOS device is now configured to connect to your Quick VPN server.

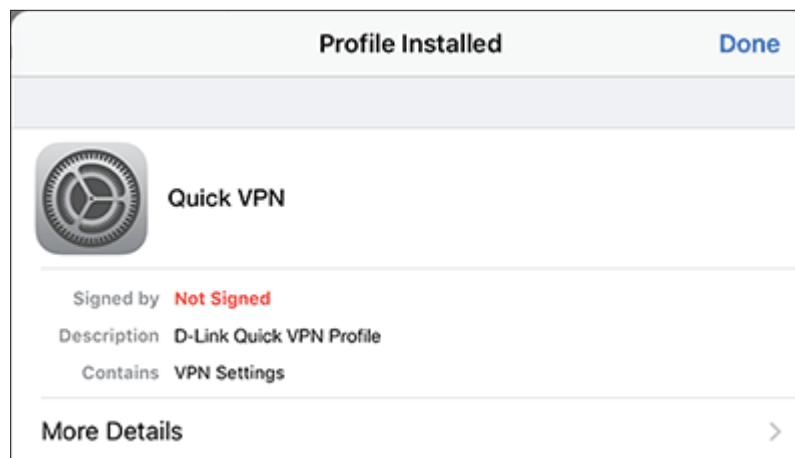

Connect or Disconnect

To connect or disconnect from to your Quick VPN server, open **Settings** and tap the button next to **VPN**.

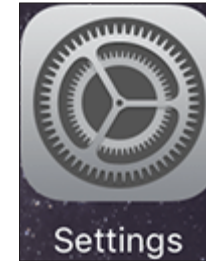

The VPN icon will appear in the notification area at the top of your screen indicating that your device is currently connected to the Quick VPN server.

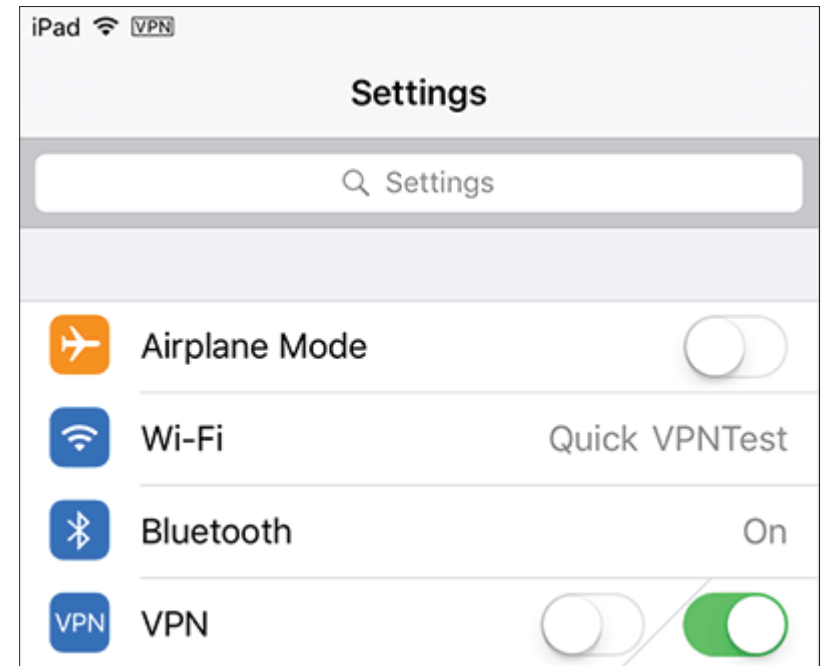

Mac OS X

VPN Setup Instructions

This section provides Quick VPN setup instructions for OS X using the **Export** Profile function. Refer to Quick VPN Server Setup Instructions on page 172 for more information.

Open the exported profile. The Install Profile dialog will appear; click **Continue** and **Install**.

Enter your user account password when prompted. Close the **Profiles** dialog.

Go to  > **System Preferences...** > **Network** and select the Quick VPN connection and click **Authentication Settings**.

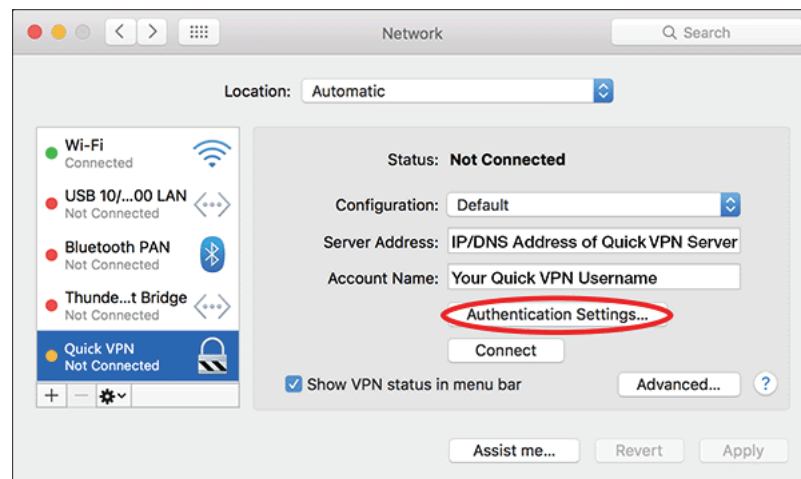
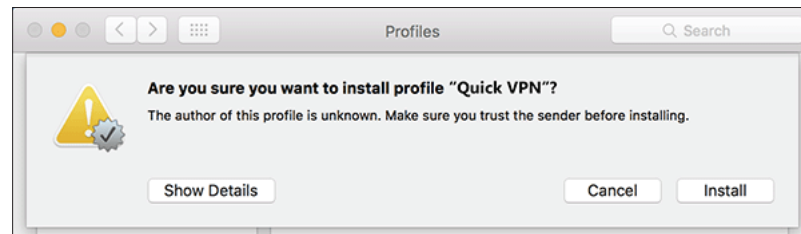

VPN Setup Instructions (Continued)

Enter your **Passkey** in the **Shared Secret** text box and click **OK, Apply**, then **OK**.

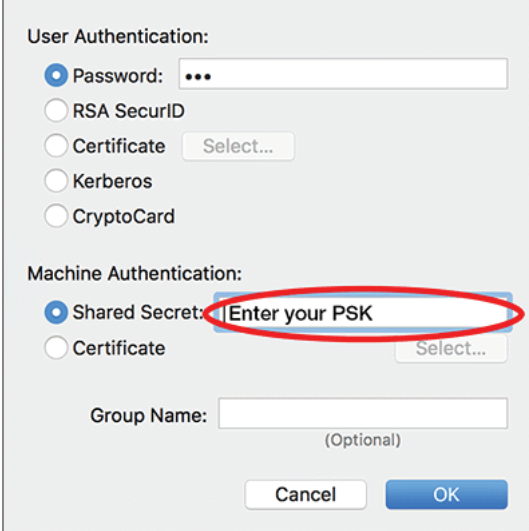

The screenshot shows a configuration window for VPN authentication. It is divided into two sections: 'User Authentication' and 'Machine Authentication'. In the 'User Authentication' section, the 'Password' option is selected with a radio button, and its text box contains three dots. Other options include 'RSA SecurID', 'Certificate' (with a 'Select...' button), 'Kerberos', and 'CryptoCard'. In the 'Machine Authentication' section, the 'Shared Secret' option is selected with a radio button, and its text box contains the text 'Enter your PSK', which is circled in red. Other options include 'Certificate' (with a 'Select...' button). Below these sections is a 'Group Name' text box with '(Optional)' written below it. At the bottom right are 'Cancel' and 'OK' buttons.

Your Mac is now configured to connect to your Quick VPN server.

Connect or Disconnect

To connect to or disconnect from your Quick VPN server, go to  > **System Preferences...** > **Network**.

Select the Quick VPN connection and click on the **Connect** or **Disconnect** button.

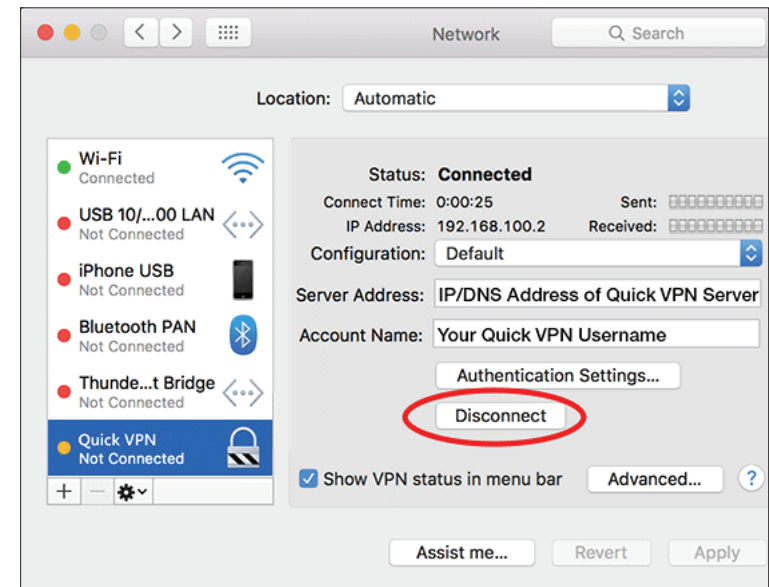
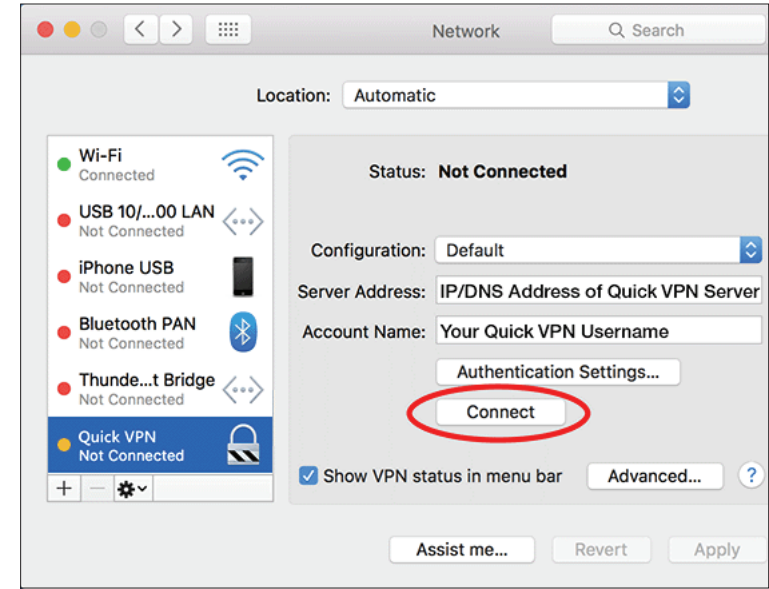

Windows 7

VPN Setup Instructions

Click the **Start** button and type **vpn** into the **Search programs and files** box.

Select **Set up a virtual private network (VPN) connection**.

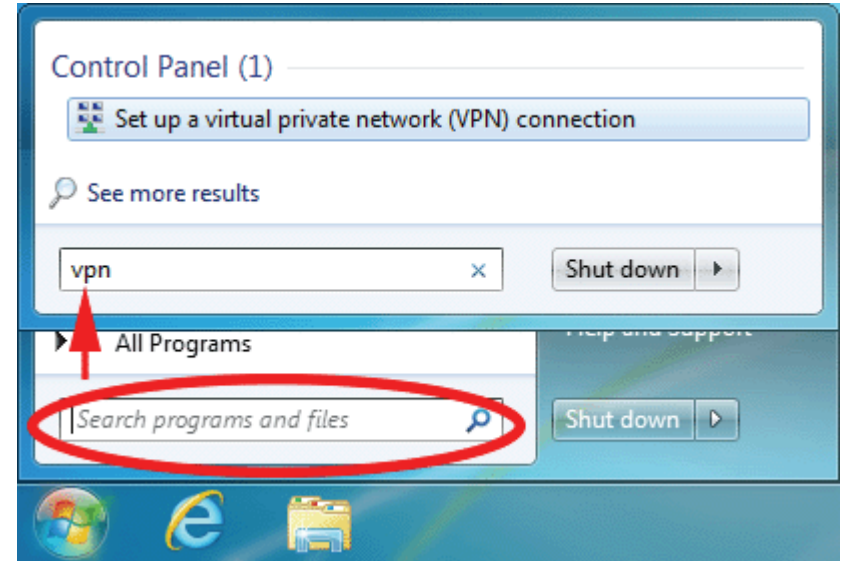

Enter the **IP/DDNS address** of your Quick VPN server in the **Internet address** box, create a name for your connection in the **Destination Name**, check **Don't Connect now; just set it up so I can connect later**, and click **Next**.

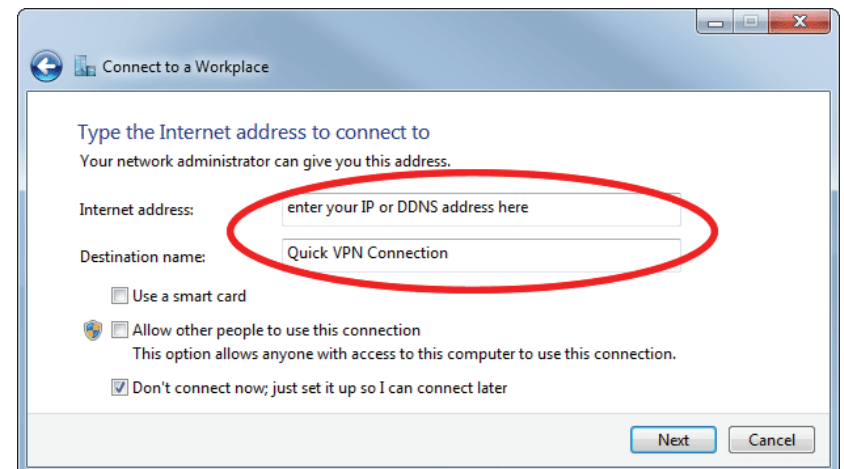

VPN Setup Instructions (Continued)

Enter your **Username**. If you would like windows to save your password, enter your **Password** and check **Remember this password**. Click **Create** to continue.

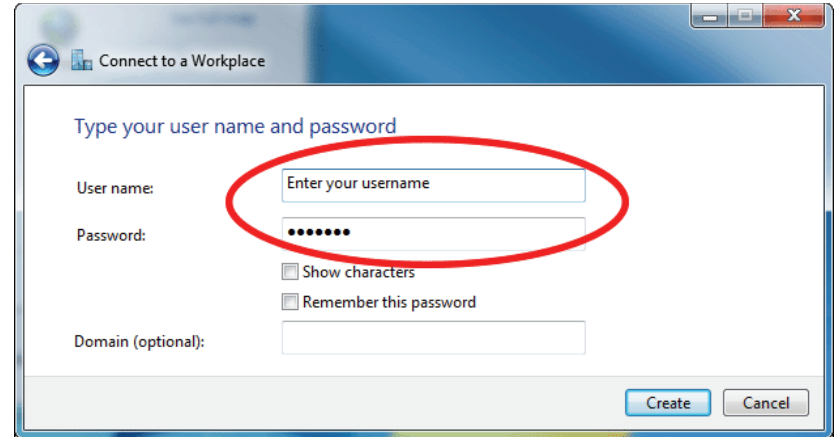

Connect to a Workplace

Type your user name and password

User name:

Password:

Show characters

Remember this password

Domain (optional):

Create Cancel

Do not click **Connect Now**.

Click **Close**. Click the **Start** button and type **view network connections** into the **Search programs and files** text box. Select **View network connections**.

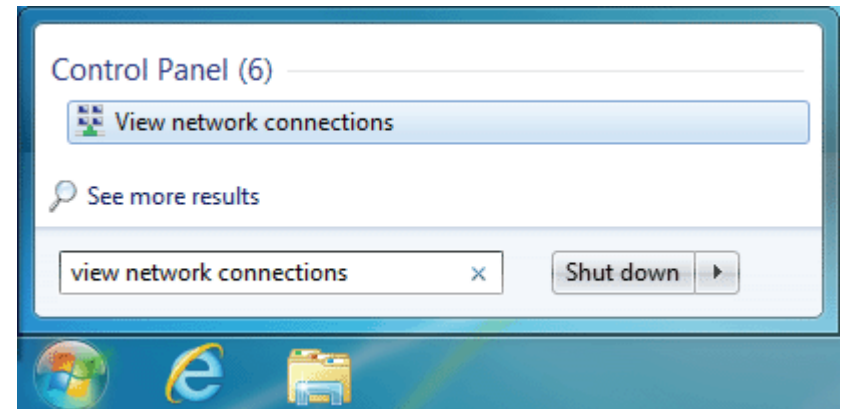

VPN Setup Instructions (Continued)

Click **Advanced settings**. Enter your **Passkey** in the **Key** text box under **Use preshared key for authentication**. Click **OK** to close **Advanced Properties** and click **OK** to close **Quick VPN Connection Properties**.

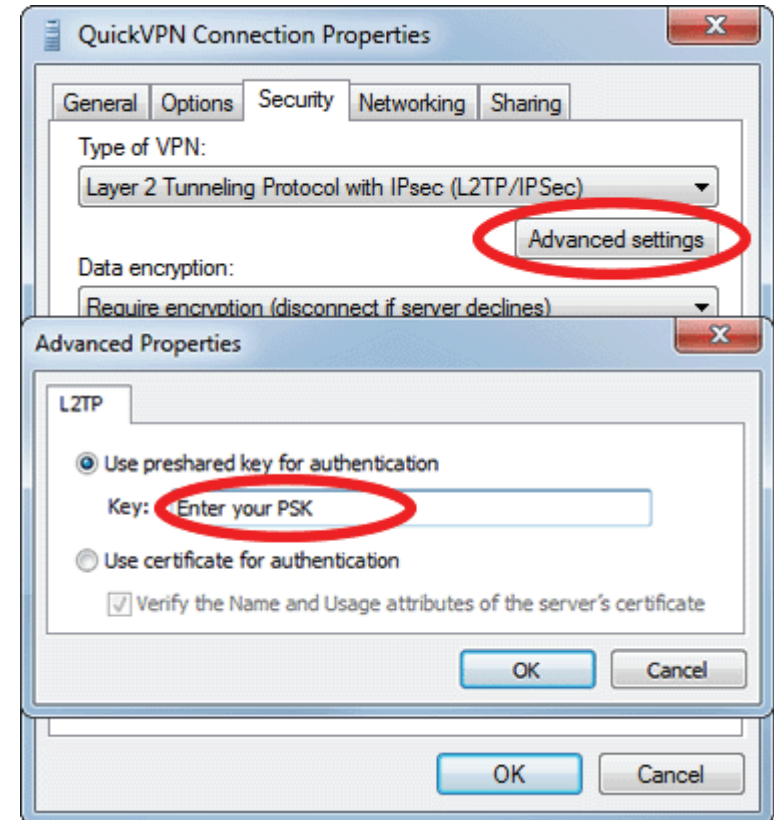

Your Windows 7 system is now configured to connect to your Quick VPN server.

Connect or Disconnect

To connect to or disconnect from your Quick VPN server, click on the **Network Settings** icon in the notification area of the Windows taskbar and from the **Dial Up and VPN** section click on your Quick VPN connection and click on the **Connect** or **Disconnect** button.



Windows 8.1/8

VPN Setup Instructions

This section provides Quick VPN setup instructions for Windows 8.1/8

Click the **Start** button and type **vpn**.

Select **Manage virtual private networks**.

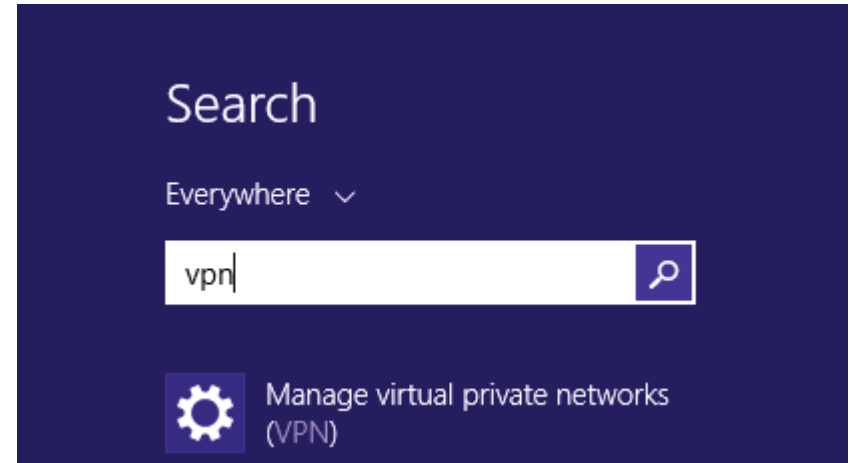

From the Network Settings page, click **Add a VPN Connection**.

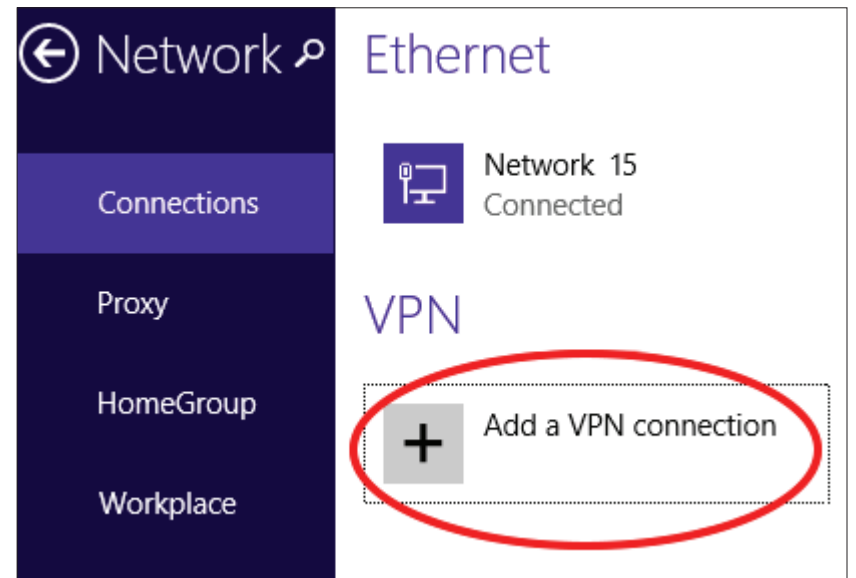

Add a VPN Connection

- 1 Select **Microsoft** from **VPN Provider**.
- 2 Create a name for your VPN connection.
- 3 Enter your **IP/DDNS address** of your Quick VPN server.
- 4 Select **User name and password** from **Type of sign-in info**.
- 5 If you would like windows to remember your sign-in information, enter your **User name, Password**, and select **Remember my sign-in info**
- 6 Choose **Save**.

The screenshot shows the 'Add a VPN connection' dialog box with the following fields and options:

- VPN provider:** A dropdown menu with 'Microsoft' selected. Step 1 points to this field.
- Connection name:** A text input field containing 'Quick VPN'. Step 2 points to this field.
- Server name or address:** A text input field containing 'IP/DDNS Address of Quick VPN Server'. Step 3 points to this field.
- Type of sign-in info:** A dropdown menu with 'User name and password' selected. Step 4 points to this field.
- User name (optional):** A text input field containing 'Username'. Step 5 points to this field.
- Password (optional):** A password input field with a masked password '.....' and a visibility toggle icon. Step 5 points to this field.
- Remember my sign-in info:** A checked checkbox. Step 5 points to this checkbox.
- Buttons:** 'Save' and 'Cancel' buttons. Step 6 points to the 'Save' button.

VPN Setup Instructions (Continued)

Right-click on the Quick VPN Connection you just created and left-click on **Properties**.

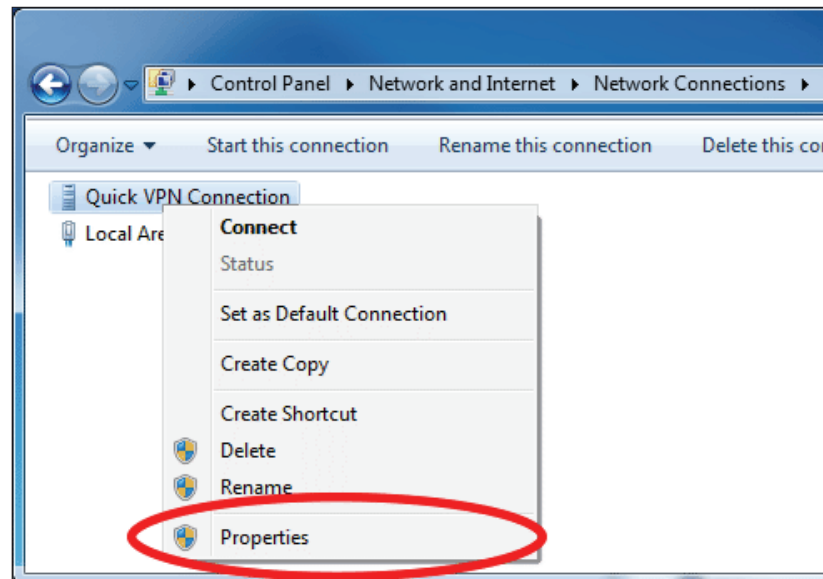

Select the **Security** tab. For the **Type of VPN**, select **Layer 2 Tunneling with IPsec (L2TP/IPSec)**.

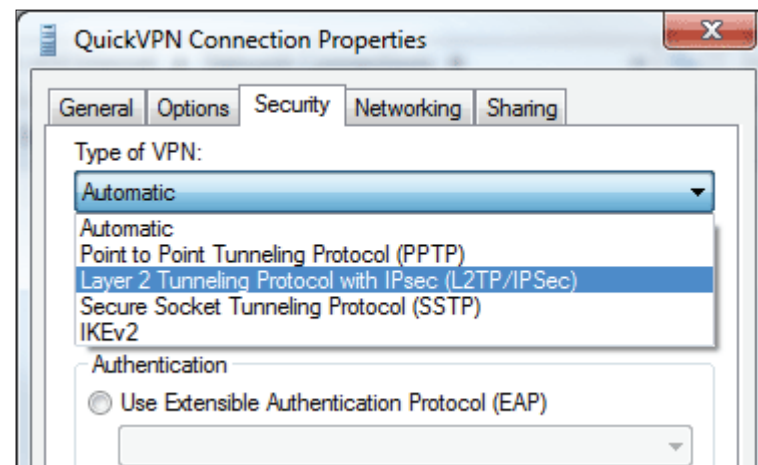

VPN Setup Instructions (Continued)

Click the **Start** button and type **view network connections**.

Select **View network connections**.

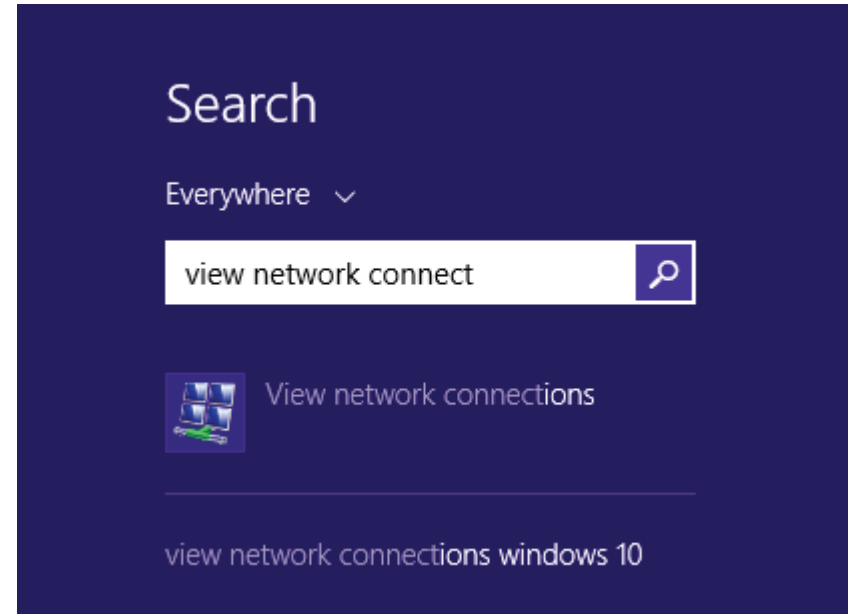

Right-click your **Quick VPN Connection** and left-click **Properties**.

Select the **Security** tab.

For the **Type of VPN**, select **Layer 2 Tunneling with IPsec (L2TP/IPSec)**.

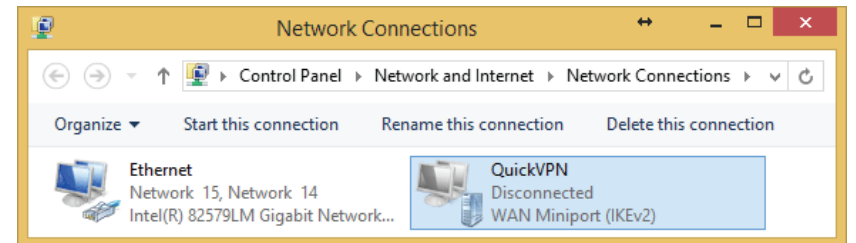

VPN Setup Instructions (Continued)

Click **Advanced settings**. Enter your **Passkey** in the **Key** text box under **Use preshared key for authentication**.

Click **OK** to close **Advanced Properties** and click **OK** to close **Quick VPN Properties**.

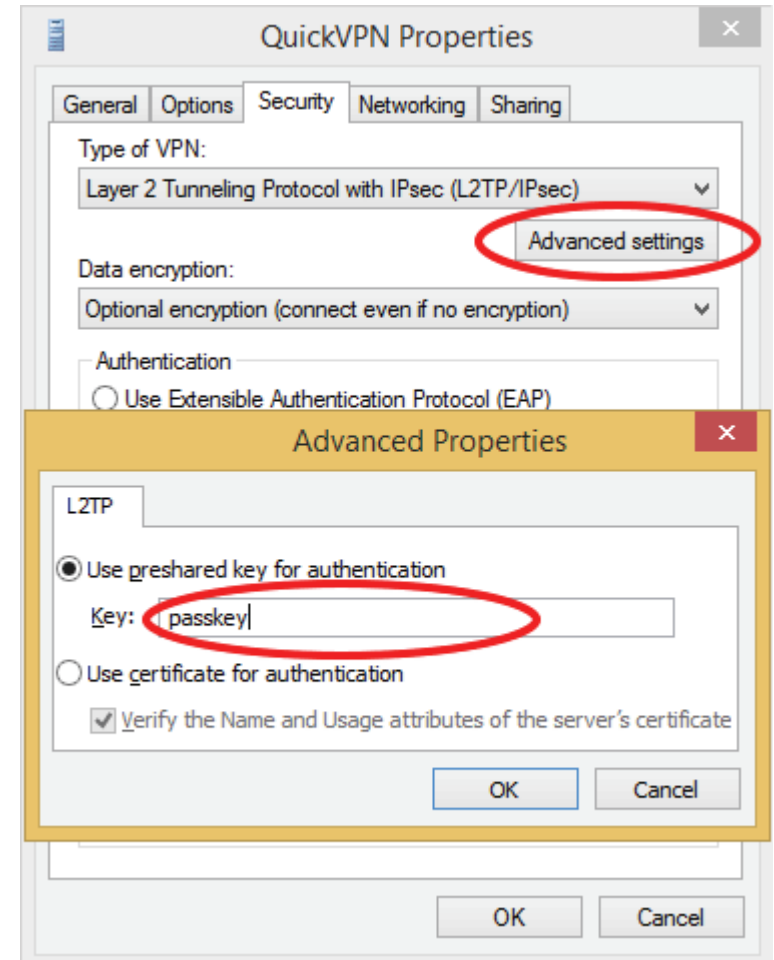

Your Windows 8.1/8 system is now configured to connect to your QuickVPN server.

Connect or Disconnect

To connect to or disconnect from your Quick VPN server, click on the **Network Settings** icon in the notification area of the Windows taskbar. Click on your Quick VPN connection and click on the **Connect** or **Disconnect** button.

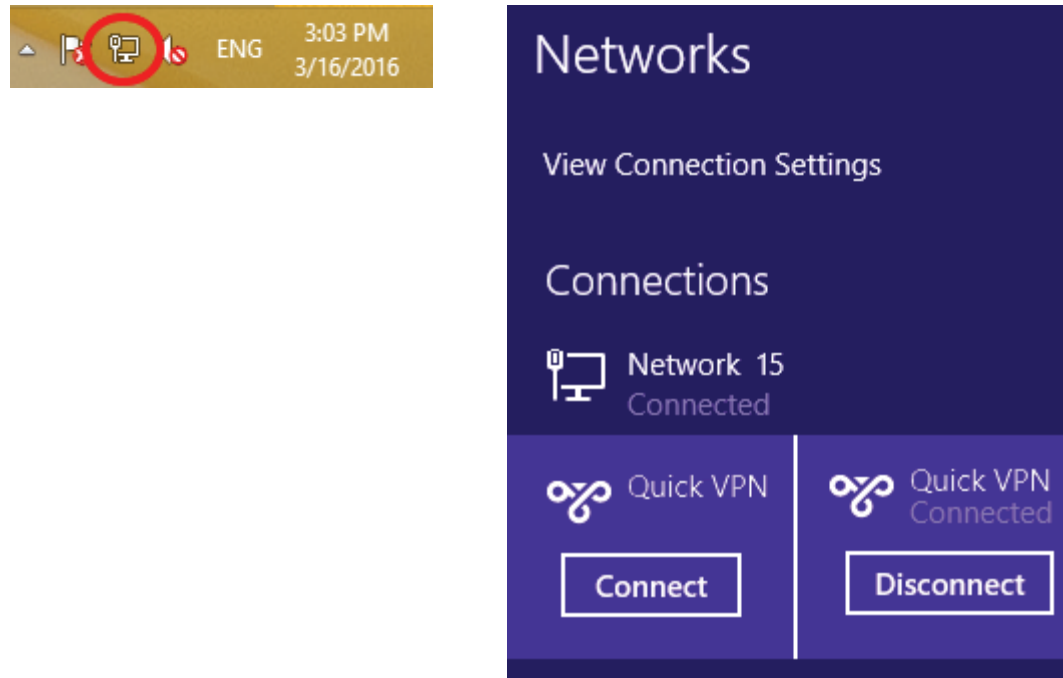

Windows 10 VPN Setup Instructions

This section provides Quick VPN setup instructions for Windows 10.

Click **Start > Settings > Network & Internet > Network and Sharing Center > VPN > Add a VPN Connection.**

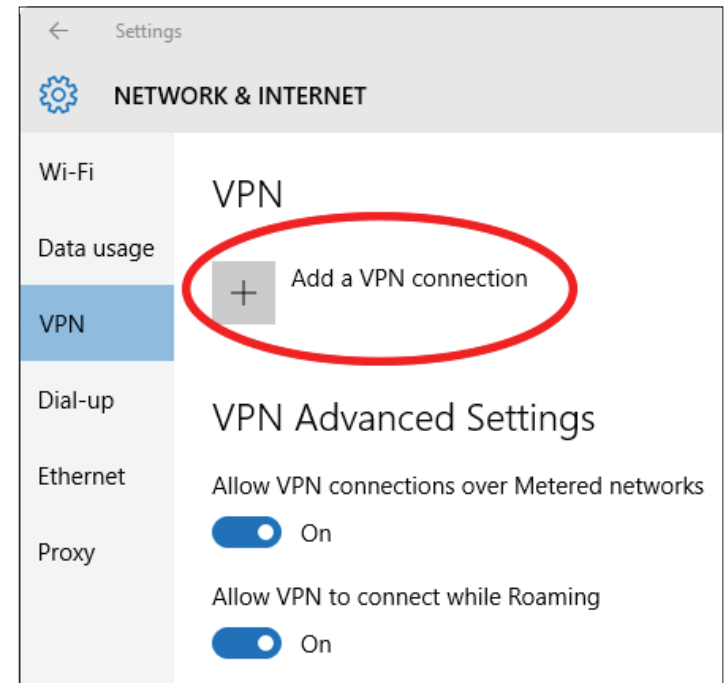
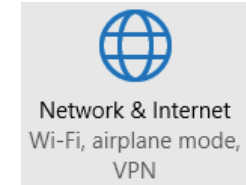
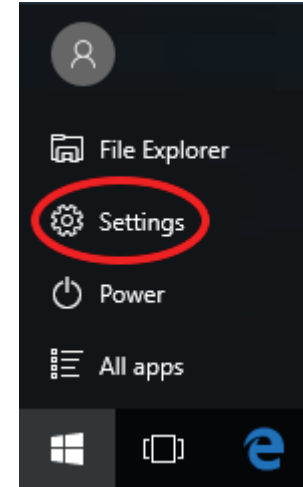

Add a VPN Connection

1 Select **Windows (built-in)** from the **VPN Provider** drop down menu.

2 Create a name for your VPN connection.

3 Enter your **IP/DDNS address** of your Quick VPN server.

4 Select **L2TP/IPSec with pre-shared key** from **VPN type**.

5 Enter the **Passkey**.

6 Select **User name and password** from **Type of sign-in info**.

If you would like windows to remember your sign-in information, enter your **User name, Password**, and select **Remember my sign-in info**

7 Choose **Save**.

Your Windows 10 system is now configured to connect to your Quick VPN server.

The screenshot shows the 'Add a VPN connection' dialog box in Windows. The fields are filled with the following information:

- VPN provider:** Windows (built-in)
- Connection name:** Quick VPN
- Server name or address:** IP/DDNS Address of Quick VPN Server
- VPN type:** L2TP/IPsec with pre-shared key
- Pre-shared key:** Passkey
- Type of sign-in info:** User name and password
- User name (optional):** Username
- Password (optional):** (represented by dots)
- Remember my sign-in info:** (checked)

At the bottom right, there are 'Save' and 'Cancel' buttons. A '7' in a circle is placed next to the 'Save' button.

Connect or Disconnect

To connect to or disconnect from your Quick VPN server, click on the **Network Settings** icon in the notification area of the Windows taskbar and click on your Quick VPN connection. The **Network & Internet** Settings page will open. Click on the **Connect** or **Disconnect** button.

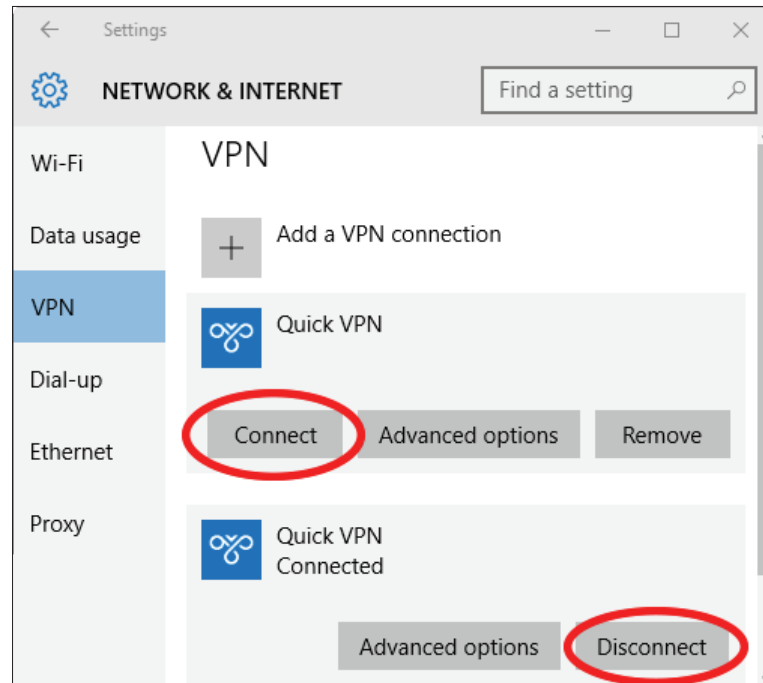
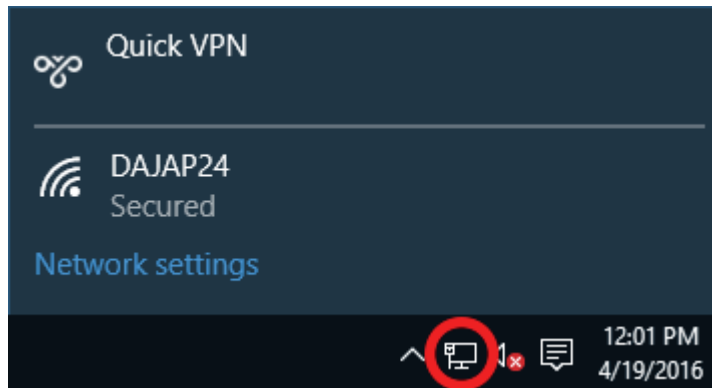

Android

VPN Setup Instructions

This section provides Quick VPN setup instructions for Android devices. Your device's screens may vary.

Go to **Settings** > **More** from the **Wireless & networks** > **VPN** > +

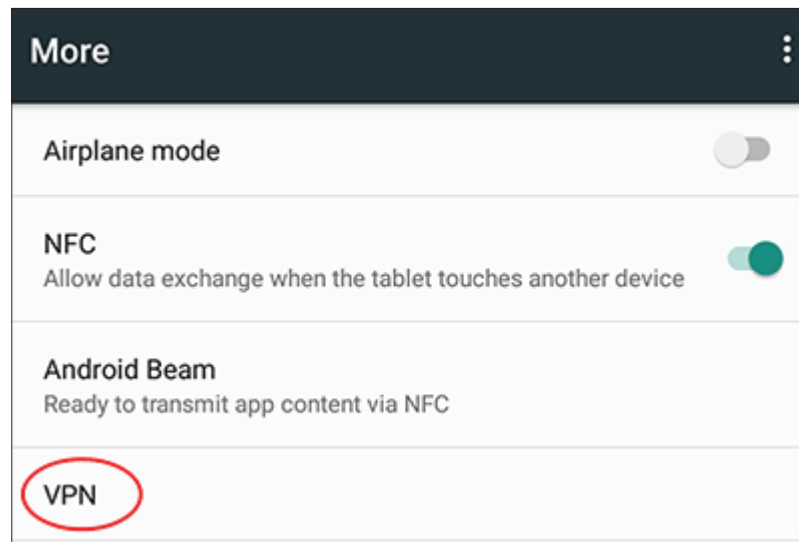
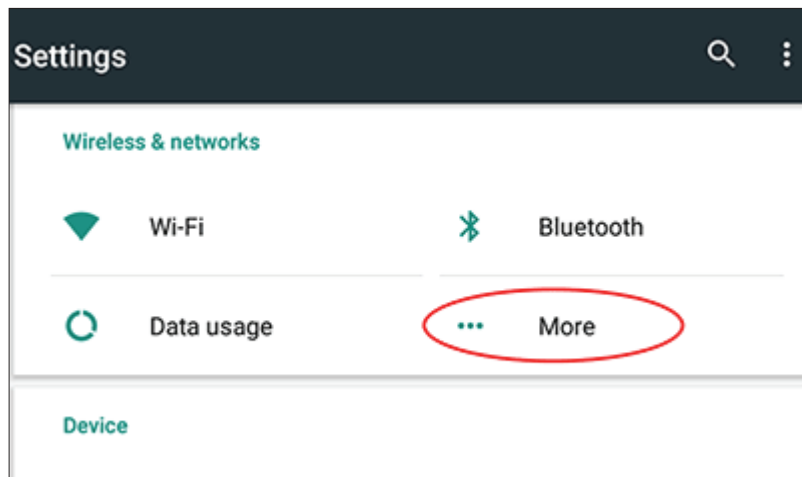

Edit VPN Profile

- 1 Enter a name for your VPN connection.
- 2 Select **L2TP/IPSec PSK** for **Type**.
- 3 Enter the **IP/DDNS address** of your Quick VPN server.
- 4 Enter your **Passkey** in **IPSec pre-shared key** field.
- 5 Choose **Save**.

Your Android device is now configured to connect to your Quick VPN server.

VPN

Edit VPN profile

Name
1 Quick VPN

Type
2 L2TP/IPSec PSK

Server address
3 Quick VPN IP/DDNS address

L2TP secret
(not used)

IPSec identifier
(not used)

IPSec pre-shared key
4

Show advanced options

5

CANCEL SAVE

Connect or Disconnect

To connect to or disconnect from your Quick VPN server, go to **Settings** > **More** from the **Wireless & networks** > **VPN** and select the **Quick VPN** connection you created.

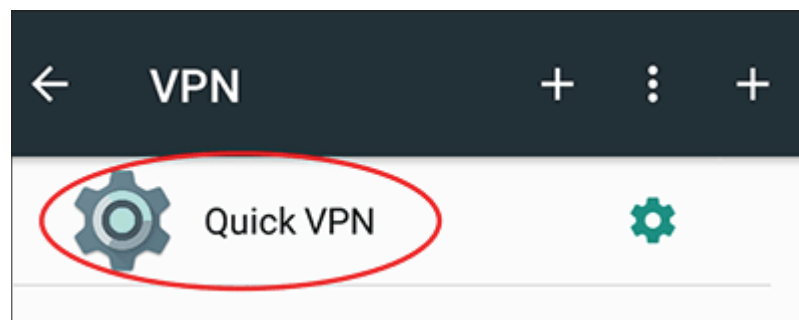
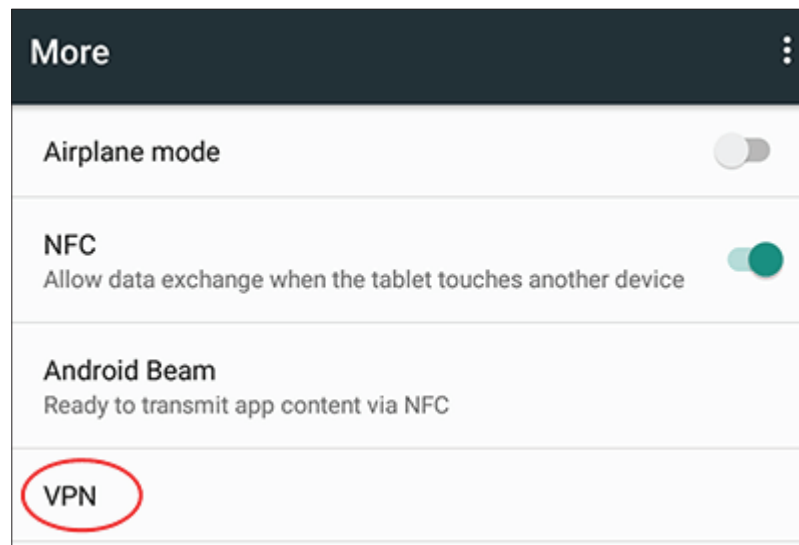
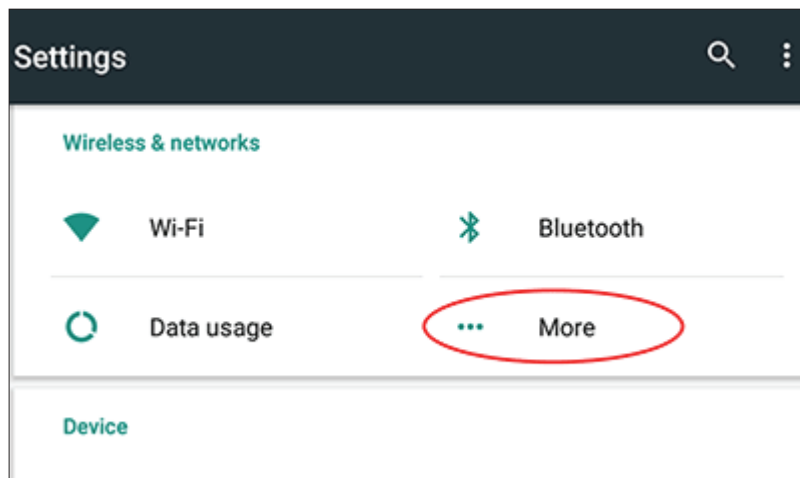

Connect or Disconnect (Continued)

To connect, enter your **Username** and **Password** and select **CONNECT**.

Connect to Quick VPN

Username
Your Quick VPN Username

Password
.....

Save account information

CANCEL **CONNECT**

To disconnect, select **DISCONNECT**.

VPN is connected

Session: **Quick VPN**
Duration: **00:00:09**
Sent: **97 bytes / 5 packets**
Received: **64 bytes / 4 packets**

DISCONNECT **CANCEL**

Connecting a Wireless Client to your Router

WPS Button

The easiest and most secure way to connect your wireless devices to the router is with WPS (Wi-Fi Protected Setup). Most wireless devices such as wireless adapters, media players, Blu-ray DVD players, wireless printers and cameras will have a WPS button (or a software utility with WPS) that you can press to connect to the DIR-895L router. Please refer to your user manual for the wireless device you want to connect to make sure you understand how to enable WPS. Once you know, follow the steps below:

Step 1 - Press the WPS button on the DIR-895L for about 1 second. The LED on the front will start to blink.



Step 2 - Within 2 minutes, press the WPS button on your wireless device (or launch the software utility and start the WPS process).

Step 3 - Allow up to 1 minute for your connection to be configured. Once the Internet light stops blinking, you will be connected and your wireless connection will be secure with WPA2.

Windows® 10

When connecting to the DIR-895L wirelessly for the first time, you will need to input the wireless network name (SSID) and Wi-Fi password (security key) of the device you are connecting to. If your product has a Wi-Fi configuration card, you can find the default network name and Wi-Fi password here. Otherwise refer to the product label for the default Wi-Fi network SSID and password, or enter the Wi-Fi credentials set during the product configuration.

To join an existing network, locate the wireless network icon in the taskbar, next to the time display, and click on it.



Wireless Icon

Clicking on this icon will display a list of wireless networks which are within range of your computer. Select the desired network by clicking on the SSID.



To connect to the SSID, click **Connect**.

To automatically connect to the router when your device detects the SSID, click the **Connect Automatically** check box.

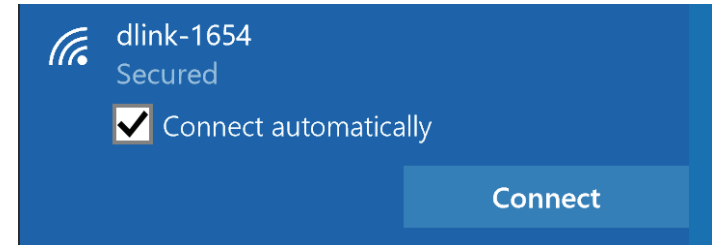

You will then be prompted to enter the Wi-Fi password (network security key) for the wireless network. Enter the password into the box and click **Next** to connect to the network. Your computer will now automatically connect to this wireless network when it is detected.

You can also use Wi-Fi Protected Setup (WPS) to connect to the router. Press the WPS button on your D-Link device and you will be automatically connected.

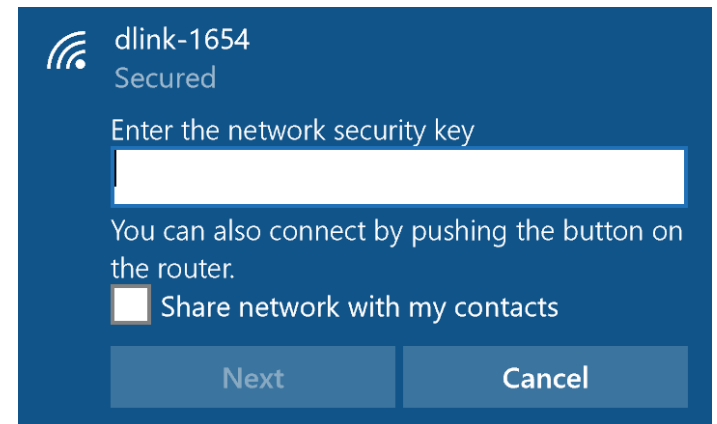

Windows® 8

WPA/WPA2

It is recommended that you enable wireless security (WPA/WPA2) on your wireless router or access point before configuring your wireless adapter. If you are joining an existing network, you will need to know the security key (Wi-Fi password) being used.

To join an existing network, locate the wireless network icon in the taskbar next to the time display.



Wireless Icon

Clicking on this icon will display a list of wireless networks that are within connecting proximity of your computer. Select the desired network by clicking on the network name.

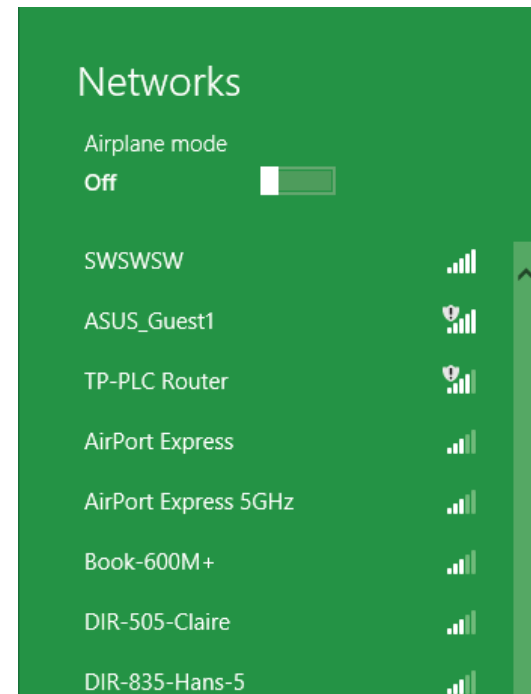

You will then be prompted to enter the network security key (Wi-Fi password) for the wireless network. Enter the password into the box and click **Next**.

If you wish to use Wi-Fi Protected Setup (WPS) to connect to the router, you can also press the WPS button on your router during this step to enable the WPS function.

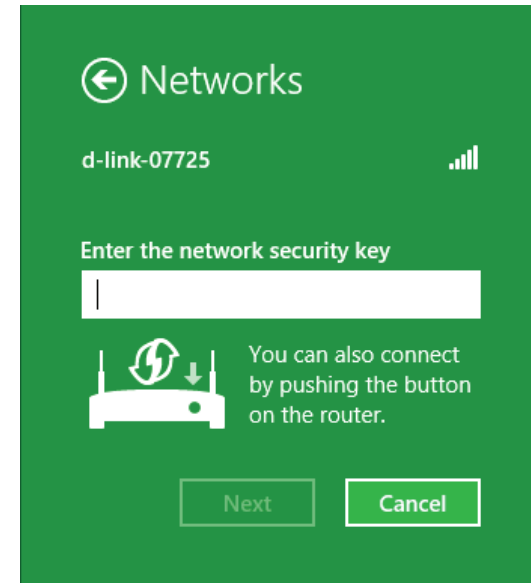

When you have established a successful connection to a wireless network, the word **Connected** will appear next to the name of the network to which you are connected to.

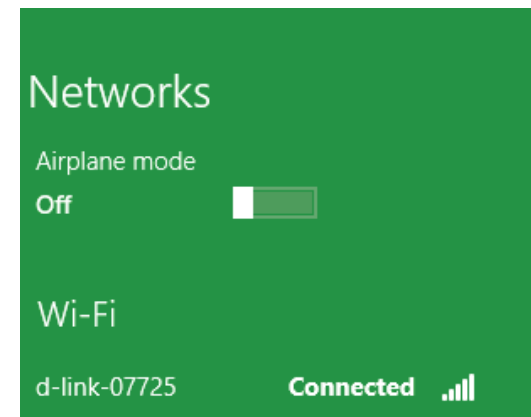

Windows® 7

WPA/WPA2

It is recommended that you enable wireless security (WPA/WPA2) on your wireless router or access point before configuring your wireless adapter. If you are joining an existing network, you will need to know the security key or passphrase being used.

Click on the wireless icon in your system tray (lower-right corner).

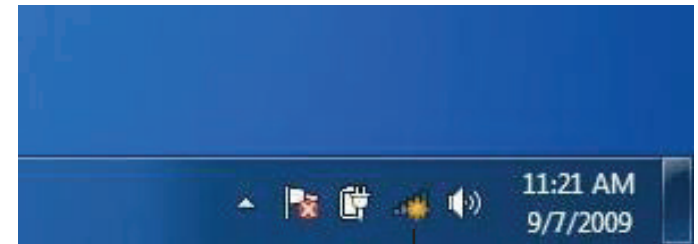

Wireless Icon

The utility will display any available wireless networks in your area.



Highlight the wireless connection with Wi-Fi name (SSID) you would like to connect to and click the **Connect** button.

If you get a good signal but cannot access the Internet, check your TCP/IP settings for your wireless adapter. Refer to the Networking Basics section in this manual for more information.



The following window appears while your computer tries to connect to the router.

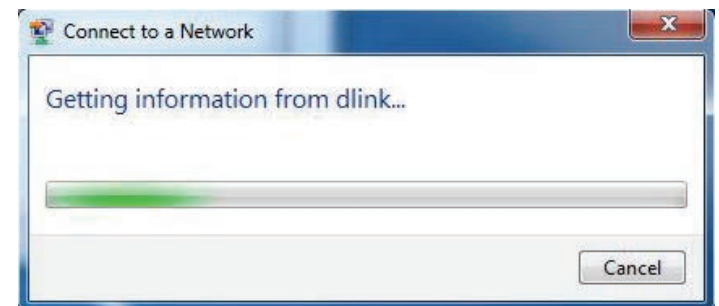

Enter the same security key or passphrase (Wi-Fi password) that is on your router and click **Connect**. You can also connect by pushing the WPS button on the router.

It may take 20-30 seconds to connect to the wireless network. If the connection fails, please verify that the security settings are correct. The key or passphrase must be exactly the same as the one on the wireless router.



Windows Vista®

Windows Vista® users may use the built-in wireless utility. If you are using another company's wireless utility, please refer to the user manual of your wireless adapter for help connecting to a wireless network. Most wireless utilities will have a "site survey" option similar to the Windows Vista® utility as seen below.

If you receive the **Wireless Networks Detected** bubble, click on the center of the bubble to access the utility.

or

Right-click on the wireless computer icon in your system tray (lower-right corner next to the time). Select **Connect to a network**.

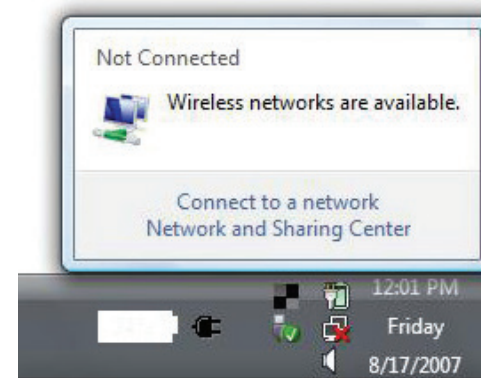

The utility will display any available wireless networks in your area. Click on a network (displayed using the SSID) and click the **Connect** button.

If you get a good signal but cannot access the Internet, check you TCP/IP settings for your wireless adapter. Refer to the **Networking Basics** section in this manual for more information.

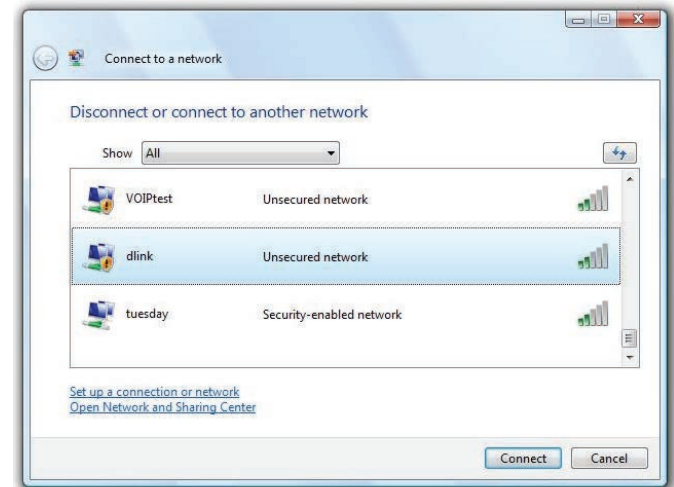

WPA/WPA2

It is recommended that you enable wireless security (WPA/WPA2) on your wireless router or access point before configuring your wireless adapter. If you are joining an existing network, you will need to know the security key or passphrase being used.

Open the Windows Vista® Wireless Utility by right-clicking on the wireless computer icon in your system tray (lower right corner of screen). Select **Connect to a network**.

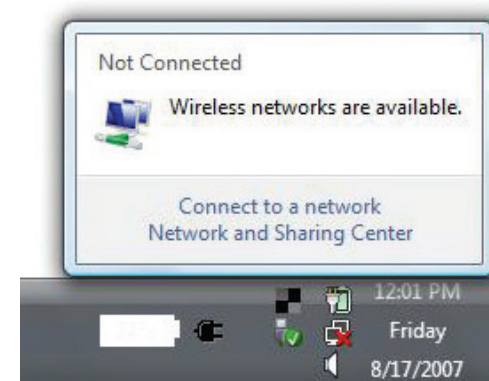

Highlight the Wi-Fi name (SSID) you would like to connect to and click **Connect**.

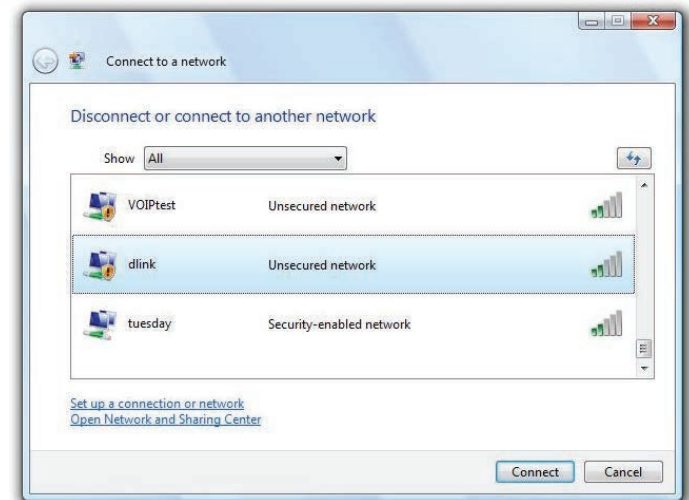

Enter the same security key or passphrase (Wi-Fi password) that is on your router and click **Connect**.

It may take 20-30 seconds to connect to the wireless network. If the connection fails, please verify that the security settings are correct. The key or passphrase must be exactly the same as the one on the wireless router.



Troubleshooting

This chapter provides solutions to problems that can occur during the installation and operation of the DIR-895L. Read the following descriptions if you are having problems. The examples below are illustrated in Windows® XP. If you have a different operating system, the screenshots on your computer will look similar to these examples.

Why can't I access the web-based configuration utility?

When entering the IP address of the D-Link router (**192.168.0.1** for example), you are not connecting to a website, nor do you have to be connected to the Internet. The device has the utility built-in to a ROM chip in the device itself. Your computer must be on the same IP subnet to connect to the web-based utility.

- Make sure you have an updated Java-enabled web browser. We recommend the following:
 - Microsoft Internet Explorer® 10 or higher
 - Mozilla Firefox 28 or higher
 - Google™ Chrome 28 or higher
 - Apple Safari 6 or higher

- Verify physical connectivity by checking for solid link lights on the device. If you do not get a solid link light, try using a different cable, or connect to a different port on the device if possible. If the computer is turned off, the link light may not be on.

- Disable any Internet security software running on the computer. Software firewalls such as ZoneAlarm, BlackICE, Sygate, Norton Personal Firewall, and Windows® XP firewall may block access to the configuration pages. Check the help files included with your firewall software for more information on disabling or configuring it.

- Configure your Internet settings:

- Go to **Start > Settings > Control Panel**. Double-click the **Internet Options** icon. From the **Security** tab, click the button to restore the settings to their defaults.

- Click the **Connection** tab and set the dial-up option to Never Dial a Connection. Click the LAN Settings button. Make sure nothing is checked. Click **OK**.

- Go to the **Advanced** tab and click the button to restore these settings to their defaults. Click **OK** three times.

- Close your web browser (if open) and open it.

- Access the web management. Open your web browser and enter the IP address of your D-Link router in the address bar. This should open the login page for your web management.

- If you still cannot access the configuration, unplug the power to the router for 10 seconds and plug back in. Wait about 30 seconds and try accessing the configuration. If you have multiple computers, try connecting using a different computer.

What can I do if I forgot my password?

If you forgot your password, you must reset your router. This process will change all your settings back to the factory defaults.

To reset the router, locate the reset button (hole) on the rear panel of the unit. With the router powered on, use a paperclip to hold the button down for 10 seconds. Release the button and the router will go through its reboot process. Wait about 30 seconds to access the router. The default IP address is **192.168.0.1**. When logging in, leave the password box empty.

Why can't I connect to certain sites or send and receive emails when connecting through my router?

If you are having a problem sending or receiving email, or connecting to secure sites such as eBay, banking sites, and Hotmail, we suggest lowering the MTU in increments of ten (Ex. 1492, 1482, 1472, etc).

To find the proper MTU Size, you'll have to do a special ping of the destination you're trying to go to. A destination could be another computer, or a URL.

- Click on **Start** and then click **Run**.
- Windows® 95, 98, and Me users type in **command** (Windows® NT, 2000, XP, Vista®, and 7 users type in **cmd**) and press **Enter** (or click **OK**).
- Once the window opens, you'll need to do a special ping. Use the following syntax:

ping [url] [-f] [-l] [MTU value]

Example: **ping yahoo.com -f -l 1472**

```
C:\>ping yahoo.com -f -l 1482
Pinging yahoo.com [66.94.234.13] with 1482 bytes of data:
Packet needs to be fragmented but DF set.
Packet needs to be fragmented but DF set.
Packet needs to be fragmented but DF set.
Packet needs to be fragmented but DF set.
Ping statistics for 66.94.234.13:
    Packets: Sent = 4, Received = 0, Lost = 4 (100% loss),
    Approximate round trip times in milli-seconds:
        Minimum = 0ms, Maximum = 0ms, Average = 0ms
C:\>ping yahoo.com -f -l 1472
Pinging yahoo.com [66.94.234.13] with 1472 bytes of data:
Reply from 66.94.234.13: bytes=1472 time=93ms TTL=52
Reply from 66.94.234.13: bytes=1472 time=109ms TTL=52
Reply from 66.94.234.13: bytes=1472 time=125ms TTL=52
Reply from 66.94.234.13: bytes=1472 time=203ms TTL=52
Ping statistics for 66.94.234.13:
    Packets: Sent = 4, Received = 4, Lost = 0 (0% loss),
    Approximate round trip times in milli-seconds:
        Minimum = 93ms, Maximum = 203ms, Average = 132ms
C:\>
```

You should start at 1472 and work your way down by 10 each time. Once you get a reply, go up by 2 until you get a fragmented packet. Take that value and add 28 to the value to account for the various TCP/IP headers. For example, lets say that 1452 was the proper value, the actual MTU size would be 1480, which is the optimum for the network we're working with ($1452+28=1480$).

Once you find your MTU, you can now configure your router with the proper MTU size.

To change the MTU rate on your router follow the steps below:

- Open your browser, enter the IP address of your router (192.168.0.1) and click **OK**.
- Enter your username (admin) and password (sometimes blank by default). Click **OK** to enter the web configuration page for the device.
- Click on **Setup** and then click **Manual Configure**.
- To change the MTU, enter the number in the MTU field and click **Save Settings** to save your settings.
- Test your email. If changing the MTU does not resolve the problem, continue changing the MTU in increments of ten.

Wireless Basics

D-Link wireless products are based on industry standards to provide easy-to-use and compatible high-speed wireless connectivity within your home, business, or on public access wireless networks. Strictly adhering to the IEEE standard, the D-Link wireless family of products will allow you to securely access the data you want, when, and where you want it. You will be able to enjoy the freedom that wireless networking delivers.

A wireless local area network (WLAN) is a cellular computer network that transmits and receives data with radio signals instead of wires. Wireless LANs are used increasingly in both home and office environments, and public areas such as airports, coffee shops and universities. Innovative ways to utilize WLAN technology are helping people work, and communicate more efficiently. Increased mobility and the absence of cabling and other fixed infrastructure have proven to be beneficial for many users.

Wireless users can use the same applications they use on a wired network. Wireless adapter cards used on laptop and desktop systems support the same protocols as Ethernet adapter cards.

Under many circumstances, it may be desirable for mobile network devices to link to a conventional Ethernet LAN in order to use servers, printers or an Internet connection supplied through the wired LAN. A wireless router is a device used to provide this link.

What is Wireless?

Wireless or Wi-Fi technology is another way of connecting your computer to the network without using wires. Wi-Fi uses radio frequency to connect wirelessly so you have the freedom to connect computers anywhere in your home or office network.

Why D-Link Wireless?

D-Link is the worldwide leader and award winning designer, developer, and manufacturer of networking products. D-Link delivers the performance you need at a price you can afford. D-Link has all the products you need to build your network.

How does wireless work?

Wireless works similarly to how cordless phones work, through radio signals that transmit data from one point A to point B. But wireless technology has restrictions as to how you can access the network. You must be within the wireless network range area to be able to connect your computer. There are two different types of wireless networks: Wireless Local Area Network (WLAN), and Wireless Personal Area Network (WPAN).

Wireless Local Area Network (WLAN)

In a wireless local area network, a device called an Access Point (AP) connects computers to the network. The access point has a small antenna attached to it, which allows it to transmit data back and forth over radio signals. With an indoor access point the signal can travel up to 300 feet. With an outdoor access point the signal can reach out up to 30 miles to serve places like manufacturing plants, industrial locations, university and high school campuses, airports, golf courses, and many other outdoor venues.

Wireless Personal Area Network (WPAN)

Bluetooth is the industry standard wireless technology used for WPAN. Bluetooth devices in WPAN operate in a range up to 30 feet away.

Compared to WLAN the speed and wireless operation range are both less than WLAN, but in return it doesn't use nearly as much power. This makes

it ideal for personal devices, such as mobile phones, PDAs, headphones, laptops, speakers, and other devices that operate on batteries.

Who uses wireless?

Wireless technology as become so popular in recent years that almost everyone is using it, whether it's for home, office, business, D-Link has a wireless solution for it.

Home Uses/Benefits

- Gives everyone at home broadband access
- Surf the web, check email, instant message, etc.
- Gets rid of the cables around the house
- Simple and easy to use

Small Office and Home Office Uses/Benefits

- Stay on top of everything at home as you would at office
- Remotely access your office network from home
- Share Internet connection and printer with multiple computers
- No need to dedicate office space

Where is wireless used?

Wireless technology is expanding everywhere, not just at home or office. People like the freedom of mobility and it's becoming so popular that more and more public facilities now provide wireless access to attract people. The wireless connection in public places is usually called "hotspots".

Using a D-Link USB adapter with your laptop, you can access the hotspot to connect to the Internet from remote locations like: airports, hotels, coffee shops, libraries, restaurants, and convention centers.

Wireless network is easy to setup, but if you're installing it for the first time it could be quite a task not knowing where to start. That's why we've put together a few setup steps and tips to help you through the process of setting up a wireless network.

Tips

Here are a few things to keep in mind, when you install a wireless network.

Centralize your router or access point

Make sure you place the router/access point in a centralized location within your network for the best performance. Try to place the router/access point as high as possible in the room, so the signal gets dispersed throughout your home. If you have a two-story home, you may need a repeater to boost the signal to extend the range.

Eliminate Interference

Place home appliances such as cordless telephones, microwaves, and televisions as far away as possible from the router/access point. This would significantly reduce any interference that the appliances might cause since they operate on same frequency.

Security

Don't let your next-door neighbors or intruders connect to your wireless network. Secure your wireless network by turning on the WPA or WEP security feature on the router. Refer to the product manual for detail information on how to set it up.

Wireless Modes

There are basically two modes of networking:

- **Infrastructure** – All wireless clients will connect to an access point or wireless router.

- **Ad-hoc** – Directly connecting to another computer for peer-to-peer communication using wireless network adapters on each computer, such as two or more DIR-895L wireless network USB adapters.

An Infrastructure network contains an access point or wireless router. All the wireless devices, or clients, will connect to the wireless router or access point.

An Ad-hoc network contains only clients, such as laptops with wireless USB adapters. All the adapters must be in Ad-hoc mode to communicate.

Networking Basics

Check your IP address

After you install your new D-Link adapter, by default, the TCP/IP settings should be set to obtain an IP address from a DHCP server (i.e. wireless router) automatically. To verify your IP address, please follow the steps below.

Click on **Start > Run**. In the run box type **cmd** and click **OK**. (Windows® 7/Vista® users type **cmd** in the **Start Search** box.)

At the prompt, type **ipconfig** and press **Enter**.

This will display the IP address, subnet mask, and the default gateway of your adapter.

If the address is 0.0.0.0, check your adapter installation, security settings, and the settings on your router. Some firewall software programs may block a DHCP request on newly installed adapters.

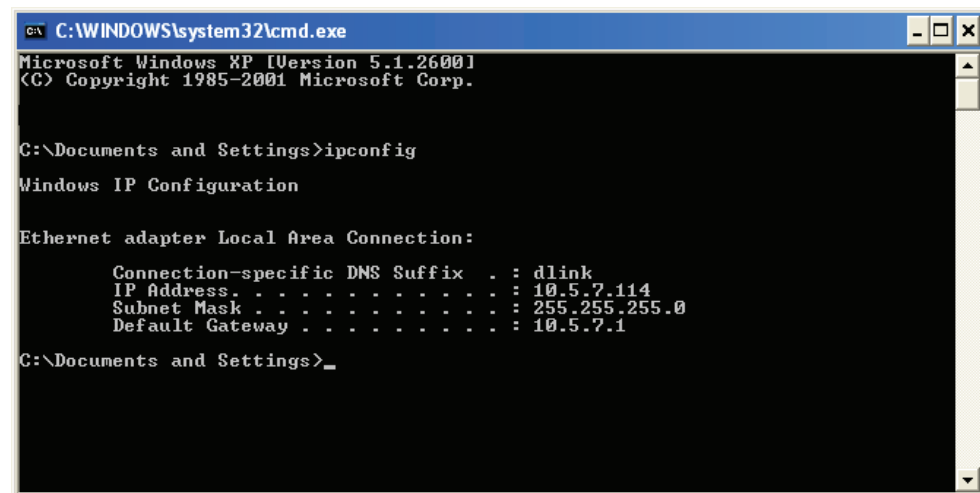

```
C:\WINDOWS\system32\cmd.exe
Microsoft Windows XP [Version 5.1.2600]
(C) Copyright 1985-2001 Microsoft Corp.

C:\Documents and Settings>ipconfig

Windows IP Configuration

Ethernet adapter Local Area Connection:

    Connection-specific DNS Suffix  . : dlink
    IP Address . . . . . : 10.5.7.114
    Subnet Mask . . . . . : 255.255.255.0
    Default Gateway . . . . . : 10.5.7.1

C:\Documents and Settings>_
```

Statically Assign an IP address

If you are not using a DHCP capable gateway/router, or you need to assign a static IP address, please follow the steps below:

Step 1

Windows® 7 - Click on **Start > Control Panel > Network and Internet > Network and Sharing Center**.

Windows Vista® - Click on **Start > Control Panel > Network and Internet > Network and Sharing Center > Manage Network Connections**.

Windows® XP - Click on **Start > Control Panel > Network Connections**.

Windows® 2000 - From the desktop, right-click **My Network Places > Properties**.

Step 2

Right-click on the **Local Area Connection** which represents your network adapter and select **Properties**.

Step 3

Highlight **Internet Protocol (TCP/IP)** and click **Properties**.

Step 4

Click **Use the following IP address** and enter an IP address that is on the same subnet as your network or the LAN IP address on your router.

Example: If the router's LAN IP address is 192.168.0.1, make your IP address 192.168.0.X where X is a number between 2 and 99. Make sure that the number you choose is not in use on the network. Set the Default Gateway the same as the LAN IP address of your router (I.E. 192.168.0.1).

Set Primary DNS the same as the LAN IP address of your router (192.168.0.1). The Secondary DNS is not needed or you may enter a DNS server from your ISP.

Step 5

Click **OK** twice to save your settings.

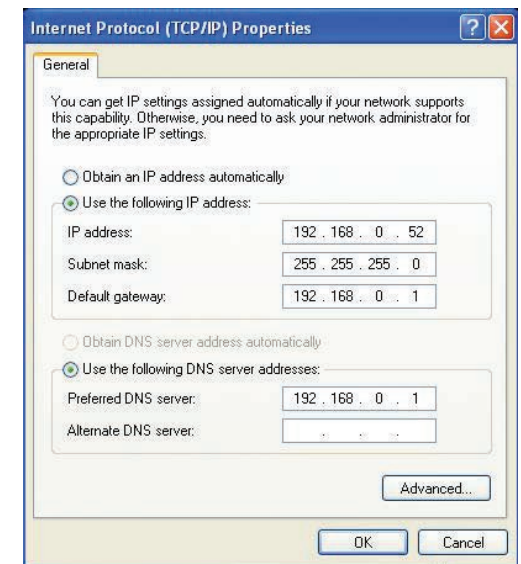

Wireless Security

This section will show you the different levels of security you can use to protect your data from intruders. The DIR-895L offers the following types of security:

- WPA2 (Wi-Fi Protected Access 2)
- WPA (Wi-Fi Protected Access)
- WPA2-PSK (Pre-Shared Key)
- WPA-PSK (Pre-Shared Key)

What is WPA?

WPA (Wi-Fi Protected Access), is a Wi-Fi standard that was designed to improve the security features of WEP (Wired Equivalent Privacy).

The 2 major improvements over WEP:

- Improved data encryption through the Temporal Key Integrity Protocol (TKIP). TKIP scrambles the keys using a hashing algorithm and by adding an integrity-checking feature, ensures that the keys haven't been tampered with. WPA2 is based on 802.11i and uses Advanced Encryption Standard (AES) instead of TKIP.
- User authentication, which is generally missing in WEP, through the extensible authentication protocol (EAP). WEP regulates access to a wireless network based on a computer's hardware-specific MAC address, which is relatively simple to be sniffed out and stolen. EAP is built on a more secure public-key encryption system to ensure that only authorized network users can access the network.

WPA-PSK/WPA2-PSK uses a passphrase or key to authenticate your wireless connection. The key is an alpha-numeric password between 8 and 63 characters long. The password can include symbols (!?*&_) and spaces. This key must be the exact same key entered on your wireless router or access point.

WPA/WPA2 incorporates user authentication through the Extensible Authentication Protocol (EAP). EAP is built on a more secure public key encryption system to ensure that only authorized network users can access the network.

Technical Specifications

Device Interfaces

- 802.11 ac/n/g/b/a wireless LAN
- Four 10/100/1000 Gigabit LAN ports
- 10/100/1000 Gigabit WAN port
- Two USB ports (one USB 3.0, one USB 2.0)

Antenna Types

- Eight external antennas

Standards

- IEEE 802.11ac
- IEEE 802.11n
- IEEE 802.11g
- IEEE 802.11b
- IEEE 802.11a
- IEEE 802.3
- IEEE 802.3u

Security

- WPA™ - Personal/Enterprise
- WPA2™ - Personal/Enterprise
- Wi-Fi Protected Setup (WPS) PIN/PBC

Power

- Input: 100 to 240 V AC, 50/60 Hz
- Output: 12 V DC, 5 A

USB Port Power

- 5 V / 0.9 A

Operating Temperature

- 0 to 40 °C (32 to 104 °F)

Operating Humidity

- 10% to 95% maximum (non-condensing)

Certifications

- FCC Class B
- CSA/LVD
- CE Class B
- C-Tick
- IPv6 Ready
- Wi-Fi Protected Setup (WPS)
- Wi-Fi Multimedia (WMM)
- Compatible with Windows 8

Dimensions

- L = 417.73 mm (16.44 inches)
- W = 262.72 mm (10.34 inches)
- H = 49.6 mm (5.89 inches)

1 Maximum wireless signal rate derived from IEEE Standard 802.11a, 802.11g, 802.11n, and 802.11ac specifications. Actual data throughput will vary. Network conditions and environmental factors, including volume of network traffic, building materials and construction, and network overhead, lower actual data throughput rate. Environmental factors will adversely affect wireless signal range.

2 Frequency Range varies depending on country's regulation.

3 The DIR-895L does not include 5.25-5.35 GHz & 5.47-5.725 GHz in some regions.

Regulatory Information

Federal Communication Commission Interference Statement

This equipment has been tested and found to comply with the limits for a Class B digital device, pursuant to Part 15 of the FCC Rules. These limits are designed to provide reasonable protection against harmful interference in a residential installation. This equipment generates, uses and can radiate radio frequency energy and, if not installed and used in accordance with the instructions, may cause harmful interference to radio communications. However, there is no guarantee that interference will not occur in a particular installation. If this equipment does cause harmful interference to radio or television reception, which can be determined by turning the equipment off and on, the user is encouraged to try to correct the interference by one of the following measures:

- Reorient or relocate the receiving antenna.
- Increase the separation between the equipment and receiver.
- Connect the equipment into an outlet on a circuit different from that to which the receiver is connected.
- Consult the dealer or an experienced radio/TV technician for help.

Non-modifications Statement:

Any changes or modifications not expressly approved by the party responsible for compliance could void the user's authority to operate this equipment.

Caution:

This device complies with Part 15 of the FCC Rules. Operation is subject to the following two conditions:

- (1) This device may not cause harmful interference, and
- (2) this device must accept any interference received, including interference that may cause undesired operation.

This device and its antenna(s) must not be co-located or operating in conjunction with any other antenna or transmitter except in accordance with FCC multi-transmitter product procedures. For product available in the USA/Canada market, only channel 1~11 can be operated. Selection of other channels is not possible.

Note

The country code selection is for non-USA models only and is not available to all USA models. Per FCC regulations, all WiFi product marketed in the USA must be fixed to USA operational channels only.

RF Frequency Requirements

This device is for indoor use only when using all channels in the 5.150 - 5.250 GHz, 5.725 - 5.850 GHz frequency range. High power radars are allocated as primary users of the 5.150 - 5.250 GHz, 5.725 - 5.850 GHz bands. These radar stations can cause interference with and/or damage this device.

It is restricted to indoor environments only.

IMPORTANT NOTICE:

FCC Radiation Exposure Statement

This equipment complies with FCC radiation exposure limits set forth for an uncontrolled environment. This equipment should be installed and operated with minimum distance 31 cm between the radiator and your body.

Innovation, Science and Economic Development Canada (ISED) Statement:

This Class B digital apparatus complies with Canadian ICES-003.

Cet appareil numérique de la classe B est conforme à la norme NMB-003 du Canada.

Innovation, Science and Economic Development Canada (ISED) Statement:

This device complies with ISED licence-exempt RSS standard(s). Operation is subject to the following two conditions:

- (1) this device may not cause interference, and
- (2) this device must accept any interference, including interference that may cause undesired operation of the device.

Le présent appareil est conforme aux CNR d'ISED applicables aux appareils radio exempts de licence. L'exploitation est autorisée aux deux conditions suivantes :

- (1) l'appareil ne doit pas produire de brouillage, et
- (2) l'utilisateur de l'appareil doit accepter tout brouillage radioélectrique subi, même si le brouillage est susceptible d'en compromettre le fonctionnement.

(i) the device for operation in the band 5150-5250 MHz is only for indoor use to reduce the potential for harmful interference to co-channel mobile satellite systems;

(i) les dispositifs fonctionnant dans la bande 5150-5250 MHz sont réservés uniquement pour une utilisation à l'intérieur afin de réduire les risques de brouillage préjudiciable aux systèmes de satellites mobiles utilisant les mêmes canaux;

(iii) for devices with detachable antenna(s), the maximum antenna gain permitted for devices in the band 5725-5850 MHz shall be such that the equipment still complies with the e.i.r.p. limits specified for point-to-point and non-point-to-point operation as appropriate;

(iii) pour les dispositifs munis d'antennes amovibles, le gain maximal d'antenne permis (pour les dispositifs utilisant la bande de 5725 à 5850 MHz) doit être conforme à la limite de la p.i.r.e. spécifiée pour l'exploitation point à point et l'exploitation non point à point, selon le cas;

Radiation Exposure Statement

This equipment complies with ISED radiation exposure limits set forth for an uncontrolled environment. This equipment should be installed and operated with minimum distance 31 cm between the radiator and your body.

Déclaration d'exposition aux radiations

Cet équipement est conforme aux limites d'exposition aux rayonnements ISED établies pour un environnement non contrôlé. Cet équipement doit être installé et utilisé avec un minimum de 31 cm de distance entre la source de rayonnement et votre corps.

Warning

This unit is to be used with a power supply, Model DA-60N12.

Avertissement

Cet appareil doit être utilisé avec une source de courant, modèle Model DA-60N12.

Table for Filed Antenna

Ant.	Brand	P/N	Antenna Type	Connector	Antenna Gain (dBi)			Cable Loss (dBi)			True Gain (dBi)		
					2.4G	5G B1	5G B4	2.4G	5G B1	5G B4	2.4G	5G B1	5G B4
1	HL TECHNOLOGY GROUP LIMITED	290-20187	Dipole Antenna	SMA Plug Reverse	1.8	2.8	-	0.5	1.1	-	1.3	1.7	-
2	HL TECHNOLOGY GROUP LIMITED	290-20188	Dipole Antenna	SMA Plug Reverse	1.8	2.8	-	0.5	1.1	-	1.3	1.7	-
3	HL TECHNOLOGY GROUP LIMITED	290-20188	Dipole Antenna	SMA Plug Reverse	1.8	2.8	-	0.5	1.1	-	1.3	1.7	-
4	HL TECHNOLOGY GROUP LIMITED	290-20188	Dipole Antenna	SMA Plug Reverse	1.8	2.8	-	0.5	1.1	-	1.3	1.7	-
5	HL TECHNOLOGY GROUP LIMITED	290-20187	Dipole Antenna	SMA Plug Reverse	-	-	2.8	-	-	0.7	-	-	2.1
6	HL TECHNOLOGY GROUP LIMITED	290-20188	Dipole Antenna	SMA Plug Reverse	-	-	2.8	-	-	0.7	-	-	2.1
7	HL TECHNOLOGY GROUP LIMITED	290-20188	Dipole Antenna	SMA Plug Reverse	-	-	2.8	-	-	0.7	-	-	2.1
8	HL TECHNOLOGY GROUP LIMITED	290-20188	Dipole Antenna	SMA Plug Reverse	-	-	2.8	-	-	0.7	-	-	2.1

NCC 警語：

以下警語適用台灣地區

依據 低功率電波輻射性電機管理辦法

第十二條: 經型式認證合格之低功率射頻電機，非經許可，公司、商號或使用者均不得擅自變更頻率、加大功率或變更原設計之特性及功能。

第十四條: 低功率射頻電機之使用不得影響飛航安全及干擾合法通信；經發現有干擾現象時，應立即停用，並改善至無干擾時方得繼續使用。前項合法通信，指依電信法規定作業之無線電通信。低功率射頻電機須忍受合法通信或工業、科學及醫療用電波輻射性電機設備之干擾。

無線傳輸設備 (UNII)

在 5.25-5.35 赫赫頻帶內操作之無線資訊傳輸設備，限於室內使用。無線資訊傳輸設備忍受合法通信之干擾且不得干擾合法通信；如造成干擾，應立即停用，俟無干擾之虞，始得繼續使用。無線資訊傳設備的製造廠商應確保頻率穩定性，如依製造廠商使用手冊上所述正常操作，發射的信號應維持於操作頻帶中。

電磁波曝露量MPE標準值 1 mW/cm^2 ，本產品使用時建議應距離人體: 31 cm.



	Frequency Band(s) Frequenzband Fréquence bande(s) Bandas de Frecuencia Frequenza/e Frequentie(s)	Max. Output Power (EIRP) Max. Output Power Consommation d'énergie max. Potencia máxima de Salida Potenza max. Output Max. Output Power
5 G	5.15 – 5.25 GHz	200 mW
	5.25 – 5.35 GHz	200 mW
	5.47 – 5.725 GHz	1 W
2.4 G	2.4 – 2.4835 GHz	100 mW

European Community Declaration of Conformity:

Česky [Czech]	Tímto D-Link Corporation prohlašuje, že tento produkt, jeho příslušenství a software jsou v souladu se směrnicí 2014/53/EU. Celý text ES prohlášení o shodě vydaného EU a o firmwaru produktu lze stáhnout na stránkách k produktu www.dlink.com .
Dansk [Danish]	D-Link Corporation erklærer herved, at dette produkt, tilbehør og software er i overensstemmelse med direktiv 2014/53/EU. Den fulde tekst i EU-overensstemmelseserklæringen og produktfirmware kan wnloades fra produktsiden hos www.dlink.com .
Deutsch [German]	Hiermit erklärt die D-Link Corporation, dass dieses Produkt, das Zubehör und die Software der Richtlinie 2014/53/EU entsprechen. Der vollständige Text der Konformitätserklärung der Europäischen Gemeinschaft sowie die Firmware zum Produkt stehen Ihnen zum Herunterladen von der Produktseite im Internet auf www.dlink.com zur Verfügung.
Eesti [Estonian]	Käesolevaga kinnitab D-Link Corporation, et see toode, tarvikud ja tarkvara on kooskõlas direktiiviga 2014/53/EL. Euroopa Liidu vastavusdeklaratsiooni täistekst ja toote püsivara on allalaadimiseks saadaval tootelehel www.dlink.com .
English	Hereby, D-Link Corporation, declares that this product, accessories, and software are in compliance with directive 2014/53/EU. The full text of the EU Declaration of Conformity and product firmware are available for download from the product page at www.dlink.com
Español [Spanish]	Por la presente, D-Link Corporation declara que este producto, accesorios y software cumplen con las directivas 2014/53/UE. El texto completo de la declaración de conformidad de la UE y el firmware del producto están disponibles y se pueden descargar desde la página del producto en www.dlink.com .
Ελληνική [Greek]	Με την παρούσα, η D-Link Corporation δηλώνει ότι αυτό το προϊόν, τα αξεσουάρ και το λογισμικό συμμορφώνονται με την Οδηγία 2014/53/ΕΕ. Το πλήρες κείμενο της δήλωσης συμμόρφωσης της ΕΕ και το υλικολογισμικό του προϊόντος είναι διαθέσιμα για λήψη από τη σελίδα του προϊόντος στην τοποθεσία www.dlink.com .
Français [French]	Par les présentes, D-Link Corporation déclare que ce produit, ces accessoires et ce logiciel sont conformes aux directives 2014/53/UE. Le texte complet de la déclaration de conformité de l'UE et le icroprogramme du produit sont disponibles au téléchargement sur la page des produits à www.dlink.com .
Italiano [Italian]	Con la presente, D-Link Corporation dichiara che questo prodotto, i relativi accessori e il software sono conformi alla direttiva 2014/53/UE. Il testo completo della dichiarazione di conformità UE e il firmware del prodotto sono disponibili per il download dalla pagina del prodotto su www.dlink.com .

Latviski [Latvian]	Ar šo uzņēmums D-Link Corporation apliecina, ka šis produkts, piederumi un programmatūra atbilst direktīvai 2014/53/ES. ES atbilstības deklarācijas pilno tekstu un produkta aparātprogrammatūru var lejupielādēt attiecīgā produkta lapā vietnē www.dlink.com .
Lietuvių [Lithuanian]	Šiuo dokumentu „D-Link Corporation“ pareiškia, kad šis gaminys, priedai ir programinė įranga atitinka direktyvą 2014/53/ES. Visą ES atitikties deklaracijos tekstą ir gaminio programinę aparatinę įrangą galima atsisiųsti iš gaminio puslapio adresu www.dlink.com .
Nederlands [Dutch]	Hierbij verklaart D-Link Corporation dat dit product, accessoires en software voldoen aan de richtlijnen 2014/53/EU. De volledige tekst van de EU conformiteitsverklaring en productfirmware is beschikbaar voor download van de productpagina op www.dlink.com .
Malti [Maltese]	Bil-preżenti, D-Link Corporation tiddikjara li dan il-prodott, l-aċċessorji, u s-software huma konformi mad-Direttiva 2014/53/UE. Tista' tniżżel it-test sħiħ tad-dikjarazzjoni ta' konformità tal-UE u l-firmware tal-prodott mill-paġna tal-prodott fuq www.dlink.com .
Magyar [Hungarian]	Ezennel a D-Link Corporation kijelenti, hogy a jelen termék, annak tartozékai és szoftvere megfelelnek a 2014/53/EU sz. rendeletnek. Az EU Megfelelőségi nyilatkozat teljes szövege és a termék firmware a termék oldaláról tölthető le a www.dlink.com címen.
Polski [Polish]	D-Link Corporation niniejszym oświadcza, że ten produkt, akcesoria oraz oprogramowanie są zgodne z dyrektywami 2014/53/EU. Pełen tekst deklaracji zgodności UE oraz oprogramowanie sprzętowe do produktu można pobrać na stronie produktu w witrynie www.dlink.com .
Português [Portuguese]	Desta forma, a D-Link Corporation declara que este produto, os acessórios e o software estão em conformidade com a diretiva 2014/53/UE. O texto completo da declaração de conformidade da UE e do firmware
Slovensko[Slovenian]	Podjetje D-Link Corporation s tem izjavlja, da so ta izdelek, dodatna oprema in programnska oprema skladni z direktivami 2014/53/EU. Celotno besedilo izjave o skladnosti EU in vdelana programska oprema sta na voljo za prenos na strani izdelka na www.dlink.com .
Slovensky [Slovak]	Spoločnosť D-Link týmto vyhlasuje, že tento produkt, príslušenstvo a softvér sú v súlade so smernicou 214/53/EÚ. Úplné znenie vyhlásenia EÚ o zhode a firmvéri produktu sú k dispozícii na prevzatie zo stránky produktu www.dlink.com .
Suomi [Finnish]	D-Link Corporation täten vakuuttaa, että tämä tuote, lisävarusteet ja ohjelmisto ovat direktiivin 2014/53/EU vaatimusten mukaisia. Täydellinen EU-vaatimustenmukaisuusvakuutus samoin kuin tuotteen laiteohjelmisto ovat ladattavissa osoitteesta www.dlink.com .

Svenska [Swedish]	D-Link Corporation försäkrar härmed att denna produkt, tillbehör och programvara överensstämmer med direktiv 2014/53/EU. Hela texten med EU-försäkran om överensstämmelse och produkt-firmware kan hämtas från produktsidan på www.dlink.com .
Íslenska [Icelandic]	Hér með lýsir D-Link Corporation því yfir að þessi vara, fylgihlutir og hugbúnaður eru í samræmi við tilskipun 2014/53/EB. Sækja má ESB-samræmisýfirlýsinguna í heild sinni og fastbúnað vörunnar af vefsíðu vörunnar á www.dlink.com .
Norsk [Norwegian]	Herved erklærer D-Link Corporation at dette produktet, tilbehøret og programvaren er i samsvar med direktivet 2014/53/EU. Den fullstendige teksten i EU-erklæring om samsvar og produktets fastvare er tilgjengelig for nedlasting fra produktsiden på www.dlink.com .

Warning Statement:

The power outlet should be near the device and easily accessible.

NOTICE OF WIRELESS RADIO LAN USAGE IN THE EUROPEAN COMMUNITY (FOR WIRELESS PRODUCT ONLY):

- This device is restricted to indoor use when operated in the European Community using channels in the 5.15-5.35 GHz band to reduce the potential for interference.
- This device is a 2.4 GHz wideband transmission system (transceiver), intended for use in all EU member states and EFTA countries. This equipment may be operated in AL, AD, BE, BG, DK, DE, FI, FR, GR, GW, IS, IT, HR, LI, LU, MT, MK, MD, MC, NL, NO, AT, PL, PT, RO, SM, SE, RS, SK, ES, CI, HU, and CY.

Usage Notes:

- To remain in conformance with European National spectrum usage regulations, frequency and channel limitations will be applied on the products according to the country where the equipment will be deployed.
- This device is restricted from functioning in Ad-hoc mode while operating in 5 GHz. Ad-hoc mode is direct peer-to-peer communication between two client devices without an Access Point.
- Access points will support DFS (Dynamic Frequency Selection) and TPC (Transmit Power Control) functionality as required when operating in 5 GHz band within the EU.
- Please refer to the product manual or datasheet to check whether your product uses 2.4 GHz and/or 5 GHz wireless.

HINWEIS ZUR VERWENDUNG VON DRAHTLOS-NETZWERK (WLAN) IN DER EUROPÄISCHEN GEMEINSCHAFT (NUR FÜR EIN DRAHTLOSES PRODUKT)

- Der Betrieb dieses Geräts in der Europäischen Gemeinschaft bei Nutzung von Kanälen im 5,15-5,35 GHz Frequenzband ist ausschließlich auf Innenräume beschränkt, um das Interferenzpotential zu reduzieren.
- Bei diesem Gerät handelt es sich um ein zum Einsatz in allen EU-Mitgliedsstaaten und in EFTA-Ländern - ausgenommen Frankreich. Der Betrieb dieses Geräts ist in den folgenden Ländern erlaubt: AL, AD, BE, BG, DK, DE, FI, FR, GR, GW, IS, IT, HR, LI, LU, MT, MK, MD, MC, NL, NO, AT, PL, PT, RO, SM, SE, RS, SK, ES, CI, HU, CY

Gebrauchshinweise:

- Um den in Europa geltenden nationalen Vorschriften zum Nutzen des Funkspektrums weiterhin zu entsprechen, werden Frequenz und Kanalbeschränkungen, dem jeweiligen Land, in dem das Gerät zum Einsatz kommt, entsprechend, auf die Produkte angewandt.
- Die Funktionalität im Ad-hoc-Modus bei Betrieb auf 5 GHz ist für dieses Gerät eingeschränkt. Bei dem Ad-hoc-Modus handelt es sich um eine Peer-to-Peer-Kommunikation zwischen zwei Client-Geräten ohne einen Access Point.
- Access Points unterstützen die Funktionen DFS (Dynamic Frequency Selection) und TPC (Transmit Power Control) wie erforderlich bei Betrieb auf 5 GHz innerhalb der EU.
- Bitte schlagen Sie im Handbuch oder Datenblatt nach, ob Ihr Gerät eine 2,4 GHz und / oder 5 GHz Verbindung nutzt.

AVIS CONCERNANT L'UTILISATION DE LA RADIO SANS FIL LAN DANS LA COMMUNAUTÉ EUROPÉENNE (UNIQUEMENT POUR LES PRODUITS SANS FIL)

- Cet appareil est limité à un usage intérieur lorsqu'il est utilisé dans la Communauté européenne sur les canaux de la bande de 5,15 à 5,35 GHz afin de réduire les risques d'interférences.
- Cet appareil est un système de transmission à large bande (émetteur-récepteur) de 2,4 GHz, destiné à être utilisé dans tous les États-membres de l'UE et les pays de l'AELE. Cet équipement peut être utilisé dans les pays suivants : AL, AD, BE, BG, DK, DE, FI, FR, GR, GW, IS, IT, HR, LI, LU, MT, MK, MD, MC, NL, NO, AT, PL, PT, RO, SM, SE, RS, SK, ES, CI, HU, CY

Notes d'utilisation:

- Pour rester en conformité avec la réglementation nationale européenne en matière d'utilisation du spectre, des limites de fréquence et de canal seront appliquées aux produits selon le pays où l'équipement sera déployé.
- Cet appareil ne peut pas utiliser le mode Ad-hoc lorsqu'il fonctionne dans la bande de 5 GHz. Le mode Adhoc fournit une communication directe pair à pair entre deux périphériques clients sans point d'accès.
- Les points d'accès prendront en charge les fonctionnalités DFS (Dynamic Frequency Selection) et TPC (Transmit Power Control) au besoin lors du fonctionnement dans la bande de 5 GHz au sein de l'UE.
- Merci de vous référer au guide d'utilisation ou de la fiche technique afin de vérifier si votre produit utilise 2.4 GHz et/ou 5 GHz sans fil.

AVISO DE USO DE LA LAN DE RADIO INALÁMBRICA EN LA COMUNIDAD EUROPEA (SOLO PARA EL PRODUCTO INALÁMBRICO)

- El uso de este dispositivo está restringido a interiores cuando funciona en la Comunidad Europea utilizando canales en la banda de 5,15-5,35 GHz, para reducir la posibilidad de interferencias.
- Este dispositivo es un sistema de transmisión (transceptor) de banda ancha de 2,4 GHz, pensado para su uso en todos los estados miembros de la UE y en los países de la AELC. Este equipo se puede utilizar en AL, AD, BE, BG, DK, DE, FI, FR, GR, GW, IS, IT, HR, LI, LU, MT, MK, MD, MC, NL, NO, AT, PL, PT, RO, SM, SE, RS, SK, ES, CI, HU, CY

Notas de uso:

- Para seguir cumpliendo las normas europeas de uso del espectro nacional, se aplicarán limitaciones de frecuencia y canal en los productos en función del país en el que se pondrá en funcionamiento el equipo.
- Este dispositivo tiene restringido el funcionamiento en modo Ad-hoc mientras funcione a 5 Ghz. El modo Ad-hoc es la comunicación directa de igual a igual entre dos dispositivos cliente sin un punto de acceso.
- Los puntos de acceso admitirán la funcionalidad DFS (Selección de frecuencia dinámica) y TPC (Control de la potencia de transmisión) si es necesario cuando funcionan a 5 Ghz dentro de la UE.
- Por favor compruebe el manual o la ficha de producto para comprobar si el producto utiliza las bandas inalámbricas de 2.4 GHz y/o la de 5 GHz.

AVVISO PER L'USO DI LAN RADIO WIRELESS NELLA COMUNITÀ EUROPEA (SOLO PER PRODOTTI WIRELESS)

- Nella Comunità europea, l'uso di questo dispositivo è limitato esclusivamente agli ambienti interni sui canali compresi nella banda da 5,15 a 5,35 GHz al fine di ridurre potenziali interferenze. Questo dispositivo è un sistema di trasmissione a banda larga a 2,4 GHz (ricetrasmittente), destinato all'uso in tutti gli stati membri dell'Unione europea e nei paesi EFTA.
- Questo dispositivo può essere utilizzato in AL, AD, BE, BG, DK, DE, FI, FR, GR, GW, IS, IT, HR, LI, LU, MT, MK, MD, MC, NL, NO, AT, PL, PT, RO, SM, SE, RS, SK, ES, CI, HU, CY

Note per l'uso

- Al fine di mantenere la conformità alle normative nazionali europee per l'uso dello spettro di frequenze, saranno applicate limitazioni sulle frequenze e sui canali per il prodotto in conformità alle normative del paese in cui il dispositivo viene utilizzato.
- Questo dispositivo non può essere attivato in modalità Ad-hoc durante il funzionamento a 5 GHz. La modalità Ad-hoc è una comunicazione diretta peer-to-peer fra due dispositivi client senza un punto di accesso.
- I punti di accesso supportano le funzionalità DFS (Dynamic Frequency Selection) e TPC (Transmit Power Control) richieste per operare a 5 GHz nell'Unione europea.
- Ti invitiamo a fare riferimento al manuale del prodotto o alla scheda tecnica per verificare se il tuo prodotto utilizza le frequenze 2,4 GHz e/o 5 GHz.

KENNISGEVING VAN DRAADLOOS RADIO LAN-GEbruik IN DE EUROPESE GEMEENSCHAP (ALLEEN VOOR DRAADLOOS PRODUCT)

- Dit toestel is beperkt tot gebruik binnenshuis wanneer het wordt gebruikt in de Europese Gemeenschap gebruik makend van kanalen in de 5.15-5.35 GHz band om de kans op interferentie te beperken.
- Dit toestel is een 2.4 GHz breedband transmissiesysteem (transceiver) dat bedoeld is voor gebruik in alle EU lidstaten en EFTA landen. Deze uitrusting mag gebruikt worden in AL, AD, BE, BG, DK, DE, FI, FR, GR, GW, IS, IT, HR, LI, LU, MT, MK, MD, MC, NL, NO, AT, PL, PT, RO, SM, SE, RS, SK, ES, CI, HU, CY

Gebruiksaanwijzingen:

- Om de gebruiksvoorschriften van het Europese Nationale spectrum na te leven, zullen frequentie- en kanaalbeperkingen worden toegepast op de producten volgens het land waar de uitrusting gebruikt zal worden.
- Dit toestel kan niet functioneren in Ad-hoc mode wanneer het gebruikt wordt in 5 GHz. Ad-hoc mode is directe peer-to-peer communicatie tussen twee klantenapparaten zonder een toegangspunt.
- Toegangspunten ondersteunen DFS (Dynamic Frequency Selection) en TPC (Transmit Power Control) functionaliteit zoals vereist bij gebruik in 5 GHz binnen de EU.
- Raadpleeg de handleiding of de datasheet om te controleren of uw product gebruik maakt van 2.4 GHz en/of 5 GHz.

SAFETY INSTRUCTIONS

The following general safety guidelines are provided to help ensure your own personal safety and protect your product from potential damage. Remember to consult the product user instructions for more details.

- Static electricity can be harmful to electronic components. Discharge static electricity from your body (i.e. touching grounded bare metal) before touching the product.
- Do not attempt to service the product and never disassemble the product. For some products with a user replaceable battery, please read and follow the instructions in the user manual.
- Do not spill food or liquid on your product and never push any objects into the openings of your product.
- Do not use this product near water, areas with high humidity, or condensation unless the product is specifically rated for outdoor application.
- Keep the product away from radiators and other heat sources.
- Always unplug the product from mains power before cleaning and use a dry lint free cloth only.

SICHERHEITSVORSCHRIFTEN

Die folgenden allgemeinen Sicherheitsvorschriften dienen als Hilfe zur Gewährleistung Ihrer eigenen Sicherheit und zum Schutz Ihres Produkts. Weitere Details finden Sie in den Benutzeranleitungen zum Produkt.

- Statische Elektrizität kann elektronischen Komponenten schaden. Um Schäden durch statische Aufladung zu vermeiden, leiten Sie elektrostatische Ladungen von Ihrem Körper ab, (z. B. durch Berühren eines geerdeten blanken Metallteils), bevor Sie das Produkt berühren.
- Unterlassen Sie jeden Versuch, das Produkt zu warten, und versuchen Sie nicht, es in seine Bestandteile zu zerlegen. Für einige Produkte mit austauschbaren Akkus lesen Sie bitte das Benutzerhandbuch und befolgen Sie die dort beschriebenen Anleitungen.
- Vermeiden Sie, dass Speisen oder Flüssigkeiten auf Ihr Produkt gelangen, und stecken Sie keine Gegenstände in die Gehäuseschlitze oder -öffnungen Ihres Produkts.
- Verwenden Sie dieses Produkt nicht in unmittelbarer Nähe von Wasser und nicht in Bereichen mit hoher Luftfeuchtigkeit oder Kondensation, es sei denn, es ist speziell zur Nutzung in Außenbereichen vorgesehen und eingestuft.
- Halten Sie das Produkt von Heizkörpern und anderen Quellen fern, die Wärme erzeugen.
- Trennen Sie das Produkt immer von der Stromzufuhr, bevor Sie es reinigen und verwenden Sie dazu ausschließlich ein trockenes fusselfreies Tuch.

CONSIGNES DE SÉCURITÉ

Les consignes générales de sécurité ci-après sont fournies afin d'assurer votre sécurité personnelle et de protéger le produit d'éventuels dommages. Veuillez consulter les consignes d'utilisation du produit pour plus de détails.

- L'électricité statique peut endommager les composants électroniques. Déchargez l'électricité statique de votre corps (en touchant un objet en métal relié à la terre par exemple) avant de toucher le produit.
- N'essayez pas d'intervenir sur le produit et ne le démontez jamais. Pour certains produits contenant une batterie remplaçable par l'utilisateur, veuillez lire et suivre les consignes contenues dans le manuel d'utilisation.
- Ne renversez pas d'aliments ou de liquide sur le produit et n'insérez jamais d'objets dans les orifices.
- N'utilisez pas ce produit à proximité d'un point d'eau, de zones très humides ou de condensation sauf si le produit a été spécifiquement conçu pour une application extérieure.
- Éloignez le produit des radiateurs et autres sources de chaleur.
- Débranchez toujours le produit de l'alimentation avant de le nettoyer et utilisez uniquement un chiffon sec non pelucheux.

INSTRUCCIONES DE SEGURIDAD

Las siguientes directrices de seguridad general se facilitan para ayudarle a garantizar su propia seguridad personal y para proteger el producto frente a posibles daños. No olvide consultar las instrucciones del usuario del producto para obtener más información.

- La electricidad estática puede resultar nociva para los componentes electrónicos. Descargue la electricidad estática de su cuerpo (p. ej., tocando algún metal sin revestimiento conectado a tierra) antes de tocar el producto.
- No intente realizar el mantenimiento del producto ni lo desmonte nunca. Para algunos productos con batería reemplazable por el usuario, lea y siga las instrucciones del manual de usuario.
- No derrame comida o líquidos sobre el producto y nunca deje que caigan objetos en las aberturas del mismo.
- No utilice este producto cerca del agua, en zonas con humedad o condensación elevadas a menos que el producto esté clasificado específicamente para aplicación en exteriores.
- Mantenga el producto alejado de los radiadores y de otras fuentes de calor.
- Desenchufe siempre el producto de la alimentación de red antes de limpiarlo y utilice solo un paño seco sin pelusa.

ISTRUZIONI PER LA SICUREZZA

Le seguenti linee guida sulla sicurezza sono fornite per contribuire a garantire la sicurezza personale degli utenti e a proteggere il prodotto da potenziali danni. Per maggiori dettagli, consultare le istruzioni per l'utente del prodotto.

- L'elettricità statica può essere pericolosa per i componenti elettronici. Scaricare l'elettricità statica dal corpo (ad esempio toccando una parte metallica collegata a terra) prima di toccare il prodotto.
- Non cercare di riparare il prodotto e non smontarlo mai. Per alcuni prodotti dotati di batteria sostituibile dall'utente, leggere e seguire le istruzioni riportate nel manuale dell'utente.
- Non versare cibi o liquidi sul prodotto e non spingere mai alcun oggetto nelle aperture del prodotto.
- Non usare questo prodotto vicino all'acqua, in aree con elevato grado di umidità o soggette a condensa a meno che il prodotto non sia specificatamente approvato per uso in ambienti esterni.
- Tenere il prodotto lontano da caloriferi e altre fonti di calore.
- Scollegare sempre il prodotto dalla presa elettrica prima di pulirlo e usare solo un panno asciutto che non lasci filacce.

VEILIGHEIDSINFORMATIE

De volgende algemene veiligheidsinformatie werd verstrekt om uw eigen persoonlijke veiligheid te waarborgen en uw product te beschermen tegen mogelijke schade. Denk eraan om de gebruikersinstructies van het product te raadplegen voor meer informatie.

- Statische elektriciteit kan schadelijk zijn voor elektronische componenten. Ontlaad de statische elektriciteit van uw lichaam (d.w.z. het aanraken van geaard bloot metaal) voordat u het product aanraakt.
- U mag nooit proberen het product te onderhouden en u mag het product nooit demonteren. Voor sommige producten met door de gebruiker te vervangen batterij, dient u de instructies in de gebruikershandleiding te lezen en te volgen.
- Mors geen voedsel of vloeistof op uw product en u mag nooit voorwerpen in de openingen van uw product duwen.
- Gebruik dit product niet in de buurt van water, gebieden met hoge vochtigheid of condensatie, tenzij het product specifiek geclassificeerd is voor gebruik buitenshuis.
- Houd het product uit de buurt van radiators en andere warmtebronnen.
- U dient het product steeds los te koppelen van de stroom voordat u het reinigt en gebruik uitsluitend een droge pluisvrije doek.

Disposing of and Recycling Your Product

ENGLISH

EN



This symbol on the product or packaging means that according to local laws and regulations this product should be not be disposed of in household waste but sent for recycling. Please take it to a collection point designated by your local authorities once it has reached the end of its life, some will accept products for free. By recycling the product and its packaging in this manner you help to conserve the environment and protect human health.

D-Link and the Environment

At D-Link, we understand and are committed to reducing any impact our operations and products may have on the environment. To minimise this impact D-Link designs and builds its products to be as environmentally friendly as possible, by using recyclable, low toxic materials in both products and packaging.

D-Link recommends that you always switch off or unplug your D-Link products when they are not in use. By doing so you will help to save energy and reduce CO2 emissions.

To learn more about our environmentally responsible products and packaging please visit www.dlinkgreen.com.

DEUTSCH

DE



Dieses Symbol auf dem Produkt oder der Verpackung weist darauf hin, dass dieses Produkt gemäß bestehender örtlicher Gesetze und Vorschriften nicht über den normalen Hausmüll entsorgt werden sollte, sondern einer Wiederverwertung zuzuführen ist. Bringen Sie es bitte zu einer von Ihrer Kommunalbehörde entsprechend amtlich ausgewiesenen Sammelstelle, sobald das Produkt das Ende seiner Nutzungsdauer erreicht hat. Für die Annahme solcher Produkte erheben einige dieser Stellen keine Gebühren. Durch ein auf diese Weise durchgeführtes Recycling des Produkts und seiner Verpackung helfen Sie, die Umwelt zu schonen und die menschliche Gesundheit zu schützen.

D-Link und die Umwelt

D-Link ist sich den möglichen Auswirkungen seiner Geschäftstätigkeiten und seiner Produkte auf die Umwelt bewusst und fühlt sich verpflichtet, diese entsprechend zu mindern. Zu diesem Zweck entwickelt und stellt D-Link seine Produkte mit dem Ziel größtmöglicher Umweltfreundlichkeit her und verwendet wiederverwertbare, schadstoffarme Materialien bei Produktherstellung und Verpackung.

D-Link empfiehlt, Ihre Produkte von D-Link, wenn nicht in Gebrauch, immer auszuschalten oder vom Netz zu nehmen. Auf diese Weise helfen Sie, Energie zu sparen und CO2-Emissionen zu reduzieren.

Wenn Sie mehr über unsere umweltgerechten Produkte und Verpackungen wissen möchten, finden Sie entsprechende Informationen im Internet unter www.dlinkgreen.com.

FRANÇAIS**FR**

Ce symbole apposé sur le produit ou son emballage signifie que, conformément aux lois et réglementations locales, ce produit ne doit pas être éliminé avec les déchets domestiques mais recyclé. Veuillez le rapporter à un point de collecte prévu à cet effet par les autorités locales; certains accepteront vos produits gratuitement. En recyclant le produit et son emballage de cette manière, vous aidez à préserver l'environnement et à protéger la santé de l'homme.

D-Link et l'environnement

Chez D-Link, nous sommes conscients de l'impact de nos opérations et produits sur l'environnement et nous engageons à le réduire. Pour limiter cet impact, D-Link conçoit et fabrique ses produits de manière aussi écologique que possible, en utilisant des matériaux recyclables et faiblement toxiques, tant dans ses produits que ses emballages.

D-Link recommande de toujours éteindre ou débrancher vos produits D-Link lorsque vous ne les utilisez pas. Vous réaliserez ainsi des économies d'énergie et réduirez vos émissions de CO₂.

Pour en savoir plus sur les produits et emballages respectueux de l'environnement, veuillez consulter le www.dlinkgreen.com.

ESPAÑOL**ES**

Este símbolo en el producto o el embalaje significa que, de acuerdo con la legislación y la normativa local, este producto no se debe desechar en la basura doméstica sino que se debe reciclar. Llévelo a un punto de recogida designado por las autoridades locales una vez que ha llegado al fin de su vida útil; algunos de ellos aceptan recogerlos de forma gratuita. Al reciclar el producto y su embalaje de esta forma, contribuye a preservar el medio ambiente y a proteger la salud de los seres humanos.

D-Link y el medio ambiente

En D-Link, comprendemos y estamos comprometidos con la reducción del impacto que puedan tener nuestras actividades y nuestros productos en el medio ambiente. Para reducir este impacto, D-Link diseña y fabrica sus productos para que sean lo más ecológicos posible, utilizando materiales reciclables y de baja toxicidad tanto en los productos como en el embalaje.

D-Link recomienda apagar o desenchufar los productos D-Link cuando no se estén utilizando. Al hacerlo, contribuirá a ahorrar energía y a reducir las emisiones de CO₂.

Para obtener más información acerca de nuestros productos y embalajes ecológicos, visite el sitio www.dlinkgreen.com.

ITALIANO**IT**

La presenza di questo simbolo sul prodotto o sulla confezione del prodotto indica che, in conformità alle leggi e alle normative locali, questo prodotto non deve essere smaltito nei rifiuti domestici, ma avviato al riciclo. Una volta terminato il ciclo di vita utile, portare il prodotto presso un punto di raccolta indicato dalle autorità locali. Alcuni questi punti di raccolta accettano gratuitamente i prodotti da riciclare. Scegliendo di riciclare il prodotto e il relativo imballaggio, si contribuirà a preservare l'ambiente e a salvaguardare la salute umana.

D-Link e l'ambiente

D-Link cerca da sempre di ridurre l'impatto ambientale dei propri stabilimenti e dei propri prodotti. Allo scopo di ridurre al minimo tale impatto, D-Link progetta e realizza i propri prodotti in modo che rispettino il più possibile l'ambiente, utilizzando materiali riciclabili a basso tasso di tossicità sia per i prodotti che per gli imballaggi.

D-Link raccomanda di spegnere sempre i prodotti D-Link o di scollegarne la spina quando non vengono utilizzati. In questo modo si contribuirà a risparmiare energia e a ridurre le emissioni di anidride carbonica.

Per ulteriori informazioni sui prodotti e sugli imballaggi D-Link a ridotto impatto ambientale, visitate il sito all'indirizzo www.dlinkgreen.com.

NEDERLANDS**NL**

Dit symbool op het product of de verpakking betekent dat dit product volgens de plaatselijke wetgeving niet mag worden weggegooid met het huishoudelijk afval, maar voor recyclage moeten worden ingeleverd. Zodra het product het einde van de levensduur heeft bereikt, dient u het naar een inzamelpunt te brengen dat hiertoe werd aangeduid door uw plaatselijke autoriteiten, sommige autoriteiten accepteren producten zonder dat u hiervoor dient te betalen. Door het product en de verpakking op deze manier te recyclen helpt u het milieu en de gezondheid van de mens te beschermen.

D-Link en het milieu

Bij D-Link spannen we ons in om de impact van onze handelingen en producten op het milieu te beperken. Om deze impact te beperken, ontwerpt en bouwt D-Link zijn producten zo milieuvriendelijk mogelijk, door het gebruik van recycleerbare producten met lage toxiciteit in product en verpakking.

D-Link raadt aan om steeds uw D-Link producten uit te schakelen of uit de stekker te halen wanneer u ze niet gebruikt. Door dit te doen bespaart u energie en beperkt u de CO₂-emissies.

Breng een bezoek aan www.dlinkgreen.com voor meer informatie over onze milieuverantwoorde producten en verpakkingen.

POLSKI**PL**

Ten symbol umieszczony na produkcie lub opakowaniu oznacza, że zgodnie z miejscowym prawem i lokalnymi przepisami niniejszego produktu nie wolno wyrzucać jak odpady czy śmieci z gospodarstwa domowego, lecz należy go poddać procesowi recyklingu. Po zakończeniu użytkowania produktu, niektóre odpowiednie do tego celu podmioty przyjmą takie produkty nieodpłatnie, dlatego prosimy dostarczyć go do punktu zbiórki wskazanego przez lokalne władze. Poprzez proces recyklingu i dzięki takiemu postępowaniu z produktem oraz jego opakowaniem, pomogą Państwo chronić środowisko naturalne i dbać o ludzkie zdrowie.

D-Link i środowisko

D-Link podchodzimy w sposób świadomy do ochrony otoczenia oraz jesteśmy zaangażowani w zmniejszanie wpływu naszych działań i produktów na środowisko naturalne. W celu zminimalizowania takiego wpływu firma D-Link konstruuje i wytwarza swoje produkty w taki sposób, aby były one jak najbardziej przyjazne środowisku, stosując do tych celów materiały nadające się do powtórnego wykorzystania, charakteryzujące się małą toksycznością zarówno w przypadku samych produktów jak i opakowań.

Firma D-Link zaleca, aby Państwo zawsze prawidłowo wyłączali z użytku swoje produkty D-Link, gdy nie są one wykorzystywane. Postępując w ten sposób pozwalają Państwo oszczędzać energię i zmniejszać emisje CO₂.

Aby dowiedzieć się więcej na temat produktów i opakowań mających wpływ na środowisko prosimy zapoznać się ze stroną Internetową www.dlinkgreen.com.

ČESKY**CZ**

Tento symbol na výrobku nebo jeho obalu znamená, že podle místně platných předpisů se výrobek nesmí vyhazovat do komunálního odpadu, ale odeslat k recyklaci. Až výrobek doslouží, odnešte jej prosím na sběrné místo určené místními úřady k tomuto účelu. Některá sběrná místa přijímají výrobky zdarma. Recyklací výrobku i obalu pomáháte chránit životní prostředí i lidské zdraví.

D-Link a životní prostředí

Ve společnosti D-Link jsme si vědomi vlivu našich provozů a výrobků na životní prostředí a snažíme se o minimalizaci těchto vlivů. Proto své výrobky navrhujeme a vyrábíme tak, aby byly co nejekologičtější, a ve výrobcích i obalech používáme recyklovatelné a nízkotoxické materiály.

Společnost D-Link doporučuje, abyste své výrobky značky D-Link vypnuli nebo vytáhli ze zásuvky vždy, když je nepoužíváte. Pomůžete tak šetřit energii a snížit emise CO₂.

Více informací o našich ekologických výrobcích a obalech najdete na adrese www.dlinkgreen.com.

MAGYAR**HU**

Ez a szimbólum a terméken vagy a csomagoláson azt jelenti, hogy a helyi törvényeknek és szabályoknak megfelelően ez a termék nem semmisíthető meg a háztartási hulladékkal együtt, hanem újrahasznosításra kell küldeni. Kérjük, hogy a termék élettartamának elteltét követően vigye azt a helyi hatóság által kijelölt gyűjtőhelyre. A termékek egyes helyeken ingyen elhelyezhetők. A termék és a csomagolás újrahasznosításával segíti védeni a környezetet és az emberek egészségét.

A D-Link és a környezet

A D-Linknél megértjük és elkötelezettek vagyunk a műveleteink és termékeink környezetre gyakorolt hatásainak csökkentésére. Az ezen hatás csökkentése érdekében a D-Link a lehető leginkább környezetbarát termékeket tervez és gyárt azáltal, hogy újrahasznosítható, alacsony károsanyag-tartalmú termékeket gyárt és csomagolásokat alkalmaz.

A D-Link azt javasolja, hogy mindig kapcsolja ki vagy húzza ki a D-Link termékeket a tápforrásból, ha nem használja azokat. Ezzel segít az energia megtakarításában és a széndioxid kibocsátásának csökkentésében.

Környezetbarát termékeinkről és csomagolásainkról további információkat a www.dlinkgreen.com weboldalon tudhat meg.

NORSK**NO**

Dette symbolet på produktet eller forpakningen betyr at dette produktet ifølge lokale lover og forskrifter ikke skal kastes sammen med husholdningsavfall, men leveres inn til gjenvinning. Vennligst ta det til et innsamlingssted anvist av lokale myndigheter når det er kommet til slutten av levetiden. Noen steder aksepteres produkter uten avgift. Ved på denne måten å gjenvinne produktet og forpakningen hjelper du å verne miljøet og beskytte folks helse.

D-Link og miljøet

Hos D-Link forstår vi oss på og er forpliktet til å minske innvirkningen som vår drift og våre produkter kan ha på miljøet. For å minimalisere denne innvirkningen designer og lager D-Link produkter som er så miljøvennlig som mulig, ved å bruke resirkulerbare, lav-toksiske materialer både i produktene og forpakningen.

D-Link anbefaler at du alltid slår av eller frakobler D-Link-produkter når de ikke er i bruk. Ved å gjøre dette hjelper du å spare energi og å redusere CO2-utslipp.

For mer informasjon angående våre miljøansvarlige produkter og forpakninger kan du gå til www.dlinkgreen.com.

DANSK**DK**

Dette symbol på produktet eller emballagen betyder, at dette produkt i henhold til lokale love og regler ikke må bortskaffes som husholdningsaffald, mens skal sendes til genbrug. Indlever produktet til et indsamlingssted som angivet af de lokale myndigheder, når det er nået til slutningen af dets levetid. I nogle tilfælde vil produktet blive modtaget gratis. Ved at indlevere produktet og dets emballage til genbrug på denne måde bidrager du til at beskytte miljøet og den menneskelige sundhed.

D-Link og miljøet

Hos D-Link forstår vi og bestræber os på at reducere enhver indvirkning, som vores aktiviteter og produkter kan have på miljøet. For at minimere denne indvirkning designer og producerer D-Link sine produkter, så de er så miljøvenlige som muligt, ved at bruge genanvendelige materialer med lavt giftighedsniveau i både produkter og emballage.

D-Link anbefaler, at du altid slukker eller frakobler dine D-Link-produkter, når de ikke er i brug. Ved at gøre det bidrager du til at spare energi og reducere CO₂-udledningerne.

Du kan finde flere oplysninger om vores miljømæssigt ansvarlige produkter og emballage på www.dlinkgreen.com.

SUOMI**FI**

Tämä symboli tuotteen pakkauksessa tarkoittaa, että paikallisten lakien ja säännösten mukaisesti tätä tuotetta ei pidä hävittää yleisen kotitalousjätteen seassa vaan se tulee toimittaa kierrätettäväksi. Kun tuote on elinkaarensa päässä, toimita se lähimpään viranomaisten hyväksymään kierrätyspisteeseen. Kierrättämällä käytetyn tuotteen ja sen pakkauksen autat tukemaan sekä ympäristön että ihmisten terveyttä ja hyvinvointia.

D-Link ja ympäristö

D-Link ymmärtää ympäristönsuojelun tärkeyden ja on sitoutunut vähentämään tuotteistaan ja niiden valmistuksesta ympäristölle mahdollisesti aiheutuvia haittavaikutuksia. Nämä negatiiviset vaikutukset minimoidakseen D-Link suunnittelee ja valmistaa tuotteensa mahdollisimman ympäristöystävällisiksi käyttämällä kierrätettäviä, alhaisia pitoisuuksia haitallisia aineita sisältäviä materiaaleja sekä tuotteissaan että niiden pakkauksissa.

Suosittellemme, että irrotat D-Link-tuotteesi virtalähteestä tai sammutat ne aina, kun ne eivät ole käytössä. Toimimalla näin autat säästämään energiaa ja vähentämään hiilidioksiidipäästöjä.

Lue lisää ympäristöystävällisistä D-Link-tuotteista ja pakkauksistamme osoitteesta www.dlinkgreen.com.

SVENSKA**SE**

Den här symbolen på produkten eller förpackningen betyder att produkten enligt lokala lagar och föreskrifter inte skall kastas i hushållssoporna utan i stället återvinnas. Ta den vid slutet av dess livslängd till en av din lokala myndighet utsedd uppsamlingsplats, vissa accepterar produkter utan kostnad. Genom att på detta sätt återvinna produkten och förpackningen hjälper du till att bevara miljön och skydda människors hälsa.

D-Link och miljön

På D-Link förstår vi och är fast beslutna att minska den påverkan våra verksamheter och produkter kan ha på miljön. För att minska denna påverkan utformar och bygger D-Link sina produkter för att de ska vara så miljövänliga som möjligt, genom att använda återvinningsbara material med låg gifthalt i både produkter och förpackningar.

D-Link rekommenderar att du alltid stänger av eller kopplar ur dina D-Link produkter när du inte använder dem. Genom att göra detta hjälper du till att spara energi och minska utsläpp av koldioxid.

För mer information om våra miljöansvariga produkter och förpackningar www.dlinkgreen.com.

PORTUGUÊS**PT**

Este símbolo no produto ou embalagem significa que, de acordo com as leis e regulamentações locais, este produto não deverá ser eliminado juntamente com o lixo doméstico mas enviado para a reciclagem. Transporte-o para um ponto de recolha designado pelas suas autoridades locais quando este tiver atingido o fim da sua vida útil, alguns destes pontos aceitam produtos gratuitamente. Ao reciclar o produto e respectiva embalagem desta forma, ajuda a preservar o ambiente e protege a saúde humana.

A D-Link e o ambiente

Na D-Link compreendemos e comprometemo-nos com a redução do impacto que as nossas operações e produtos possam ter no ambiente. Para minimizar este impacto a D-Link concebe e constrói os seus produtos para que estes sejam o mais inofensivos para o ambiente possível, utilizando materiais recicláveis e não tóxicos tanto nos produtos como nas embalagens.

A D-Link recomenda que desligue os seus produtos D-Link quando estes não se encontrarem em utilização. Com esta acção ajudará a poupar energia e reduzir as emissões de CO₂.

Para saber mais sobre os nossos produtos e embalagens responsáveis a nível ambiental visite www.dlinkgreen.com.