

User Manual

DCS-5230

Version 1.0

D-Link[®]



SECURITY

Wireless N PTZ Network Camera

Table of Contents

Product Overview	3	Status.....	50
Package Contents	3	Help	52
System Requirements	3	D-ViewCam Installation	53
Introduction.....	4	Adding a Camera.....	56
Hardware Overview	5	Wireless Security	61
Front	5	What is WEP?	61
Left Panel.....	6	What is WPA?	62
Right Panel	7	Using & Configuring the DCS-5230 with a NAT	
Bottom Panel	8	Router.....	63
Rear Panel.....	9	Router Set-Up and Installation.....	67
Hardware Installation.....	10	Using & Configuring 3G Compatible Cell Phones .	70
DI/DO Input Specifications	13	Play from RealPlayer	71
Wireless Installation Considerations.....	14	Play from PVPlayer.....	76
Configuration	15	Troubleshooting	79
D-Link Setup Wizard.....	15	Wireless Basics	82
Enabling UPnP for Windows® XP	16	Networking Basics	87
Setting up a Wireless Connection with WPS.....	21	Check your IP Address.....	87
Testing the DCS-5230	22	Statically Assign an IP Address.....	88
Viewing Your DCS-5230.....	23	Technical Specifications	89
Using the DCS-5230 with an Internet Browser.....	24		
Live Video	25		
DCS-5230 Configuration	27		
Setup	27		
Maintenance	46		

Package Contents

- D-Link DCS-5230 Wireless N PTZ Network Camera
- CAT5 Ethernet Cable
- Power Adapter
- Manual and Software on CD
- Quick Install Guide
- Camera Stand
- Mounting Screws

Note: Using a power supply with a different voltage than the one included with your product will cause damage and void the warranty for this product.

If any of the above items are missing, please contact your reseller.



System Requirements

- Windows® 2000 or XP
- At least 256MB of memory (512MB recommended)
- A wireless (802.11n or 802.11g) or Ethernet network
- Internet Explorer 6.x or higher Internet Web Browser
- VGA card resolution: 800x600 or above
- CPU: 1.3GHz or above processor (2.4GHz processor or higher with 512MB memory and a 32MB video card is required for multiple camera viewing and recording in IP surveillance program)

Introduction

D-Link's 1.3 Megapixel DCS-5230 is a 802.11n (draft) wireless ptz network camera designed with home and SOHO users in mind. The DCS-5230 delivers high quality real-time videos in MPEG-4 and JPEG allowing optimization for both image quality and bandwidth-efficiency.

The 1 Lux CMOS sensor ideal for low-light conditions and a built-in infrared LED for night surveillance allows this camera to provide 24-hour real-time monitoring. The motorized pan/tilt controls with 16x digital zoom offer precision close up imaging. A built-in PIR sensor provides effective motion detection capabilities. The WPS button offers a secure and easy wireless connection setup.

The DCS-5230 features 3G mobile video support, enabling users to view a live video feed from their camera on a compatible 3G mobile phone or PDA anywhere in a 3G coverage area. This allows users to remotely monitor the camera without having to use a computer. D-ViewCam, IP video management software is also included to manage up to 32 cameras simultaneously from your computer, send automated e-mail alerts, and record video to your hard drive when motion is detected.

Hardware Overview

Front

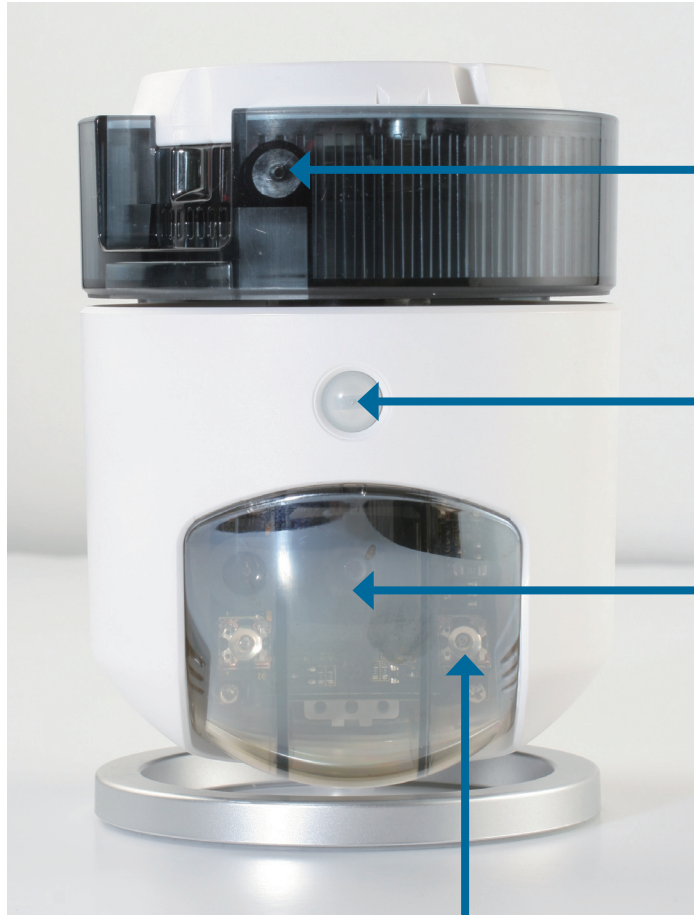

Microphone
This built-in microphone can be used capture audio from sources nearby the camera.

Pyroelectric Infrared (PIR) Sensor
This sensor is used to detect motion based on temperature variations within the immediate area.

Camera Dome
This clear dome houses the camera lens and protects the pan/tilt/zoom apparatus.

Infrared LEDs
LEDs enclosed in the dome illuminate the camera's field of vision during low-light operation.

Left Panel

Power/Link LED

The Power LED will illuminate red when the power is turned on. The light will remain red until the it has been initialized. The Link LED will illuminate green once a connection is established.

WPS LED

The WPS LED will blink blue when initializing a connection, and illuminate with solid blue once the connection has been established.

MicroSD Slot

Insert a standard MicroSD card into this slot for image storage.

WPS Button

Press this button to establish a WPS connection.



Right Panel

Audio Out

Connect a 3.5mm audio cable for output to a speaker.

Digital I/O Connector

Connect a digital I/O device to this pin block.

Ethernet Cable Connector

The DCS-5230 features a RJ-45 connector for connections to 10Base-T Ethernet cabling or 100Base-TX Fast Ethernet cabling. The port supports the NWay protocol, allowing the DCS-5230 to automatically detect or negotiate the transmission speed of the network.

DC Power Connector

The DC Power input connector is labeled DC 12V with a single jack socket to supply power to the DCS-5230.

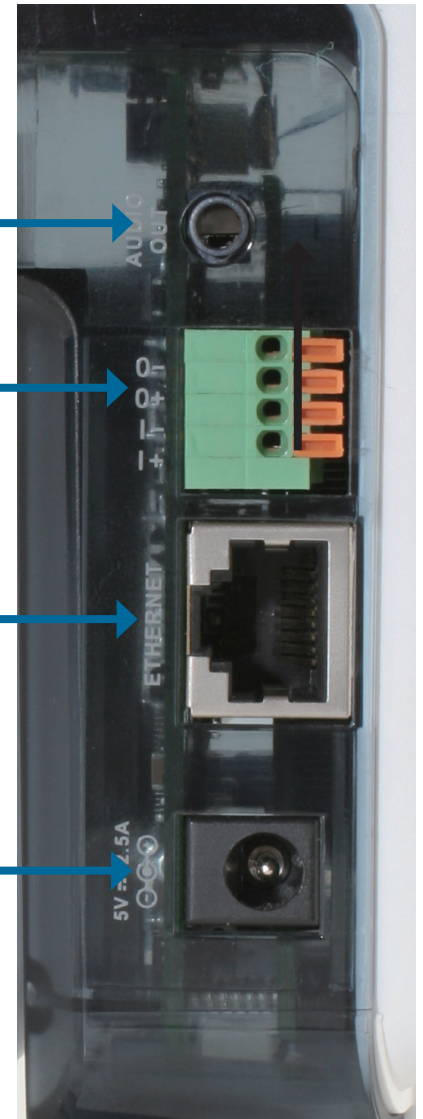

Bottom Panel

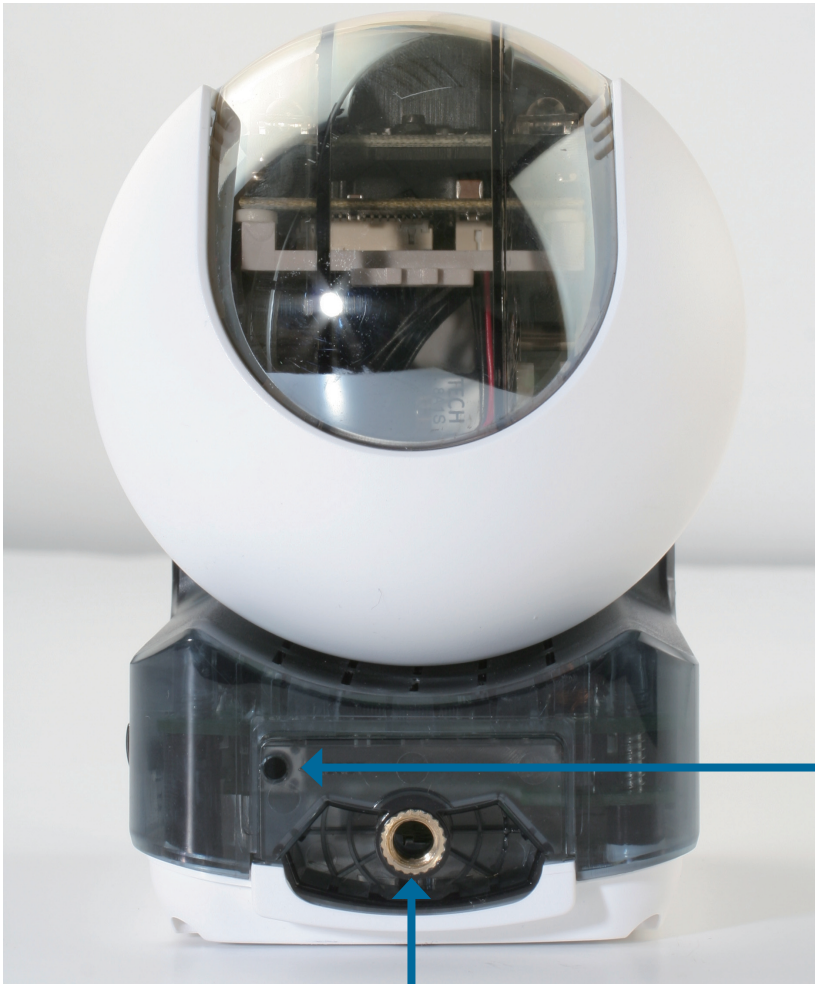

Reset Button

Depress this button with a straightened paper clip for about 20 seconds to reset the camera to factory default settings.

Mounting Socket

The silver mounting stand can be connected here if needed.

Rear Panel



Mounting Slots

These slots can be used to mount the camera against a wall using protruding bolts, nails, or screws.

Mounting Stand

This stand can be mounted atop or on the bottom of the enclosure depending on the camera's orientation.

Hardware Installation

Standard Orientation

Attach the silver mounting stand above the dome of the camera.



Tighten the nut on the top of the mounting stand using a coin or a screwdriver.



Inverted Orientation

Set the mounting onto a flat surface. Slide the camera down vertically onto the stand.



Cable Installation

Connect an Ethernet cable to the Ethernet port located on the camera's back panel and attach it to the network.

Note: An Ethernet cable is required during initial setup. Once your wireless configuration has been set up, you may disconnect the Ethernet cable and begin communicating wirelessly with your DCS-5230.

Attach the external power supply to the DC power input connector located on the camera's side panel, and connect the adapter to an AC power outlet.

Connect the 3.5mm audio connector from a speaker to the Audio Out port.



MicroSD Card Installation

Locate the MicroSD slot on the side of the camera.



Push a MicroSD card into the slot until it clicks into place.

Note: To remove a MicroSD card, gently push the card in and it will eject.



DI/DO Input Specifications

DO (Digital Output):

Normal: Open circuit

Trigger: Short circuit

After powering on or rebooting the DCS-5230, the camera will be in Normal mode by default.

DI (Digital Input):

Normal: No current

Trigger: 12V current

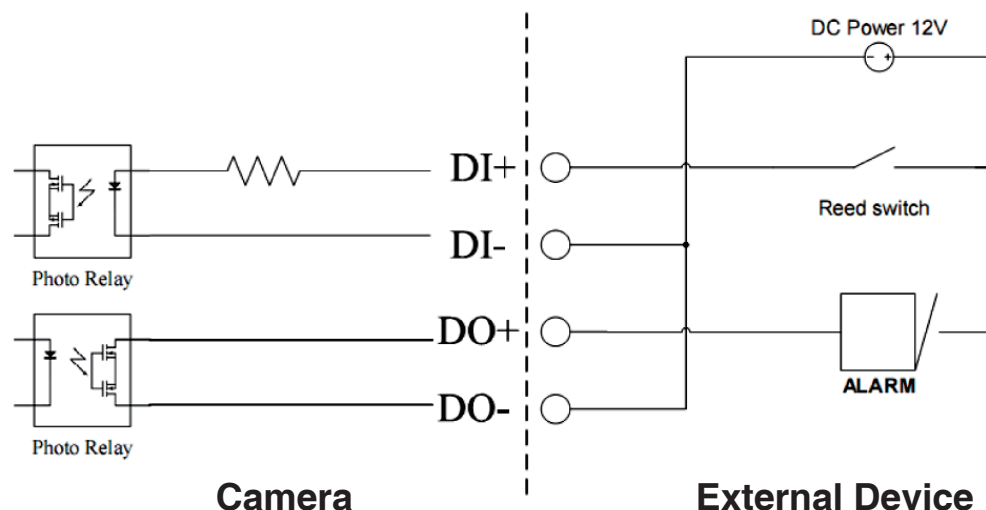

As the Digital Input signal is controlled by an external device, we recommend that you set your device to feed no current normally, and feed a 12V current only to trigger a DI event on the DCS-5230.

Example use of DI/DO:

You can connect a motion sensor to the DI port, signaling the camera to take a snapshot and to trigger an alarm connected to the DO port.

DI: Receives signals from an outside sensor. Connect any external security device to the DI port.

DO: Triggers an output device such as a buzzer or alarm.

Note: External device ports connected to the DI or DO port must provide 12V power.

Wireless Installation Considerations

The DCS-5230 can be accessed using a wireless connection from virtually anywhere within the operating range of your wireless network. Keep in mind, however, that the quantity, thickness and location of walls, ceilings, or other objects that the wireless signals must pass through, may limit the range. Ranges vary depending on the types of materials and background RF (radio frequency) noise in your home or office. The key to maximizing the wireless range is to follow these basic guidelines:

1. Minimize the number of walls and ceilings between the D-Link router and other network devices. Each wall or ceiling can reduce your adapter's range from 3 to 90 feet (1 to 30 meters).
2. Be aware of the direct line between network devices. A wall that is 1.5 feet thick (0.5 meters), at a 45-degree angle appears to be almost 3 feet (1 meter) thick. At a 2-degree angle it looks over 42 feet (14 meters) thick. Position devices so that the signal will travel straight through a wall or ceiling (instead of at an angle) for better reception.
3. Try to position access points, wireless routers, and computers so that the signal passes through open doorways and drywall. Materials such as glass, metal, brick, insulation, concrete and water can affect wireless performance. Large objects such as fish tanks, mirrors, file cabinets, metal doors and aluminum studs may also have a negative effect on range.
4. Keep your product at least 3 to 6 feet (1-2 meters) away from electrical devices or appliances that generate RF noise.
5. If you are using 2.4GHz cordless phones, make sure that the 2.4GHz phone base is as far away from your wireless device as possible. The base transmits a signal even if the phone is not in use. In some cases, cordless phones, X-10 wireless devices, and electronic equipment such as ceiling fans, fluorescent lights, and home security systems may dramatically degrade wireless connectivity.

Configuration

Turn on the computer and Insert the D-Link DCS-5230 Driver CD in the CD-ROM drive. The step-by-step instructions will help you to search and setup your IP camera smoothly and quickly.

If the CD Autorun function does not automatically start on your computer, click **Windows® Start > Run**. In the Run command box type “D:\DCS-5230.exe”, where D: represents the drive letter of your CD-ROM. If it does start, proceed to the next screen.

D-Link Setup Wizard

DCC will show the MAC address and IP address of your DCS-5230. If you have a DHCP* server on your network, there will be a valid IP Address displayed at the end of DCC process. You can begin to use the IP camera now.

*A DHCP server is a device that supplies IP Addresses to its clients that are on the same network.

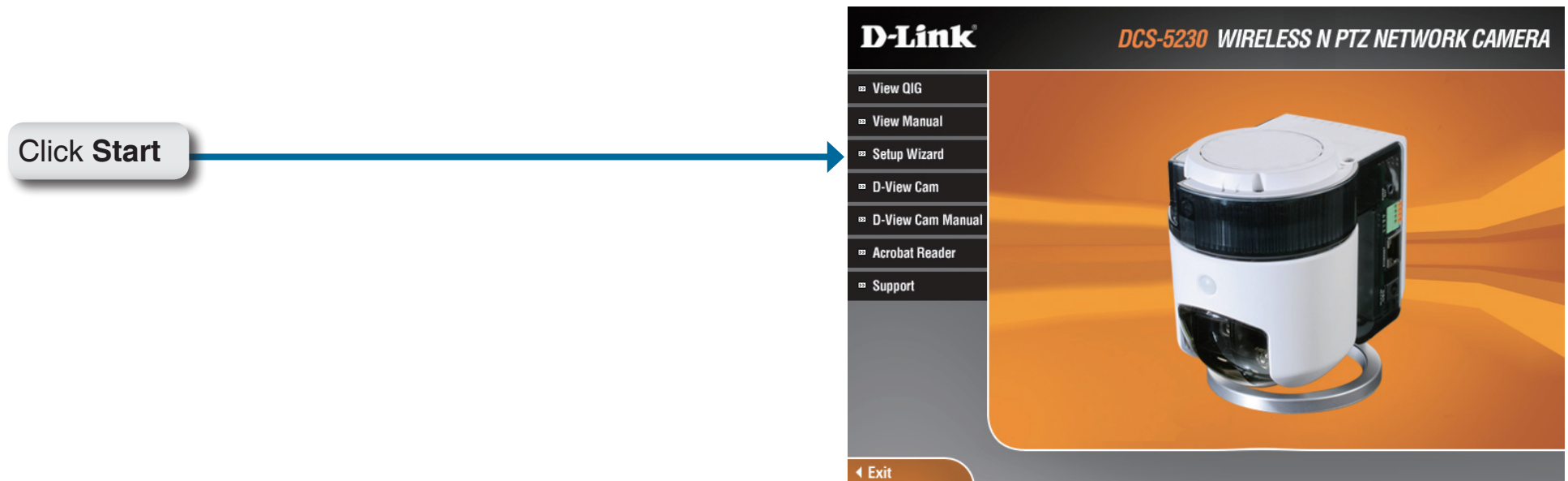

Enabling UPnP for Windows® XP

UPnP (Universal Plug and Play) is a networking architecture that provides compatibility among networking equipment, software, and peripherals. The DCS-5230 is an UPnP enabled Internet camera. If your operating system is UPnP enabled, the device will be easier to configure. If you do not want to use the UPnP functionality, it can be disabled by unchecking the **Enabled UPnP** checkbox on the **Advanced > Network** page (see page 29). Use the following steps to enable UPnP settings only if you are running Windows® XP. If you are running Windows® 98/2000, UPnP is not available.

Go to **Start > Settings**. Click **Control Panel**.

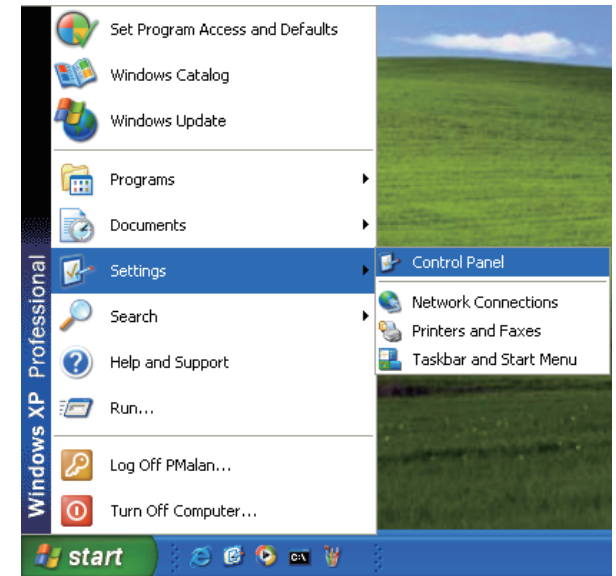

Click **Add or Remove Programs**

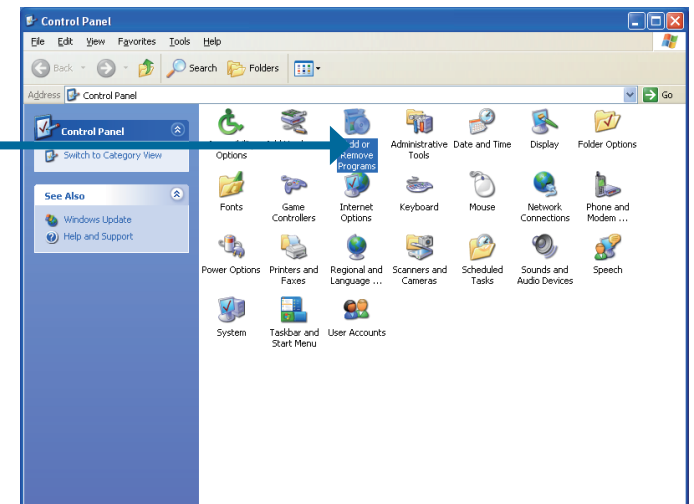

Click **Add/Remove Windows Components**

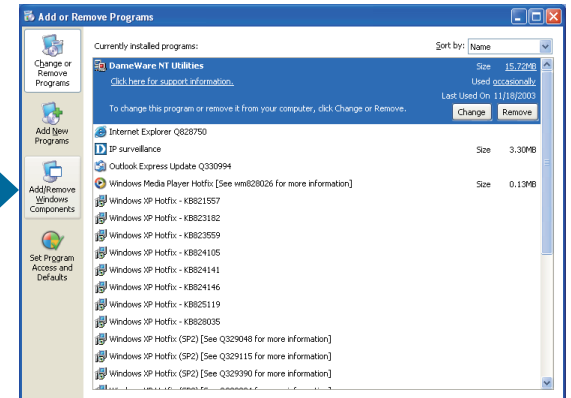

The following screen will appear.

Select **Networking Services**.

Click **Details**

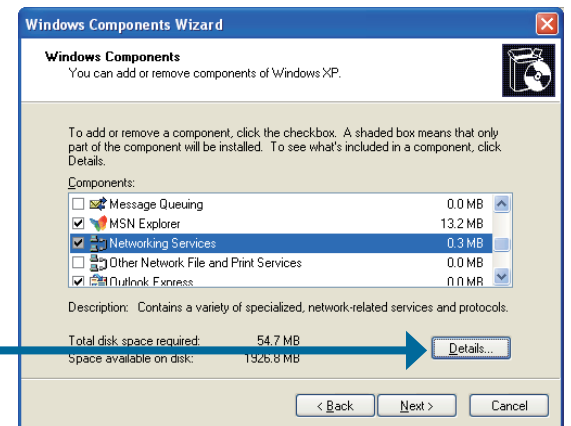

Select **Universal Plug and Play**.

Click **OK**

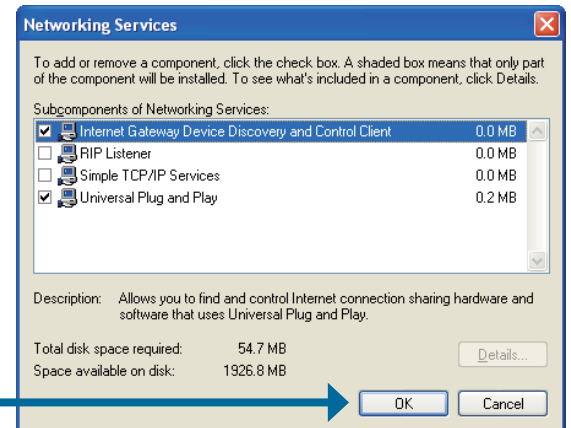

Click **Next**

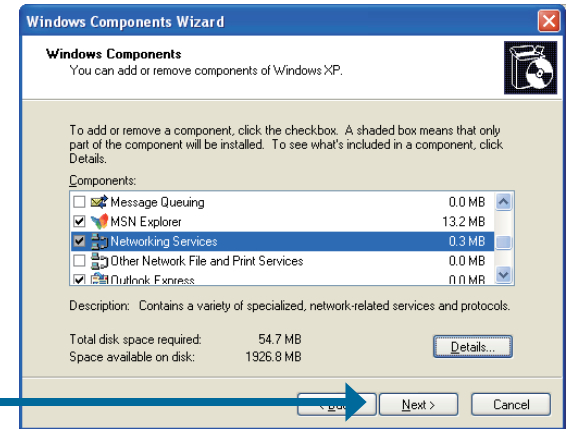

Please wait while Setup configures the components.

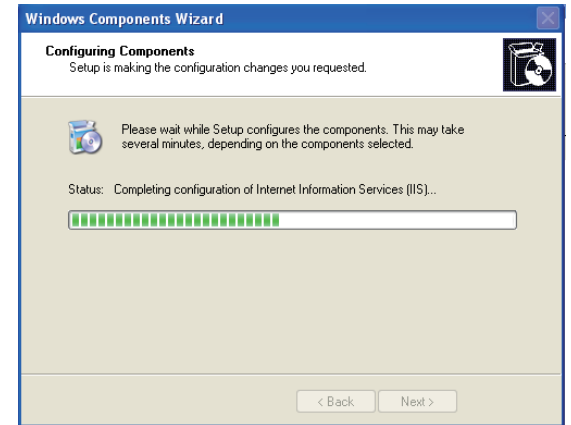

Click **Finish**



To view your DCS-5230 Internet Camera in an Internet browser, go to your Desktop and click **My Network Places**.



Click **DCS-5230 (192.168.0.120)**.

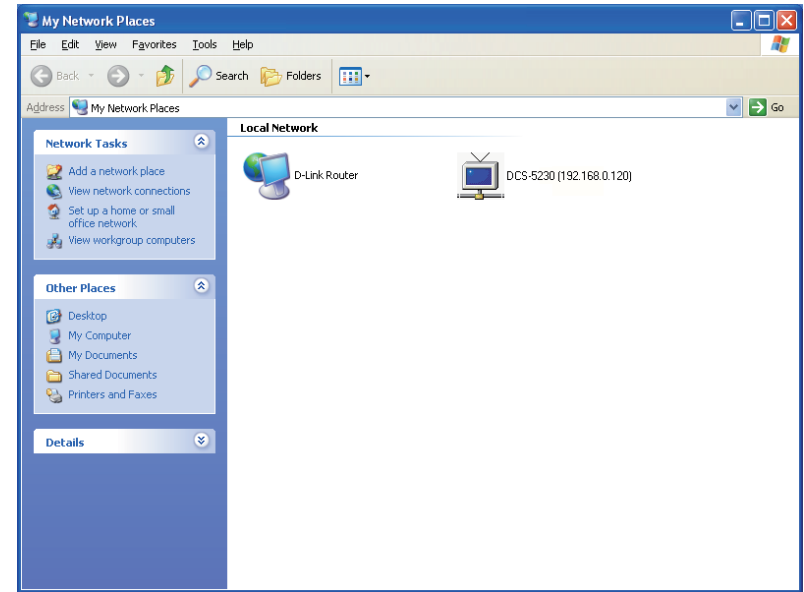

After you click on the **DCS-5230** icon, your Internet browser will automatically be opened to the IP Address of the DCS-5230, in this example it is: <http://192.168.0.120>. Your DCS-5230 may have a different IP Address.

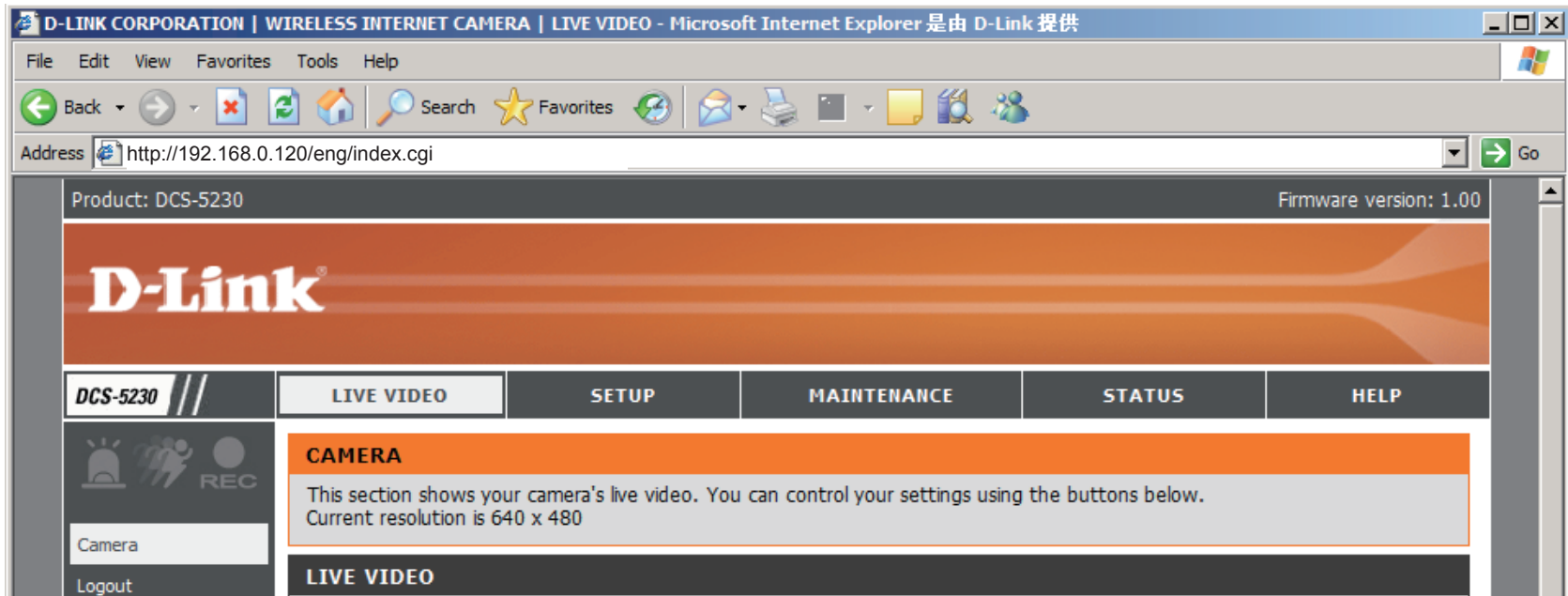

Setting up a Wireless Connection with WPS

If your wireless access point or router supports push-button Wireless Protected Setup (WPS), you can quickly configure your wireless network and camera without using the camera's web interface.

After plugging the power adapter to your camera and the front status LED lights up, hold down the WPS button on the back of the camera for 3 seconds. After pressing the button, it should start flashing blue.

Now press the WPS button on your router or access point within 1 minute to activate WPS and allow your devices to automatically configure a wireless connection. After WPS is successfully activated, the WPS LED on your camera will stop flashing, and will light up solid blue, then reboot.

Note: On some routers/access points, you may need to enter the web interface to activate WPS. Consult your product's user manual for further assistance.

WPS Button

Press this button to establish a WPS connection.



Testing the DCS-5230

Open your Internet browser and type in the IP address of the DCS-5230. In this example, the address is: <http://192.168.0.120> (your DCS-5230 may have a different IP address based on what you used in the DCC program).



The window in the center of your browser is the camera image window. You should now see a video image and hear the audio over your computer speakers from the DCS-5230. If you are having problems, please consult the Troubleshooting section of this manual (page 79).

Viewing Your DCS-5230

After all the router settings have been entered correctly, a PC user inside or outside your network will have access to the camera through the Internet Explorer Web browser. To access the camera from the Internet, type the IP Address of the router given to you by your ISP, followed by a colon, and the port number that you gave your camera (e.g., `http://70.42.15.9:83`). It is not necessary to enter the colon and port number if you are using the default Web server port 80. To access from a computer on your local (home) network, simply enter the local IP Address of the Camera followed by a colon and the port number (e.g., `192.168.0.120:83`).

If you are following this manual in the order it is presented, you should now have an operating DCS-5230 Internet Camera configured with the Installer program. This section of the manual will cover how to use the Internet Camera in two methods:

- Using the DCS-5230 with an Internet browser and accessing the screens to control and monitor the camera.
- Using IP surveillance software with the DCS-5230.

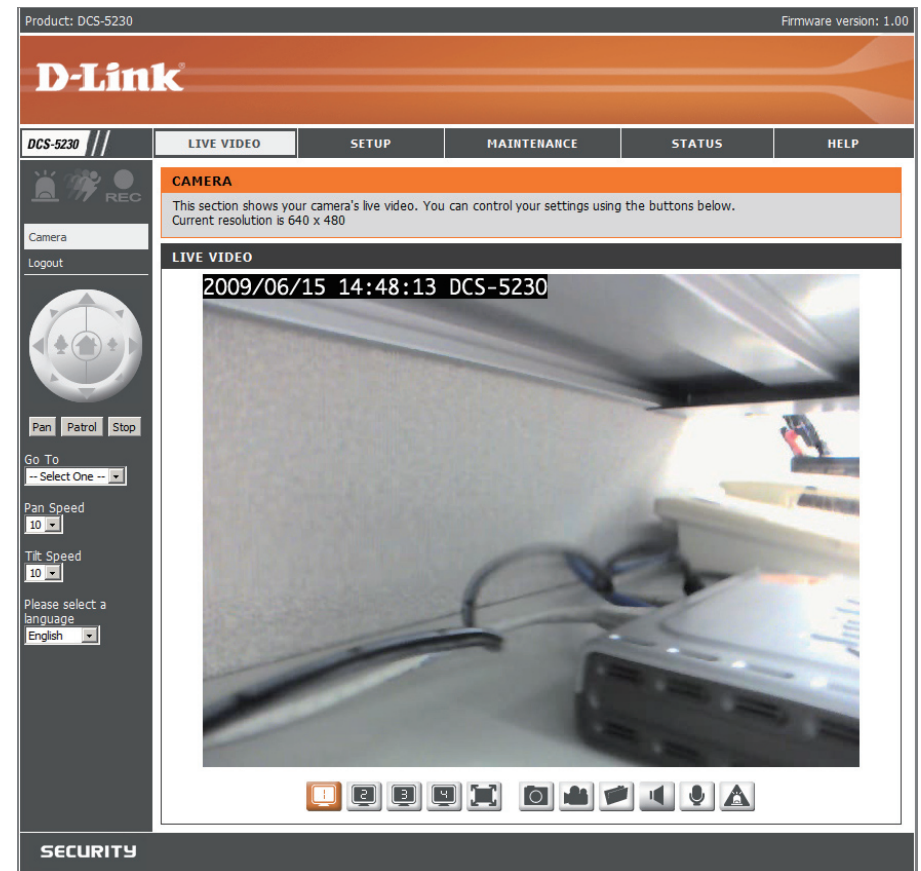

Using the DCS-5230 with an Internet Browser

Open your Internet Explorer Web browser and enter the IP address for your Internet Camera (<http://192.168.0.120>).

In the example, this address is 192.168.0.120. Your address may differ.

If a window appears asking to install a Verisign certificate for authentication click **Yes**. This allows the proprietary MPEG4 video stream to be recognized by Internet Explorer.



Live Video

The live image feed from the DCS-5230 should be visible from the device's **Live Video** page on your web browser.

- Client Setup:** Click on the **Client Setup** button to change settings related to the camera connection.
- Logout:** Click on the **Logout** button to logout from the camera server and close the browser.
- P/T/Z Action Pad:** Use the **Pan / Tilt / Zoom** Action Pad to control the camera's pan or tilt. The large tree icon controls the zoom in function. The small tree icon on the right side controls the zoom out function. The **Home** button can move the camera to the preset home position.
- Go To:** Select from the preset drop-down list to quickly move the camera to the desired preset position. (Please refer to "camera control" setup for the preset list function).
- Pan/Tilt Speed:** This setting can change the camera's Pan/Tilt speed.
- Pan:** Press this button and the camera will pan from left-most position to the right-most position and then return to its original position.
- Stop:** This will stop pan and patrol.
- Patrol:** Click this button to quickly move the camera to the desired patrol setup according to preset positions. (Please refer to "camera control" setup for the preset list function).

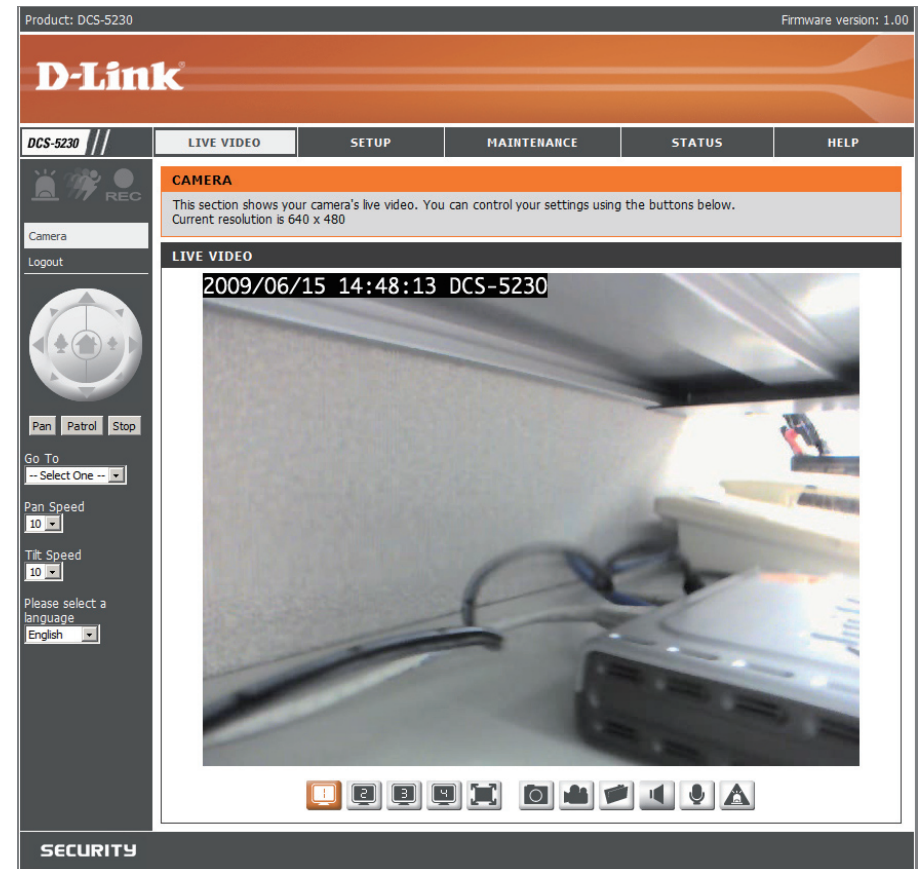

The bottom of this page contains several icons which can be used to control the camera's main functions.

Video Profile: You can change between your different viewing profiles, which you can set up in SETUP > Audio and Video.



Full Screen: This allows you to view the video in full screen mode. To exit full screen mode, press the ESC key on your keyboard.



Snapshot: Click it to capture a snapshot image. The image will pop up in a new window. Then you may save this image to a local hard drive.



Record Video: Click this button will start or stop recording video to the file path specified with the Set Path button (to the right).



Set Path: You can change the folder your manual recordings will be saved to.



Start/Stop Audio: This button toggles the built-in microphone on and off, allowing you to hear audio from the area surrounding your camera. Audio is on by default.



Start/Stop Talking: This will toggle audio to a speaker (not included) connected to the camera's Audio Out port. This can be used to communicate with others near the camera.



Start/Stop Digital Output: This button will toggle the digital output on or off.



DCS-5230 Configuration

Setup

There are 5 tabs across the top of the Configuration screen. The **LIVE VIDEO** page is used for viewing live video and audio.

The **SETUP** page is used for basic setup of the DCS-5230.

The **MAINTENANCE** page is used for server system maintenance.

The **STATUS** page will show the camera's status and logs.

The **HELP** page contains useful information about the setup and features of the DCS-5230.

Product: DCS-5230 Firmware version: 1.00

D-Link

DCS-5230 // LIVE VIDEO SETUP MAINTENANCE STATUS HELP

Setup Wizard
Network Setup
Wireless Setup
Dynamic DNS
Image Setup
Audio and Video
Motion Detection
Time and Date
Preset Position
Recording
Snapshot
Digital Output
Logout

INTERNET CONNECTION SETTINGS

In this section, you can setup the IP camera's network interface settings. If you are configuring this device for the first time, D-Link recommends that you select the Internet Connection Setup Wizard, and follow the instructions on screen. If you wish to modify or configure the IP camera settings manually, you may select the Manual Internet Connection Setup to input the network setting.

Internet Connection Setup Wizard Manual Internet Connection Setup

IP CAMERA MOTION DETECTION SETTINGS

In this section, you can setup the IP camera's Motion Detection settings. If you are configuring this device for the first time, D-Link recommends that you select the Motion Detection Setup Wizard, and follow the instructions on screen. If you wish to modify or configure the Motion Detection manually, select the Manual Motion Detection Setup.

Motion Detection Setup Wizard Manual Motion Detection Setup

Helpful Hints..

If you are an advanced user and have configured an Internet camera before, click 'Manual Internet Connection Setup' to input all settings manually.

If you consider yourself an advanced user and you want to manually set up motion detection settings, click 'Manual Motion Detection Setup' to input all the settings manually.

SECURITY

The Setup page provides the following configuration options: Wizard, Network Setup, Wireless Setup, Dynamic DNS, Image Setup, Audio and Video, Mail and FTP, Motion Detection, Time and Date, Schedule, Access List, Camera Control, and Logout.

Wizard

The setup wizards guide you through initial setup of your IP camera. You can use the Internet Connection Setup Wizard for initial network setup, and you can use the Motion Detection Setup Wizard to set up motion detection and snapshots. Simply follow the instructions given in each step of the wizard to quickly set up your camera.

Alternatively, you can manually set up your Internet connection by clicking **Manual Internet Connection Setup**, and you can manually set up motion detection options by clicking on **Manual Motion Detection Setup**. You can also see these settings by clicking on their categories on the left side (Network Setup/ Wireless Setup/ Motion Detection/ Snapshot).

Note: If the camera is set to SXGA mode in Audio and Video, Motion Detection and Motion Triggered Snapshots are disabled.



Network Setup

DHCP: DCS-5230 will request a new IP address from the DHCP server every time it restarts. Once the DCS-5230 is configured, this radio button should be deselected at all times. If this radio button has been selected and the connection is lost, run the DCC find the camera's IP address.

IP Address: Necessary for network identification.

Subnet Mask: Used to determine if the destination is in the same subnet. The default value is 255.255.255.0.

Default Router: Enter the IP address of the router/gateway. Invalid router settings may cause failed transmissions to a different subnet.

Primary DNS: The primary domain name server that translates names to IP addresses.

Secondary DNS: The secondary domain name server which operates as a backup for the primary DNS.

Enable UPnP: This option allows a computer to find this camera through UPnP (Universal Plug & Play), which will show up under "Network Neighborhood" without configuration. UPnP is based on TCP/IP and Internet protocols. UPnP is a networking architecture that provides compatibility among networking equipment, software, and peripherals. The camera is a UPnP enabled device and it will work with other UPnP devices and software.

Product: DCS-5230 Firmware version: 1.00

D-Link

DCS-5230 // LIVE VIDEO SETUP MAINTENANCE STATUS HELP

NETWORK SETUP
You can configure your LAN and Internet settings here.
Save Settings Don't Save Settings

LAN SETTINGS

LAN

DHCP Connection
 Static IP Address

IP Address
Subnet Mask
Default Gateway
Primary DNS
Secondary DNS

Enable UPnP
 Enable PPPoE

User Name
Password
Confirm password

PORT DETAIL SETTINGS

HTTP port
RTSP port
 User authentication

Save Settings Don't Save Settings

SECURITY

Helpful Hints.
Select 'DHCP Connection' if you are running a DHCP server on your network and would like an IP address assigned to your camera automatically.
- Enabling UPnP settings will allow you to configure your camera as an UPnP device in the network.
- Port Detail Settings allow you to specify the ports you reserve for both HTTP and RTSP Streaming.
- HTTP Port is the port you allocate in order to connect to the camera via a standard web browser.
- RTSP Port is the port you allocate in order to connect to a camera by using streaming mobile device(s), such as a mobile phone or PDA.

PPPoE Settings: If you are using a PPPoE connection, enable it and enter the User Name and Password for your PPPoE account. You can get this information from your Internet service provider (ISP).

HTTP Port: This is the port that allows the user to connect to the camera's user interface. By default the port is set to 80. You may change the port number if using multiple cameras.

RTSP Port: This is the port that the camera uses to stream video to. By default the port is set to 554. You may change the port number if using multiple cameras.

Note: You **MUST** also set up your router/gateway for Port Forwarding/Mapping; this will enable remote viewing of your camera via the Internet. Please refer to your router's instruction manual on how to open up ports. For additional help on configuring your camera to work with your router, please refer to **Installing the DCS-5230 Behind a Router** later in the User Manual. For installing multiple cameras, **ONE** port per camera must be opened on your router, the Web server (HTTP) port. Also, some browsers may restrict some ports, such as 1 or 22, for security purposes. If you have problems accessing your camera through HTTP, try using a port higher than 1024.

After making any changes, click the **Save Settings** button to save your changes, or click the **Don't Save Settings** button to discard your changes.

Wireless Setup

Enable Wireless: To set up your IP camera's wireless network interface settings, enable Wireless Settings in this window first. Then continue the further configuration next.

Site Survey: Clicking this button will scan for available wireless networks. After scanning, you can use the drop-down box to select an available wireless network, and related information (SSID, Wireless Mode, Channel, Authentication, Encryption) will be automatically filled in for you.

SSID: Enter the SSID of the wireless access point you wish to use.

Wireless Mode: Use the drop-down box to select the mode of the wireless network you wish to connect to. Infrastructure is normally used to connect to an access point or router. Ad-Hoc is usually used to connect directly to another computer.

Channel: If you are using Ad Hoc mode, select the channel of the wireless network you wish to connect to, or select **Auto**.

Authentication: Select the authentication you use on your wireless network - Open, Shared(WEP), WPA-PSK, or WPA-PSK2.

Encryption: If you use WPA-PSK or WPA-PSK2 authentication, you will need to specify whether your wireless network uses TKIP or AES encryption. If you use Open or Shared authentication, this setting will be automatically set for you.

Key: If you use WEP, WPA-PSK, or WPA-PSK2 authentication, enter the Key (also known as password) used for your wireless network.

After making any changes, click the **Save Settings** button to save your changes, or click the **Don't Save Settings** button to discard your changes.

The screenshot shows the D-Link DCS-5230 web interface. At the top, it displays 'Product: DCS-5230' and 'Firmware version: 1.00'. The main navigation bar includes 'LIVE VIDEO', 'SETUP', 'MAINTENANCE', 'STATUS', and 'HELP'. The 'SETUP' menu is expanded, showing options like 'Setup Wizard', 'Network Setup', 'Wireless Setup', 'Dynamic DNS', 'Image Setup', 'Audio and Video', 'Motion Detection', 'Time and Date', 'Preset Position', 'Recording', 'Snapshot', 'Digital Output', and 'Logout'. The 'Wireless Setup' page is active, featuring a 'WIRELESS SETUP' header and a 'Save Settings' button. Below this is the 'WIRELESS CONFIGURATION' section with the following settings:

- Enable Wireless:
- Site Survey:
- SSID:
- Wireless Mode:
- Channel:
- Authentication:
- Encryption:
- Key:

At the bottom of the configuration section, there are 'Save Settings' and 'Don't Save Settings' buttons. On the right side, there is a 'Helpful Hints...' section with text explaining SSID, Authentication, and WPA-PSK/WPA2-PSK settings.

Dynamic DNS

If you have a DSL or Cable service provider that changes your modem IP address periodically, Dynamic DNS (Domain Name Service), a method of keeping a domain name linked to a dynamic IP address, is useful. With most Cable and DSL connections, you are assigned a dynamic IP address and that address is used only for the duration of that specific connection. With the DCS-5230, you can set up your DDNS service and the DCS-5230 will automatically update your DDNS server every time it receives a different IP address. Depending on the service, this update may take a few hours.

Enable DDNS: Check this checkbox to enable the DDNS function of the camera.

Server Address: Use the drop-down box to the right to select a DDNS service to use.

Host Name: Type in the Host Name of the DDNS service you wish to use.

User Name: Enter your User Name for the DDNS service you wish to use.

Password: Enter the password for the DDNS service you wish to use.

Verify Password: Retype the password for the DDNS service you wish to use.

Timeout: This sets the number of hours between DDNS updates.

After making any changes, click the **Save Settings** button to save your changes, or click the **Don't Save Settings** button to discard your changes.

Product: DCS-5230 Firmware version: 1.00

D-Link

DCS-5230 // LIVE VIDEO SETUP MAINTENANCE STATUS HELP

Setup Wizard
Network Setup
Wireless Setup
Dynamic DNS
Image Setup
Audio and Video
Motion Detection
Time and Date
Preset Position
Recording
Snapshot
Digital Output
Logout

DYNAMIC DNS

The Dynamic DNS feature allows you to use a domain name that you have purchased (www.yourdomain.com) to access your camera with a dynamically assigned IP address. Most broadband Internet service providers assign dynamic (changing) IP addresses. By using a DDNS service, you can enter your domain name to connect to your camera no matter what your IP address is.

[Sign up for D-Link's Free DDNS service at www.DLinkDDNS.com.](http://www.dlinkddns.com)

Save Settings Don't Save Settings

DYNAMIC DNS SETTING

Enable DDNS

Server Address << Select Dynamic DNS Server >>

Host Name

User Name

Password

Verify Password

Timeout (hours)

Status: Disable

Save Settings Don't Save Settings

SECURITY

Helpful Hints..

Dynamic DNS is useful if you have a DSL or Cable service provider that changes your modem IP address periodically. This will allow you to assign a website domain name to your camera instead of connecting through an IP address.

Image Setup

The options in **Image Setup** allow you to adjust the settings for your IP camera sensor and image.

Brightness: This adjusts the brightness of the camera image. This is set to 35 by default.

Saturation: This adjusts the color saturation of the camera image. This is set to 40 by default.

Contrast: This adjusts the contrast of the camera image. This is set to 40 by default.

Frequency: This option adjusts the camera sensor's to prevent flickering under certain light sources, such as florescent lights. This is set to **Auto** by default.

White Balance: By default the camera will automatically white balance the image. You can turn off white balancing by selecting **Disable** from the drop-down box.

B/W: Ticking this checkbox will change the camera image into black and white.

Flip: This will flip the image vertically.

Mirror: This will flip the image horizontally in such a way that your left side will be on the left side of the screen and vice versa.

Note: Mirror and Flip can be used if you choose to mount the DCS-5230 upside down on the ceiling.

The screenshot shows the D-Link DCS-5230 web interface. At the top, it displays 'Product: DCS-5230' and 'Firmware version: 1.00'. The D-Link logo is prominent. Below the logo is a navigation bar with tabs for 'LIVE VIDEO', 'SETUP', 'MAINTENANCE', 'STATUS', and 'HELP'. The 'SETUP' tab is active, and the 'IMAGE SETUP' sub-tab is selected. The main content area is divided into three sections: 'IMAGE SETUP' (with a note that changes are reflected immediately), 'LIVE VIDEO' (showing a camera feed of a room with a timestamp '2009/06/15 14:48:54 DCS-5230'), and 'IMAGE SETTINGS'. The settings are as follows:

IMAGE SETTINGS			
Brightness	35	Saturation	80
Contrast	40	Frequency	Auto
White balance	Auto	B/W	<input type="checkbox"/>
Flip	<input checked="" type="checkbox"/>	Mirror	<input type="checkbox"/>

A 'Reset to Default' button is located at the bottom of the settings section. The right sidebar contains 'Helpful Hints...' with descriptions for Brightness, Saturation, Contrast, Frequency, White Balance, B/W, Flip, and Mirror.

Audio and Video

Click the **Audio and Video** button on the left side of the Setup screen to access audio and video settings that affect how the audio and video appears.

Sensor Output: You can set the camera's sensor output to VGA quality (640x480), XGA quality (1024x768), or SXGA quality (1280x1024).

Note: When using SXGA mode, please note that motion detection and motion triggered snapshots will be disabled and that recordings will be done at a maximum of Medium resolution.

Video Profile: You can set up 4 different video profiles, which allow you customize how you view your camera's video stream.

Encode Type: This sets the video codec used for the video stream. You can choose MPEG-4 or MJPEG(JPEG). IE browsers can view both MPEG-4 and MJPEG video streams, and non-IE browsers can only view MJPEG video streams.

Resolution: This sets the display resolution of the video stream. If the Resolution is different than the Sensor Output size, the video will be shrunk or enlarged to the Resolution size you set here.

FPS: This sets the target number of frames per second (FPS) for the video stream. Higher framerates will provide smoother video.

bps: This sets the target bitrate of the video stream. Higher bitrates will provide better quality video. When the Encode Type is set to MJPEG, you cannot change the bps setting. Also, available bps settings may change depending on what the Encode Type, Sensor Output, Resolution, and FPS settings are set to.

The screenshot shows the 'AUDIO AND VIDEO' configuration page for the DCS-5230 camera. The page is organized into several sections:

- VIDEO SENSOR:** Sensor Output is set to VGA (640x480).
- VIDEO PROFILE 1:** Encode Type: MPEG4, Resolution: 640x480, FPS: 30, bps: 2 Mbps, JPEG Quality: Excellent, RTSP URL: play1.sdp.
- VIDEO PROFILE 2:** Encode Type: MPEG4, Resolution: 320x240, FPS: 30, bps: 256 Kbps, JPEG Quality: Good, RTSP URL: play2.sdp.
- VIDEO PROFILE 3:** Encode Type: JPEG, Resolution: 640x480, FPS: 10, bps: --, JPEG Quality: Good, RTSP URL: play3.sdp.
- VIDEO PROFILE 4 FOR MOBILE DEVICE ONLY:** Encode Type: MPEG4, Resolution: 160x120, FPS: 5, bps: 64 Kbps, JPEG Quality: --, RTSP URL: 3ppp.
- NIGHT MODE:** Enable Night Mode is checked. Shutter is set to 1/15 Second. IR LED is set to Auto.
- AUDIO SETUP:** Enable Speaker is checked, Volume is 50. Enable Microphone is checked, Volume is 50.

Helpful Hints on the right side provide additional information:

- Encode Type:** Select the video codec 'JPEG' or 'MPEG4'.
- Resolution:** 3 options depend on display system used.
- FPS (Frame per second):** 30fps(NTSC) is the highest video quality for this camera.
- bps (bit per second):** Select a fixed bandwidth for your camera operation. Higher value means a higher quality image but consumes more network bandwidth.
- JPEG Quality:** Set the quality of JPEG image.
- RTSP URL:** The URL used to connect to the camera when viewing from a mobile device or PDA. (i.e. rtsp://IP:554/E).
- Night Mode:** Check Night Mode if your camera is in a dim light area and you need to improve the video quality.
- Audio Setup:** To switch the external speaker and microphone on/off or adjust the volume.
- Enable Speaker:** Enabling this feature to allow you to talk using PC's microphone and your voice to be transmitted to the external speaker connected to the camera.
- Speaker Volume:** You can adjust the speaker volume using the volume level setting.
- Enable Microphone:** Enabling this feature to hear audio from the IP Camera's microphone.
- Microphone Volume:** You can adjust the MIC Port volume using the volume level setting.

We suggest using a resolution of 176x120 (NTSC) at 5 FPS and 64K BPS to watch images on your cell phone or pda.

JPEG Quality: This sets the JPEG quality of any manual snapshots you take when this video profile is selected.

RTSP URL: This setting allows you to set a suffix for your camera's RTSP URL, so you can view your camera's video with this video profile's settings. For example, if you enter "mpeg4" as your RTSP URL setting and your camera's IP is 192.160.0.30, you can view your camera's video with these settings through 192.160.0.20/mpeg4 .

Note: Video Profile 3 is always set to MJPEG as the Encode Type to ensure that at least one of the Video Profiles are viewable by non-IE browsers. Video Profile 4 is for mobile devices only, and always uses MPEG-4 as the Encode Type.

Night Mode: Night mode allows the camera to use a longer shutter speed when the camera is in a low-light environment. If the camera is in an area where there is sufficient lighting, Night Mode will not affect the video stream.

Enable Night Mode: Check this box to enable Night Mode.

Shutter: This sets the longest shutter speed Night Mode will use when Night Mode is enabled and the camera is viewing a low-light scene.

Enable Speaker: Checking this box will enable you to send audio to an external speaker (not included) attached to the external speaker jack of your camera. This will allow you to speak with another person through your camera.

Volume: This sets the volume level of the external speaker.

Enable Microphone: Checking this box will enable you to listen to audio picked up by the camera's microphone. This will allow you to hear what is happening near your camera.

Volume: This sets the volume level of the incoming audio.

Note: Higher frame size, frame rate and bit rates will give you better video quality, but they will also require more network bandwidth. For best viewing results on a mobile phone, we suggest setting the frame rate to 5 fps and bit rate to 20 Kbps.

After making any changes, click the **Save Settings** button to save your changes, or click the **Don't Save Settings** button to discard your changes.

Motion Detection

This option allows you to set up Motion Detection on your IP camera. In order to use motion detection you must first check the **Enable Video Motion** checkbox. You can then click on the video window and draw motion detection zones by clicking and dragging your mouse. Red areas indicate areas that will be monitored for motion. The camera also has a PIR sensor which is used to detect motion using a special infrared sensor. PIR is good at detecting motion from live subjects such as people and animals.

Enable PIR: Click this box to enable the PIR sensor.

Enable Video Motion: Click this box to enable video motion detection.

Sensitivity: This setting adjusts how sensitive the camera will be to motion, where 100% will be the most sensitive setting and 0% will be the least sensitive setting.

Draw Motion Area: This will allow you to draw motion detection zones when clicking and dragging, or erase motion detection zones when clicking and dragging depending on which option you have selected.

Erase Motion Area: Clicking this button will clear all motion detection zones.

Product: DCS-5230 Firmware version: 1.00

D-Link

DCS-5230 // LIVE VIDEO SETUP MAINTENANCE STATUS HELP

MOTION DETECTION

This section will allow you to enable or disable motion detection function, draw or erase motion area, as well as configure the sensitivity setting of your camera to detect movement. You must select the checkbox of 'Enable Video Motion' to turn on the feature.

Save Settings Don't Save Settings

LIVE VIDEO

Enable PIR
 Enable Video Motion
 2009/06/15 14:05:13 DCS-5230

Sensitivity: 90 0~100%

Drawing Mode

Draw motion area
 Erase motion area

Clear

Save Settings Don't Save Settings

Helpful Hints..

Sensitivity - Set the sensitivity of camera to trigger motion detection. High sensitivity makes the motions easier to be detected.

Draw motion area - Drag your mouse to add motion detection range.

Erase motion area - Drag your mouse to erase motion detection range.

SECURITY

After making any changes, click the **Save Settings** button to save your changes, or click the **Don't Save Settings** button to discard your changes.

Note: If the camera is set to SXGA mode in Audio and Video, Motion Detection is disabled.

The red grid on the right indicates an area that has been selected for motion detection.

When motion is detected, the LIVE VIDEO page will display a blinking orange motion video icon like the one below.



The motion notification will continue to blink as long as motion is detected. If no additional motion is detected, it will return to its original state after eight seconds.



Time and Date

Click on the **Time and Date** button to access the settings from the left side of the Setup menu.

Time zone: Used to adjust the hour of time servers for local settings.

Enable Daylight Saving: Check this to enable daylight saving time.

Daylight Saving Dates: Set daylight saving time start and end date by your local definition.

Enable NTP Server: Synchronize with the NTP server over the Internet whenever the DCS-5230 starts up. It will fail if the assigned time server cannot be reached.

NTP server Used: Assign the IP address or domain name of the time server. Leaving the text box blank will let the DCS-5230 connect to default time servers.

Update interval: Used to adjust the hour of time servers for local settings. The time interval for the camera to update the time settings from a NTP server.

Set the date and time manually: Adjust the date and time according to what is selected by the administrator.

Copy Your Computer's time Settings: Synchronize the date and time of DCS-5230 with your local computer. The date and time of the PC is displayed and updated in the DCS-5230.

Product: DCS-5230 Firmware version: 1.00

D-Link

DCS-5230 // LIVE VIDEO SETUP MAINTENANCE STATUS HELP

Setup Wizard
Network Setup
Wireless Setup
Dynamic DNS
Image Setup
Audio and Video
Motion Detection
Time and Date
Preset Position
Recording
Snapshot
Digital Output
Logout

TIME AND DATE
Here you may configure the internal clock of your camera.
Save Settings Don't Save Settings

TIME CONFIGURATION
Time Zone [(GMT-12:00) International Date Line West]
 Enable Daylight Saving
 Auto Daylight Saving
 Set date and time manually
Offset: +1:00
Start time: 3:00 AM, 2:00 Sunday
End time: 11:00 PM, 1:00 Sunday

AUTOMATIC TIME CONFIGURATION
 Synchronize with NTP Server
NTP Server: ntp1.dlink.com << Select NTP Server

SET DATE AND TIME MANUALLY
 Set date and time manually
Year: 2009, Month: 6, Day: 15
Hour: 14, Minute: 49, Second: 22
Copy Your Computer's Time Settings

Helpful Hints..
Setting the correct time and time zone will allow you to have accurate logs and proper scheduling for recordings.

Preset Position

Click the **Preset Position** button from the left side of the Setup screen to access settings that affect how the DCS-5230 Internet Camera can pan and move to preset locations.

Pan Speed: Select the speed at which the camera will pan for a full cycle from the drop-down list. Select a value between 0 and 10, 0 being the slowest setting.

Tilt Speed: Select the speed at which the camera will tilt for a full cycle from the pull down menu. Select a value between 0 and 10, 0 being the slowest setting.

Pan/Patrol Speed: Select the speed at which the camera will pan during auto patrol. Select a value between 1 and 3, 1 being the slowest setting.

Current Position: Enter a name for the position at which you would like to preset the DCS-5230. Click **Add** to add the new preset position to the Preset Locations list.

Preset Position: Using the drop-down list, you can choose and delete a preset position by selecting it and clicking **Delete**.

Dwelling Time: Specify the number of seconds that the camera should remain fixed upon a specified preset position.

The screenshot shows the D-Link DCS-5230 web interface. The top navigation bar includes 'LIVE VIDEO', 'SETUP', 'MAINTENANCE', 'STATUS', and 'HELP'. The 'SETUP' menu is expanded, showing options like 'Setup Wizard', 'Network Setup', 'Wireless Setup', 'Dynamic DNS', 'Image Setup', 'Audio and Video', 'Motion Detection', 'Time and Date', 'Preset Position', 'Recording', 'Snapshot', 'Digital Output', and 'Logout'. The 'Preset Position' option is selected.

The main content area is titled 'CAMERA CONTROL' and features a live video feed of the camera's view. To the right of the video is a directional pad with 'Home Definition' and 'Default Home' buttons. Below the video are fields for 'Current Position' and 'Preset Position', each with a dropdown menu and an 'Add' button. There are also 'Preset Locations' and 'Selected Locations' lists, each with 'Up', 'Down', and 'Remove' buttons. The 'Patrol Selection' field has a 'Select' button. At the bottom, there are 'Pan Speed' and 'Tilt Speed' dropdown menus, and a 'Pan/Patrol Speed' dropdown menu. A 'Dwelling Time (sec)' field is also present.

The 'Helpful Hints' sidebar on the right contains the following text:

Home definition -
Allow you to set a new Home position or default back to the original position.

Patrol selection -
Allow you to add the Preset Locations into the 'Selected Locations' bar. This will determine where the IP camera will travel to and stop at when you select 'Auto Patrol' on the 'Live Video' page.

Set as Home: Use the **Set As Home** button to set the current position as the home position. The Home position is the first position the camera goes to after the camera boots. You can also recall the default home position, use the **Default Home** button.

Patrol Selection: To use the Auto Patrol feature, select the desired preset positions from the Preset Locations list and add them to the Selected Locations list by clicking **Select**. You can then select the order in which the camera will patrol through the preset locations by selecting a location and clicking **Up** or **Down**. Click **Remove** to remove a location from the list.

Recording

This option allows you to configure recording settings and scheduling. You can record video to a Secure Digital card inserted into the SD card slot, or you can have video saved to a Samba network drive.

Enable Recording: Check this checkbox to enable the recording feature. After enabling recording, you will need to select a location to record to (SD Card or Samba network drive), and you will need to select a scheduling method.

SD Card: Selecting this will allow you to record to an SD Card inserted into the SD slot on the right side of the unit. When recording to an SD Card, you can only use Event Based recording.

Samba Network Drive: Selecting this will allow you to record to a Samba network drive on your wired or wireless network.

Samba Auth: Here, select **Anonymous** if no user name or password is required to access your Samba drive. If you require a user name and password to log in to your Samba drive, select **Account** and fill in the following information:

User Name: Enter the user name required to access your Samba drive.

Password: Enter the password required to access your Samba drive.

Password Confirm: Re-enter the password required to access your Samba drive for verification.

Server: Enter the name or the IP of the server your Samba drive is on.

Shared Folder: Enter the name of your shared folder.

Test: This button will try to make a connection to the Samba network drive, and will let you know if the settings work.

The screenshot shows the 'RECORDING' configuration page in the D-Link DCS-5230 web interface. The page is divided into several sections:

- RECORDING:** A header section with a 'Save Settings' and 'Don't Save Settings' button.
- RECORDING:** A sub-section with a 'Save Settings' and 'Don't Save Settings' button.
- Enable recording:** A checkbox to enable the recording feature.
- Record to:** A dropdown menu to select the recording location (SD Card or Samba network drive).
- SD Card:** A section for configuring SD Card recording, including a 'Test' button and 'SD Card status: Disable'.
- Samba network drive:** A section for configuring Samba network drive recording, including fields for 'Samba Auth' (Anonymous or Account), 'User name', 'Password', 'Password confirm', 'Server', and 'Shared folder', along with a 'Test' button and 'Samba status: Disable'.
- Recording Options:** A section for configuring recording options, including 'Resolution' (Profile 1), 'Record until' (MB of free space is left), 'When storage is full' (Stop recording or Overwrite older recordings), and 'Recording Method' (Event Based or Scheduled).
- Event Based:** A section for configuring event-based recording, including 'Motion detection triggered recording', 'Digital input 1 triggered recording', 'Prerecord' (seconds), and 'Postrecord' (seconds).
- Scheduled (Samba only):** A section for configuring scheduled recording, including a table for days of the week and start/end times.

Note: You can create a simple Samba network drive on your Windows PC by right-clicking a folder, selecting **Sharing and Security...**, and selecting **Share this folder**. Enter a Share name you would like to use for the folder, then click the **Permissions** button and check the box for Full Control / Allow for the Everyone group. For your camera's Recording settings, use Anonymous for the Samba Auth, your computer's IP address for the Server, and the Share name you chose for the Shared Folder. Click on the **Test** button to test your settings.

Please note that when creating a simple network drive like this, all users on your local network will have access to the contents of this folder.

Resolution: This will let you set which video profile you wish to use to record video. Please note that if the bitrate(bps) of the video profile is higher than your Samba network drive's throughput, the recording's framerate(FPS) may be reduced.

Record Until: You can use this setting to adjust how much free space must remain when recording. It is suggested that you set this to at least 32M to allow for enough buffer space for the camera to record with.

When Storage is Full: When your storage device is full or has reached the free space limit specified in Record until, you can choose to stop recording, or you can have the camera delete old recordings to free space for new recordings to be saved.

Note: If the camera is set to SXGA mode in Audio and Video, recordings will be made at a maximum of Medium resolution only.

Event Based: Event based recording will allow you to record video when specific events happen.

Motion Detection Trigger

Recording: Enabling this option will set the camera to record video when motion is detected by the camera.

Digital Input Trigger Recording: When the camera receives a signal from its DI input, it will start recording. You can find more information about the DI/DO interface at the end of this document.

Prerecord: This will set how many seconds of video before the event takes place will be recorded.

Postrecord: This will set how many seconds of video after the event takes place will be recorded.

Example: Using motion detection triggered recording and setting Prerecord to 5 seconds and Postrecord to 9 seconds, the camera will save video from 5 seconds before motion was detected to 9 seconds after motion was detected.

Continuous: This will set the camera to record continuously. This scheduling method can only be done when recording to a Samba drive.

Scheduled Recording: This will set the camera to automatically record video during the specified times in the table below. This scheduling method can only be done when recording to a Samba drive.

After making any changes, click the **Save Settings** button to save your changes, or click the **Don't Save Settings** button to discard your changes.

Snapshot

Here, you can set the camera to take snapshots when motion is detected and/or when a signal is sent to the DI input. Snapshots can be sent to an e-mail address and/or to an FTP server.

Enable Snapshot: Check this box to enable the snapshot feature.

Motion Detector: This will set the camera to take a snapshot whenever motion is detected.

D/I: This will set the camera to take a snapshot whenever a signal is sent to the D/I input. You can find more information about the DI/DO interface at the end of this document.

E-mail Address: When checked, the camera will send the snapshots it takes to the e-mail address specified in the following text boxes. If you do not know what to enter for the User Name, Password, or SMTP Mail Server, contact your e-mail service provider for details.

User Name: Enter the username or login name for your e-mail account.

Password: Enter the password for your e-mail account.

SMTP Mail Server: Enter the SMTP server for your e-mail account.

Sender E-mail Address: Enter the e-mail address you want to appear as the “From:” e-mail address in the snapshot e-mail.

Recipient E-mail Address: Enter the e-mail address you want to send your snapshots to.

Port: Enter the port used by your SMTP server.

Test: Clicking this button will take a snapshot and will try to upload it to your FTP server using the settings you have entered.

Digital Output

This screen allows you to enable the Digital Out (D/O) port, and allows you to select what events will trigger the Digital Out signal.

Enable D/O: Check this box to enable the D/O port.

Motion Detection: When checked, the D/O port will send a signal whenever motion is detected by the camera. (When motion detection has been enabled)

D/I: When checked, the D/O port will send a signal whenever a signal is detected on the Digital In (D/I) port.

Note: If the camera is set to SXGA mode in Audio and Video, Motion Detection is disabled.

The screenshot displays the D-Link web interface for the DCS-5230 camera. The top navigation bar includes 'LIVE VIDEO', 'SETUP', 'MAINTENANCE', 'STATUS', and 'HELP'. The 'SETUP' menu is expanded, showing options like Setup Wizard, Network Setup, Wireless Setup, Dynamic DNS, Image Setup, Audio and Video, Motion Detection, Time and Date, Preset Position, Recording, Snapshot, Digital Output (selected), and Logout. The main content area is titled 'DIGITAL OUTPUT' and contains the following text: 'Here you can enable your D/O port as well as how the event will be triggered.' Below this text are two buttons: 'Save Settings' and 'Don't Save Settings'. Underneath is a section titled 'TRIGGER' with a checkbox for 'Enable D/O Signal'. If checked, there are two options for 'Trigger Event': 'Motion Detection' and 'D/I Signal 1'. At the bottom of this section are 'Save Settings' and 'Don't Save Settings' buttons. A 'Helpful Hints...' sidebar on the right explains that users can choose a trigger event like Motion detection or triggers from the D/I port, and that when an event is triggered, the D/O will begin sending a signal. The bottom of the interface features a 'SECURITY' banner.

Maintenance

Click on the **Maintenance** tab to access 3 utility screens for controlling and administering the DCS-5230. The default screen for Maintenance is Device Management.

Admin

The DCS-5230 is configured without any passwords by default. This allows anyone to access and configure the DCS-5230 as long as the IP address is known. Therefore, for security it is best to specify a password to restrict others from accessing your camera.

Type a password in the **Admin Password** field to enable protection, and then confirm the password in the **Retype Password** field.

This password is used to identify the administrator. You can add accounts with **User name** and **User Password** for other users in the Add user section. A maximum of 20 user accounts can be added.

The screenshot shows the 'MAINTENANCE' tab selected in the top navigation bar. The page is divided into several sections:

- ADMIN:** A message explaining that users can change the administrator's password, add or delete user accounts, and configure the OSD (On-Screen Display) feature.
- ADMIN PASSWORD SETTING:** Fields for 'New Password' and 'Retype Password', both with a '30 characters maximum' limit. A 'Save' button is present.
- ADD USER ACCOUNT:** Fields for 'User Name', 'New Password', and 'Retype Password', all with a '30 characters maximum' limit. An 'Add' button is present with a '20 users maximum' limit.
- USER LIST:** A table with a 'User Name' column, a '--User list --' dropdown, and a 'Delete' button.
- DEVICE SETTING:** Fields for 'Camera Name' (set to 'DCS-5230', 36 characters maximum) and 'Label' (set to 'DCS-5230', 30 characters maximum). There is a checked 'Enable OSD' checkbox, a 'Show time' checkbox, and 'LED light' options (radio buttons for 'On' and 'Off'). A 'Save' button is present.
- PRIVACY MODE:** Radio buttons for 'On', 'Off' (selected), and 'Scheduled'. Below this is a table for scheduling:

	Start	Hours	Minutes	End	Hours	Minutes
<input checked="" type="checkbox"/> Sun	Start	0	:	0	End	24 : 0
<input checked="" type="checkbox"/> Mon	Start	0	:	0	End	24 : 0
<input checked="" type="checkbox"/> Tue	Start	0	:	0	End	24 : 0
<input checked="" type="checkbox"/> Wed	Start	0	:	0	End	24 : 0
<input checked="" type="checkbox"/> Thu	Start	0	:	0	End	24 : 0
<input checked="" type="checkbox"/> Fri	Start	0	:	0	End	24 : 0
<input checked="" type="checkbox"/> Sat	Start	0	:	0	End	24 : 0

 A 'Save' button is at the bottom of this section.

On the right side, there is a 'Helpful Hints...' section with security advice: 'For security purposes, it is recommended to change the password for your administrator account. Be sure to write down the new password to avoid having to reset the camera in the event that it is forgotten. Enabling OSD, the camera name and time will be displayed on the video screen.'

Administrator's password: Password for the Administrator's account. The administrator password must be entered in twice for confirmation.

User name: Create a new user for accessing the video image. A maximum of twenty user accounts can be added. The new user name will be displayed in the list of user names below.

User List: Administrator can edit or delete users here by selecting the user name.

Delete user: Remove a user from the user list.

Enable OSD: Check this box to enable the On Screen Display which can include the camera label and time. The OSD will be displayed in the black bar above the video window with a timestamp.

Label: Type a label for the camera which will be displayed at the top of the video feed's on screen display.

Show Time: Displays the camera's current time in the on screen display area.

Camera Name: Type a name to identify your camera. This name will appear in the OSD unless a label is specified.

LED Light: The LED lights on the side of the device can be **enabled** or **disabled**. When enabled, they help to indicate the status of the camera. However, this information is readily available to anyone who can see the device. Therefore, for security reasons, you may wish to disable the LED lights to prevent others from observing the camera status.

Calibrate the Device: Clicking this button will calibrate the camera so that the P/T/Z apparatus functions correctly. The camera is automatically calibrated whenever it is powered on and initialized or reset. Should the camera's pan, tilt, and zoom functions begin to behave incorrectly, or if the device has been jarred or handled improperly, you may need to recalibrate the camera manually by pressing this button.

Privacy Mode: On: Turning privacy mode on will completely disable the audio and video feed from the camera.

Off (Default): When privacy mode is off, the audio and video feed from the camera is enabled.

Scheduled: Scheduled privacy mode offers the option to disable monitoring during certain times of the day. If scheduled privacy mode is enabled, you may put a checkmark next to the days that require privacy, and specify the interval at which the camera feed should be disabled on a particular day.

System

Save to Local Hard Drive: Clicking **Save Configuration** allows you to save a copy of the camera's current configuration to a location which you specify.

Load from Local Hard Drive: If you have previously backed up a your camera's configuration, you can restore it using this menu. Click **Browse**, and locate the file on your computer. **Click Load Configuration** to restore the backup. This will erase your current settings.

Restore to Factory Default: This option will reset the camera back to its factory default settings. This will erase your current settings.

Reboot Device: Clicking this button will restart the camera.

The screenshot displays the D-Link web interface for the DCS-5230 camera. At the top, it shows 'Product: DCS-5230' and 'Firmware version: 1.00'. The D-Link logo is prominently displayed. Below the logo is a navigation menu with tabs for 'LIVE VIDEO', 'SETUP', 'MAINTENANCE', 'STATUS', and 'HELP'. The 'MAINTENANCE' tab is selected, leading to the 'SYSTEM' page. The page title is 'DCS-5230 // SYSTEM'. On the left, there is a sidebar menu with options: 'Admin', 'System', 'Firmware Upgrade', and 'Logout'. The main content area is titled 'SYSTEM' and contains the following options and buttons:

- Save To Local Hard Drive: Save Configuration
- Load From Local Hard Drive: [Input Field] Browse... Load Configuration
- Restore To Factory Defaults: Restore Factory Defaults
- Reboot Device: Reboot Device

On the right side, there is a 'Helpful Hints..' section with the text: 'After the factory's default settings have been restored, use the installation wizard software provided with your camera to search and connect to the camera.'

At the bottom of the interface, there is a 'SECURITY' section.

Click **Apply** on this screen to restore the factory default settings. After confirmation, the system will restart and require the DCC program to locate the IP address of the DCS-5230.

Firmware Update

File Path: This option allows you to upgrade the firmware via a web browser. Click on **Browse** to locate the firmware file and then click on **Upgrade** to apply the firmware to the camera.

The screenshot displays the D-Link web interface for a DCS-5230 camera. At the top, it shows 'Product: DCS-5230' and 'Firmware version: 1.00'. The D-Link logo is prominently displayed. Below the logo is a navigation menu with tabs for 'LIVE VIDEO', 'SETUP', 'MAINTENANCE', 'STATUS', and 'HELP'. The 'MAINTENANCE' tab is selected, and the 'Firmware Upgrade' option is highlighted in the left sidebar. The main content area is titled 'FIRMWARE UPGRADE' and contains the following text:

A new firmware upgrade may be available for your IP camera. It is recommended to keep your IP camera firmware up-to-date to maintain and improve the functionality and performance of your internet camera. Click here [D-Link Support Page](#) to check for the latest firmware version available.

To upgrade the firmware on your IP camera, please download and save the latest firmware version from the D-Link Support Page to your local hard drive. Locate the file on your local hard drive by clicking the Browse button. Once you have found and opened the file using the browse button, click the "Upload" button to start the firmware upgrade.

FIRMWARE INFORMATION

Current Firmware Version: 1.00, 3021
Current Product Name: DCS-5230

FIRMWARE UPGRADE

File Path:

On the right side, there is a 'Helpful Hints..' section with the following text:

Firmware upgrade are released periodically to improve the functionality of your IP camera and also to add new features. If you run into a problem with a specific feature of the IP camera, check our support site by clicking [here](#) to check for an upgrade and see if updated firmware is available for your IP camera.

At the bottom of the page, the word 'SECURITY' is visible.

Status

Device Info

The Device Info screen lists the following important settings that are currently set for the DCS-5230:

- Camera Name
- Time & Date
- Firmware Version
- Mac Address
- IP Address
- IP Subnet Mask
- Default Gateway
- Primary DNS
- Secondary DNS
- PPPoE
- DDNS

Product: DCS-5230 Firmware version: 1.00

D-Link

DCS-5230 // LIVE VIDEO SETUP MAINTENANCE STATUS HELP

Device Info

Log

Logout

DEVICE INFO

All of your network connection details are displayed on this page. The firmware version is also displayed here.

Helpful Hints..

This page displays all the information about the camera and network settings.

INFORMATION

Camera Name	DCS-5230
Time & Date	Mon Jun 15 14:51:18 2009
Firmware Version	1.00, 3021
MAC Address	00:03:1B:58:F8:12
IP Address	172.17.5.21
IP Subnet Mask	255.255.255.0
Default Gateway	172.17.5.254
Primary DNS	192.168.168.250
Secondary DNS	192.168.168.201
PPPoE	Disable
DDNS	Disable

SECURITY

Log

The content of the log file reveals useful information about the current configuration and connection logged after the DCS-5230 starts up.

Enable remote log: This option enables the camera to send camera log files to a remote server.

IP Address: The IP address of the remote server.

Port: The port number of the remote log server. The default port is 514.

Current log: View the system log file. The content of the file reveals useful information about camera configuration and connectivity status after the camera boots up.

The screenshot displays the D-Link DCS-5230 web interface. At the top, it shows 'Product: DCS-5230' and 'Firmware version: 1.00'. The D-Link logo is prominently displayed. Below the logo is a navigation menu with tabs for 'LIVE VIDEO', 'SETUP', 'MAINTENANCE', 'STATUS', and 'HELP'. The 'STATUS' tab is selected, and the 'SYSTEM LOG' section is active. The system log contains the following entries:

```

2009-06-14 19:31:36 System is booted up.
2009-06-14 21:04:40 admin is start to watch streaming by HTTP
2009-06-14 21:04:59 admin is start to watch streaming by HTTP
2009-06-14 21:05:23 admin is start to watch streaming by HTTP
2009-06-14 21:05:34 admin is start to watch streaming by HTTP
  
```

Below the log entries are 'Clear' and 'Download' buttons. On the right side of the interface, there is a 'Helpful Hints..' section with the text: 'You can save the log to your local hard drive by clicking the Download button, and you can clear the log by clicking on the Clear button.'

At the bottom of the interface, the word 'SECURITY' is visible.

Help

The help page provides detailed information for the camera's Web interface.

The screenshot displays the D-Link DCS-5230 Web interface. At the top, it shows 'Product: DCS-5230' and 'Firmware version: 1.00'. The D-Link logo is prominently displayed. Below the logo is a navigation bar with tabs for 'LIVE VIDEO', 'SETUP', 'MAINTENANCE', 'STATUS', and 'HELP'. The 'HELP' tab is selected, showing a 'HELP MENU' with links to 'LIVE VIDEO', 'SETUP', 'MAINTENANCE', and 'STATUS'. The 'LIVE VIDEO' section contains a link to 'Camera'. The 'SETUP' section lists various configuration options: 'Setup Wizard', 'Network Setup', 'Wireless Setup', 'Dynamic DNS', 'Image Setup', 'Audio And Video', 'Motion Detection', 'Time and Date', 'Preset Position', 'Recording', 'Snapshot', and 'Digital Output'. The 'MAINTENANCE' section includes 'Admin', 'System', and 'Firmware Upgrade'. The 'STATUS' section includes 'Device Info' and 'Log'. A 'SECURITY' banner is visible at the bottom of the interface.

DCS-5230	LIVE VIDEO	SETUP	MAINTENANCE	STATUS	HELP
Help Menu Logout	HELP MENU LIVE VIDEO SETUP MAINTENANCE STATUS				
	LIVE VIDEO Camera				
	SETUP Setup Wizard Network Setup Wireless Setup Dynamic DNS Image Setup Audio And Video Motion Detection Time and Date Preset Position Recording Snapshot Digital Output				
	MAINTENANCE Admin System Firmware Upgrade				
	STATUS Device Info Log				
SECURITY					

D-ViewCam Installation

D-ViewCam software is included to manage up to 32 cameras simultaneously, send automated e-mail alerts, and record video to your hard drive when motion is detected or according to a set schedule.

Insert the software CD into the CD-ROM drive. The D-ViewCam Installation screen will appear.

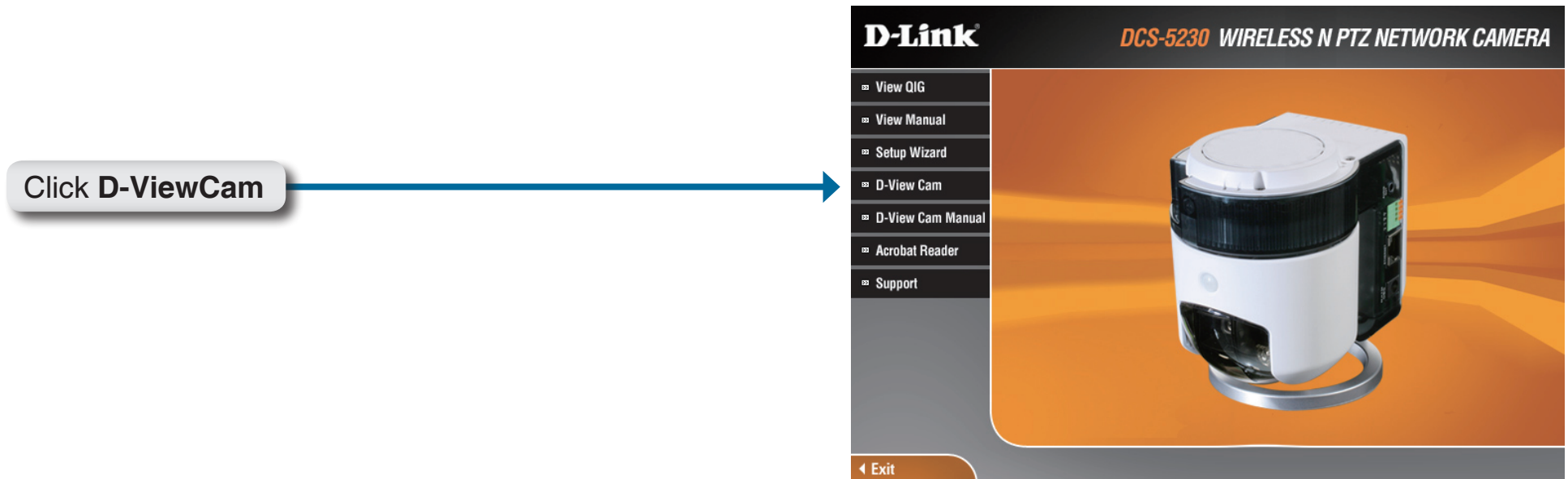

Click **D-ViewCam**

Select a language and click **OK** to continue.



Click **OK**

Click **Next** to continue.

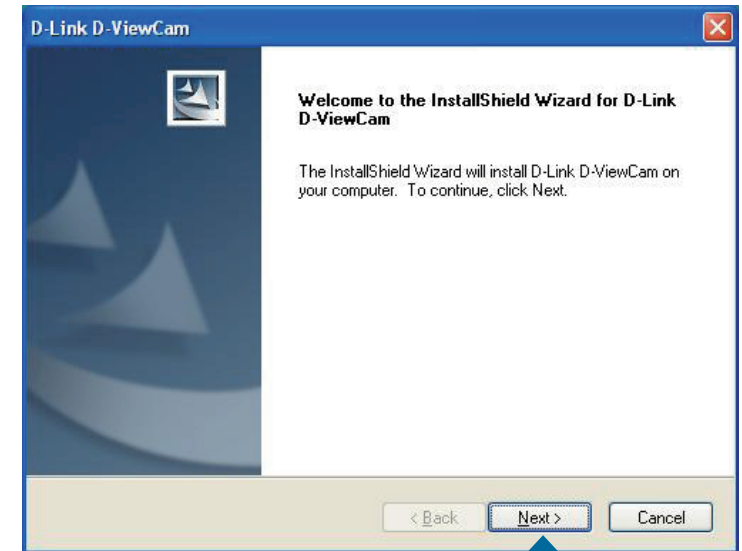

Click **Next**

Click **Browse** to choose a specific folder for the installation, otherwise click **Next** to continue.

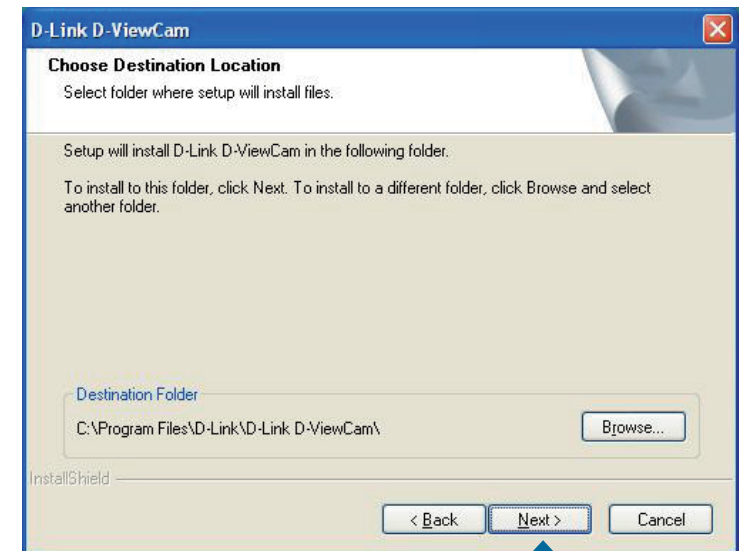

Click **Next**

Click **Next** to start the installation.

Note: The D-ViewCam installation process may take several minutes to complete.

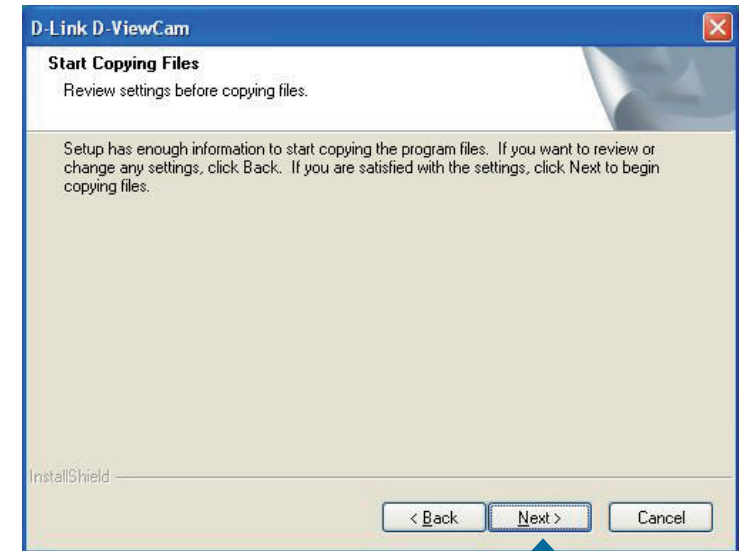

Click **Next**

Click **Finish** to complete the installation.

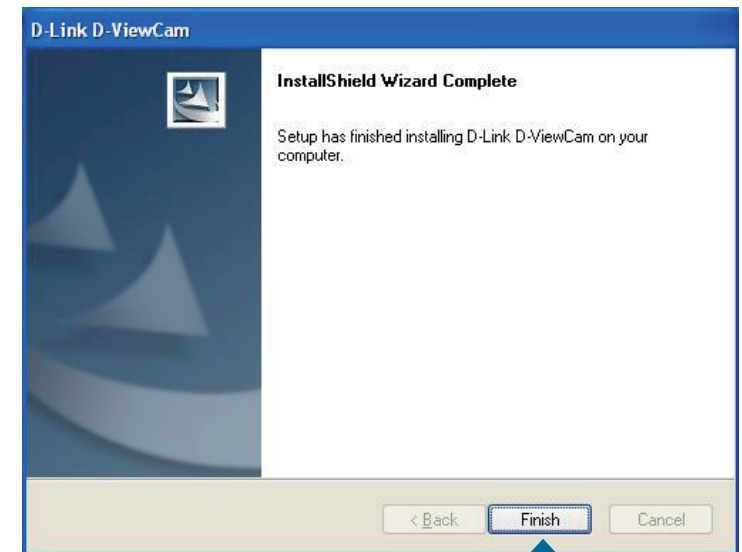

Click **Finish**

Adding a Camera

This section will show you how to add a camera to the D-ViewCam system.

To start D-ViewCam, select **Start > All Programs > D-Link > D-Link D-ViewCam**.



Enter **Admin** as the default user name and leave the password blank. Click to log into the system.

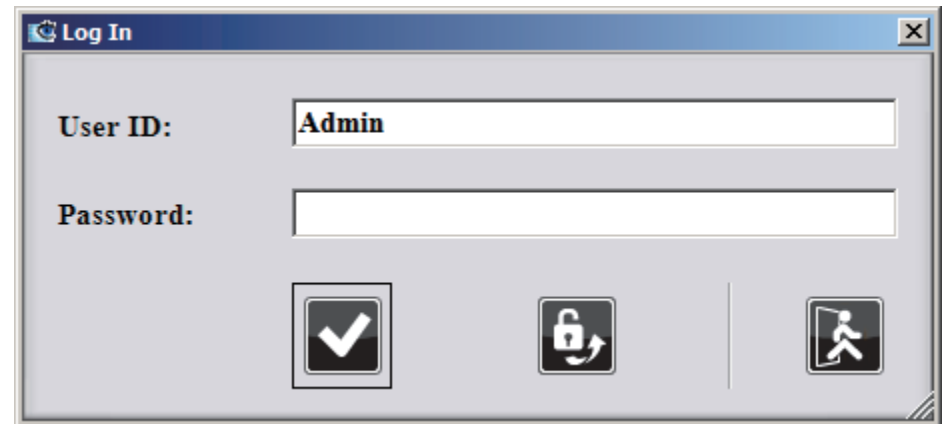

The **Add Camera Wizard** screen will appear. Use this wizard to add your cameras to the D-ViewCam system.

Note: Use the left or right arrow icons for navigation within the wizard.

Click  / **Next** to continue.

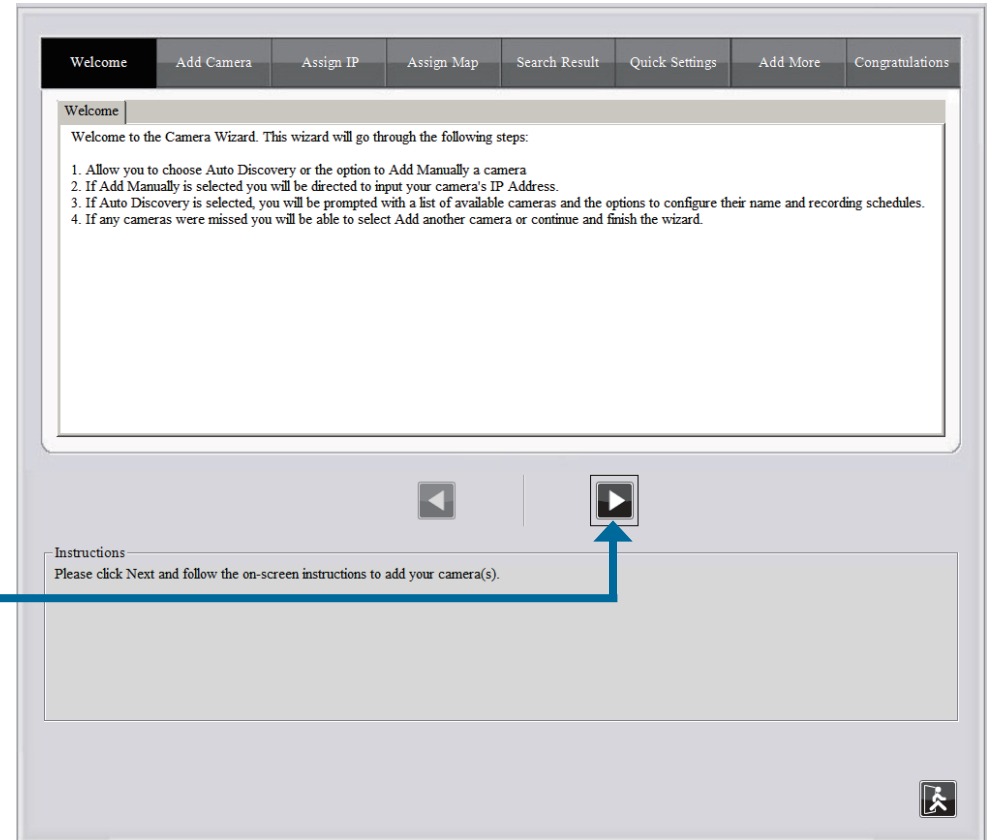

Click **Next**

Choose the method to add your camera(s). You can select **Auto Discovery** to automatically search for your camera(s), or **Add Manually** to add your camera(s) via the camera's IP address.

Click **Next** to continue.

If you selected **Auto Discovery**, the system will search all available cameras that are located on the same LAN with same subnet. The system will place all the cameras under the default map called **My Map**.

Click **Next** to continue.

If you selected **Add Manually**, enter the IP address or domain name, http port, model name, camera ID and password.

Click the “?” button to auto-detect the camera's model name. The model name will appear in the **Model Name** box.

Click **Next** to continue.

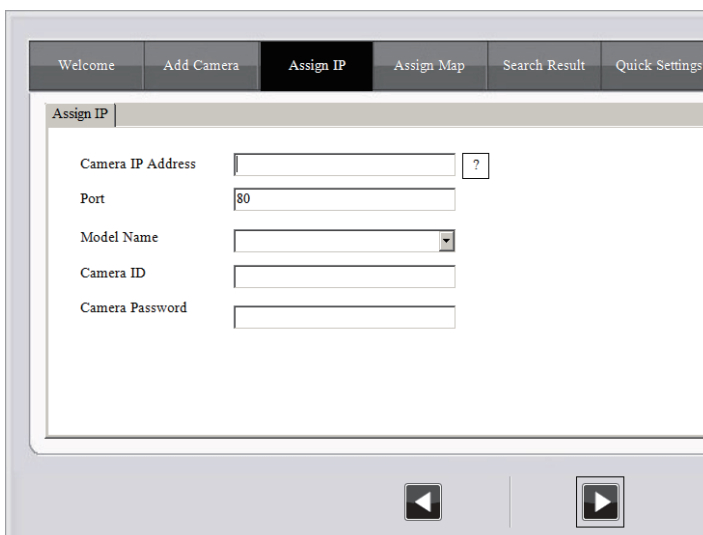
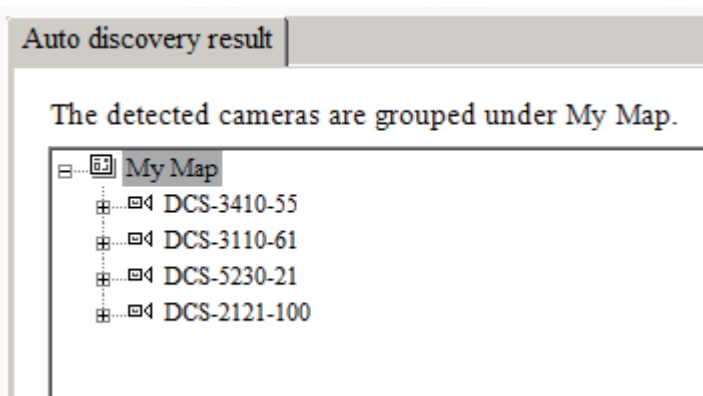
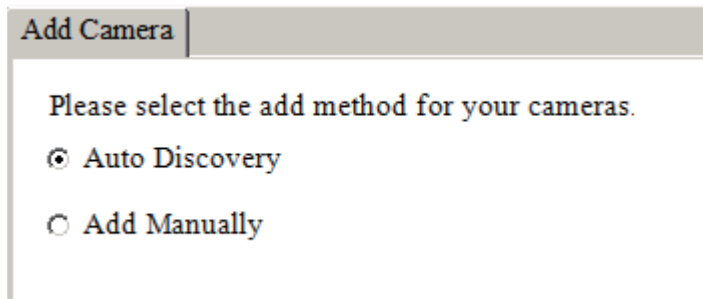

D-ViewCam shows the detected IP camera(s) information. You can choose and schedule recordings for each camera.

- **24/7 Continuous Recording:** Continuous recording - 24 hours a day, 7 days a week.
- **24/7 Motion Detection Recording:** Continuous monitoring, but records ONLY when motion is detected.
- **Office Hours Only:** Continuously monitors during office hours (08:00 AM to 06:00 PM) and records ONLY when motion is detected.
- **Non-Office Hours Only:** Continuously monitors during non-office hours (06:00 PM to 08:00 AM) and records ONLY when motion is detected.

Quick Settings

The discovered cameras information showed as below:

Camera Name	Model	Schedule Recording Type	Status	IP Address	MAC Address
DCS-3410-55	DCS-3410	None	Active	172.17.5.55	00031B66665C
DCS-3110-61	DCS-3110	None	Active	172.17.5.61	001CF078837E
DCS-5230-21	DCS-5230	None	Active	172.17.5.21	00031B58F812
DCS-2121-100	DCS-2121	None	Active	172.17.5.100	0021917D10...

Click **Next** to continue.

Select **Yes** to add other camera(s), or select **No** if you have no additional camera(s) to be added.

Click **Next** to continue.

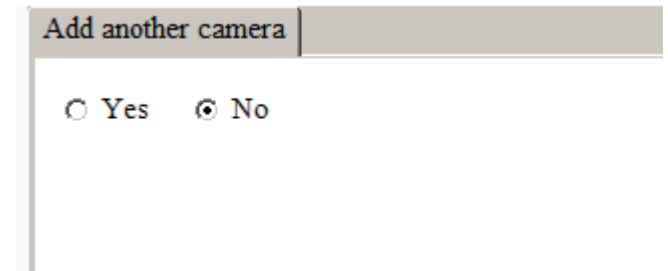

The **Add Camera wizard** is now complete. Click **Close** to access the D-ViewCam's main screen.

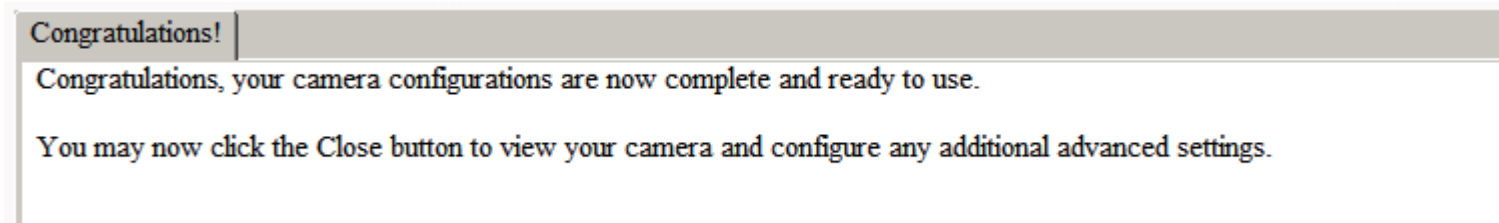

Your D-ViewCam Installation is Complete!

Note: Please refer to the D-ViewCam user manual for information about using the D-ViewCam.

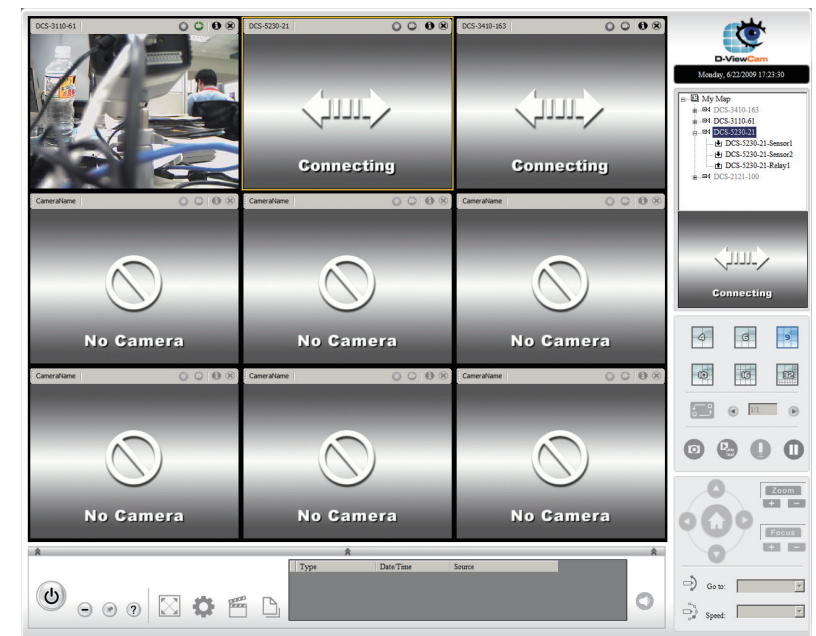

Wireless Security

This section will show you the different levels of security you can use to protect your data from intruders.

The DCS-5230 offers the following types of security:

- WPA-PSK (Pre-Shared Key)
- WEP (Wired Equivalent Privacy)

What is WEP?

WEP stands for Wired Equivalent Privacy. It is based on the IEEE 802.11 standard and uses the RC4 encryption algorithm. WEP provides security by encrypting data over your wireless network so that it is protected as it is transmitted from one wireless device to another.

To gain access to a WEP network, you must know the key. The key is a string of characters that you create. When using WEP, you must determine the level of encryption. The type of encryption determines the key length. 128-bit encryption requires a longer key than 64-bit encryption. Keys are defined by entering in a string in HEX (hexadecimal - using characters 0-9, A-F) or ASCII (American Standard Code for Information Interchange – alphanumeric characters) format. ASCII format is provided so you can enter a string that is easier to remember. The ASCII string is converted to HEX for use over the network. Four keys can be defined so that you can change keys easily.

What is WPA?

WPA, or Wi-Fi Protected Access, is a Wi-Fi standard that was designed to improve the security features of WEP (Wired Equivalent Privacy).

The 2 major improvements over WEP:

- Improved data encryption through the Temporal Key Integrity Protocol (TKIP). TKIP scrambles the keys using a hashing algorithm and, by adding an integrity-checking feature, ensures that the keys haven't been tampered with. WPA2 is based on 802.11i and uses Advanced Encryption Standard instead of TKIP.
- User authentication, which is generally missing in WEP, through the extensible authentication protocol (EAP). WEP regulates access to a wireless network based on a computer's hardware-specific MAC address, which is relatively simple to be sniffed out and stolen. EAP is built on a more secure public-key encryption system to ensure that only authorized network users can access the network.

WPA-PSK/WPA2-PSK uses a passphrase or key to authenticate your wireless connection. The key is an alpha-numeric password between 8 and 63 characters long. The password can include symbols (!?*&_) and spaces. This key must be the exact same key entered on your wireless router or access point.

Using & Configuring the DCS-5230 with a NAT Router

D-Link's DCS-5230 is a versatile and cost effective Internet Camera offering both video and audio monitoring. It can also serve as a powerful surveillance system in security applications. The DCS-5230 can be used with any wired or 802.11n/g wireless router. This section explains how to view the camera from either the Internet or from inside your internal network.

Materials Needed:

- 1 DCS-5230 Internet Camera
- 1 Ethernet Cable
- A Wired or Wireless router such as the D-Link DIR-655 Wireless Router
- Ethernet based PC for system configuration

Setting up the DCS-5230 for Use Behind a Router

Installing a DCS-5230 Internet Camera on your network is an easy 4–step procedure:

1. Assign a Local IP Address to Your Internet Camera
2. View the Internet Camera Using Your Internet Explorer Web Browser
3. Access the Router with Your Web Browser
4. Open Virtual Server Ports to Enable Remote Image Viewing

This section is designed to walk you through the setup process for installing your camera behind a router and enable remote video viewing. For the basic setup of the DCS-5230, follow the steps outlined in the Quick Installation Guide.

After you have completed the setup of the DCS-5230 outlined in the Quick Installation Guide you will have an operating camera that has an assigned IP Address. Because you are using a router to share the Internet with one or more PCs, the IP Address assigned to the Internet Camera will be a local IP Address. This allows viewing within your Local Area Network (LAN) until the router is configured to allow remote viewing of the camera over the Internet.

1. Assign a Local IP Address to Your Camera

Run the setup wizard from the CD included with the DCS-5230. Follow the steps in the Quick Installation Guide to configure the DCS-5230. The camera will be assigned a local IP Address that allows it to be recognized by the router. Write down this IP Address for future reference.

2. View the Internet Camera Using Your Internet Explorer Web Browser

Run your Internet Explorer Web browser. In the address bar, type in the IP Address that was assigned to the Internet Camera by the DCC program. The DCS-5230 Live Video Page appears with a window displaying live video from the camera. You are able to view this screen from any PC running Internet Explorer on your LAN.

Click on the **Setup** button on the left side of the display. Scroll to the bottom of the Network Setup page (see page 29) to display the ports used by HTTP and Streaming audio and video.

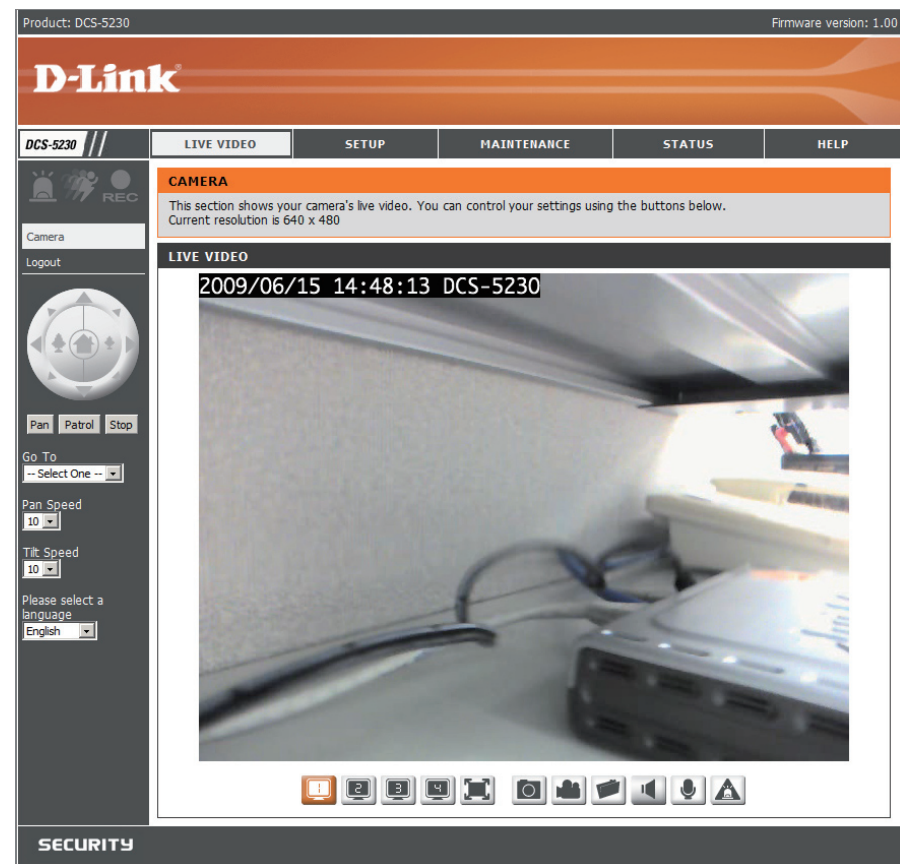

The **Setup > Network Setup** page displays the port settings for your camera. If necessary, these ports can be changed if they are already in use by other devices (e.g. in a multiple camera environment).

Note: Both the HTTP port and RTSP port are required to be opened for the DCS-5230. Please refer to page 68 on how to open ports in the router.

The screenshot shows the D-Link DCS-5230 web interface. At the top, it displays 'Product: DCS-5230' and 'Firmware version: 1.00'. The D-Link logo is prominently featured. Below the logo is a navigation menu with tabs for 'LIVE VIDEO', 'SETUP', 'MAINTENANCE', 'STATUS', and 'HELP'. The 'SETUP' tab is selected, and the 'NETWORK SETUP' sub-tab is active. The main content area is divided into two sections: 'LAN SETTINGS' and 'PORT DETAIL SETTINGS'. In the 'LAN SETTINGS' section, 'DHCP Connection' is selected, and the IP address is set to 192.168.0.20. In the 'PORT DETAIL SETTINGS' section, the HTTP port is set to 80 and the RTSP port is set to 554. There are 'Save Settings' and 'Don't Save Settings' buttons at the bottom of each section. On the right side, there is a 'Helpful Hints...' section with several tips regarding DHCP, UPnP, and port allocation.

Product	DCS-5230	Firmware version	1.00
D-Link			
DCS-5230	LIVE VIDEO	SETUP	MAINTENANCE
STATUS	HELP		Helpful Hints..
Setup Wizard	NETWORK SETUP		
Network Setup	You can configure your LAN and Internet settings here.		
Wireless Setup	Save Settings Don't Save Settings		
Dynamic DNS	LAN SETTINGS		
Image Setup	LAN		
Audio and Video	<input checked="" type="radio"/> DHCP Connection <input type="radio"/> Static IP Address		
Motion Detection	IP Address <input type="text" value="192.168.0.20"/>		
Time and Date	Subnet Mask <input type="text" value="255.255.255.0"/>		
Preset Position	Default Gateway <input type="text" value="192.168.0.1"/>		
Recording	Primary DNS <input type="text"/>		
Snapshot	Secondary DNS <input type="text"/>		
Digital Output	<input checked="" type="checkbox"/> Enable UPnP		
Logout	<input type="checkbox"/> Enable PPPoE		
	User Name <input type="text"/>		
	Password <input type="text"/>		
	Confirm password <input type="text"/>		
	PORT DETAIL SETTINGS		
	HTTP port	<input type="text" value="80"/>	
	RTSP port	<input type="text" value="554"/>	
	<input type="checkbox"/> User authentication		
	Save Settings Don't Save Settings		
SECURITY			

Helpful Hints..

- Select 'DHCP Connection' if you are running a DHCP server on your network and would like an IP address assigned to your camera automatically.
- 'Enabling UPnP' settings will allow you to configure your camera as an UPnP device in the network.
- 'Port Detail Settings' allow you to specify the ports you reserve for both HTTP and RTSP Streaming.
- 'HTTP Port' is the port you allocate in order to connect to the camera via a standard web browser.
- 'RTSP Port' is the port you allocate in order to connect to a camera by using streaming mobile device(s), such as a mobile phone or PDA.

Router Set-Up and Installation

The following steps generally apply to any router that you have on your network. The D-Link DIR-655 is used as an example to clarify the configuration process. Configure the initial settings of the DIR-655 by following the steps outlined in the DIR-655 Quick Installation Guide.

3. Access the Router with Your Web Browser

If you have cable or DSL Internet service, you will most likely have a dynamically assigned WAN IP Address. 'Dynamic' means that your router's WAN IP address can change from time to time depending on your ISP. A dynamic WAN IP Address identifies your router on the public network and allows it to access the Internet. To find out what your router's WAN IP Address is, go to the Status menu on your router and locate the WAN information for your router (as shown on the next page). The WAN IP Address will be listed. This will be the address that you will need to type in your Web browser to view your camera over the Internet.

Your WAN IP Address will be listed on the router's **Status > Device Info** page.

The screenshot shows the D-Link DIR-655 web interface. The top navigation bar includes tabs for SETUP, ADVANCED, TOOLS, STATUS, and SUPPORT. The left sidebar contains a menu with options like DEVICE INFO, LOGS, STATISTICS, INTERNET SESSIONS, WIRELESS, and WISH SESSIONS. The main content area is titled 'DEVICE INFORMATION' and contains the following sections:

- GENERAL:** Time: 2007/10/10 PM 10:10:33, Firmware Version: 1.02, 2006/10/13
- WAN:** Connection Type: DHCP Client, QoS Engine: Active, Cable Status: connected, Network Status: connected, Connection Up Time: N/A, MAC Address: 00:19:5B:03:04:E9, IP Address: 210.21.33.48, Subnet Mask: 255.255.255.248, Default Gateway: 210.21.33.254, Primary DNS Server: 168.95.1.1, Secondary DNS Server: 0.0.0.0
- LAN:** MAC Address: 00:19:5B:03:04:E8, IP Address: 192.168.0.1, Subnet Mask: 255.255.255.0, DHCP Server: Enabled
- WIRELESS LAN:** Wireless Radio: Enabled, WISH: Active, MAC Address: 00:19:5B:03:04:E8, Network Name (SSID): dlink, Channel: 4, Security Mode: Disabled, Wi-Fi Protected Setup: Enabled/Not Configured
- LAN COMPUTERS:** A table with columns for IP Address, Name (if any), and MAC. One entry is shown: IP Address: 192.168.0.155, Name: end_user, MAC: 00:05:5d:ce:b3:8d
- IGMP MULTICAST MEMBERSHIPS:** Multicast Group Address: 239.255.255.250

On the right side of the interface, there is a 'Support' section with 'Helpful Hints...' and 'More...' links.

Note: Because a dynamic WAN IP can change from time to time depending on your ISP, you may want to obtain a Static IP address from your ISP. A Static IP address is a fixed IP address that will not change over time and will be more convenient for you to use to access your camera from a remote location. The Static IP Address will also allow you to access your camera attached to your router over the Internet.

4. Open Virtual Server Ports to Enable Remote Image Viewing

The firewall security features built into the DIR-655 router prevent users from accessing the video from the DCS-5230 over the Internet. The router connects to the Internet over a series of numbered ports. The ports normally used by the DCS-5230 are blocked from access over the Internet. Therefore, these ports need to be made accessible over the Internet. This is accomplished using the Virtual Server function on the DIR-655 router. The Virtual Server ports used by the camera must be opened through the router for remote access to your camera. Virtual Server is accessed by clicking on the **Advanced** tab of the router screen.

Follow these steps to configure your router's Virtual Server settings:

1. Click **Enabled**.
2. Enter a different name for each entry.
3. Enter your camera's local IP Address (e.g., 192.168.0.120 in the example in step 2 on page 69) in the Private IP field.
4. Select TCP for HTTP port, both (TCP and UDP) for RTSP and both (TCP and UDP) for 5556 - 5559 ports.
5. If you are using the default camera port settings, enter 80 into the Public and Private Port section, click **Apply**.
6. Scheduling should be set to Always so that the camera images can be accessed at any time.

Repeat the above steps adding the port 554 to both the Public and Private Port sections. A check mark appearing before the entry name will indicate that the ports are enabled.

Important: Some ISPs block access to port 80 and other commonly used Internet ports to conserve bandwidth. Check with your ISP so that you can open the appropriate ports accordingly. If your ISP does not pass traffic on port 80, you will need to change the port the camera uses from 80 to something else, such as 800. Not all routers are the same, so refer to your user manual for specific instructions on how to open ports.

Enter valid ports in the Virtual Server section of your router. Please make sure to check the box next to the camera name on the Virtual Server List to enable your settings.

Product Page: DIR-655 Hardware Version: A1 Firmware Version: 1.02

D-Link

DIR-655 // SETUP ADVANCED TOOLS STATUS SUPPORT

VIRTUAL SERVER

The Virtual Server option allows you to define a single public port on your router for redirection to an internal LAN IP Address and Private LAN port if required. This feature is useful for hosting online services such as FTP or Web Servers.

Save Settings Don't Save Settings

24--VIRTUAL SERVERS LIST

	Name	IP Address	Port	Traffic Type	Schedule	Inbound Filter
<input checked="" type="checkbox"/>	DCS-5220	192.168.0.120	80	TCP	Always	Allow All
<input checked="" type="checkbox"/>	DCS-5220	192.168.0.120	554	TCP	Always	Allow All
<input type="checkbox"/>		0.0.0.0	0	TCP	Always	Allow All

Helpful Hints...

Check the **Application Name** drop down menu for a list of predefined server types. If you select one of the predefined server types, click the arrow button next to the drop down menu to fill out the corresponding field.

You can select a computer from the list of DHCP clients in the **Computer Name** drop down menu, or you can manually enter the IP address of the computer at which you would like to open the specified port.

Select a schedule for when the virtual server will be enabled. If you do not see the schedule you need in

Using & Configuring 3G Compatible Cell Phones

To enable mobile device video streaming, you will need to configure for mobile viewing (see below).

DCS-5230 //	LIVE VIDEO	SETUP	MAINTENANCE	STATUS	HELP													
Setup Wizard	<div style="border: 1px solid orange; padding: 5px;"> <p>AUDIO AND VIDEO</p> <p>You may configure night mode, audio, and video settings (4 video profiles) here. Profile 3 has been set as the for snapshot while profile 4 is set for your mobile phone or PDA device.</p> <p>There are three main video sensor outputs/ display system ('VGA', 'XGA', 'SXGA') and provides their own resolution settings for selections.</p> <p style="text-align: center;"> <input type="button" value="Save Settings"/> <input type="button" value="Don't Save Settings"/> </p> </div>				Helpful Hints..													
Network Setup					<p>VIDEO SENSOR</p> <p>Sensor Output</p> <p> <input checked="" type="radio"/> VGA (640x480) <input type="radio"/> XGA (1024x768) <input type="radio"/> SXGA (1280x1024) </p>	Each 'Sensor Output' serves with 3 selections of 'Resolution': VGA : 640x480, 320x240, 160x120 XGA : 1024x768, 512x384, 256x192 SXGA : 1280x1024, 640x512, 320x256												
Wireless Setup					<p>VIDEO PROFILE 1</p> <table border="1"> <thead> <tr> <th>Encode Type</th> <th>Resolution</th> <th>FPS</th> <th>bps</th> <th>JPEG Quality</th> <th>RTSP URL</th> </tr> </thead> <tbody> <tr> <td>MPEG4</td> <td>640x480</td> <td>30</td> <td>2 Mbps</td> <td>Excellent</td> <td>play1.sdp</td> </tr> </tbody> </table>	Encode Type	Resolution	FPS	bps	JPEG Quality	RTSP URL	MPEG4	640x480	30	2 Mbps	Excellent	play1.sdp	<p>Encode Type - Select the video codec 'JPEG' or 'MPEG4'.</p> <p>Resolution - 3 options depend on display system used.</p> <p>FPS (Frame per second) - 30fps(NTSC) is the highest video quality for this camera.</p> <p>bps (bit per second) - Select a fixed bandwidth for your camera operation. Higher value means a higher quality image but consumes more network bandwidth.</p> <p>JPEG Quality - Set the quality of JPEG image.</p> <p>RTSP URL - The URL used to connect to the camera when viewing from a mobile device or PDA. (i.e. rtsp://EXAMPLE.dlinkddns.com/3gpp).</p>
Encode Type					Resolution	FPS	bps	JPEG Quality	RTSP URL									
MPEG4					640x480	30	2 Mbps	Excellent	play1.sdp									
Dynamic DNS					<p>VIDEO PROFILE 2</p> <table border="1"> <thead> <tr> <th>Encode Type</th> <th>Resolution</th> <th>FPS</th> <th>bps</th> <th>JPEG Quality</th> <th>RTSP URL</th> </tr> </thead> <tbody> <tr> <td>MPEG4</td> <td>320x240</td> <td>30</td> <td>256 Kbps</td> <td>Good</td> <td>play2.sdp</td> </tr> </tbody> </table>	Encode Type	Resolution	FPS	bps	JPEG Quality	RTSP URL	MPEG4	320x240	30	256 Kbps	Good	play2.sdp	
Encode Type					Resolution	FPS	bps	JPEG Quality	RTSP URL									
MPEG4					320x240	30	256 Kbps	Good	play2.sdp									
Image Setup					<p>VIDEO PROFILE 3</p> <table border="1"> <thead> <tr> <th>Encode Type</th> <th>Resolution</th> <th>FPS</th> <th>bps</th> <th>JPEG Quality</th> <th>RTSP URL</th> </tr> </thead> <tbody> <tr> <td>JPEG</td> <td>640x480</td> <td>10</td> <td>--</td> <td>Good</td> <td>play3.sdp</td> </tr> </tbody> </table>	Encode Type	Resolution	FPS	bps	JPEG Quality	RTSP URL	JPEG	640x480	10	--	Good	play3.sdp	
Encode Type					Resolution	FPS	bps	JPEG Quality	RTSP URL									
JPEG	640x480	10	--	Good	play3.sdp													
Audio and Video	<p>VIDEO PROFILE 4 FOR MOBILE DEVICE ONLY</p> <table border="1"> <thead> <tr> <th>Encode Type</th> <th>Resolution</th> <th>FPS</th> <th>bps</th> <th>JPEG Quality</th> <th>RTSP URL</th> </tr> </thead> <tbody> <tr> <td>MPEG4</td> <td>160x120</td> <td>5</td> <td>64 Kbps</td> <td>--</td> <td>3gpp</td> </tr> </tbody> </table>	Encode Type	Resolution	FPS	bps	JPEG Quality	RTSP URL	MPEG4	160x120	5	64 Kbps	--	3gpp					
Encode Type	Resolution	FPS	bps	JPEG Quality	RTSP URL													
MPEG4	160x120	5	64 Kbps	--	3gpp													
Motion Detection	<p>NIGHT MODE</p> <p>When the Night Mode is selected, the actual frame rate might lower than Max Frame Rate setting above in dim environment.</p> <p>Enable Night Mode <input checked="" type="checkbox"/></p> <p>Shutter <input type="text" value="1/15"/> Second</p> <p>IR LED <input type="text" value="Auto"/></p>	<p>Night Mode - Check Night Mode if your camera is in a dim light area and you need to improve the video quality.</p> <p>Audio Setup - To switch the external speaker and microphone on/off or adjust the volume.</p> <p>Enable Speaker - Enabling this feature to allow you to talk using PC's microphone and your voice to be transmitted to the external speaker connected to the camera.</p> <p>Speaker Volume - You can adjust the speaker volume using the volume level setting.</p> <p>Enable Microphone - Enabling this feature to hear audio from the IP Camera's microphone.</p>																
Time and Date	<p>AUDIO SETUP</p> <p>Enable Speaker <input checked="" type="checkbox"/></p> <p>Volume <input type="text" value="50"/></p> <p>Enable Microphone <input checked="" type="checkbox"/></p> <p>Volume <input type="text" value="50"/></p>																	
Preset Position																		
Recording																		
Snapshot																		
Digital Output																		
Logout																		

Play from RealPlayer

The following steps are based on a Nokia 6630 cell phone.

Press the Menu button and select **Media**

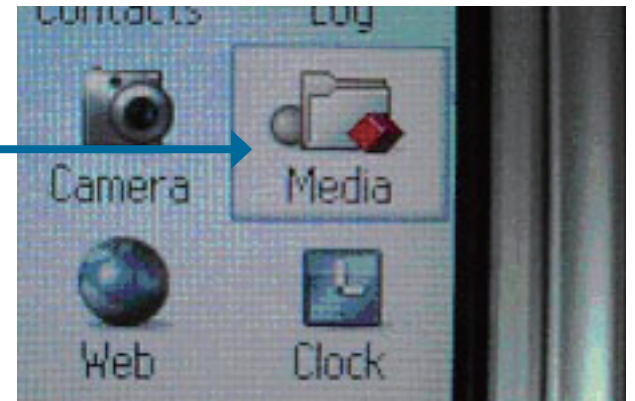

Select **Open**

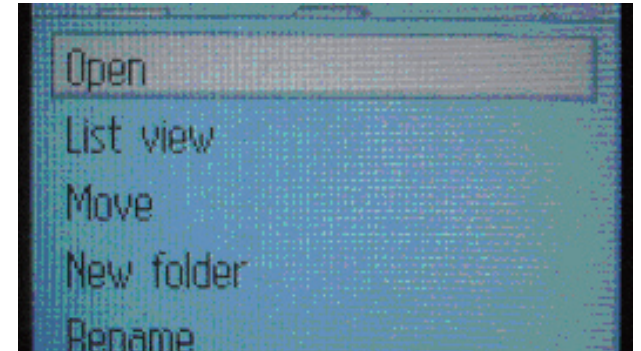

Select **RealPlayer**

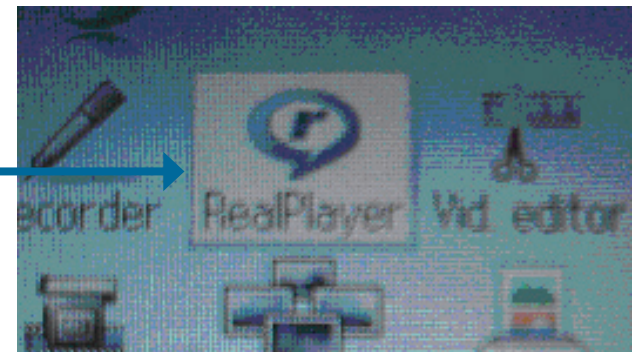

Select **Open**

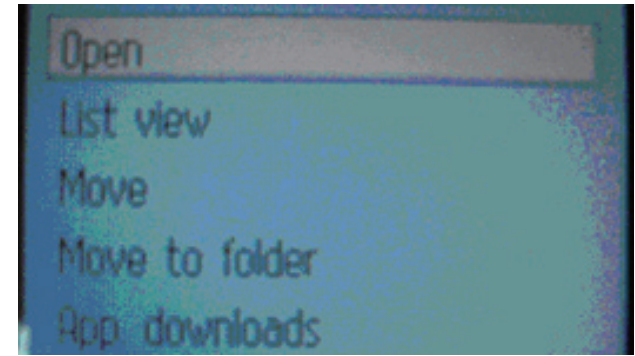

When RealPlayer opens, press **Options**

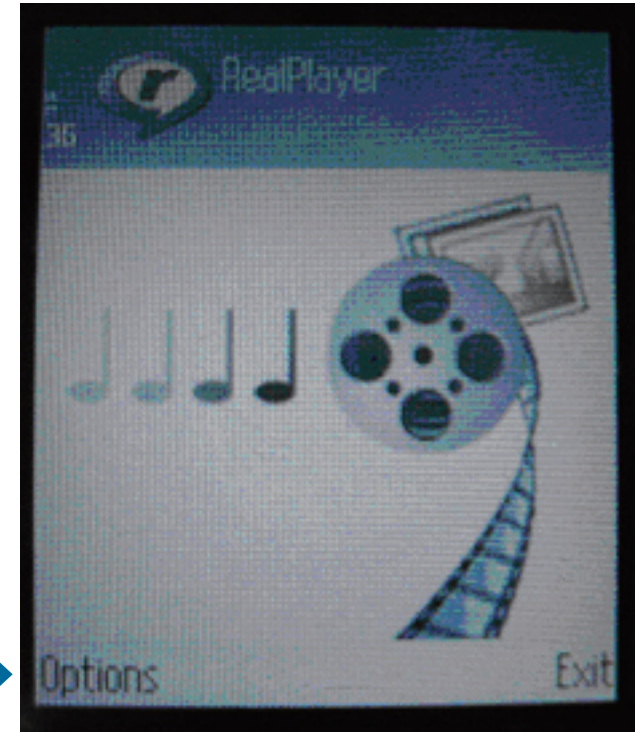

Select **Download**

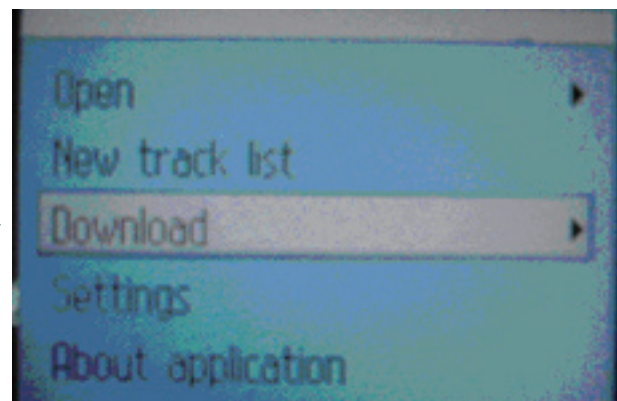

Select **Video Clips**

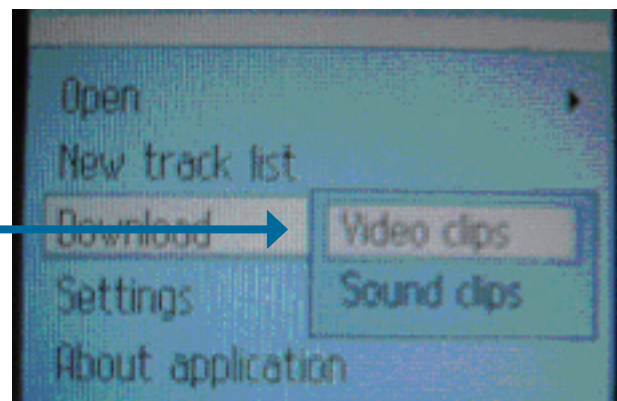

Note: 71.34.50.5 is the camera's IP address in this sample.

Press **Options**

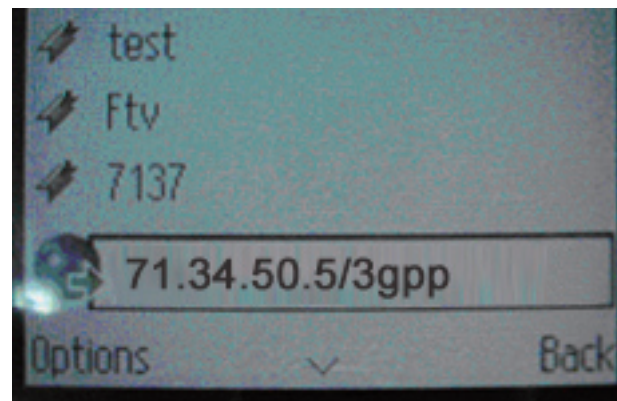

Select **Navigation Options**

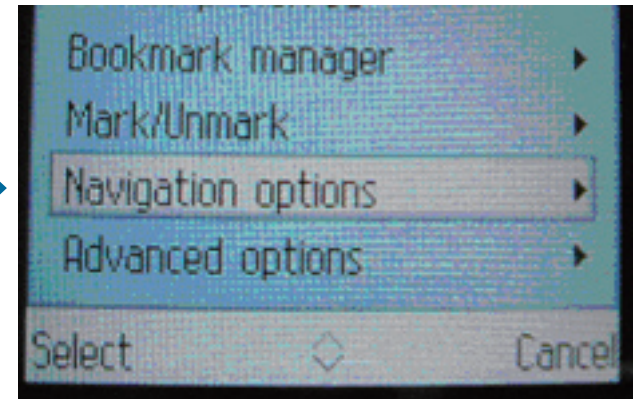

Select **Go to web address**

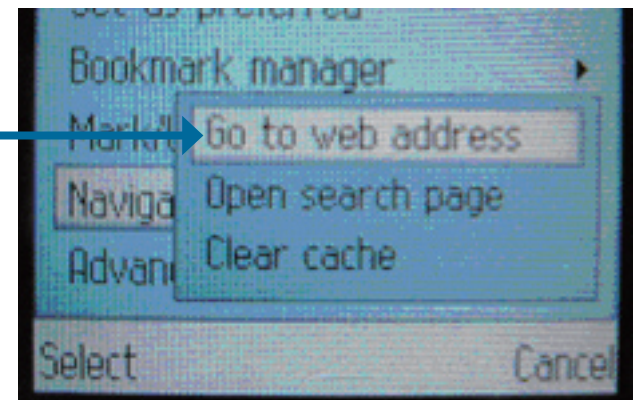

Input your rtsp address

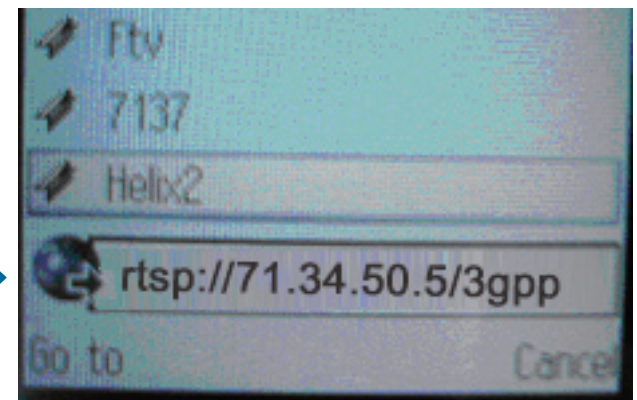

Press **Yes**, and allow Connection and Loading of the streaming video.

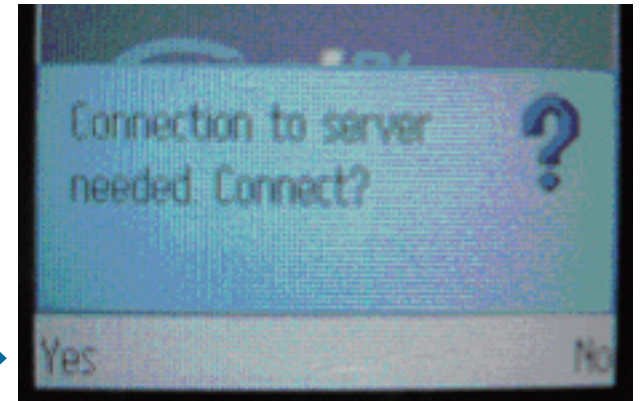

Enjoy streaming video on your cellphone.



Play from PVPlayer

Press the Menu button and select **PVPlayer**

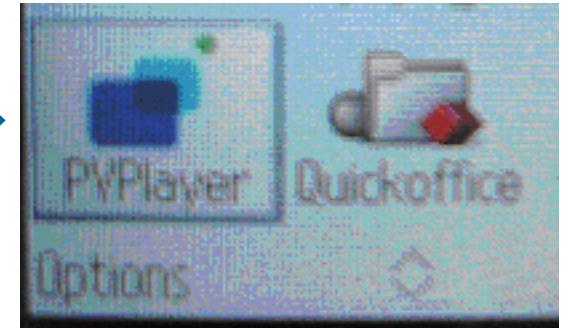

Select **Open**

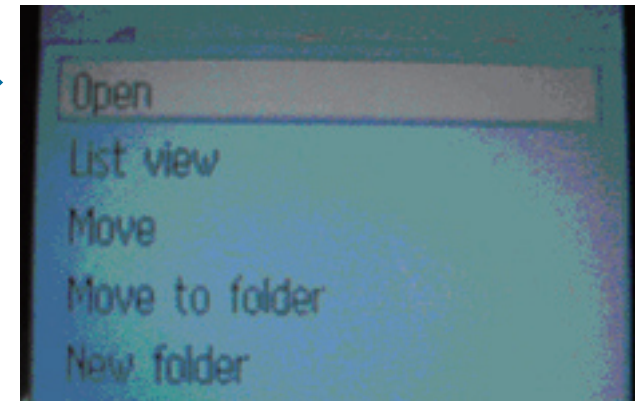

Press the **Options** button

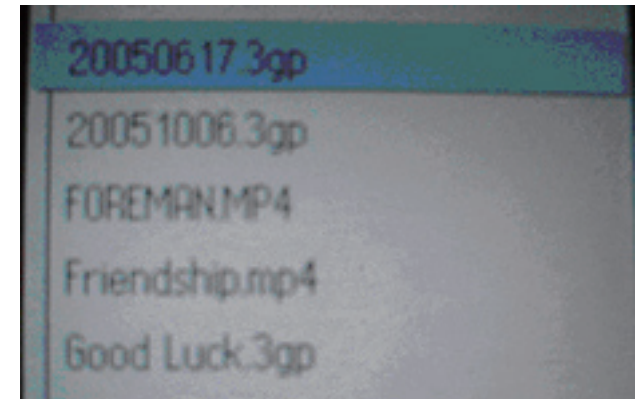

Select **Open location**

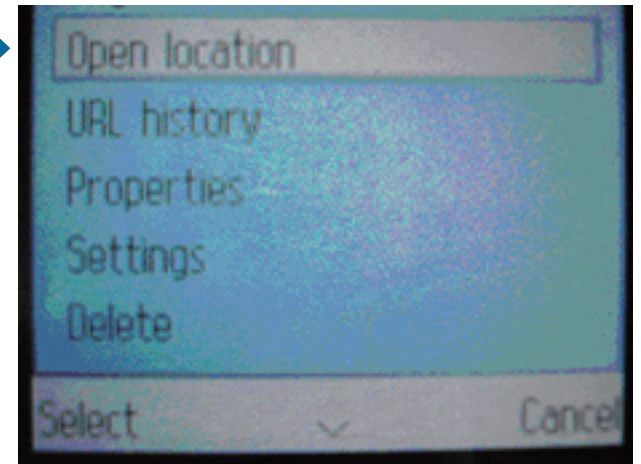

Input your rtsp address

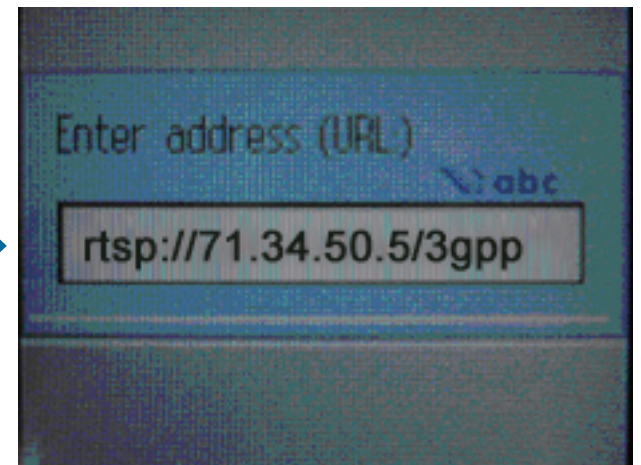

Note: 71.34.50.5 is the camera's IP address in this sample.

Enjoy streaming video on your cellphone.



Troubleshooting

1 What is an Internet Camera?

The Internet Camera is a stand-alone system connecting directly to an Ethernet or Fast Ethernet network. It differs from a conventional PC Camera, the Internet Camera is an all-in-one system with built-in CPU and Web-based solutions providing a low cost solution that can transmit high quality video images for monitoring. The Internet Camera can be managed remotely, accessed and controlled from any PC/Notebook over an Intranet or the Internet from a Web browser.

2. What is the maximum number of users that can be allowed to access DCS-5230 simultaneously?

The maximum number of users that can log onto the Internet Camera at the same time is 10. Please keep in mind the overall performance of the transmission speed will slow down when many users are logged on.

3. What algorithm is used to compress the digital image?

The Internet Camera utilizes MPEG-4 Simple Profile Mode image compression technology to provide high quality images.

4. Can I capture still images from the Internet Camera?

Yes you are able to capture still images with the snapshot function from the software application CD supplied with the Internet Camera or with the snapshot function on the Home page using an Internet browser.

5. Can the Internet Camera be used outdoors?

The Internet Camera is not weatherproof, and needs to be equipped with a weatherproof case in order to be used outdoors (recommended).

6. When physically connecting the Internet Camera to a network what network cabling is required?

The Internet Camera uses Category 5 UTP cable allowing 10 Base-T and 100 Base-T networking.

7. Can the Internet Camera be setup as a PC-cam on a computer?

No, the DCS-5230 Internet Camera is used only on a wireless 802.11n/g, Ethernet, or Fast Ethernet network.

8. Can the DCS-5230 be connected to the network if it consists of only private IP addresses?

Yes, the Internet Camera can be connected to a LAN with private IP addresses.

9. Can the DCS-5230 be installed and work if a firewall exists on the network?

If a firewall exists on the network, port 80 needs to be opened for ordinary data communication. The DCS-5230 uses HTTP port and RTSP port to stream video data. These ports (or the ports you specify from the Advanced Tab in the Configuration screen if you change the default ports) need to be opened in the firewall device. Please refer to page 68 for more information.

10. Why am I unable to access the DCS-5230 from a Web browser?

If a router or firewall is used on the network, the correct ports for the DCS-5230 may not be configured on the router or firewall. To correct the problem, you need to determine if the DCS-5230 is behind a router or firewall and if the router or firewall is properly configured for the ports the DCS-5230 is using. Refer to page 68 for help in opening the correct ports on a router or firewall for use with the DCS-5230.

Other possible problems might be due to the network cable. Try replacing your network cable. Test the network interface of the product by connecting a local computer to the unit, utilizing a Ethernet crossover cable. If the problem is not solved the Internet Camera might be faulty.

11. Why does the Internet Camera work locally but not externally?

This might be caused by network firewall protection. The firewall may need to have some settings changed in order for the Internet Camera to be accessible outside your local LAN. Check with the Network Administrator for your network.

Make sure that the Internet Camera is not conflicting with any Web server you may have running on your network. The default router setting might be a possible reason. Check that the configuration of the router settings allow the Internet Camera to be accessed outside your local LAN. Please refer to page 68 for more information.

12. I connected the Internet Camera directly to a computer with a cross-over cable Ethernet cable and received the following Windows error upon running the Installation Wizard:

This Windows error will occur if the Internet Camera is connected to a computer that is not properly configured with a valid IP address. Turn off DHCP from the Network Settings in Windows® and configure the computer with a valid IP address, or connect the camera to a router with DHCP enabled.



13. Why does a series of broad vertical white lines appear throughout the image?

It could be that the CMOS sensor has become overloaded when it has been exposed to bright lights such as direct exposure to sunlight or halogen lights. Reposition the Internet Camera into a more shaded area immediately as prolonged exposure to bright lights will damage the CMOS sensor.

14. Noisy images occur. How can I solve the problem?

The video images might be noisy if the Internet Camera is used in a very low light environment. To solve this issue you need more lighting.

15. The images appear to be of poor quality, how can I improve the image quality?

Make sure that your computer's display properties are set above 256 colors. Using 16 or 256 colors on your computer will produce dithering artifacts in the image, making the image appear to be of poor quality.

The configuration on the Internet Camera image display is incorrect. Through the **Image Setup** section of the Web management you need to adjust the image related parameters such as brightness, contrast, hue and power line frequency for fluorescent light. Please refer to the **Image Setup** section on Page 33 for detailed information.

Wireless Basics

D-Link wireless products are based on industry standards to provide easy-to-use and compatible high-speed wireless connectivity within your home, business or public access wireless networks. Strictly adhering to the IEEE standard, the D-Link wireless family of products will allow you to securely access the data you want, when and where you want it. You will be able to enjoy the freedom that wireless networking delivers.

A wireless local area network (WLAN) is a cellular computer network that transmits and receives data with radio signals instead of wires. Wireless LANs are used increasingly in both home and office environments, and public areas such as airports, coffee shops and universities. Innovative ways to utilize WLAN technology are helping people to work and communicate more efficiently. Increased mobility and the absence of cabling and other fixed infrastructure have proven to be beneficial for many users.

Under many circumstances, it may be desirable for mobile network devices to link to a conventional Ethernet LAN in order to use servers, printers or an Internet connection supplied through the wired LAN. A Wireless Router is a device used to provide this link.

What is Wireless?

Wireless or WiFi technology is another way of connecting your computer to the network without using wires. WiFi uses radio frequency to connect wirelessly, so you have the freedom to connect computers anywhere in your home or office network.

Why D-Link Wireless?

D-Link is the worldwide leader and award winning designer, developer, and manufacturer of networking products. D-Link delivers the performance you need at a price you can afford. D-Link has all the products you need to build your network.

How does wireless work?

Wireless works similar to how cordless phone work, through radio signals to transmit data from one point A to point B. But wireless technology has restrictions as to how you can access the network. You must be within the wireless network range area to be able to connect your computer. There are two different types of wireless networks Wireless Local Area Network (WLAN), and Wireless Personal Area Network (WPAN).

Wireless Local Area Network (WLAN)

In a wireless local area network, a device called an Access Point (AP) connects computers to the network. The access point has a small antenna attached to it, which allows it to transmit data back and forth over radio signals. With an indoor access point as seen in the picture, the signal can travel up to 300 feet. With an outdoor access point the signal can reach out up to 30 miles to serve places like manufacturing plants, industrial locations, college and high school campuses, airports, golf courses, and many other outdoor venues.

Who uses wireless?

Wireless technology has become so popular in recent years that almost everyone is using it, whether it's for home, office, business, D-Link has a wireless solution for it.

Home

- Gives everyone at home broadband access
- Surf the web, check e-mail, instant message, and etc
- Gets rid of the cables around the house
- Simple and easy to use

Small Office and Home Office

- Stay on top of everything at home as you would at office
- Remotely access your office network from home
- Share Internet connection and printer with multiple computers
- No need to dedicate office space

Where is wireless used?

Wireless technology is expanding everywhere not just at home or office. People like the freedom of mobility and it's becoming so popular that more and more public facilities now provide wireless access to attract people. The wireless connection in public places is usually called "hotspots."

Using a D-Link Cardbus Adapter with your laptop, you can access the hotspot to connect to Internet from remote locations like: Airports, Hotels, Coffee Shops, Libraries, Restaurants, and Convention Centers.

Wireless network is easy to setup, but if you're installing it for the first time it could be quite a task not knowing where to start. That's why we've put together a few setup steps and tips to help you through the process of setting up a wireless network.

Tips

Here are a few things to keep in mind, when you install a wireless network.

Centralize your router or Access Point

Make sure you place the router/access point in a centralized location within your network for the best performance. Try to place the router/access point as high as possible in the room, so the signal gets dispersed throughout your home. If you have a two-story home, you may need a repeater to boost the signal to extend the range.

Eliminate Interference

Place home appliances such as cordless telephones, microwaves, and televisions as away as possible from the router/access point. This would significantly reduce any interfere that the appliances might cause since they operate on same frequency.

Security

Do not let you next-door neighbors or intruders connect to your wireless network. Secure your wireless network by turning on the WPA or WEP security feature on the router. Refer to product manual for detail information on how to set it up.

Wireless Modes

There are basically two modes of networking:

- **Infrastructure** – All wireless clients will connect to an access point or wireless router.
- **Ad-Hoc** – Directly connecting to another computer, for peer-to-peer communication, using wireless network adapters on each computer, such as two or more DCS-5230 wireless network Cardbus adapters.

An Infrastructure network contains an Access Point or wireless router. All the wireless devices, or clients, will connect to the wireless router or access point.

An Ad-Hoc network contains only clients, such as laptops with wireless cardbus adapters. All the adapters must be in Ad-Hoc mode to communicate.

Networking Basics

Check your IP Address

After you install your new D-Link adapter, by default, the TCP/IP settings should be set to obtain an IP address from a DHCP server (i.e. wireless router) automatically. To verify your IP address, please follow the steps below.

Click on **Start > Run**. In the run box type **cmd** and click **OK**.

At the prompt, type **ipconfig** and press **Enter**.

This will display the IP address, subnet mask, and the default gateway of your adapter.

If the address is 0.0.0.0, check your adapter installation, security settings, and the settings on your router. Some firewall software programs may block a DHCP request on newly installed adapters.

If you are connecting to a wireless network at a hotspot (e.g. hotel, coffee shop, airport), please contact an employee or administrator to verify their wireless network settings.

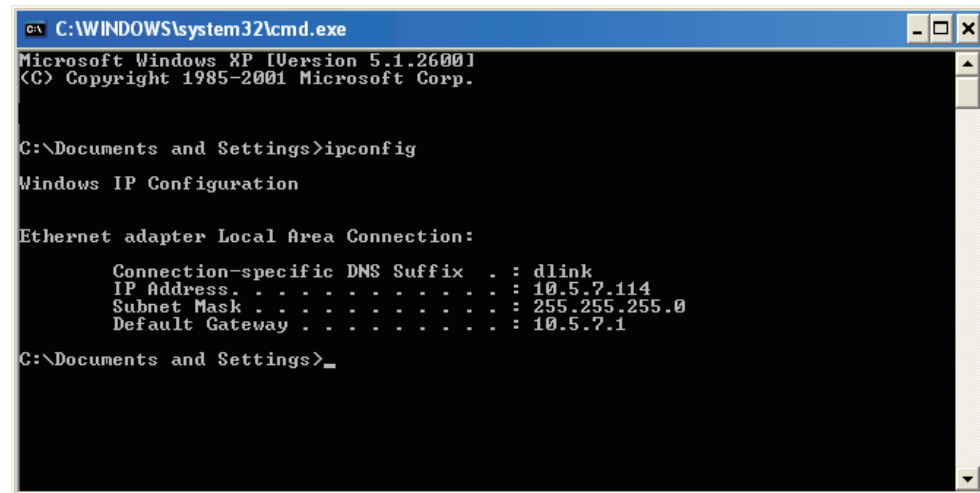

```
C:\WINDOWS\system32\cmd.exe
Microsoft Windows XP [Version 5.1.2600]
(C) Copyright 1985-2001 Microsoft Corp.

C:\Documents and Settings>ipconfig

Windows IP Configuration

Ethernet adapter Local Area Connection:

    Connection-specific DNS Suffix  . : dlink
    IP Address. . . . .               : 10.5.7.114
    Subnet Mask . . . . .            : 255.255.255.0
    Default Gateway . . . . .        : 10.5.7.1

C:\Documents and Settings>_
```

Statically Assign an IP Address

If you are not using a DHCP capable gateway/router, or you need to assign a static IP address, please follow the steps below:

Step 1

Windows® XP - Click on **Start > Control Panel > Network Connections**.

Windows® 2000 - From the desktop, right-click **My Network Places > Properties**.

Step 2

Right-click on the **Local Area Connection** which represents your D-Link network adapter and select **Properties**.

Step 3

Highlight **Internet Protocol (TCP/IP)** and click **Properties**.

Step 4

Click **Use the following IP address** and enter an IP address that is on the same subnet as your network or the LAN IP address on your router.

Example: If the router's LAN IP address is 192.168.0.1, make your IP address 192.168.0.X where X is a number between 2 and 99. Make sure that the number you choose is not in use on the network. Set Default Gateway the same as the LAN IP address of your router (192.168.0.1).

Set Primary DNS the same as the LAN IP address of your router (192.168.0.1). The Secondary DNS is not needed or you may enter a DNS server from your ISP.

Step 5

Click **OK** twice to save your settings.

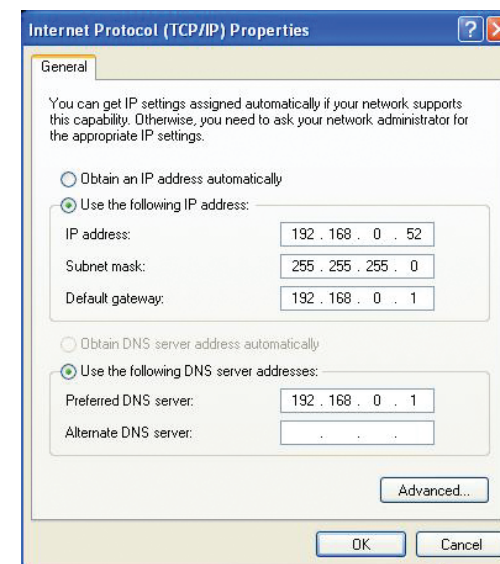

Technical Specifications

Network Protocol Support

- IPv4, ARP, TCP, UDP, ICMP, DHCP Client, NTP Client (D-Link), DNS Client, DDNS Client (D-Link), SMTP Client, FTP Client, HTTP Server, Samba Client, PPPoE, RTP, RTSP, RTCP, 3GPP

Built-in Network Interfaces

- 802.11 n/g Wireless
- WPS Support
- 10/100BASE-TX Fast Ethernet with auto-MDI/MDIX support

Video Algorithm Support

- JPEG for still images
- Enhanced video compression using MPEG4 Simple Profile
- MPEG4/MJPEG dual format compression

Video Resolution

VGA (640 x 480)

- 640 x 480 at 30fps
- 320 x 240 at 30fps
- 160 x 120 at 30fps

XGA (1024 x 768)

- 1024 x 768 at 10fps
- 512 x 384 at 10fps
- 256 x 192 at 10fps

SXGA (1280 x 1024)

- 1280 x 1024 at 10fps

Video Features

- Adjustable image size and quality
- Time stamp and text overlays
- 3 configurable motion detection windows
- Flip & mirror

Video Bit Rate

- 20K to 4M

Camera Specifications

- 1.3 Mega pixel 1/3" CMOS sensor
- Standard fixed mount type lens, 3.98mm lens, F2.0
- AGC/AWB/AES
- Electronic shutter: 1/60 to 1/15000 sec.
- Standard fixed mount type lens 4mm, F2.0
- 62° field of view

PAN/TILT/ZOOM

- Pan range: 130° ~ -180°
- Tilt range: +5 ~ -85
- Digital zoom : 16x

Audio

- Sample rate GSM-AMR : 12.20 kbps, ADPCM : 8kbps

Microphone

- Directivity: omni-directional
- Frequency: 20 ~ 20000Hz
- S/N ratio: more than 58dB

Security

- Administrator and user group protected
- Password authentication
- Wireless LAN security: 64/128-bit WEP, WPA-PSK and WPA2 data encryption

Viewing System Requirements

- OS: Microsoft Windows XP, 2000 / Vista / Linux / MAC OS X10.3 or above
- Browser: Internet Explorer v6.0 or above

Supported PDA, Mobile Phones & Software

- Handsets with 3GPP player
- Packet Video Player 3.0
- QuickTime 6.5
- Real Player 10.5
- Windows 2000, XP, Vista

Wireless LAN

Wireless Data Rates

- IEEE 802.11n: From MCS0 to MCS15
- IEEE 802.11g: 54, 48, 36, 24, 18, 12, 9, 6 Mbps
- IEEE 802.11b: 11, 5.5, 2, 1 Mbps
- Auto-select or Manual specified.

Sensitivity:

- HT40802.11n: Packet Error Rate < 10%, MCS6 < -60 dBm
- HT20802.11n: Packet Error Rate < 10%, MCS6 < -66 dBm
- 802.11g: Packet Error Rate < 10%, 54Mbps < -66 dBm
- 802.11b: Packet Error Rate < 8%, 11Mbps < -82 dBm

Antenna

- Connector: MHF
- Operating Frequency: 2.4Ghz

Physical & Environmental

DIAGNOSTIC LED

- Link/Power LED: Green/Red
- WPS LED: Blue

Power Input

- 12V, 1.25A switching power adapter
- External AC-to-DC switching power adapter

Power Consumption

- Max 6 watts

Dimensions

- 110 (H) x 105 (W) x 112 (D) mm
- (4.33 x 4.13 x 4.41 inches)

Weight

- 393 grams (0.87 lb)

Operation Temperature

- 0° to 40° C (32° to 104° F)

Storage Temperature

- -20° to 70° C (-4° to 158° F)

Humidity

- 20% to 80% non-condensing

Emission (EMI), Safety & Other Certifications

- FCC Class B
- IC
- CE
- C-Tick

Package Includes

- DCS-5230 camera
- External power adapter
- CAT5 Ethernet cable
- Quick Installation Guide
- Master CD
- Camera stand
- Mounting Screws

Version 1.0
07/14/2009