



User Manual

Vigilance HD Wireless Camera

DCS-4201

Preface

D-Link reserves the right to revise this publication and to make changes in the content hereof without obligation to notify any person or organization of such revisions or changes. Information in this document may become obsolete as our services and websites develop and change. Please refer to the www.mydlink.com website for the most current information.

Manual Revisions

| Revision | Date | Description |
|----------|----------------|---|
| 1.0 | April 24, 2015 | DCS-4201 Revision A1 with firmware version 1.00 |

Trademarks

D-Link and the D-Link logo are trademarks or registered trademarks of D-Link Corporation or its subsidiaries in the United States or other countries. All other company or product names mentioned herein are trademarks or registered trademarks of their respective companies.

Copyright © 2015 D-Link Corporation.

All rights reserved. This publication may not be reproduced, in whole or in part, without prior expressed written permission from D-Link Corporation.

Table of Contents

| | | | |
|---|----|--------------------------------|----|
| Product Overview..... | 4 | Audio and Video..... | 35 |
| Package Contents..... | 4 | Preset..... | 37 |
| Introduction..... | 5 | Motion Detection | 39 |
| System Requirements | 5 | Sound Detection..... | 41 |
| Features..... | 6 | Time and Date..... | 42 |
| Hardware Overview | 7 | Event Setup..... | 43 |
| Front | 7 | SD Card | 52 |
| Rear | 8 | Advanced..... | 53 |
| Sides | 9 | Digital Input/Output..... | 53 |
| Wireless Installation Considerations..... | 10 | ICR and IR..... | 54 |
| Installation | 11 | HTTPS..... | 55 |
| Hardware Installation | 11 | Access List..... | 56 |
| Mount the Camera | 12 | Maintenance..... | 57 |
| Configuration with Wizard | 13 | Device Management | 57 |
| Viewing Camera via Web Browser | 17 | System | 58 |
| Setup Wizard SE..... | 17 | Firmware Upgrade..... | 59 |
| Configuration..... | 19 | Status | 60 |
| Using the Configuration Interface..... | 19 | Device Info | 60 |
| Live Video | 20 | Logs | 61 |
| Setup | 22 | Help..... | 62 |
| Setup Wizard | 22 | DI/DO Specifications | 63 |
| Network Setup..... | 27 | Technical Specifications | 64 |
| Wireless Setup..... | 31 | | |
| Dynamic DNS | 32 | | |
| Image Setup | 33 | | |

Product Overview

Package Contents



DCS-4201 Vigilance HD Wireless Camera



CAT5 Ethernet cable



Power adapter



CD-ROM with User Manual and software



Quick Installation Guide

If any of the above items are missing, please contact your reseller.

Safety Notice: Installation and servicing should be done by certified technicians so as to conform to all local codes and prevent voiding your warranty.



Introduction

Congratulations on your purchase of the DCS-4201 Vigilance HD Wireless Camera. The DCS-4201 is a versatile and unique solution for your small office. Unlike a standard webcam, the DCS-4201 is a complete system with a built-in CPU and web server that transmits high quality video images for security and surveillance. The DCS-4201 can be accessed remotely, and controlled from any PC/Notebook over your local network or through the Internet via a web browser. The simple installation and intuitive web-based interface offer easy integration with your Ethernet/Fast Ethernet or 802.11n/g wireless network. The DCS-4201 also comes with motion and sound detection features for a complete security solution.

System Requirements

- Computer with Microsoft Windows® 7/8/Vista, Mac OS or Linux
- Internet Explorer 7, Firefox 20, Safari 6, or higher version with Java installed and enabled
- Existing 10/100 Ethernet-based network
- A microSD memory card (optional) is required for recording to onboard storage. SDHC Class 6 or above is recommended.

Features

Simple to Use

The DCS-4201 is a stand-alone system with a built-in CPU, requiring no special hardware or software. The DCS-4201 supports both ActiveX mode for Internet Explorer and Java mode for other browsers such as Firefox® and Safari®.

Supports a Variety of Platforms

Supporting TCP/IP networking, HTTP, and other Internet related protocols. The DCS-4201 can also be integrated easily into other Internet/Intranet applications because of its standards-based features.

Advanced Event Management

The DCS-4201 can be set up to send e-mail notifications with snapshots when an event occurs, such as when motion is detected. Events can be triggered from several sources, such as motion detection and time based events.

Broad Range of Applications

With today's high-speed Internet services, the Network Camera can provide the ideal solution for delivering live video images over the Intranet and Internet for remote monitoring. The Network Camera allows remote access using a Web browser for live image viewing, and allows the administrator to manage and control the Network Camera anytime, anywhere in the world. Many applications exist, including industrial and public monitoring of homes, offices, banks, hospitals, child-care centers, and amusement parks.

IR LED for Day and Night functionality

The built-in infrared LED enables night time viewing of up to 10 meters.

802.11n Wireless or Ethernet/Fast Ethernet Support

The DCS-4201 offers wireless 802.11n and Ethernet/Fast Ethernet connectivity, making the network camera easy to integrate into your existing network environment. The DCS-4201 works with a 10Mbps Ethernet based network or 100Mbps Fast Ethernet based network for traditional wired environments, and works with 802.11n routers or access points for added flexibility. The Site Survey feature also allows you to view and connect to any available wireless networks.

Hardware Overview

Front

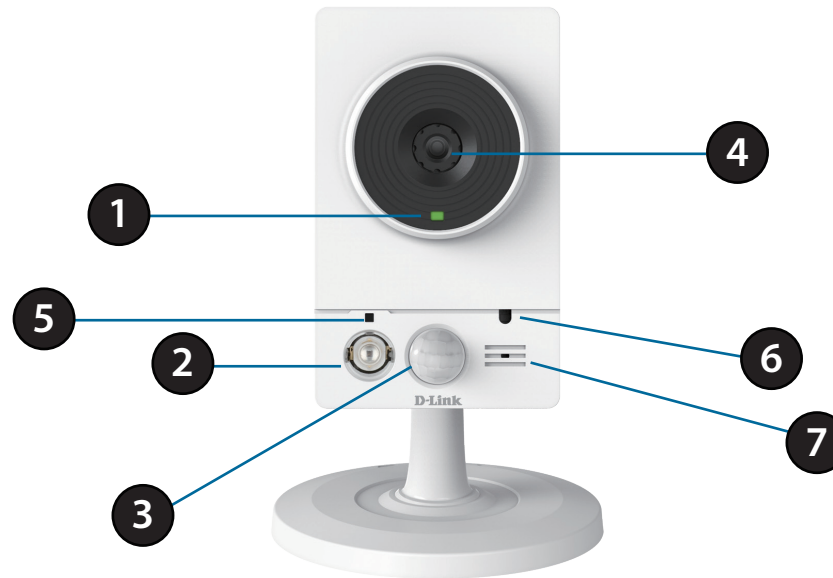

| | | |
|---|---------------------|---|
| 1 | Status LED | Indicates the camera's current status |
| 2 | Infrared LED | Used to illuminate the camera's field of view at night |
| 3 | PIR Sensor | Passive infrared sensor for motion detection |
| 4 | Camera Lens | Records video of the surrounding area |
| 5 | Microphone | Records audio from the surrounding area |
| 6 | Light Sensor | The light sensor monitors lighting conditions and switches between day and night vision modes accordingly |
| 7 | Speaker | Can play audio sent to camera for two-way communication |

Rear

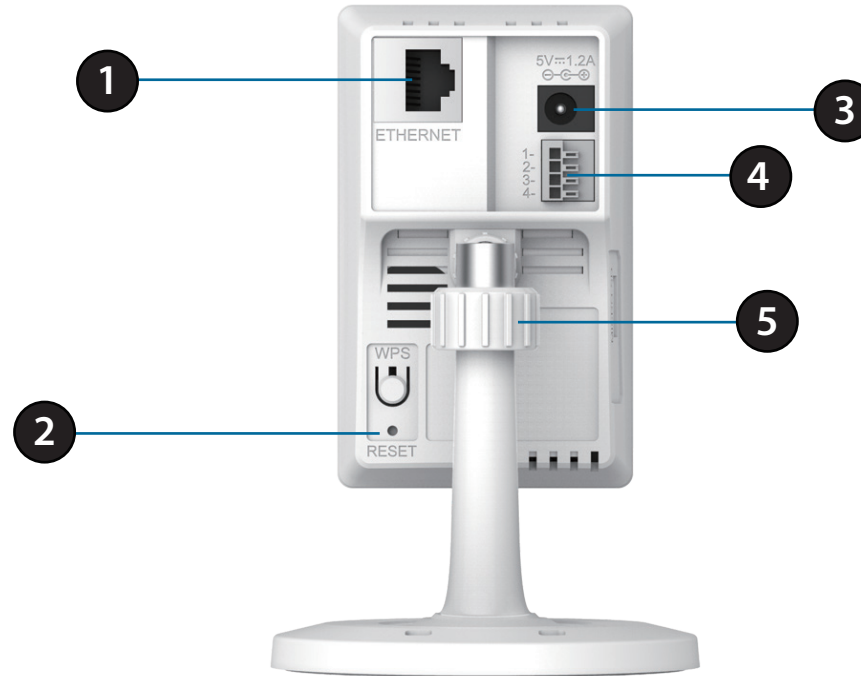

| | | |
|---|------------------------|---|
| 1 | Ethernet Port | Connects to your Ethernet network |
| 2 | Reset Button | Press and hold this button for 10 seconds to reset the camera |
| 3 | Power Connector | Connects to the included DC 5 V power adapter |
| 4 | DI/DO Connector | I/O connectors for external devices |
| 5 | Adjustment Ring | Tighten or loosen the adjustment ring to adjust the camera's position |

Sides



| | | |
|---|--------------------------|---|
| 1 | microSD Card Slot | Insert a microSD card for storing recorded images and video locally |
|---|--------------------------|---|

Wireless Installation Considerations

This D-Link device can connect to your wireless network from anywhere within the operating range of your wireless network. However, the number, thickness and location of walls, ceilings, or other objects that the wireless signals must pass through, may limit the range. Typical ranges vary depending on the types of materials and background RF (radio frequency) noise in your home or business. The key to maximizing wireless range is to follow these basic guidelines:

1. Minimize the number of walls and ceilings between your adapter and other network devices (such as your network camera) - each wall or ceiling can reduce your adapter's range from 3-90 feet (1-30 meters).
2. Be aware of the direct line between network devices. A wall that is 1.5 feet thick (.5 meters), at a 45-degree angle appears to be almost 3 feet (1 meter) thick. At a 2-degree angle, it looks over 42 feet (14 meters) thick. Position your devices so that the signal will travel straight through a wall or ceiling (instead of at an angle) for better reception.
3. Building materials make a difference. A solid metal door or aluminum studs may weaken the wireless signal. Try to position your access points, wireless routers, and other networking devices where the signal passes through drywall or open doorways. Materials and objects such as glass, steel, metal, walls with insulation, water (fish tanks), mirrors, file cabinets, brick, and concrete will degrade your wireless signal.
4. Keep your product at least 3-6 feet or 1-2 meters away from electrical devices or appliances that generate RF noise.
5. If you are using 2.4GHz cordless phones or other radio frequency sources (such as microwave ovens), your wireless connection may degrade dramatically or drop completely. Make sure your 2.4GHz phone base is as far away from your wireless devices as possible. The base transmits a signal even if the phone is not in use.

Installation

Hardware Installation

If you wish to set up your camera without using the Camera Setup Wizard, please follow these steps.

Connect the Ethernet Cable

Connect the included Ethernet cable to the network cable connector located on the panel at the rear of the DCS-4201 and attach it to the network.

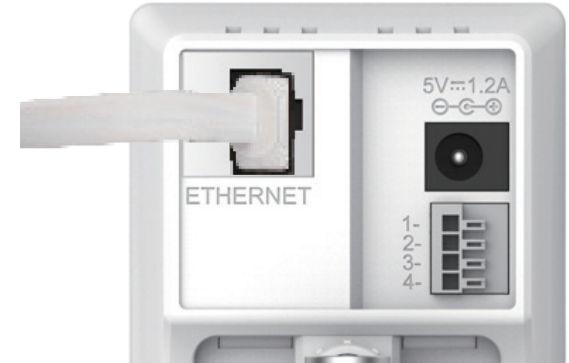

Attach the External Power Supply

Attach the external power supply to the DC Power receptor located on the rear panel of the DCS-4201 and connect it to your wall outlet or power strip.

Note: If you choose to take advantage of the Power over Ethernet feature you may unplug the power cable.



Mount the Camera

Please refer to the steps below to assist you with mounting the camera.

i We suggest that you configure the camera before mounting.

1. Place the mounting base where you want to position the camera and use a pencil to mark the holes.

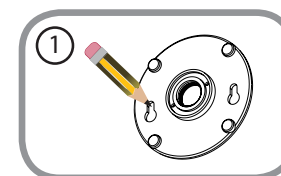

2. Depending on the material of the wall or ceiling, use proper tools to drill two holes or screws where you marked. If the wall is made out of concrete, drill the holes first, insert the plastic anchors and then the screws.

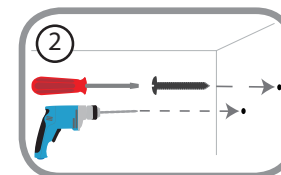

! The space between the camera and the screwheads should be 3 mm.

3. Place the mounting base over the screw that is mounted on the wall. Make sure to fit the screw-heads over the big holes and slide it downward to lock firmly. Lightly pull the base forward to make sure that it is locked.

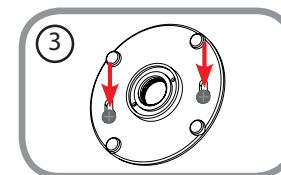

4. Place the base cover on the base and screw the camera stem clockwise into the mounting base.

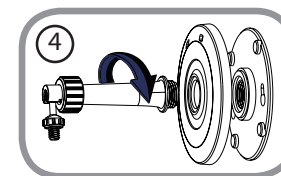

5. Adjust the angle of the camera as desired, then tighten the collar on the camera stem to lock it in place.

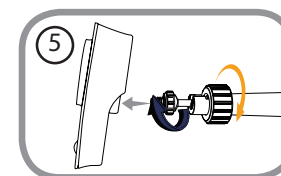

Configuration with Wizard

Insert the DCS-4201 CD into your computer's CD-ROM drive to begin the installation. If the Autorun function on your computer is disabled, or if the D-Link Launcher fails to start automatically, click **Start > Run**. Type **D:\autorun.exe**, where D: represents the drive letter of your CD-ROM drive.

Click **Setup Wizard** to begin the installation.



After clicking Setup Wizard, the following window will open.

Click **Next** to continue.

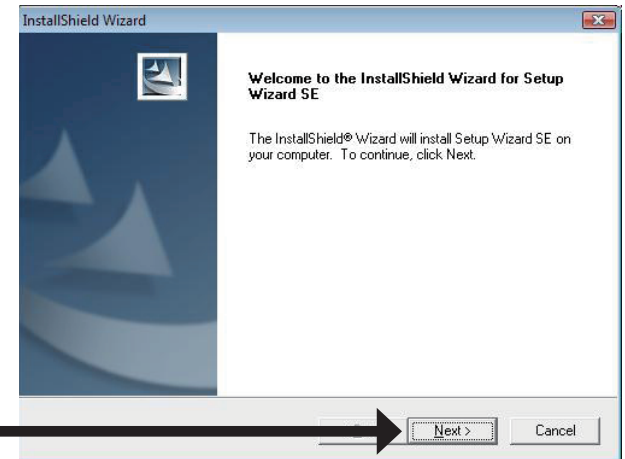

Click **Yes** to accept the License Agreement.

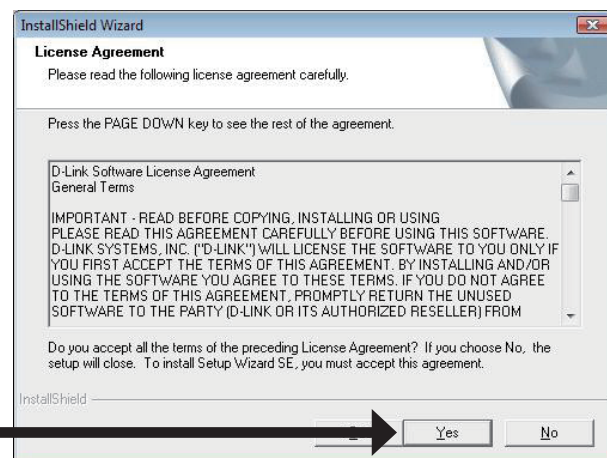

Click **Next** to start the installation process.

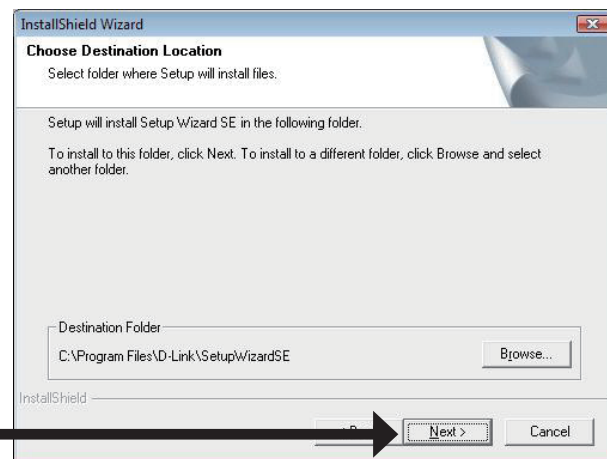

Note: The installation may take several minutes to finish.

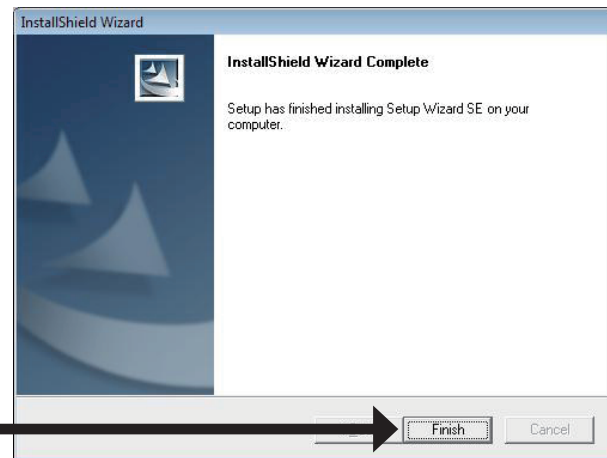

Click **Finish** to complete the installation.

Click on the **D-Link Setup Wizard SE** icon that was created in your Windows Start menu.

Start > D-Link > Setup Wizard SE

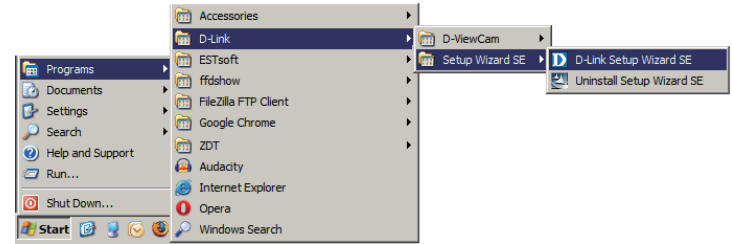

The Setup Wizard will appear and display the MAC address and IP address of your camera(s). If you have a DHCP server on your network, a valid IP Address will be displayed. If your network does not use a DHCP server, the network camera's default static IP **192.168.0.20** will be displayed.

Click the **Wizard** button to continue.



Enter the Admin ID and password. When logging in for the first time, the default Admin ID is **admin** with the password left blank.

Click **Next** to continue.

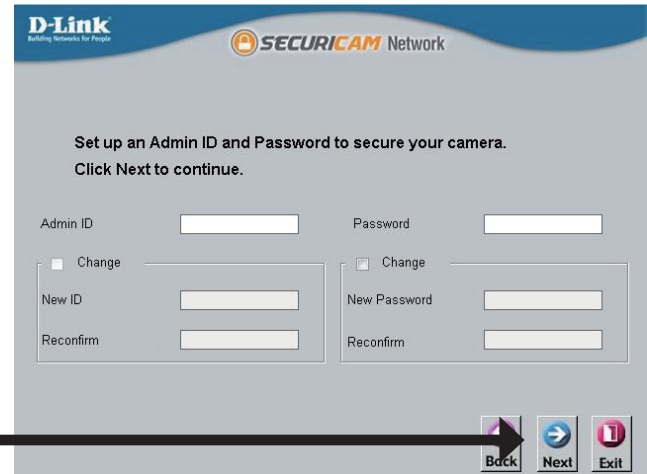

Select **DHCP** if your camera obtains an IP address automatically from a DHCP server (e.g., router). Select **Static IP** if you want to manually enter the IP settings for the camera.

Click **Next** to continue.

D-Link Building Networks for People

SECURICAM Network

Set IP Address

DHCP

Static IP

IP Address

Subnet Mask

Default Gateway

Primary DNS

Secondary DNS

Back Next Exit

Take a moment to confirm your settings and click **Restart**.

D-Link Building Networks for People

SECURICAM Network

Admin ID

Password

IP Address

Subnet Mask

Primary DNS

Secondary DNS

The Setup Wizard has completed. Click on 'Back' to modify your settings. Click 'Restart' to save your current settings and reboot the Internet Camera.

Back Restart

Setup Wizard SE

Viewing Camera via Web Browser

Click on the **D-Link Setup Wizard SE** icon that was created in your Windows Start menu.

Start > D-Link > Setup Wizard SE

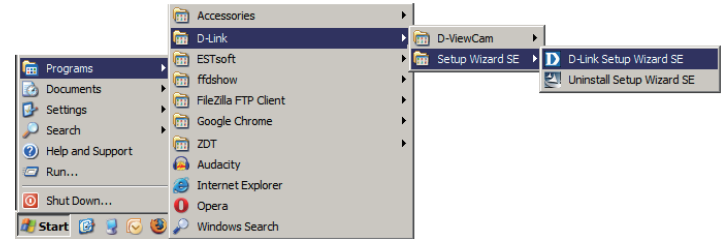

Select the camera and click **Link** to access the web configuration.



The Setup Wizard will automatically open your web browser to the IP address of the camera.



Enter **admin** as the default username and leave the password blank. Click **OK** to continue.

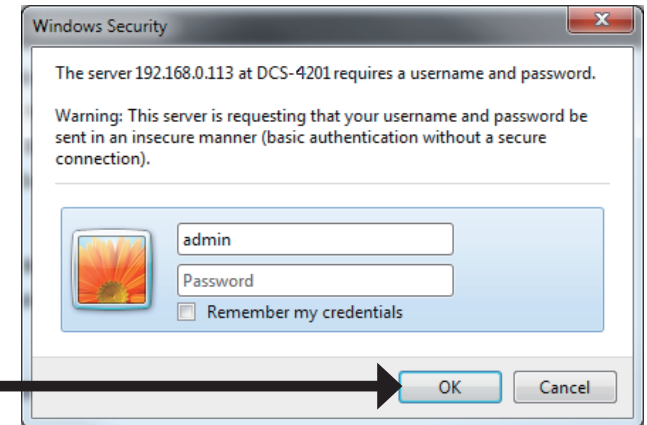

This section displays your camera's live video. You can select your video profile and view or operate the camera. For additional information about web configuration, please refer to the user manual included on the CD-ROM or the D-Link website.

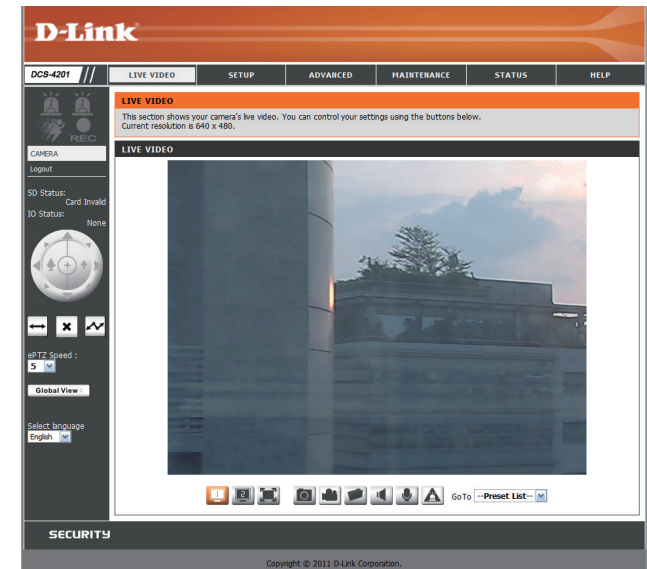

Configuration

Using the Configuration Interface

After completing the Camera Installation Wizard, you are ready to use your camera. The camera's built-in Web configuration utility is designed to allow you to easily access and configure your DCS-4201. At the end of the wizard, enter the IP address of your camera into a web browser, such as Mozilla Firefox. To log in, use the User name **admin** and the password you created in the Installation Wizard. If you did not create a password, the default password is blank. After entering your password, click **OK**.

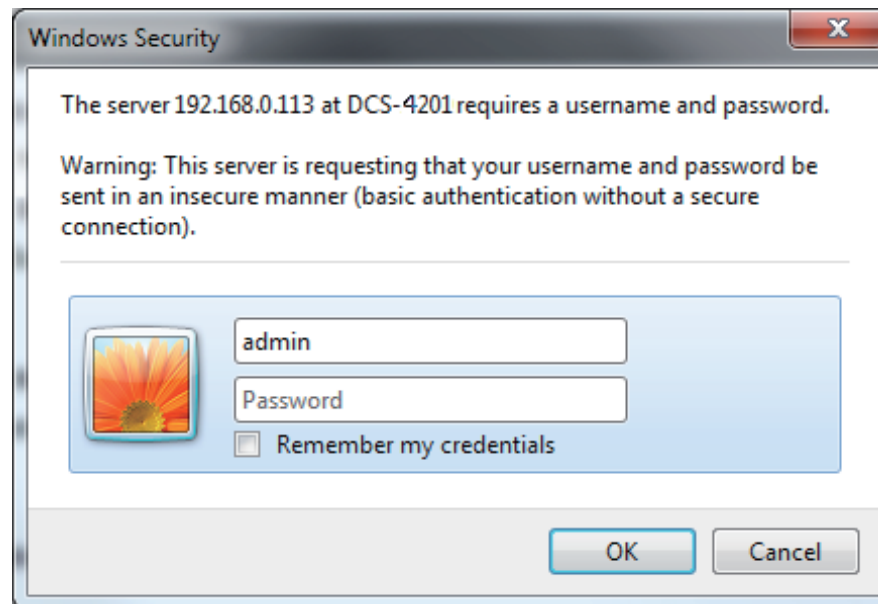







Live Video

This section shows your camera's live video. You may select any of the available icons listed below to operate the camera. You may also select your language using the drop-down menu on the left side of the screen.

You can zoom in and out on the live video image using your mouse. Right-click to zoom out or left-click to zoom in on the image.

SD Status: This option displays the status of the microSD card. If no microSD card has been inserted, this screen will display the message "Card Invalid."

IO Status: This option displays the status of your I/O device if a device has been connected.





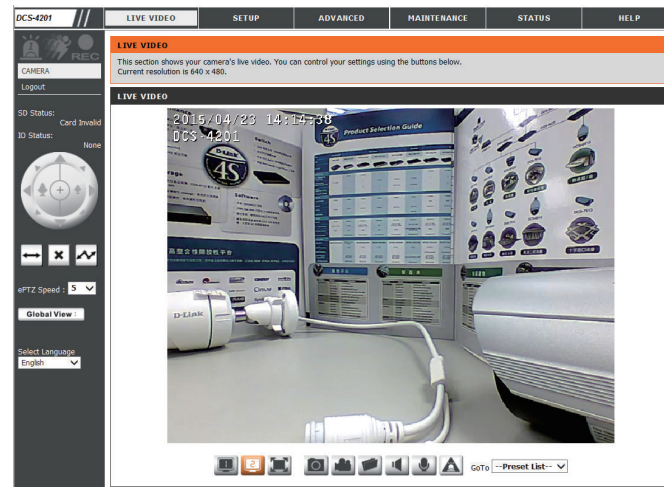





| | | |
|---|---------------------------------|--|
|  | Digital Input Indicator | This indicator will change color when a digital input signal is detected. |
|  | Motion Trigger Indicator | This indicator will change color when a trigger event occurs. Note: The video motion feature for your camera must be enabled. |
|  | Recording Indicator | When a recording is in progress, this indicator will change color. |
|  | Control Pad | This control pad can be used to electronically pan, tilt, and zoom (ePTZ) within the camera's predefined view area, if one has been defined. |
|  | Auto Pan | Starts the automatic panning function. |
|  | Stop | Stops automatic panning. |
|  | Preset Path | Starts the camera's motion along the predefined path. |

ePTZ Speed: You may select a value between 0 and 64. 0 is the slowest and 64 is the fastest.



Global View: This window indicates the total field of view (FOV) of the camera. The red box indicates the visible region of interest (ROI).

Language: You may select the interface language using this menu.

- | | |
|---|--|
|  Video Profile 1 |  Record a Video Clip |
|  Video Profile 2 |  Set a Storage Folder |
|  Video Profile 3 |  Listen/Stop Audio In (from microphone) |
|  Full screen mode |  Start/Stop Audio Out (to speaker) |
|  Taking a Snapshot |  Start/Stop Digital Output |

Go To (Preset List): If any presets have been defined, you can select them here to move the camera to the selected preset.

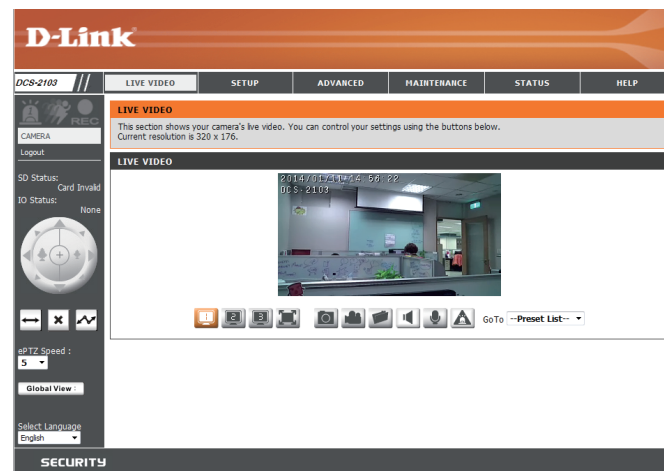

Setup Setup Wizard

To configure your Network Camera, click **Internet Connection Setup Wizard**. Alternatively, you may click **Manual Internet Connection Setup** to manually configure your Network Camera and skip to "Network Setup" on page 27.

To quickly configure your Network Camera's motion detection settings, click **Motion Detection Setup Wizard**. If you want to enter your settings without running the wizard, click **Manual Motion Detection Setup** and skip to "Motion Detection" on page 39.

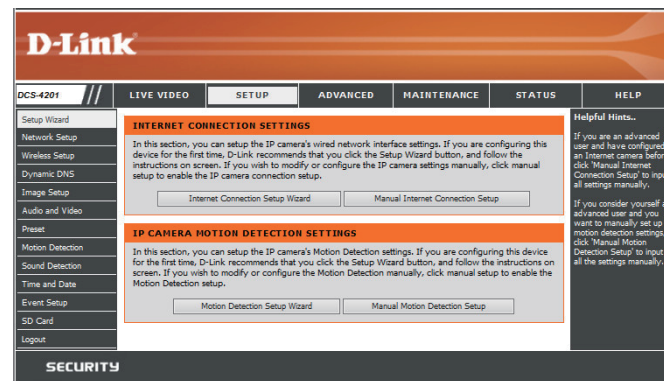

Internet Connection Setup Wizard

This wizard will guide you through a step-by-step process to configure your new D-Link Camera and connect the camera to the Internet. Click **Next** to continue.

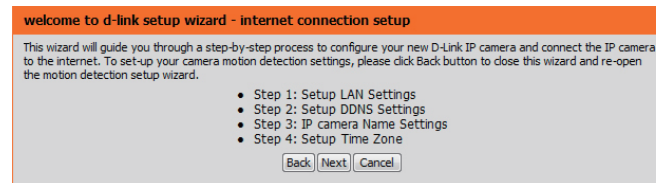

Select how the camera will connect to the Internet.

If your router is connected to a router, or you are unsure how your camera will connect to the Internet, select DHCP Connection.

Select **Static IP** if your Internet Service Provider has provided you with connection settings, or if you wish to set a static address within your home network. Enter the correct configuration information and click **Next** to continue.

If you are using PPPoE, select **Enable PPPoE** and enter your user name and password.

Click **Next** to continue.

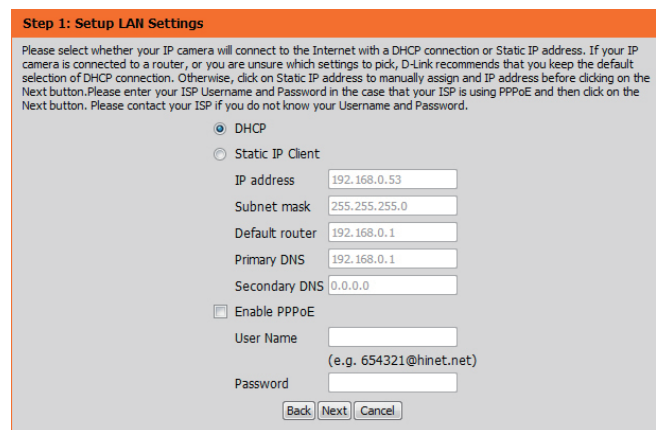

If you have a Dynamic DNS account and would like the camera to update your IP address automatically, Select **Enable DDNS** and enter your host information. Click **Next** to continue.

Step 2: Setup DDNS Settings

If you have a Dynamic DNS account and would like the IP camera to update your IP address automatically, enable DDNS and enter in your host information below. Please click on the Next button to continue.

Enable DDNS

Server Address <<

Host Name

User Name

Password

Verify Password

Timeout (hours)

Enter a name for your camera and click **Next** to continue.

Step 3: IP camera Name Settings

D-Link recommends that you rename your IP camera for easy accessibility. You can then identify and connect to your IP camera via this name. Please assign a name of your choice before clicking on the Next button.

IP camera Name

Configure the correct time to ensure that all events will be triggered as scheduled. Click **Next** to continue.

Step 4: Setup Time Zone

Please configure the correct time to ensure that all events are triggered, captured and scheduled at the correct time and day and then click on the Next button.

Time Zone

Enable Daylight Saving

If you have selected DHCP, you will see a summary of your settings, including the camera's IP address. Please write down all of this information as you will need it in order to access your camera.

Click **Apply** to save your settings.

Step 5: Setup complete

Below is a summary of your IP camera settings. Click on the Back button to review or modify settings or click on the Apply button if all settings are correct. It is recommended to note down these settings in order to access your IP camera on the network or via your web browser.

| | |
|----------------|--------------------|
| IP Address | DHCP |
| IP camera Name | DCS-2132L |
| Time Zone | (GMT+08:00) Taipei |
| DDNS | Disable |
| PPPoE | Disable |

Motion Detection Setup Wizard

This wizard will guide you through a step-by-step process to configure your camera's motion detection functions.

Click **Next** to continue.

Step 1

This step will allow you to enable or disable motion detection, specify the detection sensitivity, and adjust the camera's ability to detect movement.

You may specify whether the camera should capture a snapshot or a video clip when motion is detected.

Please see the **Motion Detection** section on "Motion Detection" on page 39 for information about how to configure motion detection.

Step 2

This step allows you to enable motion detection based on a customized schedule. Specify the day and hours. You may also choose to always record whenever motion is detected.

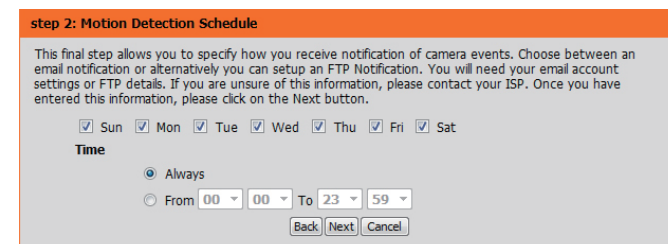
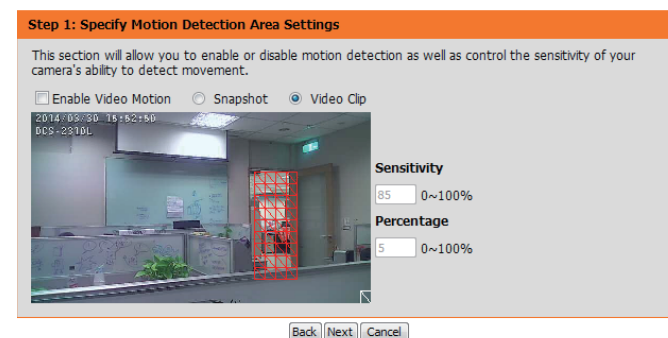
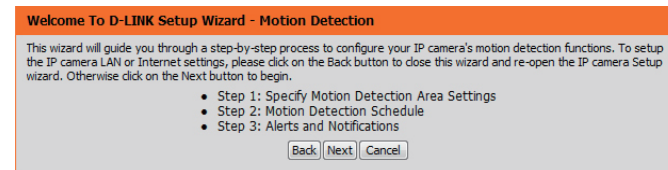

Step 3

This step allows you to specify how you will receive event notifications from your camera. You may choose not to receive notifications, or to receive notifications via e-mail or FTP.

Please enter the relevant information for your e-mail or FTP account.

Click **Next** to continue.

Step 3: Alerts and Notification

This final step allows you to specify how you receive notification of camera events. Choose between an email notification or alternatively you can setup an FTP Notification. You will need your email account settings or FTP details. If you are unsure of this information, please contact your ISP. Once you have entered this information, please click on the Next button.

Do not notify me

Email

Sender email address:

Recipient email address:

Server address:

User name:

Password:

Port:

FTP

Server address:

Port:

User name:

Password:

Remote folder name:

Step 4

You have completed the Motion Detection Wizard.

Please verify your settings and click **Apply** to save them.

Step 4: Setup Complete

You have completed your IP camera setup. Please click the Back button if you want to review or modify your settings or click on the Apply button to save and apply your settings.

Motion Detection : Enable

EVENT : Video Clip

Schedule Day : Sun ,Mon ,Tue ,Wed ,Thu ,Fri ,Sat ,

Schedule Time : Always

Alerts and Notification : Email

Please wait a few moments while the camera saves your settings and restarts.

Step 4: Setup Complete

You have completed your IP camera setup. Please click the Back button if you want to review or modify your settings or click on the Apply button to save and apply your settings.

Changes saved.IP camera's network is restarting, please wait for 5 seconds ...

Network Setup

Use this section to configure the network connections for your camera. All relevant information must be entered accurately. After making any changes, click the **Save Settings** button to save your changes.

LAN Settings: This section lets you configure settings for your local area network.

DHCP: Select this connection if you have a DHCP server running on your network and would like your camera to obtain an IP address automatically.

If you choose DHCP, you do not need to fill out the IP address settings.

Static IP Client: You may obtain a static or fixed IP address and other network information from your network administrator for your camera. A static IP address may simplify access to your camera in the future.

IP Address: Enter the fixed IP address in this field.

Subnet Mask: This number is used to determine if the destination is in the same subnet. The default value is 255.255.255.0.

Default Router: The gateway used to forward frames to destinations in a different subnet. Invalid gateway settings may cause the failure of transmissions to a different subnet.

Primary DNS: The primary domain name server translates names to IP addresses.

Secondary DNS: The secondary DNS acts as a backup to the primary DNS.

The screenshot displays the 'NETWORK SETUP' page for a D-Link DCS-4201 camera. The interface is divided into several sections for configuring network parameters:

- LAN SETTINGS:** The 'DHCP' radio button is selected. Below it, fields for 'Static IP Client' (IP address, Subnet mask, Default router, Primary DNS, Secondary DNS) are present but disabled. The 'Enable UPnP presentation' checkbox is checked, and 'Enable UPnP port forwarding' is unchecked. Forwarding status is shown as 'UPnP forwarding is inactive'.
- PPPoE SETTINGS:** The 'Disable' radio button is selected. Fields for 'User Name', 'Password', and 'Confirm password' are present but disabled. The status is 'PPPoE is inactive'.
- HTTP:** 'HTTP port' is set to 80. Fields for 'Access name for stream1' and 'Access name for stream2' are set to 'video1.mjpg' and 'video2.mjpg' respectively.
- HTTPS:** 'HTTPS port' is set to 443.
- RTSP:** 'RTSP port' is set to 554. Fields for 'Access name for stream1' and 'Access name for stream2' are set to 'live1.sdp' and 'live2.sdp' respectively.
- COS SETTINGS:** 'Enable CoS' is unchecked. 'VLAN ID' is set to 1 (with a red warning icon and text '(0-4095)').
- QoS SETTINGS:** 'Enable QoS' is unchecked. All QoS options (Live video, Live audio, Event/Alarm, Management) are set to 0.
- IPv6:** 'Enable IPv6' is unchecked.

The right sidebar contains 'Helpful Hints' for various features:

- DHCP:** Select 'DHCP Connection' if you are running a DHCP server on your network and would like an IP address assigned to your IP camera automatically.
- UPnP:** Enabling UPnP settings will allow you to configure your IP camera as an UPnP device in the network.
- PPPoE Settings:** If you use the IP camera to connect directly to the Internet, you will need to enter the username and password, which were given to you when you set up your account with your Internet Service Provider. If the camera is behind a router or a gateway, you do not need to configure this setting.
- HTTP:** HTTP Port is the port you allocate in order to connect to the IP camera via a standard web browser.
- HTTPS:** HTTPS Port in a IP camera connects to a PC via a secure web browser.
- RTSP:** RTSP Port is the port you allocate in order to connect to a IP camera by using streaming mobile devices, such as a mobile phone or PDA.
- CoS (Class of Service):** Coarsely-grained traffic control based on the LL protocol. Class of Service technologies do not guarantee a level of service in terms of bandwidth and delivery time, they offer a "best-effort".
- QoS (Quality of Service):** Fine-grained traffic control, a resource reservation control mechanism. Quality of service guarantees are important if the network capacity is insufficient, especially for real-time streaming multimedia applications.
- Enable IPv6:** Select this option and click Save to enable IPv6 settings. Please note that this only works if your network environment and hardware equipment support IPv6. The browser should be Microsoft® Internet Explorer 8.5, Mozilla Firefox 3.0 or above. When IPv6 is enabled, by default, the Network Camera will listen to router advertisements and be assigned a link-local IPv6 address accordingly.
- IPv6 Information:** Click this button to obtain the IPv6 information. If your IPv6 setting are successful, the IPv6 address list will be listed in the popup window. Please follow the steps below to link to an IPv6 address.
 - 1) Open your web browser.
 - 2) Enter the link-global or link-local IPv6 address in the address bar of your

Enable UPnP Presentation: Enabling this setting allows your camera to be configured as a UPnP device on your network.

Enable UPnP Port Forwarding: Enabling this setting allows the camera to add port forwarding entries into the router automatically on a UPnP capable network.

PPPoE Settings: Enable this setting if your network uses PPPoE.

User Name / Password: Enter the username and password for your PPPoE account. Re-enter your password in the Confirm Password field. You may obtain this information from your ISP.

HTTP Port: The default port number is 80.

Access Name for Stream 1~3: The default name is video#.mjpg, where # is the number of the stream.

HTTPS Port: You may use a PC with a secure browser to connect to the HTTPS port of the camera. The default port number is 443.

RTSP Port: The port number that you use for RTSP streaming to mobile devices, such as mobile phones or PDAs. The default port number is 554. You may specify the address of a particular stream. For instance, live1.sdp can be accessed at rtsp://x.x.x.x/video1.sdp where the x.x.x.x represents the IP address of your camera.

The screenshot displays the configuration interface for the camera, organized into several sections:

- LAN SETTINGS:**
 - Radio buttons for **DHCP** (selected) and **Static IP Client**.
 - Fields for IP address (192.168.0.113), Subnet mask (255.255.255.0), Default router (192.168.0.1), Primary DNS (192.168.0.1), and Secondary DNS (0.0.0.0).
 - Checkboxes for **Enable UPnP presentation** (checked) and **Enable UPnP port forwarding** (unchecked).
 - Fields for Forwarding Port (1024) and Forwarding Status (UPnP forwarding is inactive).
- PPPOE SETTINGS:**
 - Radio buttons for **Enable** and **Disable** (selected).
 - Fields for User Name, Password, and Confirm password.
 - PPPoE Status: PPPoE is inactive.
- HTTP:**
 - Field for HTTP port (80).
 - Fields for Access name for stream1 (video1.mjpg), stream2 (video2.mjpg), and stream3 (video3.mjpg).
- HTTPS:**
 - Field for HTTPS port (443).
- RTSP:**
 - Dropdown for Authentication (Digest).
 - Field for RTSP port (554).
 - Fields for Access name for stream1 (live1.sdp), stream2 (live2.sdp), and stream3 (live3.sdp).

Enable CoS: Enabling the Class of Service setting implements a best-effort policy without making any bandwidth reservations.

Enable QoS: Enabling QoS allows you to specify a traffic priority policy to ensure a consistent Quality of Service during busy periods. If the Network Camera is connected to a router that itself implements QoS, the router's settings will override the QoS settings of the camera.

Enable IPV6: Enable the IPV6 setting to use the IPV6 protocol. Enabling the option allows you to manually set up the address, specify an optional IP address, specify an optional router and an optional primary DNS.

Enable Multicast for stream The DCS-4201 allows you to multicast each of the available streams via group address and specify the TTL value for each stream. Enter the port and TTL settings you wish to use if you do not want to use the defaults.

COS SETTINGS

Enable CoS
 VLAN ID [0~4095]
 Live video
 Live audio
 Event/Alarm
 Management

QOS SETTINGS

Enable QoS
 Live video
 Live audio
 Event/Alarm
 Management

IPV6

Enable IPv6

IPv6 Information

 Manually setup the IP address
 Optional IP address / Prefix length / 64
 Optional default router
 Optional primary DNS

MULTICAST

Enable multicast for stream 1
 Multicast group address
 Multicast video port
 Multicast RTCP video port
 Multicast audio port
 Multicast RTCP audio port
 Multicast TTL [1~255]
 Enable multicast for stream 2
 Multicast group address
 Multicast video port
 Multicast RTCP video port
 Multicast audio port
 Multicast RTCP audio port
 Multicast TTL [1~255]
 Enable multicast for stream 3
 Multicast group address
 Multicast video port
 Multicast RTCP video port
 Multicast audio port
 Multicast RTCP audio port
 Multicast TTL [1~255]

Enable Bonjour: Enable this to allow other network devices to connect to this camera using Bonjour.

Bonjour Name: Enter the name to identify this camera on Bonjour.

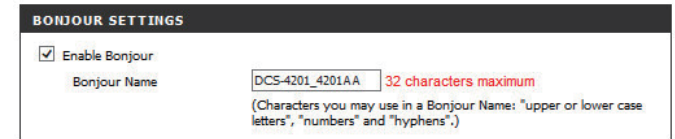

The screenshot shows the 'BONJOUR SETTINGS' section of a configuration interface. It features a checked checkbox for 'Enable Bonjour'. Below it is a text input field for 'Bonjour Name' containing 'DCS-4201_4201AA', with a red warning '32 characters maximum'. A note below the field states: '(Characters you may use in a Bonjour Name: "upper or lower case letters", "numbers" and "hyphens".)'

Wireless Setup

This section allows you to set up and configure the wireless settings on your camera. After making any changes, click the **Save Settings** button to save your changes.

Site Survey: Click the **Rescan** button to scan for available wireless networks. After scanning, you can use the drop-down box to select an available wireless network. The related information (SSID, Wireless Mode, Channel, Authentication, Encryption) will be automatically filled in for you.

SSID: Enter the SSID of the wireless access point you wish to use.

Wireless Mode: Use the drop-down box to select the mode of the wireless network you wish to connect to. Infrastructure is normally used to connect to an access point or router. Ad-Hoc is usually used to connect directly to another computer.

Channel: If you are using Ad Hoc mode, select the channel of the wireless network you wish to connect to, or select Auto.

Authentication: Select the authentication you use on your wireless network - Open, Shared, WPA-PSK, or WPA2-PSK.

Encryption: If you use WPA-PSK or WPA2-PSK authentication, you will need to specify whether your wireless network uses TKIP or AES encryption. If you use Open or Shared authentication, WEP encryption should be the setting.

Key: If you use WEP, WPA-PSK, or WPA2-PSK authentication, enter the Key (also known as password) used for your wireless network.

The screenshot shows the D-Link DCS-4201 web interface. The top navigation bar includes 'DCS-4201', 'LIVE VIDEO', 'SETUP', 'ADVANCED', 'MAINTENANCE', 'STATUS', and 'HELP'. The 'SETUP' menu is expanded to show 'Setup Wizard', 'Network Setup', 'Wireless Setup', 'Dynamic DNS', 'Image Setup', 'Audio and Video', 'Preset', 'Motion Detection', 'Time and Date', 'Event Setup', 'SD Card', and 'Logout'. The 'Wireless Setup' page is active, displaying the 'WIRELESS CONFIGURATION' section. It includes a 'WIRELESS SETUP' header with a 'Save Settings' button. Below this, the 'WIRELESS CONFIGURATION' section contains the following settings:

- Enable Wireless:
- Site Survey: (Rescan)
- SSID: default
- Wireless Mode: Infrastructure
- Channel: Auto
- Authentication: Open
- Encryption: Disable
- Default Key: 1
- Key 1: *****
- Key 2: *****
- Key 3: *****
- Key 4: *****

Below the key fields, there is a note: "(5 or 13 ASCII, 10 or 26 HEX characters)". At the bottom of the configuration section, there is a 'Save Settings' button and a 'Don't Save Settings' button. On the right side of the page, there are 'Helpful Hints...' and 'Authentication' sections with explanatory text.

Dynamic DNS

DDNS allows you to access your camera using a domain name instead of an IP address. To do this, you will need to have an account with one of the DDNS services listed in the drop-down box on this page.

Enable DDNS: Select this checkbox to enable the DDNS function.

Server Address: Select your Dynamic DNS provider from the pull down menu or enter the server address manually.

Host Name: Enter the host name of the DDNS server.

User Name: Enter the user name or e-mail used to connect to your DDNS account.

Password: Enter the password used to connect to your DDNS server account.

Timeout: Enter the DNS timeout values you wish to use.

Status: Indicates the connection status, which is automatically determined by the system.

The screenshot shows the D-Link DCS-4201 web interface. The top navigation bar includes 'LIVE VIDEO', 'SETUP', 'ADVANCED', 'MAINTENANCE', 'STATUS', and 'HELP'. The left sidebar lists various setup options: Setup Wizard, Network Setup, Wireless Setup, Dynamic DNS, Image Setup, Audio and Video, Preset, Motion Detection, Sound Detection, Time and Date, Event Setup, SD Card, and Logout. The main content area is titled 'DYNAMIC DNS' and contains the following text: 'The Dynamic DNS feature allows you to use a domain name that you have purchased (www.yourdomain.com) to access your IP camera with a dynamically assigned IP address. Most broadband Internet service providers assign dynamic (changing) IP addresses. By using a DDNS service, you can enter your domain name to connect to your IP camera no matter what your IP address is.' Below this text is a link: 'Sign up for D-Link's Free DDNS service at www.DLinkDDNS.com.' and two buttons: 'Save Settings' and 'Don't Save Settings'. The 'DYNAMIC DNS SETTING' section includes: 'Enable DDNS' (checkbox), 'Server Address' (text field with a dropdown menu showing 'www.dlinkdns.com'), 'Host Name' (text field), 'User Name' (text field), 'Password' (text field), 'Verify Password' (text field), 'Timeout' (text field with '24' and '(hours)'), and 'Status' (text field showing 'Inactive'). At the bottom of the settings section are 'Save Settings' and 'Don't Save Settings' buttons. A 'Helpful Hints...' sidebar on the right explains that Dynamic DNS is useful for DSL or Cable service providers that change IP addresses periodically and allows assigning a website domain name to the camera instead of connecting through an IP address.

Image Setup

In this section, you may configure the video image settings for your camera. A preview of the image will be shown in Live Video.

Enable Privacy Mask Setting: The Privacy Mask setting allows you to specify up to 3 rectangular areas on the camera's image to be blocked/excluded from recordings and snapshots.

You may click and drag the mouse cursor over the camera image to draw a mask area. Right clicking on the camera image brings up the following menu options:

- **Disable All:** Disables all mask areas
- **Enable All:** Enables all mask areas
- **Reset All:** Clears all mask areas.

Anti Flicker: If the video flickers, try enabling this setting.

Mirror: This will mirror the image horizontally.

Flip: This will flip the image vertically. When turning Flip on, you may want to consider turning Mirror on as well.

Power Line: Select the frequency used by your power lines to avoid interference or distortion.

White Balance: Use the drop-down box to change white balance settings to help balance colors for different environments. You can choose from Auto, Outdoor, Indoor, Fluorescent, and Push Hold. Push Hold will save and lock the currently detected white balance settings when you click Save.

Exposure Mode: Changes the exposure mode. Use the drop-down box to set the camera for Indoor, Outdoor, or Night environments, or to Moving to capture moving objects. The Low Noise option will focus on creating a high-quality picture without noise. You can also create 3 different custom exposure modes. The Max Gain setting will allow you to control the maximum amount of gain to apply to brighten the picture.

Denoise: This setting controls the amount of noise reduction that will be applied to the picture.

Brightness: Adjust this setting to compensate for backlit subjects.

Contrast: Adjust this setting to alter the color intensity/strength.

Saturation: This setting controls the amount of coloration, from grayscale to fully saturated.

Sharpness: Specify a value from 0 to 8 to specify how much sharpening to apply to the image.

Reset Default: Click this button to reset the image to factory default settings.

WDR Level: WDR makes it easier to see objects that may appear dark due to strong backlighting conditions during the daytime. Higher WDR levels will make it easier to see objects in shadows.

3D filtering: 3D filtering reduces the amount of image noise when viewing a low-light environment. Higher levels of 3D filtering will apply stronger levels of noise reduction.

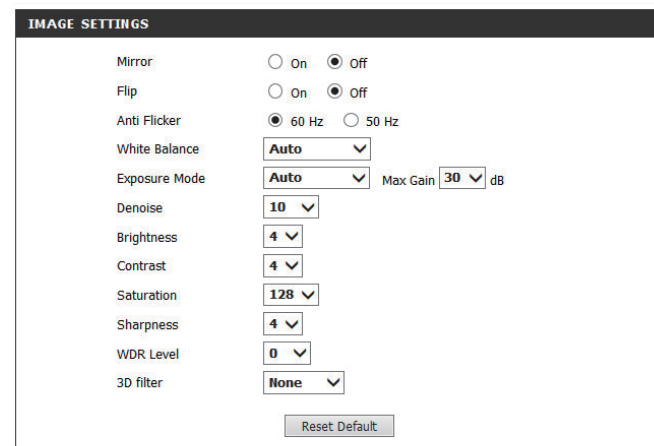

Audio and Video

You may configure up to 3 video profiles with different settings for your camera. Hence, you may set up different profiles for your computer and mobile display. In addition, you may also configure the two-way audio settings for your camera. After making any changes, click the **Save Settings** button to save your changes.

Aspect ratio: Set the aspect ratio of the video to 4:3 standard or 16:9 widescreen.

Mode: Set the video codec to be used to MJPEG or H.264.

Frame size / View window area: Frame size determines the total capture resolution, and View window area determines the Live Video viewing window size. If the Frame size is larger than the Live Video size, you can use the ePTZ controls to look around.

| | |
|------|--|
| 16:9 | 1280 x 720, 800 x 448, 640 x 360, 480 x 272, 320 x 176 |
| 4:3 | 960 x 720, 800 x 592, 640 x 480, 480 x 352, 320 x 240 |

Note: If your View window area is the same as your Frame size, you will not be able to use the ePTZ function.

Maximum frame rate: A higher frame rate provides smoother motion for videos, and requires more bandwidth. Lower frame rates will result in stuttering motion, and requires less bandwidth.

Video Quality: This limits the maximum bandwidth, which can be combined with the "Fixed quality" option to optimize the bandwidth utilization and video quality. If fixed bandwidth utilization is desired regardless of the video quality, choose "Constant bit rate" and select the desired bandwidth.

The screenshot displays the D-Link DCS-4201 web interface for configuring audio and video settings. The interface includes a navigation menu on the left with options like Setup Wizard, Network Setup, and Image Setup. The main content area is titled 'AUDIO AND VIDEO' and contains several configuration sections:

- VIDEO SETTINGS:** Includes an 'Aspect ratio' dropdown set to 4:3, with a warning that changing it will clear privacy mask and motion detection settings. Buttons for 'Save' and 'Default' are present.
- VIDEO PROFILE 1:** Configures 'Mode' (H.264), 'Frame size' (960x720), 'View window area' (960x720), 'Maximum frame rate' (30), and 'Video quality' (Fixed quality, Excellent).
- VIDEO PROFILE 2:** Configures 'Mode' (H.264), 'Frame size' (640x480), 'View window area' (640x480), 'Maximum frame rate' (30), and 'Video quality' (Fixed quality, Excellent).
- AUDIO SETTINGS:** Includes checkboxes for 'Audio in off' and 'Audio out off', 'Audio in gain level' (20dB), and 'Audio out volume level' (7).

Helpful hints on the right side provide additional context for various settings, such as the impact of frame size on bandwidth and the effect of aspect ratio on image quality.

Constant bit rate: The bps will affect the bit rate of the video recorded by the camera. Higher bit rates result in higher video quality.

Fixed quality: Select the image quality level for the camera to try to maintain. High quality levels will result in increased bit rates.

Audio in off: Selecting this checkbox will mute incoming audio.

Audio in gain level: This setting controls the amount of gain applied to incoming audio to increase its volume.

Audio out off: Selecting this checkbox will mute outgoing audio.

Audio out volume level: This setting controls the amount of gain applied to outgoing audio to increase its volume.

The screenshot displays the configuration interface for a camera, divided into three main sections: VIDEO SETTINGS, VIDEO PROFILE 1, VIDEO PROFILE 2, and AUDIO SETTINGS.

- VIDEO SETTINGS:** Aspect ratio is set to 4:3. A warning message states: "Warning: Change the aspect ratio will clear the settings of privacy mask and preset and motion detection." There are "Save" and "Default" buttons.
- VIDEO PROFILE 1:** Mode is H.264, Frame size is 960x720, View window area is 960x720, Maximum frame rate is 30. Video quality is set to Fixed quality (Excellent).
- VIDEO PROFILE 2:** Mode is H.264, Frame size is 640x480, View window area is 640x480, Maximum frame rate is 30. Video quality is set to Fixed quality (Excellent).
- AUDIO SETTINGS:** Audio in off is unchecked, Audio in gain level is 20dB, Audio out off is unchecked, and Audio out volume level is 7. There are "Save Settings" and "Don't Save Settings" buttons at the bottom.

Preset

This screen allows you to set preset points for the ePTZ function of the camera, which allows you to look around the camera's viewable area by using a zoomed view. Presets allow you to quickly go to and view a specific part of the area your camera is covering, and you can create preset sequences, which will automatically change the camera's view between the different presets according to a defined order and timing you can set.

Note: If your View window area is the same as your Frame size, you will not be able to use the ePTZ function.

Video Profile: This selects which video profile to use.

ePTZ Speed: You may select a value between 0 and 64. 0 is the slowest and 64 is the fastest.

Arrow Buttons and Home Button: Use these buttons to move to a specific part of the viewing area, which you can then set as a preset. Click the Home button to return to the center of the viewing area.

Input Preset Name: Enter the name of the preset you want to create, then click the **Add** button to make a new preset. If an existing preset has been selected from the Preset List, you can change its name by typing in a new name, then clicking the **Rename** button.

Preset List: Click this drop-down box to see a list of all the presets that have been created. You can select one, then click the **GoTo** button to change the displayed camera view to the preset. Clicking the **Remove** button will delete the currently selected preset.

Preset Sequence: This section allows you to create a preset sequence, which automatically moves the camera's view between a set of preset views.

The screenshot displays the D-Link DCS-4201 web interface. The top navigation bar includes 'LIVE VIDEO', 'SETUP', 'ADVANCED', 'MAINTENANCE', 'STATUS', and 'HELP'. The 'SETUP' page is active, showing a sidebar with navigation options like 'Setup Wizard', 'Network Setup', 'Dynamic DNS', 'Image Setup', 'Audio and Video', 'Preset', 'Motion Detection', 'Sound Detection', 'Time and Date', 'Event Setup', 'SD Card', and 'Logout'. The main content area is titled 'PRESET CONTROL' and contains a live video feed of a hallway. To the right of the video are controls for 'VIDEO PROFILE' (set to 1) and 'ePTZ Speed' (set to 5), along with directional arrow buttons and a Home button. Below the video feed are sections for 'PRESET' and 'PRESET SEQUENCE'. The 'PRESET' section has an 'Input Preset Name' field with 'Add' and 'Rename' buttons, and a 'Preset List' dropdown with 'GoTo' and 'Remove' buttons. The 'PRESET SEQUENCE' section has a 'Preset Name' field set to 'Dwell time', a 'Dwell time' field set to '10', and 'Add' and 'Update' buttons. A 'Helpful Hints...' sidebar on the right provides instructions on how to use the controls and create preset sequences.

Preset List: To add a preset to the sequence, select it from the drop-down box at the bottom of this window, set the **Dwell time** to determine how long the camera view will stay at that preset, then click the **Add** button. The preset name will appear in the list, followed by the dwell time to view that preset for.

You can rearrange your presets in the sequence by selecting a preset in the sequence, then clicking the arrow buttons to move it higher or lower in the current sequence.

Clicking the trash can button will remove the currently selected preset from the sequence.

If you want to change the dwell time for a preset, select it from the list, enter a new dwell time, then click the **Update** button.

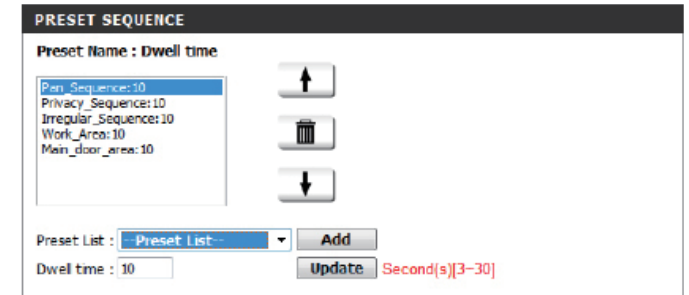

Motion Detection

Motion detection enables the camera to monitor the video feed for movement. Here, you can adjust the sensitivity and percentage settings, which work together to determine whether motion is detected by the camera or not. After making any changes, click the **Save Settings** button to save your changes.

Enable Video Motion: Select this box to enable the motion detection feature of your camera.

Enable PIR: Select this box to enable Passive Infrared detection.

Sensitivity: Specifies how sensitive motion detection will be from 0% to 100%. A low sensitivity setting means that there must be large changes between two images in order to detect motion, and a high sensitivity setting means that even small changes will cause motion to be detected.

Low sensitivities may be useful when monitoring an area that has flickering lights or a window to the outside in view. High sensitivities may be useful when monitoring an area that rarely changes, such as a storeroom or warehouse.



Draw Motion Area: Use your mouse to click and drag on the area that you would like to monitor for motion.

Erase Motion Area: To erase a motion detection area, simply click on the red square that you wish to remove.

Right clicking on the camera image brings up the following menu options:

- **Select All:** Draws a motion detection area over the entire screen.
- **Clear All:** Clears any motion detection areas that have been drawn.
- **Restore:** Restores the previously specified motion detection areas.

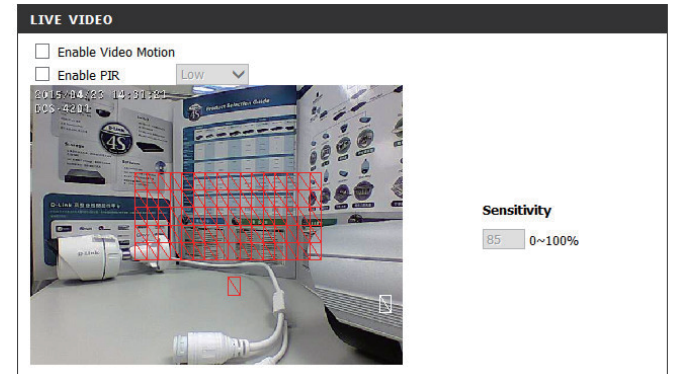

Sound Detection

Sound detection enables the camera to monitor the environment for loud sounds. You may set the volume threshold used to determine whether sound was detected or not.

Enable Sound Detection: Check this box to enable the sound detection feature of your camera.

Detection Level: Specifies the measurable level that would indicate sound. Please enter a value between 50 and 90, the higher the number the more sensitive the camera will be to sound.

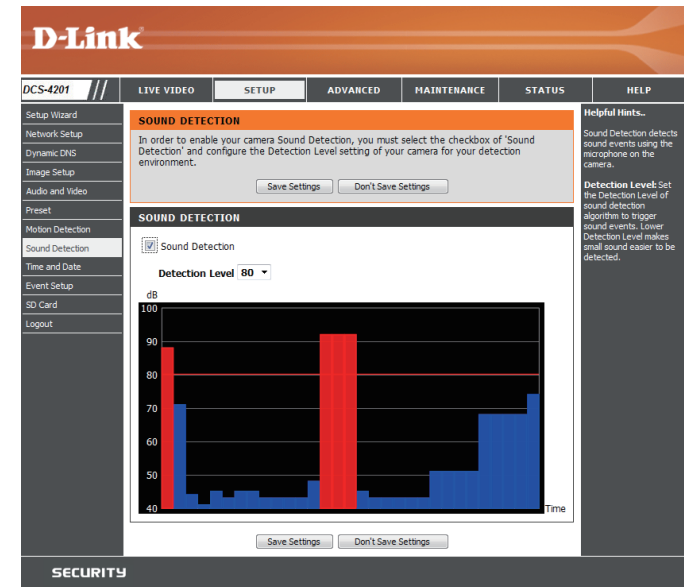

The screenshot displays the D-Link DCS-4201 web interface. The top navigation bar includes 'LIVE VIDEO', 'SETUP', 'ADVANCED', 'MAINTENANCE', 'STATUS', and 'HELP'. The left sidebar lists various setup options: Setup Wizard, Network Setup, Dynamic DNS, Image Setup, Audio and Video, Preset, Motion Detection, Sound Detection (selected), Time and Date, Event Setup, SD Card, and Logout. The main content area is titled 'SOUND DETECTION' and contains the following elements:

- A header section with the text: "In order to enable your camera Sound Detection, you must select the checkbox of 'Sound Detection' and configure the Detection Level setting of your camera for your detection environment." Below this are 'Save Settings' and 'Don't Save Settings' buttons.
- A sub-section titled 'SOUND DETECTION' with a checked checkbox for 'Sound Detection' and a 'Detection Level' dropdown menu set to '80'.
- A bar chart showing sound levels in dB (y-axis, 40 to 100) over time (x-axis). A red bar indicates a detected sound event.
- Another 'Save Settings' and 'Don't Save Settings' button at the bottom of the chart area.
- A 'Helpful Hints...' section on the right side of the page, which includes the text: "Sound Detection detects sound events using the microphone on the camera." and "Detection Level: Set the Detection Level of sound detection algorithm to trigger sound events. Lower Detection Level makes small sound easier to be detected."

At the bottom of the interface, the word 'SECURITY' is displayed.

Time and Date

This section allows you to automatically or manually configure, update, and maintain the internal system clock for your camera. After making any changes, click the **Save Settings** button to save your changes.

Time Zone: Select your time zone from the drop-down menu.

Enable Daylight Saving: Select this to enable Daylight Saving Time.

Auto Daylight Saving: Select this option to allow your camera to configure the Daylight Saving settings automatically.

Set Date and Time Manually: Selecting this option allows you to configure the Daylight Saving date and time manually.

Offset: Sets the amount of time to be added or removed when Daylight Saving is enabled.

Synchronize with NTP Server: Enable this feature to set the time automatically by using an NTP server.

NTP Server: Network Time Protocol (NTP) synchronizes the DCS-4201 with an Internet time server. Choose the one that is closest to your location.

Set the Date and Time Manually: This option allows you to set the time and date manually.

Copy Your Computer's Time Settings: This will synchronize the time information from your PC.



Event Setup

In a typical application, when motion is detected, the DCS-4201 sends images to a FTP server or via e-mail as notifications. As shown in the illustration below, an event can be triggered by many sources, such as motion detection or external digital input devices. When an event is triggered, a specified action will be performed. You can configure the Network Camera to send snapshots or videos to your e-mail address or FTP site.

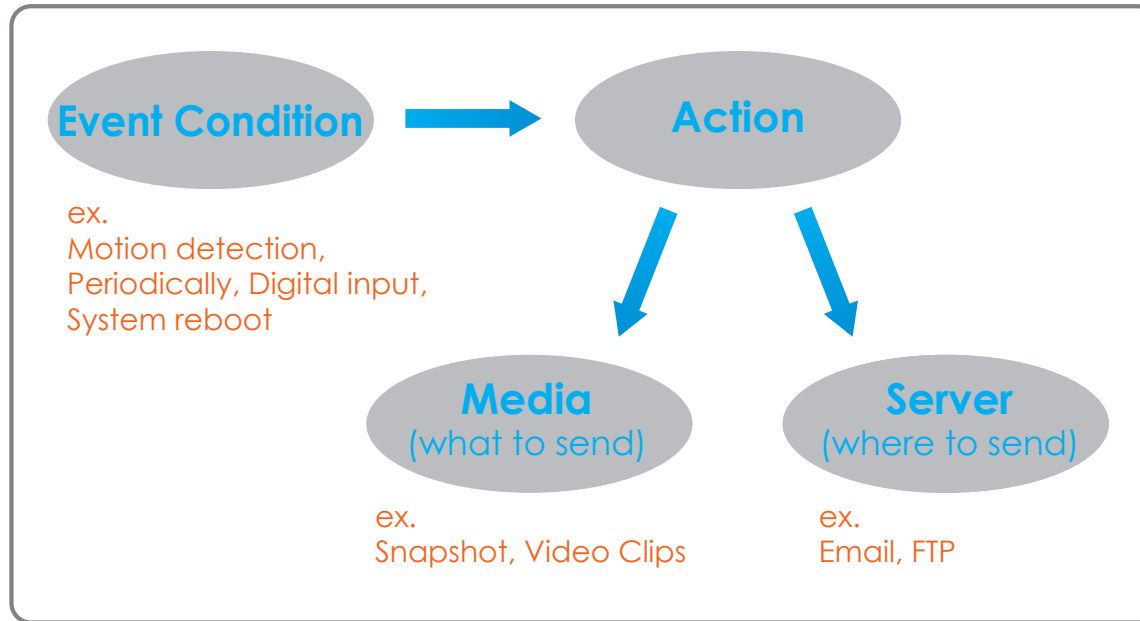

To start plotting an event, it is suggested to configure server and media columns first so that the Network Camera will know what action shall be performed when a trigger is activated.

The Event Setup page includes 4 different sections.

- Server
- Media
- Event
- Recording

1. To add a new item - "event, server or media," click **Add**. A screen will appear and allow you to update the fields accordingly.
2. To delete the selected item from the pull-down menu of event, server or media, click **Delete**.
3. Click on the item name to pop up a window for modifying.

D-Link

DCS-2103 // LIVE VIDEO SETUP ADVANCED MAINTENANCE STATUS HELP

EVENT SETUP

There are four sections in Event Setup page. They are event, server, media and recording. Click Add to pop a window to add a new item of event, server, media or recording. Click Delete to delete the selected item from event, server, media or recording. Click on the item name to pop a window to edit it. There can be at most 2 events and 1 recording. There can be at most 5 server and 5 media configurations.

SERVER

| Name | Type | Address/Location |
|------------------------------------|---------------------------------------|------------------|
| <input type="button" value="Add"/> | <input type="button" value="Delete"/> | |

MEDIA

| Name | Type | Source |
|------------------------------------|---------------------------------------|--------|
| <input type="button" value="Add"/> | <input type="button" value="Delete"/> | |

EVENT

| Name | Status | Sun | Mon | Tue | Wed | Thu | Fri | Sat | Time | Trigger |
|------------------------------------|---------------------------------------|-----|-----|-----|-----|-----|-----|-----|------|---------|
| <input type="button" value="Add"/> | <input type="button" value="Delete"/> | | | | | | | | | |

RECORDING

| Name | Status | Sun | Mon | Tue | Wed | Thu | Fri | Sat | Time | Source | Destination |
|------------------------------------|---------------------------------------|-----|-----|-----|-----|-----|-----|-----|------|--------|-------------|
| <input type="button" value="Add"/> | <input type="button" value="Delete"/> | | | | | | | | | | |

Helpful Hint...

Suggest setting server and media first before setting event. The servers and media which selected in event list are not be able to modify or delete. Please remove them first from the event if you want to delete or modify them. Recommend using different media in different event to make use all media be produced and received correctly. If using the same media in different events and the events trigger almost simultaneously, the triggered event will not receive any media, there would be only notifications.

SECURITY

Add Server

You can configure up to 5 servers to save snapshots and/or video to. After making any changes, click the **Save Settings** button to save your changes.

Server Name: Enter the unique name of your server.

E-mail: Enter the configuration for the target e-mail server account.

FTP: Enter the configuration for the target FTP server account.

Network Storage: Specify a network storage device. Only one network storage device is supported.

SD Card: Use the camera's onboard SD card storage.

The screenshot shows a configuration window titled "SERVER TYPE". It contains several sections, each with a radio button to select a server type:

- Server Name:** A text input field.
- Email:** Selected by default. Fields include: Sender email address, Recipient email address, Server address, User name, Password, and Port (set to 25). There is a checkbox for "This server requires a secure connection (StartTLS)".
- FTP:** Fields include: Server address, Port (set to 21), User name, Password, and Remote folder name. There is a checked checkbox for "Passive mode".
- Network storage:** Fields include: Network storage location (with a note "(for example: \\my_nas\disk\folder)"), Workgroup, User name, Password, and Primary WINS server.
- SD Card:** A radio button option.

At the bottom of the window are three buttons: "Test", "Save Settings", and "Don't Save Settings".

Add Media

There are three types of media, **Snapshot**, **Video Clip**, and **System Log**. After making any changes, click the **Save Settings** button to save your changes.

Media Name: Enter a unique name for media type you want to create.

Snapshot: Select this option to set the media type to snapshots.

Source: Set the video profile to use as the media source. Refer to **Audio and Video** on "Audio and Video" on page 35 for more information on video profiles.

Send pre-event image(s) [0~4]: Set the number of pre-event images to take. Pre-event images are images taken before the main event snapshot is taken.

Send post-event image(s) [0~7]: Set the number of post-event images to take. Post-event images are images taken after the main event snapshot is taken. You can set up to 7 post-event images to be taken.

File name prefix: The prefix name will be added on the file name.

Add date and time suffix to file name: Check it to add timing information as file name suffix.

Video clip: Select this option to set the media type to video clips.

Source: Set the video profile to use as the media source. Refer to "Audio and Video" on page 51 for more information on video profiles.

Pre-event recording: This sets how many seconds to record before the main event video clip starts. You can record up to 4 seconds of pre-event video.

Maximum duration: Set the maximum length of video to record for your video clips.

Maximum file size: Set the maximum file size to record for your video clips.

File name prefix: This is the prefix that will be added to the filename of saved video clips.

System log: Select this option to set the media type to system logs. This will save the event to the camera system log, but will not record any snapshots or video.

The screenshot shows the 'MEDIA TYPE' configuration window. It features a 'Media name' text field at the top. Below it are three radio button options: 'Snapshot' (selected), 'Video Clip', and 'System log'. The 'Snapshot' section includes a 'Source' dropdown menu set to 'Profile1', two 'Send' fields (both set to '1') for 'pre-event image(s) [0~3]' and 'post-event image(s) [0~7]', a 'File Name Prefix' text field, and a checkbox for 'Add date and time suffix to file name'. The 'Video Clip' section includes a 'Source' dropdown menu set to 'Profile1', three fields for 'Pre-event recording: [] Second(s) [0~3]', 'Maximum duration: [] Second(s) [1~100]', and 'Maximum file size: [] Kbytes [100~50000]', and a 'File Name Prefix' text field. The 'System log' section is currently unselected. At the bottom right, there are two buttons: 'Save Settings' and 'Don't Save Settings'.

Add Event

Create and schedule up to 2 events with their own settings here. After making any changes, click the **Save Settings** button to save your changes.

Event name: Enter a name for the event.

Enable this event: Select this box to activate this event.

Priority: Set the priority for this event. The event with higher priority will be executed first.

Delay: Select the delay time before checking the next event. It is being used for both events of motion detection and digital input trigger.

Trigger: Specify the input type that triggers the event.

Video Motion Detection: Motion is detected during live video monitoring. Select the windows that need to be monitored.

Periodic: The event is triggered in specified intervals. The trigger interval unit is in minutes.

Digital input: The external trigger input to the camera.

System Boot: Triggers an event when the system boots up.

Network Lost: Triggers an event when the network connection is lost.

Passive Infrared Sensor: Triggers an event when the PIR sensor detects movement.

Sound Detection: Triggers an event when sound is detected.

EVENT

Event name:

Enable this event

Priority: normal

Delay for 10 seconds before detecting next event [For motion detection and digital input and Passive Infrared sensor]

TRIGGER

Video motion detection

Periodic
Trigger every 1 minutes

Digital input

System boot

Network lost

Passive Infrared sensor

Sound Detection

EVENT SCHEDULE

Sun Mon Tue Wed Thu Fri Sat

Time

Always

From 00 00 To 23 59

ACTION

Trigger D/O for 1 seconds

Time: Select **Always** or enter the time interval.

Action: If you have created Server and Media entries, you will see them appear here. Select which Server you want to send to and which Media you want the camera to send.

Trigger D/O: Select to trigger the digital output for a specific number of seconds when an event occurs.

The screenshot shows a configuration window titled "EVENT SCHEDULE". At the top, there are seven checkboxes for days of the week: Sun, Mon, Tue, Wed, Thu, Fri, and Sat, all of which are checked. Below this is a section labeled "Time" with two radio button options: "Always" (which is selected) and "From" followed by two dropdown menus (both set to "00") and "To" followed by two dropdown menus (both set to "59"). Below the "Time" section is a section labeled "ACTION" with a checkbox labeled "Trigger D/O for" followed by a text input field containing the number "1" and the word "seconds". At the bottom of the window, there are two buttons: "Save Settings" and "Don't Save Settings".

Add Recording

Here you can configure and schedule the recording settings. After making any changes, click the **Save Settings** button to save your changes.

Recording entry name: The unique name of the entry.

Enable this recording: Select this to enable the recording function.

Priority: Set the priority for this entry. The entry with a higher priority value will be executed first.

Source: The source of the stream.

Recording schedule: Scheduling the recording entry.

Recording settings: Configuring the setting for the recording.

Destination: Select the folder where the recording file will be stored.

Total cycling recording size: Please input a HDD volume between 1 MB and 2 TB for recording space. The recording data will replace the oldest record when the total recording size exceeds this value. For example, if each recording file is 6MB, and the total cyclical recording size is 600MB, then the camera will record 100 files in the specified location (folder) and then will delete the oldest file and create new file for cyclical recording.

Please note that if the free HDD space is not enough, the recording will stop. Before you set up this option please make sure your HDD has enough space, and it is better to not save other files in the same folder as recording files.

RECORDING

Recording entry name:

Enable this recording

Priority: normal

Source: Profile 1

RECORDING SCHEDULE

Sun Mon Tue Wed Thu Fri Sat

Time

Always

From To

RECORDING SETTINGS

Destination: None

Total cycling recording size: Mbytes [200~2000000]

Size of each file for recording: Mbytes

Time of each file for recording: seconds

File Name Prefix:

Size of each file for recording: If this is selected, files will be separated based on the file size you specify.

Time of each file for recording: If this is selected, files will be separated based on the maximum length you specify.

File Name Prefix: The prefix name will be added on the file name of the recording file(s).

RECORDING SETTINGS
Destination None ▾
Total cycling recording size: 1000 Mbytes [200~2000000]
 Size of each file for recording: 10 Mbytes
 Time of each file for recording: 10 seconds
File Name Prefix:

SD Card

Here you may browse and manage the recorded files which are stored on the microSD card.

Format SD Card: Click this icon to automatically format the microSD card and create "picture" & "video" folders.

View Recorded Picture: If the picture files are stored on the microSD card, click on the picture folder and choose the picture file you would like to view.

Playback Recorded Video: If video files are stored on the microSD card, click on the video folder and choose the video file you would like to view.

Refresh: Reloads the file and folder information from the microSD card.

The screenshot shows the D-Link DCS-4201 web interface. The main content area is titled "SD CARD" and contains the following information:

SD Card: / SD Status: Ready
 Files per Page: 10 Refresh 1 of 1

| Delete | File | Num of files | Size |
|--------------------------|---------|--------------|------|
| <input type="checkbox"/> | Video | 0 | |
| <input type="checkbox"/> | Picture | 0 | |

Format SD Card Total:15549952KB, Used:96KB, Free:15549856KB

Helpful Hints:

Format SD Card: Click this icon, system will automatically format SD card and create "picture" & "video" folders.

View recorded pictures: If SD stored recorded picture files, enter picture link and choose which picture file you desire to view. You will view picture via image viewer SW. (e. Windows Image Viewer)

Playback recorded videos: If SD stored recorded video files, enter video link and choose which video file you desire to playback. Windows will guide you to open/download video file (AVI format) so that you can playback file via video decoder SW (e. Windows Media Player)

Advanced Digital Input/Output

This screen allows you to control the behavior of digital input and digital output devices. The I/O connector provides the physical interface for digital output (DO) and digital input (DI) that is used for connecting a variety of external alarm devices such as IR-Sensors and alarm relays. The digital input is used for connecting external alarm devices and once triggered images will be taken and e-mailed. After making any changes, click the **Save Settings** button to save your changes.

Select D/I or D/O Mode: The camera will send a signal when an event is triggered, depending upon the type of device connected to the DI circuit.

N.C. stands for **Normally Closed**. This means that the normal state of the circuit is closed. Therefore events are triggered when the device status changes to "Open."

N.O. stands for **Normally Open**. This means that the normal state of the circuit is open. Therefore events are triggered when the device status changes to "Closed."

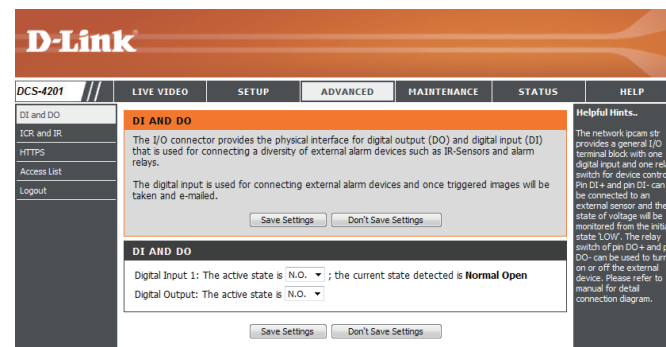

ICR and IR

Here you can configure the ICR and IR settings. The IR(Infrared) Cut-Removable(ICR) filter can be disengaged for increased sensitivity in low light environments.

Automatic: The Day/Night mode is set automatically. You can use the Sensitivity dropdown box to set when the camera will switch to Night mode. The text box to the right shows what lighting conditions are currently being detected by the camera for reference. You can refresh this status by clicking the **Refresh** button.

Day Mode: Day mode enables the IR Cut Filter.

Night Mode: Night mode disables the IR Cut Filter.

Schedule Mode: Set up the Day/Night mode using a schedule. The camera will enter Day mode at the starting time and return to Night mode at the ending time.

IR Light Control: The camera can enable or disable the IR (infrared) light according to your preferences. This setting provides additional controls depending on your specific application.

Off: The IR light will always be off.

On: The IR light will always be on.

Sync with ICR: The IR light will turn on when the ICR sensor is on.

Schedule: The IR light will turn on or off according to the schedule that you specify below.

The screenshot displays the D-Link DCS-4201 web interface. The main content area is titled "ICR AND IR" and contains the following information:

- ICR AND IR:** An IR(Infrared) Cut-Removable(ICR) filter can be disengaged from the image path for increased sensitivity in low light environments. The ICR filter will automatically engage depending on the ambient light, allowing the camera to be effective in day/night environments.
 - Select the Day/Night from the radio button. The available options are Automatic, Schedule mode, Day mode and Night mode.
 - The default value is Automatic.
- Light Sensor Sensitivity:** Light sensor sensitivity has Low, Medium, and High three different levels. You may get current camera light illumination by clicking Refresh button to set proper level of Light sensor sensitivity. For example, when level sets at High less than 30lux, camera will switch Day & Night mode to Night mode.
- IR Light:** The built-in IR light illuminators will be activated automatically or manually so as to supplement the low light situation without additional equipment.

Buttons: Save Settings, Don't Save Settings

ICR

Removable IR-Cut filter trigger condition:

- Automatic Sensitivity: Medium: <20lux over 30 lux Refresh
- Day mode
- Night mode
- Schedule mode

Day mode(24hr)
From 07:00 To 18:00

IR LIGHT

IR Light Control: Medium

- Off
- On
- Sync. With ICR
- Schedule

IR Light Control On(24hr)
From 07:00 To 18:00

Buttons: Save Settings, Don't Save Settings

Helpful Hints...

- Automatic:** The day/night mode is set automatically. It is normally set in the Day mode and changes to the Night mode in a dark place.
- Day mode:** The Day mode means disable the IR Cut Filter.
- Night mode:** The Night mode means enable the IR Cut Filter.
- Schedule mode:** Set the Day/Night mode using the schedule. Fill in the time so the Day/Night mode is normally set to Day mode and it enters the Day mode at the start time and returns to the Night mode at the end time.
- IR Light Control:** In poor light conditions, open IR Light Control to automatically turn on the light to enable you to take clear picture. The IR Light Control has 4 options: Off, On, Sync. with ICR, and Schedule. Off: This option disable the IR Light Control. On: This option automatically opens the IR Light Control to enable a camera to take clear images in poor light conditions. Sync. with ICR: In this option, the IR Light Control will open automatically and follow the ICR setting. Schedule: In this option, you have to customize the setting to set the time period you want. Please set the Start time and the End time of your chosen schedule.

HTTPS

This page allows you to install and activate an HTTPS certificate for secure access to your camera. After making any changes, click the **Save Settings** button to save your changes.

Enable HTTPS Secure Connection: Enable the HTTPS service.

Create Certificate Method: Choose the way the certificate should be created. Three options are available:

- Create a self-signed certificate automatically
- Create a self-signed certificate manually
- Create a certificate request and install

Status: Displays the status of the certificate.

Note: The certificate cannot be removed while HTTPS is still enabled. To remove the certificate, you must first uncheck **Enable HTTPS secure connection**.

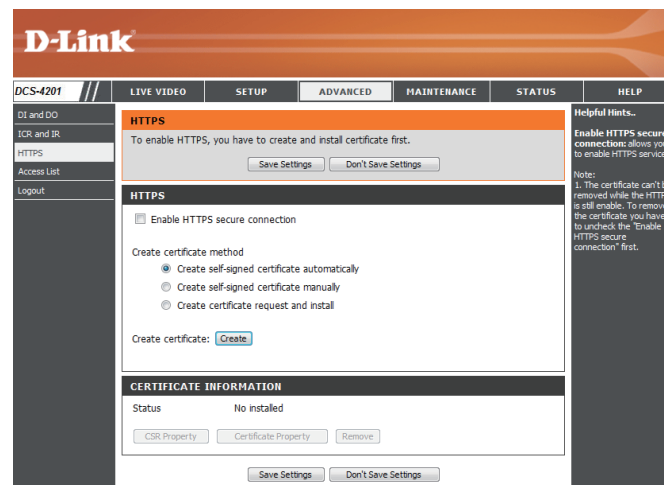

Access List

Here you can set access permissions for users to view your DCS-4201.

Allow list: The list of IP addresses that have the access right to the camera.

Start IP address: The starting IP Address of the devices (such as a computer) that have permission to access the video of the camera. Click **Add** to save the changes made.

Note: A total of seven lists can be configured for both columns.

End IP address: The ending IP Address of the devices (such as a computer) that have permission to access the video of the camera.

Delete allow list: Remove the customized setting from the Allow List.

Deny list: The list of IP addresses that have no access rights to the camera.

Delete deny list: Remove the customized setting from the Delete List.

For example:

When the range of the Allowed List is set from 1.1.1.0 to 192.255.255.255 and the range of the Denied List is set from 1.1.1.0 to 170.255.255.255. Only users with IPs located between 171.0.0.0 and 192.255.255.255 can access the Network Camera.

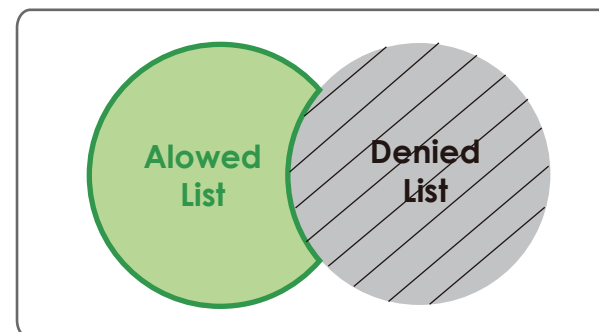
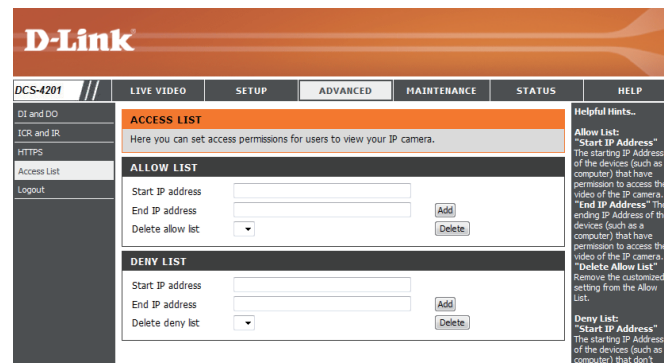

Maintenance

Device Management

You may modify the name and administrator's password of your camera, as well as add and manage the user accounts for accessing the camera. You may also use this section to create a unique name and configure the OSD settings for your camera.

Admin Password Setting: Set a new password for the administrator's account.

Add User Account: Add a new user account.

User Name: Enter the user name for the new account.

Password: Enter the password for the new account.

User List: All the existing user accounts will be displayed here. You may delete accounts included in the list, but you may want to reserve at least one as a guest account.

IP Camera Name: Create a unique name for your camera that will be added to the file name prefix when creating a snapshot or a video clip.

Enable OSD: Select this option to enable the On-Screen Display feature for your camera.

Label: Enter a label for the camera, which will be shown on the OSD when it is enabled.

Show Time: Select this option to enable the time-stamp display on the video screen.

LED: You may specify whether or not to illuminate the status LED on the camera.

D-Link

DCS-4201 // LIVE VIDEO SETUP ADVANCED MAINTENANCE STATUS HELP

ADMIN

Here you can change the administrator's password for your IP camera as well as add and/or delete user account(s). You can configure the information, such as IP camera's name and time via this page. You can also enable the OSD (On-Screen Display) feature in order to display the IP camera name and time stamp for your video recordings.

ADMIN PASSWORD SETTING

New Password 32 characters maximum
Retype Password

ADD USER ACCOUNT

User Name 20 users maximum
New Password 32 characters maximum
Retype Password

USER LIST

User Name

DEVICE SETTING

IP Camera Name DCS-2103 63 characters maximum
 Enable OSD
Label DCS-2103 30 characters maximum
Show Time

LED

LED On Off

Helpful Hints...

Enabling OSD, the IP camera name and time will be displayed on the video screen for the user.

For security purposes, it is recommended that you change the password for your administrator account. Be sure to write down the new password to avoid having to reset the IP camera in the event that it is forgotten.

LED: In the rear panel of your camera there is a LED beside the network adapter. ON: The LED will flash a light to indicate if the network is working or not. OFF: No light will show, forth option is turn off.

Privacy Control: Allow you to configure if camera could enter Privacy mode or not.

Privacy Off: Camera is in a normal operating mode.

Privacy On: Camera is in a Privacy mode. Live Video, Video Clip, Snapshot and SD Recording will be turned off.

SECURITY

Copyright © 2014 D-Link Corporation.

System

In this section, you may back up, restore and reset the camera configuration, or reboot the camera.

Save To Local Hard Drive: You may save your current camera configuration as a file on your computer.

Local From Local Hard Drive: Locate a pre-saved configuration by clicking **Browse** and then restore the pre-defined settings to your camera by clicking **Load Configuration**.

Restore to Factory Default: You may reset your camera and restore the factory settings by clicking **Restore Factory Defaults**.

Reboot Device: This will restart your camera.

Enable Schedule Reboot: You can schedule the camera to reboot according to a schedule. Select the days and time you want the camera to automatically reboot.

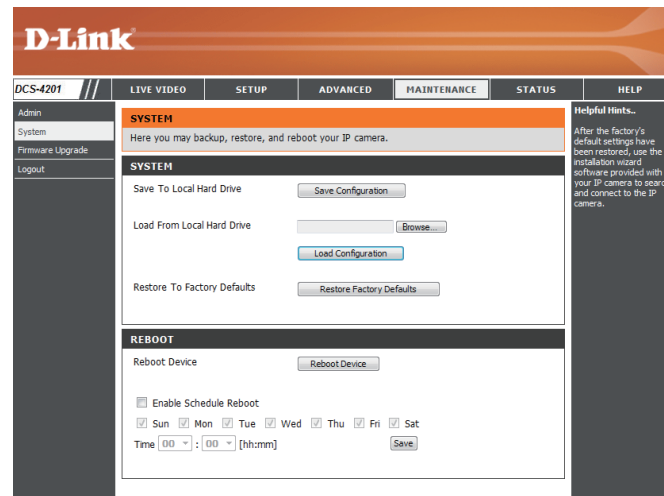

Firmware Upgrade

The camera's current firmware version will be displayed on this screen. You may visit the D-Link Support Website to check for the latest available firmware version.

To upgrade the firmware on your DCS-4201, please download and save the latest firmware version from the D-Link Support Page to your local hard drive. Locate the file on your local hard drive by clicking the **Browse** button. Select the file and click the **Upload** button to start upgrading the firmware.

Current Firmware Version: Displays the detected firmware version.

Current Product Name: Displays the camera model name.

File Path: Locate the file (upgraded firmware) on your hard drive by clicking **Browse**.

Upload: Uploads the new firmware to your camera.

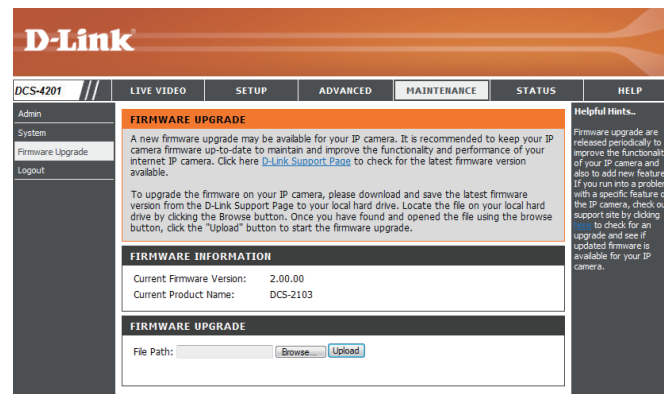

Status

Device Info

This page displays detailed information about your device and network connection.

The screenshot shows the D-Link web interface for a DCS-4201 device. The top navigation bar includes links for LIVE VIDEO, SETUP, ADVANCED, MAINTENANCE, STATUS (selected), and HELP. The left sidebar contains links for Device Info (selected), Log, and Logout. The main content area is titled 'DEVICE INFO' and contains a descriptive paragraph and a table of device information. A 'Helpful Hints..' section is visible on the right side of the main content area.

| INFORMATION | |
|------------------|--------------------------|
| IP Camera Name | DCS-4201 |
| Time & Date | Sat Jan 11 15:01:18 2014 |
| Firmware Version | 1.00.00 |
| Hardware Version | A |
| MAC Address | 0A:CA:21:03:B1:01 |
| IP Address | 192.168.0.113 |
| IP Subnet Mask | 255.255.255.0 |
| Default Gateway | 192.168.0.1 |
| Primary DNS | 192.168.0.1 |
| Secondary DNS | 0.0.0.0 |
| PPPoE | Disable |
| DDNS | Disable |

Logs

This page displays the log information of your camera. You may download the information by clicking **Download**. You may also click **Clear** to delete the saved log information.

D-Link

DCS-4201 // LIVE VIDEO SETUP ADVANCED MAINTENANCE STATUS HELP

Device Info
Log
Logout

SYSTEM LOG
The system log records IP camera events that have occurred.

CURRENT LOG

1. 2014-01-11 14:59:24 NETWORK RECONNECT
2. 2014-01-11 14:59:15 NETWORK LOSS
3. 2014-01-11 14:58:52 SYSTEM SET IR LIGHT OFF
4. 2014-01-11 14:58:36 SYSTEM SET IR LIGHT ON
5. 2014-01-11 14:57:47 DCS-2103 ACQUIRE DHCP IP 192.168.0.113
6. 2014-01-11 14:57:47 NETWORK RECONNECT
7. 2014-01-11 14:57:43 NETWORK LOSS
8. 2014-01-11 14:56:19 SYSTEM SET IR LIGHT OFF
9. 2014-01-11 14:56:09 SYSTEM SET IR LIGHT ON
10. 2014-01-11 14:55:44 admin FROM 192.168.0.174 SET VIDEO CODEC Need Reset
11. 2014-01-11 14:55:39 admin FROM 192.168.0.174 SET PROFILE 1 Viewer window area 320x176
12. 2014-01-11 14:55:39 admin FROM 192.168.0.174 SET PROFILE 1 Frame Size 320x176
13. 2014-01-11 14:55:15 DCS-2103 ACQUIRE DHCP IP 192.168.0.113
14. 2014-01-11 14:55:15 NETWORK RECONNECT
15. 2014-01-11 14:54:56 NETWORK LOSS
16. 2014-01-11 14:54:44 admin LOGIN OK FROM 192.168.0.174
17. 2014-01-11 14:53:19 DCS-2103 ACQUIRE DHCP IP 192.168.0.113
18. 2014-01-11 14:53:18 NETWORK RECONNECT
19. 2014-01-11 14:53:13 NETWORK LOSS
20. 2014-01-11 14:53:13 SYSTEM SET IR LIGHT OFF

First Page Previous 20 Next 20

Clear Download

Helpful Hints..
You can save the log to your local hard IP camera by clicking the Download button, and you can clear the log by clicking on the Clear button.

Help

This page provides helpful information regarding camera operation.

| |
|---|
| HELP |
| <ul style="list-style-type: none">• LIVE VIDEO• SETUP• MAINTENANCE• ADVANCED• STATUS |
| LIVE VIDEO |
| <ul style="list-style-type: none">• Camera |
| SETUP |
| <ul style="list-style-type: none">• Setup Wizard• Network Setup• Wireless Setup• Dynamic DNS• Image Setup• Audio and Video• Preset• Motion Detection• Time and Date• Event Setup• SD Card |
| ADVANCED |
| <ul style="list-style-type: none">• PI and PO• KR and IR• HTTOS• Access List |
| MAINTENANCE |
| <ul style="list-style-type: none">• Admin• System• Firmware Upgrade |
| STATUS |
| <ul style="list-style-type: none">• Device Info• Log |

DI/DO Specifications

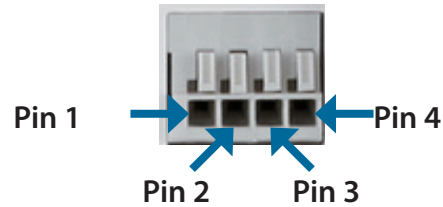

| PIN | FUNCTION | NOTE |
|-----|-------------------------|--|
| 1 | Digital Out (DO) | Uses an open-drain NFET transistor with the source connected to GND in camera. If used with an external relay, a diode must be connected in parallel with the load for protection against voltage transients. Max loading is 100 mA. |
| 2 | Digital In (DI) | A switch from DI to DC 5 V, activated by setting NO. or NC. |
| 3 | DC5V OUTPUT | DC 5 V Output / Max. 100 mA |
| 4 | GND | GND |

Internal 5V Power

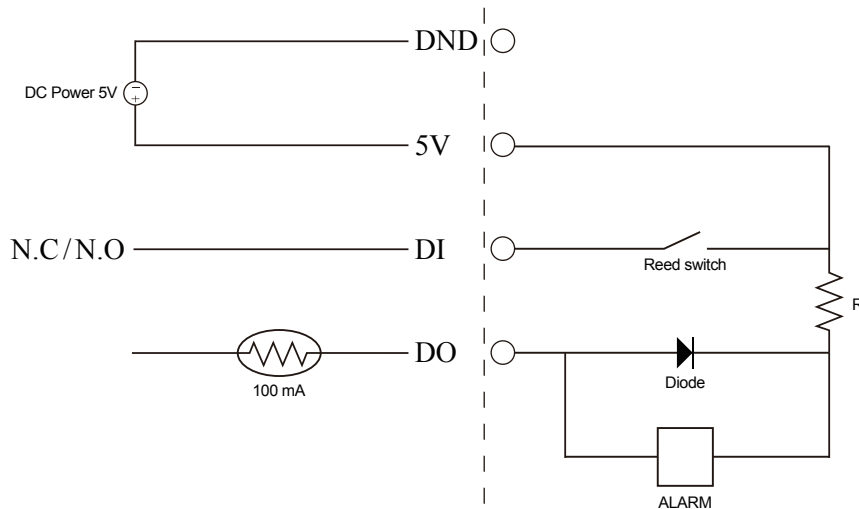

External 3~12V Power

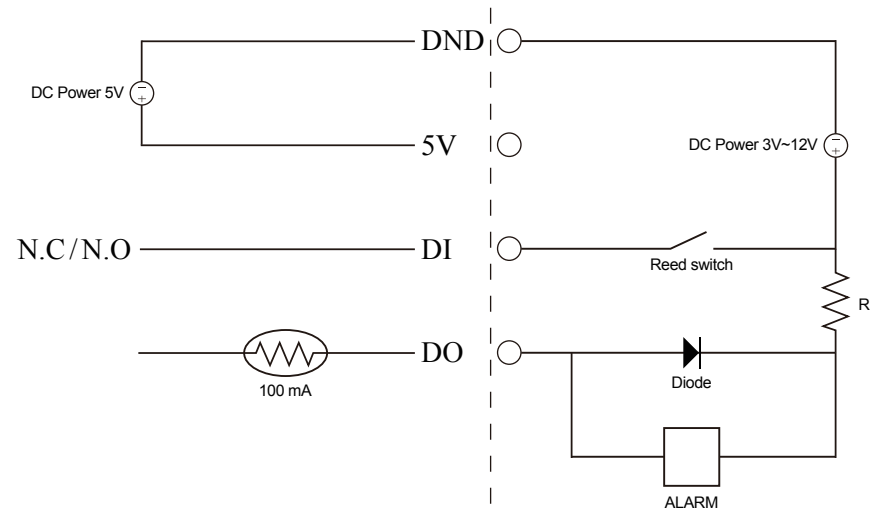

Technical Specifications

| | | | |
|----------------|---------------------------|--|--|
| Camera | Camera Hardware Profile | <ul style="list-style-type: none"> ▪ 1/4" Megapixel progressive CMOS sensor ▪ 10 meter IR illumination distance ▪ Minimum illumination: 0 lux with IR LED on ▪ Built-in Infrared-Cut Removable (ICR) Filter module ▪ Built-in PIR sensor ▪ Built-in microphone and speaker | <ul style="list-style-type: none"> ▪ 10x digital zoom ▪ Focal length: 1.8 mm ▪ Aperture: F2.4 ▪ Angle of view: <ul style="list-style-type: none"> ▪ (H) 97.6° ▪ (V) 69.2° ▪ (D) 108.9° |
| | Image Features | <ul style="list-style-type: none"> ▪ Configurable image size, quality, frame rate, and bit rate ▪ Time stamp and text overlays ▪ Configurable motion detection windows | <ul style="list-style-type: none"> ▪ Configurable privacy mask zones ▪ Configurable shutter speed, brightness, saturation, contrast, and sharpness |
| | Video Compression | <ul style="list-style-type: none"> ▪ Simultaneous H.264/MJPEG format compression ▪ H.264 multicast streaming | <ul style="list-style-type: none"> ▪ JPEG for still images |
| | Video Resolution | 16:9 - 1280x720, 800x448, 640x360, 480x272, 320x176 | 4:3 - 960x720, 800x592, 640x480, 480x352, 320x240 |
| | Audio Support | G.711, AAC | |
| | External Device Interface | <ul style="list-style-type: none"> ▪ 10/100 BASE-TX Fast Ethernet port ▪ DI/DO port | <ul style="list-style-type: none"> ▪ MicroSD card slot ▪ 802.11n wireless |
| Network | Network Protocols | IPv6 IPv4 TCP/IP UDP ICMP DHCP client NTP client (D-Link) DNS client DDNS client (D-Link) SMTP client FTP client | HTTP / HTTPS Samba Client PPPoE UPnP port forwarding RTP / RTSP / RTCP IP filtering QoS CoS Multicast SNMP ONVIF compliant |
| | Security | <ul style="list-style-type: none"> ▪ Administrator and user group protection ▪ Password authentication | <ul style="list-style-type: none"> ▪ HTTP and RTSP digest encryption |

Appendix B: Technical Specifications

| | | | |
|--------------------------|---|---|--|
| System Management | System Requirements for Web Interface | <ul style="list-style-type: none"> Operating System: Microsoft Windows 8/7/Vista | <ul style="list-style-type: none"> Browser: Internet Explorer, Firefox |
| | Event Management | <ul style="list-style-type: none"> Motion detection Event notification and uploading of snapshots/video clips via e-mail or FTP | <ul style="list-style-type: none"> Supports multiple SMTP and FTP servers Multiple event notifications Multiple recording methods for easy backup |
| | Remote Management | <ul style="list-style-type: none"> Take snapshots/video clips and save to local hard drive | <ul style="list-style-type: none"> Configuration interface accessible via web browser |
| General | Weight | 118g | |
| | Power Supply | 5 VDC, 1.2 A | |
| | Power Consumption | 4.0 +-5% watts | |
| | Temperature | Operating: 0 to 40 °C (32 to 104 °F) | Storage: -20 to 70 °C (-4 to 158 °F) |
| | Humidity | Operating: 20% to 80% non-condensing | Storage: 5% to 95% non-condensing |
| | Certifications | CE CE LVD | FCC C-Tick |
| Dimensions | <p>The image contains two technical drawings of the D-Link DCS-4201 camera. The left drawing is a side view showing the camera's profile. It has a total width of 89 units and a height of 81.6 units. The camera head is tilted, and its width is 30.7 units. The right drawing is a front view showing the camera's face. It has a total height of 127.9 units and a width of 58 units. The front view shows a lens in the center, two circular buttons below it, and the 'D-LINK' logo at the bottom of the camera head.</p> | | |