

DCS-3411/3430

Version 1.01

**Day & Night Network Camera**  
(DCS-3411)

**Wireless N Day & Night Network Camera**  
(DCS-3430)

 **User Manual**

**Business Class Networking**

# Table of Contents

<b>Product Overview</b> .....	<b>3</b>	Snapshot.....	46
Package Contents.....	3	Digital Output.....	47
System Requirements.....	3	Advanced ICR.....	48
Introduction .....	4	RS-485.....	49
Features.....	5	Maintenance .....	50
Hardware Overview.....	6	Device Admin.....	50
Hardware Installation.....	8	System .....	51
Software Installation .....	10	Firmware Upgrade.....	52
<b>Configuration</b> .....	<b>22</b>	Status .....	53
Setup Wizard Configuration .....	22	Device Info .....	53
Web-based Configuration Utility.....	25	Logs .....	54
Live Video .....	26	Help .....	55
Camera .....	26	<b>D-ViewCam Installation</b> .....	<b>56</b>
Setup.....	27	Add a Camera.....	59
Wizard .....	27	<b>Troubleshooting</b> .....	<b>64</b>
Internet Connection Setup Wizard.....	27	<b>DI/DO</b> .....	<b>67</b>
Motion Detection Setup Wizard.....	31	<b>Networking Basics</b> .....	<b>69</b>
Network Setup.....	34	Check your IP address.....	69
Wireless Setup.....	36	Statically Assign an IP address.....	70
Dynamic DNS .....	37	<b>Technical Specifications</b> .....	<b>71</b>
Image Setup .....	38		
Audio and Video.....	39		
Motion Detection .....	41		
Time and Date.....	42		
Recording .....	43		
How to save video to a shared folder? .....	44		

# Package Contents

- D-Link DCS-3411/3430 Day & Night Network Camera
- CAT5 Ethernet Cable
- Power Adapter
- Manual and Software on CD
- Quick Install Guide
- Camera Stand
- 2 Antennas (DCS-3430 only)

Note: Using a power supply with a different voltage than the one included with the package will cause damage and void the warranty for this product.

If any of the above items are missing, please contact your reseller.



# System Requirements

- Windows® XP or Windows Vista®
- At least 256MB of memory (512MB recommended)
- An available Ethernet connection
- Wireless 802.11n network (for DCS-3430 only)
- Internet Explorer 6.x or higher Internet Web Browser
- VGA card resolution: 800x600 or above
- CPU: 1.7GHz or above processor (2.8GHz plus processor with 512MB memory and a 32MB video card is required for multiple camera viewing and recording using the D-ViewCam software)

# Introduction

The D-Link DCS-3411/3430 Day & Night Network Camera is a powerful surveillance system that can connect to your network. The DCS-3411/3430 differs from a conventional PC Camera because it is a stand-alone system with a built-in CPU and Web server, providing low-cost solution capable of solving demanding security and home/office monitoring needs. It is designed with an aluminum cast for maximum heat dissipation and better protection. Snapshot enables you to save a snapshot image directly from a Web browser to a local hard drive without installing any software. H.264 can reduce the size of video stream around 80% compared with the Motion JPEG and as much as 50% when compared with MPEG4. Using less network bandwidth and storage space allows the DCS-3411/3430 to be a very cost effective network camera. With 0.5 lux light sensitivity, the DCS-3411/3430 is capable of capturing video in rooms with minimal lighting. With optional Day & Night Auto Iris lens, IR LED lens or night vision illuminator, you can customize your surveillance application to enable low light or night vision video streaming. You can also zoom in using the DCS-3411/3430's 16x digital zoom feature. The DCS-3411/3430 gives you the ability to monitor video and audio in your home/office using an Internet browser anywhere in the world! Simple installation procedures, along with the built-in Web-based interface offers easy integration to your network environments.

Note: Use of audio or video equipment for recording the image or voice of a person without their knowledge and consent is prohibited in certain states or jurisdictions. Nothing herein represents a warranty or representation that the D-Link product provided herein is suitable for the end-user's intended use under the applicable laws of his or her state. D-Link disclaims any liability whatsoever for any end-user use of the D-Link product, which fails to comply with applicable state, local, or federal laws.

# Features

- **Multiple Stream Types:** Choose between H.264 / MPEG4 / MJPEG depending on the type of application the camera is being used for. When using H.264 you can reduce the bandwidth and storage needs by up to 80% when compared to MJPEG or by up to 50% when compared with MPEG4.
- **Supports a Variety of Protocols:** Supporting TCP/IP networking, SMTP e-mail, HTTP and other Internet related protocols, the DCS-3411/3430 Network Camera can be integrated easily into other Internet/Intranet applications because of its standards-based features.
- **Remote Snapshot Images:** Using the Snapshot feature, you save snapshots directly from the Web browser to a local hard drive without installing any software, making it convenient to instantly capture any moment from a remote location.
- **Low Light Recording and 16x Digital Zoom:** The DCS-3411/3430's 0.5 lux light sensitivity allows you to capture video in rooms with minimal lighting, making it ideal for use at night time. The camera also features 16x digital zoom for closer viewing.
- **Optional Day & Night Auto iris lens, IR LED Lens or night vision illuminator<sup>2</sup>,** you can customize your surveillance application to enable low light or night vision video streaming.
- **Web Configuration:** Using the Web browser, administrators can configure and manage the Network Camera directly using the web browser via Intranet or Internet. Up to 10 accounts with different settings can be created and controlled by the administrator.
- **Built-in BNC (Bayonet Neil-Concelman) connector** is used for professional video connections. It benefits users who integrate digital IP camera into traditional system (CCTV) for both analog and digital video streaming purposes.
- **Powerful Surveillance and Remote Monitoring Utility:** An administrator is assigned with a pre-defined user ID and password, can modify the Network Camera settings from a remote site via Intranet or Internet. Administrators are allowed to monitor the video image, record the video image to a hard drive, and take snapshots.
- **Broad Range of Applications:** With today's high-speed Internet, the Network Camera provides the ideal solution for remotely monitoring live video images over the Intranet and Internet. The DCS-3411/3430 allows remote access using an Internet Explorer or web browser for live image viewing with audio and allows the administrator to manage and control the Network Camera anywhere and anytime. Apply the Network Camera to monitor various objects and places such as homes, offices, banks, hospitals, child-care centers, amusement parks and other varieties of industrial and public monitoring. The Network Camera can also be used for intruder detection with its motion-detection mode, capture still images and video images for archiving and many more applications.

# Hardware Overview

## Ethernet Cable Connector (PoE only with 3411)

The Network Camera's back panel features an RJ-45 connector for connections to 10Base-T Ethernet cabling or 100Base-TX Fast Ethernet cabling. This network port supports the NWay protocol, allowing the Network Camera to automatically detect or negotiate the transmission speed of the network.

## Iris Level

Used only when the DC-Iris lens is connected to the camera. When adjusting the Iris level, you can determine the brightness of the video images.

## Audio Out Connector

The DCS-3411/3430 provides an Audio Out connector to be used for 2-way audio. Speakers (not included) may be connected to the camera to provide audio for 2-way communication.

## Reset Button

Reset will be initiated when the reset button is pressed once and held until the Power LED flashes through its cycle twice.

## BNC

The BNC connector is used for professional video connections. It benefits users who integrate digital IP camera into traditional system (CCTV) for both analog and digital video streaming purposes.

## Microphone Connector

The DCS-3411/3430 Day & Night Network Camera has an internal microphone built-in. However, you have the option of using an external microphone by plugging it into the microphone connector.

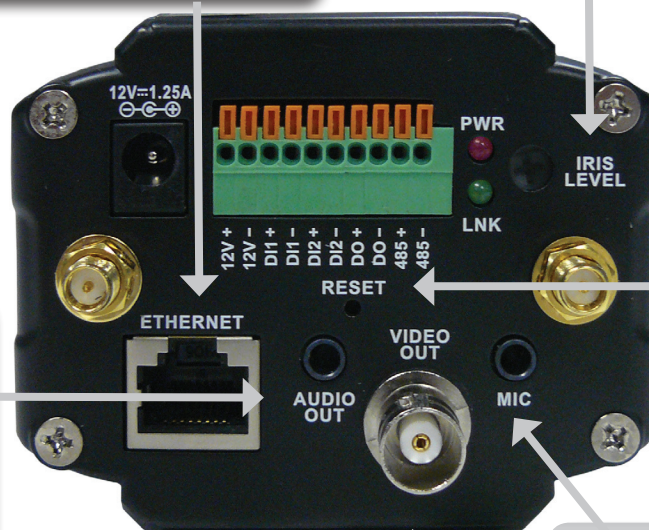

# Hardware Overview

## DC Power Connector

The DC power input connector is located on the DCS-3411/3430 Network Camera's back panel and is labeled 12V DC with a single socket to supply power to the Network Camera.

## I/O Connector

The DCS-3411/3430 provides a terminal block with three pairs of connectors situated on the back panel. Two pairs are for input and the other is for output. The I/O connectors provide the physical interface to send and receive digital signals to and from a variety of external devices.

## Power LED

The power LED is on the back of the camera. As soon as the power adapter is connected to the camera, the LED will turn red. Once a connection has been established via Ethernet port, the LINK LED will turn solid green. If traffic is passing to the camera the LINK LED will blink. If no Ethernet connection is detected the LINK LED will not light up.

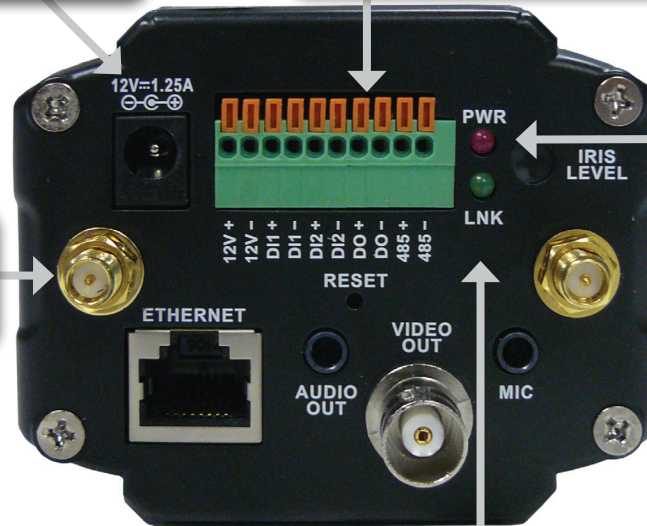

**Antenna Connectors (DCS-3430)**  
Connects to the wireless antennas.

## Link LED

Once a connection has been established via Ethernet port, the LINK LED will turn solid green. If traffic is passing to the camera the LINK LED will blink. If no Ethernet connection is detected the LINK LED will not light up.

# Hardware Installation

## Attach the Antennas (DCS-3430 only)

Locate the antennas included with your DCS-3430, and attach them to the antenna connectors located on the back of the DCS-3430.



## Connect the Ethernet Cable

Connect an Ethernet cable to the network cable connector located on the Network Camera's back panel and attach it to the network.



## Attach the External Power Supply

Attach the external power supply to the DC power input connector located on the Network Camera's back panel (labeled DC 12V) and connect it to an AC power outlet.

Note: When you have a proper connection, the LED will turn red. The light may cycle on and off and your computer may show an intermittent loss of connectivity, this is normal until you have configured your Network Camera.

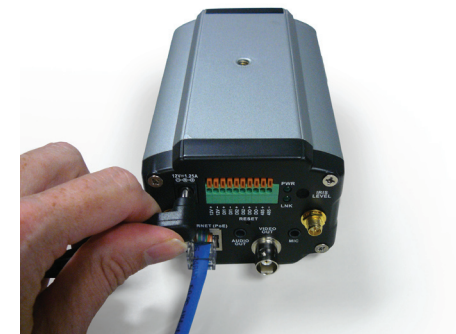

## Connect Using Power-Over-Ethernet

Once you connect an Ethernet cable to your PoE switch or adapter, the Power LED on the DCS-3411/3430 will turn red to indicate a proper connection.



The Network Camera comes with a camera stand with a swivel ball screw head that can be attached to the Network Camera bottom socket cavity. Attach the camera stand to the Network Camera and station it for your application. There are holes located in the base of the camera stand allowing the Network Camera to be mounted to the ceiling, or any wall securely.

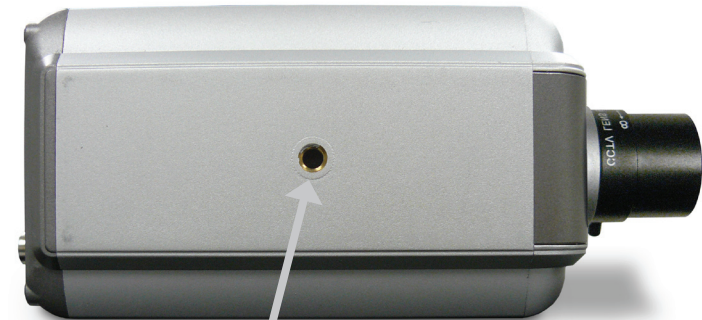

Socket for camera stand

# Software Installation

Turn on the computer and Insert the D-Link DCS-3411/3430 Driver CD in the CD-ROM drive. The step-by-step instructions that follow are shown in Windows® XP. The steps and screens are similar for the other Windows operating systems.

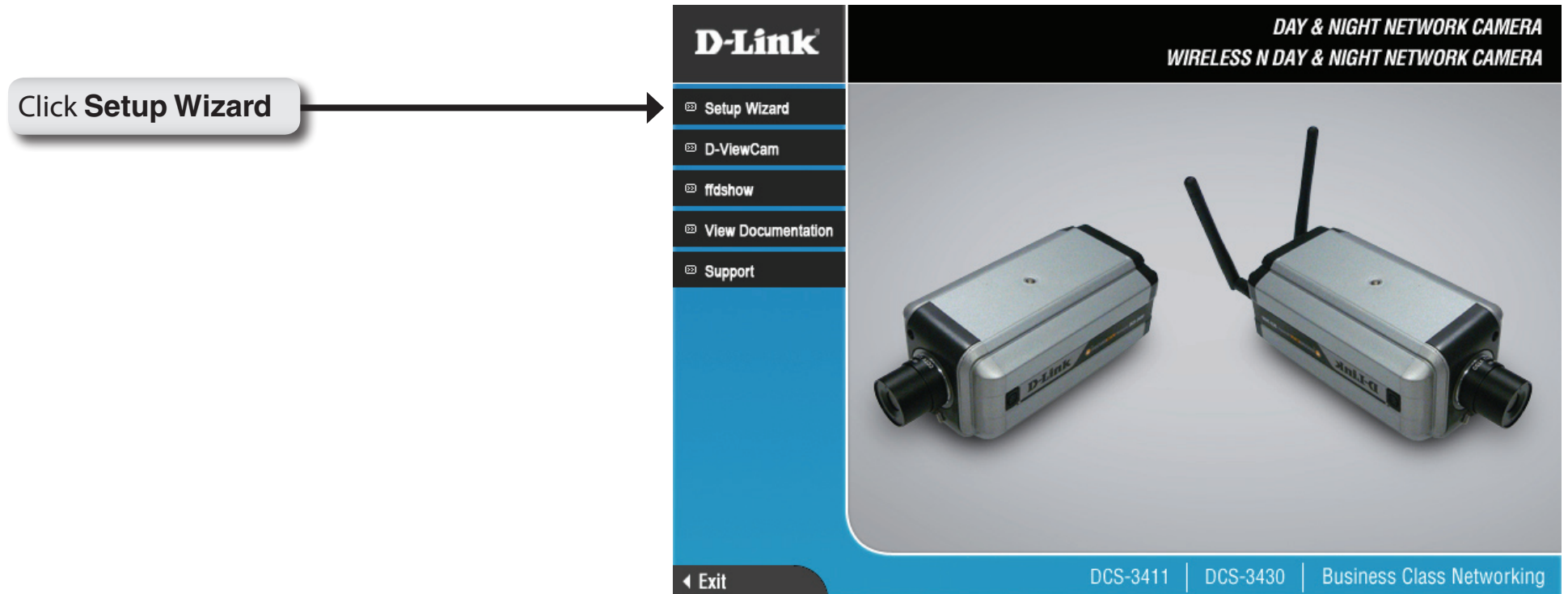

If the CD Autorun function does not automatically start on your computer, click Windows Start > Run. In the Run command box type "**D:\DCS-3411\_3430.exe**", where D: represents the drive letter of your CD-ROM. If it does start, proceed to the next screen.

Click **Next** to continue.

Click **Next**

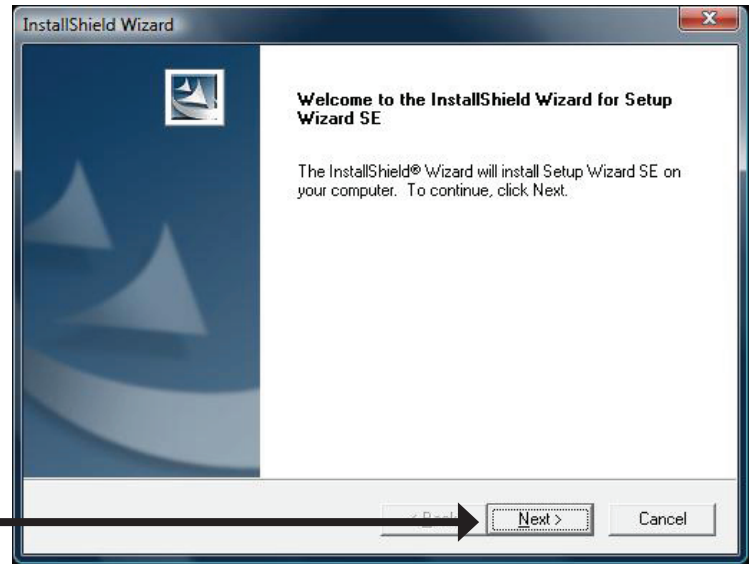

Click **Yes** to accept the License Agreement.

Click **Yes**

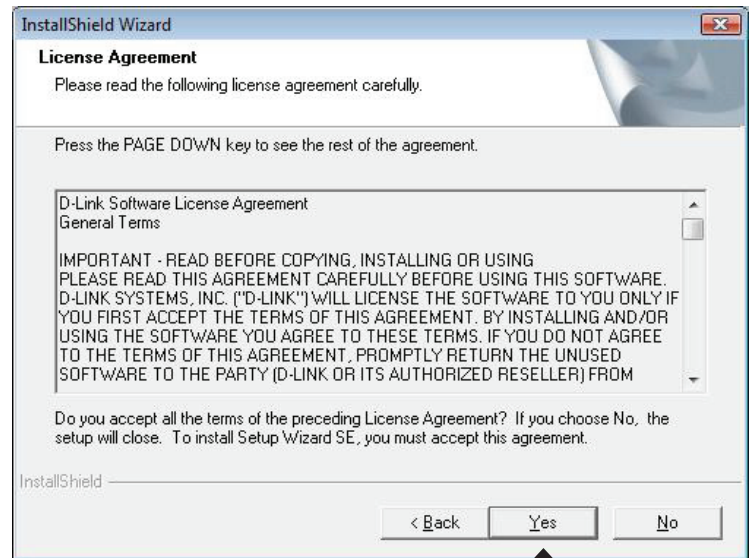

To start the installation click **Next**.

Note: The installation may take several minutes to complete.

Click **Next**

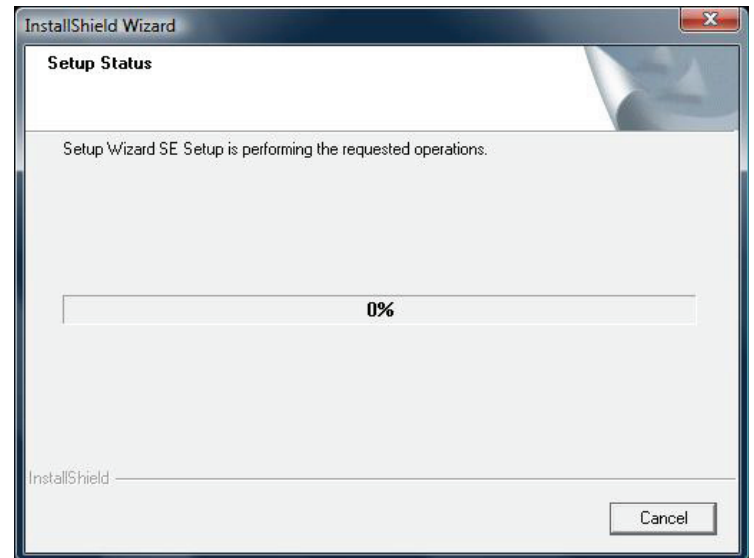
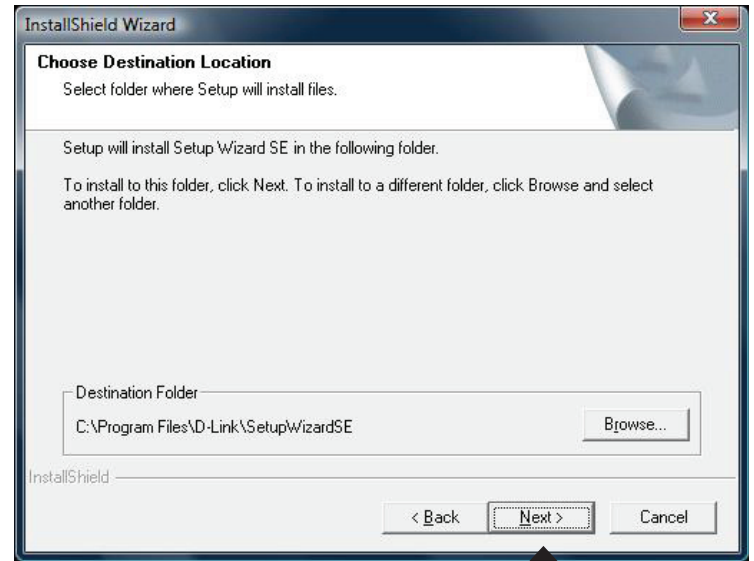

Click **Finish** to complete the installation.

Click **Finish**

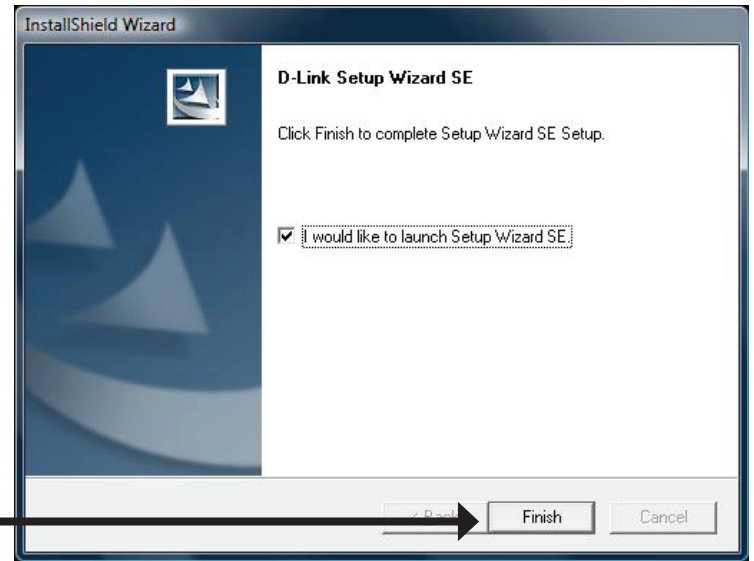

Now, click on **ffdshow** from the autorun screen. This will install the proper codecs that will allow you to playback video taken by the DCS-3411/3430.

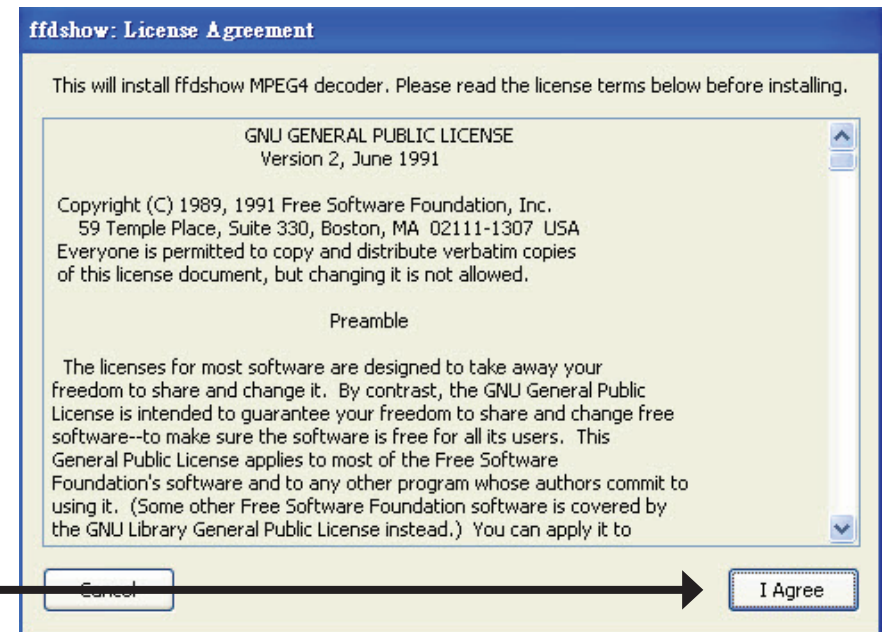

Select Language, and then click OK.

Click **OK**



Click **Next**

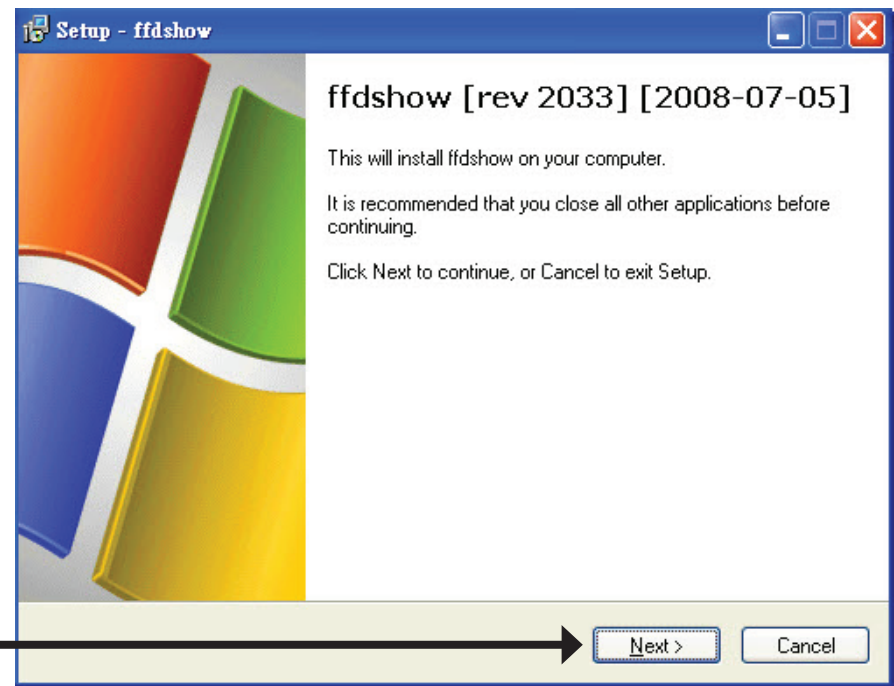

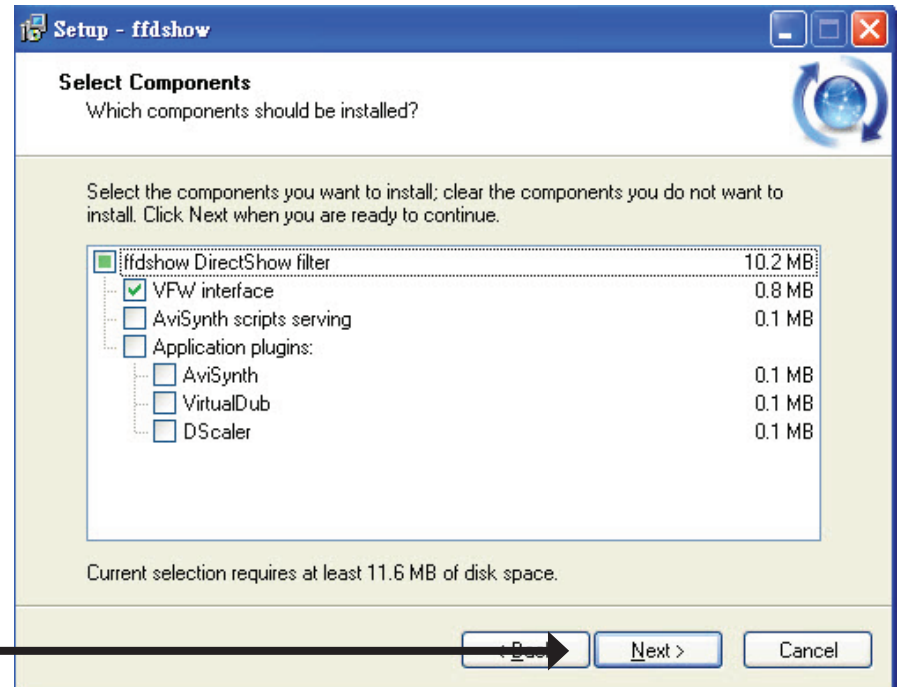
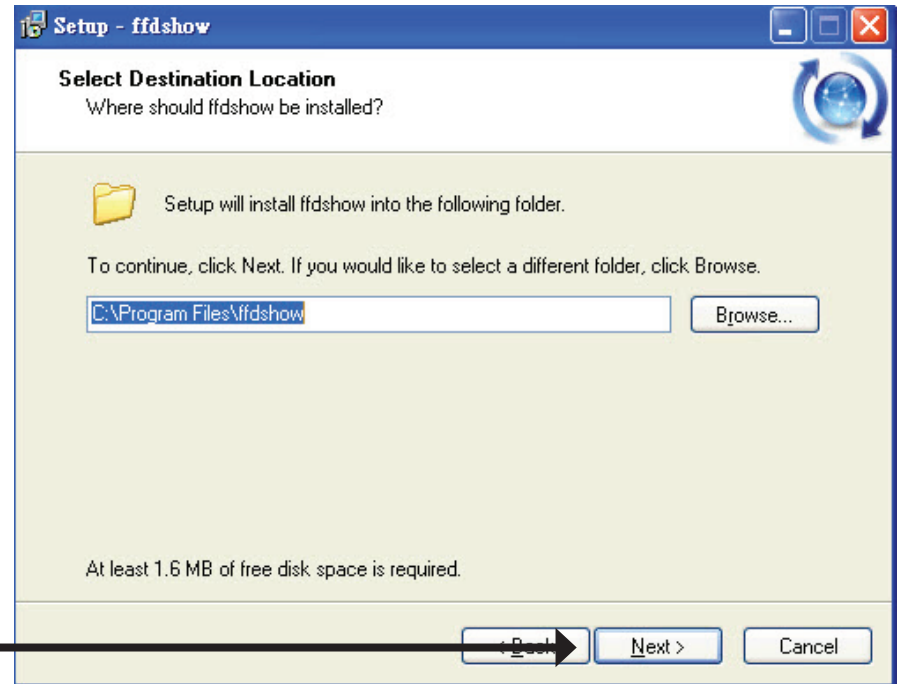



Click **Next**

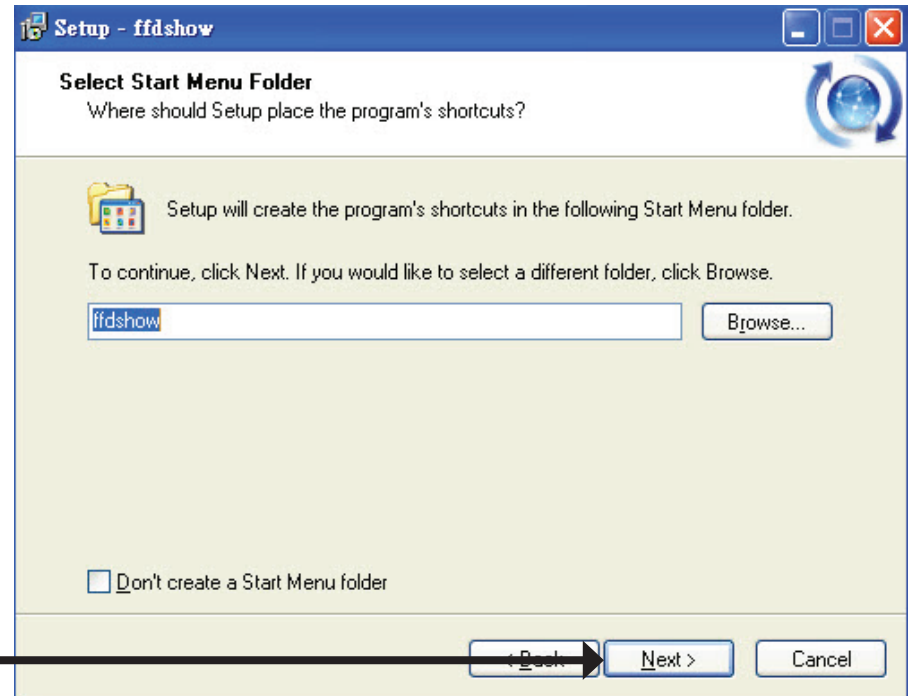

Click **Next**

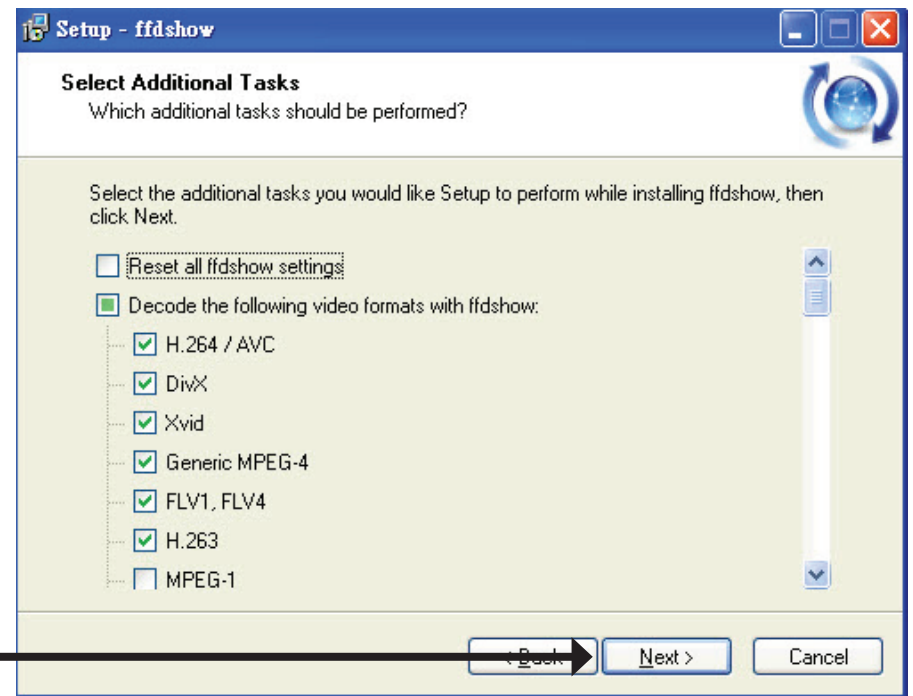

Click Next

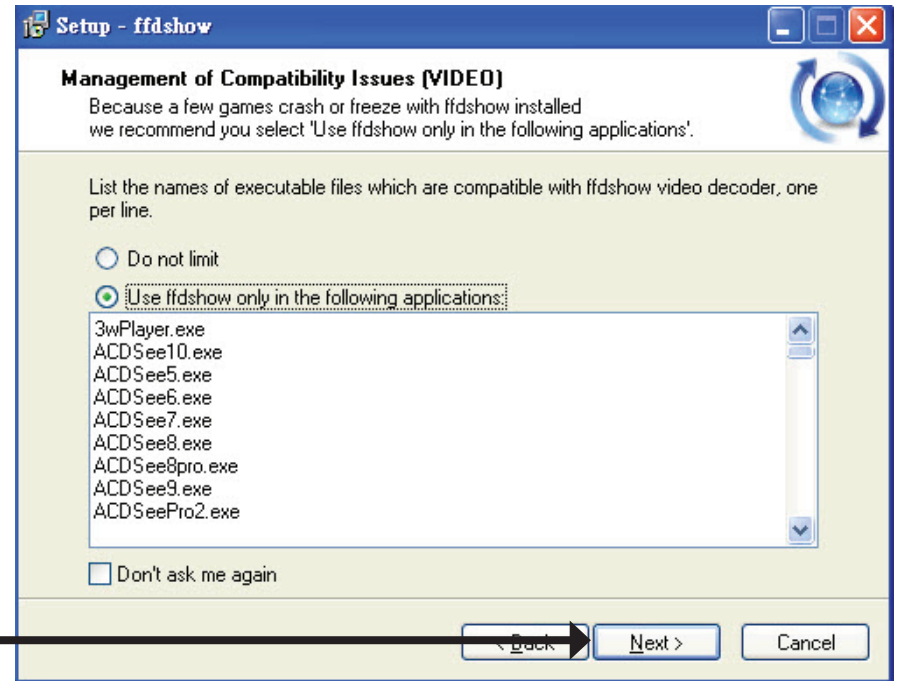

Click Next

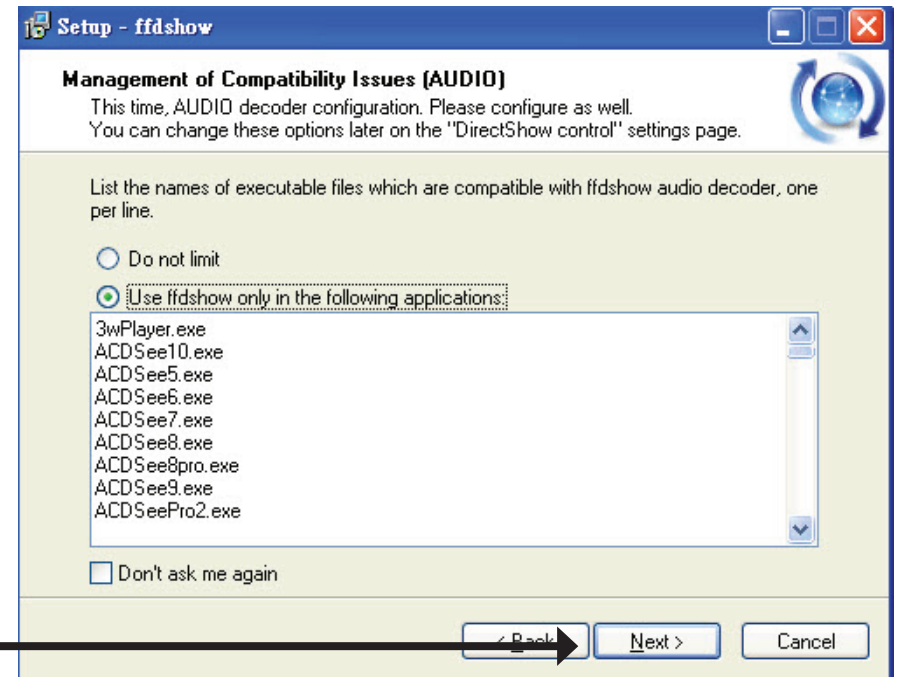

Select the speaker from your PC, and then click Next.

Click **Next**

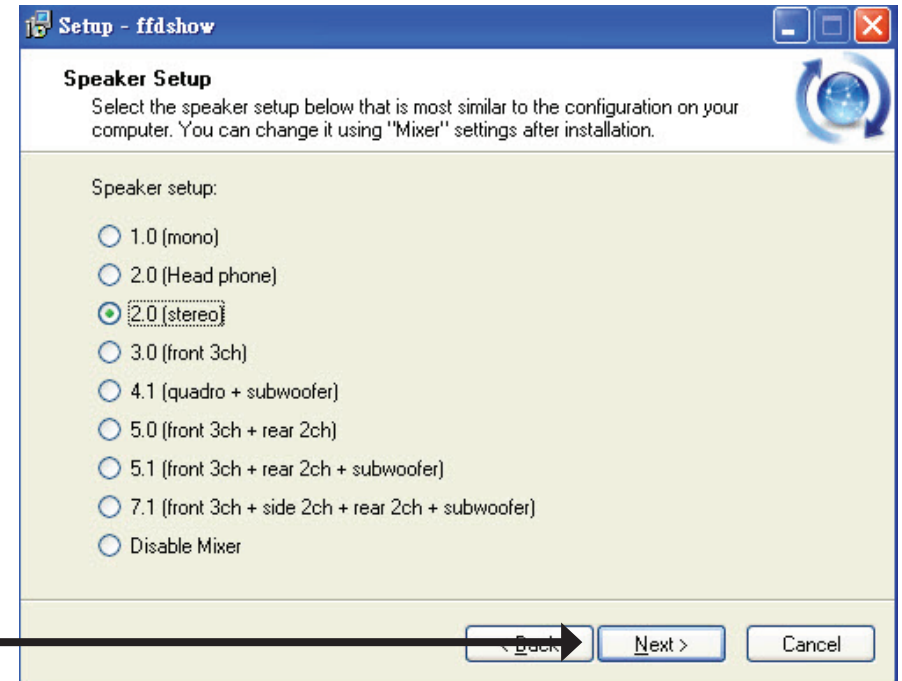

Click **Install**

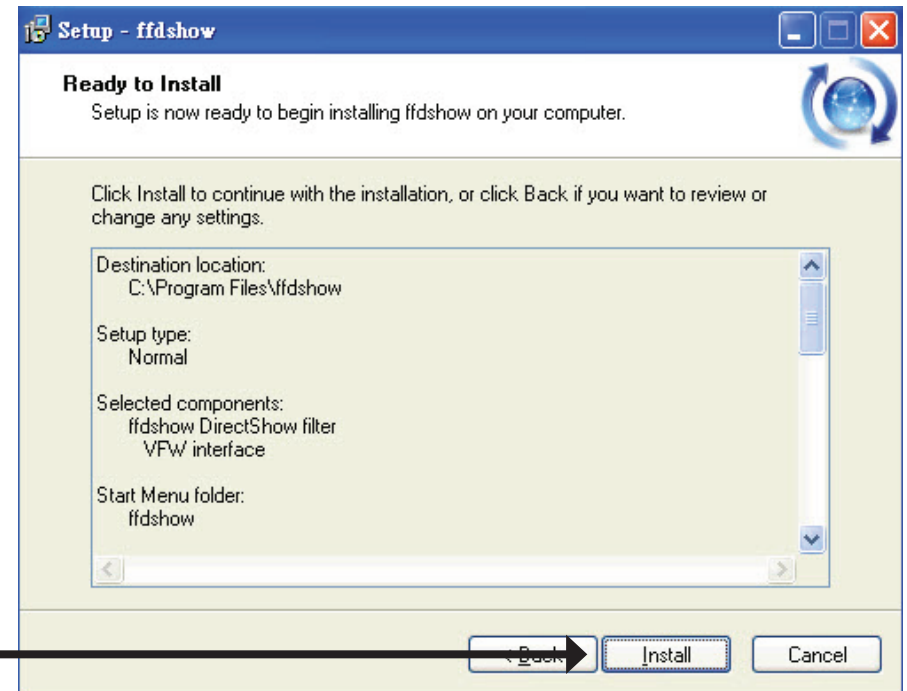

## Installing

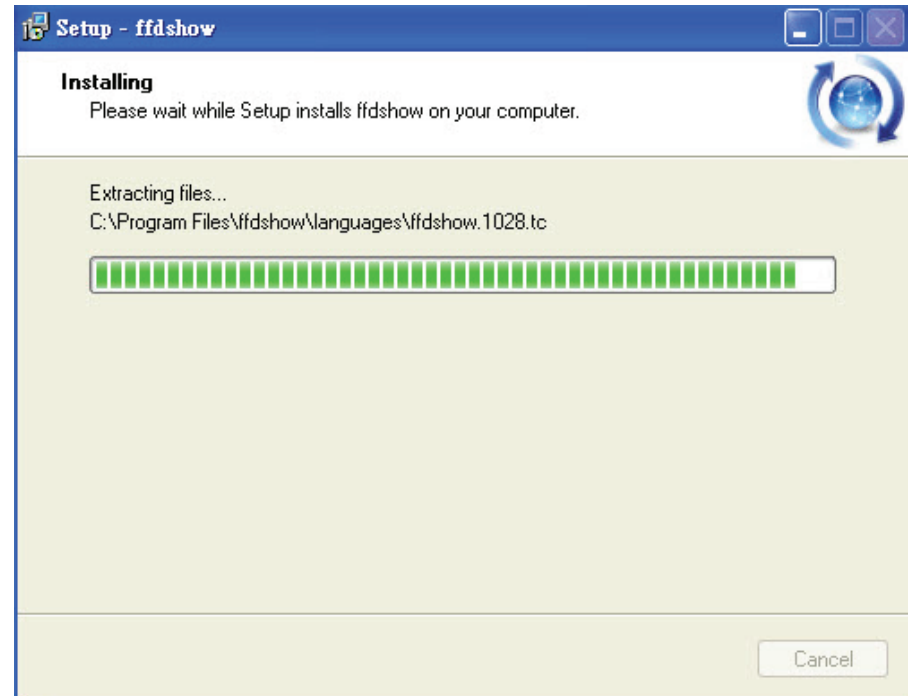

# Configuration

This section will show you how to configure your new D-Link Network Camera using the Setup Wizard.

## Setup Wizard Configuration

Click on the **D-Link Setup Wizard SE** icon that was created in your Windows Start menu.

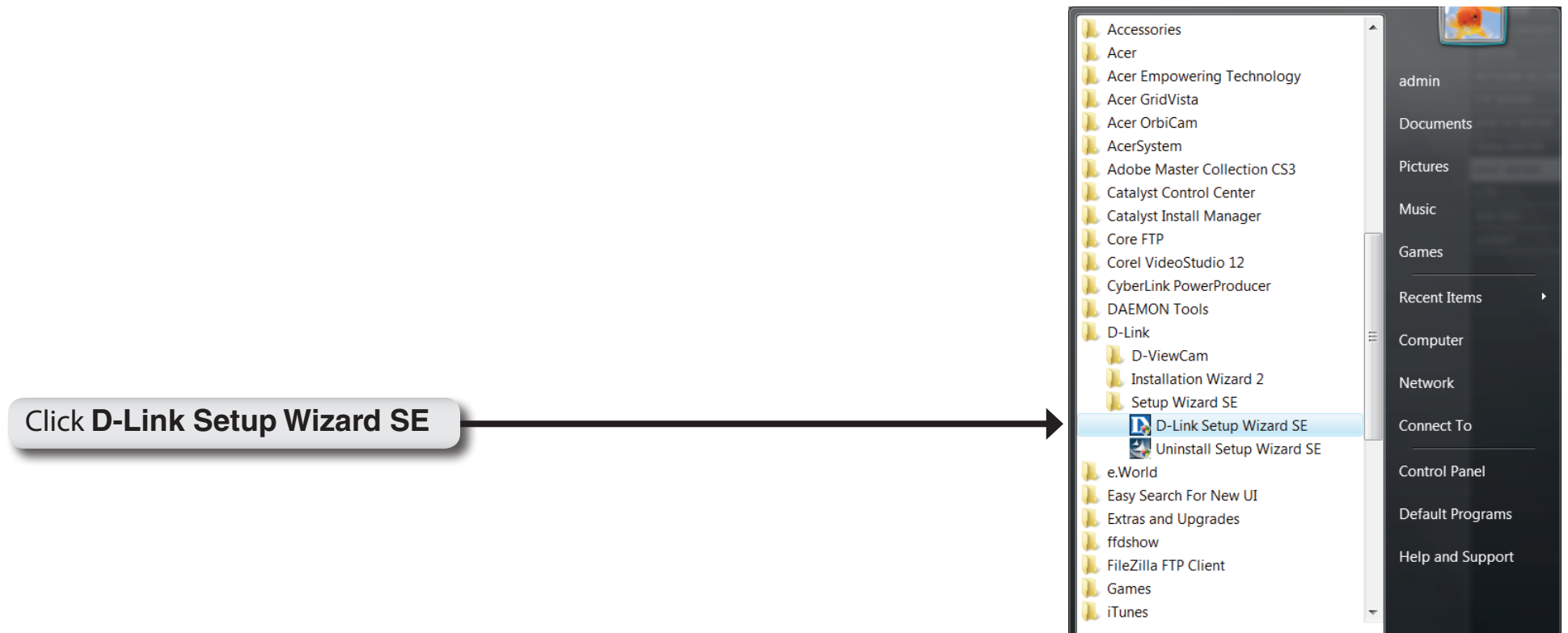

The Setup Wizard will appear and show the MAC address of the DCS-3411/3430 and an IP Address (which may or may not be correct depending on what you have your DCS-3411/3430 connected to). If you have a DHCP server on your network, there will be a valid IP Address displayed here. Click the **Wizard** button to continue.

Note: A DHCP server is a device that supplies the IP address.

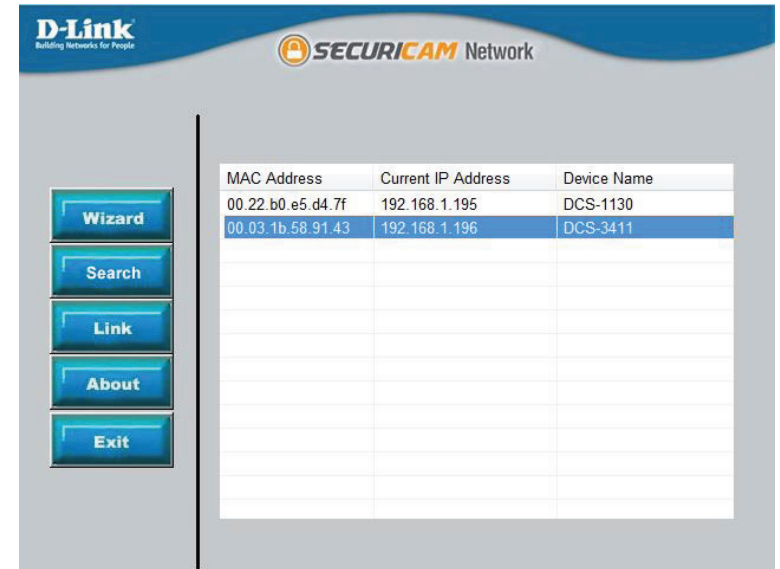

Enter the admin ID and password.

Note: The default Admin ID is **admin** with the password left blank.



Click **Next**

Select DHCP if you want to obtain a new IP address every time the camera boots up.



Click **Next**

Select static IP to use the same IP address at each boot up.



Click **Next**

Click **Restart** to save your settings and reboot the Network Camera.



Click **Restart**



Click the button labeled **Link** to access the web configuration page. The Setup Wizard will automatically open your web browser to the IP address of the DCS-3411/3430, in this example it is: http://192.198.0.185. Your DCS-3411/3430 may have a different IP Address.

Click **Link**

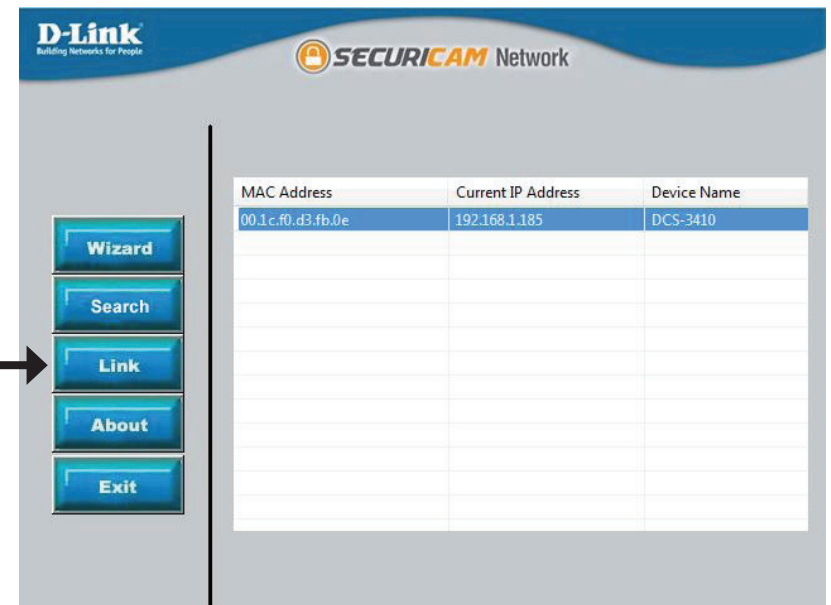



# Web-based Configuration Utility

This section will show you how to configure your new D-Link Network Camera using the Web-based Configuration Utility.

To access the configuration utility, open a web-browser such as Internet Explorer and enter the IP address for your Network Camera (<http://192.168.1.179>)

Note: For example, the address is 192.168.1.179. Your address may differ.

Enter **Admin** for the username and then leave the password blank by default.

Note: To change your password at a later time, please refer to page 50.

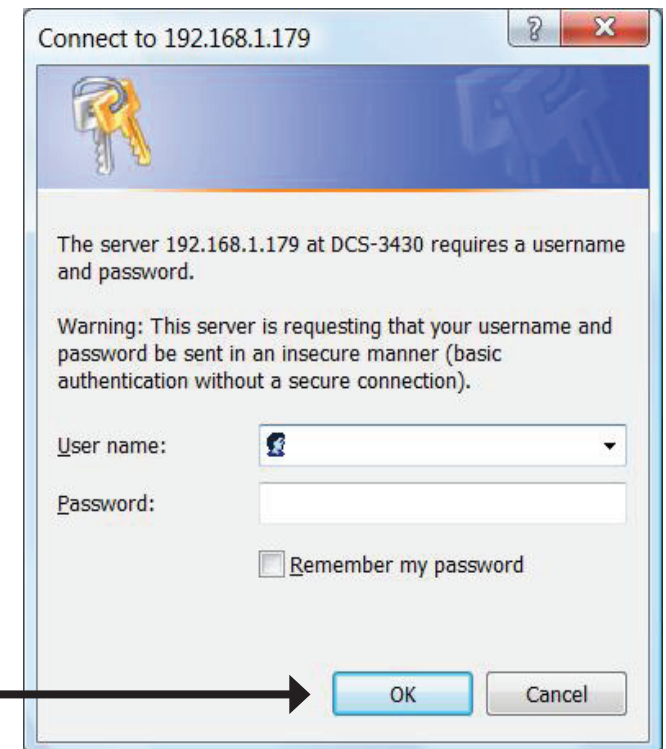

# Live Video Camera

This section shows your camera's live video. You may select the available thumbnails for your option of predefined **Video Profile**, **Full Screen** mode, and action items of taking **Snapshot**, **Recording**, **Set Storage Folder**, **Listen**, **Talk**, and **Digital Output**. You may also select your language setting using the drop-down menu.

You can zoom in and out of the live video image using your mouse. Right-click to zoom out and left-click to zoom in on the image.

 **Digital Input Indicator:** This indicator will light up when there is an available digital input signal.

 **Motion Trigger Indicator:** When a trigger event occurs, this will light up.

Note: The video motion feature for your camera must be enabled.

 **Recording Indicator:** When a recording is in progress, this indicator will light up.

 **Video Profile 1**

 **Video Profile 2**

 **Video Profile 3**

 **Video Profile 4**

 **Full screen mode**

 **Taking a Snapshot**

 **Recording a Video Clip**

 **Set a Storage Folder**

 **Listen/Stop Listening**

 **Talk/Stop Talking**

 **Start/Stop Digital Output**



The screenshot displays the D-Link camera web interface. At the top, it shows 'Product: DCS-3430' and 'Firmware Version: 1.0.0'. The D-Link logo is prominently displayed. Below the logo is a navigation menu with tabs for 'DCS-3430', 'LIVE VIDEO', 'SETUP', 'ADVANCED', 'MAINTENANCE', 'STATUS', and 'HELP'. The 'LIVE VIDEO' tab is selected. On the left side, there are icons for 'Camera', 'Logout', and a language selection dropdown set to 'English'. The main content area is titled 'CAMERA' and contains the text: 'This section shows your camera's live video. You can control your settings using the buttons below. Current resolution is 640 x 480'. Below this is a 'LIVE VIDEO' section showing a real-time video feed of an office cubicle with a date and time stamp '2009/04/13 16:28:51D PM'. At the bottom of the video feed, there is a row of control icons: Video Profile 1, Video Profile 2, Video Profile 3, Video Profile 4, Full screen mode, Taking a Snapshot, Recording a Video Clip, Set a Storage Folder, Listen/Stop Listening, Talk/Stop Talking, and Start/Stop Digital Output. The bottom of the interface features a 'SECURITY' banner.

# Setup Wizard

To quickly configure your Network Camera, click **Internet Connection Setup Wizard**, or click **Manual Internet Connection Setup** to manually configure your Network Camera.

To quickly configure your Network Camera's motion detection settings, click **Motion Detection Setup Wizard** and skip to page 31. If you want to enter your settings without running the wizard, click **Manual Motion Detection Setup** and skip to page 41.

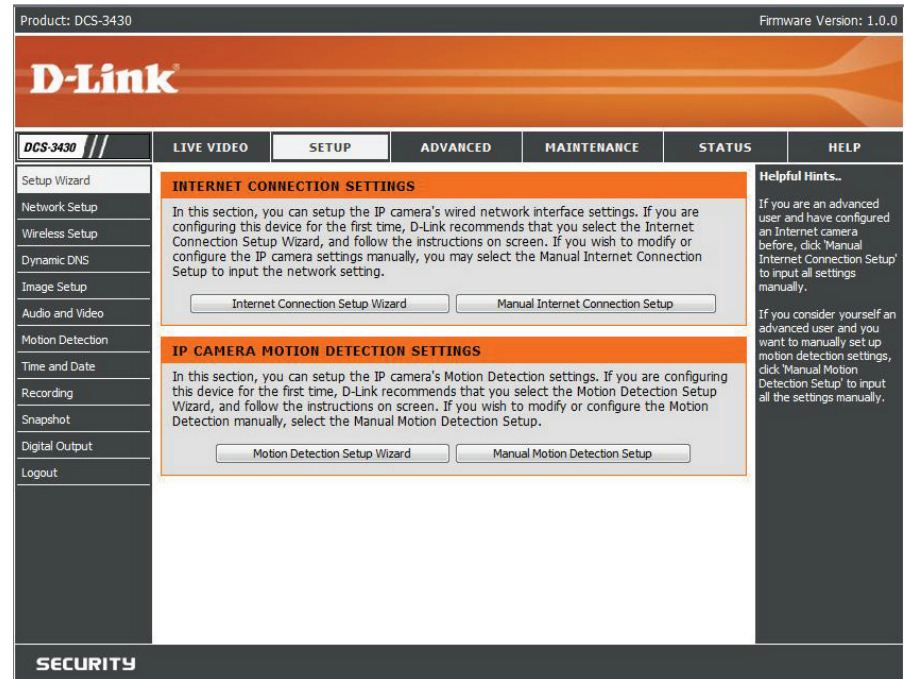

## Internet Connection Setup Wizard

This wizard will guide you through a step-by-step process to configure your new D-Link Camera and connect the camera to the internet. Click **Next** to continue.

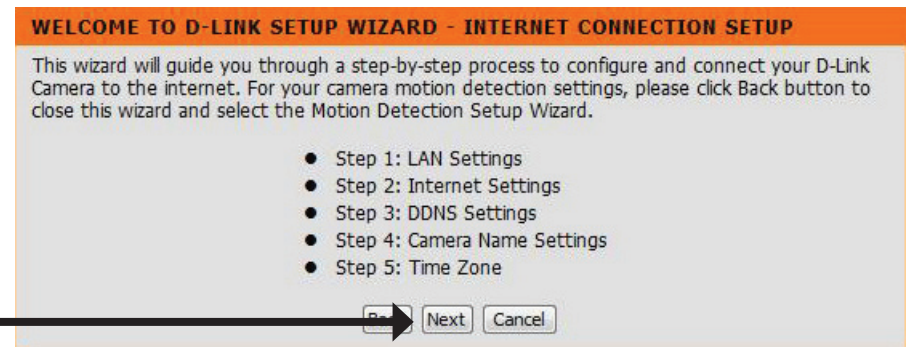

Click **Next**

Select **DHCP** if you are unsure which settings to pick. Click **Next** to continue and skip to page 29.

**STEP 1: LAN SETTINGS**

Please select whether your camera will connect to the Internet with a DHCP connection or Static IP address. If your camera is connected to a router, or you are unsure which settings to pick, D-Link recommends that you keep the default selection of DHCP connection. Otherwise, select Static IP address to manually assign an IP address before clicking on the Next button.

DHCP Connection  
 Static IP Address

IP Address   
Subnet Mask   
Default Gateway   
Primary DNS   
Secondary DNS

Click **Next**



Select **Static IP** if your Internet Service Provider has provided you with connection settings, or you wish to set a static address within your home network. Enter the accurate information for your static IP setting. Click **Next** to continue.

**STEP 1: LAN SETTINGS**

Please select whether your camera will connect to the Internet with a DHCP connection or Static IP address. If your camera is connected to a router, or you are unsure which settings to pick, D-Link recommends that you keep the default selection of DHCP connection. Otherwise, select Static IP address to manually assign an IP address before clicking on the Next button.

DHCP Connection  
 Static IP Address

IP Address   
Subnet Mask   
Default Gateway   
Primary DNS   
Secondary DNS

Click **Next**



If you are using PPPoE, select **Enable** and enter your user name and password, otherwise select **Disable** and click **Next** to continue.

**STEP 2: INTERNET SETTINGS**

If your ISP is using PPPoE, please enable this setting and enter your ISP Username and Password. Then, click on the Next button. Please contact your ISP if you do not know your Username and Password.

Enabled

Username   
(e.g. 123456@hinet.net)

Password

Click **Next**

If you have a Dynamic DNS account and would like the camera to update your IP address automatically, Select **Enable** and enter your host information. Click **Next** to continue.

**STEP 3: DDNS SETTINGS**

If you have a Dynamic DNS account and would like the camera to update the IP address automatically, please enable DDNS and enter your host information below. Then, click on the Next button to continue.

Enable

Server Address  <<

Host Name

User Name

Password

Verify Password

Timeout  (Hours)

Click **Next**

Enter a name for your camera and click **Next** to continue.

**STEP 4: CAMERA NAME SETTINGS**

D-Link recommends that you rename your camera for easy accessibility. You can then identify and connect to your camera via this name. Please assign a name of your choice before clicking on the Next button.

Camera Name

Click **Next**

Configure the correct time to ensure that all events will be triggered, captured and scheduled at the right time. Click **Next** to continue.

**STEP 5: SETUP TIME ZONE**

Please configure the correct time to ensure that all events are triggered, captured and scheduled at the correct time and day and then click on the Next button.

Time Zone

Enable Daylight Saving

Click **Next**

If you have selected **DHCP**, you will see a summary of your camera's settings. Please note down all this information as you will need it for accessing your camera within the network. Click **Apply** to save your settings.

**STEP 6: SETUP COMPLETE**

Below is a summary of your camera settings. Click on the Back button to review or modify settings or click on the Apply button if all settings are correct. It is recommended to note down these settings in order to access your camera on the network or via your web browser.

IP Address	DHCP
IP Camera Name	DCS-3430
Time Zone	(GMT-08:00) Pacific Time (US & Canada)
DDNS	Disable
PPPoE	Disable

Click **Apply**

If you have selected **Static IP**, you will see a summary of your camera's settings. Please note down all this information as you will need it for accessing your camera within the network. Click **Apply** to save your settings.

**STEP 6: SETUP COMPLETE**

Below is a summary of your camera settings. Click on the Back button to review or modify settings or click on the Apply button if all settings are correct. It is recommended to note down these settings in order to access your camera on the network or via your web browser.

IP Address	192.168.0.20
IP Camera Name	DCS-3430
Time Zone	(GMT-08:00) Pacific Time (US & Canada)
DDNS	Disable
PPPoE	Disable

Click **Apply**

## Motion Detection Setup Wizard

This wizard will guide you through a step-by-step process to configure your new D-Link Camera motion detection functions. Click **Next** to continue.

Click **Next**

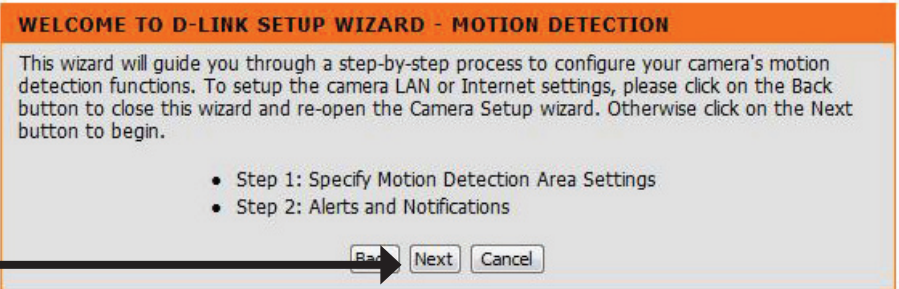

This section will allow you to enable or disable motion detection as well as control the sensitivity or your camera's ability to detect movement. You can select the **Drawing Mode** to draw or erase the motion area in your window of live video.

Click **Next**

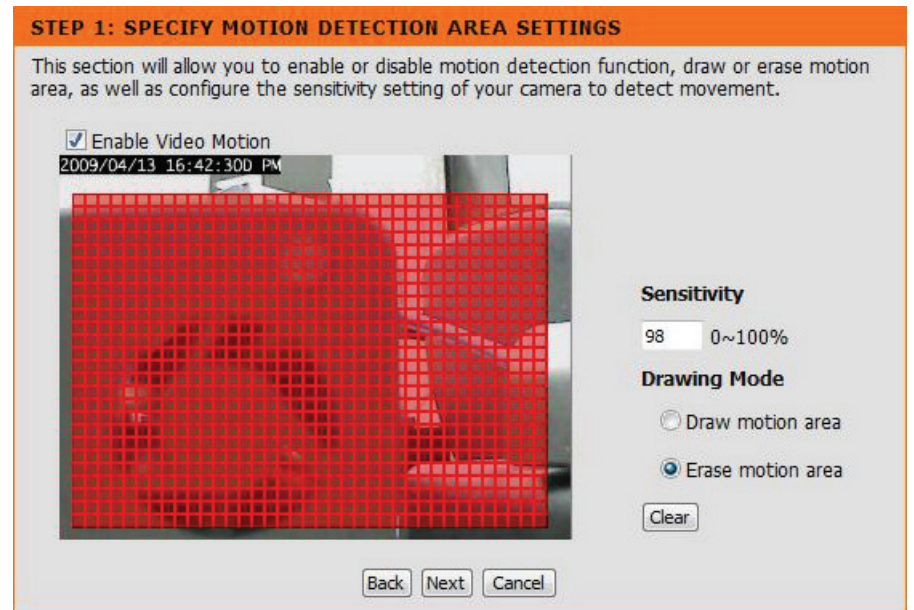

This step allows you to specify how you will receive the events notification of your camera, either via using email or FTP. You will need to enter all the relevant information for your email account or FTP settings. Then, click **Next** to continue.

**STEP 2: ALERTS AND NOTIFICATIONS**

This final step allows you to specify how you will receive alert and notification of camera events. You can enable an email notification and/or a FTP Notification by input all the relevant information. Then, click on the Next button.

Enable e-mail notification	<input type="checkbox"/>
User Name	<input type="text"/>
Password	<input type="text"/>
SMTP Mail Server	<input type="text"/>
Sender E-mail Address	<input type="text"/>
Recipient E-mail Address	<input type="text"/>
Port	<input type="text" value="25"/>
Enable FTP uploading	<input type="checkbox"/>
User Name	<input type="text"/>
Password	<input type="text"/>
Host Name	<input type="text"/>
Path	<input type="text"/>
Filename Prefix	<input type="text" value="cam"/>
Port	<input type="text" value="21"/>
Interval	<input type="text" value="1"/>
Passive Mode	<input checked="" type="checkbox"/>

Click **Next**





You have completed the Motion Detection Wizard. Click **Apply** to activate your settings.

**STEP 3: SETUP COMPLETE**

You have completed your camera setup. Please click the Back button if you want to review or modify your settings or click on the Apply button to save and apply your settings.

Motion Detection: Enable  
Alerts and Notification: Do not notify me

Click **Apply**



# Network Setup

Use this section to configure the network connections for your camera. All relevant information must be entered accurately.

**LAN Settings:** Settings for your local area network.

**DHCP:** Select this connection if you have a DHCP server running on your network and would like a dynamic IP address to be updated to your camera automatically.

**Static IP Address:** You may obtain a static or fixed IP address and other network information from your network administrator for your camera. A static IP address will ease you for accessing your camera in the future.

**IP Address:** The fixed IP address.

**Subnet Mask:** The default value is "255.255.255.0." Used to determine if the destination is in the same subnet.

**Default Gateway:** The gateway used to forward frames to destinations in a different subnet. Invalid gateway settings may cause the failure of transmissions to a different subnet.

**Primary DNS:** Primary domain name server that translates names to IP addresses.

**Secondary DNS:** Secondary domain name server to backup the primary one.

**Enable UPnP:** Enable this setting to allow your camera to be configured as an UPnP device in your network.

Product: DCS-3430 Firmware Version: 1.0.0

**D-Link**

DCS-3430 // LIVE VIDEO SETUP ADVANCED MAINTENANCE STATUS HELP

Setup Wizard  
 Network Setup  
 Wireless Setup  
 Dynamic DNS  
 Image Setup  
 Audio and Video  
 Motion Detection  
 Time and Date  
 Recording  
 Snapshot  
 Digital Output  
 Logout

**NETWORK SETUP**  
 You can configure your LAN and Internet settings here.  
 Save Settings Don't Save Settings

**LAN SETTINGS**

LAN

DHCP Connection  
 Static IP Address

IP Address   
 Subnet Mask   
 Default Gateway   
 Primary DNS   
 Secondary DNS

Enable UPnP  
 Enable UPnP port forwarding  
 External HTTP port   
 External RTSP port

Enable PPPoE  
 User Name   
 Password   
 Confirm password

**PORT DETAIL SETTINGS**

HTTP port   
 RTSP port

Save Settings Don't Save Settings

**SECURITY**

**Helpful Hints..**  
 Select 'DHCP Connection' if you are running a DHCP server on your network and would like an IP address assigned to your camera automatically.  
 - Enabling 'UPnP' settings will allow you to configure your camera as an UPnP device in the network.  
 - 'Port Detail Settings' allow you to specify the ports you reserve for both HTTP and RTSP Streaming.  
 - 'HTTP Port' is the port you allocate in order to connect to the camera via a standard web browser.  
 - 'RTSP Port' is the port you allocate in order to connect to a camera by using streaming mobile device(s), such as a mobile phone or PDA.

**Enable UPnP port forwarding:** Enable this setting to allow the camera to add port forwarding entries into the router automatically.

**Enable PPPoE:** Enable this setting if your network is using PPPoE service.

**User Name:** The unique name to your account. You may obtain this information from your ISP.

**Password:** The password to your account. You may obtain this information from your ISP.

**HTTP Port:** The default value is 80.

**RTSP port:** The port number that you use for RTSP streaming to mobile devices, such as mobile phones or PDAs. The default port number is 554.

# Wireless Setup

This sections allows you to setup and configure the wireless settings for your camera.

**Enable Wireless:** Select to enable wireless configuration.

**Site Survey:** Select the wireless connection you would like to use from the pull-down menu.

**SSID:** Enter the name of you wireless network.

**Wireless Mode:** Use the dropdown box to select the mode of the wireless network you wish to connect to. **Infrastructure** is normally used to connect to an access point or router. **Ad-Hoc** is usually used to connect directly to another computer.

**Channel:** If you are using Ad Hoc mode, select the channel of the wireless network you wish to connect to, or select **Auto**.

**Authentication:** Select the authentication you use on your wireless network - **Open**, **Shared (WEP)**, **WPA-PSK**, or **WPA-PSK2**.

**Encryption:** If you use **WPA-PSK** or **WPA-PSK2** authentication, you will need to specify whether your wireless network uses TKIP or AES encryption. If you use **Open** or **Shared** authentication, this setting will be automatically set for you.

**Key:** If you use **WEP**, **WPA-PSK**, or **WPA-PSK2** authentication, enter the **Key** (also known as password) used for your wireless network.

**Signal:** Indicates the strength of the wirelss signal between the camera and the access point.

The screenshot displays the D-Link DCS-3430 wireless setup web interface. The page title is 'Product: DCS-3430' and 'Firmware Version: 1.0.0'. The main navigation bar includes 'LIVE VIDEO', 'SETUP', 'ADVANCED', 'MAINTENANCE', 'STATUS', and 'HELP'. The 'SETUP' menu is selected, and the 'WIRELESS SETUP' section is active. The interface is divided into three main areas:

- WIRELESS SETUP:** A summary section with the text 'In this section, you can setup and configure the wireless settings for your camera.' and two buttons: 'Save Settings' and 'Don't Save Settings'.
- WIRELESS CONFIGURATION:** A form with the following fields:
  - Enable Wireless:** A checked checkbox.
  - Site Survey:** A dropdown menu set to 'dlink' with a 'Rescan' button.
  - SSID:** A text input field containing 'dlink'.
  - Wireless Mode:** A dropdown menu set to 'Infrastructure'.
  - Channel:** A dropdown menu set to 'Auto'.
  - Authentication:** A dropdown menu set to 'WPA2-PSK'.
  - Encryption:** A dropdown menu set to 'AES'.
  - Key:** A text input field with masked characters (dots).
  - Signal:** A text input field containing '100'.
- Helpful Hints..:** A sidebar section providing additional information:
  - SSID (Service Set Identifier):** Explains that it is the name of the wireless network (e.g., Default, Conference, My network, etc.) and can be entered manually via the Site Survey menu.
  - Authentication:**
    - Open:** Makes the camera visible to all devices on the network.
    - Shared:** Allows communication only with other devices that have the identical WEP (Wired Equivalent Privacy) settings.
    - WPA-PSK, WPA2-PSK:** Both modes require a pre-shared Key for the connection.

At the bottom of the configuration section, there are two buttons: 'Save Settings' and 'Don't Save Settings'. The 'SECURITY' section is partially visible at the bottom of the page.

# Dynamic DNS

DDNS (Dynamic Domain Name Server) will hold a DNS host name and synchronize the public IP address of the modem when it has been modified. The user name and password are required when using the DDNS service.

**Enable DDNS:** Click to enable the DDNS function.

**Server Address:** Select your Dynamic DNS provider from the pull down menu or enter the server address manually.

**Host Name:** Enter the host name of the DDNS server.

**User name:** Enter your user name or e-mail used to connect to the DDNS

**Password:** Enter your password used to connect to the DDNS server.

**Timeout:** This sets the number of hours between DDNS updates.

**Status:** Indicate the connection status, automatically determined by the system.

Product: DCS-3430 Firmware Version: 1.0.0

**D-Link**

DCS-3430 // LIVE VIDEO SETUP ADVANCED MAINTENANCE STATUS HELP

Setup Wizard  
Network Setup  
Wireless Setup  
Dynamic DNS  
Image Setup  
Audio and Video  
Motion Detection  
Time and Date  
Recording  
Snapshot  
Digital Output  
Logout

**DYNAMIC DNS**

The Dynamic DNS feature allows you to use a domain name that you have purchased (www.yourdomain.com) to access your camera with a dynamically assigned IP address. Most broadband Internet service providers assign dynamic (changing) IP addresses. By using a DDNS service, you can enter your domain name to connect to your camera no matter what your IP address is.

[Sign up for D-Link's Free DDNS service at www.DLinkDDNS.com.](http://www.DLinkDDNS.com)

Save Settings Don't Save Settings

**DYNAMIC DNS SETTING**

Enable DDNS

Server Address  << Select Dynamic DNS Server >>

Host Name

User Name

Password

Verify Password

Timeout  (hours)

Status:Disable

Save Settings Don't Save Settings

**Helpful Hints..**

Dynamic DNS is useful if you have a DSL or Cable service provider that changes your modem IP address periodically. This will allow you to assign a website domain name to your camera instead of connecting through an IP address.

**SECURITY**

# Image Setup

In this section, you may configure the video image settings for your camera. Preview of the image will be shown in the window of Live Video. Click **Save Settings** to activate and save your changes.

**Brightness:** An adjustable setting to compensate for backlit scenes.

**Contrast:** Adjust to control the contrast of colors between the object. This feature will help improve images under a dull grey sky.

**Flip:** Select this feature when your camera is installed upside down on the ceiling

**B/W:** Select to enable or disable black and white mode for you camera.

**Saturation:** This setting controls the strength of color from black and white to bold colors.

**Sharpness:** Adjust the sharpness of images. Sharper images will be displayed when the number is higher. If the number is lower, a blurrier image will be displayed.

**Mirror:** Select this feature to obtain a mirror image.

**Frequency:** You may chose 50Hz or 60Hz frequency. It may depend on the country where you reside.

Product: DCS-3430 Firmware Version: 1.0.0

**D-Link**

DCS-3430 // LIVE VIDEO SETUP ADVANCED MAINTENANCE STATUS HELP

Setup Wizard  
Network Setup  
Wireless Setup  
Dynamic DNS  
Image Setup  
Audio and Video  
Motion Detection  
Time and Date  
Recording  
Snapshot  
Digital Output  
Logout

**IMAGE SETUP**

Your changes made for the image settings will be reflected immediately. The results can be seen and found in the Live Video window below.

**LIVE VIDEO**

2009/04/13 17:31:260 PM

**IMAGE SETTINGS**

Brightness	50	Saturation	100
Contrast	50	Sharpness	40
Flip	<input type="checkbox"/>	Mirror	<input type="checkbox"/>
B/W	<input type="checkbox"/>	Frequency	60Hz

Reset to Default

**SECURITY**

Brightness, Saturation, Contrast and frequency can be adjusted allowing you to fine-tune your image settings.

**Brightness** - It is used to compensate for backlit scenes.

**Saturation** - It controls the strength of color from black and white to bold colors.

**Contrast** - Adjustable to control the contrast of colors between the object. It help to improve the image under a dull grey sky.

**Frequency** - You may need to choose '50' or '60' Hz frequency (depends on country).

**B/W** - Select to enable or disable black-and-white mode for your camera.

**Flip** - Select this feature when your camera is installed up-side down on the ceiling.

**Mirror** - Select this feature to obtain mirror image.

# Audio and Video

You may configure 4 video profiles with different settings for your camera. Additionally, you may also configure your audio (speakers and microphone) setup for your camera. Profile 3 is set as the profile for snapshot, while profile 4 is set for your mobile phone or PDA device.

**Resolution:** This option allows the user to choose the video resolution of the camera between 160x120, 320x240 and 704x480:

- QQVGA @ 160x112 - Usually used for only displays of handheld devices.
- QVGA @ 320x240 - Standard solution for mobile phones and PDAs.
- VGA @ 640x480 - Standard solution for computer display.

**FPS:** (Frames Per Second): Highest FPS represents highest refresh rate of a picture is updated on screen every second, and provides better quality of video.

**Jpeg Quality:** Select the image quality level you wish to use for the JPEG images captured.

**BPS:** (Bits Per Second): BPS will affect the bit rate of the video recorded by the camera. Higher bit rate will increase the video quality.

**RTSP URL:** Is the URL name used to connect to the camera when viewing from a mobile device or PDA.

**Analog Output:** Select the display system of Analog Video Output on the back **NTSC** or **PAL**.

Product: DCS-3430 Firmware Version: 1.0.0

**D-Link**

DCS-3430 // LIVE VIDEO SETUP ADVANCED MAINTENANCE STATUS HELP

Setup Wizard  
Network Setup  
Wireless Setup  
Dynamic DNS  
Image Setup  
Audio and Video  
Motion Detection  
Time and Date  
Recording  
Snapshot  
Digital Output  
Logout

**AUDIO AND VIDEO**  
You may configure audio, and video settings (4 video profiles) here. Profile 3 has been set as the for snapshot while profile 4 is set for your mobile phone or PDA device.  
Save Settings Don't Save Settings

**VIDEO PROFILE 1**

Encode Type	Resolution	FPS	bps	JPEG Quality	RTSP URL
H264	640x480	30	2 Mbps	--	play1.sdp

**VIDEO PROFILE 2**

Encode Type	Resolution	FPS	bps	JPEG Quality	RTSP URL
MPEG4	320x240	30	1 Mbps	Excellent	play2.sdp

**VIDEO PROFILE 3**

Encode Type	Resolution	FPS	bps	JPEG Quality	RTSP URL
JPEG	640x480	10	--	Excellent	play3.sdp

**VIDEO PROFILE 4 FOR MOBILE DEVICE ONLY**

Encode Type	Resolution	FPS	bps	JPEG Quality	RTSP URL
MPEG4	160x112	5	2 Mbps	--	3gpp

**ANALOG OUTPUT**  
 NTSC  
 PAL

**AUTO EXPOSURE**  
 On  
 Off (used for auto IRIS lens)

**AUDIO SETUP**

Enable Speaker	<input checked="" type="checkbox"/>
Volume	100
Enable Microphone	<input checked="" type="checkbox"/>
Volume	100

Save Settings Don't Save Settings

**Helpful Hints..**  
**Encode Type** - Select the video codec 'JPEG' or 'MPEG4'.  
**Resolution** - 3 options depend on display system used.  
**FPS (Frame per second)** - 30fps is the highest video quality for this camera.  
**bps (bit per second)** - Select a fixed bandwidth for your camera operation. Higher value means a higher quality image but consumes more network bandwidth.  
**JPEG Quality** - Set the quality of JPEG image.  
**RTSP URL** - The URL used to connect to the camera when viewing from a mobile device or PDA. (i.e. rtsp://EXAMPLE.dlinkdns.com/3gpp).  
**Analog Output** - Select the display system of Analog Video Output on the back as NTSC or PAL.  
**Auto Exposure** - Select On to use auto exposure, Off to use auto IRIS.  
**Audio Setup** - To switch the external speaker and microphone on/off or adjust the volume.  
**Enable Speaker** - Enabling this feature to allow you to talk using PC's microphone and your voice to be transmitted to the external speaker connected to the camera.  
**Speaker Volume** - You can adjust the speaker volume using the volume level setting.  
**Enable Microphone** - Enabling this feature to hear audio from the IP Camera's microphone.  
**Microphone Volume** - You can adjust the MIC Port volume using the volume level setting.  
 We suggest using a resolution of 160x112 at 5 FPS and 64K BPS to watch images on your cell phone or pda.

**SECURITY**

**Auto Exposure:** Select **On** to use auto exposure or **Off** to use auto IRIS.

**Audio Setup:** You may switch the external speaker and microphone on/off or adjust the volume.

**Enable Speaker:** Enabling this feature allows you to talk using a PC microphone. Your voice will be transmitted to the external speaker connected to the camera.

**Speaker Volume:** You can adjust the speaker volume by using the volume level setting.

**Enable Microphone:** Enable this feature to hear audio from the IP Camera's microphone.

**Microphone Volume:** You can adjust the MIC Port volume by using the volume level setting.



# Motion Detection

Enabling **Video Motion** will allow your camera to use the motion detection feature. You may also draw out the motion area for the monitoring.

**Enable Video Motion:** Check this option to turn on the motion detection feature for your camera.

**Sensitivity:** Set the measurable difference between two sequential images that would indicate motion.

**Draw motion area:** Select this option to draw out the motion detection area by dragging your mouse in the window (indicated by the red-colored box).

**Erase motion area:** Select this option to erase your motion detection area by dragging your mouse in the window.

Product: DCS-3430 Firmware Version: 1.0.0

**D-Link**

DCS-3430 // LIVE VIDEO SETUP ADVANCED MAINTENANCE STATUS HELP

**MOTION DETECTION**

This section will allow you to enable or disable motion detection function, draw or erase motion area, as well as configure the sensitivity setting of your camera to detect movement. You must select the checkbox of 'Enable Video Motion' to turn on the feature.

Save Settings Don't Save Settings

**LIVE VIDEO**

Enable Video Motion  
2009/04/13 17:51:19.00

Sensitivity: 98 0~100%

**Drawing Mode**

Draw motion area  
 Erase motion area

Clear

Save Settings Don't Save Settings

**Helpful Hints..**

**Sensitivity** - Set the sensitivity for motion detection.  
High sensitivity makes the motions easier to be detected.

**Draw motion area** - Drag your mouse to add motion detection range.

**Erase motion area** - Drag your mouse to erase motion detection range.

**SECURITY**

# Time and Date

From this section, you may automatically or manually configure, update and maintain the internal system clock for your camera.

**Time Zone:** Select your time zone from the drop-down menu.

**Enable Daylight Saving:** Select this to enable the daylight saving time.

**Auto Daylight Saving:** Select this option so that your camera will configure the Daylight Saving setting automatically.

**Set date and time manually:** Select this option so that you may configure the Daylight Saving date and time manually.

**Offset:** Sets the amount of time to be added or removed when Daylight Saving is enabled.

**Synchronize with NTP server:** Enable this feature to obtain time configuration automatically from NTP server.

**NTP Server:** Network Time Protocol (NTP) synchronizes the DCS-3411/3430 with an Internet time server. Choose the one that is closest to your location.

**Set the date and time manually:** This option allows you to set the time and date manually.

**Copy Your Computer's Time Settings:** This will synchronize the time information from your PC.

Product: DCS-3430 Firmware Version: 1.0.0

**D-Link**

DCS-3430 // LIVE VIDEO SETUP ADVANCED MAINTENANCE STATUS HELP

**TIME AND DATE**

Here you may configure the internal clock of your camera.

Save Settings Don't Save Settings

**TIME CONFIGURATION**

Time Zone: (GMT-08:00) Pacific Time (US & Canada)

Enable Daylight Saving

Auto Daylight Saving

Set date and time manually

Offset: +1:00

Start time	Month	Week	Day of week	Hour	Minutes
	3	2	Sunday	2	00
End time	11	1	Sunday	2	00

**AUTOMATIC TIME CONFIGURATION**

Synchronize with NTP Server

NTP Server: ntp1.dlink.com << Select NTP Server

**SET DATE AND TIME MANUALLY**

Set date and time manually

Year	Month	Day	Hour	Minute	Second
2009	4	13	17	52	54

Copy Your Computer's Time Settings

Save Settings Don't Save Settings

**SECURITY**

**Helpful Hints..**  
Setting the correct time and time zone will allow you to have accurate logs and proper scheduling for recordings.

# Recording

In this section, you can configure and schedule the recording setting for your IP camera.

**Enable Recording:** Select this option to enable the recording feature.

**SD Card:** Selecting this will allow you to record to a SD Card inserted into the SD slot on the right side of the unit. When recording to the SD card, you can only use Event Based recording.

**Samba Auth:** To access your account on the Samba network drive, enter your account or anonymous username and password.

**Server:** The name of your Samba server.

**Shared Folder:** The name of the shared folder used for recording.

**Test:** Click this thumbnail to verify the connection status of your camera to the Samba network drive.

**Samba Status:** Displays the connection status that is determined by the system. You can click **Get Status** to refresh the status.

**Resolution:** Select your pre-defined profile from the drop-down menu.

**When Storage is full:** When the recording storage area is full, you may choose to stop recording, or recycle the recording files so that your camera can record the video continuously.

**Event Based:** Records when Motion Recording, Digital Input 1, or Digital Input 2 is triggered.

**Prerecord:** A preset amount of time before motion recording is triggered.

**Postrecord:** A preset amount of time after motion recording is triggered.

**Continuous:** Select to continuously record.

**Scheduled:** Select this option to manually schedule and configure the starting and ending time for the recording.

Product: DCS-3430 Firmware Version: 1.0.0

**D-Link**

DCS-3430 // LIVE VIDEO SETUP ADVANCED MAINTENANCE STATUS HELP

Setup Wizard  
Network Setup  
Wireless Setup  
Dynamic DNS  
Image Setup  
Audio and Video  
Motion Detection  
Time and Date  
Recording  
Snapshot  
Digital Output  
Logout

**RECORDING**

Here you may configure and schedule the recording of you camera. You must select the checkbox of "Enable Recording" to turn on the feature.

Save Settings Don't Save Settings

**RECORDING**

Enable recording

Record to:

SD Card  
SD Card status : Disable [Get status](#)

Samba network drive

Samba Auth

User name

Password

Password confirm

Server

Shared folder

[Test](#)

Samba status : Disable [Get status](#)

Recording Options

Resolution

Record until  MB of free space is left (minimum is 32MB)

When storage is full:

Stop recording

Overwrite older recordings

Recording Method

Event Based

Motion detection triggered recording

Digital input 1 triggered recording

Digital input 2 triggered recording

Prerecord  seconds (range 0 to 15 seconds)

Postrecord  seconds (range 0 to 15 seconds)

Continuous (Samba only)

Scheduled (Samba only)

		Start	Hours	Minutes	End	Hours	Minutes
<input checked="" type="checkbox"/>	Sun	Start	<input type="text" value="0"/>	: <input type="text" value="0"/>	End	<input type="text" value="24"/>	: <input type="text" value="0"/>
<input checked="" type="checkbox"/>	Mon	Start	<input type="text" value="0"/>	: <input type="text" value="0"/>	End	<input type="text" value="24"/>	: <input type="text" value="0"/>
<input checked="" type="checkbox"/>	Tue	Start	<input type="text" value="0"/>	: <input type="text" value="0"/>	End	<input type="text" value="24"/>	: <input type="text" value="0"/>
<input checked="" type="checkbox"/>	Wed	Start	<input type="text" value="0"/>	: <input type="text" value="0"/>	End	<input type="text" value="24"/>	: <input type="text" value="0"/>
<input checked="" type="checkbox"/>	Thu	Start	<input type="text" value="0"/>	: <input type="text" value="0"/>	End	<input type="text" value="24"/>	: <input type="text" value="0"/>
<input checked="" type="checkbox"/>	Fri	Start	<input type="text" value="0"/>	: <input type="text" value="0"/>	End	<input type="text" value="24"/>	: <input type="text" value="0"/>
<input checked="" type="checkbox"/>	Sat	Start	<input type="text" value="0"/>	: <input type="text" value="0"/>	End	<input type="text" value="24"/>	: <input type="text" value="0"/>

Save Settings Don't Save Settings

**SECURITY**

**Helpful Hints...**  
You can record the video to a 'SD Card' or a 'Samba network' drive based on the selected events. You may also configure the 'Recording Options' and select a scheduling method to specify when the camera will record video.

## How to save video to a shared folder?

1. Set the folder in your computer to shared. You can set as anonymous authentication or set a user name and password.

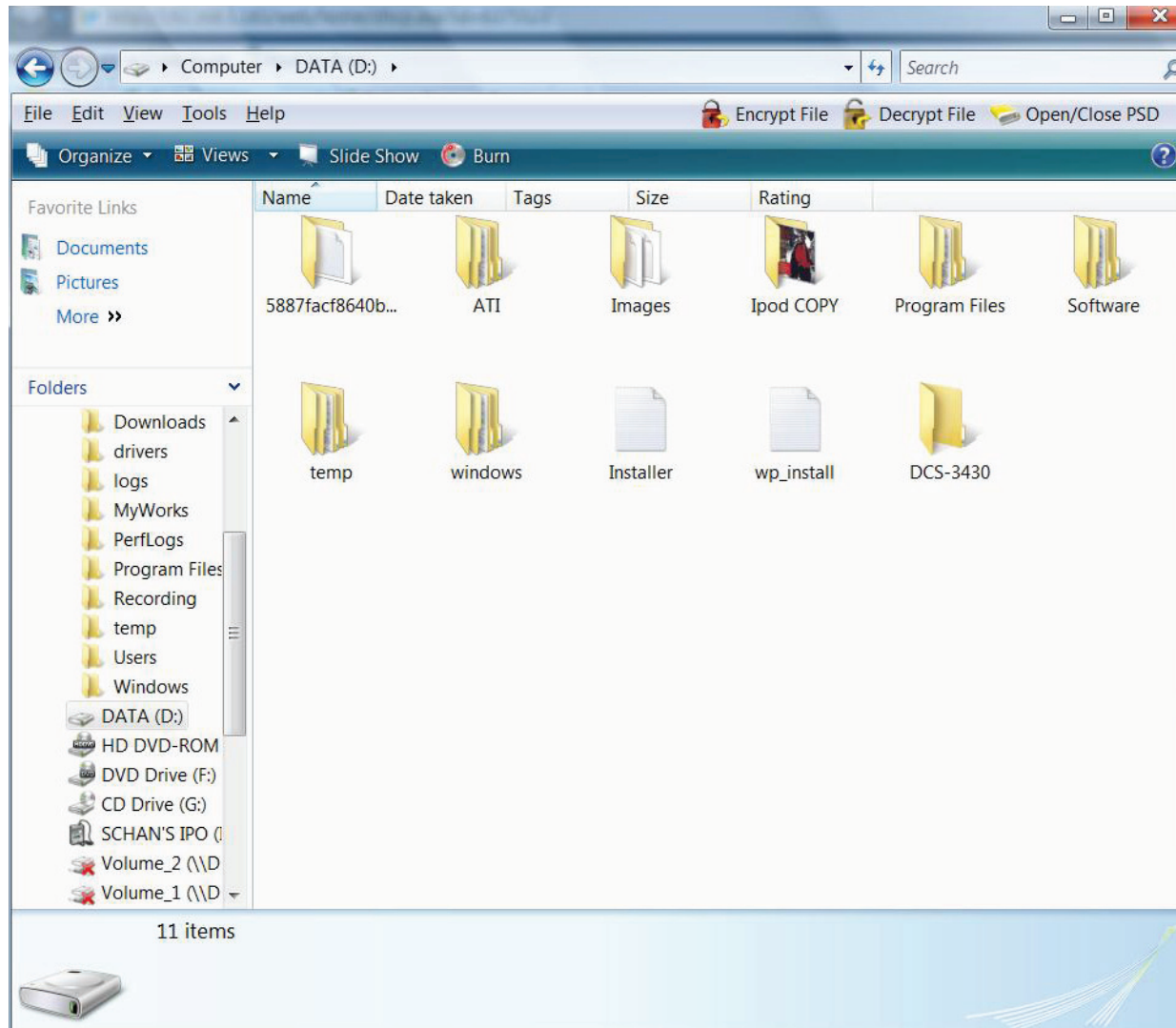

2. Click **Enable Recording**.
3. Set the Samba Authentication to **Anonymous** or **Account**. Enter the IP address of the computer or network attached storage with the shared folder and the name of the shared folder in step 1 to record to. If you selected **Account**, enter the user name and password from step 1.
4. Set the recording and schedule options.
5. Click **Save Settings**. The status will be set to **Normal** when connected properly.

Product: DCS-3430 Firmware Version: 1.0.

**D-Link**

DCS-3430 // LIVE VIDEO SETUP ADVANCED MAINTENANCE STATUS HELP

Setup Wizard  
Network Setup  
Wireless Setup  
Dynamic DNS  
Image Setup  
Audio and Video  
Motion Detection  
Time and Date  
**Recording**  
Snapshot  
Digital Output  
Logout

**RECORDING**

Here you may configure and schedule the recording of you camera. You must select the checkbox of 'Enable Recording' to turn on the feature.

Save Settings Don't Save Settings

**RECORDING**

Enable recording

Record to:

SD Card  
SD Card status : Disable

Samba network drive  
Samba Auth   
User name   
Password   
Password confirm   
Server   
Shared folder   
  
Samba status : Disable

Recording Options  
Resolution   
Record until  MB of free space is left (minimum is 32MB)  
When storage is full:  
 Stop recording  
 Overwrite older recordings

Recording Method  
 Event Based  
 Motion detection triggered recording  
 Digital input 1 triggered recording  
 Digital input 2 triggered recording  
Prerecord  seconds (range 0 to 15 seconds)  
Postrecord  seconds (range 0 to 15 seconds)  
 Continuous (Samba only)  
 Scheduled (Samba only)

	Start	Hours	Minutes	End	Hours	Minutes
<input checked="" type="checkbox"/> Sun	Start	<input type="text" value="0"/>	: <input type="text" value="0"/>	End	<input type="text" value="24"/>	: <input type="text" value="0"/>
<input checked="" type="checkbox"/> Mon	Start	<input type="text" value="0"/>	: <input type="text" value="0"/>	End	<input type="text" value="24"/>	: <input type="text" value="0"/>
<input checked="" type="checkbox"/> Tue	Start	<input type="text" value="0"/>	: <input type="text" value="0"/>	End	<input type="text" value="24"/>	: <input type="text" value="0"/>
<input checked="" type="checkbox"/> Wed	Start	<input type="text" value="0"/>	: <input type="text" value="0"/>	End	<input type="text" value="24"/>	: <input type="text" value="0"/>
<input checked="" type="checkbox"/> Thu	Start	<input type="text" value="0"/>	: <input type="text" value="0"/>	End	<input type="text" value="24"/>	: <input type="text" value="0"/>
<input checked="" type="checkbox"/> Fri	Start	<input type="text" value="0"/>	: <input type="text" value="0"/>	End	<input type="text" value="24"/>	: <input type="text" value="0"/>
<input checked="" type="checkbox"/> Sat	Start	<input type="text" value="0"/>	: <input type="text" value="0"/>	End	<input type="text" value="24"/>	: <input type="text" value="0"/>

Save Settings Don't Save Settings

**SECURITY**

**Helpful Hints..**  
You can record the video to a 'SD Card' or a 'Samba network' drive based on the selected events. You may also configure the 'Recording Options' and select a scheduling method to specify when the camera will record video.

# Snapshot

Enable the **Snapshot** feature so that your camera can take snapshots and send it to your email address or FTP server.

**Enable Snapshot:** Enable or disable snapshot event.

**Event Based:** Select one or more of the events such as **Motion Detection**, **D/I Signal 1** and **D/I Signal 2** for the source that triggers the action.

**Continuous:** Select to continuously record.

**Scheduled:** Select this option to manually schedule and configure the starting and ending time for the recording.

**Send to E-mail Address:** Select this option if you want to receive snapshot images in your e-mail.

**FTP Server:** Select this option if you want to receive your snapshot images via FTP.

**Host name:** The host name of your FTP server.

**Path:** The directory or path where the images will be uploaded to (for example: \pub\images).

**Filename Prefix:** The prefix that will be added to the filename of each file.

**Port:** The port of the FTP server. The default port is 25.

**Passive mode:** Some FTP servers allow clients to use passive mode when connecting to an FTP, which uses random ports for transfers.

Product: DCS-3430 Firmware Version: 1.0.0

**D-Link**

DCS-3430 // LIVE VIDEO SETUP ADVANCED MAINTENANCE STATUS HELP

Setup Wizard  
Network Setup  
Wireless Setup  
Dynamic DNS  
Image Setup  
Audio and Video  
Motion Detection  
Time and Date  
Recording  
Snapshot  
Digital Output  
Logout

**SNAPSHOT**

In order to enable your camera to take snapshots, you must select the checkbox of 'Enable Snapshot'. Then, you can determine the trigger event(s) and FTP and/or email notification(s). The resolution of snapshot can be configured as in the video profile 3 in [Audio and Video](#).

Save Settings Don't Save Settings

**SNAPSHOT**

Enable Snapshot

Scheduling

Event Based

Motion Detection

D/I Signal 1

D/I Signal 2

Continuous (FTP only)

Scheduled (FTP only)

		Start	Hours	Minutes	End	Hours	Minutes
<input checked="" type="checkbox"/>	Sun	Start	00	: 00	End	24	: 00
<input checked="" type="checkbox"/>	Mon	Start	00	: 00	End	24	: 00
<input checked="" type="checkbox"/>	Tue	Start	00	: 00	End	24	: 00
<input checked="" type="checkbox"/>	Wed	Start	00	: 00	End	24	: 00
<input checked="" type="checkbox"/>	Thu	Start	00	: 00	End	24	: 00
<input checked="" type="checkbox"/>	Fri	Start	00	: 00	End	24	: 00
<input checked="" type="checkbox"/>	Sat	Start	00	: 00	End	24	: 00

Send to:

E-mail Address

User Name

Password

SMTP Mail Server

Sender E-mail Address

Recipient E-mail Address

Port  (range 1 to 65535)

FTP Server

User Name

Password

Host Name

Path

Filename Prefix

Port  (range 1 to 65535)

Interval  Seconds (range 1 to 86400 seconds)

Passive Mode

Save Settings Don't Save Settings

**Helpful Hints...**

You can choose to receive notifications by FTP and/or E-mail. The 'Test' buttons are provided to test if your input settings are valid and functional.

# Digital Output

You may enable the **Digital Output (DO)** feature and configure the source of event for your camera.

**Enable D/O** This enables the D/O to send a signal when there **signal:** is a triggered event.

**Trigger Event:** You can choose from one or up to three events, such as **Motion Detection, D/I Signal 1,** and **D/I Signal 2** for the sources of the triggered events.

The screenshot displays the web interface for a D-Link DCS-3430 camera. The top navigation bar includes 'LIVE VIDEO', 'SETUP', 'ADVANCED', 'MAINTENANCE', 'STATUS', and 'HELP'. The 'SETUP' menu is expanded to show 'DIGITAL OUTPUT'. The main content area is titled 'DIGITAL OUTPUT' and contains the following text: 'Here you can enable your D/O port as well as how the event will be triggered.' Below this text are two buttons: 'Save Settings' and 'Don't Save Settings'. The 'TRIGGER' section is visible, showing a checkbox for 'Enable D/O Signal' and a 'Trigger Event' dropdown menu. The dropdown menu is open, showing three options: 'Motion Detection', 'D/I Signal 1', and 'D/I Signal 2'. At the bottom of the 'TRIGGER' section are two buttons: 'Save Settings' and 'Don't Save Settings'. On the right side of the interface, there is a 'Helpful Hints...' section with the text: 'You may choose a trigger event like Motion detection or triggers from the D/I port. When an event is triggered, the D/O will begin sending a signal.'

# Advanced ICR

**ICR** - IR-Cut Removable(ICR) filter is a switch mechanical design with two different sensor filters. It provides the best lighting conditions for day and night.

**Automatic:** Selecting this feature will automatically set to the day mode during daylight and to the night mode during the night or in dark places.

**Day mode:** Selecting this mode will disable the IR Cut Filter.

**Night mode:** Selecting this mode will enable the IR Cut Filter.

**Scheduled Mode:** This mode will allow you to enter the desired time frames for the ICR filter.

Product: DCS-3430 Firmware Version: 1.0.0

**D-Link**

DCS-3430 // LIVE VIDEO SETUP **ADVANCED** MAINTENANCE STATUS HELP

ICR  
RS-485  
Logout

**ICR**

An IR(Infrared) Cut-Removable(ICR) filter can be disengaged from the image path for increased sensitivity in low light environments. The ICR filter will automatically engage depending on the ambient light, allowing the camera to be effective in day/night environments.

1. Select the Day/Night from the radio button. The available options are Automatic, Schedule mode, Day mode and Night mode.
2. The default value is Automatic.

Save Settings Don't Save Settings

**ICR**

IR-Cut Removable filter trigger condition:

Automatic  
 Day mode  
 Night mode  
 Scheduled mode  
 Day mode(24hr)  
 From 00 to 00 to 00 to 00

**Helpful Hints..**

**ICR :**

**Automatic:**The Day/Night mode is set automatically. It is normally set in the Day mode and changes to the Night mode in a dark place.

**Day mode:**The Day mode means disable the IR Cut Filter.

**Night mode:**The Night mode means enable the IR Cut Filter.

**Schedule mode:**Set the Day/Night mode using the schedule. Fill in the time so the Day/Night mode is normally set to Day mode and it enters the Day mode at the start time and returns to the Night mode at the end time.

**SECURITY**



## RS-485

You may configure the **RS-485** settings or communication specifications (baud rate, data bit, stop bit, and parity bit) for your camera. RS-485 is a serial communication method for computers and devices. For your camera, RS-485 is used to control a PAN/TILT device, such as an external camera enclosure to perform PAN and TILT movement.

**Support PAN-TILT:** When enabling Support PAN-TILT, a control panel will be displayed on the Live Video page allowing control through RS-485 for an external camera enclosure.

**Protocol:** Select one protocol type from the pull-down menu.

**ID:** Range from **1** to **255**, is the identifier for each RS-485 devices.

**Baud Rate:** Range from **2400** to **38400** bps. It is a speed measurement for communication between a transmitter and receiver, indicates the number of bit transfers per second. Higher baud rate will reduce the distance of the two devices (transmitter and receiver). By default, the value is **2400**.

**Data Bit:** Either **7** or **8**. It is a measurement of the actual data bits in a transmission. By default, the value is **8**.

**Stop Bit:** Either **1** or **2**. It is used to signal the end of communication for a single packet. The more bits used for stop bits, the greater the lenience in synchronizing the different clocks but the slower the data transmission rate. By default, the value is **1**.

**Parity Bit:** Choices of **No**, **Even**, and **Odd**. It is a simple form of error checking used in serial communication and you may use no parity. For even and odd parity, the serial port sets the parity bit (the last bit after the data bits) to a value to ensure that the transmission has an even or odd number of logic-high bits. For example, if the data is 011, for even parity, the parity bit is 0 to keep the number of logic-high bits even. If the parity is odd, the parity bit is 1, resulting in 3 logic-high bits.

The screenshot shows the D-Link DCS-3430 camera configuration interface. The top navigation bar includes 'LIVE VIDEO', 'SETUP', 'ADVANCED', 'MAINTENANCE', 'STATUS', and 'HELP'. The 'ADVANCED' tab is selected, and the 'RS-485' sub-tab is active. The main content area displays the following settings:

- Support PAN-TILT:**  (unchecked)
- Protocol:** Pelco-D (dropdown menu)
- ID:** 1 (text input field)
- Baud Rate:** 2400 (dropdown menu)
- Data Bits:** 7 (radio button), 8 (radio button)
- Stop Bit:** 1 (radio button), 2 (radio button)
- Parity Bit:** No (radio button), Even (radio button), Odd (radio button)

Buttons for 'Save Settings' and 'Don't Save Settings' are located below the settings. A 'Helpful Hints...' sidebar on the right provides additional information:

- ID value:** ID value is between 1 and 255. ID is used to identify RS-485 device.
- Stop bit:** Stop bit can be set to either 1 bit or 2 bits.
- Support PAN-TILT:** When enabling Support PAN-TILT a control panel will be displayed on the Live Video page allowing control through RS-485 for an external camera enclosure.
- Protocol:** Select the PTZ standard used to connect a PTZ scanner via the serial interface: RS485.
- Baud Rate:** Select the desired baud rate for the device you connected.
- Stop Bit:** Select the desired stop bits for the device you connected.
- Data Bits:** Select the desired data bits for the device you connected.
- Parity Bit:** Select the desired parity type for the device you connected.

# Maintenance

## Device Admin

You may modify the name and administrator's password of your camera, as well as add and manage the user accounts for accessing the camera. You may also use this section to create the unique name and configure the OSD setting for your camera.

**Admin password setting:** Set a new password for the administrator's account.

**Add user account:** Add new user account.

**User name:** The user name for the new account.

**Password:** The password for the new account.

**User List:** All the existing user accounts will be displayed here. You may delete any accounts included on the list.

**Camera Name:** Create a unique name for your camera, in which you can access the camera by using this name in your web-browser.  
For example: http://DCS-3411/3430 (By default).

**Enable OSD:** Select this option to enable the On-Screen Display feature for your camera.

**Label:** The label name.

**Show time:** Select this option to enable the time-stamp display in the video screen.

**LED Light:** Chose **On** or **Off**.

Product: DCS-3430 Firmware Version: 1.0.0

**D-Link**

DCS-3430 // LIVE VIDEO SETUP ADVANCED MAINTENANCE STATUS HELP

**ADMIN**

Here you can change the administrator's password for your account as well as add and/or delete user account(s). You can also configure a unique name for your camera, and enable its OSD (On-Screen Display) feature in order to display camera name and time stamp for both live video and recordings of your camera.

**ADMIN PASSWORD SETTING**

New Password  30 characters maximum  
Retype Password

**ADD USER ACCOUNT**

User Name  20 users maximum  
New Password  30 characters maximum  
Retype Password

**USER LIST**

User Name  -- User list --

**DEVICE SETTING**

Camera Name  DCS-3430 36 characters maximum  
 Enable OSD  
Label  PM 30 characters maximum  
Show time   
LED light  On  Off

**Helpful Hints..**

For security purposes, it is recommended to change the password for your administrator account. Be sure to write down the new password to avoid having to reset the camera in the event that it is forgotten.

Enabling OSD, the camera name and time will be displayed on the video screen.

# System

In this section, you may backup, restore and reset the settings as well as reboot your camera.

**Save To Local Hard Drive:** You may save and document your current configuration settings into your computer.

**Local From Local Hard Drive:** **Browse** and then restore the pre-defined settings to your camera by clicking **Load Configuration**.

**Restore To Factory Default:** You may reset your camera and restore the factory settings to your camera by clicking **Restore Factory Defaults**.

**Reboot Device:** This will restart your camera.

The screenshot displays the D-Link camera's web interface. At the top, it shows 'Product: DCS-3430' and 'Firmware Version: 1.0.0'. The D-Link logo is prominently displayed. Below the logo is a navigation menu with tabs for 'LIVE VIDEO', 'SETUP', 'ADVANCED', 'MAINTENANCE', 'STATUS', and 'HELP'. The 'MAINTENANCE' tab is selected, leading to the 'SYSTEM' configuration page. The page title is 'SYSTEM' and it contains the text: 'Here you may backup, restore, and reboot your camera.' The main content area lists four actions with corresponding buttons: 'Save To Local Hard Drive' with a 'Save Configuration' button, 'Load From Local Hard Drive' with a text input field and a 'Browse...' button, followed by a 'Load Configuration' button, 'Restore To Factory Defaults' with a 'Restore Factory Defaults' button, and 'Reboot Device' with a 'Reboot Device' button. On the left side, there is a vertical menu with options: 'Admin', 'System', 'Firmware Upgrade', and 'Logout'. On the right side, there is a 'Helpful Hints..' section with text: 'After the factory's default settings have been restored, use the installation wizard software provided with your camera to search and connect to the camera.' At the bottom of the interface, the word 'SECURITY' is visible.

# Firmware Upgrade

Your current firmware version and date will be displayed on your screen. You may go to the D-Link Support Page to check for the latest firmware version available.

To upgrade the firmware on your DCS-3411/3430, please download and save the latest firmware version from the D-Link Support Page to your local hard drive. Locate the file on your local hard drive by clicking the **Browse** button. Then, open the file and click the **Upload** button to start the firmware upgrade.

**Current firmware version:** It will be automatically determined and displayed by the system.

**Current Product Name:** Name of the existing product.

**File Path:** Locate the file (upgraded firmware) on your hard drive by clicking **Browse**.

**Upload:** Start uploading the new firmware to your camera.

The screenshot shows the D-Link web interface for a DCS-3430 camera. The top navigation bar includes 'LIVE VIDEO', 'SETUP', 'ADVANCED', 'MAINTENANCE', 'STATUS', and 'HELP'. The 'MAINTENANCE' tab is selected, displaying the 'FIRMWARE UPGRADE' section. The interface includes a sidebar with 'Admin', 'System', 'Firmware Upgrade', and 'Logout' options. The main content area contains the following text:

**FIRMWARE UPGRADE**

A new firmware upgrade may be available for your IP camera. It is recommended to keep your IP camera firmware up-to-date to maintain and improve the functionality and performance of your internet camera. Click here [D-Link Support Page](#) to check for the latest firmware version available.

To upgrade the firmware on your IP camera, please download and save the latest firmware version from the D-Link Support Page to your local hard drive. Locate the file on your local hard drive by clicking the Browse button. Once you have found and opened the file using the browse button, click the "Upload" button to start the firmware upgrade.

**FIRMWARE INFORMATION**

Current Firmware Version: 1.0.0, 2901  
Current Product Name: DCS-3430

**FIRMWARE UPGRADE**

File Path:

On the right side, there is a 'Helpful Hints..' section with the following text:

Firmware upgrade are released periodically to improve the functionality of your IP camera and also to add new features. If you run into a problem with a specific feature of the IP camera, check our support site by clicking [here](#) to check for an upgrade and see if updated firmware is available for your IP camera.

The bottom of the interface features a 'SECURITY' banner.

# Status

## Device Info

This page displays all the details information about your device and network connection.

Product: DCS-3430
Firmware Version: 1.0.0

D-Link

DCS-3430
LIVE VIDEO
SETUP
ADVANCED
MAINTENANCE
STATUS
HELP

Device Info

Log

Logout

DEVICE INFO

All of your network connection details are displayed on this page. The firmware version is also displayed here.

INFORMATION

Camera Name	DCS-3430
Time & Date	Tue Apr 14 10:54:51 2009
Firmware Version	1.0.0, 2901
MAC Address	00:03:1B:58:91:36
IP Address	192.168.1.179
IP Subnet Mask	255.255.255.0
Default Gateway	192.168.1.1
Primary DNS	192.168.1.1
Secondary DNS	
PPPoE	Disable
DDNS	Disable

Helpful Hints..

This page displays all the information about the camera and network settings.

SECURITY

# Logs

This page displays the log information of your camera. You may download the information by clicking **Download** or delete the log information by clicking **Clear**.

The screenshot displays the D-Link camera web interface. At the top, it shows 'Product: DCS-3430' and 'Firmware Version: 1.0.0'. The D-Link logo is prominently displayed in the center. Below the logo is a navigation menu with tabs for 'LIVE VIDEO', 'SETUP', 'ADVANCED', 'MAINTENANCE', 'STATUS', and 'HELP'. The 'STATUS' tab is selected. On the left side, there is a sidebar menu with 'Device Info', 'Log', and 'Logout' options. The main content area is divided into two sections: 'SYSTEM LOG' and 'CURRENT LOG'. The 'SYSTEM LOG' section contains the text: 'The system log records camera events that have occurred.' The 'CURRENT LOG' section is currently empty and contains two buttons: 'Clear' and 'Download'. On the right side, there is a 'Helpful Hints..' section with the text: 'You can save the log to your local hard drive by clicking the Download button, and you can clear the log by clicking on the Clear button.' At the bottom of the interface, the word 'SECURITY' is displayed.

# Help

Product: DCS-3430 Firmware Version: 1.0.0



DCS-3430	LIVE VIDEO	SETUP	ADVANCED	MAINTENANCE	STATUS	HELP
Help Menu	<b>HELP MENU</b>					
Logout	LIVE VIDEO SETUP MAINTENANCE STATUS					
	<b>LIVE VIDEO</b>					
	<a href="#">Camera</a>					
	<b>SETUP</b>					
	<a href="#">Setup Wizard</a> <a href="#">Network Setup</a> <a href="#">Wireless Setup</a> <a href="#">Dynamic DNS</a> <a href="#">Image Setup</a> <a href="#">Audio and Video</a> <a href="#">Motion Detection</a> <a href="#">Time and Date</a> <a href="#">Recording</a> <a href="#">Snapshot</a> <a href="#">Digital Output</a> <a href="#">RS-485</a>					
	<b>MAINTENANCE</b>					
	<a href="#">Admin</a> <a href="#">System</a> <a href="#">Firmware Upgrade</a>					
	<b>STATUS</b>					
	<a href="#">Device Info</a> <a href="#">Log</a>					
<b>SECURITY</b>						

# D-ViewCam Installation

D-ViewCam software is included for the administrator to manage up to 32 D-Link IP cameras remotely. You may now use the software to configure all the advanced settings for your cameras. D-ViewCam is a comprehensive management tool for IP surveillance.

Insert the CD-ROM into the CD-ROM drive. A menu screen will appear as shown below.

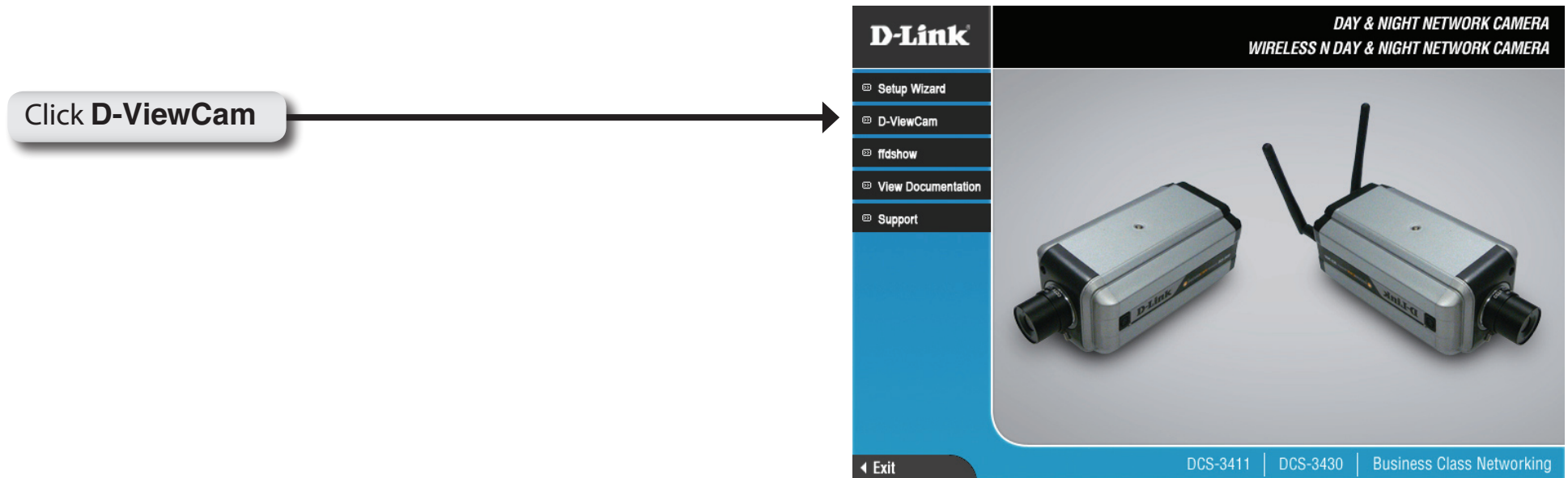

D-ViewCam provides English, Traditional Chinese and Simplified Chinese language versions. Select a language version and click **OK** to continue.

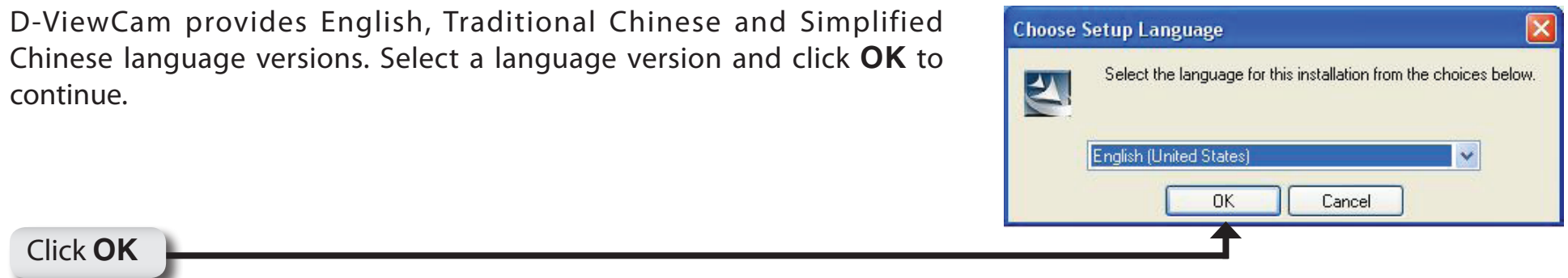



Click **Next** to continue.

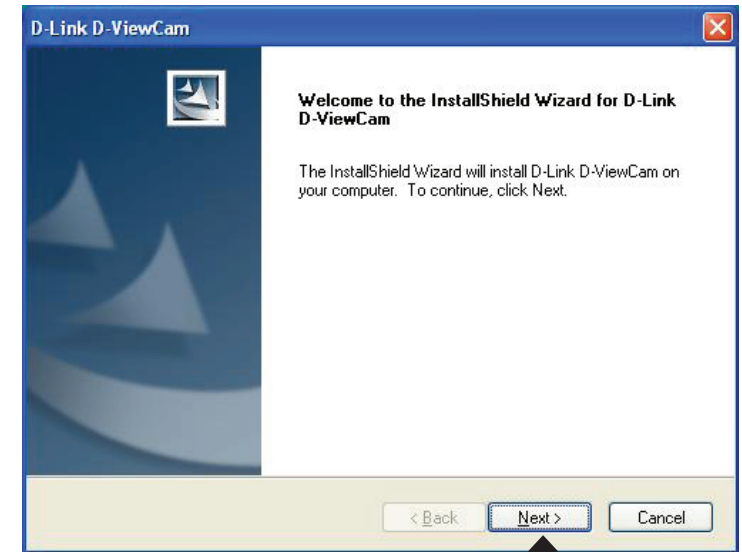

Click **Next**

Click **Browse** if you would like to choose a specific folder for the installation, otherwise click **Next** to continue.

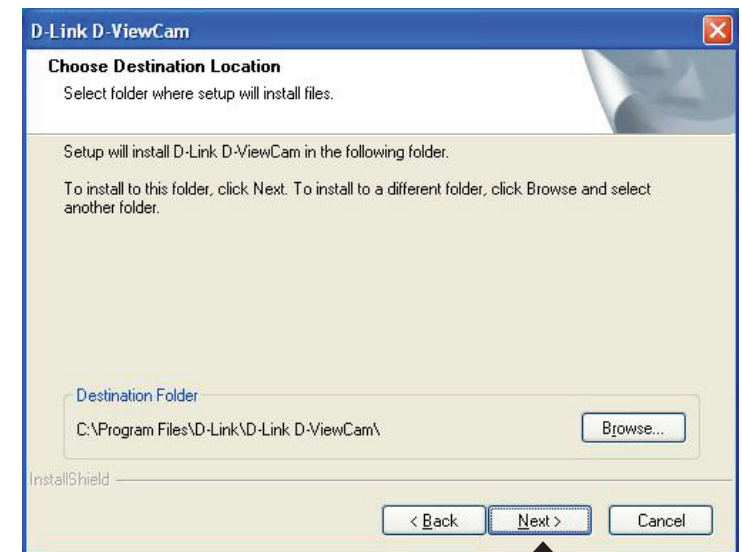

Click **Next**

Click **Next** to start the installation.

Note: The D-ViewCam installation process may take several minutes to complete.

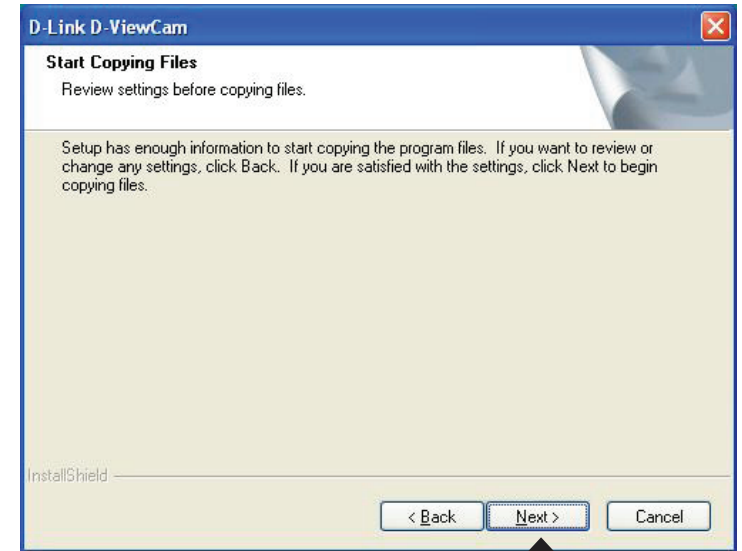

Click **Next**

Click **Finish** to complete the installation.

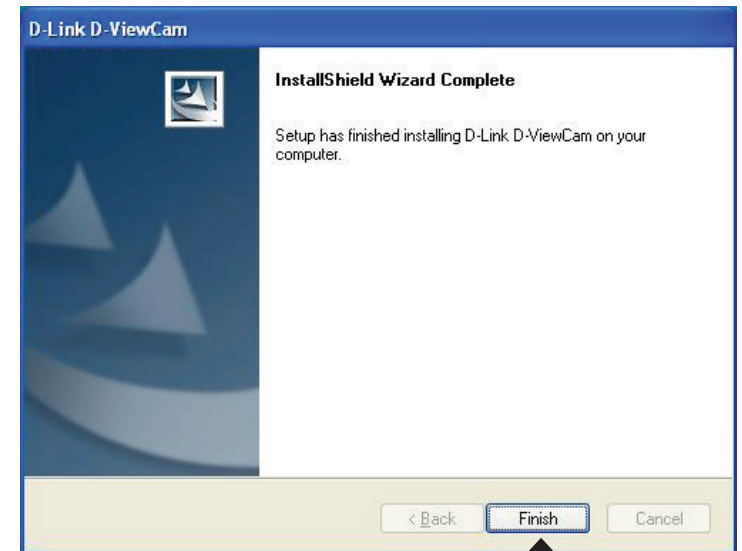

Click **Finish**

# Add a Camera

This section will show you how to start and add a camera to the D-ViewCam system.

To start D-ViewCam, select **Start > All Programs > D-Link > D-Link D-ViewCam**.



Enter **Admin** as the default user name and leave the password blank. Click  / **OK** to log into the system and access the Add Camera Wizard.

Note: Please refer to page 51 in the D-ViewCam user manual to change your password.

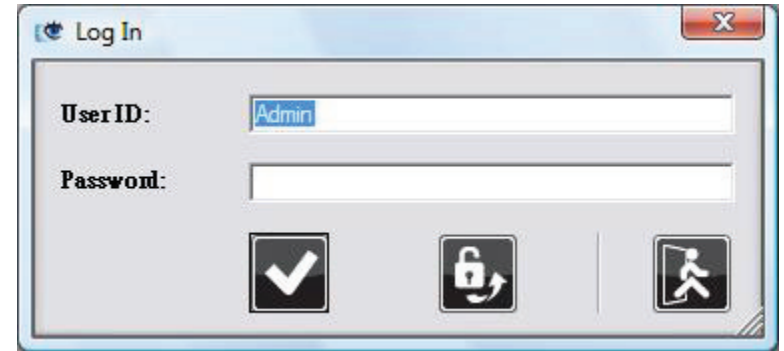

Welcome to the Add Camera Wizard. Use this wizard to add your cameras to the D-ViewCam system.

Note: Use the left or right arrow to navigate the wizard.

Click  **Next** to continue.

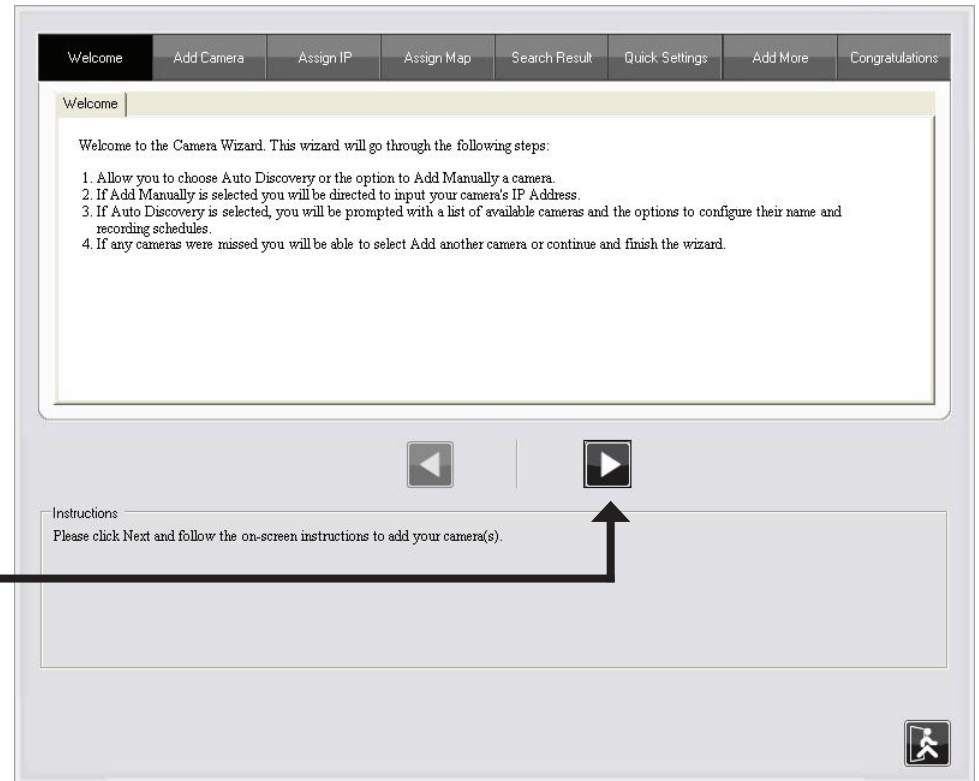

Click **Next**

Choose which method to add your camera(s). You can choose **Auto Discovery** to automatically search for your camera(s), or choose **Add Manually** to add your camera(s) via the camera's IP address. Click **Next** to continue.

If you choose **Auto Discovery**, the system will search all available cameras that are located on the same LAN with same subnet. The system will place all the cameras under the default map called My Map. Click **Next** to continue.

If you choose **Add Manually**, enter the IP address or domain name, http port, model name, camera ID and password.

Click the "?" button to auto detect the camera's model name, then the model name will appear in the **Model Name** box.

Click **Next** to continue.

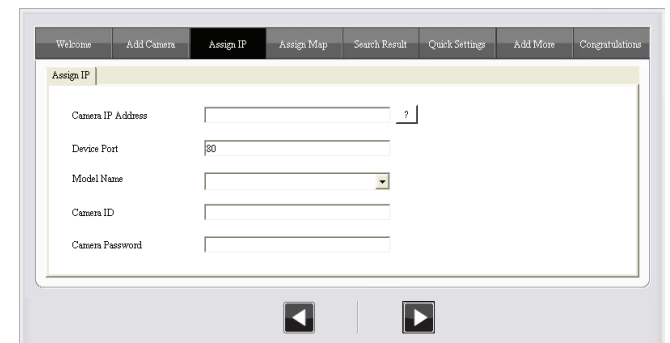
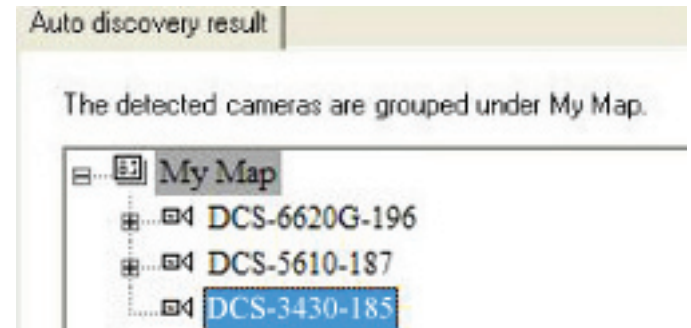
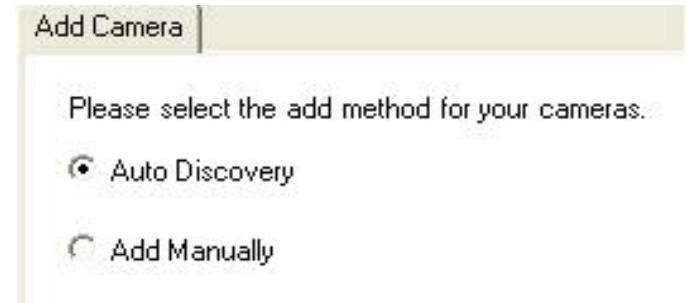

D-ViewCam shows the detected IP camera(s) information. You can choose and schedule the recording for each camera.

- **24/7 Continuous Recording:** Continuously recording 24 hours a day, 7 days a week.
- **24/7 Motion Detection Recording:** Continuously monitoring but ONLY recording when motion is detected.
- **Office Hours Only:** Continuously monitoring during office hours (08:00 AM to 06.00 PM) and ONLY recording when motion is detected.
- **Non-Office Hours Only:** Continuously monitoring during non-office hours (06:00 PM to 08.00 AM) and ONLY recording when motion is detected.

Note: Excluding 24/7 Continuous Recording, other schedule recording types can ONLY do recording when motion is detected. Please refer to page 35 in the D-ViewCam manual for more information.

Click **Next** to continue.

Quick Settings

The discovered cameras information showed as below:

Camera Name	Model	Schedule Recording Type	Status	IP Address	MAC Address
DCS-5610-187	DCS-5610	None	Active	10.129.1.187	000D887D6DC4
DCS-6620G-99	DCS-6620G	None	Active	10.129.1.99	001346DC3BC3
DCS-3430-185	DCS-3430	None	Active	10.129.1.185	001346DC3BEB

Select **Yes** to add other camera(s), or select **No** if you have no additional camera(s) to be added. Click **Next** to continue.

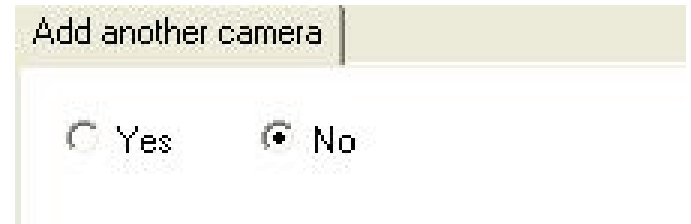

The **Add Camera wizard** is now complete. Click **Close** to access the D-ViewCam's main screen.

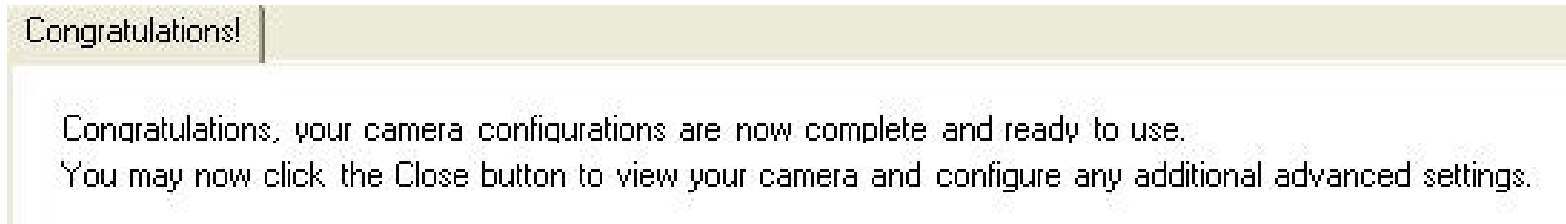

## Your D-ViewCam Installation is Complete!

Note: Please refer to the D-ViewCam user manual for information about using D-ViewCam.

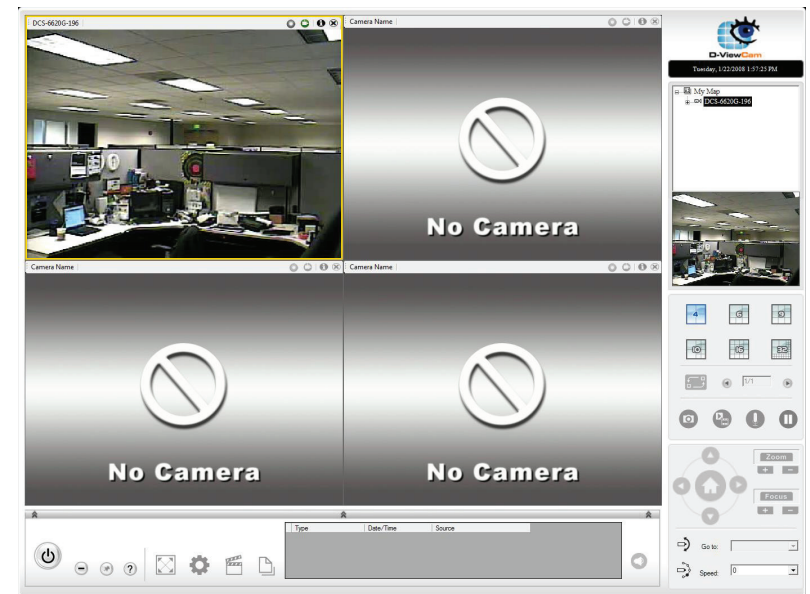

# Troubleshooting

## **1. What is an Network Camera?**

The Network Camera is a stand-alone system connecting directly to an Ethernet or Fast Ethernet network. It differs from a conventional PC Camera, the Network Camera is an all-in-one system with built-in CPU and Web-based solutions providing a low cost solution that can transmit high quality video images for monitoring. The Network Camera can be managed remotely, accessed and controlled from any PC/Notebook over an Intranet or the Internet from a Web browser.

## **2. What is the maximum number of users that can be allowed to access DCS-3411/3430 simultaneously?**

The maximum number of users that can log onto the Network Camera at the same time is 10. Please keep in mind the overall performance of the transmission speed will slow down when many users are logged on.

## **3. What algorithm is used to compress the digital image?**

The Network Camera utilizes MPEG-4 simple profile image compression technology to provide high quality images.

## **4. Can I capture still images from the Network Camera?**

Yes you are able to capture still images with the snapshot function from the software application CD supplied with the Network Camera or with the snapshot function on the Home page using an Internet browser.

## **5. Can the Network Camera be used outdoors?**

The Network Camera is not weatherproof. It needs to be equipped with a weatherproof case to be used outdoors and it is not recommended.

## **6. When physically connecting the Network Camera to a network what network cabling is required?**

The Network Camera uses Category 5 UTP cable allowing 10 Base-T and 100 Base-T networking.

## **7. Can the Network Camera be setup as a PC-cam on a computer?**

No, the DCS-3411/3430 Network Camera is used only on an wireless 802.11n, Ethernet or Fast Ethernet network.



**8. Can the DCS-3411/3430 be connected to the network if it consists of only private IP addresses?**

Yes, the Network Camera can be connected to a LAN with private IP addresses.

**9. Can the DCS-3411/3430 be installed and work if a firewall exists on the network?**

If a firewall exists on the network, port 80 is open for ordinary data communication. The DCS-3411/3430 uses port 5002 for streaming audio and port 5003 for streaming video. These ports (or the ports you specify from the Advanced Tab in the Configuration screen if you change the default ports) need to be opened on the firewall.

**10. Why am I unable to access the DCS-3411/3430 from a Web browser?**

If a router or firewall is used on the network, the correct ports for the DCS-3411/3430 may not be configured on the router or firewall. To correct the problem, you need to determine if the DCS-3411/3430 is behind a router or firewall and if the router or firewall is properly configured for the ports the DCS-3411/3430 is using. Other possible problems might be due to the network cable. Try replacing your network cable. Test the network interface of the product by connecting a local computer to the unit, utilizing a Ethernet crossover cable. If the problem is not solved the Network Camera might be faulty.

**11. Why does the Network Camera work locally but not externally?**

This might be caused by network firewall protection. The firewall may need to have some settings changed in order for the Network Camera to be accessible outside your local LAN. Check with the Network Administrator for your network.

Make sure that the Network Camera isn't conflicting with any Web server you may have running on your network. The default router setting might be a possible reason. Check that the configuration of the router settings allow the Network Camera to be accessed outside your local LAN.

**12. I connected the Network Camera directly to a computer with a cross-over cable Ethernet cable and received the following Windows error upon running the Installation Wizard:**

This Windows error will occur if the Network Camera is connected to a computer that is not properly configured with a valid IP address. Turn off DHCP from the Network Settings in Windows and configure the computer with a valid IP address, or connect the camera to a router with DHCP enabled. This error can also occur if the Installation Wizard icon is clicked on more than once from the setup wizard.

**13. Noisy images occur. How can I solve the problem?**

The video images might be noisy if the Network Camera is used in a very low light environment. To solve this issue you need more lighting.



**13. The images appear to be of poor quality, how can I improve the image quality?**

Make sure that your computer's display properties are set above 256 colors. Using 16 or 256 colors on your computer will produce dithering artifacts in the image, making the image appear to be of poor quality. The configuration on the Network Camera image display is incorrect. Through the Advanced > Image Setting section of the Web management you need to adjust the image related parameters such as brightness, contrast, hue and power line frequency for fluorescent light.

# DI/DO

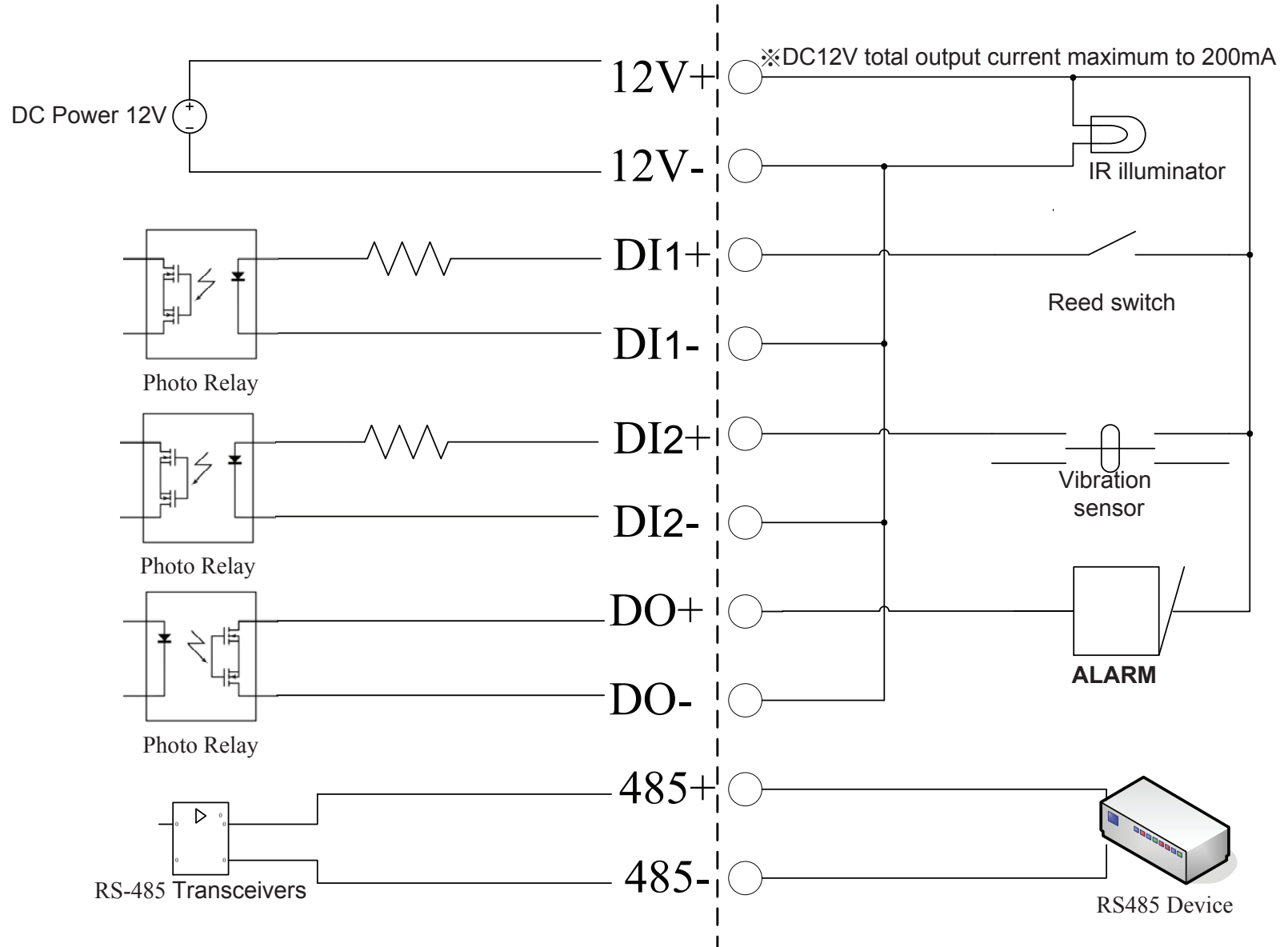

<b>12V+/12V-</b>	Connect to an IR illuminator or other device in parallel connection. The total output current should be under 200mA.
<b>DI</b>	Receive signals from a motion detector or any other external security device.
<b>DO</b>	Connect to an alarm or buzzer. Refer to page 47.
<b>485+/485-</b>	Connect to the RS-485 interface for controlling auxiliary equipment such as an external camera enclosure to perform PAN and TILT movement. Refer to page 49 for more information.

# Networking Basics

## Check your IP address

After you install your new D-Link adapter, by default, the TCP/IP settings should be set to obtain an IP address from a DHCP server (i.e. wireless router) automatically. To verify your IP address, please follow the steps below.

Click on **Start > Run**. In the run box type `cmd` and click **OK**.

At the prompt, type `ipconfig` and press **Enter**.

This will display the IP address, subnet mask, and the default gateway of your adapter.

If the address is `0.0.0.0`, check your adapter installation, security settings, and the settings on your router. Some firewall software programs may block a DHCP request on newly installed adapters.

If you are connecting to a wireless network at a hotspot (e.g. hotel, coffee shop, airport), please contact an employee or administrator to verify their wireless network settings.

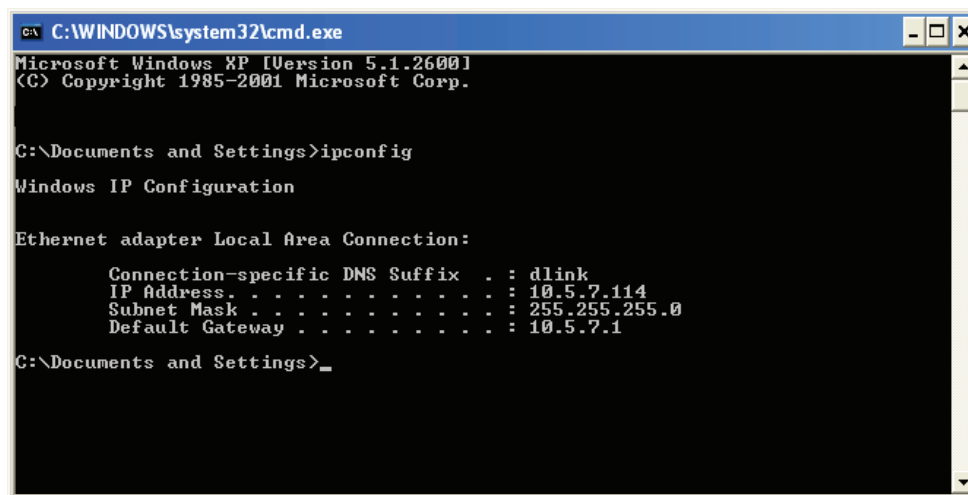

```
C:\WINDOWS\system32\cmd.exe
Microsoft Windows XP [Version 5.1.2600]
(C) Copyright 1985-2001 Microsoft Corp.

C:\Documents and Settings>ipconfig

Windows IP Configuration

Ethernet adapter Local Area Connection:

    Connection-specific DNS Suffix  . : dlink
    IP Address . . . . . : 10.5.7.114
    Subnet Mask . . . . . : 255.255.255.0
    Default Gateway . . . . . : 10.5.7.1

C:\Documents and Settings>_
```

## Statically Assign an IP address

If you are not using a DHCP capable gateway/router, or you need to assign a static IP address, please follow the steps below:

### Step 1

Windows® XP - Click on **Start > Control Panel > Network Connections**.

Windows® 2000 - From the desktop, right-click **My Network Places > Properties**.

### Step 2

Right-click on the **Local Area Connection** which represents your D-Link network adapter and select **Properties**.

### Step 3

Highlight **Internet Protocol (TCP/IP)** and click **Properties**.

### Step 4

Click **Use the following IP address** and enter an IP address that is on the same subnet as your network or the LAN IP address on your router.

Example: If the camera's LAN IP address is 192.168.0.1, make your IP address 192.168.0.X where X is a number between 2 and 99. Make sure that the number you choose is not in use on the network. Set Default Gateway the same as the LAN IP address of your router (192.168.0.1).

Set Primary DNS the same as the LAN IP address of your router (192.168.0.1). The Secondary DNS is not needed or you may enter a DNS server from your ISP.

### Step 5

Click **OK** twice to save your settings.

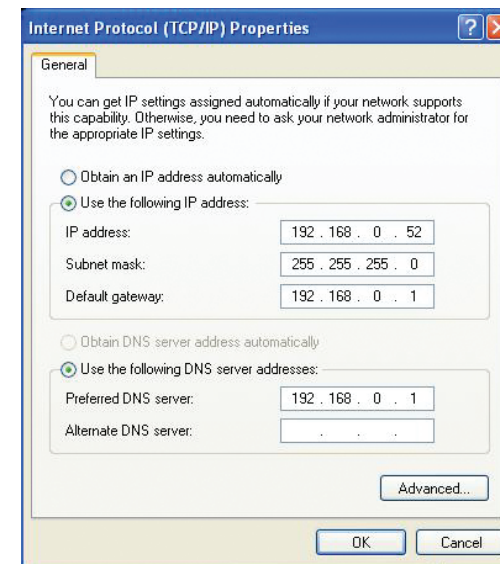

# Technical Specifications

## Video Codec

MPEG4 / MJPEG/ H.264 multi profile compression simultaneously

## PoE (3411 only)

Supported IEEE 802.3af standard

## Sensor

1/4" CMOS Sensor

## SDRAM

64 Mbytes

## Flash Memory

8 Mbytes

## Lens

6mm, F1.8

Support Auto Iris lens, or IR lens

## LAN

- 10/100Base T ports x1
- IEEE 802.3 compliance
- IEEE 802.3u compliance
- Support Full-Duplex operations
- MDI/MDIX auto-negotiation
- 802.3x Flow Control support for Full-Duplex mode
- Supported IEEE 802.3af standard (DCS-3411 only)

## MIC

42dB +/- 3dB, Omni-directional

## Antenna

2 (DCS-3430 only)

## I/O Connector

2 Inputs (Photo relay, Active High: Dropout: 0 VDC)

1 Output (photo relay, Close circuit current: AC 70mA or DC 100mA;  
400ohm; Open circuit voltage: 240 VAC or 350VDC)

Power Output: 12VDC, 200mA

## RS 485

2 pin(485A,485B) (Supported to control external Pan-Tilt device)

## Audio Out

600mV

## Video Out

75 ohm 1Vpp

## Reset Button

Reset to factory default

## Storage

SD card slot

## Dimension (WxDxH)

177mm x 78mm x 60mm

## Weight

577.8g

## Max Power Consumption

- Max : DCS-3411 5.484 W, DCS-3430 6.9W
- Input: 100-240VAC, 50/60Hz, 0.4A
- Output: 12VDC, 1.25A

### **Wireless (DCS-3430 only) Frequency Range And Channels**

- 2.412-2.4835 GHz
- 13 Channels (depend on Area)

### **Transmission**

2TX, 2RX

### **Date Range**

- IEEE 802.11n: From MCS0 to MCS15
- IEEE 802.11g: 54, 48, 36, 24, 18, 12, 9, 6 Mbps
- IEEE 802.11b: 11, 5.5, 2, 1 Mbps
- Auto-select or Manual specified.

### **Outpower**

- 12 dBm@11n (Typical)
- 12 dBm@11g (Typical)
- 16 dBm@11b (Typical)

### **Sensitivity**

- HT40802.11n: Packet Error Rate < 10%, MCS6 < -60 dBm
- HT20802.11n: Packet Error Rate < 10%, MCS6 < -66 dBm
- 802.11g: Packet Error Rate < 10%, 54Mbps < -66 dBm
- 802.11b: Packet Error Rate < 8%, 11Mbps < -82 dB

### **Antenna**

- Connector: MHF
- Operating Frequency: 2.4Ghz

### **Networking**

#### **Protocol**

- IPV4, ARP, TCP, UDP, ICMP
- DHCP Client
- NTP Client
- DNS Client

- DDNS Client (D-Link)
- SMTP Client
- FTP Client
- HTTP Server
- Samba Client
- PPPoE
- UPnP Port Forwarding
- RTP
- RTSP
- RTCP
- 3GPP

### **Ethernet**

10/100M BaseT Fast Ethernet auto negotiation

### **Wireless (DCS-3430 only)**

WMM

### **Video**

#### **Algorithm Supported**

- MPEG4/MJPEG/H.264 multi profile compression simultaneously
- JPEG for still image

### **Features**

- Adjustable image size and quality
- Time stamp and text overlay
- Three configurative motion detection windows
- Flip & Mirror

### **Resolution**

- Up to 30 frames at 640x480
- Up to 30 frames at 320x240
- Up to 30 frames at 160x120

### **Sensitivity**

11.5 V/lux-s at 550nm



**Video**

AGC, AWB, AES, BLC

**Digital Zoom**

Up to 16X

**Low Lux**

0.5 lux@F1.8

**3A control**

AGC, AWB, AES

**Electronic shutter**

NTSC: 1/60 ~ 1/100000 sec.

PAL: 1/50 ~ 1/110000 sec.

**Audio****Sample rate**

GSM-AMR: 12.2kbps, ADPCM: 8Kbps

**Cable**

- Cable Length: 1800 ± 30mm
- UL 20AWGx2C (105°C) 300V

**Plug**

- Type: L type
- Connector Color: Black

**Frequency**

20 ~ 20000Hz

**S/N ratio**

More than 58dB

**Microphone****Directional**

Omni-directional

**Frequency**

20 ~ 20000Hz

**S/N ratio**

More than 58dB

**LED****Control**

Enable/Disable

**Security****Login authentication**

Default Admin ID/PW : admin/space(blank)

**OS Support****Device**

Windows 2000 / Windows XP / Windows Vista / 3GPP Mobile Phone

**Utility**

Windows 2000 / Windows XP / Windows Vista

**Physical Environment****Power**

- 12V 1.25A switching power adapter
- External AC-to-DC Switching Power Adapter
- Type: USA / UK / EUR / AUS / CN (Order by each territory)

**Operation Temperature**

0 to 40°C (32 to 104°F)

**Storage Temperature**

- 20 to 70°C (-4 to 158°F)

### **Humidity**

20-80% RH non-condensing

### **Emission (EMI), Safety & Other Certifications**

- FCC
- IC
- C-Tick
- CE
- LVD

<sup>1</sup>Maximum wireless signal rate derived from IEEE Standard 802.11g, 802.11a and Draft 802.11n specifications. Actual data throughput will vary. Network conditions and environmental factors, including volume of network traffic, building materials and construction, and network overhead, lower actual data throughput rate. Environmental conditions will adversely affect wireless signal range.

<sup>2</sup>Range varies depending on country's regulation.

<sup>3</sup>The DCS-3411/3430 doesn't include 5.25-5.35GHz & 5.47~5.725GHz.