

# USER MANUAL

DCS-2130

VERSION 1.0



---

# Table of Contents

<b>Product Overview</b> .....	<b>4</b>	Time and Date .....	31
Package Contents .....	4	Event Setup .....	32
System Requirements .....	4	Application .....	33
<b>Hardware Overview</b> .....	<b>5</b>	Add Server .....	34
Front .....	5	Add Media .....	35
Rear .....	6	Add Event .....	37
Side .....	7	Add Recording .....	39
<b>Installation</b> .....	<b>8</b>	SD Card .....	41
Starting the Camera Installation Wizard .....	8	Advanced .....	42
Connecting Wirelessly Using WPS .....	9	Digital Input/Output .....	42
<b>Configuration</b> .....	<b>10</b>	HTTPS .....	43
Using the Configuration Menu .....	10	Access List .....	44
Live Video .....	11	Maintenance .....	45
Setup .....	13	Device Management .....	45
Wizard .....	13	Backup and Restore .....	46
Internet Connection Setup Wizard .....	13	Firmware Upgrade .....	47
Motion Detection Setup Wizard .....	16	Status .....	48
Network Setup .....	18	Device Info .....	48
Wireless Setup .....	21	Logs .....	49
Dynamic DNS .....	23	Help .....	50
Image Setup .....	24	<b>Appendix</b> .....	<b>51</b>
Audio and Video .....	26	DI/DO Input Specifications .....	51
Preset .....	28	Technical Specifications .....	52
Motion Detection .....	30		

---

# Preface

D-Link reserves the right to revise this publication and to make changes in the contents hereof without obligation to notify any person or organization of such revisions or changes.

## Manual Revisions

Revision	Date	Description
1.0	June 14, 2011	DCS-2130 Revision A1 with firmware version 1.00

## Trademarks

D-Link and the D-Link logo are trademarks or registered trademarks of D-Link Corporation or its subsidiaries in the United States or other countries. All other company or product names mentioned herein are trademarks or registered trademarks of their respective companies.

Copyright © 2011 D-Link Corporation.

All rights reserved. This publication may not be reproduced, in whole or in part, without prior expressed written permission from D-Link Systems, Inc.

# Package Contents

- DCS-2130 Network Camera
- CAT5 Ethernet cable
- Power adapter
- Camera stand
- CD-ROM with User Manual and software
- Quick Installation Guide

If any of the above items are missing, please contact your reseller.



# System Requirements

- Existing 10/100 Ethernet-based network or 802.11n/g wireless network
- Computer with Windows 7/Vista/XP for Camera Setup Wizard
- Internet Explorer, Firefox, Opera, or other web browser for web interface (Internet Explorer recommended for full functionality)

If any of the above items are missing, please contact your reseller.

# Hardware Overview

## Front

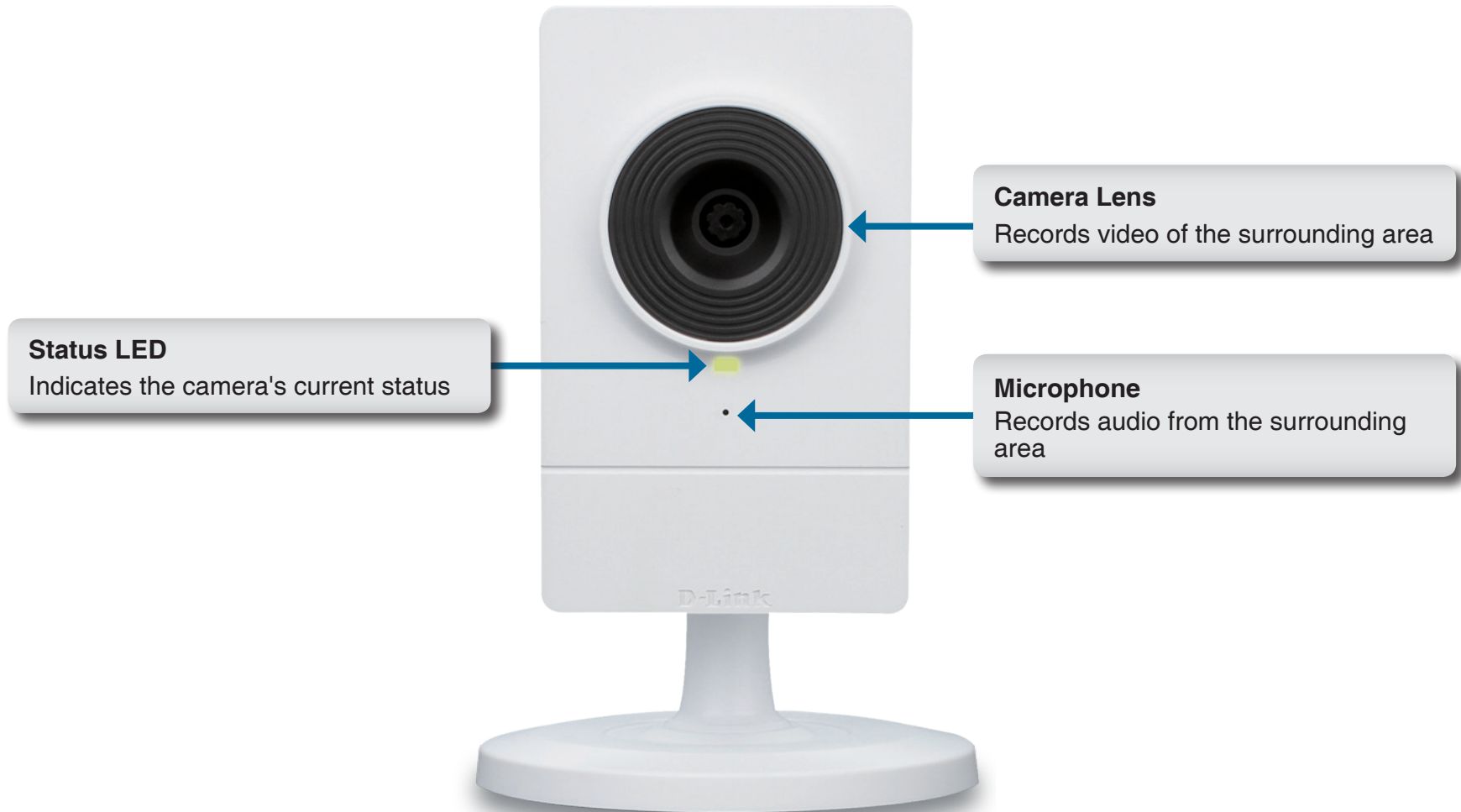

## Rear

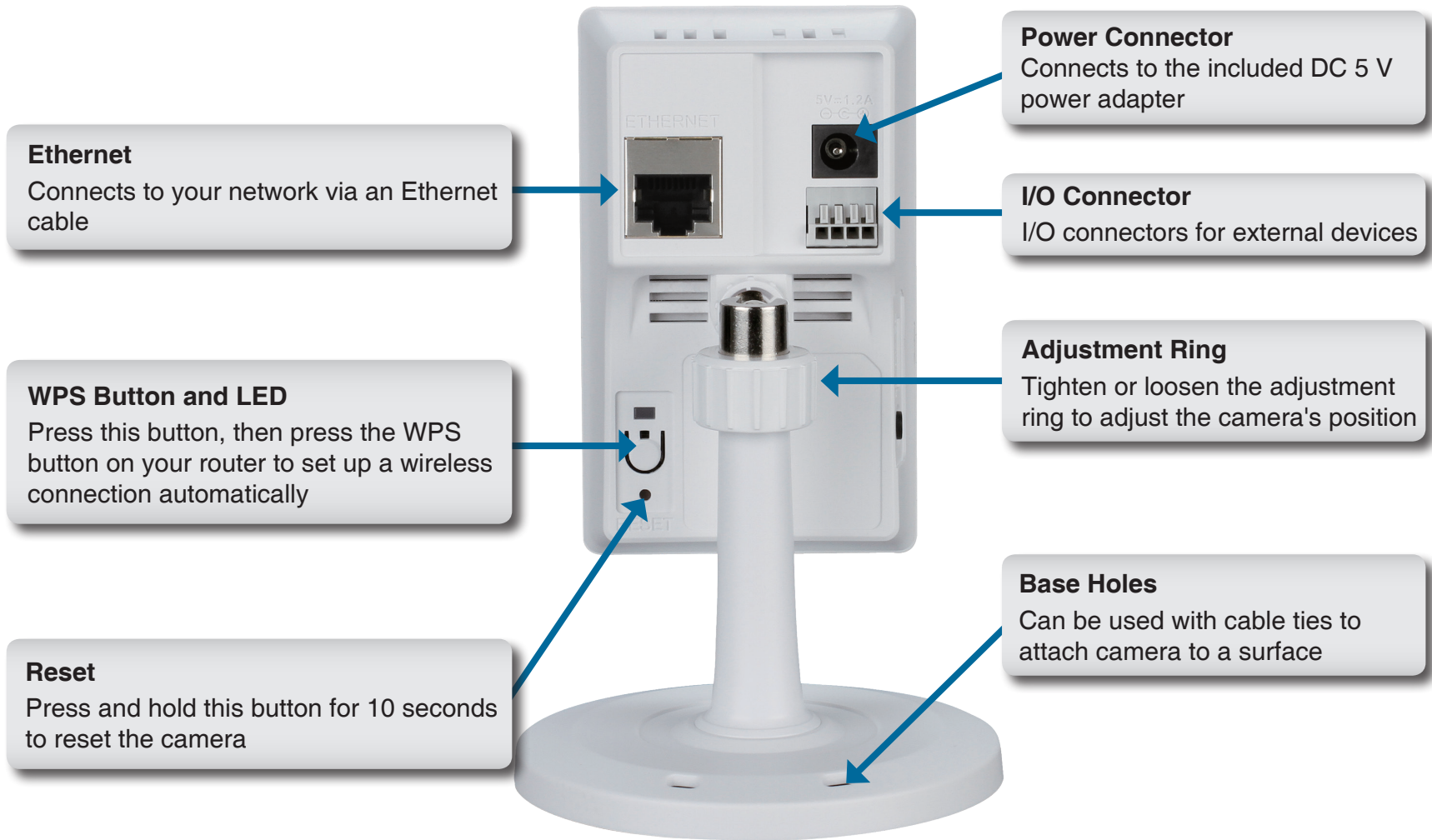

## Side



# Starting the Camera Installation Wizard

Insert the Installation CD-ROM into your computer's optical drive to start the autorun program.

The CD-ROM will open the Camera Setup Wizard. Simply click the **Start** button to go through the Setup Wizard, which will guide you through the setup process from connecting your hardware to configuring your camera.

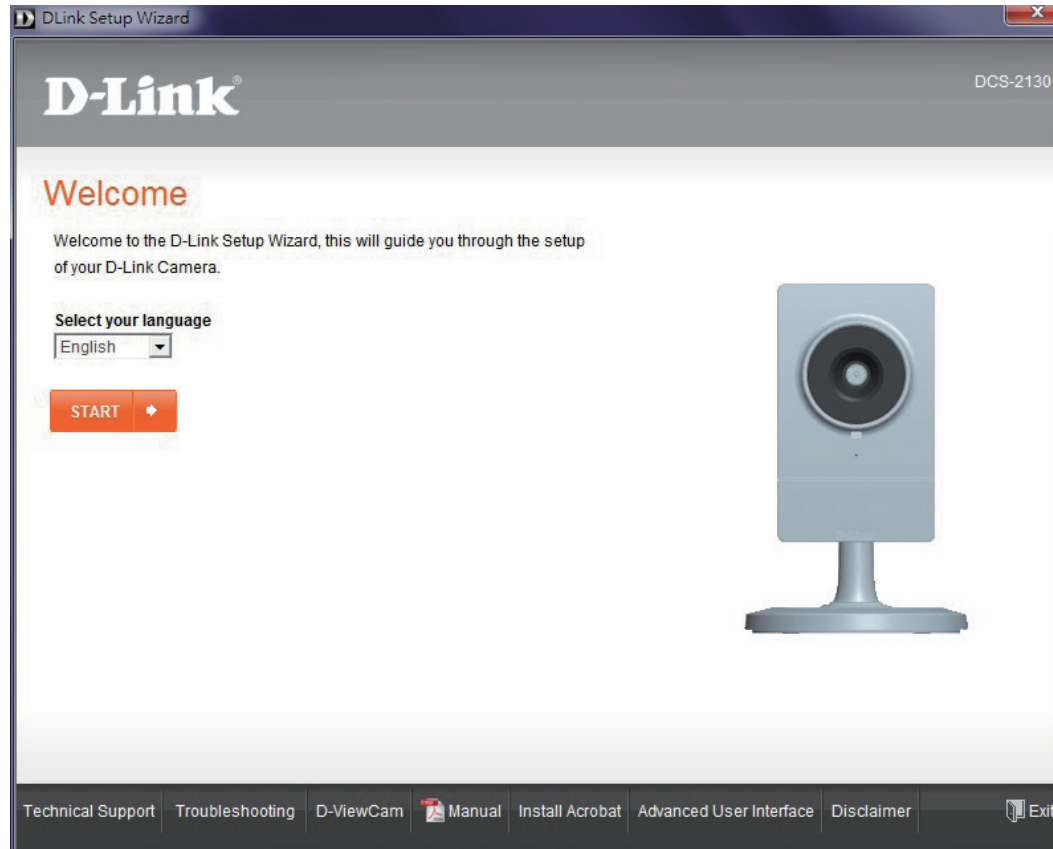



# Connecting Wirelessly Using WPS

Alternatively, you may create a wireless connection by using the WPS Button on the back of the camera.

To create a WPS connection:

## Step 1

Press and hold the WPS button on the back of the camera for three seconds. The WPS status LED above the button will blink.

## Step 2

Press the WPS button on your router within 60 seconds. The WPS button is usually on the front or side of your router. On some routers, you may need to log in to the web interface and then click on an onscreen button to activate the WPS feature. If you are not sure where the WPS button is on your router, please refer to your router's User Manual.

The DCS-2130 will automatically create a wireless connection to your router. While connecting, the green LED will flash and your camera will reboot.



# Using the Configuration Menu

After completing the Camera Setup Wizard, you are ready to use your camera. The camera's built-in Web configuration utility is designed to allow you to easily access and configure your DCS-2130. At the end of the wizard, click the **Go To Camera** button, or enter the IP address of your camera into a web browser, such as Internet Explorer. To log in, use the user name **admin** and the password you created in the Installation Wizard. If you did not create a password, the default password is blank. After entering your password, click the **OK** button.

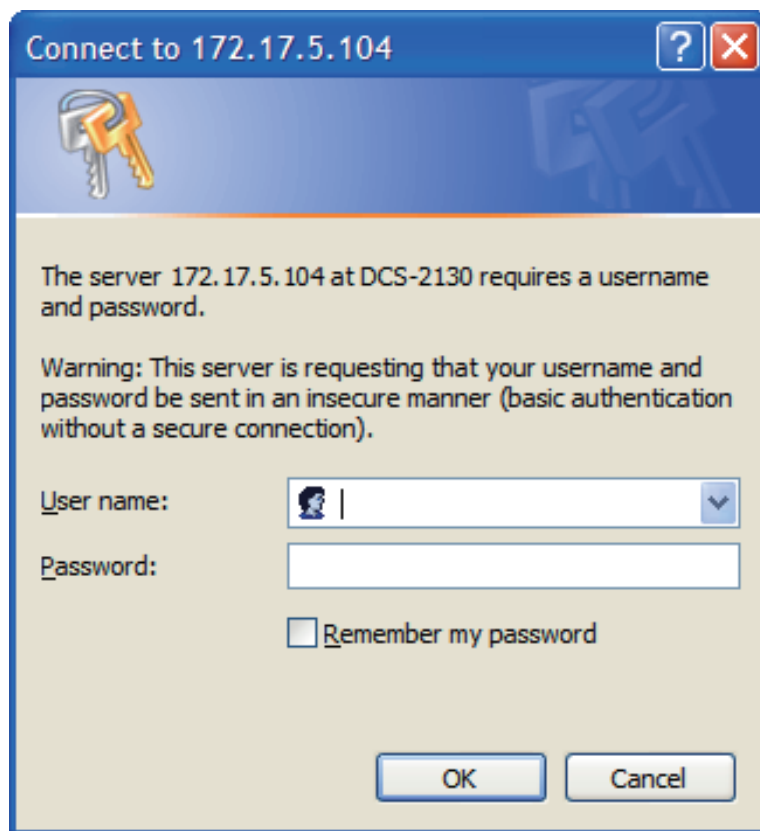

**Note:** If you are directly connecting your PC to the camera, or if you are using the camera on a closed network, the default IP is **192.168.0.20**.











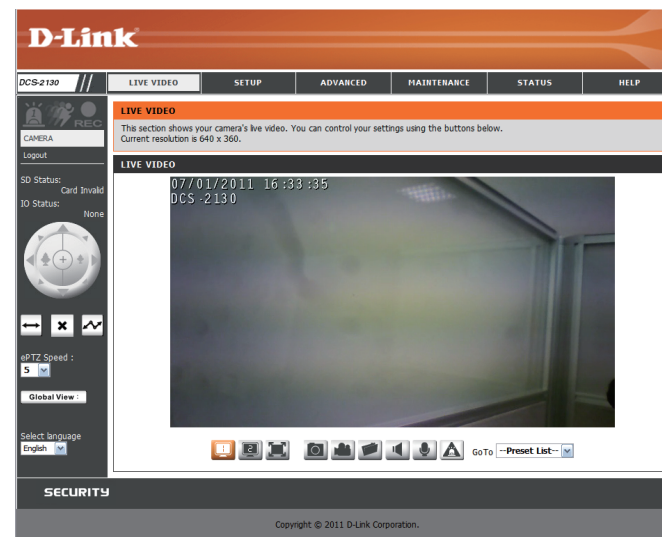

# Live Video

This section shows your camera's live video. You may select any of the available icons listed below to operate the camera. You may also select your language using the drop-down menu on the left side of the screen.

You can zoom in and out on the live video image using your mouse. Right-click to zoom out or left-click to zoom in on the image.

	<b>Digital Input Indicator</b>	This indicator will change color when a digital input signal is detected.
	<b>Motion Trigger Indicator</b>	This indicator will change color when a trigger event occurs.  <b>Note:</b> The video motion feature for your camera must be enabled.
	<b>Recording Indicator</b>	When a recording is in progress, this indicator will change color.



-  Video Profile 1
-  Video Profile 2
-  Video Profile 3
-  Full screen mode
-  Taking a Snapshot
-  Recording a Video Clip
-  Set a Storage Folder
-  Listen/Stop Listening
-  Talk/Stop Talking
-  Start/Stop Digital Output

	<b>Control Pad</b>	This control pad can be used to pan, tilt, and zoom within the camera's predefined view area, if one has been defined.
---	--------------------	--

**Go To:** If any presets have been defined, selecting a preset from this list (**Preset List**) will display it.

**SD Status:** This option displays the status of the SD card. If no SD card has been inserted, this screen will display the message "Card Invalid."

**IO Status:** This option displays the status of your I/O device if a device has been connected.



**PTZ Control:** This camera uses electronic pan/tilt/zoom (ePTZ) to select and view areas of interest in the field of view. Please see page 26 for information about setting the frame size and view window area.

**ePTZ Speed:** You may select a value between 0 and 64. 0 is the slowest and 64 is the fastest.

**Global View:** This window indicates the total field of view (FOV) of the camera. The red box indicates the visible region of interest (ROI).

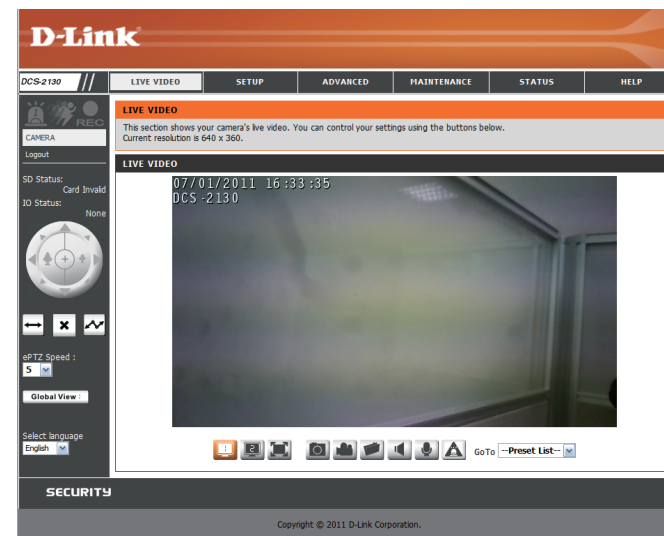
**Language:** You may select the interface language using this menu.



	<b>Auto Pan</b>	Starts the automatic panning function. The ROI will pan from back and forth within the FOV
	<b>Stop</b>	Stops the camera ePTZ motion
	<b>Preset Path</b>	Starts the camera's motion along the predefined path

# Setup Wizard

To configure your Network Camera, click **Internet Connection Setup Wizard**. Alternatively, you may click **Manual Internet Connection Setup** to manually configure your Network Camera and skip to page 22.

To quickly configure your Network Camera's motion detection settings, click **Motion Detection Setup Wizard**. If you want to enter your settings without running the wizard, click **Manual Motion Detection Setup** and skip to page 27.

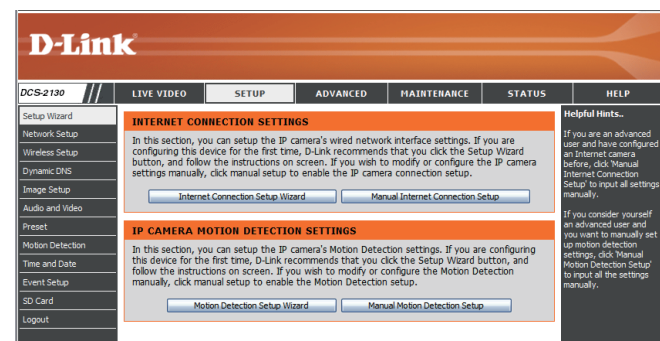

## Internet Connection Setup Wizard

This wizard will guide you through a step-by-step process to configure your new D-Link Camera and connect the camera to the internet. Click **Next** to continue.

**Note:** Select DHCP if you are unsure of which settings to choose.

Click **Next** to continue.

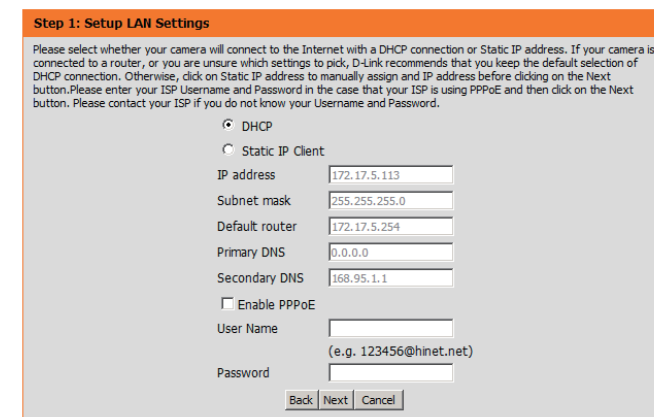
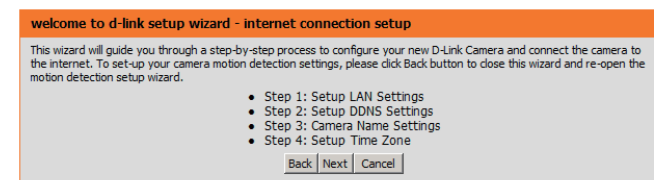

# Configuration

Select Static IP if your Internet Service Provider has provided you with connection settings, or if you wish to set a static address within your home network. Enter the correct configuration information and click **Next** to continue.

If you are using PPPoE, select **Enable PPPoE** and enter your user name and password, otherwise click **Next** to continue.

If you have a Dynamic DNS account and would like the camera to update your IP address automatically, Select **Enable DDNS** and enter your host information. Click **Next** to continue.

Enter a name for your camera and click **Next** to continue.

**Step 1: Setup LAN Settings**

Please select whether your camera will connect to the Internet with a DHCP connection or Static IP address. If your camera is connected to a router, or you are unsure which settings to pick, D-Link recommends that you keep the default selection of DHCP connection. Otherwise, click on Static IP address to manually assign and IP address before clicking on the Next button. Please enter your ISP Username and Password in the case that your ISP is using PPPoE and then click on the Next button. Please contact your ISP if you do not know your Username and Password.

DHCP  
 Static IP Client

IP address   
Subnet mask   
Default router   
Primary DNS   
Secondary DNS

Enable PPPoE  
User Name   
(e.g. 123456@hinet.net)  
Password

**Step 2: Setup DDNS Settings**

If you have a Dynamic DNS account and would like the camera to update your IP address automatically, enable DDNS and enter in your host information below. Please click on the Next button to continue.

Enable DDNS

Server Address  <<

Host Name   
User Name   
Password   
Verify Password   
Timeout  (hours)

**Step 3: Camera Name Settings**

D-Link recommends that you rename your camera for easy accessibility. You can then identify and connect to your camera via this name. Please assign a name of your choice before clicking on the Next button.

IP Camera Name

## Configuration

---

Configure the correct time to ensure that all events will be triggered as scheduled. Click **Next** to continue.

If you have selected DHCP, you will see a summary of your settings, including the camera's IP address. Please write down all of this information as you will need it in order to access your camera.

Click **Apply** to save your settings.

**Step 4: Setup Time Zone**

Please configure the correct time to ensure that all events are triggered, captured and scheduled at the correct time and day and then click on the Next button.

Time Zone

Enable Daylight Saving

**Step 5: Setup complete**

Below is a summary of your camera settings. Click on the Back button to review or modify settings or click on the Apply button if all settings are correct. It is recommended to note down these settings in order to access your camera on the network or via your web browser.

IP Address	DHCP
IP Camera Name	DCS-3710
Time Zone	(GMT+08:00) Taipei
DDNS	Disable
PPPoE	Disable

# Motion Detection Setup Wizard

This wizard will guide you through a step-by-step process to configure your camera's motion detection functions.

Click **Next** to continue.

## Step 1

This step will allow you to enable or disable motion detection, specify the detection sensitivity, and adjust the camera's ability to detect movement.

You may specify whether the camera should capture a snapshot or a video clip when motion is detected.

Please see the **Motion Detection** section on page 27 for information about how to configure motion detection.

## Step 2

This step allows you to enable motion detection based on a customized schedule. Specify the day and hours. You may also choose to always record motion.

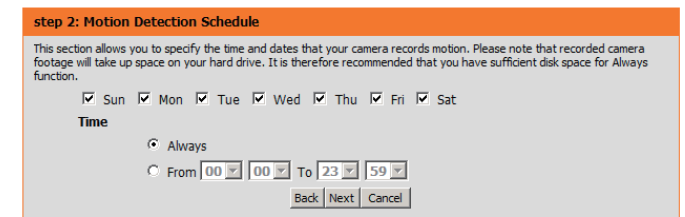
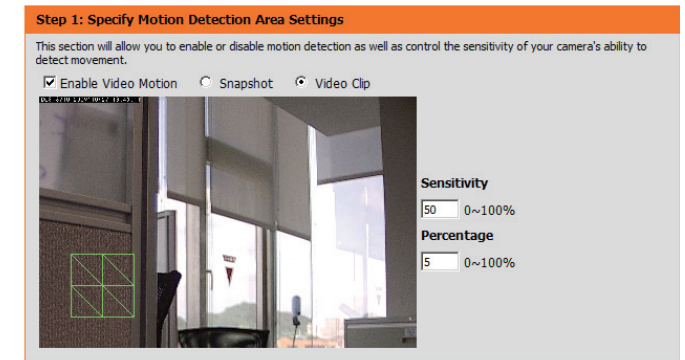
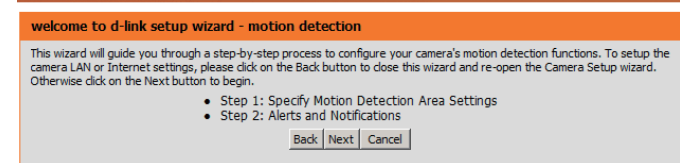



## Step 3

This step allows you to specify how you will receive event notifications from your camera. You may choose not to receive notifications, or to receive notifications via e-mail or FTP.

Please enter the relevant information for your e-mail or FTP account.

Click **Next** to continue.

**Step 3: Alerts and Notification**

This final step allows you to specify how you receive notification of camera events. Choose between an email notification or alternatively you can setup an FTP Notification. You will need your email account settings or FTP details. If you are unsure of this information, please contact your ISP. Once you have entered this information, please click on the Next button.

Do not notify me

Email

Sender email address

Recipient email address

Server address

User name

Password

Port

FTP

Server address

Port

User name

Password

Remote folder name

## Step 4

You have completed the Motion Detection Wizard.

Please verify your settings and click **Apply** to save them.

**Step 4: Setup Complete**

You have completed your camera setup. Please click the Back button if you want to review or modify your settings or click on the Apply button to save and apply your settings.

Motion Detection : Enable

EVENT : Video Clip

Schedule Day : Sun , Mon , Tue , Wed , Thu , Fri , Sat ,

Schedule Time : Always

Alerts and Notification : Email

Please wait a few moments while the camera saves your settings and restarts.

**Step 4: Setup Complete**

You have completed your camera setup. Please click the Back button if you want to review or modify your settings or click on the Apply button to save and apply your settings.

Changes saved.IP Camera's network is restarting, please wait for 3 seconds ...

# Network Setup

Use this section to configure the network connections for your camera. All relevant information must be entered accurately. After making any changes, click the **Save Settings** button to save your changes.

**LAN Settings:** This section lets you configure settings for your local area network.

**DHCP:** Select this connection if you have a DHCP server running on your network and would like your camera to obtain an IP address automatically.

**Static IP Address:** You may obtain a static or fixed IP address and other network information from your network administrator for your camera. A static IP address may simplify access to your camera in the future.

**IP Address:** Enter the fixed IP address in this field.

**Subnet Mask:** This number is used to determine if the destination is in the same subnet. The default value is 255.255.255.0.

**Default Gateway:** The gateway used to forward frames to destinations in a different subnet. Invalid gateway settings may cause the failure of transmissions to a different subnet.

**Primary DNS:** The primary domain name server translates names to IP addresses.

**Secondary DNS:** The secondary DNS acts as a backup to the primary DNS.

**Enable UPnP:** Enabling this setting allows your camera to be configured as a UPnP device on your network.

**Enable UPnP Port Forwarding:** Enabling this setting allows the camera to add port forwarding entries into the router automatically on a UPnP capable network.

**Enable PPPoE:** Enable this setting if your network uses PPPoE.

**User Name / Password:** Enter the username and password for your PPPoE account. Re-enter your password in the Confirm Password field. You may obtain this information from your ISP.

**HTTP Port:** The default port number is 80.

**Access Name for Stream 1~3:** The default name is video#.mjpg, where # is the number of the stream.

**HTTPS Port:** You may use a PC with a secure browser to connect to the HTTPS port of the camera. The default port number is 443.

**RTSP Port:** The port number that you use for RTSP streaming to mobile devices, such as mobile phones or PDAs. The default port number is 554. You may specify the address of a particular stream. For instance, live1.sdp can be accessed at rtsp://x.x.x.x/video1.sdp where the x.x.x.x represents the ip address of your camera.

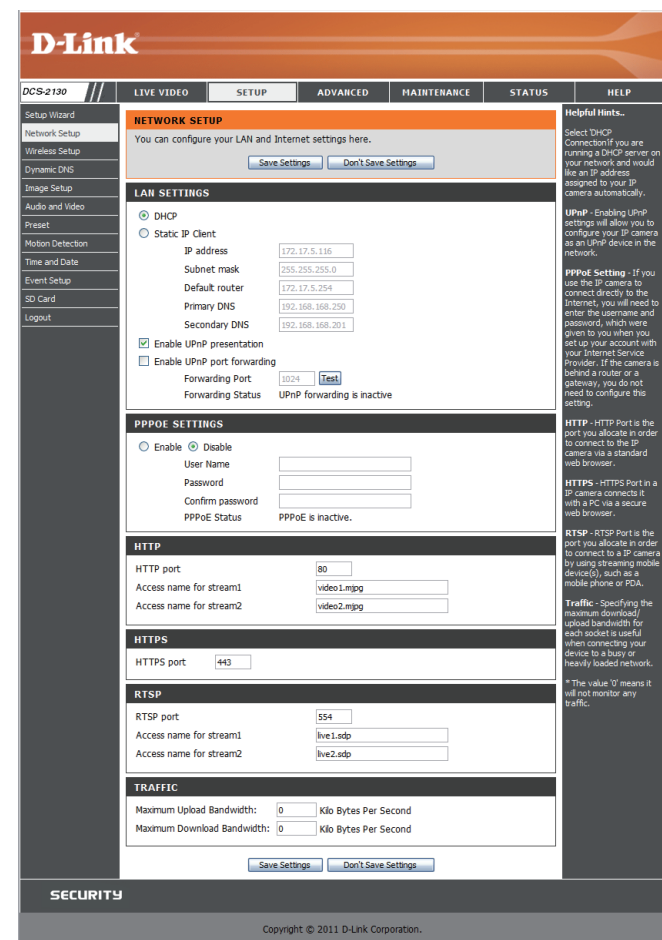

**Maximum Upload/Download Bandwidth:** Specifying the maximum download/upload bandwidth for each socket can be useful when connecting your device to a busy or heavily loaded network. Entering a value of '0' indicates that the camera should not monitor bandwidth. Specifying other values will limit the camera's transfer speed to the specified number of kilobytes per second.

The screenshot displays the D-Link DCS-2130 web interface. The main content area is titled 'NETWORK SETUP' and contains the following sections:

- LAN SETTINGS:** Includes DHCP (selected), Static IP Client (IP address: 172.17.5.116, Subnet mask: 255.255.255.0, Default router: 172.17.5.254, Primary DNS: 192.168.168.230, Secondary DNS: 192.168.168.201), and UPnP presentation (checked). UPnP port forwarding is inactive.
- PPPoE SETTINGS:** 'Enable' is selected, and PPPoE status is 'inactive'.
- HTTP:** HTTP port is 80. Access names for stream1 and stream2 are 'video1.mjpg' and 'video2.mjpg' respectively.
- HTTPS:** HTTPS port is 443.
- RTSP:** RTSP port is 554. Access names for stream1 and stream2 are 'live1.sdp' and 'live2.sdp' respectively.
- TRAFFIC:** Maximum Upload Bandwidth: 0 Kilo Bytes Per Second. Maximum Download Bandwidth: 0 Kilo Bytes Per Second.

The interface also features a 'Helpful Hints...' sidebar on the right with information about DHCP, UPnP, PPPoE, HTTP, HTTPS, RTSP, and Traffic settings.

# Wireless Setup

This section allows you to set up and configure the wireless settings on your camera. After making any changes, click the **Save Settings** button to save your changes.

**Site Survey:** Click the **Rescan** button to scan for available wireless networks. After scanning, you can use the dropdown box to select an available wireless network. The related information (SSID, Wireless Mode, Channel, Authentication, Encryption) will be automatically filled in for you.

**SSID:** Enter the SSID of the wireless access point you wish to use.

**Wireless Mode:** Use the dropdown box to select the mode of the wireless network you wish to connect to. Infrastructure is normally used to connect to an access point or router. Ad-Hoc is usually used to connect directly to another computer.

**Channel:** If you are using Ad Hoc mode, select the channel of the wireless network you wish to connect to, or select Auto.

**Authentication:** Select the authentication you use on your wireless network - Open, Shared, WPA-PSK, or WPA2-PSK.

**Encryption:** If you use WPA-PSK or WPA2-PSK authentication, you will need to specify whether your wireless network uses TKIP or AES encryption. If you use Open or Shared authentication, WEP encryption should be setting.

The screenshot shows the D-Link DCS-2130 Web Interface. The top navigation bar includes 'LIVE VIDEO', 'SETUP', 'ADVANCED', 'MAINTENANCE', 'STATUS', and 'HELP'. The 'SETUP' tab is selected, and the 'WIRELESS SETUP' sub-tab is active. The page title is 'WIRELESS SETUP' and it contains the text: 'In this section, you can setup and configure the wireless settings on your camera.' Below this are two buttons: 'Save Settings' and 'Don't Save Settings'.

The main configuration area is titled 'WIRELESS CONFIGURATION' and includes the following fields:

- Enable Wireless:
- Site Survey:  == SSID List ==
- SSID: default
- Wireless Mode: Infrastructure
- Channel: Auto
- Authentication: Open
- Encryption: WEP
- Default Key: 1
- Key 1: \*\*\*\*\*
- Key 2: \*\*\*\*\*
- Key 3: \*\*\*\*\*
- Key 4: \*\*\*\*\*

At the bottom of the configuration area are two buttons: 'Save Settings' and 'Don't Save Settings'.

On the right side of the interface, there is a 'Helpful Hints...' section with the following text:

You may choose which wireless network for the connection using the pull-down menu of Site Survey or enter the SSID manually.

**SSID** (Service Set Identifier) is the name of your wireless network, such as Default, Conference, My network, and etc.

**Authentication**

**Open** - This option makes the camera visible to all devices on the network. No encryption is provided.

**Shared** - Allows communication only with other devices that have the identical WEP (Wired Equivalent Privacy) settings.

**WPA-PSK, WPA2-PSK** - Both modes will require you to input a pre-shared key for the connection that is held between the camera and the wireless device.

**Key:** If you use WEP, WPA-PSK, or WPA2-PSK authentication, enter the Key (also known as password) used for your wireless network.

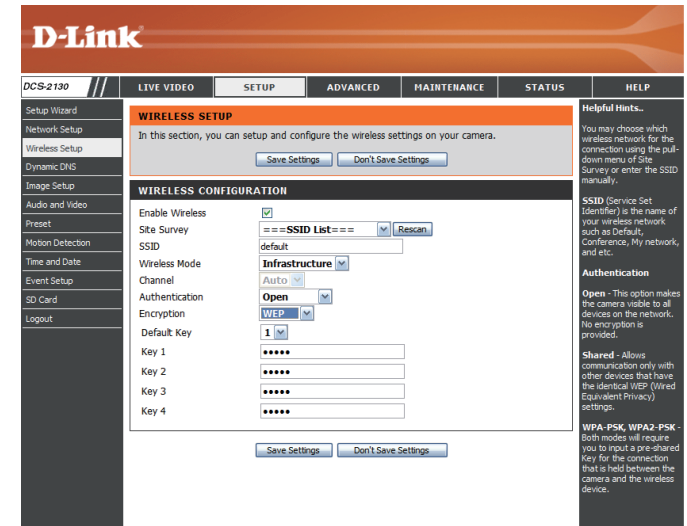

# Dynamic DNS

DDNS (Dynamic Domain Name Server) will hold a DNS host name and synchronize the public IP address of the modem when it has been modified. A user name and password are required when using the DDNS service. After making any changes, click the **Save Settings** button to save your changes.

**Enable DDNS:** Select this checkbox to enable the DDNS function.

**Server Address:** Select your Dynamic DNS provider from the pull down menu or enter the server address manually.

**Host Name:** Enter the host name of the DDNS server.

**User Name:** Enter the user name or e-mail used to connect to your DDNS account.

**Password:** Enter the password used to connect to your DDNS server account.

**Timeout:** Enter the DNS Timeout values you wish to use.

**Status:** Indicates the connection status, which is automatically determined by the system.

The screenshot shows the D-Link DCS-2130 web interface. The top navigation bar includes 'LIVE VIDEO', 'SETUP', 'ADVANCED', 'MAINTENANCE', 'STATUS', and 'HELP'. The left sidebar lists various setup options: Setup Wizard, Network Setup, Wireless Setup, Dynamic DNS (selected), Image Setup, Audio and Video, Preset, Motion Detection, Time and Date, Event Setup, SD Card, and Logout. The main content area is titled 'DYNAMIC DNS' and contains the following information:

**DYNAMIC DNS**

The Dynamic DNS feature allows you to use a domain name that you have purchased (www.yourdomain.com) to access your IP camera with a dynamically assigned IP address. Most broadband Internet service providers assign dynamic (changing) IP addresses. By using a DDNS service, you can enter your domain name to connect to your IP camera no matter what your IP address is.

Sign up for D-Link's Free DDNS service at [www.DLinkDDNS.com](http://www.DLinkDDNS.com).

Buttons: Save Settings, Don't Save Settings

---

**DYNAMIC DNS SETTING**

Enable DDNS:

Server Address:  <<  >>

Host Name:

User Name:

Password:

Verify Password:

Timeout:  (hours)

Status: Active

Buttons: Save Settings, Don't Save Settings

**Helpful Hints...**

Dynamic DNS is useful if you have a DSL or Cable service provider that changes your modem IP address periodically. This will allow you to assign a website domain name to your IP camera instead of connecting through an IP address.

# Image Setup

In this section, you may configure the video image settings for your camera. A preview of the image will be shown in Live Video.

**Enable Privacy Mask:** The Privacy Mask setting allows you to specify up to 3 rectangular areas on the camera's image to be blocked/excluded from recordings and snapshots.

You may click and drag the mouse cursor over the camera image to draw a mask area.

Right clicking on the camera image brings up the following menu options:

**Disable All:** Disables all mask areas

**Enable All:** Enables all mask areas

**Reset All:** Clears all mask areas.

**Anti Flicker:** If the video flickers, try enabling this setting.

**Mirror:** This will mirror the image horizontally.

**Flip:** This will flip the image vertically. When turning Flip on, you may want to consider turning Mirror on as well.

**Power Line:** Select the frequency used by your power lines to avoid interference or distortion.

**White Balance:** Use the dropdown box to change white balance settings to help balance colors for different environments. You can choose from Auto, Outdoor, Indoor, Fluorescent, and Push Hold.

The screenshot shows the D-Link DCS-2130 web interface. The top navigation bar includes 'LIVE VIDEO', 'SETUP', 'ADVANCED', 'MAINTENANCE', 'STATUS', and 'HELP'. The 'SETUP' tab is selected, and the 'IMAGE SETUP' sub-tab is active. The main content area displays the 'LIVE VIDEO' section with a checkbox for 'Enable Privacy Mask Setting' and a live video feed. Below the feed is the 'IMAGE SETTINGS' section with various controls: Anti Flicker (On/Off), Mirror (On/Off), Flip (On/Off), Power Line (60 Hz/50 Hz), White Balance (Auto), Exposure Mode (Auto), Denoise (0), Brightness (4), Contrast (4), Saturation (128), and Sharpness (4). A 'Reset Default' button is located at the bottom of the settings section. The right sidebar contains 'Helpful Hints' for Privacy Mask, Anti Flicker, Mirror, Flip, and Power Line.



**Exposure Mode:** Changes the exposure mode. Use the dropdown box to set the camera for Indoor, Outdoor, or Night environments, or to Moving to capture moving objects. The Low\_Noise option will focus on creating a high-quality picture without noise. You can also create 3 different custom exposure modes. The Max Gain setting will allow you to control the maximum amount of gain to apply to brighten the picture.

**Denoise:** This setting controls the amount of noise reduction that will be applied to the picture.

**Brightness:** Adjust this setting to compensate for backlit subjects.

**Contrast:** Adjust this setting to alter the color intensity/strength.

**Saturation:** This setting controls the amount of coloration, from grayscale to fully saturated.

**Sharpness:** Specify a value from 0 to 8 to specify how much sharpening to apply to the image.

**Reset Default:** Click this button to reset the image to factory default settings.



# Audio and Video

You may configure up to 3 video profiles with different settings for your camera. Hence, you may set up different profiles for your computer and mobile display. In addition, you may also configure the two-way audio settings for your camera. After making any changes, click the **Save Settings** button to save your changes.

**Number of active profiles:** You can use the dropdown box to set up to 3 active profiles.

**Aspect ratio:** Set the aspect ratio of the video to 4:3 standard or 16:9 widescreen.

**Mode:** Set the video codec to be used to JPEG, MPEG-4, or H.264.

**Frame size / View window area:** Frame size determines the total capture resolution, and View window area determines the Live Video viewing window size. If the Frame size is larger than the Live Video size, you can use the ePTZ controls to look around.

16:9	1280 x 800, 1280 x 720, 800 x 450, 640 x 360, 480 x 270, 320 x 176, 176 x 144
4:3	1024 x 768, 800 x 600, 640 x 480, 480 x 360, 320 x 240, 176 x 144

**Note:** If your View window area is the same as your Frame size, you will not be able to use the ePTZ function.

**Maximum frame rate:** A higher frame rate provides smoother motion for videos, and requires more bandwidth. Lower frame rates will result in stuttering motion, and requires less bandwidth.



**Video Quality:** This limits the maximum frame rate, which can be combined with the "Fixed quality" option to optimize the bandwidth utilization and video quality. If fixed bandwidth utilization is desired regardless of the video quality, choose "Constant bit rate" and select the desired bandwidth.

**Constant bit rate:** The bps will affect the bit rate of the video recorded by the camera. Higher bit rates result in higher video quality.

**Fixed quality:** Select the image quality level for the camera to try to maintain. High quality levels will result in increased bit rates.

**Audio in off:** Ticking this checkbox will mute incoming audio.

**Audio in gain level:** This setting controls the amount of gain applied to incoming audio to increase its volume.

**Audio out off:** Ticking this checkbox will mute outgoing audio.

**Audio out volume level:** This setting controls the amount of gain applied to outgoing audio to increase its volume.



# Preset

This screen allows you to set preset points for the ePTZ function of the camera, which allows you to look around the camera's viewable area by using a zoomed view. Presets allow you to quickly go to and view a specific part of the area your camera is covering, and you can create preset sequences, which will automatically change the camera's view between the different presets according to a defined order and timing you can set.

**Note:** If your View window area is the same as your Frame size, you will not be able to use the ePTZ function. For more details, refer to "Audio and Video" on page 26.

**Video Profile:** This selects which video profile to use. For more information, refer to "Audio and Video" on page 26.

**ePTZ Speed:** You may select a value between 0 and 64. 0 is the slowest and 64 is the fastest.

**Arrow Buttons and Home Button:** Use these buttons to move to a specific part of the viewing area, which you can then set as a preset. Click the Home button to return to the center of the viewing area.

**Input Preset Name:** Enter the name of the preset you want to create, then click the **Add** button to make a new preset. If an existing preset has been selected from the Preset List, you can change its name by typing in a new name, then clicking the **Rename** button.

**Preset List:** Click this dropdown box to see a list of all the presets that have been created. You can select one, then click the **GoTo** button to change the displayed camera view to the preset. Clicking the **Remove** button will delete the currently selected preset.



**Preset Sequence:** This section allows you to create a preset sequence, which automatically moves the camera's view between a set of preset views.

To add a preset to the sequence, select it from the dropdown box at the bottom of this window, set the **Dwell time** to determine how long the camera view will stay at that preset, then click the **Add** button. The preset name will appear in the list, followed by the dwell time to view that preset for.

You can rearrange your presets in the sequence by selecting a preset in the sequence, then clicking the arrow buttons to move it higher or lower in the current sequence.

Clicking the trash can button will remove the currently selected preset from the sequence.

If you want to change the dwell time for a preset, select it from the list, enter a new dwell time, then click the **Update** button.

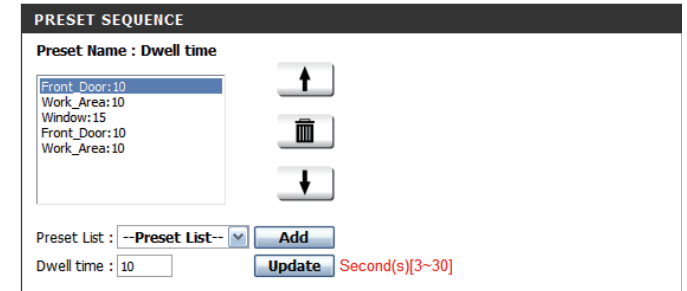

# Motion Detection

Enabling Video Motion will allow your camera to use the motion detection feature. You may draw a finite motion area that will be used for monitoring. After making any changes, click the **Save Settings** button to save your changes.

**Enable Video Motion:** Select this box to enable the motion detection feature of your camera.

**Sensitivity:** Specifies the measurable difference between two sequential images that would indicate motion. Please enter a value between 0 and 100.

**Percentage:** Specifies the amount of motion in the window being monitored that is required to initiate an alert. If this is set to 100%, motion is detected within the whole window will trigger a snapshot.

**Draw Motion Area:** Draw the motion detection area by dragging your mouse in the window (indicated by the red square).

**Erase Motion Area:** To erase a motion detection area, simply click on the red square that you wish to remove.

Right clicking on the camera image brings up the following menu options:

**Select All:** Draws a motion detection area over the entire screen.

**Clear All:** Clears any motion detection areas that have been drawn.

**Restore:** Restores the previously specified motion detection areas.

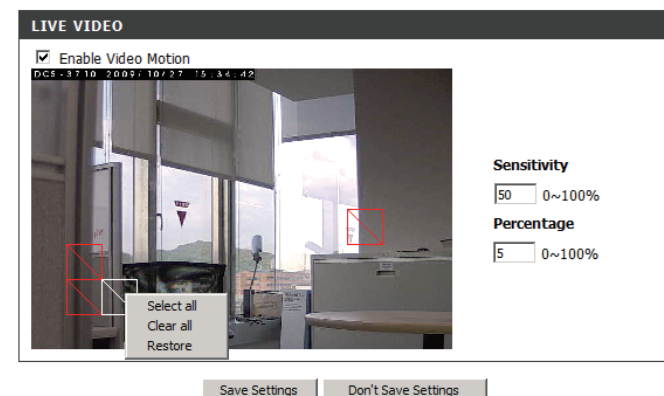
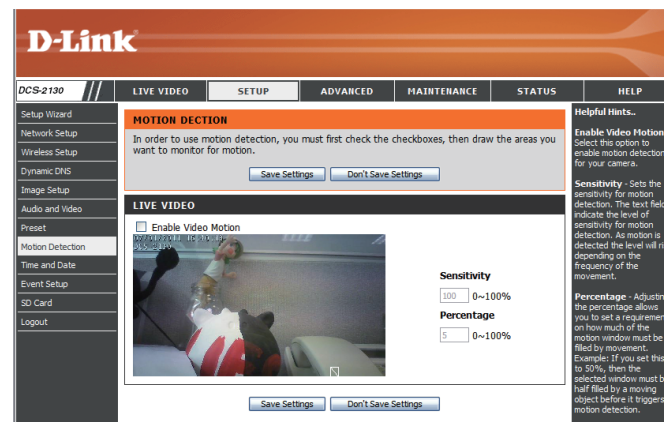

# Time and Date

This section allows you to automatically or manually configure, update, and maintain the internal system clock for your camera. After making any changes, click the **Save Settings** button to save your changes.

**Time Zone:** Select your time zone from the drop-down menu.

**Enable Daylight Saving:** Select this to enable Daylight Saving Time.

**Auto Daylight Saving:** Select this option to allow your camera to configure the Daylight Saving settings automatically.

**Set Date and Time Manually:** Selecting this option allows you to configure the Daylight Saving date and time manually.

**Offset:** Sets the amount of time to be added or removed when Daylight Saving is enabled.

**Synchronize with NTP Server:** Enable this feature to obtain time automatically from an NTP server.

**NTP Server:** Network Time Protocol (NTP) synchronizes the DCS-2130 with an Internet time server. Choose the one that is closest to your location.

**Set the Date and Time Manually:** This option allows you to set the time and date manually.

**Copy Your Computer's Time Settings:** This will synchronize the time information from your PC.



# Event Setup

The Event Setup page includes 4 different sections.

- Event
- Server
- Media
- Recording

1. To add a new item - "event, server or media," click **Add**. A screen will appear and allow you to update the fields accordingly.
2. To delete the selected item from the pull-down menu of event, server or media, click **Delete**.
3. Click on the item name to pop up a window for modifying.

**Note:** You can add up to four events, five servers, and five media fields.

**D-Link**

DCS-2130 // LIVE VIDEO SETUP ADVANCED MAINTENANCE STATUS HELP

**EVENT SETUP**

There are four sections in Event Setup page. They are event, server, media and recording. Click Add to pop a window to add a new item of event, server, media or recording. Click Delete to delete the selected item from event, server, media or recording. Click on the item name to pop a window to edit it. There can be at most 2 events and 1 recording. There can be at most 5 server and 5 media configurations.

**Helpful Hints...**

Suggest setting server and media first before setting event. The servers and media which selected in event list are not be able to modify or delete. Please remove them first from the event if you want to delete or modify them. Recommend using different media in different event to make use all media be produced and received correctly. If using the same media in different events and the events trigger almost simultaneously, the servers in the second triggered event will not receive any media, there would be only notifications.

**SERVER**

Name	Type	Address/Location
Add <input type="button" value="v"/> Delete		

**MEDIA**

Media freespace: 6700KB

Name	Type	Source
Add <input type="button" value="v"/> Delete		

**EVENT**

Name	Status	Sun	Mon	Tue	Wed	Thu	Fri	Sat	Time	Trigger
Add <input type="button" value="v"/> Delete										

**RECORDING**

Name	Status	Sun	Mon	Tue	Wed	Thu	Fri	Sat	Time	Source	Destination
Add <input type="button" value="v"/> Delete											



# Application

In a typical application, when motion is detected, the DCS-2130 Network Camera sends images to a FTP server or via e-mail as notifications. As shown in the illustration below, an event can be triggered by many sources, such as motion detection or external digital input devices. When an event is triggered, a specified action will be performed. You can configure the Network Camera to send snapshots or videos to your e-mail address or FTP site.

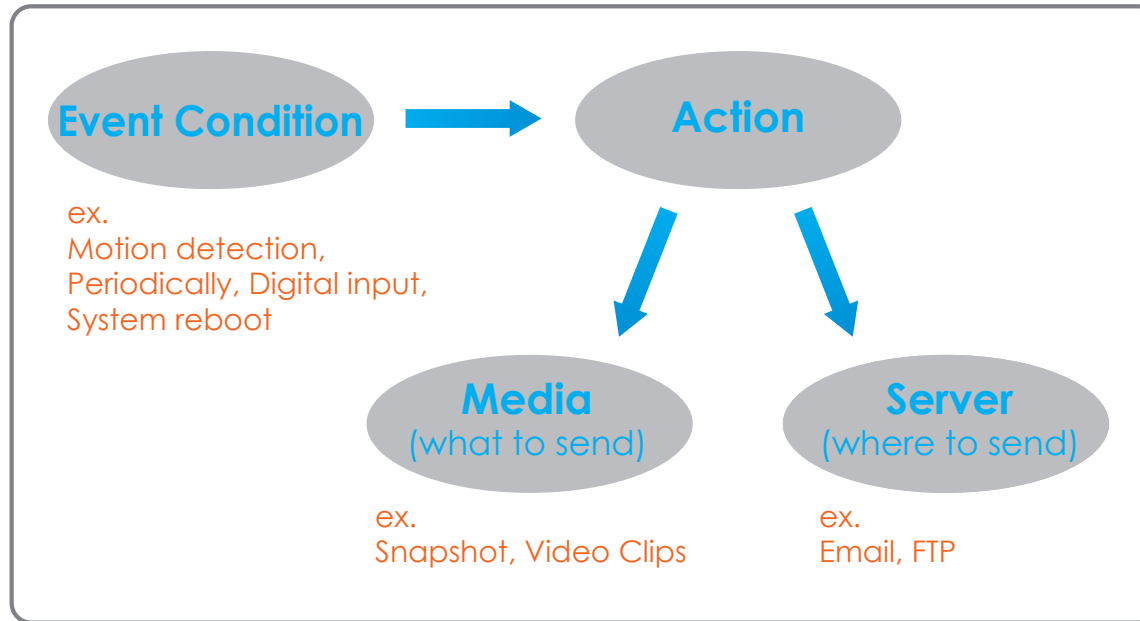

To start plotting an event, it is suggested to configure server and media columns first so that the Network Camera will know what action shall be performed when a trigger is activated.

# Add Server

You can configure up to 5 servers to save snapshots and/or video to. After making any changes, click the **Save Settings** button to save your changes.

**Server Name:** Enter the unique name of your server.

**E-mail:** Enter the configuration for the target e-mail server account.

**FTP:** Enter the configuration for the target FTP server account.

**Network Storage:** Specify a network storage device. Only one network storage device is supported.

**SD Card:** Use the camera's onboard SD card storage.

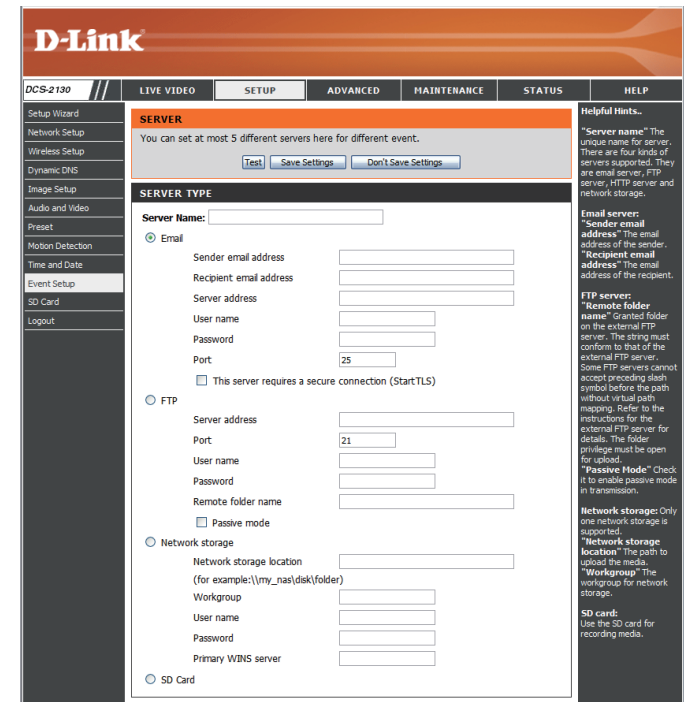

# Add Media

There are three types of media, **Snapshot**, **Video Clip**, and **System Log**. After making any changes, click the **Save Settings** button to save your changes.

**Media Name:** Enter an unique name for media type you want to create.

**Snapshot:** Select this option to set the media type to snapshots.

**Source:** Set the video profile to use as the media source. Refer to "Audio and Video" on page 26 for more information on video profiles.

**Send pre-event image(s) [0~4]:** Set the number of pre-event images to take. Pre-event images are images taken before the main event snapshot is taken.

**Send post-event image(s) [0~7]:** Set the number of post-event images to take. Post-event images are images taken after the main event snapshot is taken. You can set up to 7 post-event images to be taken.

**File name prefix:** The prefix name will be added on the file name.

**Add date and time suffix to file name:** Check it to add timing information as file name suffix.

**D-Link**

DCS-2130 // LIVE VIDEO SETUP ADVANCED MAINTENANCE STATUS HELP

Setup Wizard  
Network Setup  
Wireless Setup  
Dynamic DNS  
Image Setup  
Audio and Video  
Preset  
Motion Detection  
Time and Date  
Event Setup  
SD Card  
Logout

**MEDIA**

You can set at most 5 different media here for different event.

Save Settings Don't Save Settings

**MEDIA TYPE**

Media name:

Snapshot

Source:  [New](#)

Send  pre-event image(s) [0~4]

Send  post-event image(s) [0~7]

File Name Prefix:

Add date and time suffix to file name

Video Clip

Source:  [New](#)

Pre-event recording:  Second(s) [0~4]

Maximum duration:  Second(s) [1~100]

Maximum file size:  Kbytes [100~3000]

File Name Prefix:

System log

File Name Prefix:

Save Settings Don't Save Settings

**Helpful Hints...**

"Media name" The unique name for media. There are three kinds of media. They are snapshot, video clip and system log.

"Source" The source of profile, profile 1 or profile 2.

"Send Pre-event images" The number of pre-event images.

"Send Post-event images" The number of post-event images.

"File name prefix" The prefix name will be added on the file name of the snapshot images.

"Add date and time suffix to file name" Check it to add timing information as file name suffix.

"Video clip recording" The interval of pre-event recording in seconds. There are two limitations for video clip file.

"Pre-event recording" The interval of pre-event recording in seconds. There are two limitations for video clip file.

"Maximum duration" The maximal recording file duration in seconds.

"Maximum file size" The maximal recording file duration in seconds.

**Video clip:** Select this option to set the media type to video clips.

**Source:** Set the video profile to use as the media source. Refer to "Audio and Video" on page 26 for more information on video profiles.

**Pre-event recording:** This sets how many seconds to record before the main event video clip starts. You can record up to 4 seconds of pre-event video.

**Maximum duration:** Set the maximum length of video to record for your video clips.

**Maximum file size:** Set the maximum file size to record for your video clips.

**File name prefix:** This is the prefix that will be added to the filename of saved video clips.

**System log:** Select this option to set the media type to system logs. This will save the event to the camera system log, but will not record any snapshots or video.

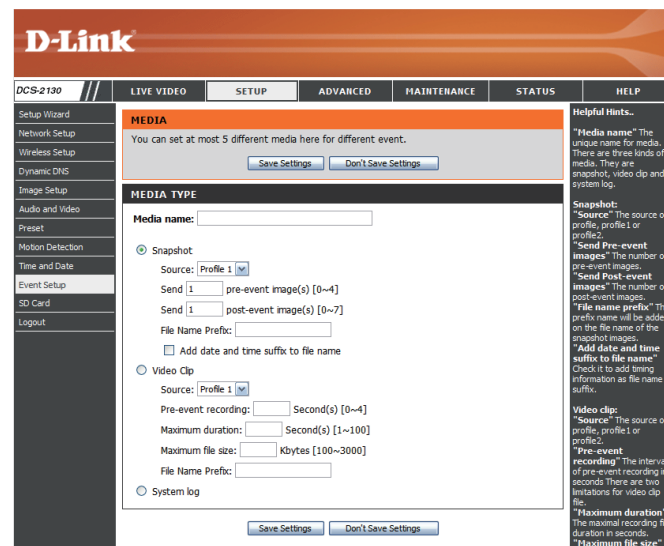

# Add Event

Create and schedule up to 3 events with their own settings here. After making any changes, click the **Save Settings** button to save your changes.

**Event name:** Enter a name for the event.

**Enable this event:** Select this box to activate this event.

**Priority:** Set the priority for this event. The event with higher priority will be executed first.

**Delay:** Select the delay time before checking the next event. It is being used for both events of motion detection and digital input trigger.

**Trigger:** Specify the input type that triggers the event.

**Video Motion Detection:** Motion is detected during live video monitoring. Select the windows that need to be monitored.

**Periodic:** The event is triggered in specified intervals. The trigger interval unit is in minutes.

**Digital input:** The external trigger input to the camera.

**System Boot:** Triggers an event when the system boots up.

**Network Lost:** Triggers an event when if the network connection is lost.

**D-Link**

DCS-2130 // LIVE VIDEO SETUP ADVANCED MAINTENANCE STATUS HELP

**EVENT**

You can set at most 2 events like motion detection or digital input trigger here and arrange the detection schedule at the same time.

Save Settings Don't Save Settings

**EVENT**

Event name:

Enable this event

Priority: normal

Delay for 10 seconds before detecting next event [For motion detection and digital input]

**TRIGGER**

Video motion detection

Periodic

Trigger every 1 minutes

Digital input

System boot

Network lost

**EVENT SCHEDULE**

Sun  Mon  Tue  Wed  Thu  Fri  Sat

Time

Always

From 00:00 To 23:59

**ACTION**

Trigger D/O for 1 seconds

Save Settings Don't Save Settings

**Helpful Hints..**

**Priority:** The event with higher priority will be executed first.

**Delay second(s) before detecting next event:** The delay to check next event. It is used in motion detection and digital input trigger type.

There are five kinds of trigger supported.

**Video motion detection:** select the windows which need to be monitored.

**Periodic:** The event is triggered in specified intervals. The unit of trigger interval is minute.

**Digital input:** The event is triggered when the DI status changed by external device.

**System boot:** The event is triggered when the system boot up.

**Network lost:** The event is triggered when the network service is not available or disconnection.

**Sun ~ Sat:** Select the days of the week to perform the event.

**Time:** show "Always" or input the time interval.

The default action are triggering DO and storing media on SD card. If there are servers configured, the user can select them from "Server".

**Time:** Select **Always** or enter the time interval.

**Trigger D/O:** Select to trigger the digital output for a specific number of seconds when an event occurs.

**Server:** Specify the location where the event information should be saved to.

**D-Link**

DCS-2130 // LIVE VIDEO SETUP ADVANCED MAINTENANCE STATUS HELP

**EVENT**

You can set at most 2 events like motion detection or digital input trigger here and arrange the detection schedule at the same time.

**EVENT**

Event name:

Enable this event

Priority:

Delay for  seconds before detecting next event [For motion detection and digital input]

**TRIGGER**

Video motion detection

Periodic  
Trigger every  minutes

Digital input

System boot

Network lost

**EVENT SCHEDULE**

Sun  Mon  Tue  Wed  Thu  Fri  Sat

Time

Always

From   To

**ACTION**

Trigger D/O for  seconds

**Helpful Hints...**

**Priority:** The event with higher priority will be executed first.

**Delay second(s) before detecting next event:** The delay to check next event. It is used in motion detection and digital input trigger type.

There are five kinds of trigger supported.

**Video motion detection:** select the windows which need to be monitored.

**Periodic:** The event is triggered in specified intervals. The unit of trigger interval is minute.

**Digital input:** The event is triggered when the DI status changed by external device.

**System boot:** The event is triggered when the system boot up.

**Network lost:** The event is triggered when the network service is not available or disconnection.

**Sun ~ Sat:** Select the days of the week to perform the event.

Time: show "Always" or input the time interval.

The default action are triggering DO and storing media on SD card. If there are servers configured, the user can select them from 'Server'.

# Add Recording

Here you can configure and schedule the recording settings. After making any changes, click the **Save Settings** button to save your changes.

**Recording entry name:** The unique name of the entry.

**Enable this recording:** Select this to enable the recording function.

**Priority:** Set the priority for this entry. The entry with a higher priority value will be executed first.

**Source:** The source of the stream.

**Recording schedule:** Scheduling the recording entry.

**Recording settings:** Configuring the setting for the recording.

**Destination:** Select the folder where the recording file will be stored.

**Total cycling recording size:** Please input a HDD volume between 1MB and 200GB for recording space. The recording data will replace the oldest record when the total recording size exceeds this value. For example, if each recording file is 6MB, and the total cyclic recording size is 600MB, then the camera will record 100 files in the specified location (folder) and then will delete the oldest file and create new file for cyclic recording.

Please note that if the free HDD space is not enough, the recording will stop. Before you set up this option please make sure your HDD has enough space, and it is better to not save other files in the same folder as recording files.

**Size of each file for recording:** File size for each recording file. You may input the value in the range of 200-5000.

**File Name Prefix:** The prefix name will be added on the file name of the recording file(s).

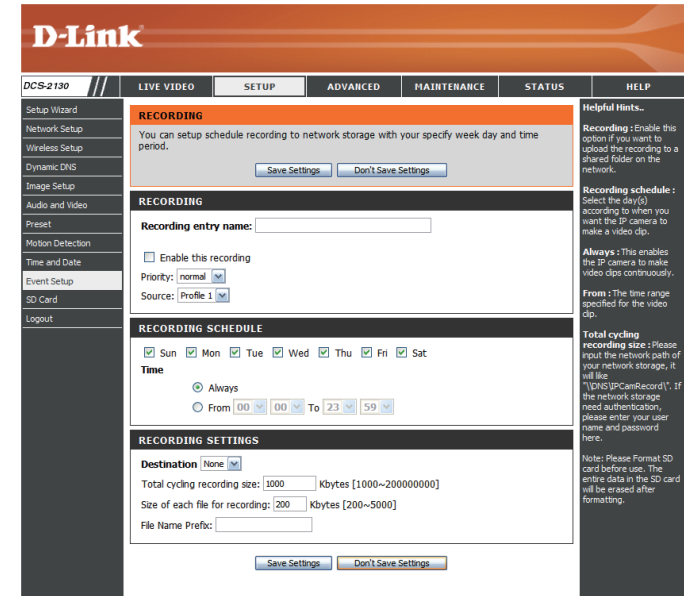



# SD Card

Here you may browse and manage the recorded files which are stored on the SD card.

**Format SD Card:** Click this icon to automatically format the SD card and create "picture" & "video" folders.

**View Recorded Picture:** If the picture files are stored on the SD card, click on the picture folder and choose the picture file you would like to view.

**Playback Recorded Video:** If video files are stored on the SD card, click on the video folder and choose the video file you would like to view.

**Refresh:** Reloads the file and folder information from the SD card.

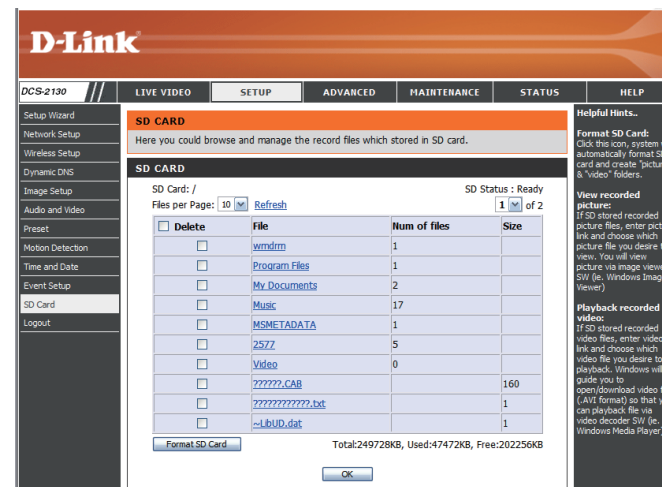

# Advanced

## Digital Input/Output

This screen allows you to control the behavior of digital input and digital output devices. The I/O connector provides the physical interface for digital output (DO) and digital input (DI) that is used for connecting a variety of external alarm devices such as IR-Sensors and alarm relays. The digital input is used for connecting external alarm devices and once triggered images will be taken and e-mailed. After making any changes, click the **Save Settings** button to save your changes.

**Select DI or D/O Mode:** The camera will send a signal when an event is triggered, depending upon the type of device connected to the DI circuit.

N.C. stands for **Normally Closed**. This means that the normal state of the circuit is closed. Therefore events are triggered when the device status changes to "Open."

N.O. stands for **Normally Open**. This means that the normal state of the circuit is open. Therefore events are triggered when the device status changes to "Closed."

**LED:** You may specify whether or not to illuminate the LED on the side of the camera.

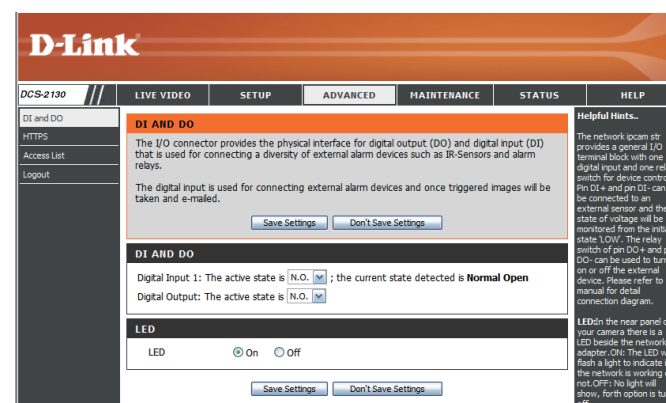

# HTTPS

This page allows you to install and activate an HTTPS certificate for secure access to your camera. After making any changes, click the **Save Settings** button to save your changes.

**Enable HTTPS Secure Connection:** Enable the HTTPS service.

**Create Certificate Method:** Choose the way the certificate should be created. Three options are available:

- Create a self-signed certificate automatically
- Create a self-signed certificate manually
- Create a certificate request and install

**Status:** Displays the status of the certificate.

**Note:** The certificate cannot be removed while the HTTPS is still enabled. To remove the certificate, you must first uncheck **Enable HTTPS secure connection**.

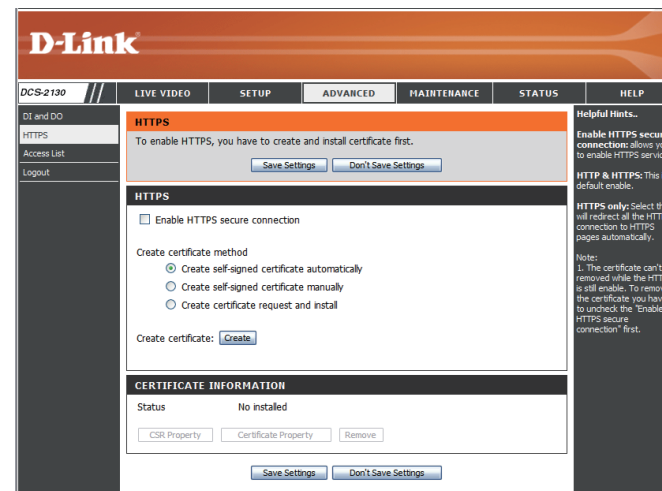

# Access List

Here you can set access permissions for users to view your DCS-2130.

**Allow list:** The list of IP addresses that have the access right to the camera.

**Start IP address:** The starting IP Address of the devices (such as a computer) that have permission to access the video of the camera. Click Add to save the changes made.

**Note:** A total of seven lists can be configured for both columns.

**End IP address:** The ending IP Address of the devices (such as a computer) that have permission to access the video of the camera.

**Delete allow list:** Remove the customized setting from the Allow List.

**Deny list:** The list of IP addresses that have no access rights to the camera.

**Delete deny list:** Remove the customized setting from the Delete List.

**For example:**

When the range of the Allowed List is set from 1.1.1.0 to 192.255.255.255 and the range of the Denied List is set from 1.1.1.0 to 170.255.255.255. Only users with IPs located between 171.0.0.0 and 192.255.255.255 can access the Network Camera.

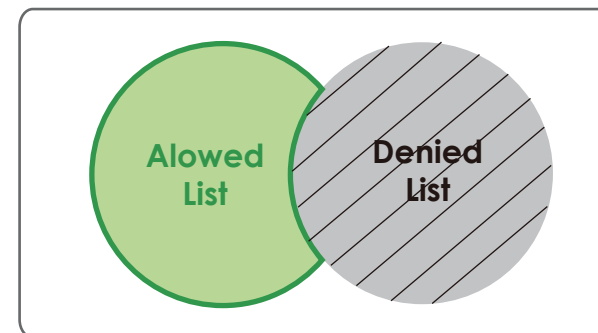
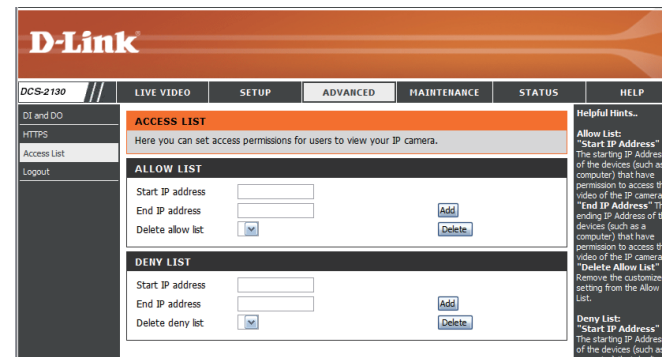

# Maintenance

## Device Management

You may modify the name and administrator's password of your camera, as well as add and manage the user accounts for accessing the camera. You may also use this section to create a unique name and configure the OSD settings for your camera.

**Admin Password Setting:** Set a new password for the administrator's account.

**Add User Account:** Add new user account.

**User Name:** The user name for the new account.

**Password:** The password for the new account.

**User List:** All the existing user accounts will be displayed here. You may delete accounts included in the list, but please reserve at least one as guest.

**Camera Name:** Create a unique name for your camera that will be added to the file name prefix when creating a snapshot or a video clip.

**Enable OSD:** Select this option to enable the On-Screen Display feature for your camera.

**Label:** Enter a label for the camera.

**Show Time:** Select this option to enable the time-stamp display on the video screen.

**D-Link**

DCS-2130 // LIVE VIDEO SETUP ADVANCED MAINTENANCE STATUS HELP

Admin  
System  
Firmware Upgrade  
Logout

**ADMIN**  
Here you can change the administrator's password for your IP camera as well as add and/or delete user account(s). You can configure the information, such as IP camera's name and time via this page. You can also enable the OSD (On-Screen Display) feature in order to display the IP camera name and time stamp for your video recordings.

**ADMIN PASSWORD SETTING**  
New Password  63 characters maximum  
Retype Password  Save

**ADD USER ACCOUNT**  
User Name  20 users maximum  
New Password  63 characters maximum  
Retype Password   
Add

**USER LIST**  
User Name  -- User list -- Add Delete

**DEVICE SETTING**  
IP camera Name  DCS-2130 63 characters maximum  
 Enable OSD  
Label  DCS-2130 63 characters maximum  
Show time   
Save

**Helpful Hints...**  
Enabling OSD, the IP camera name and time will be displayed on the video screen for the user.  
For security purposes, it is recommended that you change the password for your administrator account. Be sure to write down the new password to avoid having to reset the IP camera in the event that it is forgotten.

# Backup and Restore

In this section, you may backup, restore and reset the camera configuration, or reboot the camera.

**Save To Local Hard Drive:** You may save and document your current settings into your computer.

**Local From Local Hard Drive:** Locate a pre-saved configuration by clicking **Browse** and then restore the pre-defined settings to your camera by clicking **Load Configuration**.

**Restore to Factory Default:** You may reset your camera and restore the factory settings by clicking **Restore Factory Defaults**.

**Reboot Device:** This will restart your camera.

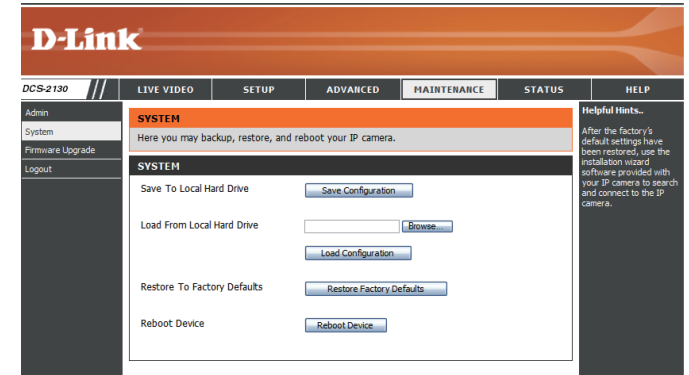

# Firmware Upgrade

The camera's current firmware version will be displayed on this screen. You may visit the D-Link Support Website to check for the latest available firmware version.

To upgrade the firmware on your DCS-2130, please download and save the latest firmware version from the D-Link Support Page to your local hard drive. Locate the file on your local hard drive by clicking the **Browse** button. Select the file and click the **Upload** button to start upgrading the firmware.

**Current Firmware Version:** Displays the detected firmware version.

**Current Product Name:** Displays the camera model name.

**File Path:** Locate the file (upgraded firmware) on your hard drive by clicking **Browse**.

**Upload:** Uploads the new firmware to your camera.

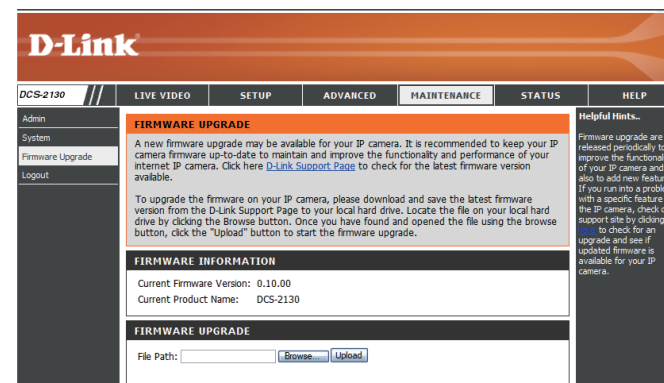

# Status

## Device Info

This page displays detailed information about your device and network connection.

The screenshot shows the D-Link web interface for the DCS-2130 device. The top navigation bar includes 'DCS-2130', 'LIVE VIDEO', 'SETUP', 'ADVANCED', 'MAINTENANCE', 'STATUS', and 'HELP'. The 'STATUS' tab is selected. On the left, a sidebar contains 'Device Info', 'Log', and 'Logout'. The main content area features a 'DEVICE INFO' header with a sub-header 'INFORMATION' and a table of network details. A 'Helpful Hints..' section on the right explains that the page displays IP camera and network settings information.

INFORMATION	
IP camera Name	DCS-2130
Time & Date	Fri Jan 7 16:48:32 2011
Firmware Version	0.10.00
MAC Address	AA:BB:CC:11:22:33
IP Address	172.17.5.116
IP Subnet Mask	255.255.255.0
Default Gateway	172.17.5.254
Primary DNS	192.168.168.250
Secondary DNS	192.168.168.201
PPPoE	Disable
DDNS	Disable



# Logs

This page displays the log information of your camera. You may download the information by clicking **Download**. You may also click **Clear** to delete the saved log information.

The screenshot shows the D-Link web interface for the DCS-2130 camera. The top navigation bar includes 'LIVE VIDEO', 'SETUP', 'ADVANCED', 'MAINTENANCE', 'STATUS', and 'HELP'. The left sidebar has 'Device Info', 'Log', and 'Logout' options, with 'Log' currently selected. The main content area is titled 'SYSTEM LOG' and contains a description: 'The system log records IP camera events that have occurred.' Below this is a 'CURRENT LOG' section listing 20 entries of system events, including login attempts, DHCP acquisitions, and system booting. At the bottom of the log list are navigation buttons: 'First Page', 'Previous 20', 'Next 20', 'Clear', and 'Download'. On the right side, there is a 'Helpful Hints..' section with text explaining how to save and clear the log.

# Help

This page provides helpful information regarding camera operation.

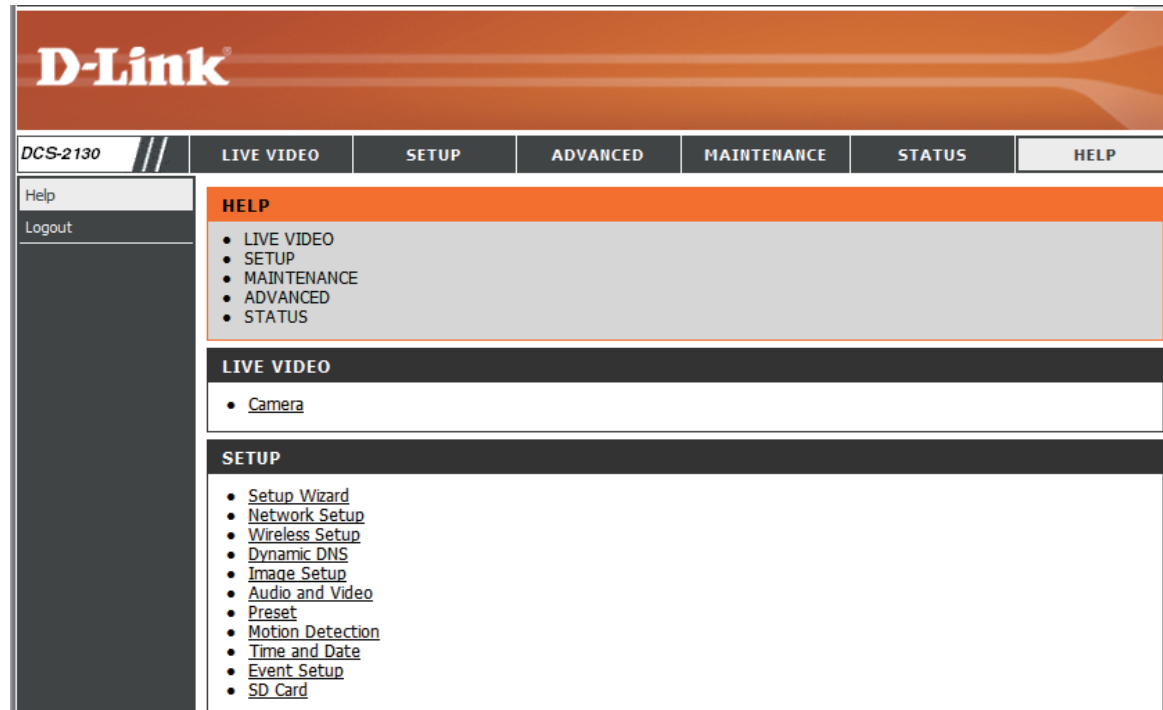

**D-Link**

DCS-2130 // LIVE VIDEO SETUP ADVANCED MAINTENANCE STATUS HELP

Help  
Logout

**HELP**

- [LIVE VIDEO](#)
- [SETUP](#)
- [MAINTENANCE](#)
- [ADVANCED](#)
- [STATUS](#)

**LIVE VIDEO**

- [Camera](#)

**SETUP**

- [Setup Wizard](#)
- [Network Setup](#)
- [Wireless Setup](#)
- [Dynamic DNS](#)
- [Image Setup](#)
- [Audio and Video](#)
- [Preset](#)
- [Motion Detection](#)
- [Time and Date](#)
- [Event Setup](#)
- [SD Card](#)

# DI/DO Input Specifications

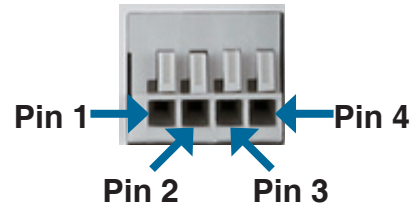

PIN	FUNCTION	NOTE
1	Digital Out (DO)	Uses an open-drain NFET transistor with the source connected to GND in camera. If used with an external relay, a diode must be connected in parallel with the load for protection against voltage transients. Max loading is 100 mA.
2	Digital In (DI)	A switch from DI to DC 5 V, activated by setting NO. or NC.
3	DC5V OUTPUT	DC 5 V Output / Max. 100 mA
4	GND	GND

## Internal 5V Power

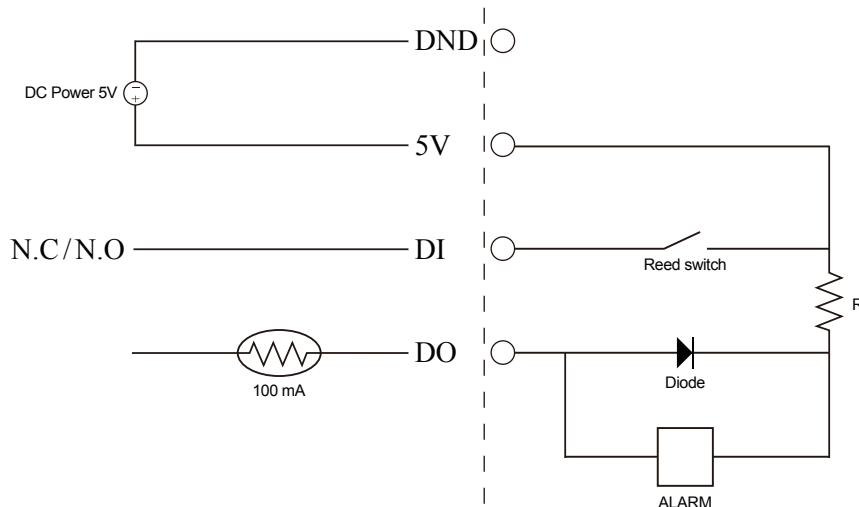

## External 3~12V Power

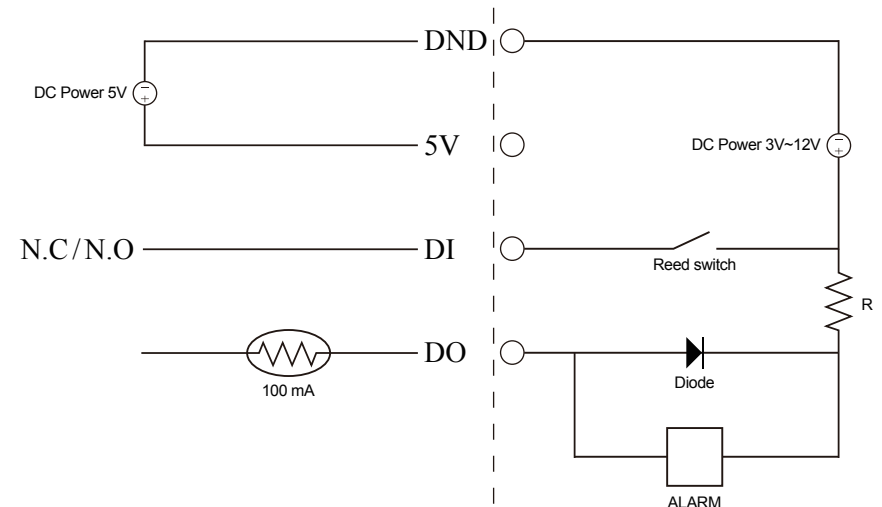

# Technical Specifications

Camera	<b>Camera Hardware Profile</b>	<ul style="list-style-type: none"> <li>▪ 1/4" 1 Megapixel progressive CMOS sensor</li> <li>▪ Minimum illumination 1.0 lux</li> <li>▪ 10x digital zoom</li> <li>▪ Fixed length 3.45 mm</li> </ul>	<ul style="list-style-type: none"> <li>▪ Aperture F2.0</li> <li>▪ Angle of view: (H) 57.8° (V) 37.8° (D) 66°</li> </ul>
	<b>Image Features</b>	<ul style="list-style-type: none"> <li>▪ Configurable image size, quality, frame rate, and bit rate</li> <li>▪ Time stamp and text overlays</li> <li>▪ Configurable motion detection windows</li> </ul>	<ul style="list-style-type: none"> <li>▪ 3 configurable privacy mask zones</li> <li>▪ Configurable shutter speed, brightness, saturation, contrast, and sharpness</li> </ul>
	<b>Video Compression</b>	<ul style="list-style-type: none"> <li>▪ Simultaneous H.264/MPEG-4/MJPEG format compression</li> <li>▪ JPEG for still image</li> <li>▪ H.264/MPEG-4 multicast streaming</li> </ul>	<ul style="list-style-type: none"> <li>▪ H.264/MPEG-4 multicast streaming</li> </ul>
	<b>Video Resolution</b>	16:9 - 1280 x 800, 1280 x 720, 800 x 450, 640 x 360, 480 x 270, 320 x 176, 176 x 144 at frame rates up to 30 fps 4:3 - 1024 x 768, 800 x 600, 640 x 480, 480 x 360, 320 x 240, 176 x 144 at frame rates up to 30 fps	
	<b>Audio Support</b>	G.726	
	<b>External Device Interface</b>	<ul style="list-style-type: none"> <li>▪ 1 DI / 1 DO</li> <li>▪ Micro SD card slot</li> </ul>	<ul style="list-style-type: none"> <li>▪ Built-in microphone</li> <li>▪ 3.5mm audio output jack</li> </ul>
Network	<b>Network Protocols</b>	IPv4, TCP/IP, UDP, ICMP, DHCP Client, NTP Client (D-Link), DNS Client, DDNS Client (D-Link), SMTP Client, FTP Client, HTTP / HTTPS, Samba Client, PPPoE, UPnP Port Forwarding, RTP / RTSP/ RTCP, IP filtering, 3GPP, IGMP, ONVIF Compliant	
	<b>Security</b>	<ul style="list-style-type: none"> <li>▪ Administrator and user group protection</li> <li>▪ Password authentication</li> </ul>	<ul style="list-style-type: none"> <li>▪ HTTP and RTSP digest encryption</li> </ul>

# Technical Specifications

System Management	<b>System Requirements for Web Interface</b>	<ul style="list-style-type: none"> <li>▪ Operating System: Microsoft Windows 7/Vista/XP/2000</li> <li>▪ Browser: Internet Explorer, Firefox, Netscape, Opera</li> </ul>
	<b>Event Management</b>	<ul style="list-style-type: none"> <li>▪ Motion detection</li> <li>▪ Event notification and upload snapshots/video clips via HTTP, SMTP, or FTP</li> <li>▪ Supports multiple HTTP, SMTP, and FTP servers</li> <li>▪ Multiple event notifications</li> <li>▪ Multiple recording methods for easy backup</li> </ul>
	<b>Remote Management</b>	<ul style="list-style-type: none"> <li>▪ Configuration accessible via web browser</li> <li>▪ Take snapshots/video clips and save to local hard drive or NAS via web browser</li> </ul>
	<b>Mobile Support</b>	Windows 7/Vista/XP system, Pocket PC, or mobile phone with 3GPP playback support
	<b>D-ViewCam™ System Requirements</b>	<ul style="list-style-type: none"> <li>▪ Operating System: Microsoft Windows 7/Vista/XP</li> <li>▪ Web Browser: Internet Explorer 6 or higher</li> <li>▪ Protocol: Standard TCP/IP</li> </ul>
	<b>D-ViewCam™ Software Functions</b>	<ul style="list-style-type: none"> <li>▪ Remote management/control of up to 32 cameras</li> <li>▪ Viewing of up to 32 cameras on one screen</li> <li>▪ Supports all management functions provided in web interface</li> <li>▪ Scheduled motion triggered, or manual recording options</li> </ul>
General	<b>Power Input</b>	5 V DC 1.2 A, 50/60 Hz
	<b>Max. Power Consumption</b>	DCS-2103: 2 watts DCS-2130: 2.5 watts
	<b>Operating Temperature</b>	0 to 40 °C (32 to 104 °F)
	<b>Storage Temperature</b>	-20 to 70 °C (-4 to 158 °F)
	<b>Humidity</b>	20% to 80% non-condensing
	<b>Weight</b>	DCS-2103: 68 g DCS-2130: 69 g
	<b>Certifications</b>	CE, CE LVD, FCC (Class B), C-Tick

\* This device complies with part 15 of the FCC Rules.

Operation is subject to the following two conditions:

(1) This device may not cause harmful interference.

(2) This device must accept any interference received, including interference that may cause undesired operation.

