

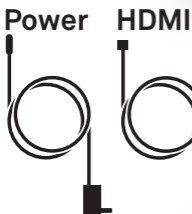

D-Link

INSTALL GUIDE

Your Little Black Box



SD/MMC card slot



Your Two-Faced Remote

Play/Pause - We know you get it

Directional Pad - Navigate your way around

Enter Button - Accept the current selection / show playback menu

Menu - Go back / show main menu

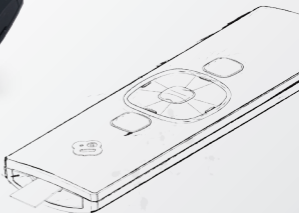

Pull out the plastic tab from the remote to activate the battery.

Step 1

Using the supplied HDMI cable, connect the Boxee Box to your TV.

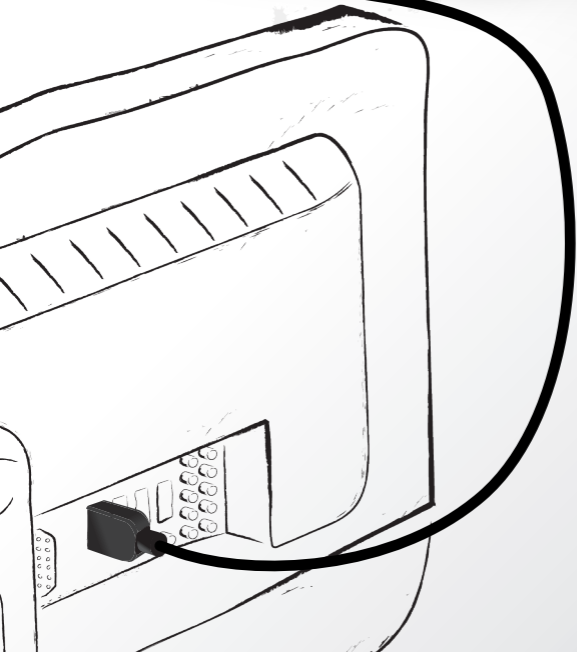

Step 2

Using the supplied power adapter, plug the Boxee Box into a power source.

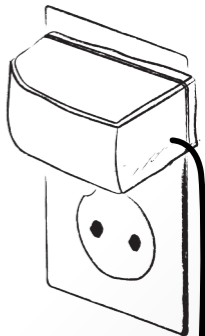

Power plug may differ by region.

Power Button



Step 3

Turn on your Boxee Box. Then use the TV's remote control to turn on your TV and set it to the correct HDMI input source. You should see the Boxee Box logo smiling at you.



Step 4

Follow the on-screen instructions to configure your new Boxee Box and connect to your network.



Warning: To block adult content, configure Parental Controls under settings.

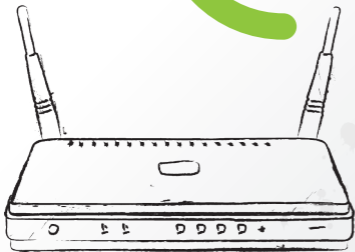

Pairing your Boxee Remote to the Boxee Box

Your remote comes from the factory already paired to the Boxee Box. If you are noticing interference with your remote from other devices, you may pair the remote with the Boxee Box in the easy steps below:

1. Make sure to move other devices away from the Boxee Box (or turn them off)
2. Put the remote in close proximity with the Boxee Box.
3. Press and hold the OK key on the simple side of the remote for 5 seconds.
4. Pairing is complete when you can control the Boxee Box. There is no visual indication of pairing on the device.
5. You can immediately use the remote control now.

Replacing the Battery

With a coin, remove the battery tray. Insert the battery with the + side face down into the battery tray. Slide the tray back into the remote.

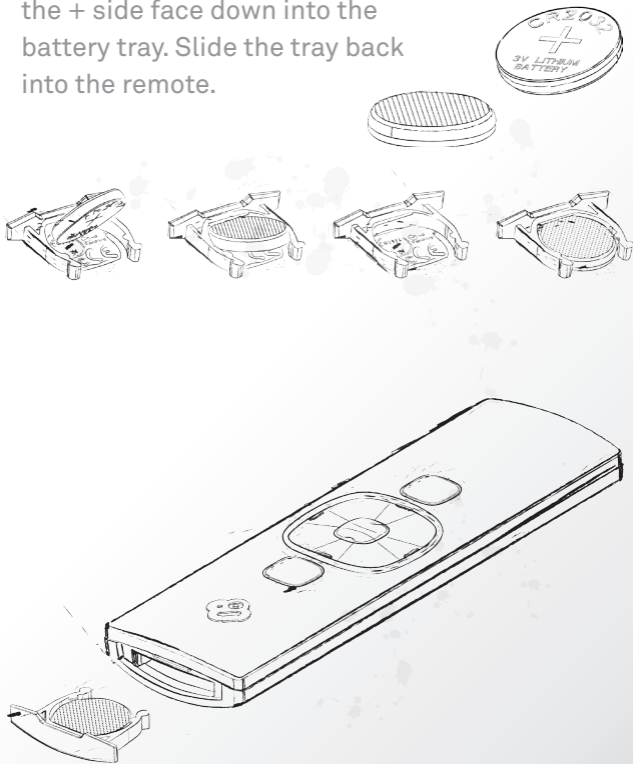

Need Help With Something?

United Kingdom (Mon-Fri)

website: <http://www.dlink.co.uk> FTP: <ftp://ftp.dlink.co.uk>
Home Wireless/Broadband 0871 873 3000 (9.00am–06.00pm,
Sat 10.00am-02.00pm)

Managed, Smart, & Wireless Switches, or Firewalls 0871 873
0909 (09.00am- 05.30pm)

(BT 10ppm, other carriers may vary.)

Ireland (Mon-Fri)

All Products 1890 886 899

(09.00am-06.00pm, Sat 10.00am-02.00pm)

Phone rates: €0.05ppm peak, €0.045ppm off peak times

Ihre kleine 'Black Box'



Strom

HDMI



SD/MMC-Karteneinschub



Ihre beidseitig verwendbare Fernbedienung

Play/Pause - Für Wiedergabe und Pause

Navigationstastenfeld - Zur besseren Navigation

Eingabetaste - Zum Bestätigen der aktuellen Auswahl / Anzeigen des Wiedergabe-Menüs

Menü - Zurück / Hauptmenü anzeigen

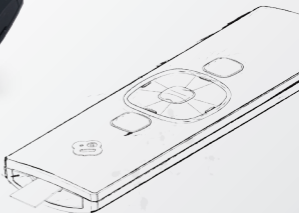

Ziehen Sie die Plastiklasche aus der Fernbedienung, um die Batterie zu aktivieren.

Schritt 1.

Schließen Sie die Boxee Box mithilfe des mitgelieferten HDMI-Kabels an Ihr Fernsehgerät an.

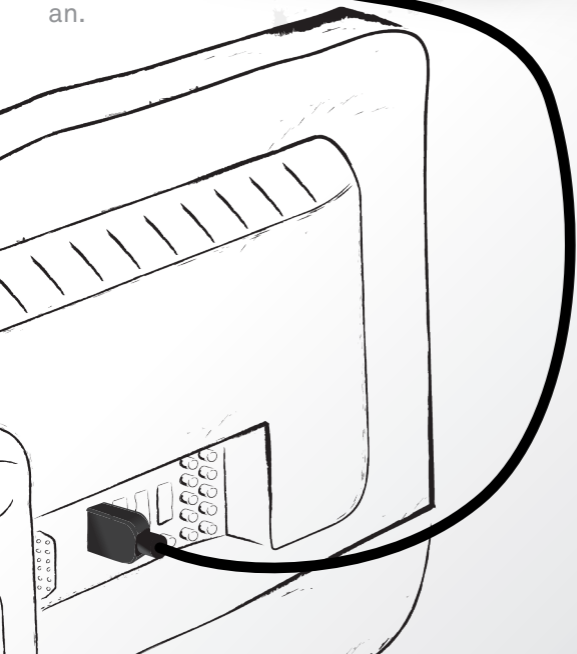

Schritt 2.

Schließen Sie die Boxee Box unter Verwendung des mitgelieferten Stromadapters/ Netzteil an eine Stromquelle an.

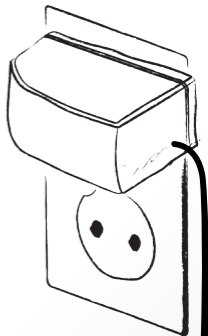

Ein-/Aus-Taste

Der Netzstecker ist möglicherweise von Land zu Land unterschiedlich.



Schritt 3.

Schalten Sie Ihren Fernseher ein. Anschließend sollten Sie die Boxee Box einschalten. Sollte Ihr Fernseher nicht automatisch die Boxee Box anzeigen, müssen sie die entsprechende Eingangquelle in Ihrem Fernseher auswählen, zB HDMI1, HDMI2 etc..

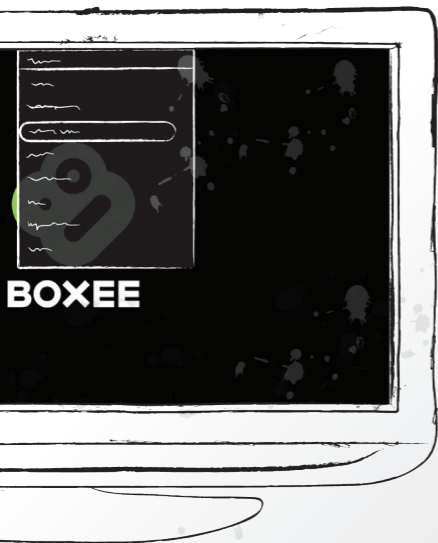



Schritt 4.

Folgen Sie den Anweisungen auf dem Bildschirm, um Ihre neue Boxee Box zu konfigurieren und eine Verbindung zu Ihrem Netzwerk herzustellen.

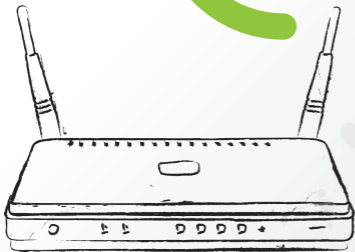

Warnung: Um die Kategorie 'Adult Content' (jugendgefährdendes Material) zu sperren, stellen Sie die Kinderschutzfunktionen entsprechend ein.

Einstellung Ihrer Boxee-Fernbedienung auf die Boxee Box

Ihre Fernbedienung ist bereits werkseitig auf die Boxee Box eingestellt. Sollten Sie jedoch Störungen von anderen Geräten feststellen, können Sie die Fernbedienung wie folgt umstellen:

1. Stellen Sie zunächst unbedingt andere Geräte von der Boxee Box entfernt auf (oder schalten Sie diese aus)
2. Verwenden Sie die Fernbedienung in unmittelbarer Nähe der Boxee Box.
3. Drücken und halten Sie die OK-Taste auf der 'einfachen Seite' der Fernbedienung 5 Sekunden lang.
4. Die Abstimmung ist abgeschlossen, wenn Sie die Boxee Box bedienen können. Es erfolgt keine visuelle Anzeige der erfolgreichen Abstimmung auf dem Gerät.
5. Sie können die Fernbedienung nun sofort verwenden.

Ersetzen der Batterie

Verwenden Sie eine Münze, um den Batterieträger zu entfernen.
Legen Sie die Batterie mit der + Seite nach unten in den Batterieträger. Schieben Sie den Batterieträger wieder zurück in die Fernbedienung.

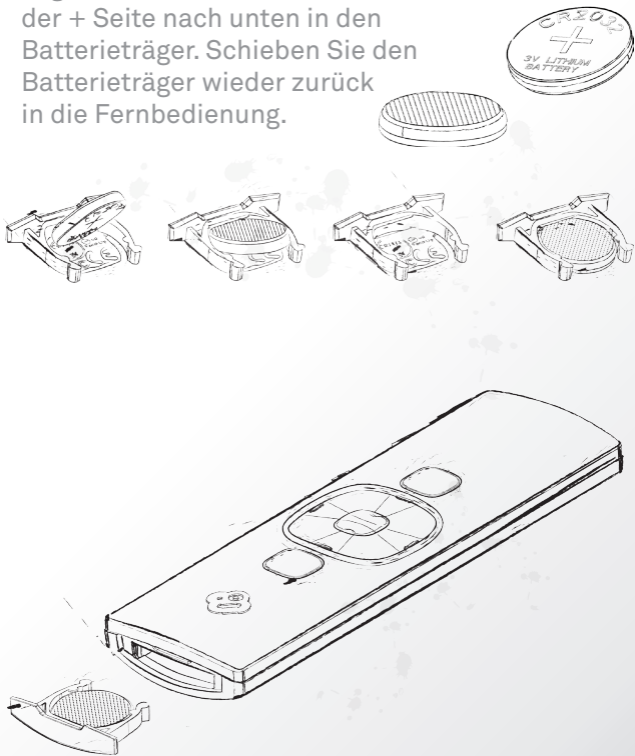

Sie brauchen Hilfe?

Deutschland

Web: <http://www.dlink.de>

Telefon: +49(0)1805 2787

0,14 € pro Minute

Zeiten: Mo. – Fr. 09:00 – 17:30 Uhr

Österreich:

Web: <http://www.dlink.at>

Telefon: +43(0)820 480084

0,116 € pro Minute

Zeiten: Mo. – Fr. 09:00 – 17:30 Uhr

Schweiz:

Web: <http://www.dlink.ch>

Telefon: +41(0)848 331100

0,08 CHF pro Minute

Zeiten: Mo. – Fr. 09:00 – 17:30 Uhr

* Gebühren aus Mobilnetzen und von anderen Providern können abweichen.

Votre petite boîte noire



Alimentation

HDMI



Fente pour carte SD/MMC



Votre télécommande à 2 faces

Lecture/Pause : Nous savons que vous l'avez



Pavé directionnel : Naviguez en toute liberté

Bouton Entrée : Acceptez le menu de sélection actuelle / de lecture

Menu : Menu de retour / affichage principal



by D-Link

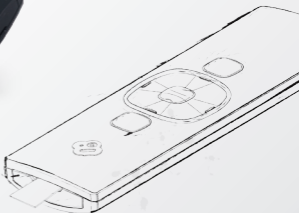

Retirez la languette en plastique de la télécommande pour activer la pile.

Étape 1

À l'aide du câble HDMI fourni, connectez la Boxee Box à votre télévision.

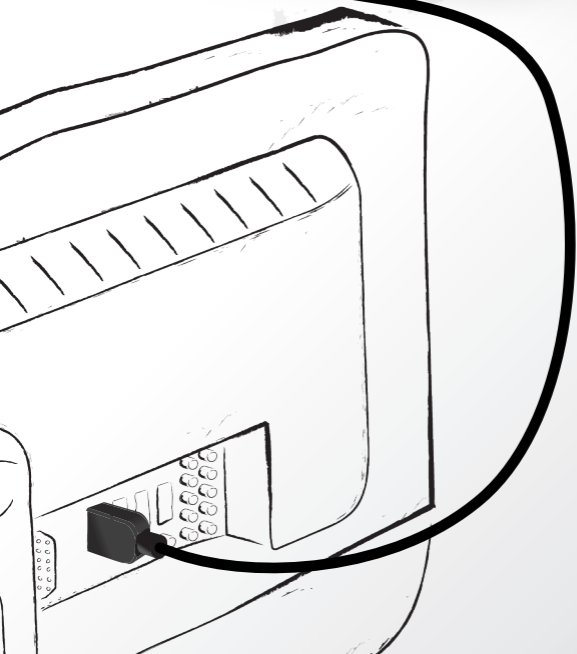

Étape 2

En utilisant l'adaptateur secteur fourni, branchez la Boxee Box dans une prise de courant.

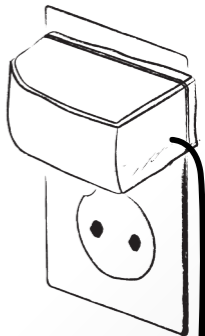

Bouton d'alimentation

La prise de courant peut être différente d'une région à l'autre.



Étape 3

Allumez votre Boxee Box. Ensuite, utilisez la télécommande de la télévision pour l'allumer et la régler sur la source d'entrée HDMI correcte. Le logo Boxee Box doit vous sourire.

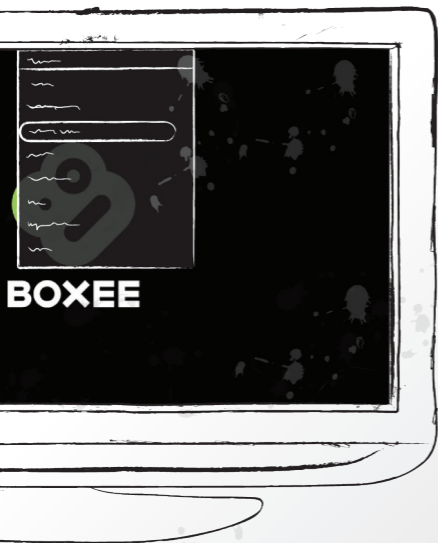

Étape 4

Suivez les instructions à l'écran pour configurer votre nouvelle Boxee Box et connectez-la à votre réseau.

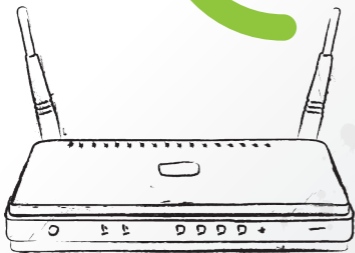

Attention : Pour bloquer le contenu pour adulte, configurez les contrôles parentaux sous ces paramètres.

Synchronisation de la télécommande Boxee avec la Boxee Box

À la sortie d'usine, votre télécommande est déjà synchronisée avec la Boxee Box. Si vous constatez des interférences entre votre télécommande et d'autres périphériques, vous pouvez la synchroniser avec la Boxee Box en suivant les étapes simples ci-dessous :

1. Veillez à éloigner les autres périphériques de la Boxee Box (ou à les éteindre)
2. Placez la télécommande à proximité de la Boxee Box.
3. Maintenez la touche OK située sur le côté simple de la télécommande enfoncée pendant 5 secondes.
4. La synchronisation est terminée lorsque vous pouvez commander la Boxee Box. Aucune indication de la synchronisation n'est visible sur le périphérique.
5. Vous pouvez utiliser la télécommande dès à présent.

Remplacement de la pile

Retirez le couvercle de la pile à l'aide d'une pièce. Insérez la pile, la face + vers le bas du compartiment à piles. Refaites glisser le couvercle dans la télécommande.



Besoin d'aide sur un point précis ?

France

Assistance technique D-Link sur internet :

<http://www.dlink.fr>

Assistance technique D-Link par téléphone : 0820 0803 03

0.12 € TTC/min depuis un poste fixe

Du lundi au vendredi de 9h à 19h (hors jours fériés)

Su pequeña caja negra



Alimentación

HDMI



Ranura para tarjeta
SD/MMC



Su mando a distancia de doble cara

Reproducción/Pausa - Sabemos que lo entiende

Pulsador de dirección - Navegar por todas partes

Botón Intro - Aceptar la selección actual / mostrar el menú de reproducción

Menú - Volver / mostrar el menú principal

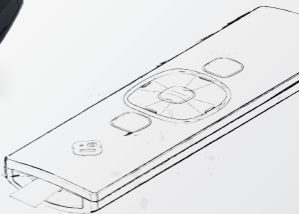

Tire de la lengüeta de plástico del mando a distancia para activar la batería.

Paso 1

Utilizando el cable HDMI suministrado, conecte el Boxee Box a su TV.

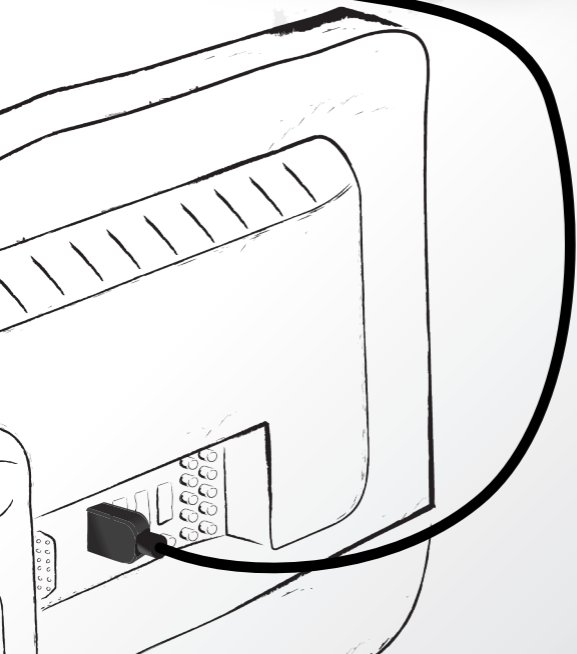

Paso 2

Utilizando el adaptador de alimentación suministrado, enchufe el Boxee Box a una fuente de alimentación.

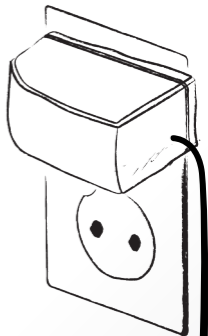

El enchufe de alimentación puede variar según la región.

Botón Alimentación



Paso 3

Encienda su Boxee Box. A continuación, utilice el mando a distancia de su TV para encender su televisor y configurarlo en la fuente de entrada HDMI correcta. Debería ver el logotipo de Boxee Box sonriéndole.



Paso 4

Siga las instrucciones en pantalla para configurar su nuevo Boxee Box y conéctese a la red.

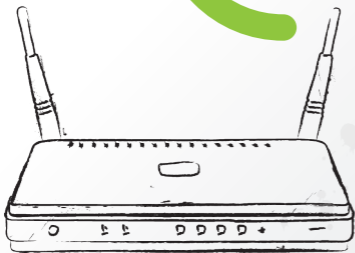

Advertencia: Para bloquear los contenidos para adultos, configure los parámetros de los controles parentales.

Emparejar el mando a distancia de Boxee con el Boxee Box

Su mando a distancia se envía de fábrica emparejado con el Boxee Box. Si observa interferencias con el mando a distancia procedente de otros dispositivos, puede emparejar el mando a distancia con el Boxee Box siguiendo estos sencillos pasos:

1. Asegúrese de alejar los otros dispositivos del Boxee Box (o apáguelos)
2. Coloque el mando a distancia cerca del Boxee Box.
3. Pulse y mantenga pulsada la tecla Aceptar del lado sencillo del mando a distancia durante 5 segundos.
4. El emparejamiento ha finalizado cuando pueda controlar el Boxee Box. No existe ninguna indicación visual del emparejamiento en el dispositivo.
5. Puede utilizar inmediatamente el mando a distancia.

Sustitución de la batería

Con una moneda, retire la bandeja de la batería. Introduzca la batería con la cara + hacia abajo en la bandeja de la batería. Deslice de nuevo la bandeja en el mando a distancia.



¿Necesita ayuda?

España

<http://www.dlink.es>

Asistencia Técnica Telefónica de D-Link:

+34 902 30 45 45 0,067 €/min

De Lunes a Viernes de 9:00 a 19:00

Il Boxee Box



Alimentazione
HDMI



Slot per schede SD/MMC



Telecomando a due facce

Play/Pause - Hanno la funzione dei pulsanti di un normale telecomando

Pulsante di direzione - Consente di spostarsi

Pulsante Invio - Consente di accettare la selezione corrente o di visualizzare il menu di riproduzione

Menu - Consente di tornare indietro o di visualizzare il menu principale

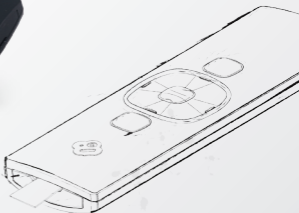

Estrarre la linguetta di plastica dal telecomando per attivare la batteria.

Passo 1

Utilizzando il cavo HDMI fornito collegare il Boxee Box al televisore.

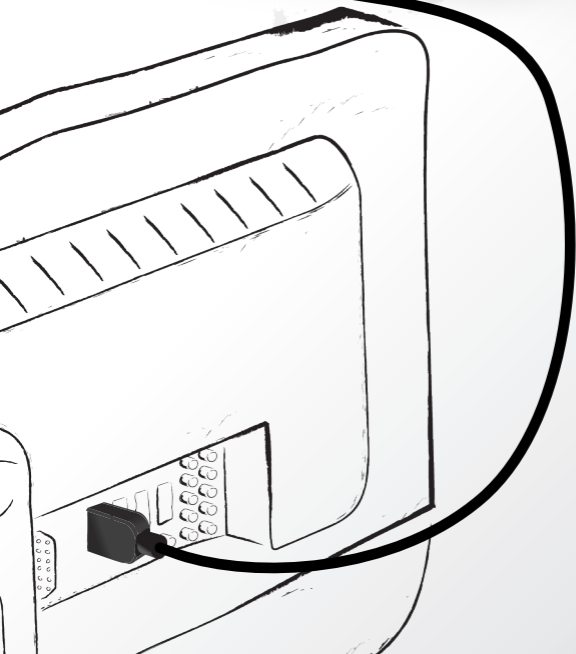

Passo 2

Utilizzando l'adattatore di alimentazione fornito, collegare il Boxee Box a una fonte di alimentazione.

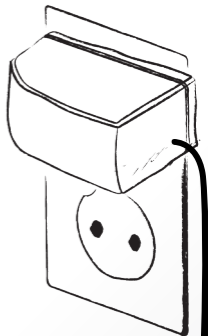

Pulsante di alimentazione

La spina potrebbe essere diversa a seconda del paese.



Passo 3

Accendere il Boxee Box. Utilizzare il telecomando del televisore per accendere il televisore e impostarlo sull'ingresso HDMI corretto. Se le operazioni sono corrette, verrà visualizzato il logo del Boxee Box.

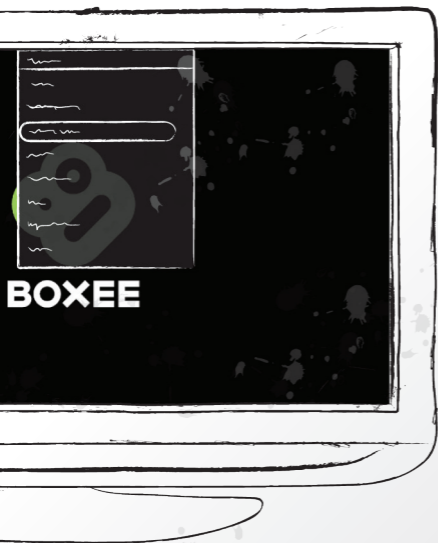

Passo 4

Seguire le istruzioni visualizzate sullo schermo per configurare il nuovo Boxee Box e collegarlo alla rete.



Avviso: per bloccare il contenuto per adulti, configurare la funzione Controllo parentale nelle impostazioni.

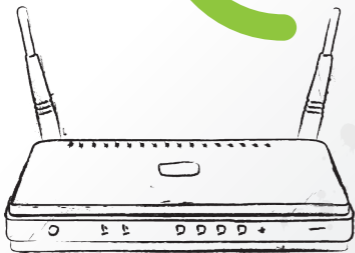

Associazione del telecomando Boxee al Boxee Box

Il telecomando fornito è già associato al Boxee Box. Se si notano interferenze tra il telecomando e altri dispositivi, è possibile associare il telecomando al Boxee Box eseguendo le operazioni descritte di seguito:

1. Assicurarsi di allontanare gli altri dispositivi dal Boxee Box (oppure spegnerli)
2. Avvicinare il telecomando al Boxee Box.
3. Premere e tenere premuto il tasto OK sul telecomando per 5 secondi.
4. L'associazione risulta completata quando è possibile controllare il Boxee Box con il telecomando. L'associazione non viene confermata visivamente sul dispositivo.
5. A questo punto è possibile utilizzare subito il telecomando.

Sostituzione della batteria

Utilizzare una moneta per rimuovere il vano batteria. Inserire la batteria con il lato + rivolto verso il basso nel vano batteria. Far scorrere il vassoio nel telecomando.



Ulteriori informazioni

Italia

<http://www.dlink.it/support>

Supporto Tecnico dal lunedì al venerdì dalle ore 9.00 alle ore
19.00 con orario continuato

Telefono: 199400057

Uw kleine zwarte kastje



Voeding

HDMI



SD/MMC-kaartsleuf



Uw dubbelzijdige afstandsbediening

Afspelen/Pauzeren - Gebruik deze functie om te pauzeren of af te spelen

Directionele Pad - Navigeer gemakkelijk door de menu's van uw Boxee Box

Enter-knop - Accepteer de huidige selectie/toon afspeelmenu

Menu - Ga terug/toon hoofdmenu

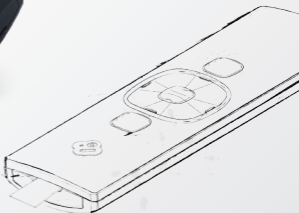

Trek het plastic lipje van de afstandsbediening naar buiten om de batterij te activeren.

Stap 1

Sluit het Boxee-kastje aan met de meegeleverde HDMI-kabel op uw tv.

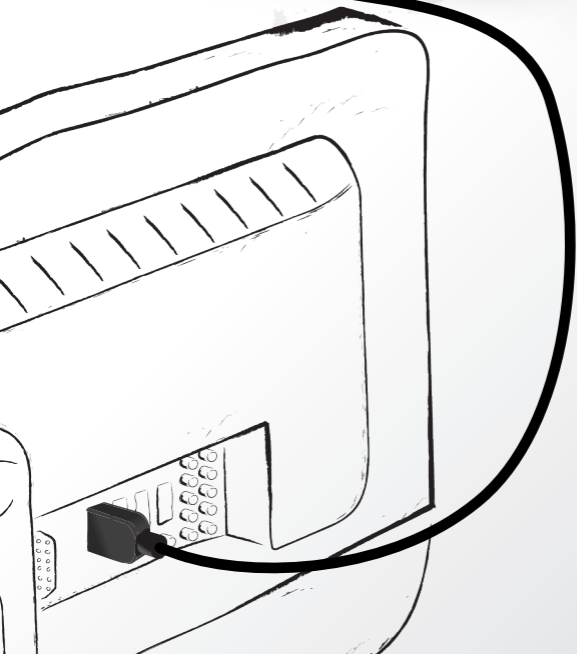

Stap 2

Sluit de Boxee Box aan op een stopcontact d.m.v de bijgeleverde stroomadapter.

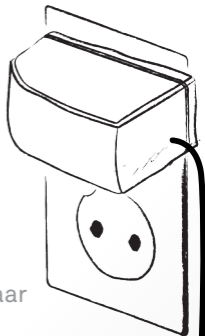

Aan/Uit schakelaar

De stroomstekker kan enigszins verschillen volgens regio.



Stap 3

Schakel uw Boxee Box in. Gebruik vervolgens de afstandsbediening van uw tv om deze over te schakelen op de HDMI input-bron.

Het logo van de Boxee Box ziet u nu op het scherm verschijnen!

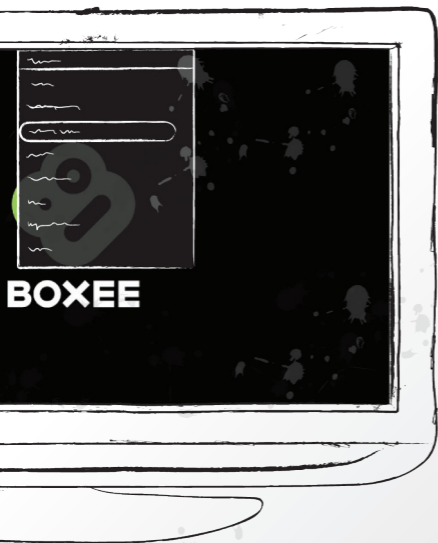

Stap 4

Volg de instructies op het scherm om uw nieuwe Boxee-kastje te configureren en een verbinding te maken met uw netwerk.



Waarschuwing:

Configureer Ouderlijke controle onder "instellingen" om inhoud voor kinderen te blokkeren.

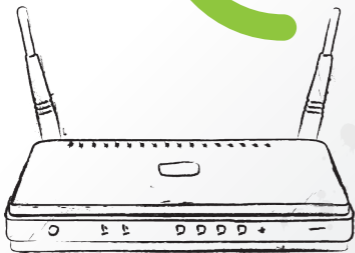

Uw Boxee-afstandsbediening koppelen aan het Boxee-kastje

Uw afstandsbediening werd in de fabriek al gekoppeld aan het Boxee-kastje.

Indien u interferentie opmerkt met uw afstandsbediening van andere apparaten, kunt u de afstandsbediening koppelen aan het Boxee-kastje met de onderstaande eenvoudige stappen:

1. Plaats andere apparaten uit de buurt van het Boxee kastje (of schakel ze uit)
2. Richt uw afstandsbediening op de Boxee Box.
3. Houd de OK-knop gedurende 5 seconden ingedrukt op de enkele zijde van de afstandsbediening.
4. Het koppelen is voltooid wanneer u het Boxee-kastje kunt bedienen. Op het apparaat is geen visuele indicatie van koppeling.
5. U kunt de afstandsbediening nu onmiddellijk gebruiken.

De batterij vervangen

Verwijder de batterijlade met een muntstuk. Plaats de batterij met de + zijde naar beneden gericht in de batterijlade. Schuif de lade terug in de afstandsbediening.



Hulp nodig met iets?

Technische ondersteuning voor klanten in Nederland:

www.dlink.nl / 0900 501 2007 / €0.15per minuut.

Technische ondersteuning voor klanten in België:

www.dlink.be / 070 66 06 40 / €0.175per minuut(spitsuren),
€0.0875per minuut(daluren)

Technische ondersteuning voor klanten in Luxemburg:

www.dlink.be / +32 70 66 06 40

Mała, czarna skrzynka



Zasilanie HDMI



Gniazdo karty SD/MMC



Dwustronny pilot zdalnego sterowania

**Play/Pause (Odtwarzanie/
Pauza)** - Wiesz o co chodzi

D-pad - Steruj wszystkim

Przycisk Enter - Zaakceptuj
bieżący wybór/pokaż menu
odtwarzania

Menu - Wróć/pokaż menu
główne

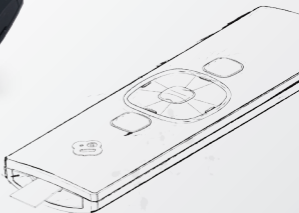

Wyciągnij plastikową kartę z pilota zdalnego sterowania, aby aktywować baterię.

Krok 1

Za pomocą dołączonego kabla HDMI podłącz Boxee Box do swojego telewizora.

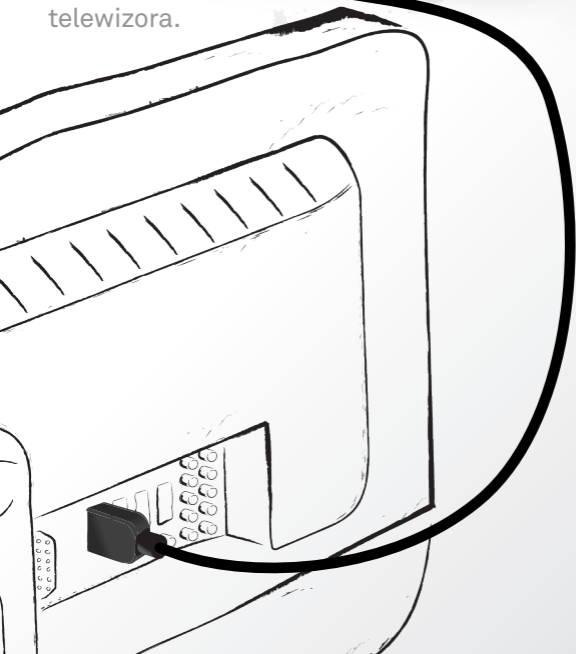

Krok 2

Za pomocą dołączonego zasilacza sieciowego, podłącz Boxee Box do źródła zasilania.

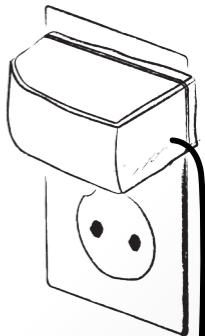

Włącznik

Wtyczki zasilania mogą być różne w zależności od regionu.



Krok 3

Włącz Boxee Box. Następnie za pomocą pilota zdalnego sterowania TV włącz telewizor i ustaw prawidłowe źródło wejścia HDMI. Powinno pojawić się uśmiechnięte logo Boxee Box.

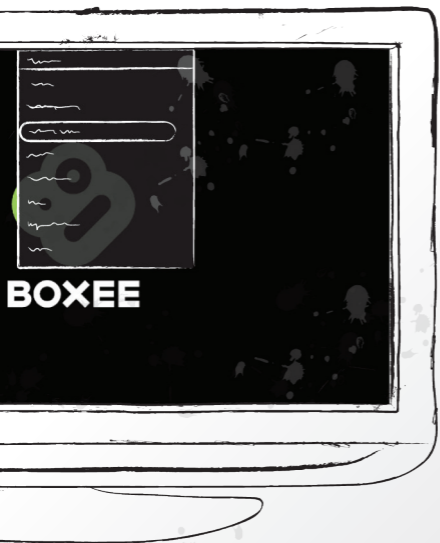



Krok 4

Postępuj zgodnie ze wskazówkami na ekranie, aby skonfigurować Boxee Box i podłączyć go do swojej sieci.

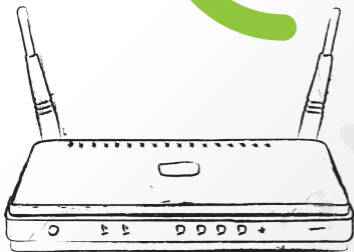

Ostrzeżenie: Aby zablokować dostęp do treści dla dorosłych, w ustawieniach skonfiguruj funkcję Kontroli rodzicielskiej

Parowanie pilota zdalnego sterowania Boxee i Boxee Box

Pilot zdalnego sterowania jest fabrycznie sparowany z Boxee Box. Jeśli zauważysz zakłócenia pracy pilota pochodzące od innych urządzeń, możesz sparować go z Boxee Box w kilku prostych krokach, omówionych poniżej:

1. Upewnij się, że Boxee Box znajduje się z dala od innych urządzeń (lub są one wyłączone)
2. Umieść pilot w pobliżu Boxee Box.
3. Naciśnij i przytrzymaj przez 5 sekund przycisk OK po prostej stronie pilota.
4. Parowanie jest zakończone, jeśli możesz obsługiwać Boxee Box. Na urządzeniu nie ma widocznego oznaczenia parowania.
5. Możesz od razu korzystać z pilota.

Wymiana baterii

Za pomocą monety usuń szufladkę baterii. Włóż baterię odwróconą stroną + do dołu do szufladki baterii. Wsuń szufladkę baterii z powrotem do pilota.



Masz jakieś problemy?

Polski

Telefoniczna pomoc techniczna firmy D-Link: 0 801 022 021

Pomoc techniczna firmy D-Link świadczona przez Internet:

<http://www.dlink.eu/support/>

Vaše černá skříňka



Napájení HDMI



Slot pro kartu SD/MMC



Ovladač se dvěma tvářemi

Přehrávání/pauza - Víme, že je vám to jasné

Směrová tlačítka - Slouží pro navigaci

Tlačítko Enter - Potvrdit aktuální výběr / zobrazit menu pro přehrávání

Menu - Zpět / zobrazit hlavní menu

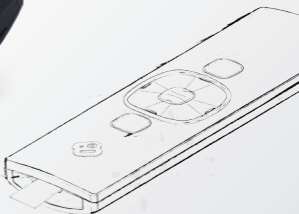

Vytažením plastového pásku z ovladače aktivujete baterii.

Krok 1

Pomocí
příbaleného
kabelu HDMI
připojte Boxee
Box
k TV.



Krok 2

Pomocí přibaleného napájecího adaptéru připojte Boxee Box k napájení.

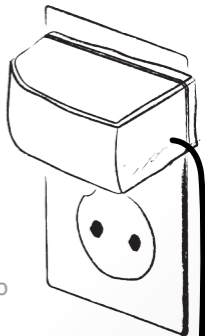

Vypínací tlačítko

Elektrická zásuvka se může v různých oblastech lišit.



Krok 3

Zapněte Boxee Box. Pak dálkovým ovladačem k TV zapněte televizor a vyberte správný vstup HDMI. Mělo by se na vás usmívat logo Boxee Box.

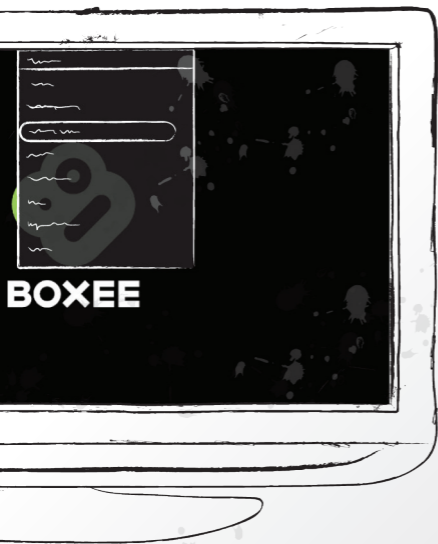

Krok 4

Podle pokynů
na obrazovce
nakonfigurujte nový
Boxee Box a připojte
jej k síti.



Výstraha: Chcete-li
blokovat obsah pro
dospělé, v nastavení
zadejte rodičovskou
kontrolu.

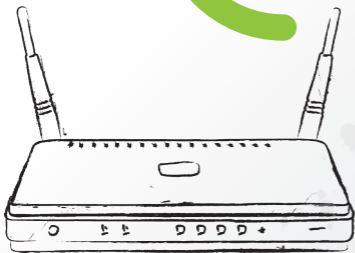

Párování Boxee Box a ovladače k Boxee

Dálkový ovladač je dodáván již spárovaný s Boxee Box. Však zaznamenate-li rušení způsobené jinými zařízeními, můžete ovladač jednoduše spárovat dle následujících kroků:

1. Ostatní blízko ležící zařízení přesuňte dále od Boxee Box nebo je vypněte.
2. Ovladač umístěte blízko Boxee Box.
3. Stiskněte tlačítko OK na straně ovladače s logem D-Link a držte jej 5 sekund.
4. Párování je dokončeno, jakmile můžete Boxee Box ovládat. Na zařízení se neobjeví žádné viditelné indikátory párování.
5. Dálkový ovladač můžete ihned začít používat.

Výměna baterie

Pomocí mince vyjměte držák baterie. Vložte do držáku baterii kladným pólem (+) nahoru. Zasuňte držák zpět do ovladače.

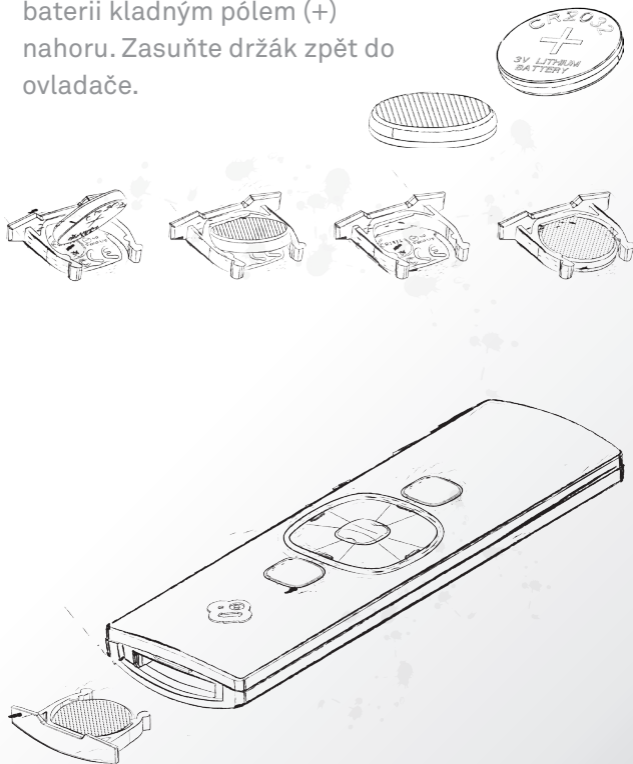

Potřebujete odbornou konzultaci?

Česká a Slovenská republika

Web: <http://www.dlink.cz/support/>

E-mail: support@dlink.cz

Telefon

ČR: +420 211 151 640 nebo

SK: +421 (0)692 147 110

Telefonická podpora je v provozu: PO - PÁ od 09:00 do 17:00

Volání je zpoplatněno dle příslušných tarifů Vašeho operátora.

Az Ön kicsi fekete Box-a



SD/MMC-kártya nyílás

Tápellátás HDMI

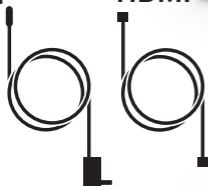

A kétoldalas távirányító

Lejátszás/Szünet - Tudjuk, hogy rátalál

Többirányú pad - Navigáljon minden irányba

Enter gomb - Fogadja el az épp aktuális választást / jelenítse meg a lejátszási menüt

Menü - Vissza / főmenü megjelenítése

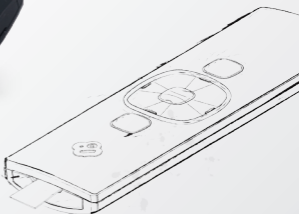

Húzza ki a műanyag fület a távirányítóból az elem aktiválásához.

1. lépés

A csomagolásban található HDMI kábel segítségével csatlakoztassa a Boxee Box a TV-jéhez.



2. lépés

A csomagolásban található tápadapter segítségével csatlakoztassa a Boxee Box tápforráshoz.

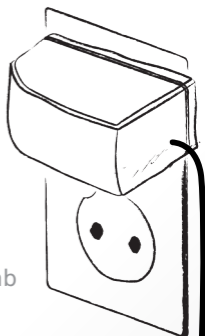

Bekapcsolás gomb

A csatlakozó
régiónként változhat.



3. lépés

Kapcsolja be a Boxee Box-ot. Ezt követően a TV távirányítójával kapcsolja be a TV-t és állítsa be megfelelő HDMI bemeneti forrásra. Most a Boxee Box logójának kellene mosolyognia Önre.





4. lépés

Kövesse a képernyőn megjelenő utasításokat az új Boxee Box konfigurálásához és a hálózathoz való csatlakozáshoz.

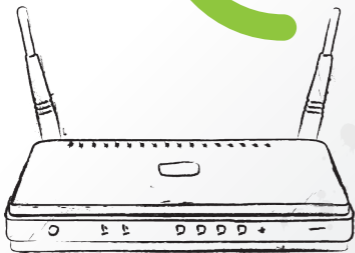

Figyelmeztetés:

Felnőtt tartalom blokkolásához konfigurálja a Szülői felügyeletet a beállításokban.

Boxee távirányító párosítása a Boxee Box-zal

A távirányító már gyárilag össze van párosítva a Boxee Box-zal. Amennyiben interferenciát tapasztal a távirányító és eszközök között, újrapárosíthatja a távirányítót a Boxee Box-zal az alábbi egyszerű lépések követésével:

1. Bizonyosodjon meg arról, hogy a többi eszközt távolabb helyezte a Boxee Box-otól (vagy kikapcsolta azokat)
2. Helyezze a távirányítót a Boxee Box-hoz közel.
3. Nyomja meg és tartsa 5 másodpercen keresztül lenyomva az OK gombot a távirányító egyszerűbb oldalán.
4. A párosítás akkor van kész, amikor tudja irányítani a Boxee Box-ot. A párosításnak nincs látható jele az eszközön.
5. Most már használhatja a távirányítót.

Elemcsere

Egy pénzérme segítségével vegye ki az elemtartót. Helyezze be az elemet a tartóba annak + oldalával lefelé. Csúsztassa vissza az elemtartót a távirányítóba.

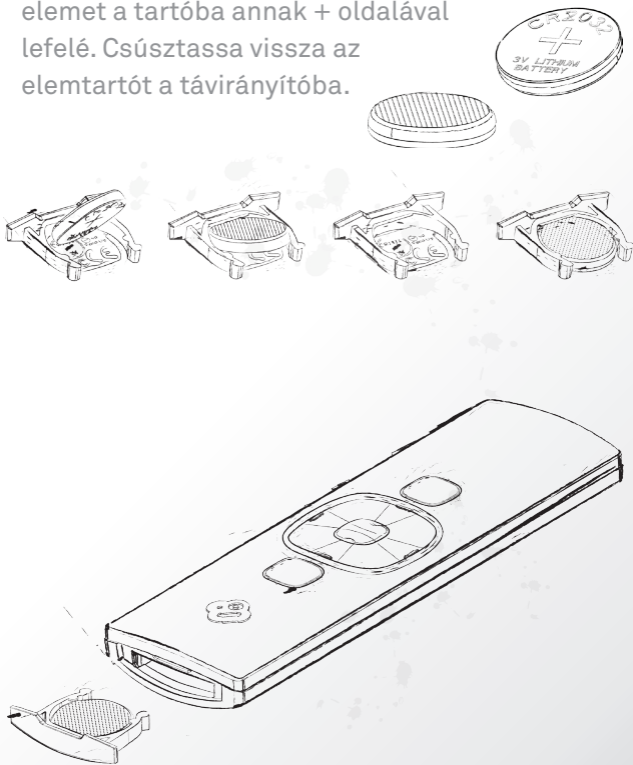

Segíthetünk valamiben?

Magyar

URL : <http://www.dlink.hu>

Tel. : 06 1 461-3001

Fax : 06 1 461-3004

Vezetékes 14,99 Ft/min - Mobil 49.99, Ft/min

email : support@dlink.hu

Din lille sorte boks



Strøm

HDMI



SD/MMC-kortspor



Din tosidige fjernkontroll

Spill/Pause - Vi vet at du skjønner dette

Retningskontroller - Naviger rundt omkring

Enter-tast - Aksepter det nåværende valg / vis avspillingsmenyen

Meny - Gå tilbake / vis hovedmeny

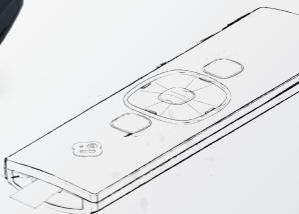

Trekk plastfliken at av fjernkontrollen for å aktivere batteriet.

Trinn 1

Koble til Boxee Box med den medfølgende HDMI-kabelen til TV-en din.



Trinn 2

Koble Boxee Box til en strømkilde med den medfølgende strømadapteren.

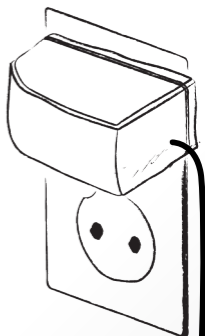

AV/PÅ-knapp

Støpselet kan være forskjellig for hver region.



Trinn 3

Slå på Boxee Box. Bruk TV-ens fjernkontroll for å slå på TV-en og angi riktig HDMI-inngangskilde. Boxee Box-logoen vil nå smile til deg.

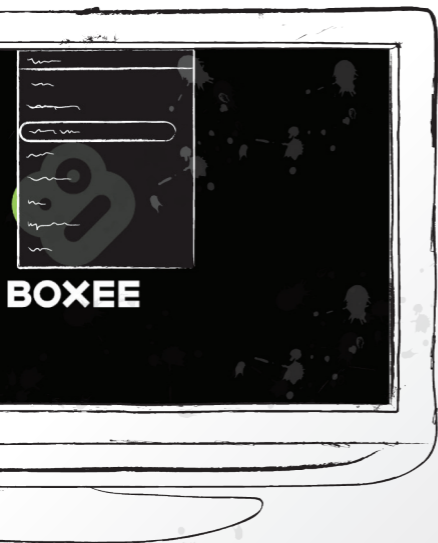

Trinn 4

Følg instruksjonene på skjermen for å konfigurere din nye Boxee Box og koble den til nettverket.

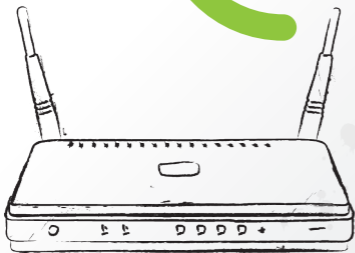

Observere! Din BoxeeBox kommer forhåndsinnstilt med aktivert foreldrekontroll. Du har også muligheten å konfigurere ett passord for funksjonene under innstillinger.

Å tilknytte Boxee Remote til Boxee Box

Fjernkontrollen er fra fabrikken allerede tilknyttet Boxee Box. Hvis du merker interferens med fjernkontrollen fra andre enheter, kan du tilknytte fjernkontrollen til Boxee Box i noen enkle trinn:

1. Sørg for å flytte andre enheter bort fra Boxee Box (eller slå dem av)
2. Sett fjernkontrollen i nærheten av Boxee Box.
3. Trykk og hold på OK-tasten på den enkle siden av fjernkontrollen i 5 sekunder.
4. Tilknytningen er fullført når du kan bruke Boxee Box. Det er ingen visuell indikasjon på at enheten er tilknyttet.
5. Du kan nå bruke fjernkontrollen.

Bytte batteri

Ta ut batteribrettet med en mynt. Sett inn batteriet med + siden vendt nedover i batteribrettet. Skyv brettet tilbake i fjernkontrollen.



Trenger du hjelp med noe?

Norsk

D-Link Teknisk Support over Internett: <http://www.dlink.no>

D-Link Teknisk telefonsupport: 820 00 755

(Hverdager 08:00-20:00)

Din lille, sorte box



Strømforsyning



HDMI

SD/MMC-kortspalte



Den tosideede fjernbetjening

Spil/Pause - Vi ved, du får brug for den

Styreplade - Navigér rundt, som du vil

Tryk på knappen - Acceptér det aktuelle valg/vis afspilningsmenu

Menu - Gå tilbage/vis hovedmenu

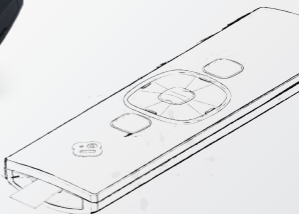

Træk plastfligen ud fra fjernbetjeningen for at aktivere batteriet.

Trin 1

Tilslut Boxee ved at bruge det medsendte HDMI-kabel Box til dit TV.



Trin 2

Anvend den medsendte strømfor-
synings-adapter til
at forbinde Boxee Box til en
stikkontakt.

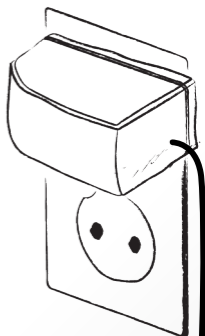

Tænd/sluk-knap

Strømtikket varierer
fra land til land.



Trin 3

Tænd din Boxee Box. Brug derefter TV'ets fjernbetjening til at tænde TV'et og vælge den korrekte HDMI-indgangskilde Du vil nu se Boxee Box-logoet smile til dig.

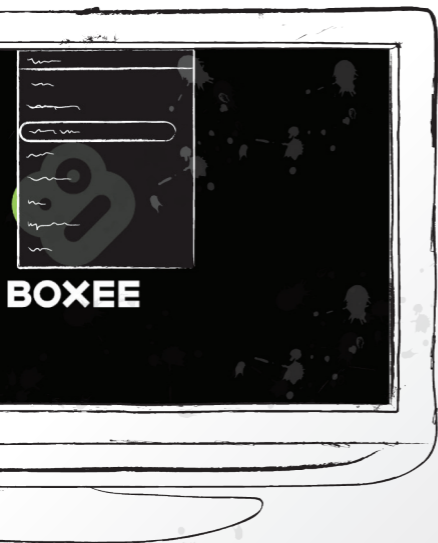

Trin 4

Følg på skærmen vejledningerne i konfigurering af din nye Boxee Box og tilslutning til dit netværk.



Advarsel: For at blokere pornografisk indhold konfigureres forældre-kontrol under indstillingerne.

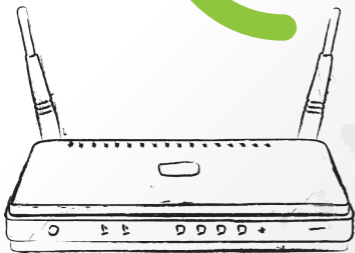

Tilknytning af Boxee-fjernbetjeningen til Boxee Box'en

Fjernbetjeningen er fra producenten allerede knyttet til Boxee Box'en. Hvis du mærker interferens/støj mellem din fjernbetjening og andre enheder, kan du knytte fjernbetjeningen til Boxee Box'en i følgende nemme trin:

1. Fjern andre enheder langt væk fra Boxee Box'en (eller sluk dem)
2. Hold fjernbetjeningen tæt på Boxee Box'en.
3. Tryk på og hold OK-knappen på fjernbetjeningens symbolside inde i 5 sekunder.
4. Tilknytningen er afsluttet, når du kan styre Boxee Box'en. Der er ingen visuel indikation af tilknytning på enheden.
5. Du kan nu med det samme benytte fjernbetjeningen.

Udskiftning af batteriet

Brug en mønt til at trække batteriskuffen ud. Indsæt batteriet med +siden nedad i batteriskuffen. Lad skuffen glide tilbage i fjernbetjeningen.

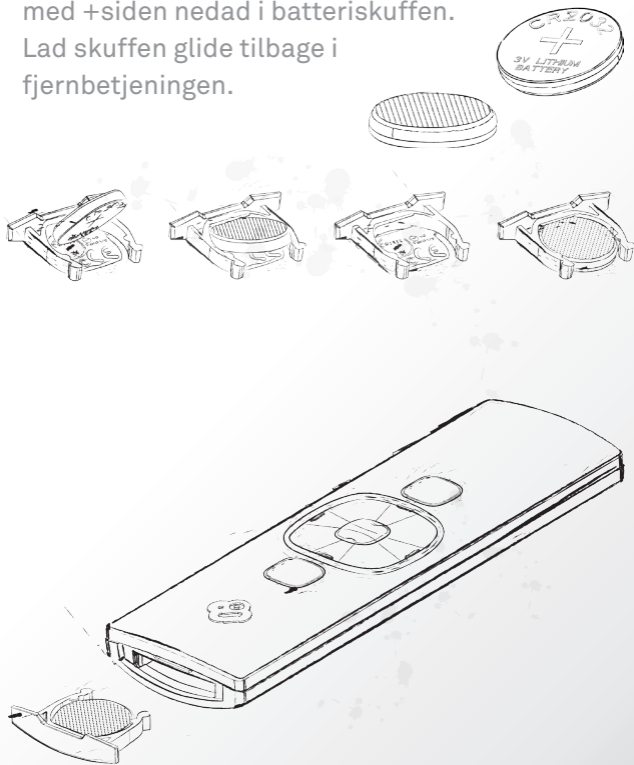

Har du brug for hjælp?

Dansk

D-Link teknisk support på Internettet: <http://www.dlink.dk>

D-Link teknisk support over telefonen: Tlf.: 9013 8899

Normale åbningstider: Hverdage kl. 08:00 - 20:00

Pieni musta laatikkosi



Virta

HDMI

SD/MMC-
muistikorttipaikka



Kaksipuolinen kaukosäädin

Play/Paussi - Tämän varmaan tiedät



Navi-näppäin - Navigoi perille



Enter-painike - Hyväksy nykyinen valinta / näytä toistoalikko



Valikko - Edellinen / näytä päävalikko



by
D-Link

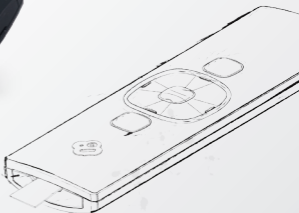

Aktivoi paristo vetämällä muovinen kieleke ulos kaukosäätimestä.

Vaihe 1

Kytke toimitetulla
HDMI-kaapelilla
Boxee Box
television.

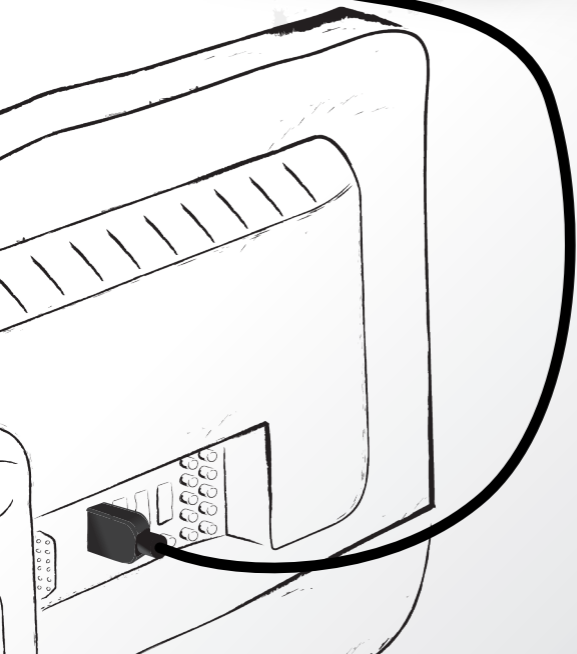

Vaihe 2

Kytke Boxee Box toimitetulla virtasovittimella virtalähteeseen.

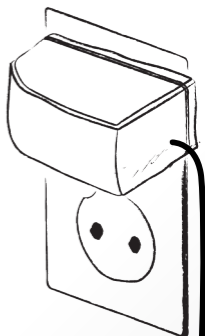

Virtapainike

Virtapistoke voi vaihdella alueen mukaan.



Vaihe 3

Käynnistä Boxee Box. Käynnistä sitten televisio television kaukosäätimellä ja aseta se oikeaan HDMI-tuloon. Sinun pitäisi nähdä Boxee Box -logon hymyilevän.





Vaihe 4

Seuraa näytölle tulevia ohjeita ja määritä uusi Boxee Boxisi ja kytkeydy verkkoon.

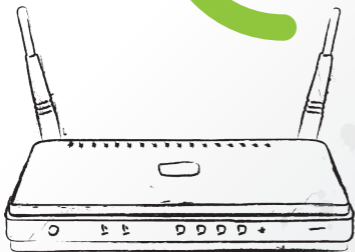

Huomautus:

Aikuisviihde suoja on aktivoitu tehdasasetuksissa. Voit laittaa salasanan toiminnalle Asetuksissa.

Laiteparin muodostaminen Boxee-kaukosäätimen ja Boxee Boxin välille

Kaukosäädin on asetettu laitepariin Boxee Boxin kanssa tehtaassa. Jos muut laitteet häiritsevät kaukosäätimen toimintaa, voit muodostaa laiteparin kaukosäätimen ja Boxee Boxin välille suorittamalla seuraavat helpot vaiheet:

1. Siirrä muut laitteet kauaksi Boxee Boxista (tai sammuta ne)
2. Vie kaukosäädin lähelle Boxee Boxia
3. Pidä Enter-näppäin painettuna kaukosäätimen etupanelissa 5 sekunnin ajan.
4. Parinmuodostus on valmis, kun pystyt hallitsemaan Boxee Boxia. Laiteparin muodostuksesta ei ole mitään visuaalista merkkiä laitteessa.
5. Voit nyt välittömästi käyttää kaukosäädintä.

Pariston vaihtaminen

Irrota paristopidike kolikolla.
Asenna pariston +puoli
alaspäin paristopidikkeeseen.
Työnnä paristopidike takaisin
kaukosäätimeen.

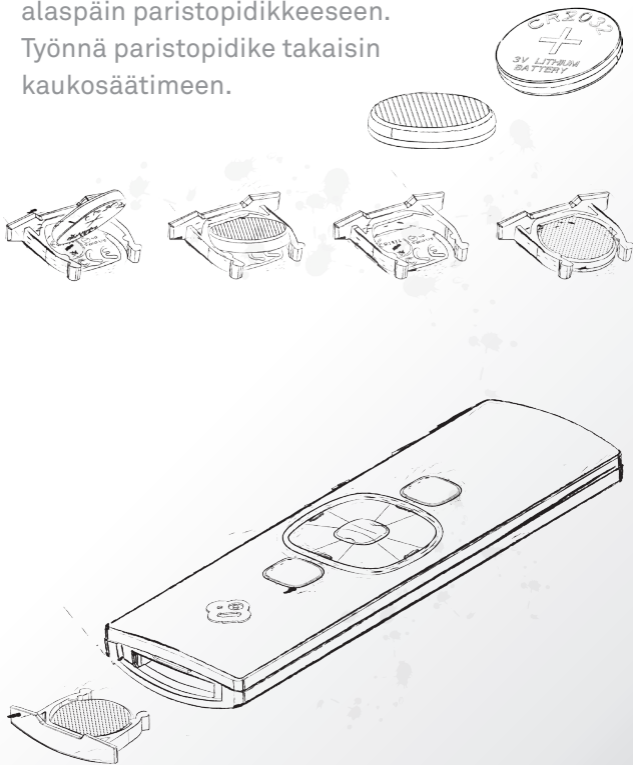

Tarvitsetko apua?

Suomeksi

Internetin kautta : <http://www.dlink.fi>

Tekninen tuki:

Arkisin klo. 9 - 21

Numerosta : 0600 155 57

Din lilla svarta box



Strömanslutning



SD/MMC-kortplats



Din tvåsidiga fjärrkontroll

Spela upp/pausa - Vi vet att du förstår

Styrplatta - Navigera dit du vill

Ok knapp - Acceptera det aktuella valet / visa uppspelningsmenyn

Meny - Gå tillbaka / visa huvudmenyn

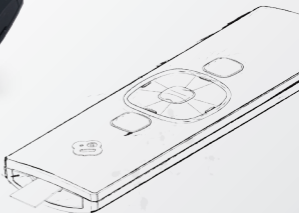

Dra ut plastfliken från fjärrkontrollen för att aktivera batteriet.

Steg 1

Använd den medlevererade HDMI-kabeln och anslut Boxee Box-enheten till teven.

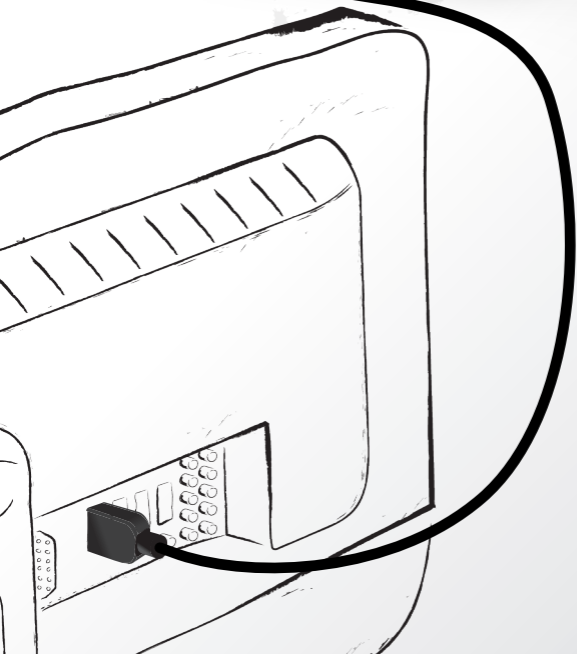

Steg 2

Använd den medlevererade nätadaptern och anslut Boxee Box-enheten till en strömkälla.

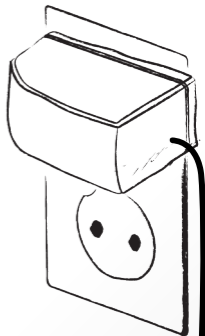

Strömbrytare

Stickproppen kan skilja beroende på region.



Steg 3

Slå på Boxee Box-enheten. Använd sedan tevens fjärrkontroll för att slå på teven och ställa in den till rätt HDMI-ingång. Du ska se Boxee Box-logotypen le åt dig.

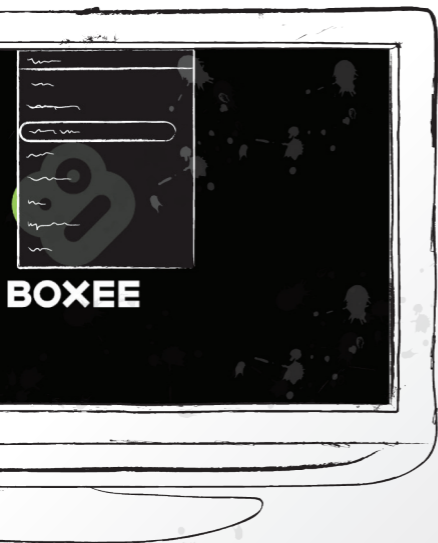

Steg 4

Följ instruktionerna på skärmen för att konfigurera din nya Boxee Box-enhet och ansluta till nätverket.

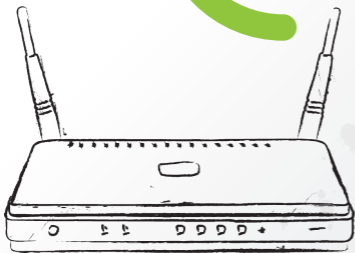

Observera! Din Boxeebox kommer förinställd med aktiverad föräldrakontroll. Du har även möjlighet att ställa in ett lösenord för funktionen under inställningar.

Para Boxee-fjärrkontrollen med Boxee Box-enheten

Fjärrkontrollen paras på fabriken med Boxee Box-enheten. Om du har problem med störningar på fjärrkontrollen från andra enheten kanske du måste para den med Boxee Box-enheten enligt de enkla stegen nedan:

1. Flytta bort övriga enheter från Boxee Box-enheten (eller slå av dem)
2. Placera fjärrkontrollen nära Boxee Box-enheten.
3. Håll OK-tangenten på den enkla sidan av fjärrkontrollen nedtryckt i fem sekunder.
4. Parningen är klar när du kan kontrollera Boxee Box-enheten. Det finns ingen visuell indikering för parning på enheten.
5. Nu kan du direkt använda fjärrkontrollen.

Batteribyte

Ta med ett mynt bort batterihållaren.
Sätt i batteriet med plussidan vänd
nedåt i batterihållaren. Skjut in
batterihållaren i fjärrkontrollen.

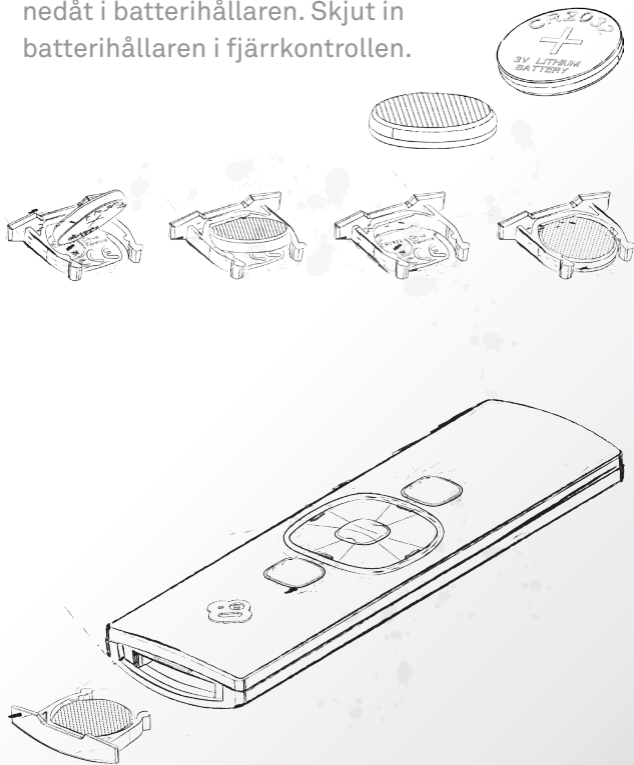

Behöver du hjälp?

Svenska

D-Link Teknisk Support via Internet: <http://www.dlink.se>

D-Link Teknisk Support via telefon: 0900-100 77 00

Vardagar 08:00-20:00

A Sua Pequena Caixa Preta



Alimentação



Entrada do cartão
SD/MMC



O Seu Comando à Distância de Dupla Face

Reproduzir/Pausa - Nós sabemos que consegue

Comando Direccional - Navegar pelo sistema

Botão Enter - Aceitar a selecção actual/exibir o menu de reprodução

Menu - Retroceder/exibir o menu principal

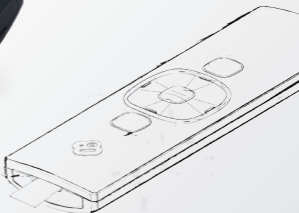

Puxe para fora a patilha plástica do comando à distância para activar a bateria.

Passo 1:

Utilizando o cabo HDMI, ligue a Boxee Caixa para a sua TV.

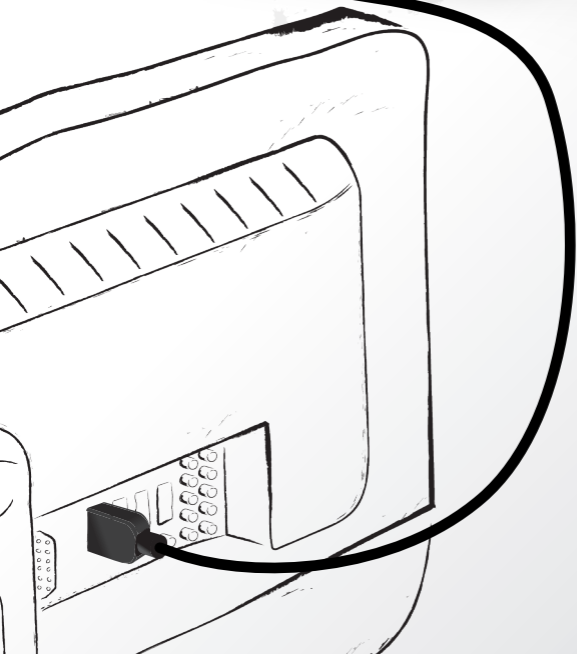

Passo 2:

Utilizando o adaptador de corrente fornecido, ligue a Caixa Boxee a uma fonte de alimentação.

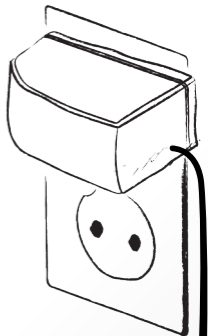

Botão de Alimentação

A tomada de corrente pode ser diferente consoante a região.



Passo 3:

Ligue a sua Caixa Boxee. Em seguida, utilize o comando à distância da televisão para a ligar a televisão e definir a fonte de entrada HDMI correcta. Deverá ver o logótipo da Caixa Boxee a sorrir para si.





Passo 4:

Siga as instruções no ecrã para configurar a sua nova Caixa Boxee e ligar à sua rede.

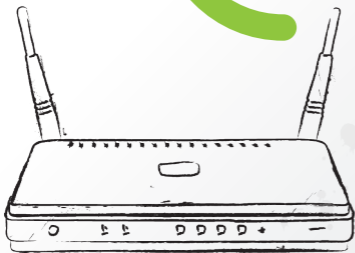

Aviso: Para bloquear conteúdo para adultos, configure o Controlo Parental nas configurações.

Emparelhar o Comando à Distância da sua Boxee com a Caixa Boxee

O seu comando à distância vem da fábrica já emparelhado com a Caixa Boxee. Se estiver a observar interferências de outros dispositivos com o seu comando à distância, pode emparelhar o comando à distância com a Caixa Boxee com os passos simples seguintes:

1. Certifique-se que afasta outros dispositivos da Caixa Boxee (ou os desliga)
2. Coloque o comando à distância perto da Caixa Boxee.
3. Pressione e mantenha pressionado durante 5 segundos a tecla OK no lado simples do comando à distância.
4. O emparelhamento está terminado quando conseguir comandar a Caixa Boxee. No dispositivo não existe indicação visual do emparelhamento.
5. Pode utilizar imediatamente o comando à distância.

Substituir a Pilha

Com uma moeda, retire a bandeja da pilha. Insira a pilha com o lado + virado para baixo na bandeja da bateria. Faça deslizar a bandeja para dentro do comando à distância.



Precisa de Ajuda?

Português

Assistência Técnica da D-Link na Internet:

<http://www.dlink.pt>

Assistência Técnica Telefónica da D-Link: +351 707 78 00 10

Το μικρό μαύρο κουτί σας



Ισχύς

HDMI



υποδοχή κάρτας
SD/MMC



Το τηλεχειριστήριο διπλής όψης

Αναπαραγωγή/Παύση - Γνωρίζουμε
ότι πραγματοποιείται

Επίθεμα κατεύθυνσης - Πλοηγηθείτε
προς όλες τις κατευθύνσεις

Πλήκτρο Enter - Αποδοχή της
τρέχουσας επιλογής / εμφάνιση
μενού αναπαραγωγής

Μενού - Επιστροφή / εμφάνιση
κεντρικού μενού

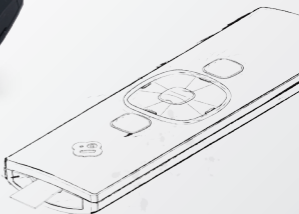

Τραβήξτε προς τα έξω την πλαστική
γλωσσίδα από το τηλεχειριστήριο για
την ενεργοποίηση της μπαταρίας.

Βήμα 1ο

Με τη χρήση του παρεχόμενου καλωδίου HDMI, συνδέστε το Boxee Box στην τηλεόρασή σας.

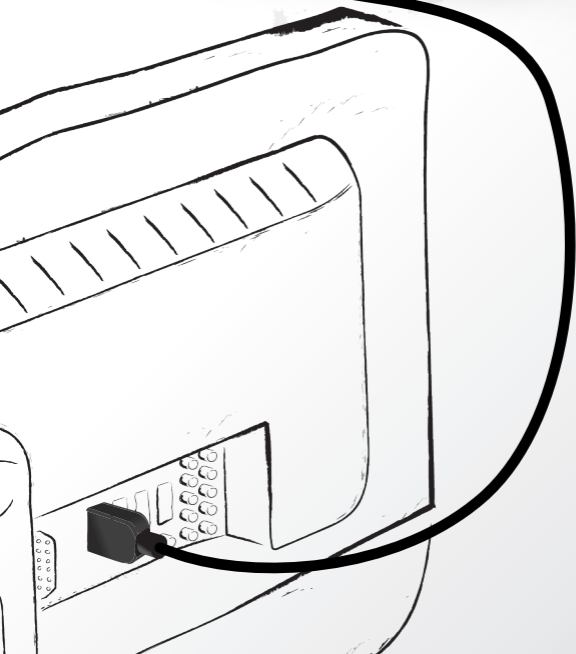

Βήμα 2ο

Με τη χρήση του παρεχόμενου προσαρμογέα ισχύος, συνδέστε το Boxee Box σε μια πηγή ισχύος.

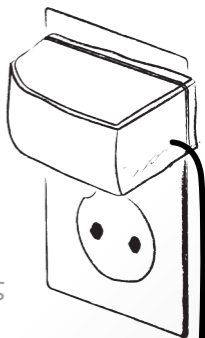

Πλήκτρο ισχύος

Το βύσμα ισχύος μπορεί να διαφέρει ανά περιοχή.



Βήμα 3ο

Ενεργοποιήστε το Boxee Box. Στη συνέχεια, χρησιμοποιήστε το τηλεχειριστήριο της τηλεόρασής σας για να την ενεργοποιήσετε και να τη ρυθμίσετε στη σωστή πηγή εισόδου HDMI. Πρέπει να δείτε το λογότυπο του Boxee Box να σας χαμογελά.

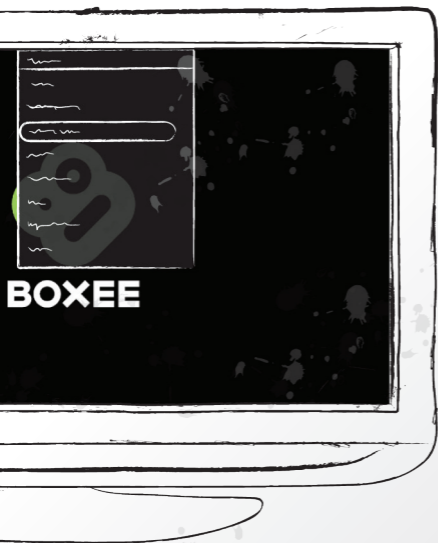



Βήμα 4ο

Ακολουθήστε τις οδηγίες της οθόνης για να διαμορφώσετε το νέο Boxee Box σας και να το συνδέσετε στο δίκτυό σας.

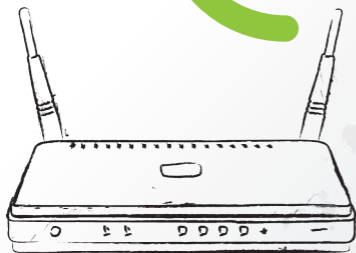

Προειδοποίηση:

Για την παρεμπόδιση περιεχομένου για ενήλικες, διαμορφώστε τους Γονικούς ελέγχους κάτω από τις ρυθμίσεις.

Αντιστοίχιση του τηλεχειριστηρίου Boxee στο Boxee Box

Το τηλεχειριστήριο σας είναι εργαστηριακά αντιστοιχισμένο με το Boxee Box. Εάν παρατηρείτε παρεμβολή του τηλεχειριστηρίου σας από άλλες συσκευές, μπορεί να αντιστοιχίσετε το τηλεχειριστήριο με το Boxee Box με τα εξής εύκολα βήματα:

1. Βεβαιωθείτε ότι έχετε μετακινήσει άλλες συσκευές μακριά από το Boxee Box (ή απενεργοποιήστε τις)
2. Τοποθετήστε το τηλεχειριστήριο κοντά στο Boxee Box.
3. Πιέστε και κρατήστε το πλήκτρο OK από την απλή πλευρά του τηλεχειριστηρίου για 5 δευτερόλεπτα.
4. Η αντιστοίχιση είναι ολοκληρωμένη όταν μπορείτε να ελέγξετε το Boxee Box. Δεν υπάρχει οπτική ένδειξη αντιστοίχιση στη συσκευή.
5. Μπορείτε να χρησιμοποιήσετε άμεσα το τηλεχειριστήριο.

ΑΝτικατάσταση μπαταρίας

Με ένα νόμισμα, αφαιρέστε το δίσκο της μπαταρίας. <εισάγετε τη μπαταρία με την πλευρά + προς τα κάτω στο δίσκο της μπαταρίας. Κυλίστε το δίσκο πίσω στο τηλεχειριστήριο.



Χρειάζεστε βοήθεια σε κάτι;

Ελληνικά

D-Link Hellas Support Center

<http://www.dlink.gr/support>

Κεφαλληνίας 64, 11251 Αθήνα,

Τηλ: 210 86 11 114 (Δευτέρα- Παρασκευή 09:00-17:00)

Φαξ: 210 8611114

Mala crna kutija



Utor za SD/MMC
karticu

Napajanje HDMI



Daljinski upravljač s dva lica

Reprodukcija/pauza - to vam ne trebamo objašnjavati

Područje za navigaciju - Kretanje izbornicima i funkcijama

Gumb za potvrdu - potvrda odabira / otvaranje izbornika reprodukcije

Izbornik - povratak / prikaz glavnog izbornika

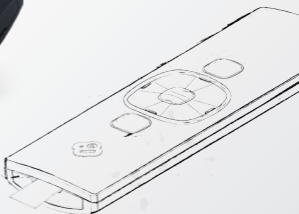

Izvucite plastični jezičak iz daljinskog upravljača, da biste aktivirali bateriju.

1. korak

Uz pomoć
isporučenog HDMI
kabela priključite
Boxee na TV.

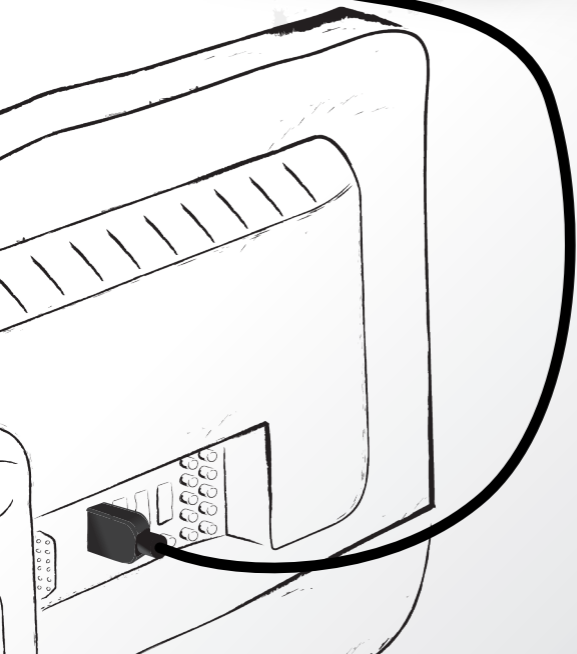

2. korak

Uz pomoć isporučenog adaptera napajanja priključite Boxee na izvor napajanja.

Gumb za uključivanje

Strujni priključak može se razlikovati ovisno o regiji.



3. korak

Uključite uređaj Boxee. Zatim uz pomoć daljinskog upravljača za TV uključite televizor i odaberite točan izvor HDMI signala. Trebali biste vidjeti nasmijani logotip Boxee.



4. korak

Slijedite zaslonske upute za konfiguriranje novog uređaja Boxee i povezivanje s mrežom.

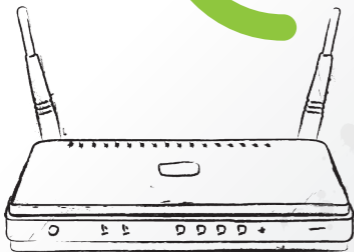

Upozorenje: Da biste blokirali neprimjerene sadržaje, konfigurirajte postavke roditeljskog nadzora.

Uparivanje daljinskog upravljača s uređajem Boxee

Daljinski upravljač tvornički je uparen s uređajem Boxee. Ako primijetite da drugi uređaji ometaju rad daljinskog upravljača, možete lako upariti daljinski upravljač s uređajem Boxee na dolje opisani način:

1. Udaljite ostale uređaje od uređaja Boxee (ili ih isključite)
2. Postavite daljinski upravljač u blizinu uređaja Boxee.
3. Pritisnite i držite gumb OK na strani daljinskog upravljača s manje funkcijskih tipaka u trajanju od 5 sekundi.
4. Uparivanje je dovršeno kad budete mogli upravljati uređajem Boxee. Nema vizualnog upozorenja da je uparivanje uspješno dovršeno.
5. Možete odmah početi s korištenjem daljinskog upravljača.

Zamjena baterije

Kovanicom uklonite odjeljak za bateriju. Umetnite bateriju tako da strana s oznakom + bude okrenuta prema dolje u odjeljku. Vratite odjeljak u daljinski upravljač.



Potrebna vam je pomoć?

Hrvatski

Hvala vam na odabiru D-Link proizvoda. Za dodatne informacije, podršku i upute za korištenje uređaja, molimo vas da posjetite D-Link internetsku stranicu na www.dlink.eu www.dlink.biz/hr

Vaša majhna črna škatla



Napajanje HDMI



Reža za kartico SD/MMC



Vaš dvostranski daljinski upravljalac

Predvajanje/Premor - Vemo, da boste rabili

Smerna ploščica - Premikajte se naokoli

Gumb za vnos - Potrditev trenutne izbire / prikaz menija predvajanja

Meni - Korak nazaj / prikaz glavnega menija

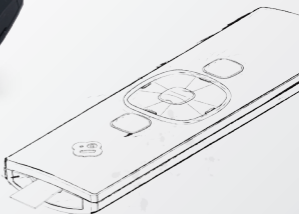

Izvalcite plastični zavihek iz daljinskega upravljalca, da aktivirate baterijo.

Korak 1

S pomočjo kabla HDMI povežite Boxee Box z vašim televizorjem.

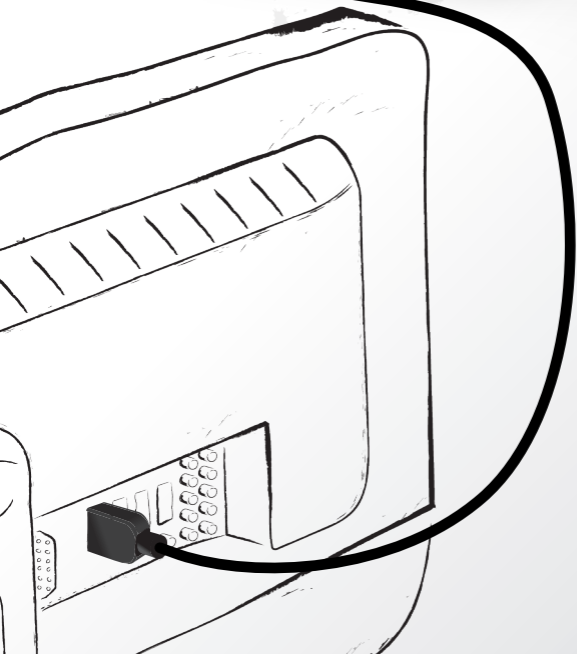

Korak 2

S pomočjo dostavljenega napajalnega adapterja, vklopite Boxee Box v vir napajanja.

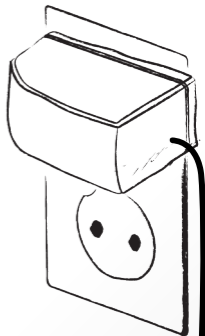

Gumb za vklop

Napajalni vtič se lahko razlikuje, odvisno od regije.



Korak 3

Vklopite svojo Boxee Box. Potem vklopite televizor s pomočjo daljinskega upravljalca televizorja in nastavite ustrezni vhodni vir HDMI. Morali bi videti logo Boxee Box, kako se vam smehlja.

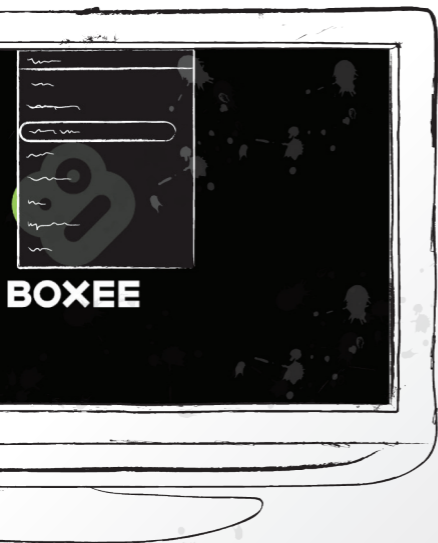



Korak 4

Sledite navodila na zaslону za nastavitve vašega novega Boxee Box in za povezovanje z omrežjem.

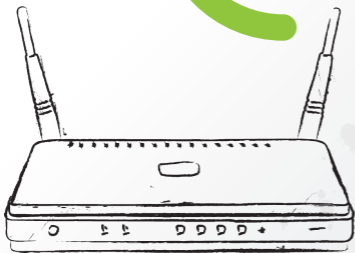

Opozorilo: Za blokiranje vsebine za odrasle nastavite Starševski nadzor v nastavitvah.

Povezovanje daljinskega upravljalca Boxee in Boxee Box

Vaš daljinski upravljalac je že tovarniški povezan s Boxee Box. Če opazite motnje v delovanju daljinskega upravljalca s strani drugih naprav, lahko sledite preprostim korakom spodaj in povežete daljinski upravljalac z Boxee Box:

1. Prepričajte se, da so druge naprave odmaknjene stran od Boxee Box (ali pa jih izklopite)
2. Namestite daljinski upravljalac v neposredno bližino Boxee Box.
3. Pritisnite in držite gumb OK na preprosti strani daljinskega upravljalca za 5 sekund.
4. Povezovanje je opravljeno, ko lahko upravljate Boxee Box. Za povezovanje naprave ni vidne potrditve.
5. Lahko takoj uporabljate svoj daljinski upravljalac.

Zamenjava baterije

S pomočjo kovanca odprite pokrov oddelka za baterijo. Vstavite baterijo tako, da bo + stran baterije obrnjena navzdol v oddelku za baterijo. Potisnite pokrov nazaj v daljinski upravljalac.



Potrebujete pomoč?

Slovenski

Zahvaljujemo se vam, ker ste izbrali D-Link proizvod. Za vse nadaljnje informacije, podporo ter navodila za uporabo prosimo obiščite D-Link - ovo spletno stran www.dlink.eu
www.dlink.biz/sl

Mica dvs. cutie neagră



Alimentare

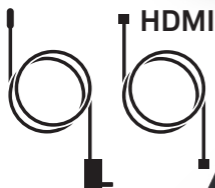

Slot de card SD/MMC



Telecomanda cu două fațete

Redare/Pauză - Știm că ați înțeles

Tastatură direcțională - Utilizați pentru navigare

Butonul Enter - Acceptă selecția curentă/afișează meniul de redare

Meniu - Salt înapoi/afișează meniul principal

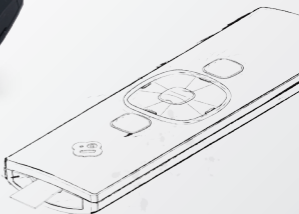

Scoateți lamela de plastic de pe telecomandă pentru a activa bateria.

Pasul 1

Utilizând cablul HDMI furnizat, conectați dispozitivul Boxee la aparatul TV.

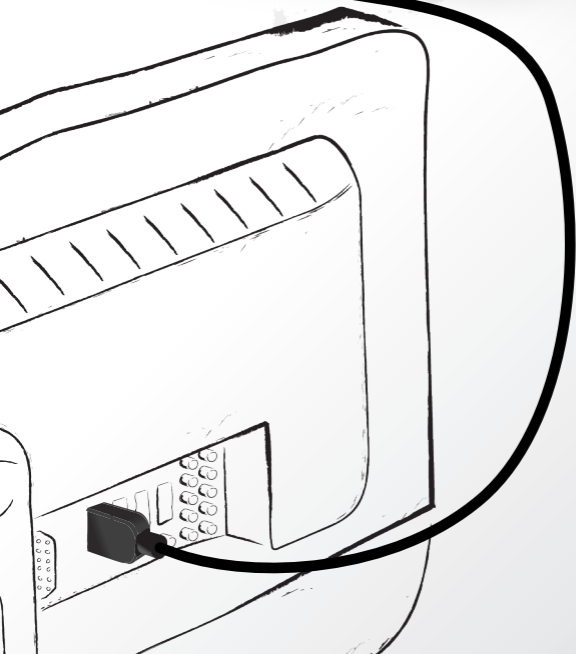

Pasul 2

Utilizând adaptorul de alimentare furnizat, conectați dispozitivul Boxee la o sursă de alimentare.

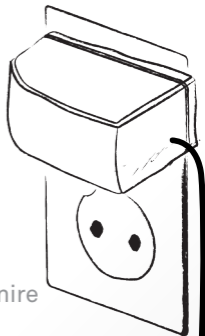

Buton de pornire

Este posibil ca fișa de rețea să difere în funcție de regiune.



Pasul 3

Porniți dispozitivul Boxee. Apoi utilizați telecomanda aparatului TV pentru a porni aparatul TV și setați-l la sursa de intrare HDMI corectă. Trebuie să vedeți sigla dispozitivului Boxee care vă zâmbeste.



Pasul 4

Urmați instrucțiunile de pe ecran pentru a vă configura noul dispozitiv Boxee și conectați-vă la rețea.

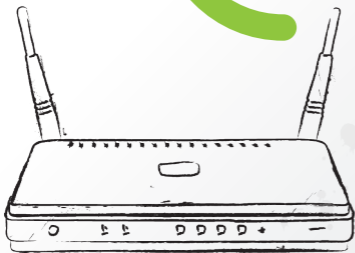

Avertisment: Pentru blocarea conținutului pentru adulți, configurați setările Parental Controls (Controale parentale).

Sincronizarea telecomenzii Boxee cu dispozitivul Boxee

Telecomanda este deja sincronizată din fabrică cu dispozitivul Boxee. Dacă observați interferențe ale telecomenzii cu alte dispozitive, puteți să sincronizați telecomanda cu dispozitivul Boxee în pașii simpli de mai jos:

1. Asigurați-vă că mutați alte dispozitive la distanță de dispozitivul Boxee (sau opriți-le)
2. Așezați telecomanda în apropierea dispozitivului Boxee.
3. Apăsați și țineți apăsată tasta OK (OK) de pe partea simplă a telecomenzii timp de 5 secunde.
4. Sincronizarea este finalizată când puteți să controlați dispozitivul Boxee. Nu există o indicare vizuală a sincronizării pe dispozitiv.
5. Puteți să utilizați telecomanda imediat.

Înlocuirea bateriei

Cu o monedă, scoateți tava bateriei. Introduceți bateria cu partea + în jos în tava bateriei. Glisați tava bateriei în telecomandă.

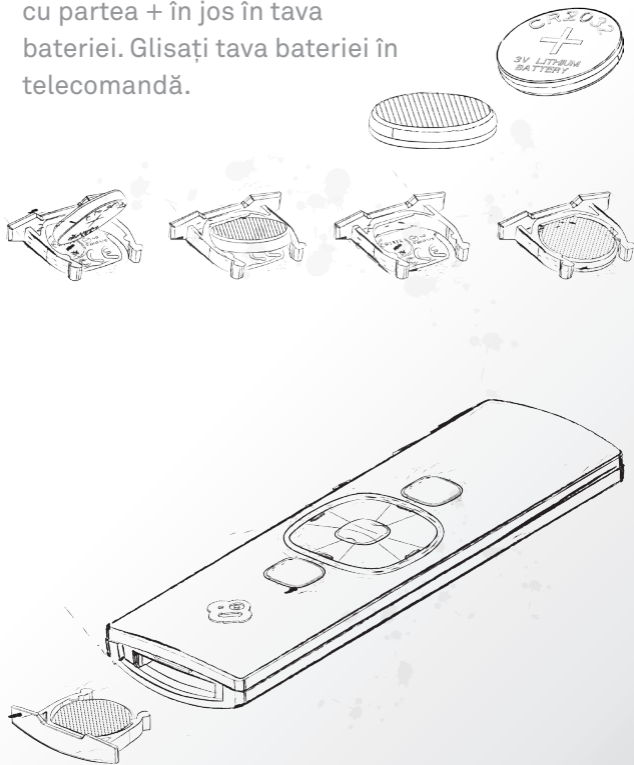

Aveți nevoie de ajutor?

Română

Vă mulțumim pentru alegerea produselor D-Link. Pentru mai multe informații, suport și manuale ale produselor vă rugăm să vizitați site-ul D-Link www.dlink.eu
www.dlink.ro

BOXEE BOX