



X S T A C K User Manual

Product Model: **xStack**[™] DES-3500 Series
Layer 2 Managed Stackable Fast Ethernet Switch
Release 5

Information in this document is subject to change without notice.

© 2007 D-Link Corporation. All rights reserved.

Reproduction in any manner whatsoever without the written permission of D-Link Corporation is strictly forbidden.

Trademarks used in this text: D-Link and the D-LINK logo are trademarks of D-Link Corporation; Microsoft and Windows are registered trademarks of Microsoft Corporation.

Other trademarks and trade names may be used in this document to refer to either the entities claiming the marks and names or their products. D-Link Corporation disclaims any proprietary interest in trademarks and trade names other than its own.

October 2007

Table of Contents

Preface	viii
Intended Readers.....	ix
Typographical Conventions	ix
Notes, Notices, and Cautions	ix
Safety Instructions	x
Safety Cautions	x
General Precautions for Rack-Mountable Products	xi
Protecting Against Electrostatic Discharge	xii
Introduction.....	1
Switch Description.....	1
Features	1
Ports	2
Front-Panel Components.....	2
LED Indicators	3
Rear Panel Description.....	4
Side Panel Description	4
Gigabit Combo Ports.....	5
Installation	7
Package Contents	7
Before You Connect to the Network.....	7
Installing the Switch without the Rack.....	8
Installing the Switch in a Rack.....	9
Mounting the Switch in a Standard 19" Rack	10
Power On (AC Power).....	11
Power Failure.....	11
Connecting DC Power to DES-3526DC	11
Connecting the Switch	12
Switch to End Node	12
Switch to Hub or Switch	13
Connecting To Network Backbone or Server	14
Introduction to Switch Management.....	15
Management Options.....	15
Web-based Management Interface.....	15
SNMP-Based Management.....	15
Connecting the Console Port (RS-232 DCE).....	15
First Time Connecting to the Switch.....	17
Password Protection.....	17
SNMP Settings.....	19

Traps	19
MIBs	19
IP Address Assignment	20
Connecting Devices to the Switch	21
Web-based Switch Configuration	22
Introduction.....	22
Login to Web Manager	22
Web-based User Interface	23
Areas of the User Interface	23
Web Pages.....	23
Configuring the Switch.....	25
Switch Information	26
IP Address.....	26
Advanced Settings	29
Port Configuration	31
Port Description	33
Port Mirroring.....	34
Link Aggregation.....	35
Understanding Port Trunk Groups	35
LACP Port Setting	38
MAC Notification.....	39
MAC Notification Global Settings.....	39
MAC Notification Port Settings.....	40
IGMP	41
IGMP Snooping	41
Static Router Ports Entry.....	43
Forbidden Router Ports Entry	44
IGMP Multicast VLAN.....	45
Spanning Tree.....	48
802.1s MSTP	48
802.1w Rapid Spanning Tree.....	48
Port Transition States	48
Edge Port.....	49
P2P Port	49
802.1d/802.1w/802.1s Compatibility	49
STP Bridge Global Settings	50
MST Configuration Table	53
MSTI Settings	55
STP Instance Settings.....	56
MSTP Port Information.....	57
Loopback Detection.....	60
Forwarding Filtering	61

Unicast Forwarding.....	61
Multicast Forwarding.....	62
Multicast Port Filtering Mode.....	63
VLANs.....	64
Understanding IEEE 802.1p Priority.....	64
VLAN Description.....	64
Notes about VLANs on the xStack DES-3500 Series switches.....	64
IEEE 802.1Q VLANs.....	64
802.1Q VLAN Tags.....	66
Port VLAN ID.....	66
Tagging and Untagging.....	67
Ingress Filtering.....	67
Default VLANs.....	67
Port-based VLANs.....	68
VLAN Segmentation.....	68
Asymmetric VLANs.....	69
VLAN and Trunk Groups.....	70
Static VLAN Entry.....	70
GVRP Setting.....	72
Traffic Control.....	73
Port Security.....	76
QoS.....	77
Advantages of QoS.....	77
Understanding QoS.....	78
Port Bandwidth.....	79
Scheduling.....	80
802.1p Default Priority.....	81
802.1p User Priority.....	81
Traffic Segmentation.....	82
System Severity Alerts.....	83
System Log Server.....	83
SNTP Settings.....	85
Time Setting.....	85
Time Zone and DST.....	86
Access Profile Table.....	88
Configuring the Access Profile Table.....	88
CPU Interface Filtering.....	100
CPU Interface Filtering Profile Table.....	100
Port Access Entity (802.1X).....	110
802.1x Port-Based and MAC-Based Access Control.....	110
Authentication Server.....	111
Authenticator.....	111

Client.....	112
Authentication Process.....	112
Port-Based Network Access Control.....	113
MAC-Based Network Access Control	114
Configure Authenticator.....	115
PAE System Control	117
Port Capability	117
Initializing Ports for Port Based 802.1x	118
Initializing Ports for MAC Based 802.1x.....	119
Reauthenticate Port(s) for Port Based 802.1x	119
RADIUS Server	120
Guest VLANs.....	121
Limitations Using the Guest VLAN.....	121
Guest VLAN Configuration	121
IP-MAC Binding.....	122
ACL Mode	122
IP-MAC Binding Port	125
IP-MAC Binding Table.....	126
IP-MAC Binding Blocked.....	127
Limited IP Multicast Range	128
Limited IP Multicast Range Profile Setting	128
Limited IP Multicast Range Status Setting	129
Limited IP Multicast Range Setting	130
Layer 3 IP Networking.....	131
Static ARP Table.....	131
DHCP/BOOTP Relay.....	132
DHCP / BOOTP Relay Global Settings	132
The Implementation of DHCP Information Option 82 in the xStack DES-3500 Series switches	134
DHCP/BOOTP Relay Interface Settings.....	135
Management.....	136
Security IP	136
User Accounts.....	137
Admin and User Privileges	138
Access Authentication Control	138
Policy & Parameters.....	140
Application's Authentication Settings	140
Authentication Server Group Settings.....	141
Authentication Server Hosts.....	142
Login Method Lists	144
Enable Method Lists	145
Local Enable Password	146
Enable Admin	147

Secure Socket Layer (SSL)	148
Download Certificate	148
Configuration	149
Secure Shell (SSH)	150
SSH Configuration	150
SSH Algorithm.....	151
SSH User Authentication	153
SNMP Manager	154
SNMP Settings.....	154
Traps	154
MIBs	154
SNMP User Table	155
SNMP View Table	157
SNMP Group Table.....	158
SNMP Community Table Configuration	159
SNMP Host Table	160
SNMP Engine ID	161
Safeguard Engine	162
Filter.....	164
DHCP Server Screening Setting	164
DHCP Client Filtering Setting	165
NetBIOS Filtering Setting	166
Monitoring	168
Port Utilization.....	168
CPU Utilization.....	169
Packets	170
Received (RX).....	170
UMB Cast (RX)	171
Transmitted (TX)	173
Errors	175
Received (RX).....	175
Transmitted (TX)	176
Size	178
MAC Address	180
Switch History Log.....	181
IGMP Snooping Group.....	182
IGMP Snooping Forwarding.....	183
VLAN Status.....	184
Router Port.....	184
Port Access Control	185
Authenticator State.....	185

Layer 3 Feature	187
Browse ARP Table.....	187
Safeguard Engine Status	188
Maintenance.....	189
TFTP Services.....	189
Download Firmware from TFTP Server	189
Download Configuration File.....	190
Upload Configuration.....	190
Upload Log	191
Multiple Image Services	192
Firmware Information	192
Config Firmware Image	193
Ping Test	193
Save Changes.....	194
Reset	194
Reset System.....	195
Reset Config	195
Reboot Device.....	195
Logout.....	195
D-Link Single IP Management	196
Single IP Management (SIM) Overview.....	196
The Upgrade to v1.6.....	197
SIM Using the Web Interface	198
Topology.....	199
Tool Tips.....	201
Right-Click.....	202
Group Icon	202
Commander Switch Icon.....	203
Member Switch Icon	204
Candidate Switch Icon	204
Menu Bar	206
Group	206
Device	206
View.....	206
Firmware Upgrade	207
Configuration File Backup/Restore.....	207
Upload Log File	207
Technical Specifications	208
Cables and Connectors.....	210
System Log Entries	211
Cable Lengths	222
Glossary	223

Warrenties/Registration	226
Tech Support.....	234

Preface

The *DES-3500 Series Manual* is divided into sections that describe the system installation and operating instructions with examples.

Section 1, Introduction - Describes the Switch and its features.

Section 2, Installation- Helps you get started with the basic installation of the Switch and also describes the front panel, rear panel, side panels, and LED indicators of the Switch. Included in this section is a description of how to hook up the DC power supply for the DES-3500 Series switches.

Section 3, Connecting the Switch - Tells how you can connect the Switch to your Ethernet/Fast Ethernet network.

Section 4, Introduction to Switch Management - Introduces basic Switch management features, including password protection, SNMP settings, IP address assignment and connecting devices to the Switch.

Section 5, Introduction to Web-based Switch Management - Talks about connecting to and using the Web-based switch management feature on the Switch.

Section 6, Configuring the Switch - A detailed discussion about configuring some of the basic functions of the Switch, including accessing the Switch information, using the Switch's utilities and setting up network configurations, such as Quality of Service, The Access Profile Table, port mirroring and configuring the Spanning Tree.

Section 7, Management - A discussion of the security features of the Switch, including Security IP, User Accounts, Access Authentication Control, and SNMP.

Section 8, Monitoring - Features graphs and screens used in monitoring features and packets on the Switch.

Section 9, Maintenance - Features information on Switch utility functions, including TFTP Services, Switch History, Ping Test Save Changes and Rebooting Services.

Section 10, Single IP Management - Discussion on the Single IP Management function of the Switch, including functions and features of the Java based user interface and the utilities of the SIM function.

Appendix A, Technical Specifications - The technical specifications of the DES-3500 Series switches.

Appendix B, Cables and Connectors - Describes the RJ-45 receptacle/connector, straight through and crossover cables and standard pin assignments.

Appendix C, Cable Lengths - Information on cable types and maximum distances.

Glossary - Lists definitions for terms and acronyms used in this document.

Intended Readers

The *DES-3500 Manual* contains information for setup and management of the Switch. This manual is intended for network managers familiar with network management concepts and terminology.

Typographical Conventions

Convention	Description
[]	In a command line, square brackets indicate an optional entry. For example: [copy filename] means that optionally you can type copy followed by the name of the file. Do not type the brackets.
Bold font	Indicates a button, a toolbar icon, menu, or menu item. For example: Open the File menu and choose Cancel . Used for emphasis. May also indicate system messages or prompts appearing on your screen. For example: You have mail. Bold font is also used to represent filenames, program names and commands. For example: use the copy command.
Boldface Typewriter Font	Indicates commands and responses to prompts that must be typed exactly as printed in the manual.
Initial capital letter	Indicates a window name. Names of keys on the keyboard have initial capitals. For example: Click Enter.
<i>Italics</i>	Indicates a window name or a field. Also can indicate a variables or parameter that is replaced with an appropriate word or string. For example: type filename means that you should type the actual filename instead of the word shown in italic.
Menu Name > Menu Option	Menu Name > Menu Option Indicates the menu structure. Device > Port > Port Properties means the Port Properties menu option under the Port menu option that is located under the Device menu.

Notes, Notices, and Cautions



A **NOTE** indicates important information that helps you make better use of your device.



A **NOTICE** indicates either potential damage to hardware or loss of data and tells you how to avoid the problem.



A **CAUTION** indicates a potential for property damage, personal injury, or death.

Safety Instructions

Use the following safety guidelines to ensure your own personal safety and to help protect your system from potential damage. Throughout this document, the caution icon (⚠) is used to indicate cautions and precautions that you need to review and follow.



Safety Cautions

To reduce the risk of bodily injury, electrical shock, fire, and damage to the equipment, observe the following precautions.

- Observe and follow service markings.
 - Do not service any product except as explained in your system documentation.
 - Opening or removing covers that are marked with the triangular symbol with a lightning bolt may expose you to electrical shock.
 - Only a trained service technician should service components inside these compartments.
- If any of the following conditions occur, unplug the product from the electrical outlet and replace the part or contact your trained service provider:
 - The power cable, extension cable, or plug is damaged.
 - An object has fallen into the product.
 - The product has been exposed to water.
 - The product has been dropped or damaged.
 - The product does not operate correctly when you follow the operating instructions.
- Keep your system away from radiators and heat sources. Also, do not block cooling vents.
- Do not spill food or liquids on your system components, and never operate the product in a wet environment. If the system gets wet, see the appropriate section in your troubleshooting guide or contact your trained service provider.
- Do not push any objects into the openings of your system. Doing so can cause fire or electric shock by shorting out interior components.
- Use the product only with approved equipment.
- Allow the product to cool before removing covers or touching internal components.
- Operate the product only from the type of external power source indicated on the electrical ratings label. If you are not sure of the type of power source required, consult your service provider or local power company.
- To help avoid damaging your system, be sure the voltage on the power supply is set to match the power available at your location:
 - 115 volts (V)/60 hertz (Hz) in most of North and South America and some Far Eastern countries such as South Korea and Taiwan
 - 100 V/50 Hz in eastern Japan and 100 V/60 Hz in western Japan
 - 230 V/50 Hz in most of Europe, the Middle East, and the Far East
 - –48 VDC for DC power supply unit on DES-3526DC only
- Also, be sure that attached devices are electrically rated to operate with the power available in your location.
- Use only approved power cable(s). If you have not been provided with a power cable for your system or for any AC-powered option intended for your system, purchase a power cable that is approved for use in your country. The power cable must be rated for the product and for the voltage and current marked on the product's electrical ratings label. The voltage and current rating of the cable should be greater than the ratings marked on the product.
- To help prevent electric shock, plug the system and peripheral power cables into properly grounded electrical outlets. These cables are equipped with three-prong plugs to help ensure proper grounding. Do not use adapter plugs or remove the grounding prong from a cable. If you must use an extension cable, use a 3-wire cable with properly grounded plugs.

- Observe extension cable and power strip ratings. Make sure that the total ampere rating of all products plugged into the extension cable or power strip does not exceed 80 percent of the ampere ratings limit for the extension cable or power strip.
- To help protect your system from sudden, transient increases and decreases in electrical power, use a surge suppressor, line conditioner, or uninterruptible power supply (UPS).
- Position system cables and power cables carefully; route cables so that they cannot be stepped on or tripped over. Be sure that nothing rests on any cables.
- Do not modify power cables or plugs. Consult a licensed electrician or your power company for site modifications. Always follow your local/national wiring rules.
- When connecting or disconnecting power to hot-pluggable power supplies, if offered with your system, observe the following guidelines:
 - Install the power supply before connecting the power cable to the power supply.
 - Unplug the power cable before removing the power supply.
 - If the system has multiple sources of power, disconnect power from the system by unplugging all power cables from the power supplies.
- Move products with care; ensure that all casters and/or stabilizers are firmly connected to the system. Avoid sudden stops and uneven surfaces.



General Precautions for Rack-Mountable Products

Observe the following precautions for rack stability and safety. Also, refer to the rack installation documentation accompanying the system and the rack for specific caution statements and procedures.

- Systems are considered to be components in a rack. Thus, "component" refers to any system as well as to various peripherals or supporting hardware.
- Before working on the rack, make sure that the stabilizers are secured to the rack, extended to the floor, and that the full weight of the rack rests on the floor. Install front and side stabilizers on a single rack or front stabilizers for joined multiple racks before working on the rack.
- Always load the rack from the bottom up, and load the heaviest item in the rack first.
- Make sure that the rack is level and stable before extending a component from the rack.
- Use caution when pressing the component rail release latches and sliding a component into or out of a rack; the slide rails can pinch your fingers.
- After a component is inserted into the rack, carefully extend the rail into a locking position, and then slide the component into the rack.
- Do not overload the AC supply branch circuit that provides power to the rack. The total rack load should not exceed 80 percent of the branch circuit rating.
- Ensure that proper airflow is provided to components in the rack.
- Do not step on or stand on any component when servicing other components in a rack.



NOTE: A qualified electrician must perform all connections to DC power and to safety grounds. All electrical wiring must comply with applicable local, regional or national codes and practices.



CAUTION: Never defeat the ground conductor or operate the equipment in the absence of a suitably installed ground conductor. Contact the appropriate electrical inspection authority or an electrician if you are uncertain that suitable grounding is available.



CAUTION: The system chassis must be positively grounded to the rack cabinet frame. Do not attempt to connect power to the system until grounding cables are connected. A qualified electrical inspector must inspect completed power and safety ground wiring. An energy hazard will exist if the safety ground cable is omitted or disconnected.

Protecting Against Electrostatic Discharge

Static electricity can harm delicate components inside your system. To prevent static damage, discharge static electricity from your body before you touch any of the electronic components, such as the microprocessor. You can do so by periodically touching an unpainted metal surface on the chassis.

You can also take the following steps to prevent damage from electrostatic discharge (ESD):

1. When unpacking a static-sensitive component from its shipping carton, do not remove the component from the antistatic packing material until you are ready to install the component in your system. Just before unwrapping the antistatic packaging, be sure to discharge static electricity from your body.
2. When transporting a sensitive component, first place it in an antistatic container or packaging.
3. Handle all sensitive components in a static-safe area. If possible, use antistatic floor pads, workbench pads and an antistatic grounding strap.

Section 1

Introduction

Switch Description

Features

Ports

Front-Panel Components

Side Panel Description

Rear Panel Description

Gigabit Combo Ports

The DES-3500 layer 2 Fast Ethernet switches are members of the D-Link xStack family. Ranging from 10/100Mbps edge switches to core gigabit switches, the xStack switch family has been future-proof designed to provide a stacking architecture with fault tolerance, flexibility, port density, robust security and maximum throughput with a user-friendly management interface for the networking professional.

The following manual describes the installation, maintenance and configurations concerning members of the xStack DES-3500 switch series. These three switches, the DES-3526, DES-3526DC, and the DES-3550 are all very similar in configurations and basic hardware and consequentially, most of the information in this manual will be universal to the whole xStack DES-3500 switch series. Corresponding screen pictures of the web manager may be taken from any one of these switches but the configuration will be identical, except for varying port counts.

Switch Description

The DES-3500 Series switches are equipped with unshielded twisted-pair (UTP) cable ports providing dedicated 10 or 100 Mbps bandwidth. The Switch has 24 UTP ports (48 UTP ports for the DES-3550) and Auto MDI-X/MDI-II convertible ports that can be used for unlinking to another switch. These ports can be used for connecting PCs, printers, servers, hubs, routers, switches and other networking devices. The dual speed ports use standard twisted-pair cabling and are ideal for segmenting networks into small, connected sub networks for superior performance. Each 10/100 port can support up to 200 Mbps of throughput in full-duplex mode.

In addition, the Switch has 2 Mini-GBIC combo ports. These two-gigabit combo ports are ideal for connecting to a server or network backbone.

This stand-alone Switch enables the network to use some of the most demanding multimedia and imaging applications concurrently with other user applications without creating bottlenecks. The built-in console interface can be used to configure the Switch's settings for priority queuing, VLANs, and port trunk groups, port monitoring, and port speed.



NOTE: For the remainder of this manual, all hardware versions of the DES-3500 Series switches will be referred to as simply the Switch or the DES-3500 except where the differences are relevant.

Features

- IEEE 802.3 10BASE-T compliant
- IEEE 802.3u 100BASE-TX compliant
- IEEE 802.1p Priority Queues
- IEEE 802.3x flow control in full duplex mode
- IEEE 802.3ad Link Aggregation Control Protocol support.
- IEEE 802.1x Port-based and MAC-based Access Control
- IEEE 802.1Q VLAN
- IEEE 802.1D Spanning Tree, IEEE 802.1W Rapid Spanning Tree and IEEE 802.1s Multiple Spanning Tree support
- Access Control List (ACL) support
- Single IP Management support
- Access Authentication Control utilizing TACACS, XTACACS and TACACS+
- Dual Image Firmware
- Simple Network Time Protocol support

- MAC Notification support
- Asymmetric VLAN support
- System and Port Utilization support
- System Log Support
- Address table: Supports up to 8K MAC addresses per device
- Supports 16M Bytes buffer memory per device
- Supports Port-based VLAN Groups
- Port Trunking with flexible load distribution and fail-over function
- IGMP Snooping support
- SNMP support
- Secure Sockets Layer (SSL) and Secure Shell (SSH) support
- Port Mirroring support
- MIB support for:
 - RFC1213 MIB II
 - RFC1493 Bridge
 - RFC1757 RMON
 - RFC1643 Ether-like MIB
 - RFC2233 Interface MIB
 - Private MIB
 - RFC2674 for 802.1p
 - IEEE 802.1x MIB
- RS-232 DCE console port for Switch management
- Provides parallel LED display for port status such as link/act, speed, etc.
- High performance switching engine performs forwarding and filtering at full wire speed, maximum 14, 881 packets/sec on each 10Mbps Ethernet port, and maximum 148,810 packet/sec on 100Mbps Fast Ethernet port.
- Full- and half-duplex for both 10Mbps and 100Mbps connections. Full duplex allows the switch port to simultaneously transmit and receive data. It only works with connections to full-duplex-capable end stations and switches. Connections to a hub must take place at half-duplex
- Support broadcast storm filtering
- Non-blocking store and forward switching scheme capability to support rate adaptation and protocol conversion
- Supports by-port Egress/Ingress rate control.
- Supports IP-MAC Port Binding.
- Efficient self-learning and address recognition mechanism enables forwarding rate at wire speed
- Safeguard Engine Support

Ports

- Twenty-four (48 for the DES-3550) high-performance (MDI-X/MDI-II) ports for connecting to end stations, servers, hubs and other networking devices.
- All UTP ports can auto-negotiate between 10Mbps and 100Mbps, half-duplex and full duplex, and feature flow control.
- Two 1000BASE-T Mini-GBIC combo ports for connecting to another switch, server, or network backbone.
- RS-232 DCE Diagnostic port (console port) for setting up and managing the Switch via a connection to a console terminal or PC using a terminal emulation program.



NOTE: For customers interested in D-View, D-Link Corporation's proprietary SNMP management software, go to the D-Link Website (www.dlink.com) and download the software and manual.

Front-Panel Components

The front panel of the Switch consists of LED indicators for power and for each 10/100 Mbps twisted-pair ports, and two 1000BASE-T Mini-GBIC ports.



Figure 1- 1. Front Panel View of the DES-3526 switch

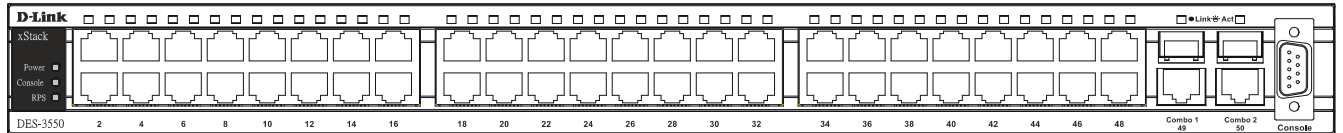

Figure 1- 2. Front Panel View of the DES-3550 switch

The DES-3526DC does not support a redundant power supply and therefore the RPS indicator does not appear on the front panel.

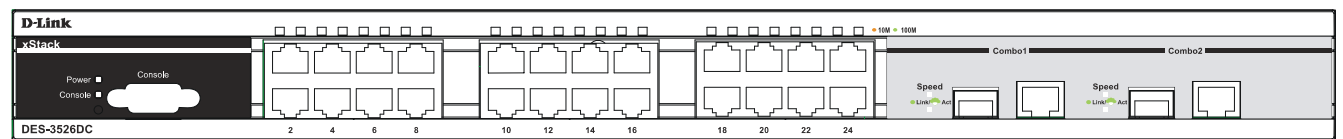

Figure 1- 3. Front Panel View of DES-3526DC

Comprehensive LED indicators display the status of the Switch and the network.

LED Indicators

The Switch supports LED indicators for Power, Console, RPS (DES-3526/3550) and Port LEDs. The following shows the LED indicators for the DES-3500 Series switches along with an explanation of each indicator. LEDs and their corresponding meanings are displayed below.

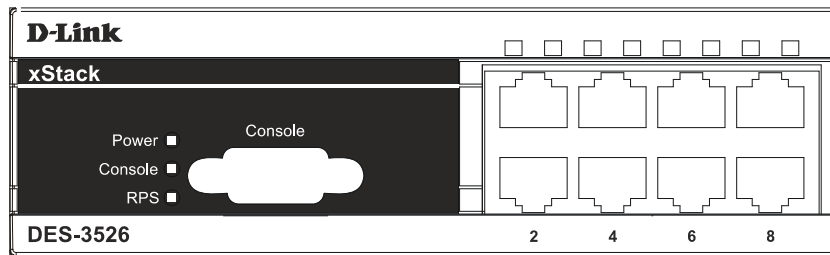

Figure 1- 4. LED Indicators on DES-3526 Series switches

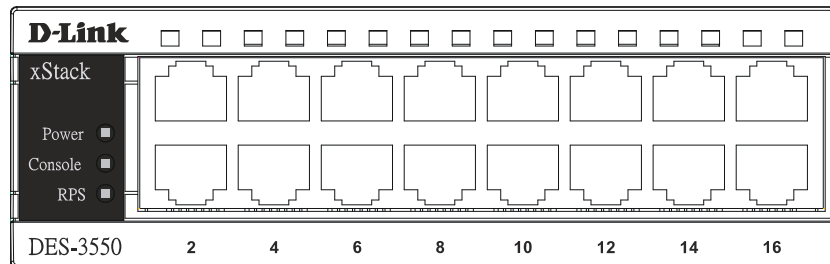

Figure 1- 5. Indicators on DES-3550 Series switch

LED	Description
Power	This LED will light green after the Switch is powered on to indicate the ready state of the device. The indicator is dark when the Switch is powered off.
Console	This LED should blink during the Power-On Self Test (POST). When the POST is finished, the LED goes dark. This indicator is lit solid green when the Switch is being logged into via out-of-band/local console management through the RS-232 console port in the back of the Switch using a straight-through serial cable.
RPS (DES-3526DC not supported)	This LED will be lit when the redundant power supply is present and in use. Otherwise it will remain dark.
Port LEDs	<p>One row of LEDs for each port is located above the ports on the front panel. The first LED is for the top port and the second one is for the bottom ports. These port LEDs will light two different colors for 10M and 100M.</p> <ul style="list-style-type: none"> Amber - For speeds of 10 Mbps. A solid light denotes activity on the port while a blinking light indicates a valid link. Green - For speeds of 100 Mbps. A solid light denotes activity on the port while a blinking light indicates a valid link.
100M/10M	These LEDs will light steady green to indicate that the port is transferring data at 100Mbps.
Gigabit Ports	<p>The Switch's two Mini GBIC ports have their own corresponding LEDs:</p> <p>Speed - This LED will light solid green when the port is transferring at a rate of 1000Mbps. When dark, the port is transferring at 10/100Mbps.</p> <p>Link/Act - This LED will light solid green when there is a valid link. A blinking LED indicates current activity on the port. A dark LED indicates no activity on the port.</p>

Rear Panel Description

The rear panel of the Switch contains an AC power connector.

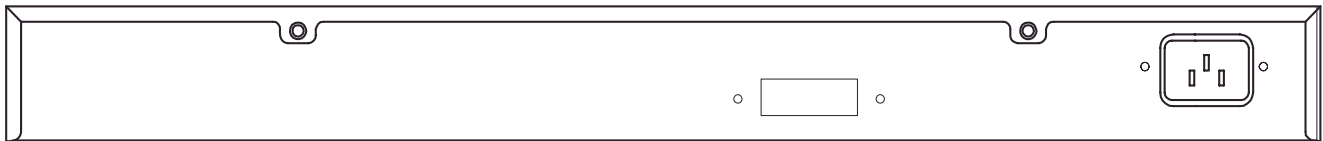

Figure 1- 6. Rear panel view of the DES-3526

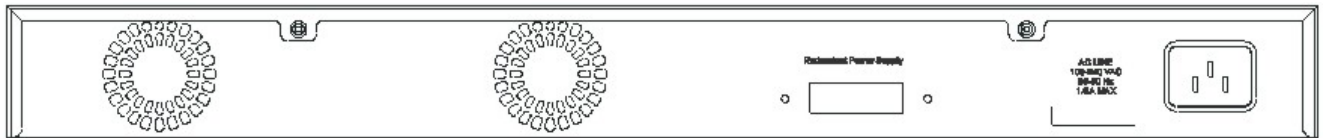

Figure 1- 7. Rear panel view of the DES-3550

The AC power connector is a standard three-pronged connector that supports the power cord. Plug-in the female connector of the provided power cord into this socket, and the male side of the cord into a power outlet. The Switch automatically adjusts its power setting to any supply voltage in the range from 100 ~ 240 VAC at 50 ~ 60 Hz.

The rear panel also includes an outlet for an optional external power supply. When power fails, the optional external RPS will take over all the power immediately and automatically.



Figure 1- 8. Rear panel view of DES-3526DC

The rear panel of the DC power version of the Switch includes an opening designed to accommodate the DC power wiring assembly. See the installation instructions in this Section for details.

Side Panel Description

The right-hand side panel of the Switch contains a system fan, while the left hand panel includes a system fan and a heat vent.

The system fans are used to dissipate heat. The sides of the system also provide heat vents to serve the same purpose. Do not block these openings, and leave at least 6 inches of space at the rear and sides of the Switch for proper ventilation. Be reminded that without proper heat dissipation and air circulation, system components might overheat, which could lead to system failure.

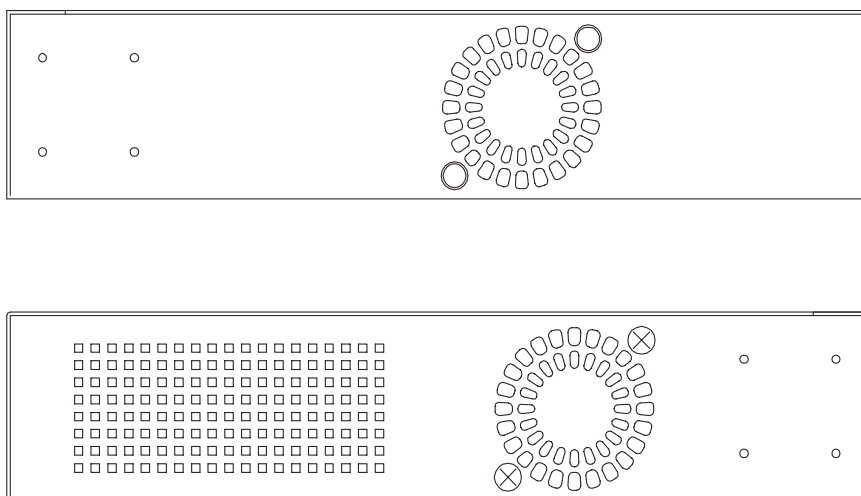

Figure 1- 9. Side panels of the DES-3526/DES-3526DC



Figure 1- 10. Side panels of the DES-3550

Gigabit Combo Ports

In addition to the 24 (or 48) 10/100 Mbps ports, the Switch features two Gigabit Ethernet Combo ports. These two ports are 1000BASE-T copper ports (provided) and Mini-GBIC ports (optional). See the diagram below to view the two Mini-GBIC port modules being plugged into the Switch. Please note that although these two front panel modules can be used simultaneously, the ports must be different. The GBIC port will always have the highest priority.

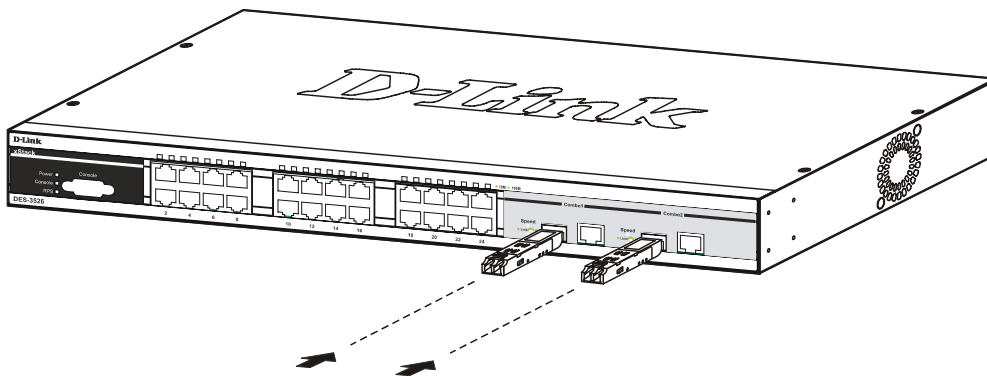

Figure 1- 11. Inserting the Mini-GBIC modules into the DES-3526

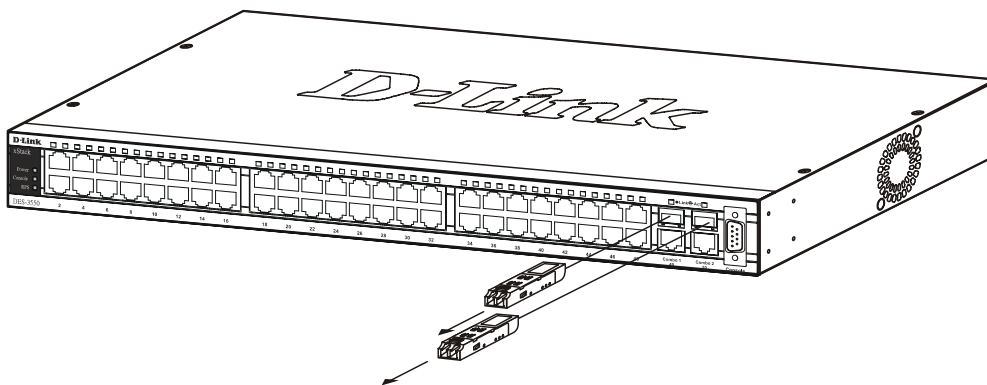

Figure 1- 12. Inserting the Mini-GBIC modules into the DES-3550

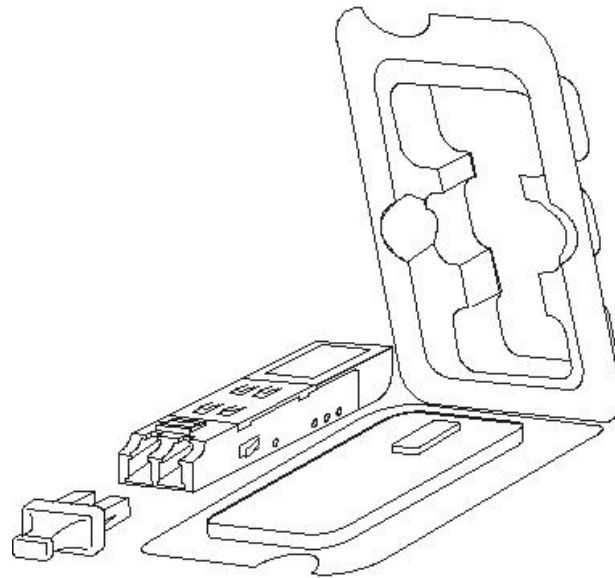

Figure 1- 13. Installing the Mini-GBIC Module

SECTION 2

Installation

Package Contents

Before You Connect to the Network

Installing the Switch without the Rack

Rack Installation

Power On

Package Contents

Open the shipping carton of the Switch and carefully unpack its contents. The carton should contain the following items:

- One xStack DES-3500 Series switch
- One AC power cord
- One CD Kit for User's Guide/CLI/D-View module
- Quick Installation Guide
- Registration card
- Mounting kit (two brackets and screws)
- Four rubber feet with adhesive backing
- RS-232 console cable

If any item is found missing or damaged, please contact your local D-Link Reseller for replacement.

Before You Connect to the Network

The site where you install the Switch may greatly affect its performance. Please follow these guidelines for setting up the Switch.

- Install the Switch on a sturdy, level surface that can support at least 6.6 lb. (3 kg) of weight. Do not place heavy objects on the Switch.
- The power outlet should be within 1.82 meters (6 feet) of the Switch.
- Visually inspect the power cord and see that it is fully secured to the AC power port.
- Make sure that there is proper heat dissipation from and adequate ventilation around the Switch. Leave at least 10 cm (4 inches) of space at the front and rear of the Switch for ventilation.
- Install the Switch in a fairly cool and dry place for the acceptable temperature and humidity operating ranges.
- Install the Switch in a site free from strong electromagnetic field generators (such as motors), vibration, dust, and direct exposure to sunlight.
- When installing the Switch on a level surface, attach the rubber feet to the bottom of the device. The rubber feet cushion the Switch, protect the casing from scratches and prevent it from scratching other surfaces.

Installing the Switch without the Rack

When installing the Switch on a desktop or shelf, the rubber feet included with the Switch should first be attached. Attach these cushioning feet on the bottom at each corner of the device. Allow enough ventilation space between the Switch and any other objects in the vicinity.

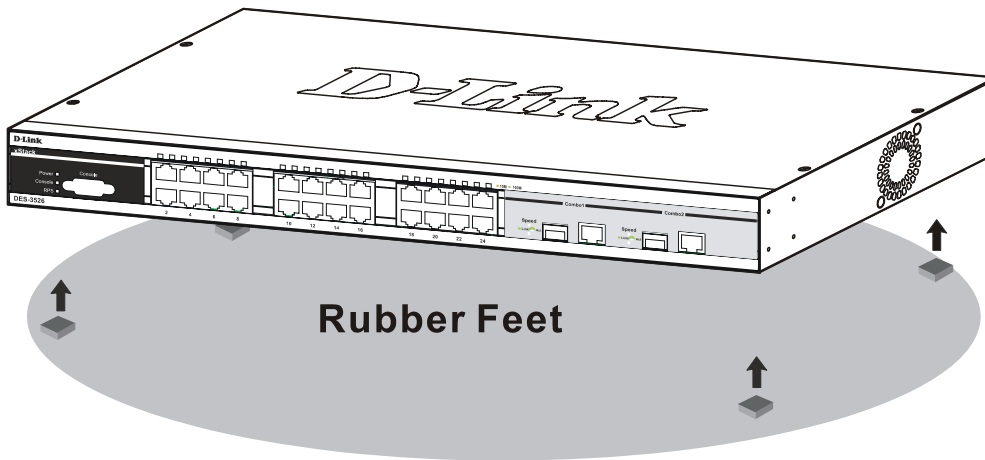

Figure 2- 1. Preparing the DES-3526 for installation on a desktop or shelf

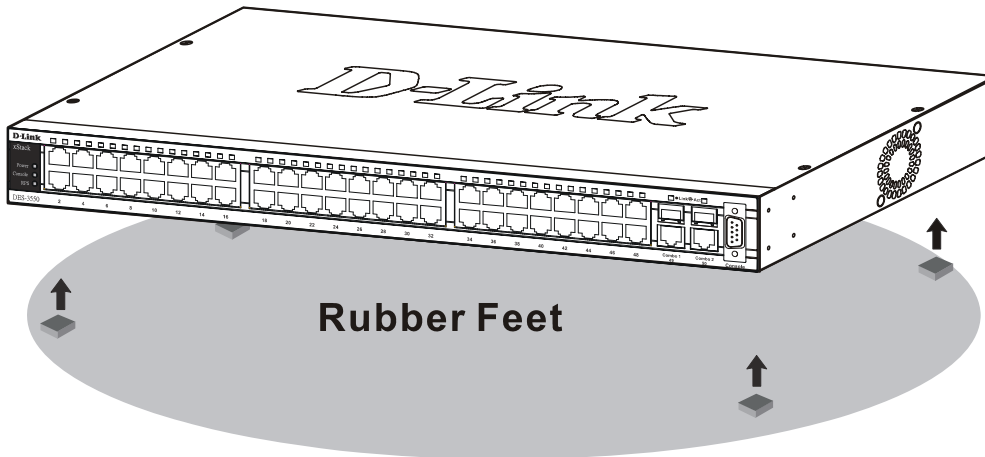

Figure 1- 14. Preparing the DES-3550 for installation on a desktop or shelf

Installing the Switch in a Rack

The Switch can be mounted in a standard 19" rack. Use the following diagrams to guide you.

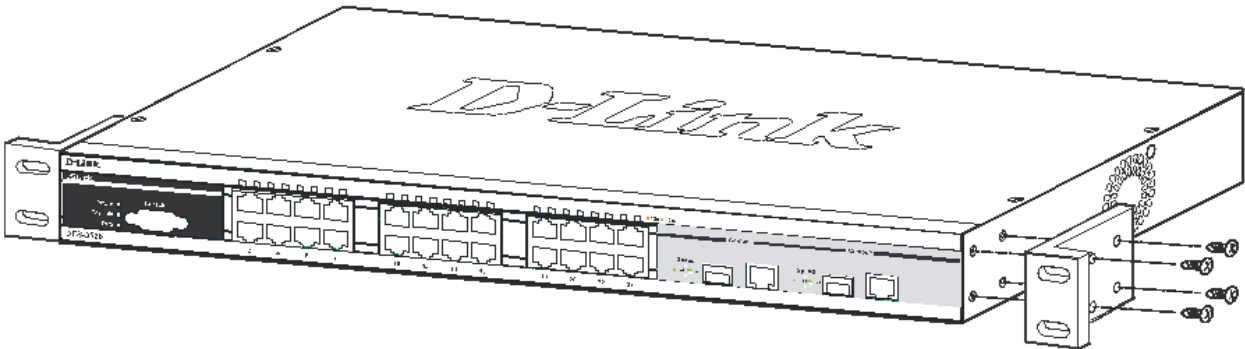

Figure 2- 2. Fasten mounting brackets to the DES-3526

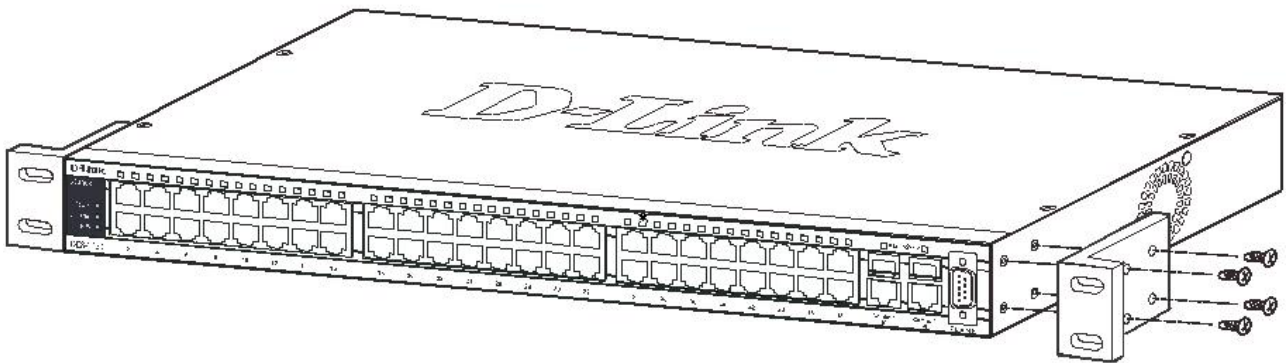

Figure 1- 15. Fasten mounting brackets to the DES-3550

Fasten the mounting brackets to the Switch using the screws provided. With the brackets attached securely, you can mount the Switch in a standard rack as shown in Figure 2-3 below.

Mounting the Switch in a Standard 19" Rack



CAUTION: Installing systems in a rack without the front and side stabilizers installed could cause the rack to tip over, potentially resulting in bodily injury under certain circumstances. Therefore, always install the stabilizers before installing components in the rack. After installing components in a rack, do not pull more than one component out of the rack on its slide assemblies at one time. The weight of more than one extended component could cause the rack to tip over and may result in injury.

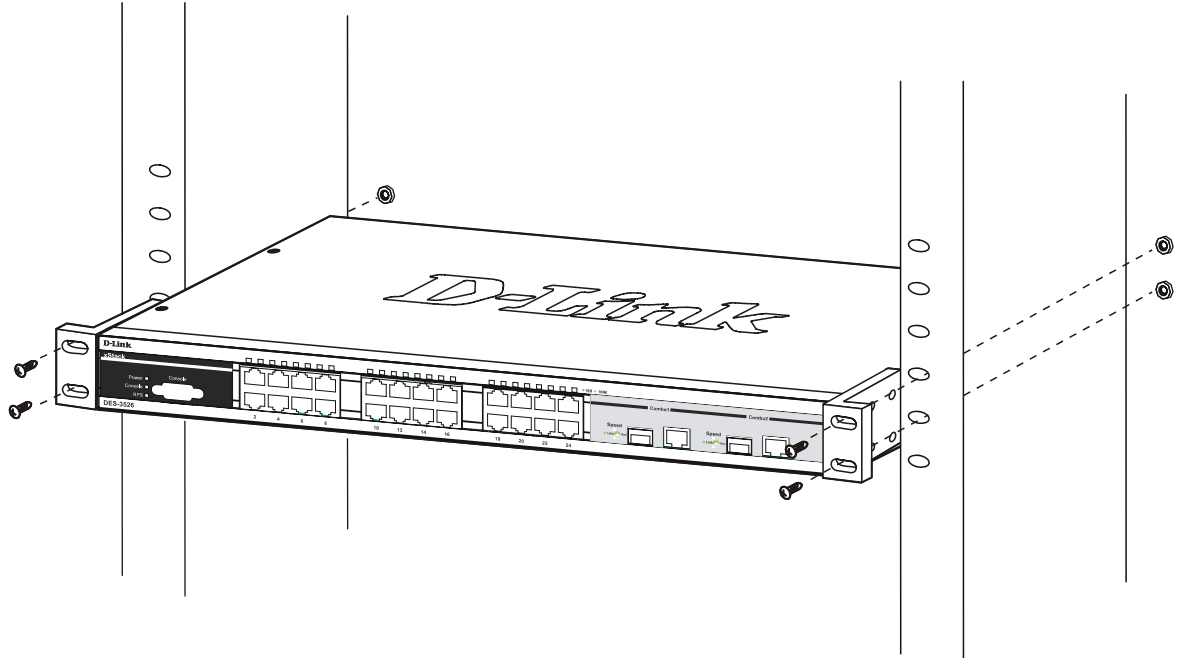

Figure 2- 3. Installing the DES-3526 in a rack

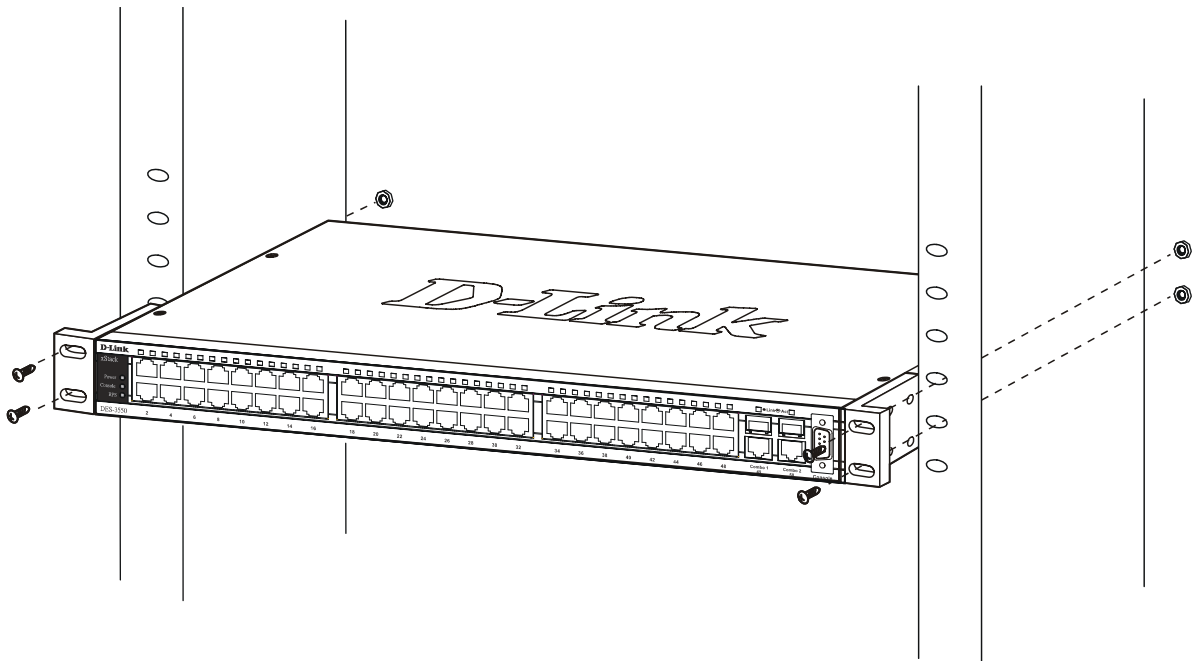

Figure 2- 4. Installing the DES-3550 in a rack

Power On (AC Power)

Plug one end of the AC power cord into the power connector of the Switch and the other end into the local power source outlet. After the Switch is powered on, the LED indicators will momentarily blink. This blinking of the LED indicators represents a reset of the system.

Power Failure

As a precaution for AC power supply units, in the event of a power failure, unplug the Switch. When power has resumed, plug the Switch back in.

Connecting DC Power to DES-3526DC

Follow the instructions below to connect the DC power supply of the DES-3526DC to a DC power source.



Figure 2- 5. Power connections attached to contacts on assembly

1. Firmly attach the DC power to the negative and positive contacts on the wiring assembly.
 - The negative pole (-) connects to the **-48V** contact.
 - The positive pole (+) connects to the **-48V Return** contact.
 - If available, the earth ground may be connected to center contact post.
2. Tighten the contact screws so the connection is secure.

Section 3

Connecting the Switch

Switch to End Node

Switch to Hub or Switch

Connecting To Network Backbone or Server



NOTE: All 24 (48 for the DES-3550) high-performance NWay Ethernet ports can support both MDI-II and MDI-X connections.

Switch to End Node

End nodes include PCs outfitted with a 10, 100 or 1000 Mbps RJ-45 Ethernet/Fast Ethernet Network Interface Card (NIC) and most routers.

An end node can be connected to the Switch via a twisted-pair Category 3, 4, or 5 UTP/STP cable. The end node should be connected to any of the ports of the Switch.

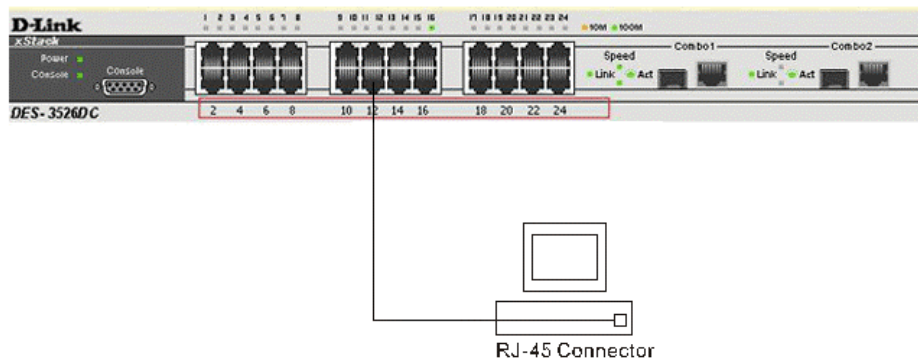

Figure 3- 1. DES-3526 connected to an end node

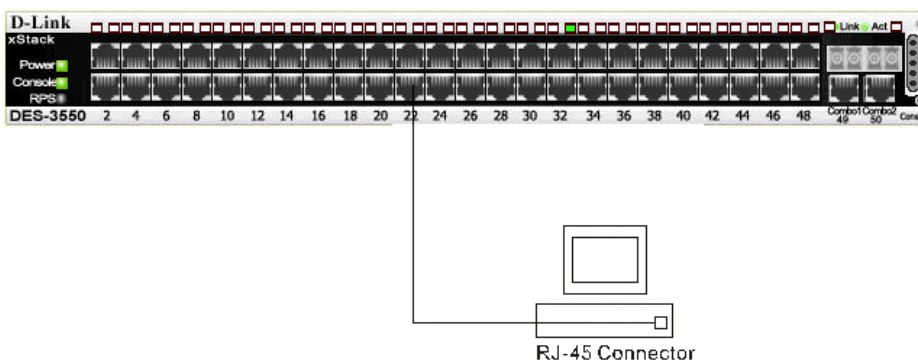

Figure 3- 2 DES-3550 connected to an end node

The Link/Act LEDs for each UTP port will light green or amber when the link is valid. A blinking LED indicates packet activity on that port.

Switch to Hub or Switch

These connections can be accomplished in a number of ways using a normal cable.

- A 10BASE-T hub or switch can be connected to the Switch via a twisted-pair Category 3, 4 or 5 UTP/STP cable.
- A 100BASE-TX hub or switch can be connected to the Switch via a twisted -pair Category 5 UTP/STP cable.

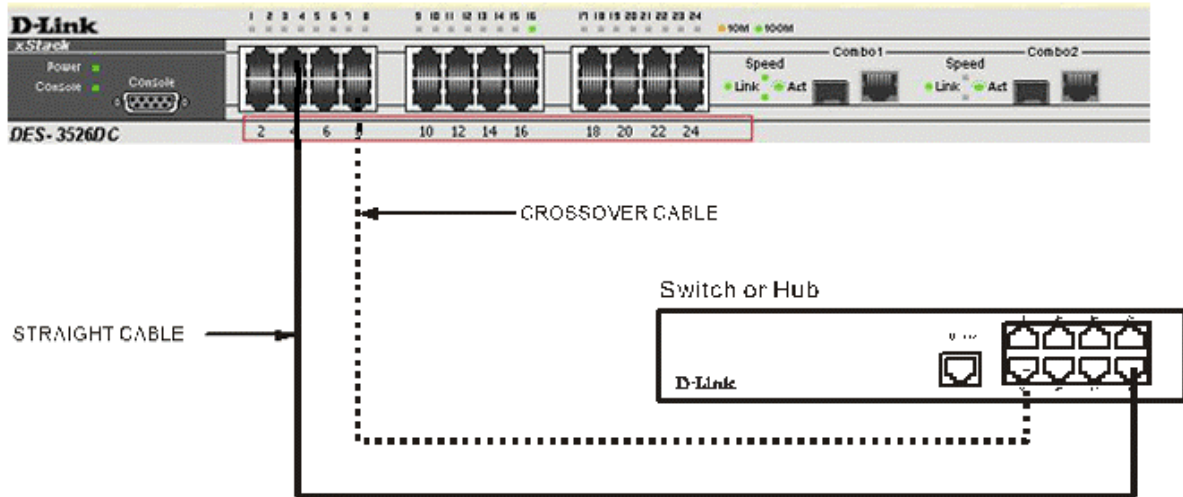

Figure 3- 3. DES-3526 connected to a normal (non-Uplink) port on a hub or switch using a straight or crossover cable

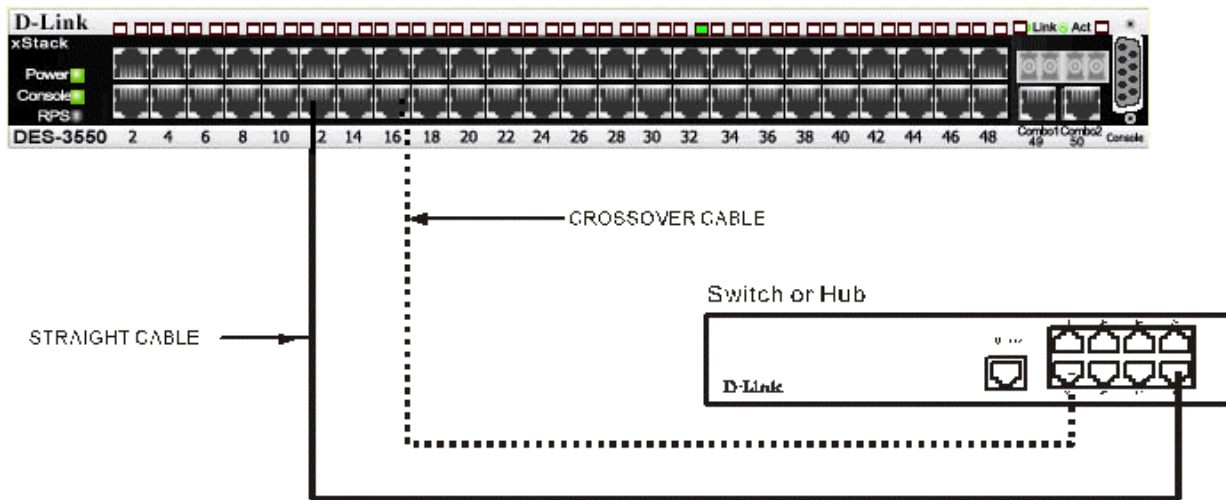

Figure 3- 4 DES-3550 connected to a normal (non-Uplink) port on a hub or switch using a straight or crossover cable

Connecting To Network Backbone or Server

The two Mini-GBIC combo ports are ideal for uninking to a network backbone or server. The copper ports operate at a speed of 1000, 100 or 10Mbps in full or half duplex mode. The fiber optic ports can operate at 1000Mbps in full duplex mode.

Connections to the Gigabit Ethernet ports are made using fiber optic cable or Category 5 copper cable, depending on the type of port. A valid connection is indicated when the Link LED is lit.

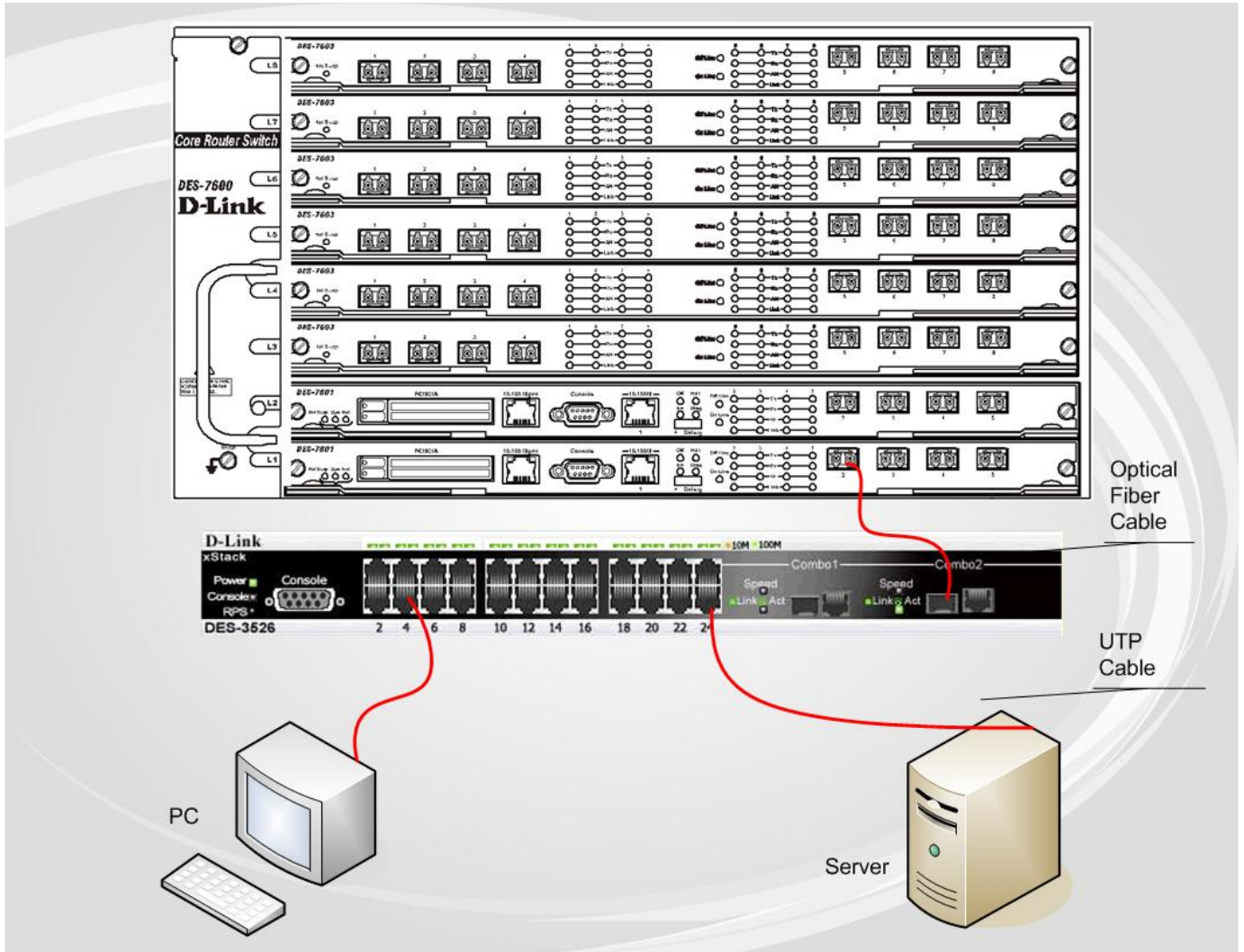

Figure 3- 5. Connecting the DES-3500 Series switch to a Server

Section 4

Introduction to Switch Management

Management Options

Web-based Management Interface

SNMP-Based Management

Managing User Accounts

Command Line Console Interface through the Serial Port

Connecting the Console Port (RS-232 DCE)

First Time Connecting to the Switch

Password Protection

SNMP Settings

IP Address Assignment

Connecting Devices to the Switch

Management Options

This system may be managed out-of-band through the console port on the front panel or in-band using Telnet. The user may also choose the web-based management, accessible through a web browser.

Web-based Management Interface

After you have successfully installed the Switch, you can configure the Switch, monitor the LED panel, and display statistics graphically using a web browser, such as Netscape Navigator (version 6.2 and higher) or Microsoft® Internet Explorer (version 5.0).

SNMP-Based Management

You can manage the Switch with an SNMP-compatible console program. The Switch supports SNMP version 1.0, version 2.0 and version 3.0. The SNMP agent decodes the incoming SNMP messages and responds to requests with MIB objects stored in the database. The SNMP agent updates the MIB objects to generate statistics and counters.

Connecting the Console Port (RS-232 DCE)

The Switch provides an RS-232 serial port that enables a connection to a computer or terminal for monitoring and configuring the Switch. This port is a female DB-9 connector, implemented as a data terminal equipment (DTE) connection.

To use the console port, you need the following equipment:

- A terminal or a computer with both a serial port and the ability to emulate a terminal.
- A null modem or crossover RS-232 cable with a female DB-9 connector for the console port on the Switch.

To connect a terminal to the console port:

1. Connect the female connector of the RS-232 cable directly to the console port on the Switch, and tighten the captive retaining screws.
2. Connect the other end of the cable to a terminal or to the serial connector of a computer running terminal emulation software. Set the terminal emulation software as follows:
3. Select the appropriate serial port (**COM port 1** or **COM port 2**).
4. Set the data rate to **9600** baud.
5. Set the data format to **8** data bits, **1** stop bit, and **no parity**.
6. Set flow control to none.
7. Under Properties, select **VT100** for Emulation mode.
8. Select Terminal keys for Function, Arrow, and Ctrl keys. Ensure that you select Terminal keys (not Windows keys).



NOTE: When you use HyperTerminal with the Microsoft® Windows® 2000 operating system, ensure that you have Windows 2000 Service Pack 2 or later installed. Windows 2000 Service Pack 2 allows you to use arrow keys in HyperTerminal's VT100 emulation. See www.microsoft.com for information on Windows 2000 service packs.

9. After you have correctly set up the terminal, plug the power cable into the power receptacle on the back of the Switch. The boot sequence appears in the terminal.
10. After the boot sequence completes, the console login screen displays.
11. If you have not logged into the command line interface (CLI) program, press the Enter key at the User name and password prompts. There is no default user name and password for the Switch. The administrator must first create user names and passwords. If you have previously set up user accounts, log in and continue to configure the Switch.
12. Enter the commands to complete your desired tasks. Many commands require administrator-level access privileges. Read the next section for more information on setting up user accounts. See the *DES-3500 Series switches Command Line Interface Reference Manual* on the documentation CD for a list of all commands and additional information on using the CLI.
13. When you have completed your tasks, exit the session with the logout command or close the emulator program.

Make sure the terminal or PC you are using to make this connection is configured to match these settings.

If you are having problems making this connection on a PC, make sure the emulation is set to VT-100. You will be able to set the emulation by clicking on the **File** menu in your HyperTerminal window, clicking on **Properties** in the drop-down menu, and then clicking the **Settings** tab. This is where you will find the **Emulation** options. If you still do not see anything, try rebooting the Switch by disconnecting its power supply.

Once connected to the console, the screen below will appear on your console screen. This is where the user will enter commands to perform all the available management functions. The Switch will prompt the user to enter a user name and a password. Upon the initial connection, there is no user name or password and therefore just press enter twice to access the command line interface.

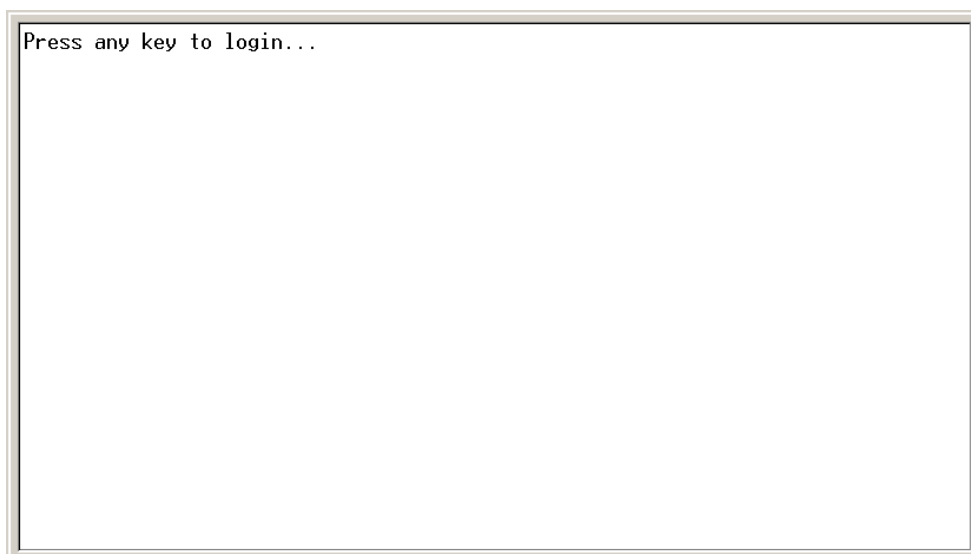

Figure 4- 1. Initial screen after first connection

First Time Connecting to the Switch

The Switch supports user-based security that can allow you to prevent unauthorized users from accessing the Switch or changing its settings. This section tells how to log onto the Switch.



NOTE: The passwords used to access the Switch are case-sensitive; therefore, "S" is not the same as "s."

When you first connect to the Switch, you will be presented with the first login screen.



NOTE: Press Ctrl+R to refresh the screen. This command can be used at any time to force the console program in the Switch to refresh the console screen.

Press Enter in both the Username and Password fields. You will be given access to the command prompt **DES-3500 Series switches:4#** shown below:

There is no initial username or password. Leave the Username and Password fields blank.

```

DES-3526 Fast Ethernet Switch Command Line Interface
                          Firmware: Build 5.00-B25
                          Copyright(C) 2000-2004 D-Link Corporation. All rights reserved.
username:
password:
DES-3526:admin#

```

Figure 4- 2. Command Prompt



NOTE: The first user automatically gets Administrator level privileges. It is recommended to create at least one Admin-level user account for the Switch.

Password Protection

The DES-3500 Series switches do not have a default user name and password. One of the first tasks when settings up the Switch is to create user accounts. If you log in using a predefined administrator-level user name, you have privileged access to the Switch's management software.

After your initial login, define new passwords for both default user names to prevent unauthorized access to the Switch, and record the passwords for future reference.

To create an administrator-level account for the Switch, do the following:

- At the CLI login prompt, enter create account admin followed by the *<user name>* and press the Enter key.
- You will be asked to provide a password. Type the *<password>* used for the administrator account being created and press the Enter key.
- You will be prompted to enter the same password again to verify it. Type the same password and press the Enter key.
- Successful creation of the new administrator account will be verified by a Success message.



NOTE: Passwords are case sensitive. User names and passwords can be up to 15 characters in length.

The sample below illustrates a successful creation of a new administrator-level account with the user name "newmanager".

```
DES-3526:admin#create account operator 2
Command: create account operator 2

Enter a case-sensitive new password:*****
Enter the new password again for confirmation:*****
Success.
DES-3526:admin#
```



NOTICE: CLI configuration commands only modify the running configuration file and are not saved when the Switch is rebooted. To save all your configuration changes in nonvolatile storage, you must use the save command to copy the running configuration file to the startup configuration.



NOTICE: In case of lost passwords or password corruption, please refer to the D-Link website and the White Paper entitled "Password Recovery Procedure", which will guide you through the steps necessary to resolve this issue.

SNMP Settings

Simple Network Management Protocol (SNMP) is an OSI Layer 7 (Application Layer) designed specifically for managing and monitoring network devices. SNMP enables network management stations to read and modify the settings of gateways, routers, switches, and other network devices. Use SNMP to configure system features for proper operation, monitor performance and detect potential problems in the Switch, switch group or network.

Managed devices that support SNMP include software (referred to as an agent), which runs locally on the device. A defined set of variables (managed objects) is maintained by the SNMP agent and used to manage the device. These objects are defined in a Management Information Base (MIB), which provides a standard presentation of the information controlled by the on-board SNMP agent. SNMP defines both the format of the MIB specifications and the protocol used to access this information over the network.

The DES-3500 Series switches supports SNMP versions 1, 2c, and 3. You can specify which version of SNMP you want to use to monitor and control the Switch. The three versions of SNMP vary in the level of security provided between the management station and the network device.

In SNMP v.1 and v.2, user authentication is accomplished using 'community strings', which function like passwords. The remote user SNMP application and the Switch SNMP must use the same community string. SNMP packets from any station that has not been authenticated are ignored (dropped).

The default community strings for the Switch used for SNMP v.1 and v.2 management access are:

- public - Allows authorized management stations to retrieve MIB objects.
- private - Allows authorized management stations to retrieve and modify MIB objects.

SNMP v.3 uses a more sophisticated authentication process that is separated into two parts. The first part is to maintain a list of users and their attributes that are allowed to act as SNMP managers. The second part describes what each user on that list can do as an SNMP manager.

The Switch allows groups of users to be listed and configured with a shared set of privileges. The SNMP version may also be set for a listed group of SNMP managers. Thus, you may create a group of SNMP managers that are allowed to view read-only information or receive traps using SNMP v.1 while assigning a higher level of security to another group, granting read/write privileges using SNMP v.3.

Using SNMP v.3 individual users or groups of SNMP managers can be allowed to perform or be restricted from performing specific SNMP management functions. The functions allowed or restricted are defined using the Object Identifier (OID) associated with a specific MIB. An additional layer of security is available for SNMP v.3 in that SNMP messages may be encrypted. To read more about how to configure SNMP v.3 settings for the Switch read the section entitled Management.

Traps

Traps are messages that alert network personnel of events that occur on the Switch. The events can be as serious as a reboot (someone accidentally turned OFF the Switch), or less serious like a port status change. The Switch generates traps and sends them to the trap recipient (or network manager). Typical traps include trap messages for Authentication Failure, Topology Change and Broadcast/Multicast Storm.

MIBs

The Switch in the Management Information Base (MIB) stores management and counter information. The Switch uses the standard MIB-II Management Information Base module. Consequently, values for MIB objects can be retrieved from any SNMP-based network management software. In addition to the standard MIB-II, the Switch also supports its own proprietary enterprise MIB as an extended Management Information Base. Specifying the MIB Object Identifier may also retrieve the proprietary MIB. MIB values can be either read-only or read-write.

IP Address Assignment

Each Switch must be assigned its own IP Address, which is used for communication with an SNMP network manager or other TCP/IP application (for example BOOTP, TFTP). The Switch's default IP address is 10.90.90.90. You can change the default Switch IP address to meet the specification of your networking address scheme.

The Switch is also assigned a unique MAC address by the factory. This MAC address cannot be changed, and can be found by entering the command "show switch" into the command line interface, as shown below.

```

Device Type       : DES-3526 Fast-Ethernet Switch
Combo Port Type  : 1000Base-T + 1000Base-T
MAC Address       : 00-80-C8-95-26-A0
IP Address        : 10.53.13.199 (Manual)
VLAN Name         : default
Subnet Mask       : 255.0.0.0
Default Gateway   : 0.0.0.0
Boot PROM Version : Build 3.00.005
Firmware Version  : Build 4.01-B19
Hardware Version  : 0A1
Device S/N        :
Power Status      : Main - Normal, Redundant - Not Present
System Name       :
System Location   :
System Contact    :
Spanning Tree     : Disabled
GVRP              : Disabled
IGMP Snooping    : Disabled
TELNET            : Enabled (TCP 23)
SSH               : Disabled
WEB               : Enabled (TCP 80)
RMON              : Disabled
CTRL+C ESC Q Quit SPACE N Next Page ENTER Next Entry A All
  
```

Figure 4- 3. Show switch command

The Switch's MAC address can also be found from the Web management program on the **Switch Information (Basic Settings)** window on the **Configuration** menu.

The IP address for the Switch must be set before it can be managed with the Web-based manager. The Switch IP address can be automatically set using BOOTP or DHCP protocols, in which case the actual address assigned to the Switch must be known.

The IP address may be set using the Command Line Interface (CLI) over the console serial port as follows:

Starting at the command line prompt, enter the commands

```
config ipif System ipaddress xxx.xxx.xxx.xxx/yyy.yyy.yyy.yyy
```

Where the x's represent the IP address to be assigned to the IP interface named System and the y's represent the corresponding subnet mask.

Alternatively, you can enter **config ipif System ipaddress xxx.xxx.xxx.xxx/z**. Where the x's represent the IP address to be assigned to the IP interface named System and the z represents the corresponding number of subnets in CIDR notation.

The IP interface named System on the Switch can be assigned an IP address and subnet mask, and then be used to connect a management station to the Switch's Telnet or Web-based management agent.



NOTICE: In case of lost passwords or password corruption, please refer to the D-Link website and the White Paper entitled "Password Recovery Procedure", which will guide you through the steps necessary to resolve this issue.

```
DES-3526:4#config ipif System ipaddress 10.41.44.254/8
Command: config ipif System ipaddress 10.41.44.254/8

Success.

DES-3526:4#
```

Figure 4- 4. Assigning the Switch an IP Address

In the above example, the Switch was assigned an IP address of 10.41.44.254 with a subnet mask of 255.0.0.0. The system message **Success** indicates that the command was executed successfully. The Switch can now be configured and managed via Telnet and the CLI or via the Web-based management.

Connecting Devices to the Switch

After you assign IP addresses to the Switch, you can connect devices to the Switch.

To connect a device to an SFP transceiver port:

- Use your cabling requirements to select an appropriate SFP transceiver type.
- Insert the SFP transceiver (sold separately) into the SFP transceiver slot.
- Use the appropriate network cabling to connect a device to the connectors on the SFP transceiver.



NOTICE: When the SFP transceiver acquires a link, the associated integrated 10/100/1000BASE-T port is disabled.

Section 5

Web-based Switch Configuration

Introduction

Login to Web manager

Web-Based User Interface

Basic Setup

Reboot

Basic Switch Setup

Network Management

Switch Utilities

Network Monitoring

IGMP Snooping Status

Introduction

All software functions of the DES-3500 Series switches can be managed, configured and monitored via the embedded web-based (HTML) interface. The Switch can be managed from remote stations anywhere on the network through a standard browser such as Opera, Netscape Navigator/Communicator, or Microsoft Internet Explorer. The browser acts as a universal access tool and can communicate directly with the Switch using the HTTP protocol.

The Web-based management module and the Console program (and Telnet) are different ways to access the same internal switching software and configure it. Thus, all settings encountered in web-based management are the same as those found in the console program.

Login to Web Manager

To begin managing your Switch, simply run the browser you have installed on your computer and point it to the IP address you have defined for the device. The URL in the address bar should read something like: `http://123.123.123.123`, where the numbers 123 represent the IP address of the Switch.



NOTE: The Factory default IP address for the Switch is 10.90.90.90.

This opens the management module's user authentication window, as seen below.

Figure 5- 1. Enter Network Password window

Leave both the User Name field and the Password field blank and click **OK**. This will open the Web-based user interface. The Switch management features available in the web-based manager are explained below.

Web-based User Interface

The user interface provides access to various Switch configuration and management screens, allows you to view performance statistics, and permits you to graphically monitor the system status.

Areas of the User Interface

The figure below shows the user interface. The user interface is divided into three distinct areas as described in the table.

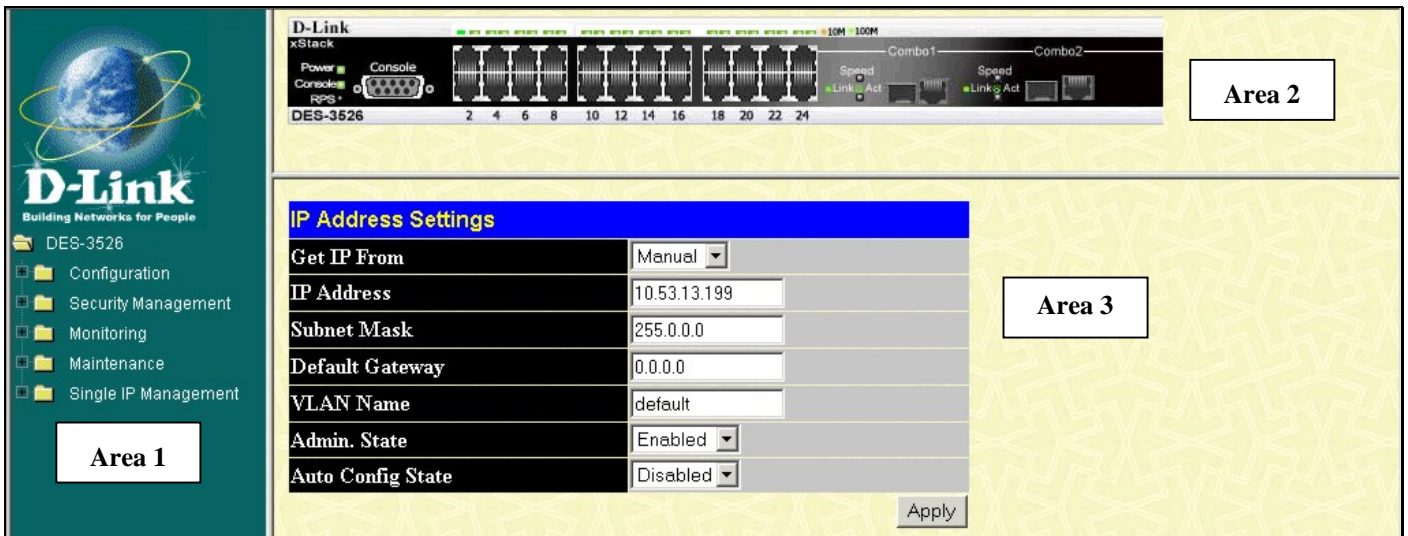

Figure 5- 2. Main Web-Manager page

Area	Function
Area 1	Select the menu or window to be displayed. The folder icons can be opened to display the hyper-linked menu buttons and subfolders contained within them. Click the D-Link logo to go to the D-Link website.
Area 2	Presents a graphical near real-time image of the front panel of the Switch. This area displays the Switch's ports and expansion modules, showing port activity, duplex mode, or flow control, depending on the specified mode. Various areas of the graphic can be selected for performing management functions, including port configuration.
Area 3	Presents switch information based on your selection and the entry of configuration data.



NOTICE: Any changes made to the Switch configuration during the current session must be saved in the Save Changes web menu (explained below) or use the command line interface (CLI) command save.

Web Pages

When you connect to the management mode of the Switch with a web browser, a login window is displayed. Enter a user name and password to access the Switch's management mode.

Below is a list and description of the main folders available in the web interface:

Configuration – Contains windows concerning configurations for Switch Information, IP Address, Advanced Settings, Port Configuration, Port Description, Port Mirroring, Link Aggregation, LACP Port Setting, MAC Notification, IGMP, Spanning Tree, Forwarding Filtering, VLANs, Traffic Control, Port Security, QoS, System Severity Settings, System Log Server, Sntp Settings, Access Profile Table, CPU Interface Filtering, Port Access Entity, IP-MAC Binding, Limited IP Multicast Range and Layer 3 IP Networking.

Security Management – Contains windows concerning configurations for Security IP, User Accounts, Access Authentication Control (TACACS), Secure Sockets Layer (SSL), Secure Shell (SSH), SNMP Manager and Safeguard Engine Settings.

Monitoring – Contains windows concerning monitoring the Switch, pertaining to Port Utilization, CPU Utilization, Packets, Errors, Size, MAC Address, Switch History Log, IGMP Snooping Group, IGMP Snooping Forwarding, VLAN Status, Router Port, Port Access Control, Layer 3 Feature and Safeguard Engine Status.

Maintenance – Contains windows concerning configurations and information about Switch maintenance, including TFTP Services, Multiple Image Services, Ping Test, Save Changes, Reset, Reset System, Reset Config, Reboot Device and Logout.

Single IP Management – Contains windows concerning information on Single IP Management, including SIM Settings, Topology, and Firmware/Configuration downloads.



NOTE: Be sure to configure the user name and password in the User Accounts menu before connecting the Switch to the greater network.



NOTICE: In case of lost passwords or password corruption, please refer to the D-Link website and the White Paper entitled “Password Recovery Procedure”, which will guide you through the steps necessary to resolve this issue.

Section 6

Configuring the Switch

Switch Information

IP Address

Advanced Settings

Port Configuration

Port Description

Port Mirroring

Link Aggregation

LACP Port Setting

MAC Notification

IGMP

Spanning Tree

Forward Filtering

VLANs

Traffic Control

Port Security

QoS

System Log Servers

SNTP Settings

Access Profile Table

CPU Interface Filtering

Port Access Entity

IP-MAC Binding

Limited IP Multicast Range Settings

Layer 3 IP Networking

Switch Information

The subsections below describe how to change some of the basic settings for the Switch such as changing IP settings and assigning user names and passwords for management access privileges, as well as how to save the changes and restart the Switch.

Click the **Switch Information** link in the **Configuration** menu.

Switch Information (Basic Settings)	
Device Type	DES-3526
External Ports	1000TX + 1000TX
MAC Address	00:80:c8:35:26:a0
Boot PROM Version	3.00.005
Firmware Version	4.01-B19
Hardware Version	0A1
Power Status	Main - Normal, Redundant - Not Present
System Name	<input type="text"/>
System Location	<input type="text"/>
System Contact	<input type="text"/>
Apply	

Figure 6- 1. Switch Information (Basic Settings) window

The **Switch Information (Basic Settings)** window shows the Switch's MAC Address (assigned by the factory and unchangeable), the Boot PROM, Firmware Version, and Hardware Version. This information is helpful to keep track of PROM and firmware updates and to obtain the Switch's MAC address for entry into another network device's address table, if necessary. The user may also enter a System Name, System Location and System Contact to aid in defining the Switch, to the user's preference.

IP Address

The IP Address may initially be set using the console interface prior to connecting to it through the Ethernet. If the Switch IP address has not yet been changed, read the introduction of the *xStack DES-3500 Series Command Line Interface Manual* or return to Section 4 of this manual for more information.

To change IP settings using the web manager you must access the IP Address menu located in the Configuration folder.

To configure the Switch's IP address:

Open the **Configuration** folder and click the **IP Address** menu link. The web manager will display the Switch's current IP settings in the IP configuration menu, as seen below.

IP Address Settings	
Get IP From	Manual <input type="text"/>
IP Address	<input type="text" value="10.53.13.91"/>
Subnet Mask	<input type="text" value="255.0.0.0"/>
Default Gateway	<input type="text" value="10.41.44.1"/>
VLAN Name	<input type="text" value="default"/>
Admin. State	Enabled <input type="text"/>
Auto Config State	Disabled <input type="text"/>
Apply	

Figure 6- 2. IP Address Settings window

To manually assign the Switch's IP address, subnet mask, and default gateway address:

1. Select *Manual* from the Get IP From drop-down menu.
2. Enter the appropriate IP Address and Subnet Mask.

3. If you want to access the Switch from a different subnet from the one it is installed on, enter the IP address of the Default Gateway. If you will manage the Switch from the subnet on which it is installed, you can leave the default address (0.0.0.0) in this field.
4. If no VLANs have been previously configured on the Switch, you can use the *default* VLAN Name. The *default* VLAN contains all of the Switch ports as members. If VLANs have been previously configured on the Switch, you will need to enter the *VLAN ID* of the VLAN that contains the port connected to the management station that will access the Switch. The Switch will allow management access from stations with the same VID listed here.



NOTE: The Switch's factory default IP address is 10.90.90.90 with a subnet mask of 255.0.0.0 and a default gateway of 0.0.0.0.

To use the BOOTP or DHCP protocols to assign the Switch an IP address, subnet mask, and default gateway address. Use the Get IP From pull-down menu to choose from *BOOTP* or *DHCP*. This selects how the Switch will be assigned an IP address on the next reboot.



NOTE: If you enable the **AutoConfig**, the **Get IP From** setting will automatically become DHCP.

The IP Address Settings options are:

Parameter	Description
BOOTP	The Switch will send out a BOOTP broadcast request when it is powered up. The BOOTP protocol allows IP addresses, network masks, and default gateways to be assigned by a central BOOTP server. If this option is set, the Switch will first look for a BOOTP server to provide it with this information before using the default or previously entered settings.
DHCP	The Switch will send out a DHCP broadcast request when it is powered up. The DHCP protocol allows IP addresses, network masks, and default gateways to be assigned by a DHCP server. If this option is set, the Switch will first look for a DHCP server to provide it with this information before using the default or previously entered settings.
Manual	Allows the entry of an IP address, Subnet Mask, and a Default Gateway for the Switch. These fields should be of the form xxx.xxx.xxx.xxx, where each xxx is a number (represented in decimal form) between 0 and 255. This address should be a unique address on the network assigned for use by the network administrator.
Subnet Mask	A Bitmask that determines the extent of the subnet that the Switch is on. Should be of the form xxx.xxx.xxx.xxx, where each xxx is a number (represented in decimal) between 0 and 255. The value should be 255.0.0.0 for a Class A network, 255.255.0.0 for a Class B network, and 255.255.255.0 for a Class C network, but custom subnet masks are allowed.
Default Gateway	IP address that determines where packets with a destination address outside the current subnet should be sent. This is usually the address of a router or a host acting as an IP gateway. If your network is not part of an intranet, or you do not want the Switch to be accessible outside your local network, you can leave this field unchanged.
VLAN Name	This allows the entry of a VLAN Name from which a management station will be allowed to manage the Switch using TCP/IP (in-band via web manager or Telnet). Management stations that are on VLANs other than the one entered here will not be able to manage the Switch in-band unless their IP addresses are entered in the Security IP Management menu. If VLANs have not yet been configured for the Switch, the default VLAN contains all of the Switch's ports. There are no entries in the Security IP Management table, by default, so any management station that can connect to the Switch can access the Switch until a management VLAN is specified or Management Station IP Addresses are assigned.
Admin State	This allows the user to enable or disable the Admin State for the IP interface, by the using the pull-down menu. Disabling this feature will render all remote management inoperable, and thus the only way to configure the Switch will be to use the Console port for the Command Line Interface.
Auto Config State	When autoconfig is enabled, the Switch is instructed to get a configuration file via TFTP, and it becomes a DHCP client automatically. The configuration file will be loaded upon booting up. In order to use Auto Config, the DHCP server must be set up to deliver the TFTP server IP address

and configuration file name information in the DHCP reply packet. The TFTP server must be running and have the requested configuration file stored in its base directory when the request is received from the Switch. Consult the DHCP server and/or TFTP server software instructions for information on loading a configuration file for use by a client. (Also see the section titled Upload Configuration for instructions on uploading a configuration to a TFTP server.

If the Switch is unable to complete the autoconfiguration process the previously saved configuration file present in Switch memory will be loaded.

Click **Apply** to let your changes take effect.

Setting the Switch's IP Address using the Console Interface

Each Switch must be assigned its own IP Address, which is used for communication with an SNMP network manager or other TCP/IP application (for example BOOTP, TFTP). The Switch's default IP address is 10.90.90.90. You can change the default Switch IP address to meet the specification of your networking address scheme.

The IP address for the Switch must be set before it can be managed with the Web-based manager. The Switch IP address can be automatically set using BOOTP or DHCP protocols, in which case the actual address assigned to the Switch must be known. The IP address may be set using the Command Line Interface (CLI) over the console serial port as follows:

Starting at the command line prompt, enter the commands **config ipif System ipaddress xxx.xxx.xxx.xxx/ yyy.yyy.yyy.yyy**. Where the x's represent the IP address to be assigned to the IP interface named System and the y's represent the corresponding subnet mask.

Alternatively, you can enter **config ipif System ipaddress xxx.xxx.xxx.xxx/z**. Where the x's represent the IP address to be assigned to the IP interface named **System** and the z represents the corresponding number of subnets in CIDR notation.

The IP interface named System on the Switch can be assigned an IP address and subnet mask which can then be used to connect a management station to the Switch's Telnet or Web-based management agent.

The system message **Success** indicates that the command was executed successfully. The Switch can now be configured and managed via Telnet and the CLI or via the Web-based management agent using the above IP address to connect to the Switch.



NOTICE: In case of lost passwords or password corruption, please refer to the D-Link website and the White Paper entitled "Password Recovery Procedure", which will guide you through the steps necessary to resolve this issue.

Advanced Settings

The **Switch Information (Advanced Settings)** window contains the main settings for all major functions for the Switch. To view the **Advanced Settings** window, click its link in the **Configuration** folder. This will enable the following window to be viewed and configured.

Switch Information (Advanced Settings)	
Serial Port Auto Logout Time	Never
MAC Address Aging Time	300
IGMP Snooping	Disabled
GVRP Status	Disabled
Telnet Status	Enabled
TCP Port Number (1-65535)	23
Web Status	Enabled
Web TCP Port Number	80
Link Aggregation Algorithm	MAC Source
RMON Status	Disabled
802.1x Status	Port Base
802.1x Authentication Protocol	RADIUS EAP
Asymmetric VLAN	Disabled
Syslog Global State	Disabled
Apply	

Figure 6- 3. Switch Information (Advanced Settings) window

Parameter	Description
Serial Port Auto Logout Time	Select the logout time used for the console interface. This automatically logs the user out after an idle period of time, as defined. Choose from the following options: <i>2 Minutes</i> , <i>5 Minutes</i> , <i>10 Minutes</i> , <i>15 Minutes</i> or <i>Never</i> . The default setting is <i>10 minutes</i> .
MAC Address Aging Time	This field specifies the length of time a learned MAC Address will remain in the forwarding table without being accessed (that is, how long a learned MAC Address is allowed to remain idle). To change this, type in a different value representing the MAC address age-out time in seconds. The MAC Address Aging Time can be set to any value between <i>10</i> and <i>1,000,000</i> seconds. The default setting is <i>300</i> seconds.
IGMP Snooping	To enable system-wide IGMP Snooping capability select <i>Enabled</i> . IGMP snooping is <i>Disabled</i> by default. Enabling IGMP snooping allows you to specify use of a multicast router only (see below). To configure IGMP Snooping for individual VLANs, use the IGMP Snooping window under the IGMP folder.
GVRP Status	Use this pull-down menu to enable or disable GVRP on the Switch.
Telnet Status	Telnet configuration is <i>Enabled</i> by default. If you do not want to allow configuration of the system through Telnet choose <i>Disabled</i> .
TCP Port Number (1-65535)	The TCP port number. TCP ports are numbered between <i>1</i> and <i>65535</i> . The "well-known" TCP port for the Telnet protocol is <i>23</i> .
Web Status	Web-based management is <i>Enabled</i> by default. If you choose to disable this by selecting <i>Disabled</i> , you will lose the ability to configure the system through the web interface as soon as these settings are applied.
Web TCP Port Number	The TCP port number currently being utilized by the Switch to connect to the web interface. The "well-known" TCP port for the Web interface is <i>80</i> .

Link Aggregation Algorithm	The algorithm that the Switch uses to balance the load across the ports that make up the port trunk group is defined by this definition. Choose <i>MAC Source</i> , <i>MAC Destination</i> , <i>MAC Src & Dest</i> , <i>IP Source</i> , <i>IP Destination</i> or <i>IP Src & Dest</i> (See the Link Aggregation section of this manual).
RMON Status	Remote monitoring (RMON) of the Switch is <i>Enabled</i> or <i>Disabled</i> here.
802.1x Status	MAC Address may enable by port or the Switch's 802.1x function; the default is <i>Disabled</i> . This field must be enabled to view and configure certain windows for 802.1x. More information regarding 802.1x, its functions and implementation can be found later in this section, under the Port Access Entity folder. Port-Based 802.1x specifies that ports configured for 802.1x are initialized based on the port number only and are subject to any authorization parameters configured. MAC-based Authorization specifies that ports configured for 802.1x are initialized based on the port number and the MAC address of the computer being authorized and are then subject to any authorization parameters configured.
802.1x Authentication Protocol	The user may use the pull-down menu to choose between <i>radius eap</i> and <i>radius pap</i> for the 802.1x authentication protocol on the Switch. The default setting is <i>radius eap</i> .
Asymmetric VLAN	This field will enable or disable Asymmetric VLANs on the Switch. The default is <i>Disabled</i> .
Syslog Global State	Enables or disables Syslog State; default is <i>Disabled</i> .

Click **Apply** to implement changes made.



NOTE: When the Asymmetric VLAN function is *Disabled*, the user must change the VLAN setting on the Switch to its default configurations.

Port Configuration

This section contains information for configuring various attributes and properties for individual physical ports and Err-disabled Ports, including port speed and flow control. Clicking on **Port Configurations** in the **Configuration** menu will display the following window for the user:

The screenshot shows the 'Port Configuration' window. At the top, there is a configuration form with the following fields: From (Port 1), To (Port 1), State (Disabled), Speed/Duplex (Auto), FlowCtrl (Disabled), Learn (Disabled), Trap (Disabled), and an Apply button. Below the form is a table titled 'The Port Information Table' with 7 columns: Port, State, Speed/Duplex, Connection, FlowCtrl, Learn, and Trap. The table lists 26 ports, with ports 1-17 and 19-26 showing 'Link Down' connections, and port 18 showing '100M/Full/None'. All other parameters (State, Speed/Duplex, FlowCtrl, Learn, Trap) are consistent across all rows.

Port	State	Speed/Duplex	Connection	FlowCtrl	Learn	Trap
1	Enabled	Auto	Link Down	Disabled	Enabled	Enabled
2	Enabled	Auto	Link Down	Disabled	Enabled	Enabled
3	Enabled	Auto	Link Down	Disabled	Enabled	Enabled
4	Enabled	Auto	Link Down	Disabled	Enabled	Enabled
5	Enabled	Auto	Link Down	Disabled	Enabled	Enabled
6	Enabled	Auto	Link Down	Disabled	Enabled	Enabled
7	Enabled	Auto	Link Down	Disabled	Enabled	Enabled
8	Enabled	Auto	Link Down	Disabled	Enabled	Enabled
9	Enabled	Auto	Link Down	Disabled	Enabled	Enabled
10	Enabled	Auto	Link Down	Disabled	Enabled	Enabled
11	Enabled	Auto	Link Down	Disabled	Enabled	Enabled
12	Enabled	Auto	Link Down	Disabled	Enabled	Enabled
13	Enabled	Auto	Link Down	Disabled	Enabled	Enabled
14	Enabled	Auto	Link Down	Disabled	Enabled	Enabled
15	Enabled	Auto	Link Down	Disabled	Enabled	Enabled
16	Enabled	Auto	Link Down	Disabled	Enabled	Enabled
17	Enabled	Auto	Link Down	Disabled	Enabled	Enabled
18	Enabled	Auto	100M/Full/None	Disabled	Enabled	Enabled
19	Enabled	Auto	Link Down	Disabled	Enabled	Enabled
20	Enabled	Auto	Link Down	Disabled	Enabled	Enabled
21	Enabled	Auto	Link Down	Disabled	Enabled	Enabled
22	Enabled	Auto	Link Down	Disabled	Enabled	Enabled
23	Enabled	Auto	Link Down	Disabled	Enabled	Enabled
24	Enabled	Auto	Link Down	Disabled	Enabled	Enabled
25	Enabled	Auto	Link Down	Disabled	Enabled	Enabled
26	Enabled	Auto	Link Down	Disabled	Enabled	Enabled

Below the table is a link labeled 'Show Err-disabled Ports'.

Figure 6- 4. Port Configuration window

To configure switch ports:

1. Choose the port or sequential range of ports using the From...To... port pull-down menus.
2. Use the remaining pull-down menus to configure the parameters described below:

Parameter	Description
State	Toggle the State field to either enable or disable a given port or group of ports.
Speed/Duplex	Toggle the Speed/Duplex field to either select the speed and duplex/half-duplex state of the port. <i>Auto</i> denotes auto-negotiation between 10 and 100 Mbps devices, in full- or half-duplex. The <i>Auto</i> setting allows the port to automatically determine the fastest settings the device the port is connected to can handle, and then to use those settings. The other options are <i>Auto</i> , <i>10M/Half</i> , <i>10M/Full</i> , <i>100M/Half</i> , <i>100M/Full</i> , and <i>1000M/Full</i> . There is no automatic adjustment of port settings with any option other than <i>Auto</i> .
Flow Control	Displays the flow control scheme used for the various port configurations. Ports configured for full-duplex use 802.3x flow control, half-duplex ports use backpressure flow control, and <i>Auto</i> ports use an automatic selection of the two. The default is <i>Disabled</i> .
Learn	Enable or disable MAC address learning for the selected ports. When <i>Enabled</i> , destination and source MAC addresses are automatically listed in the forwarding table. When learning is <i>Disabled</i> , MAC addresses must be manually entered into the forwarding table. This is sometimes done for reasons of security or efficiency. See the section on Forwarding/Filtering for information on entering MAC addresses into the forwarding table. The default setting is

	<i>Disabled.</i>
Trap	Enables or disables trap support on the switch. The default setting is <i>Disabled</i> .

Click **Apply** to implement the new settings on the Switch.

To display the detail information about disabled ports as the following window, click the hyperlink: [Show Err-disabled Ports](#) from the above **Port Configuration** window. The **Err-Disabled Ports** window lists the current connection status and reason for a port being disabled. To exit the window, click the hyperlink: [Return to Port Setting page](#).

Err-Disabled Ports			
Port	Port State	Connection Status	Reason
Return to Port Setting page			

Port Description

The DES-3500 Series switches support a port description feature where the user may name various ports on the Switch. To assign names to various ports, click the **Port Description** on the **Configuration** menu:

Port Description Setting		
From	To	Description
Port 1	Port 1	<input type="text"/>
Apply		
Port Description Table		
Port	Description	
1		
2		
3		
4		
5		
6		
7		
8		
9		
10		
11		
12		
13		
14		
15		
16		
17		
18		
19		
20		
21		
22		
23		
24		
25		
26		

Figure 6- 5. Port Description Setting window

Use the **From** and **To** pull down menu to choose a port or range of ports to describe, and then enter a description of the port(s). Click **Apply** to set the descriptions in the **Port Description Table**.

Port Mirroring

The Switch allows you to copy frames transmitted and received on a port and redirect the copies to another port. You can attach a monitoring device to the mirrored port, such as a sniffer or an RMON probe, to view details about the packets passing through the first port. This is useful for network monitoring and troubleshooting purposes. To view the **Port Mirroring** window, click **Port Mirroring** in the **Configuration** folder.

Setup Port Mirroring													
Source Port	1	2	3	4	5	6	7	8	9	10	11	12	13
None	<input type="radio"/>	<input type="radio"/>	<input type="radio"/>	<input type="radio"/>	<input type="radio"/>	<input type="radio"/>	<input type="radio"/>	<input type="radio"/>	<input type="radio"/>	<input type="radio"/>	<input type="radio"/>	<input type="radio"/>	<input type="radio"/>
Ingress	<input type="radio"/>	<input type="radio"/>	<input type="radio"/>	<input type="radio"/>	<input type="radio"/>	<input type="radio"/>	<input type="radio"/>	<input type="radio"/>	<input type="radio"/>	<input type="radio"/>	<input type="radio"/>	<input type="radio"/>	<input type="radio"/>
Egress	<input type="radio"/>	<input type="radio"/>	<input type="radio"/>	<input type="radio"/>	<input type="radio"/>	<input type="radio"/>	<input type="radio"/>	<input type="radio"/>	<input type="radio"/>	<input type="radio"/>	<input type="radio"/>	<input type="radio"/>	<input type="radio"/>
Both	<input type="radio"/>	<input type="radio"/>	<input type="radio"/>	<input type="radio"/>	<input type="radio"/>	<input type="radio"/>	<input type="radio"/>	<input type="radio"/>	<input type="radio"/>	<input type="radio"/>	<input type="radio"/>	<input type="radio"/>	<input type="radio"/>
Source Port	14	15	16	17	18	19	20	21	22	23	24	25	26
None	<input type="radio"/>	<input type="radio"/>	<input type="radio"/>	<input type="radio"/>	<input type="radio"/>	<input type="radio"/>	<input type="radio"/>	<input type="radio"/>	<input type="radio"/>	<input type="radio"/>	<input type="radio"/>	<input type="radio"/>	<input type="radio"/>
Ingress	<input type="radio"/>	<input type="radio"/>	<input type="radio"/>	<input type="radio"/>	<input type="radio"/>	<input type="radio"/>	<input type="radio"/>	<input type="radio"/>	<input type="radio"/>	<input type="radio"/>	<input type="radio"/>	<input type="radio"/>	<input type="radio"/>
Egress	<input type="radio"/>	<input type="radio"/>	<input type="radio"/>	<input type="radio"/>	<input type="radio"/>	<input type="radio"/>	<input type="radio"/>	<input type="radio"/>	<input type="radio"/>	<input type="radio"/>	<input type="radio"/>	<input type="radio"/>	<input type="radio"/>
Both	<input type="radio"/>	<input type="radio"/>	<input type="radio"/>	<input type="radio"/>	<input type="radio"/>	<input type="radio"/>	<input type="radio"/>	<input type="radio"/>	<input type="radio"/>	<input type="radio"/>	<input type="radio"/>	<input type="radio"/>	<input type="radio"/>
Target Port	Port 1												
Status	Enabled												
<input type="button" value="Apply"/>													
<p>Note(1):The "Source Port" and "Target Port" should be different or the setup will be invalid.</p> <p>Note(2):The "Target Port" should be a non-trunked port.</p> <p>The Trunking Ports: None</p>													

Figure 6- 6. Setup Port Mirroring window

To configure a mirror port:

- Select the Source Port from where you want to copy frames and the Target Port, which receives the copies from the source port.
- Select the Source Direction, Ingress, Egress, or Both and change the Status drop-down menu to *Enabled*.
- Click **Apply** to let the changes take effect.



NOTE: You cannot mirror a fast port onto a slower port. For example, if you try to mirror the traffic from a 100 Mbps port onto a 10 Mbps port, this can cause throughput problems. The port you are copying frames from should always support an equal or lower speed than the port to which you are sending the copies. Also, the target port for the mirroring cannot be a member of a trunk group. Please note a target port and a source port cannot be the same port.

Link Aggregation

Understanding Port Trunk Groups

Port trunk groups are used to combine a number of ports together to make a single high-bandwidth data pipeline.

The DES-3500 Series switches support up to six port trunk groups with 2 to 8 ports in each group. A potential bit rate of 8000 Mbps can be achieved.

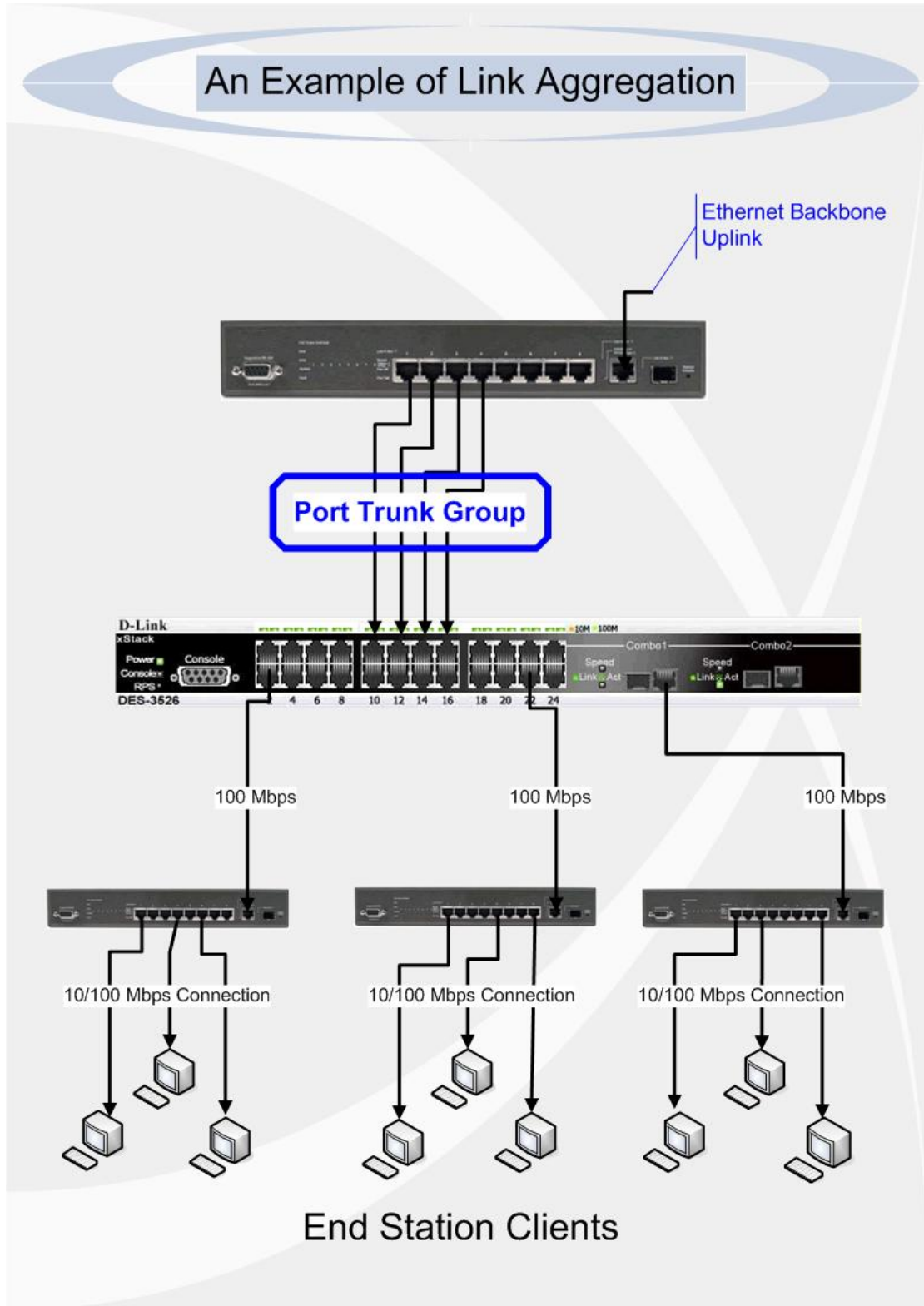

Figure 6-7. Example of Port Trunk Group

The Switch treats all ports in a trunk group as a single port. Data transmitted to a specific host (destination address) will always be transmitted over the same port in a trunk group. This allows packets in a data stream to arrive in the same order they were sent.



NOTE: If any ports within the trunk group become disconnected, packets intended for the disconnected port will be load shared among the other unlinked ports of the link aggregation group.

Link aggregation allows several ports to be grouped together and to act as a single link. This gives a bandwidth that is a multiple of a single link's bandwidth.

Link aggregation is most commonly used to link a bandwidth intensive network device or devices, such as a server, to the backbone of a network.

The Switch allows the creation of up to six link aggregation groups, each group consisting of 2 to 8 links (ports). The aggregated links must be contiguous (they must have sequential port numbers) except the two (optional) Gigabit ports, which can only belong to a single link aggregation group. All of the ports in the group must be members of the same VLAN, and their STP status, static multicast, traffic control; traffic segmentation and 802.1p default priority configurations must be identical. Port locking, port mirroring and 802.1X must not be enabled on the trunk group. Further, the aggregated links must all be of the same speed and should be configured as full duplex.

The Master Port of the group is to be configured by the user, and all configuration options, including the VLAN configuration that can be applied to the Master Port, are applied to the entire link aggregation group.

Load balancing is automatically applied to the ports in the aggregated group, and a link failure within the group causes the network traffic to be directed to the remaining links in the group.

The Spanning Tree Protocol will treat a link aggregation group as a single link, on the switch level. On the port level, the STP will use the port parameters of the Master Port in the calculation of port cost and in determining the state of the link aggregation group. If two redundant link aggregation groups are configured on the Switch, STP will block one entire group; in the same way STP will block a single port that has a redundant link.

To configure port trunking, click on the **Link Aggregation** hyperlink in the **Configuration** folder to bring up the following window:

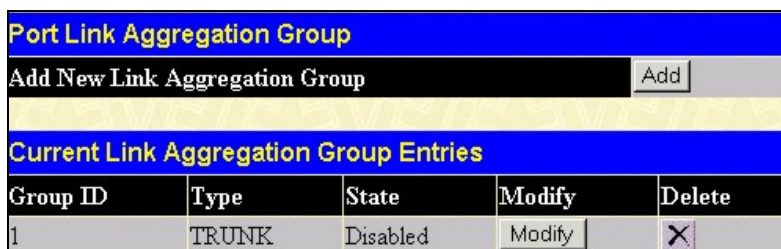

Figure 6- 8. Port Link Aggregation Group window

To configure port trunk groups, click the **Add** button to add a new trunk group and use the **Link Aggregation Settings** window (see example below) to set up trunk groups. To modify a port trunk group, click the **Modify** button corresponding to the entry you wish to alter. To delete a port trunk group, click the corresponding X under the Delete heading in the **Current Link Aggregation Group Entries** table.



Figure 6- 9. Link Aggregation Settings window – Add

Link Aggregation Settings													
Group ID(1-6)	<input type="text" value="1"/>												
State	Disabled ▾												
Master Port	Port 1 ▾												
Member Ports	1	2	3	4	5	6	7	8	9	10	11	12	13
	<input type="checkbox"/>	<input type="checkbox"/>	<input type="checkbox"/>	<input type="checkbox"/>	<input type="checkbox"/>	<input type="checkbox"/>	<input type="checkbox"/>	<input type="checkbox"/>	<input type="checkbox"/>	<input type="checkbox"/>	<input type="checkbox"/>	<input type="checkbox"/>	<input type="checkbox"/>
Member Ports	14	15	16	17	18	19	20	21	22	23	24	25	26
	<input type="checkbox"/>	<input type="checkbox"/>	<input type="checkbox"/>	<input type="checkbox"/>	<input type="checkbox"/>	<input type="checkbox"/>	<input type="checkbox"/>	<input type="checkbox"/>	<input type="checkbox"/>	<input type="checkbox"/>	<input type="checkbox"/>	<input type="checkbox"/>	<input type="checkbox"/>
Type	Static ▾												
Active Port													
Flooding Port	0												
													Apply
<p>Note: It is only valid to set up at most 8 member ports of any one trunk group and a port can be a member of only one trunk group at a time.</p> <p>Show All Link Aggregation Group Entries</p>													

Figure 6- 10. Link Aggregation Settings window - Modify

The user-changeable parameters are as follows:

Parameter	Description
Group ID	Select an ID number for the group, between 1 and 6.
State	Trunk groups can be toggled between <i>Enabled</i> and <i>Disabled</i> . This is used to turn a port trunking group on or off. This is useful for diagnostics, to quickly isolate a bandwidth intensive network device or to have an absolute backup aggregation group that is not under automatic control.
Master Port	Choose the Master Port for the trunk group using the pull-down menu.
Member Ports	Choose the members of a trunked group. Up to eight ports per group can be assigned to a group.
Flooding Port	A trunking group must designate one port to allow transmission of broadcasts and unknown unicasts.
Active Port	Shows the port that is currently forwarding packets.
Type	This pull-down menu allows you to select between <i>Static</i> and <i>LACP</i> (Link Aggregation Control Protocol). LACP allows for the automatic detection of links in a Port Trunking Group.

After setting the previous parameters, click **Apply** to allow your changes to be implemented. Successfully created trunk groups will be show in the **Current Link Aggregation Group Entries** table as seen in Figure 6-8.

LACP Port Setting

The **LACP Port Setting** window is used in conjunction with the **Link Aggregation** window to create port trunking groups on the Switch. Using the following window, the user may set which ports will be active and passive in processing and sending LACP control frames.

LACP Port Settings			
From	To	Mode	Apply
Port 1	Port 1	Passive	Apply

LACP Port Table	
Port	Activity
1	Passive
2	Passive
3	Passive
4	Passive
5	Passive
6	Passive
7	Passive
8	Passive
9	Passive
10	Passive
11	Passive
12	Passive
13	Passive
14	Passive
15	Passive
16	Passive
17	Passive
18	Passive
19	Passive
20	Passive
21	Passive
22	Passive
23	Passive
24	Passive
25	Passive
26	Passive

Figure 6- 11. LACP Port Settings window

The user may set the following parameters:

Parameter	Description
From/To	A consecutive group of ports may be configured starting with the selected port.
Mode	<p><i>Active</i> - Active LACP ports are capable of processing and sending LACP control frames. This allows LACP compliant devices to negotiate the aggregated link so the group may be changed dynamically as needs require. In order to utilize the ability to change an aggregated port group, that is, to add or subtract ports from the group, at least one of the participating devices must designate LACP ports as active. Both devices must support LACP.</p> <p><i>Passive</i> - LACP ports that are designated as passive cannot initially send LACP control frames. In order to allow the linked port group to negotiate adjustments and make changes dynamically, one end of the connection must have "active" LACP ports (see above).</p>

After setting the previous parameters, click **Apply** to allow your changes to be implemented. The LACP Port Table shows which ports are active and/or passive.

MAC Notification

MAC Notification is used to monitor MAC addresses learned and entered into the forwarding database.

MAC Notification Global Settings

To globally set MAC notification on the Switch, open the following window by opening the **MAC Notification** folder and clicking the **MAC Notification Global Settings** link:

Figure 6- 12. MAC Notification Global Settings window

The following parameters may be modified:

Parameter	Description
State	Enable or disable MAC notification globally on the Switch
Interval (sec)	The time in seconds between notifications.
History size	The maximum number of entries listed in the history log used for notification. Up to 500 entries can be specified.

MAC Notification Port Settings

To change MAC notification settings for a port or group of ports on the Switch, click **Port Settings** in the **MAC Notification** folder, which will display the following window:

MAC Notification Port Settings			
From	To	State	Apply
Port 1	Port 1	Disabled	Apply
MAC Notification Port State Table			
Port	State		
1	Disabled		
2	Disabled		
3	Disabled		
4	Disabled		
5	Disabled		
6	Disabled		
7	Disabled		
8	Disabled		
9	Disabled		
10	Disabled		
11	Disabled		
12	Disabled		
13	Disabled		
14	Disabled		
15	Disabled		
16	Disabled		
17	Disabled		
18	Disabled		
19	Disabled		
20	Disabled		
21	Disabled		
22	Disabled		
23	Disabled		
24	Disabled		
25	Disabled		
26	Disabled		

Figure 6- 13. MAC Notification Port Settings window

The following parameters may be set:

Parameter	Description
From...To	Select a port or group of ports to enable for MAC notification using the pull-down menus.
State	Enable MAC Notification for the ports selected using the pull-down menu.

Click **Apply** to implement changes made.

IGMP

Internet Group Management Protocol (IGMP) snooping allows the Switch to recognize IGMP queries and reports sent between network stations or devices and an IGMP host. When enabled for IGMP snooping, the Switch can open or close a port to a specific device based on IGMP messages passing through the Switch.

In order to use IGMP Snooping it must first be enabled for the entire Switch (see **Advanced Settings**). You may then fine-tune the settings for each VLAN using the **IGMP Snooping** link in the **Configuration** folder. When enabled for IGMP snooping, the Switch can open or close a port to a specific multicast group member based on IGMP messages sent from the device to the IGMP host or vice versa. The Switch monitors IGMP messages and discontinues forwarding multicast packets when there are no longer hosts requesting that they continue.

IGMP Snooping

Use the **Current IGMP Snooping Group Entries** window to view **IGMP Snooping** settings. To modify the settings, click the **Modify** button of the VLAN ID you want to change.

Current IGMP Snooping Group Entries				
VLAN ID	VLAN Name	State	Querier State	Modify
1	default	Disabled	Disabled	<input type="button" value="Modify"/>
4094	Trinity	Disabled	Disabled	<input type="button" value="Modify"/>

Figure 6- 14. Current IGMP Snooping Group Entries window

Clicking the **Modify** button will open the **IGMP Snooping Settings** window, shown below:

IGMP Snooping Settings	
VLAN ID	4094
VLAN Name	Trinity
Query Interval	<input type="text" value="125"/>
Max Response Time	<input type="text" value="10"/>
Robustness Value	<input type="text" value="2"/>
Last Member Query Interval	<input type="text" value="1"/>
Host Timeout(1-16711450)	<input type="text" value="260"/>
Router Timeout(1-16711450)	<input type="text" value="260"/>
Leave Timer(0-16711450)	<input type="text" value="2"/>
Querier State	Disabled ▾
State	Disabled ▾
<input type="button" value="Apply"/>	
Show All IGMP Group Entries	

Figure 6- 15. IGMP Snooping Settings window

The following parameters may be viewed or modified:

Parameter	Description
VLAN ID	This is the VLAN ID that, along with the VLAN Name, identifies the VLAN the user wishes to modify the IGMP Snooping Settings for.
VLAN Name	This is the VLAN Name that, along with the VLAN ID, identifies the VLAN the user wishes to modify the IGMP Snooping Settings for.
Query Interval	The Query Interval field is used to set the time (in seconds) between transmitting IGMP queries. Entries between 1 and 65535 seconds are allowed. Default = 125.
Max Response Time	This determines the maximum amount of time in seconds allowed before sending an IGMP response report. The Max Response Time field allows an entry between 1 and 25 (seconds). Default = 10.
Robustness Variable	Adjust this variable according to expected packet loss. If packet loss on the VLAN is expected to be high, the Robustness Variable should be increased to accommodate increased packet loss. This entry field allows an entry of 1 to 255. Default = 2.
Last Member Query Interval	This field specifies the maximum amount of time between group-specific query messages, including those sent in response to leave group messages. Default = 1.
Host Timeout	This is the maximum amount of time in seconds allowed for a host to continue membership in a multicast group without the Switch receiving a host membership report. Default = 260.
Route Timeout	This is the maximum amount of time in seconds a route is kept in the forwarding table without receiving a membership report. Default = 260.
Leave Timer	This specifies the maximum amount of time in seconds between the Switch receiving a leave group message from a host, and the Switch issuing a group membership query. If no response to the membership query is received before the Leave Timer expires, the (multicast) forwarding entry for that host is deleted.
Querier State	Choose <i>Enabled</i> to enable transmitting IGMP Query packets or <i>Disabled</i> to disable. The default is <i>Disabled</i> .
State	Select <i>Enabled</i> to implement IGMP Snooping. This field is <i>Disabled</i> by default.

Click **Apply** to implement the new settings. Click the [Show All IGMP Group Entries](#) link to return to the **Current IGMP Snooping Group Entries** window.

Static Router Ports Entry

A static router port is a port that has a multicast router attached to it. Generally, this router would have a connection to a WAN or to the Internet. Establishing a router port will allow multicast packets coming from the router to be propagated through the network, as well as allowing multicast messages (IGMP) coming from the network to be propagated to the router.

A router port has the following behavior:

- All IGMP Report packets will be forwarded to the router port.
- IGMP queries (from the router port) will be flooded to all ports.
- All UDP multicast packets will be forwarded to the router port. Because routers do not send IGMP reports or implement IGMP snooping, a multicast router connected to the router port of a Layer 3 switch would not be able to receive UDP data streams unless the UDP multicast packets were all forwarded to the router port.

A router port will be dynamically configured when IGMP query packets, RIPv2 multicast, DVMRP multicast or PIM-DM multicast packets are detected flowing into a port.

Open the **IGMP folder** and the click on the **Static Router Ports Entry** link to open the **Current Static Router Ports Entries** page, as shown below.

Current Static Router Ports Entries		
VLAN ID	VLAN Name	Modify
1	default	<input type="button" value="Modify"/>
4094	Trinity	<input type="button" value="Modify"/>

Figure 6- 16. Current Static Router Ports Entries window

The **Current Static Router Ports Entries** window displays all of the current entries to the Switch's static router port table. To modify an entry, click the **Modify** button. This will open the **Static Router Ports Settings** window, as shown below.

Static Router Ports Settings												
VID		4094										
VLAN Name		Trinity										
Member Ports												
1	2	3	4	5	6	7	8	9	10	11	12	13
<input type="checkbox"/>	<input type="checkbox"/>	<input type="checkbox"/>	<input type="checkbox"/>	<input type="checkbox"/>	<input type="checkbox"/>	<input type="checkbox"/>	<input type="checkbox"/>	<input type="checkbox"/>	<input type="checkbox"/>	<input type="checkbox"/>	<input type="checkbox"/>	<input type="checkbox"/>
14	15	16	17	18	19	20	21	22	23	24	25	26
<input type="checkbox"/>	<input type="checkbox"/>	<input type="checkbox"/>	<input type="checkbox"/>	<input type="checkbox"/>	<input type="checkbox"/>	<input type="checkbox"/>	<input type="checkbox"/>	<input type="checkbox"/>	<input type="checkbox"/>	<input type="checkbox"/>	<input type="checkbox"/>	<input type="checkbox"/>
<input type="button" value="Apply"/>												
Show All Static Router Ports Entries												

Figure 6- 17. Static Router Ports Settings window

The following parameters can be set:

Parameter	Description
VID (VLAN ID)	This is the VLAN ID that, along with the VLAN Name, identifies the VLAN where the multicast router is attached.
VLAN Name	This is the name of the VLAN where the multicast router is attached.
Member Ports	Ports on the Switch that will have a multicast router attached to them.

Click **Apply** to implement the new settings, Click the [Show All Static Router Port Entries](#) link to return to the **Current Static Router Port Entries** window.

Forbidden Router Ports Entry

The Forbidden Router Ports Entry section will allow users to set a port or group of ports belonging to a VLAN as being forbidden from receiving information from or being connected to multicast routers. To view the following window, click **Configuration > IGMP > Forbidden Router Ports Entry**.

Current Forbidden MC Router Ports Entries			
VLAN ID	VLAN Name	Port List	Modify
1	default	5-6	<input type="button" value="Modify"/>

Figure 6- 18. Current Forbidden MC Router Ports Entries

To change the forbidden router ports settings for a listed VLAN, click its corresponding **Modify** button, which will display the following configurable window.

Forbidden MC Router Ports Settings													
VID		1											
VLAN Name		default											
Member Ports													
1	2	3	4	5	6	7	8	9	10	11	12	13	
<input type="checkbox"/>	<input type="checkbox"/>	<input type="checkbox"/>	<input type="checkbox"/>	<input checked="" type="checkbox"/>	<input checked="" type="checkbox"/>	<input type="checkbox"/>	<input type="checkbox"/>	<input type="checkbox"/>	<input type="checkbox"/>	<input type="checkbox"/>	<input type="checkbox"/>	<input type="checkbox"/>	<input type="checkbox"/>
14	15	16	17	18	19	20	21	22	23	24	25	26	
<input type="checkbox"/>	<input type="checkbox"/>	<input type="checkbox"/>	<input type="checkbox"/>	<input type="checkbox"/>	<input type="checkbox"/>	<input type="checkbox"/>	<input type="checkbox"/>	<input type="checkbox"/>	<input type="checkbox"/>	<input type="checkbox"/>	<input type="checkbox"/>	<input type="checkbox"/>	<input type="checkbox"/>
<input type="button" value="Apply"/>													
Show All Forbidden MC Router Ports Entries													

Figure 6- 19. Forbidden MC Router Ports Settings

To add ports as forbidden router ports, click the corresponding check box of the port or ports, and click Apply. Properly set forbidden ports will be displayed in the **Current Forbidden MC Router Ports Entries** window under the **Port List** heading.

IGMP Multicast VLAN

Standard Internet Group Management Protocol (IGMP) snooping purposely limits multicast traffic so that only the interfaces actively associating with the multicast are flooded. A layer 2 switch will snoop IGMP packet traffic between a multicast router and host devices to learn and record the associated multicast groups and their member ports. A multicast forwarding table is maintained for each multicast group. The table consists of entries that match the multicast group with ports used for the multicast. A host will send an IGMP Join Group and Leave Group request when it wishes to receive or terminate a particular IP multicast. The Switch also sends periodic queries to multicast routers for membership reports used to keep the multicast group tables up to date.

IGMP snooping works well for enterprise or even campus level implementations using adequate and well-placed switching capacity. However, IGMP snooping is problematic for service providers that wish to deploy subscriber-based multicast traffic in an Ethernet switching environment when subscriber ports have their own unique VLAN; and because of the nature of the communication between an IGMP snooping enabled switch and the multicast router. This creates a problem for sending multicasts across separate VLANs.

The DES-3526 addresses this need by allowing the Switch to create a special network-wide shared VLANs used for multicasting. This allows each port to be in separate VLANs while using the special VLAN for multicast streams. A subscriber may subscribe (Join Group) or unsubscribe (Leave Group) to a multicast while the remaining subscribers are isolated from the multicast.

The Switch uses the special multicast VLAN to qualify MAC addresses in the Switch forwarding table as being members of the multicast. It uses IGMP to modify the forwarding table, that is, to add or delete MAC addresses as it receives Join or Leave requests from host devices.

To create IGMP Multicast VLANs for the Switch, click **Configuration > IGMP > IGMP Multicast VLAN**, which will provide the following window for the user to configure.

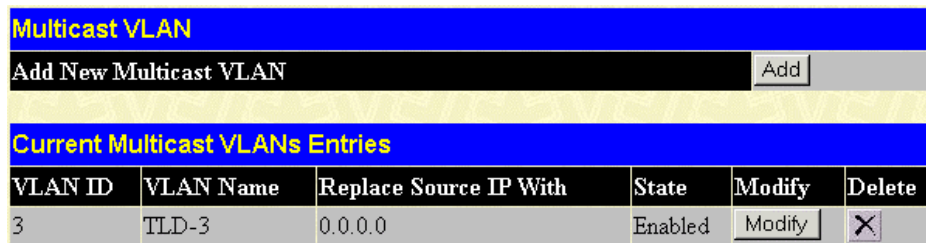

Figure 6- 20 Multicast VLAN and Current Multicast VLANs Entries Table

To create a new Multicast VLAN, click the **Add** button in the window above. The following window will be displayed.



Figure 6- 21 Multicast VLAN window (add)

The following parameters can be set:

Parameter	Description
VID	The VLAN ID of the multicast VLAN to be created. The user may choose a number between 1-4094 to identify this VLAN. Up to 3 multicast VLANs can be configured.
VLAN Name	The name of the multicast VLAN to be configured. Each multicast VLAN is given a name that can be up to 32 characters. Up to 3 multicast VLANs can be configured.
Replace Source IP With	Enter a source IP address that you want to replace in this field.
State	The user may enable or disable this VLAN using the pull down menu here.
Source Port	A port on the Switch to be designated as the source port for multicast traffic. Multicast traffic entering the switch will be forwarded from this port to member ports on the same VLAN. Note that the Source port must be different from the member ports of the created VLAN.
Member Port	A port or range of member ports to add to the multicast VLAN. These ports will receive multicast traffic from the source port. Remember, the source port cannot be the same as any member port.

Click Apply to create the multicast VLAN.

To modify a previously created multicast VLAN, click the Modify button in the **Current Multicast VLANs Entries Table**, which will display the following window for the user to configure.

Multicast VLAN													
VID	VLAN Name			Replace Source IP With				State					
3	TLD-3			0.0.0.0				Enabled					
Port Settings	1	2	3	4	5	6	7	8	9	10	11	12	13
None	<input type="radio"/>	<input type="radio"/>	<input type="radio"/>	<input type="radio"/>	<input type="radio"/>	<input type="radio"/>	<input type="radio"/>	<input type="radio"/>	<input type="radio"/>	<input type="radio"/>	<input type="radio"/>	<input type="radio"/>	<input type="radio"/>
Source Port	<input type="radio"/>	<input type="radio"/>	<input type="radio"/>	<input type="radio"/>	<input type="radio"/>	<input type="radio"/>	<input type="radio"/>	<input type="radio"/>	<input type="radio"/>	<input type="radio"/>	<input type="radio"/>	<input type="radio"/>	<input type="radio"/>
Member Port	<input type="radio"/>	<input type="radio"/>	<input type="radio"/>	<input type="radio"/>	<input type="radio"/>	<input type="radio"/>	<input type="radio"/>	<input type="radio"/>	<input type="radio"/>	<input type="radio"/>	<input type="radio"/>	<input type="radio"/>	<input type="radio"/>
Port Settings	14	15	16	17	18	19	20	21	22	23	24	25	26
None	<input type="radio"/>	<input type="radio"/>	<input type="radio"/>	<input type="radio"/>	<input type="radio"/>	<input type="radio"/>	<input type="radio"/>	<input type="radio"/>	<input type="radio"/>	<input type="radio"/>	<input type="radio"/>	<input type="radio"/>	<input type="radio"/>
Source Port	<input type="radio"/>	<input type="radio"/>	<input type="radio"/>	<input type="radio"/>	<input type="radio"/>	<input type="radio"/>	<input type="radio"/>	<input type="radio"/>	<input type="radio"/>	<input type="radio"/>	<input type="radio"/>	<input type="radio"/>	<input type="radio"/>
Member Port	<input type="radio"/>	<input type="radio"/>	<input type="radio"/>	<input type="radio"/>	<input type="radio"/>	<input type="radio"/>	<input type="radio"/>	<input type="radio"/>	<input type="radio"/>	<input type="radio"/>	<input type="radio"/>	<input type="radio"/>	<input type="radio"/>
Apply													
Show All Multicast VLAN Entries													

Figure 6- 22 Multicast VLAN window (window)

The following parameters can be set:

Parameter	Description
VID	Displays the VLAN ID of the configured multicast VLAN. Up to 3 multicast VLANs can be configured.
VLAN Name	The name of the configured multicast VLAN. Each multicast VLAN is given a name that can be up to 32 characters. Up to 3 multicast VLANs can be configured.
Replace Source IP With	Enter a source IP address that you want to replace in this field.
State	The user may enable or disable this VLAN using the pull down menu here.
Source Port	A port on the Switch to be designated as the source port for multicast traffic. Multicast traffic entering the switch will be forwarded from this port to member ports on the same VLAN. Note that the Source port must be different from the member ports of the created VLAN.
Member Port	A port or range of member ports to add to the multicast VLAN. These ports will receive multicast traffic from the source port. Remember, the source port cannot be the same as any member port.

Click Apply to configure the multicast VLAN.



Note: Once a Multicast VLAN has been configured and enabled on the switch, other IGMP Snooping settings will be overridden and the IGMP Snooping Multicast VLAN will take precedence.

Spanning Tree

This Switch supports three versions of the Spanning Tree Protocol; 802.1d STP, 802.1w Rapid STP and 802.1s MSTP. 802.1d STP will be familiar to most networking professionals. However, since 802.1w RSTP and 802.1s MSTP has been recently introduced to D-Link managed Ethernet switches, a brief introduction to the technology is provided below followed by a description of how to set up 802.1d STP, 802.1w RSTP and 802.1s MSTP.

802.1s MSTP

Multiple Spanning Tree Protocol, or MSTP, is a standard defined by the IEEE community that allows multiple VLANs to be mapped to a single spanning tree instance, which will provide multiple pathways across the network. Therefore, these MSTP configurations will balance the traffic load, preventing wide scale disruptions when a single spanning tree instance fails. This will allow for faster convergences of new topologies for the failed instance. Frames designated for these VLANs will be processed quickly and completely throughout interconnected bridges utilizing any of the three spanning tree protocols (STP, RSTP or MSTP).

This protocol will also tag BPDU packets so receiving devices can distinguish spanning tree instances, spanning tree regions and the VLANs associated with them. An MSTI ID will classify these instances. MSTP will connect multiple spanning trees with a Common and Internal Spanning Tree (CIST). The CIST will automatically determine each MSTP region, its maximum possible extent and will appear as one virtual bridge that runs a single spanning tree. Consequentially, frames assigned to different VLANs will follow different data routes within administratively established regions on the network, continuing to allow simple and full processing of frames, regardless of administrative errors in defining VLANs and their respective spanning trees.

Each switch utilizing the MSTP on a network will have a single MSTP configuration that will have the following three attributes:

1. A configuration name defined by an alphanumeric string of up to 32 characters (defined in the **STP Bridge Global Settings** window in the Configuration Name field).
2. A configuration revision number (named here as a Revision Level and found in the **STP Bridge Global Settings** window) and;
3. A 4096-element table (defined here as a VID List in the **MST Configuration Table** window), which will associate each of the possible 4096, VLANs supported by the Switch for a given instance.

To utilize the MSTP function on the Switch, three steps need to be taken:

1. The Switch must be set to the MSTP setting (found in the **STP Bridge Global Settings** window in the STP Version field)
2. The correct spanning tree priority for the MSTP instance must be entered (defined here as a Priority in the **MST Configuration Table** window when configuring an MSTI ID settings).
3. VLANs that will be shared must be added to the MSTP Instance ID (defined here as a VID List in the **MST Configuration Table** window when configuring an MSTI ID settings).

802.1w Rapid Spanning Tree

The Switch implements three versions of the Spanning Tree Protocol, the Multiple Spanning Tree Protocol (MSTP) as defined by the IEEE 802.1s, the Rapid Spanning Tree Protocol (RSTP) as defined by the IEEE 802.1w specification and a version compatible with the IEEE 802.1d STP. RSTP can operate with legacy equipment implementing IEEE 802.1d, however the advantages of using RSTP will be lost.

The IEEE 802.1w Rapid Spanning Tree Protocol (RSTP) evolved from the 802.1d STP standard. RSTP was developed in order to overcome some limitations of STP that impede the function of some recent switching innovations, in particular, certain Layer 3 functions that are increasingly handled by Ethernet switches. The basic function and much of the terminology is the same as STP. Most of the settings configured for STP are also used for RSTP. This section introduces some new Spanning Tree concepts and illustrates the main differences between the two protocols.

Port Transition States

An essential difference between the three protocols is in the way ports transition to a forwarding state and in the way this transition relates to the role of the port (forwarding or not forwarding) in the topology. MSTP and RSTP combine the transition states disabled, blocking and listening used in 802.1d and creates a single state Discarding. In either case, ports do not forward packets. In the STP port transition states disabled, blocking or listening or in the RSTP/MSTP port state discarding, there is no functional difference, the port is not active in the network topology. Table 6-1 below compares how the three protocols differ regarding the port state transition.

All three protocols calculate a stable topology in the same way. Every segment will have a single path to the root bridge. All bridges listen for BPDU packets. However, BPDU packets are sent more frequently - with every Hello packet. BPDU packets are sent even if a BPDU packet was not received. Therefore, each link between bridges is sensitive to the status of the link. Ultimately this difference results in faster detection of failed links, and thus faster topology adjustment. A drawback of 802.1d is this absence of immediate feedback from adjacent bridges.

802.1d MSTP	802.1w RSTP	802.1d STP	Forwarding	Learning
Discarding	Discarding	Disabled	No	No
Discarding	Discarding	Blocking	No	No
Discarding	Discarding	Listening	No	No
Learning	Learning	Learning	No	Yes
Forwarding	Forwarding	Forwarding	Yes	Yes

Table 6- 1. Comparing Port States

RSTP is capable of a more rapid transition to a forwarding state - it no longer relies on timer configurations - RSTP compliant bridges are sensitive to feedback from other RSTP compliant bridge links. Ports do not need to wait for the topology to stabilize before transitioning to a forwarding state. In order to allow this rapid transition, the protocol introduces two new variables: the edge port and the point-to-point (P2P) port.

Edge Port

The edge port is a configurable designation used for a port that is directly connected to a segment where a loop cannot be created. An example would be a port connected directly to a single workstation. Ports that are designated as edge ports transition to a forwarding state immediately without going through the listening and learning states. An edge port loses its status if it receives a BPDU packet, immediately becoming a normal spanning tree port.

P2P Port

A P2P port is also capable of rapid transition. P2P ports may be used to connect to other bridges. Under RSTP/MSTP, all ports operating in full-duplex mode are considered to be P2P ports, unless manually overridden through configuration.

802.1d/802.1w/802.1s Compatibility

MSTP or RSTP can interoperate with legacy equipment and is capable of automatically adjusting BPDU packets to 802.1d format when necessary. However, any segment using 802.1d STP will not benefit from the rapid transition and rapid topology change detection of MSTP or RSTP. The protocol also provides for a variable used for migration in the event that legacy equipment on a segment is updated to use RSTP or MSTP.

The Spanning Tree Protocol (STP) operates on two levels:

1. On the switch level, the settings are globally implemented.
2. On the port level, the settings are implemented on a per user-defined group of ports basis.

STP Bridge Global Settings

To open the following window, open the **Spanning Tree** folder in the **Configuration** menu and click the **STP Bridge Global Settings** link.

STP Bridge Global Settings	
STP Status	Disabled ▾
STP Version	STP ▾
Hello Time(1-2 Sec)	2
Max Age(6-40 Sec)	20
Forward Delay(4-30 Sec)	15
Max Hops(1-20)	20
TX Hold Count(1-10)	6
Forwarding BPDU	Enabled ▾
MST Configuration Identification	
Configuration Name	00:19:5B:72:E8:F9
Revision Level(0-65535)	0
If the STP version is different from current settings. STP settings will return to default. Are you sure you want to set with STP? If yes, click the "Apply" button .	
Apply	

Figure 6- 23. STP Bridge Global Settings window - STP

STP Bridge Global Settings	
STP Status	Disabled ▾
STP Version	RSTP ▾
Hello Time(1-2 Sec)	2
Max Age(6-40 Sec)	20
Forward Delay(4-30 Sec)	15
Max Hops(1-20)	20
TX Hold Count(1-10)	6
Forwarding BPDU	Enabled ▾
MST Configuration Identification	
Configuration Name	00:19:5B:72:E8:F9
Revision Level(0-65535)	0
If the STP version is different from current settings. STP settings will return to default. Are you sure you want to set with STP? If yes, click the "Apply" button .	
Apply	

Figure 6- 24. STP Bridge Global Settings window - RSTP (default)

STP Bridge Global Settings	
STP Status	Disabled ▾
STP Version	MSTP ▾
Max Age(6-40 Sec)	20
Forward Delay(4-30 Sec)	15
Max Hops(1-20)	20
TX Hold Count(1-10)	6
Forwarding BPDU	Enabled ▾
MST Configuration Identification	
Configuration Name	00:19:5B:72:E8:F9
Revision Level(0-65535)	0
If the STP version is different from current settings. STP settings will return to default. Are you sure you want to set with STP? If yes, click the "Apply" button .	
Apply	

Figure 6- 25. STP Bridge Global Settings window - MSTP



NOTE: The Hello Time cannot be longer than the Max. Age. Otherwise, a configuration error will occur. Observe the following formulas when setting the above parameters:

Max. Age ≤ 2 x (Forward Delay - 1 second)

Max. Age ≥ 2 x (Hello Time + 1 second)

The following parameters can be set:

Parameter	Description
STP Status	Use the pull-down menu to enable or disable STP globally on the Switch. The default is <i>Disabled</i> .
STP Version	Use the pull-down menu to choose the desired version of STP to be implemented on the Switch. There are three choices: <i>STP</i> - Select this parameter to set the Spanning Tree Protocol (STP) globally on the switch. <i>RSTP</i> - Select this parameter to set the Rapid Spanning Tree Protocol (RSTP) globally on the Switch. <i>MSTP</i> - Select this parameter to set the Multiple Spanning Tree Protocol (MSTP) globally on the Switch.
Hello Time	The Hello Time can be set from 1 to 2 seconds. This is the interval between two transmissions of BPDU packets sent by the Root Bridge to tell all other switches that it is indeed the Root Bridge. This field will only appear here when STP or RSTP is selected for the STP Version. For MSTP, the Hello Time must be set on a port per port basis. See the MST Port Settings section for further details.
Max Age	The Max Age may be set to ensure that old information does not endlessly circulate through redundant paths in the network, preventing the effective propagation of the new information. Set by the Root Bridge, this value will aid in determining that the Switch has spanning tree configuration values consistent with other devices on the bridged LAN. If the value ages out and a BPDU has still not been received from the Root Bridge, the Switch will start sending its own BPDU to all other switches for permission to become the Root Bridge. If it turns out that your switch has the lowest Bridge Identifier, it will become the Root Bridge. The user may choose a time between 6 and 40 seconds. The default value is 20.
Forward Delay	The Forward Delay can be from 4 to 30 seconds. Any port on the Switch spends this time in the listening state while moving from the blocking state to the forwarding state.
Max Hops	Used to set the number of hops between devices in a spanning tree region before the BPDU (bridge protocol data unit) packet sent by the Switch will be discarded. Each switch on the hop count will reduce the hop count by one until the value reaches zero. The Switch will then discard the BPDU packet and the information held for the port will age out. The user may set a hop count

	from 1 to 20. The default is 20.
TX Hold Count	Used to set the maximum number of Hello packets transmitted per interval. The count can be specified from 1 to 10. The default is 6.
Forwarding BPDUs	This field can be <i>Enabled</i> or <i>Disabled</i> . When <i>Enabled</i> , it allows the forwarding of STP BPDU packets from other network devices. The default is <i>Enabled</i> .
MST Configuration Identification	
Configuration Name	Enter an alphanumeric string of up to 32 characters to uniquely identify the MSTP region on the Switch. This Configuration Name, along with the Revision Level value will identify the MSTP region configured on the Switch. If no name is entered, the default name will be the MAC address of the device. This field is only valid when MSTP is the version of STP globally set on the Switch.
Revision Level	Enter a number between 0 and 65535 to identify the MSTP region. This value, along with the name will identify the MSTP region configured on the Switch. The default setting is 0. This field is only valid when MSTP is the version of STP globally set on the Switch.

Click **Apply** to implement changes made.

MST Configuration Table

The following screens in the **MST Configuration Table** window allow the user to configure a MSTI instance on the Switch. These settings will uniquely identify a multiple spanning tree instance set on the Switch. The Switch initially possesses one *CIST* or Common Internal Spanning Tree of which the user may modify the parameters for but cannot change the MSTI ID for, and cannot be deleted. To view the **Current MST Configuration Identification** window, click **Configuration > Spanning Tree > MST Configuration Table**:

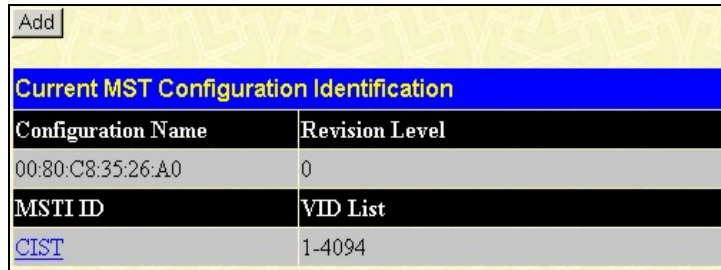

Figure 6- 26. Current MST Configuration Identification window

The window above contains the following information:

Parameter	Description
Configuration Name	A previously configured name set on the Switch to uniquely identify the MSTI (Multiple Spanning Tree Instance). If a configuration name is not set, this field will show the MAC address to the device running MSTP. This field can be set in the STP Bridge Global Settings window.
Revision Level	This value, along with the Configuration Name will identify the MSTP region configured on the Switch. This field can also be set in the STP Bridge Global Settings window.
MSTI ID	This field shows the MSTI IDs currently set on the Switch. This field will always have the CIST MSTI, which may be configured but not deleted. Clicking the hyperlinked name will open a new window for configuring parameters associated with that particular MSTI.
VID List	This field displays the VLAN IDs associated with the specific MSTI.

Clicking the **Add** button will reveal the following window to configure:



Figure 6- 27. Instance ID Settings window – Add

The user may configure the following parameters to create a MSTI in the Switch.

Parameter	Description
MSTI ID	Enter a number between 1 and 4 to set a new MSTI on the Switch.
Type	Create is selected to create a new MSTI. No other choices are available for this field when creating a new MSTI.
VID List (1-4094)	This field is used to specify the VID range from configured VLANs set on the Switch. Supported VIDs on the Switch range from ID number 1 to 4094.
Priority (0-61440)	Select a value between 0 and 61440 to specify the priority for a specified MSTI for forwarding packets. The lower the value, the higher the priority. This entry must be divisible by 4094.

Click **Apply** to implement changes made.

To configure the settings for the CIST, click on its hyperlinked name in the **Current MST Configuration Identification** window, which will reveal the following window to configure:

Figure 6- 28. Instance ID Settings window - CIST modify

The user may configure the following parameters to configure the CIST on the Switch.

Parameter	Description
MSTI ID	The MSTI ID of the CIST is 0 and cannot be altered.
Type	The type of configuration about to be processed. This window is used to set the priority for the CIST only. All other parameters are permanently set and therefore unchangeable.
VID List (1-4094)	This field is used to specify the VID range from configured VLANs set on the Switch. Supported VIDs on the Switch range from ID number 1 to 4094. This field is inoperable when configuring the CIST.
Priority (0-61440)	Select a value between 0 and 61440 to specify the priority for a specified MSTI for forwarding packets. The lower the value, the higher the priority. This entry must be divisible by 4094.

Click **Apply** to implement changes made.

To configure the parameters for a previously set MSTI, click on its hyperlinked MSTI ID number, which will reveal the following window for configuration.

Figure 6- 29. Instance ID Settings window – modify

The user may configure the following parameters for a MSTI on the Switch.

Parameter	Description
MSTI ID	Displays the MSTI ID previously set by the user.
Type	This field allows the user to choose a desired method for altering the MSTI settings. The user has four choices. <ul style="list-style-type: none"> <i>Add</i> - Select this parameter to add VIDs to the MSTI ID, in conjunction with the VID List parameter. <i>Remove</i> - Select this parameter to remove VIDs from the MSTI ID, in conjunction with the VID List parameter. <i>Delete</i> - Select this parameter to delete this MSTI ID. <i>Set Priority Only</i> - Select this parameter to set the priority for the MSTI ID. This field is used in conjunction with the Priority field.
VID List (1-4094)	This field is used to specify the VID range from configured VLANs set on the Switch that the user wishes to add to this MSTI ID. Supported VIDs on the Switch range from ID number 1 to 4094. This parameter can only be utilized if the Type chosen is <i>Add</i> or <i>Remove</i> .

Priority (0-61440)	Select a value between 0 and 61440 to specify the priority for a specified MSTI for forwarding packets. The lower the value, the higher the priority. This entry must be divisible by 4094 and can only be utilized if the Type chosen is Set Priority Only.
---------------------------	--

Click **Apply** to implement changes made.

MSTI Settings

This window displays the current MSTI configuration settings and can be used to update the port configuration for an MSTI ID. If a loop occurs, the MSTP function will use the port priority to select an interface to put into the forwarding state. Set a higher priority value for interfaces to be selected for forwarding first. In instances where the priority value is identical, the MSTP function will implement the lowest MAC address into the forwarding state and other interfaces will be blocked. Remember that lower priority values mean higher priorities for forwarding packets.

To view the following window, click **Configuration > Spanning Tree > MSTP Settings**:

Msti	Designated Bridge	Internal PathCost	Prio	Status	Role
0	8000/0050ba7120d6	200000	128	Forwarding	Root
2	1002/0080c83526a0	200000	128	Forwarding	Master

Figure 6- 30. MSTP Port Information window

To view the MSTI settings for a particular port, select the Port number, located in the top left hand corner of the screen and click **Apply**. To modify the settings for a particular MSTI Instance, click on its hyperlinked MSTI ID, which will reveal the following window.

Instance ID	2
Internal cost(0=Auto)	200000
Priority	128

[Show MSTI Table](#)

Figure 6- 31. MSTI Settings window

Parameter	Description
Instance ID	Displays the MSTI ID of the instance being configured. An entry of 0 in this field denotes the CIST (default MSTI).
Internal cost (0=Auto)	This parameter is set to represent the relative cost of forwarding packets to specified ports when an interface is selected within a STP instance. The default setting is 0 (auto). There are two options: <ul style="list-style-type: none"> 0 (auto) - Selecting this parameter for the <i>internalCost</i> will set quickest route automatically and optimally for an interface. The default value is derived from the media speed of the interface. value 1-2000000 - Selecting this parameter with a value in the range of 1-2000000 will set the quickest route when a loop occurs. A lower Internal cost represents a quicker transmission.
Priority	Enter a value between 0 and 240 to set the priority for the port interface. A higher priority will designate the interface to forward packets first. A lower number denotes a higher priority.

Click **Apply** to implement changes made.

STP Instance Settings

The following window displays MSTIs currently set on the Switch. To view the following table, click **Configuration > Spanning Tree > STP Instance Settings**:

STP Instance Table		
Instance Type	Instance Status	Instance Priority
CIST	Enabled	32768(bridge priority : 32768, sys ID ext : 0)
MSTI(2)	Enabled	4098(bridge priority : 4096, sys ID ext : 2)

Figure 6- 32. STP Instance Table window

The following information is displayed:

Parameter	Description
Instance Type	Displays the instance type(s) currently configured on the Switch. Each instance type is classified by a MSTI ID. CIST refers to the default MSTI configuration set on the Switch.
Instance Status	Displays the current status of the corresponding MSTI ID
Instance Priority	Displays the priority of the corresponding MSTI ID. The lowest priority will be the root bridge.

Click **Apply** to implement changes made.

To acquire more detailed information on a particular STP Instance, click its hyperlinked Instance Type, which will display the following read-only window.

STP Instance Operational Status	
Regional Root Bridge	32770/00-80-c8-35-26-a0
Internal Root Cost	0
Designated Bridge	32770/00-80-c8-35-26-a0
Root Port	None
Remaining Hops	20
Last Topology Change	181
Topology Changes Count	0
Show STP Instance Table	

Figure 6- 33. STP Instance Operational Status

MSTP Port Information

STP can be set up on a port per port basis. To view the following window click **Configuration > Spanning Tree > MST Port Information**:

STP Port Settings

From	To	External Cost (0=Auto)	Hello Time	Migrate	Edge	Restricted Role	Restricted TCN	P2P	Forward BPDU	State
Port 1	Port 1	0		Yes	False	False	False	Auto	False	Enabled

MSTP Port Information Table

Port	External Cost	Hello Time	Edge	Restricted Role	Restricted TCN	P2P	Forward BPDU	Port STP State
1	AUTO/200000	2/2	False/No	False	False	Auto/Yes	False	Enabled
2	AUTO/200000	2/2	False/No	False	False	Auto/Yes	False	Enabled
3	AUTO/200000	2/2	False/No	False	False	Auto/Yes	False	Enabled
4	AUTO/200000	2/2	False/No	False	False	Auto/Yes	False	Enabled
5	AUTO/200000	2/2	False/No	False	False	Auto/Yes	False	Enabled
6	AUTO/200000	2/2	False/No	False	False	Auto/Yes	False	Enabled
7	AUTO/200000	2/2	False/No	False	False	Auto/Yes	False	Enabled
8	AUTO/200000	2/2	False/No	False	False	Auto/Yes	False	Enabled
9	AUTO/200000	2/2	False/No	False	False	Auto/Yes	False	Enabled
10	AUTO/200000	2/2	False/No	False	False	Auto/Yes	False	Enabled
11	AUTO/200000	2/2	False/No	False	False	Auto/Yes	False	Enabled
12	AUTO/200000	2/2	False/No	False	False	Auto/Yes	False	Enabled
13	AUTO/200000	2/2	False/No	False	False	Auto/Yes	False	Enabled
14	AUTO/200000	2/2	False/No	False	False	Auto/Yes	False	Enabled
15	AUTO/200000	2/2	False/No	False	False	Auto/Yes	False	Enabled
16	AUTO/200000	2/2	False/No	False	False	Auto/Yes	False	Enabled
17	AUTO/200000	2/2	False/No	False	False	Auto/Yes	False	Enabled
18	AUTO/200000	2/2	False/No	False	False	Auto/Yes	False	Enabled
19	AUTO/200000	2/2	False/No	False	False	Auto/Yes	False	Enabled
20	AUTO/200000	2/2	False/No	False	False	Auto/Yes	False	Enabled
21	AUTO/200000	2/2	False/No	False	False	Auto/Yes	False	Enabled
22	AUTO/200000	2/2	False/No	False	False	Auto/Yes	False	Enabled
23	AUTO/200000	2/2	False/No	False	False	Auto/Yes	False	Enabled
24	AUTO/200000	2/2	False/No	False	False	Auto/Yes	False	Enabled
25	AUTO/200000	2/2	False/No	False	False	Auto/Yes	False	Enabled
26	AUTO/200000	2/2	False/No	False	False	Auto/Yes	False	Enabled

Figure 6- 34. STP Port Settings window

In addition to setting Spanning Tree parameters for use on the switch level, the Switch allows for the configuration of groups of ports, each port-group of which will have its own spanning tree, and will require some of its own configuration settings. An STP Group will use the switch-level parameters entered above, with the addition of Port Priority and Port Cost.

An STP Group spanning tree works in the same way as the switch-level spanning tree, but the root bridge concept is replaced with a root port concept. A root port is a port of the group that is elected based on port priority and port cost, to be the connection to the network for the group. Redundant links will be blocked, just as redundant links are blocked on the switch level.

The STP on the switch level blocks redundant links between switches (and similar network devices). The port level STP will block redundant links within an STP Group.

It is advisable to define an STP Group to correspond to a VLAN group of ports.



NOTE: If you want to enable Forwarding BPDU on a per port basis, the following settings must first be in effect: 1. STP must be globally disabled and 2. Forwarding BPDU must be globally enabled. These are the default settings configurable in the **STP Bridge Global Settings** menu discussed previously.

The following STP Port Settings fields can be set:

Parameter	Description
From/To	A consecutive group of ports may be configured starting with the selected port.
External Cost	This defines a metric that indicates the relative cost of forwarding packets to the specified port list. Port cost can be set automatically or as a metric value. The default value is 0 (auto). 0 (auto) - Setting 0 for the external cost will automatically set the speed for forwarding packets to the specified port(s) in the list for optimal efficiency. Default port cost: 100Mbps port = 200000. Gigabit port = 20000. value 1-200000000 - Define a value between 1 and 200000000 to determine the external cost. The lower the number, the greater the probability the port will be chosen to forward packets.
Hello Time	The time interval between transmissions of configuration messages by the designated port, to other devices on the bridged LAN. The user may choose a time between 1 and 2 seconds. The default is 2 seconds. This field is only operable when the Switch is enabled for MSTP.
Migration	Setting this parameter as "yes" will set the ports to send out BPDU packets to other bridges, requesting information on their STP setting. If the Switch is configured for RSTP, the port will be capable to migrate from 802.1d STP to 802.1w RSTP. If the Switch is configured for MSTP, the port is capable of migrating from 802.1d STP to 802.1s MSTP. RSTP and MSTP can coexist with standard STP, however the benefits of RSTP and MSTP are not realized on a port where an 802.1d network connects to an 802.1w or 802.1s enabled network. Migration should be set as yes on ports connected to network stations or segments that are capable of being upgraded to 802.1w RSTP or 802.1s MSTP on all or some portion of the segment.
Edge	Choosing the <i>True</i> parameter designates the port as an edge port. Edge ports cannot create loops, however an edge port can lose edge port status if a topology change creates a potential for a loop. An edge port normally should not receive BPDU packets. If a BPDU packet is received, it automatically loses edge port status. Choosing the <i>False</i> parameter indicates that the port does not have edge port status.
Restricted Role	A Boolean value set by management. Two options are available for this parameter: True and False. If TRUE causes the Port not to be selected as Root Port for the CIST or any MSTI, even it has the best spanning tree priority vector. Such a Port will be selected as an Alternate Port after the Root Port has been selected. This parameter should be FALSE by default. If set, it can cause lack of spanning tree connectivity. It is set by a network administrator to prevent bridges external to a core region of the network influencing the spanning tree active topology, possibly because those bridges are not under the full control of the administrator.
Restricted Tcn	A Boolean value set by management. Two options are available for this parameter: True and False. If TRUE causes the Port not to propagate received topology change notifications and topology changes to other Ports. This parameter should be FALSE by default. If set it can cause temporary loss of connectivity after changes in a spanning trees active topology as a result of persistent incorrectly learned station location information. It is set by a network administrator to prevent bridges external to a core region of the network, causing address flushing in that region, possibly because those bridges are not under the full control of the administrator or MAC_Operational for the attached LANs transitions frequently.
P2P	Choosing the <i>True</i> parameter indicates a point-to-point (P2P) shared link. P2P ports are similar to edge ports, however they are restricted in that a P2P port must operate in full duplex. Like edge ports, P2P ports transition to a forwarding state rapidly thus benefiting from RSTP. A p2p value of <i>False</i> indicates that the port cannot have p2p status. <i>Auto</i> allows the port to have p2p status whenever possible and operate as if the p2p status were true. If the port cannot maintain this status, (for example if the port is forced to half-duplex operation) the p2p status changes to operate as if the p2p value were <i>false</i> . The default setting for this parameter is <i>auto</i> .
Forward BPDU	Choosing True will allow the forwarding of BPDU packets in the specified ports from other network devices. This will go into effect only if STP is globally disabled AND Forwarding BPDU

	is globally enabled (See STP Bridge Global Settings above). The default setting False, does not forward BPDU packets when STP is disabled.
State	This drop-down menu allows you to enable or disable STP for the selected group of ports. The default is <i>Enabled</i> .

Click **Apply** to implement changes made.

Loopback Detection

This feature is used to temporarily shutdown a port on the Switch when a CTP (Configuration Testing Protocol) packet has been looped back to the switch. When the Switch detects CTP packets are received from a port or a VLAN, it signifies a loop on the network. The Switch will automatically block the port or the VLAN and send an alert to the administrator. The Loopback Detection port will restart (change to discarding state) when the Loopback Detection **Recover Time** times out. The Loopback Detection function can be implemented on a range of ports at a time. The user may enable or disable this function using the pull-down menu.

Loopback Detection Global Settings

Loopdetect Status	Disabled ▾
Interval (1-32767)	10
Recover Time (0 or 60-1000000)	60
Mode	Port_based ▾

Loopback Detection Status Settings

From	To	State	
Port 1 ▾	Port 1 ▾	Disable ▾	<input type="button" value="Apply"/>

Loopback Detection Port_based Table

Port	Loopdetect State	Loop Status
1	Disable	Normal
2	Disable	Normal
3	Disable	Normal
4	Disable	Normal
5	Disable	Normal
6	Disable	Normal
7	Disable	Normal
8	Disable	Normal
9	Disable	Normal
10	Disable	Normal
11	Disable	Normal
12	Disable	Normal
13	Disable	Normal
14	Disable	Normal
15	Disable	Normal
16	Disable	Normal
17	Disable	Normal
18	Disable	Normal
19	Disable	Normal
20	Disable	Normal
21	Disable	Normal
22	Disable	Normal
23	Disable	Normal
24	Disable	Normal
25	Disable	Normal
26	Disable	Normal

Figure 6- 35 Loopback Detection Global Settings window

Parameter	Description
Loopback Detection Global Settings	
Loopback Detection Status	Use the pull-down menu to enable or disable Loopback Detection globally on the Switch. The default is <i>Disabled</i> .
Interval (1-32767)	Use the pull-down menu to set up the time interval (inseconds) at which the remote device transmits all the CTP packets to detect the loop-back event. The default value is 10, with a valid range of 1 to 32767,
Recover Time (0 or 60 – 1000000)	The time interval (in seconds) used by the Auto-Recovery mechanism to decide how long to check if the loop status is gone. The valid range is 60 to 1000000. Zero is a special value, which means to disable the auto-recovery mechanism. The default value is 60.
Mode	Two modes are available: <i>Port_based</i> , <i>VLAN_based</i> . In port-based mode, the port will be disabled during the loop detection. In vlan-based mode, the port cannot process VLAN packets destined for ports involved in detecting the loop.
Loopback Detection Status Settings	
From/To	A consecutive group of ports may be configured starting with the selected port.
State	Use the pull-down menu to enable or disable Loopback Detection on consecutive group of ports of the Switch. The default is <i>Disabled</i> .

Click **Apply** to implement changes made.

Forwarding Filtering

Unicast Forwarding

Open the **Forwarding Filtering** folder in the **Configuration** menu and click on the **Unicast Forwarding** link. This will open the Setup Static Unicast Forwarding Table, as shown below:

Figure 6- 36. Setup Static Unicast Forwarding Table window

To add or edit an entry, define the following parameters and then click **Add/Modify**:

Parameter	Description
VLAN ID (VID)	The VLAN ID number of the VLAN on which the above Unicast MAC address resides.
MAC Address	The MAC address to which packets will be statically forwarded. This must be a unicast MAC address.
Allowed to Go Port	Allows the selection of the port number on which the MAC address entered above resides.

Click **Apply** to implement the changes made. To delete an entry in the Static Unicast Forwarding Table, click the corresponding **X** under the Delete heading.

Multicast Forwarding

The following figure and table describe how to set up **Multicast Forwarding** on the Switch. Open the **Forwarding Filtering** folder and click on the **Multicast Forwarding** link to see the entry screen below:

Figure 6- 37. Static Multicast Forwarding Settings window

The **Static Multicast Forwarding Settings** window displays all of the entries made into the Switch's static multicast forwarding table. Click the **Add** button to open the **Setup Static Multicast Forwarding Table** window, as shown below:

Figure 6- 38. Setup Static Multicast Forwarding Table window

The following parameters can be set:

Parameter	Description
VID	The VLAN ID of the VLAN to which the corresponding MAC address belongs.
Multicast MAC Address	The MAC address of the static source of multicast packets. This must be a multicast MAC address.
Port Settings	Allows the selection of ports that will be members of the static multicast group and ports either that are forbidden from joining dynamically, or that can join the multicast group dynamically, using GMRP. The options are: <i>None</i> - No restrictions on the port dynamically joining the multicast group. When None is chosen, the port will not be a member of the Static Multicast Group. <i>Egress</i> - The port is a static member of the multicast group.

Click **Apply** to implement the changes made. To delete an entry in the Static Multicast Forwarding Table, click the corresponding **X** under the Delete heading. Click the **Show All Multicast Forwarding Entries** link to return to the **Static Multicast Forwarding Settings** window.

Multicast Port Filtering Mode

The following figure and table describe how to set up multicast forwarding on the Switch. Open the **Forwarding Filtering** folder and click on the **Multicast Port Filtering Mode Setup** link to see the entry window below:

Multicast Port Filtering Mode Setup			
From	To	Mode	Apply
Port 1	Port 1	Forward All Groups	Apply
Multicast Port Filtering Mode Table			
Port	Mode		
1	Forward Unregistered Groups		
2	Forward Unregistered Groups		
3	Forward Unregistered Groups		
4	Forward Unregistered Groups		
5	Forward Unregistered Groups		
6	Forward Unregistered Groups		
7	Forward Unregistered Groups		
8	Forward Unregistered Groups		
9	Forward Unregistered Groups		
10	Forward Unregistered Groups		
11	Forward Unregistered Groups		
12	Forward Unregistered Groups		
13	Forward Unregistered Groups		
14	Forward Unregistered Groups		
15	Forward Unregistered Groups		
16	Forward Unregistered Groups		
17	Forward Unregistered Groups		
18	Forward Unregistered Groups		
19	Forward Unregistered Groups		
20	Forward Unregistered Groups		
21	Forward Unregistered Groups		
22	Forward Unregistered Groups		
23	Forward Unregistered Groups		
24	Forward Unregistered Groups		
25	Forward Unregistered Groups		
26	Forward Unregistered Groups		

Figure 6- 39. Multicast Port Filtering Mode Setup window

The following parameters can be set:

Parameter	Description
From/To	These two drop-down menus allow you to select a range of ports to which the filter settings will be applied.
Mode	<p>This drop-down menu allows you to select the action the Switch will take when it receives a multicast packet that is to be forwarded to one of the ports in the range specified above.</p> <ul style="list-style-type: none"> <i>Forward All Groups</i> - This will instruct the Switch to forward a multicast packet to all multicast groups residing within the range of ports specified above. <i>Forward Unregistered Groups</i> - This will instruct the Switch to forward a multicast packet whose destination is an unregistered multicast group residing within the range of ports specified above. <i>Filter Unregistered Groups</i> - This will instruct the Switch to filter any multicast packets whose destination is an unregistered multicast group residing within the range of ports specified above.

Click **Apply** to implement changes made.

VLANs

Understanding IEEE 802.1p Priority

Priority tagging is a function defined by the IEEE 802.1p standard designed to provide a means of managing traffic on a network where many different types of data may be transmitted simultaneously. It is intended to alleviate problems associated with the delivery of time critical data over congested networks. The quality of applications that are dependent on such time critical data, such as video conferencing, can be severely and adversely affected by even very small delays in transmission.

Network devices that are in compliance with the IEEE 802.1p standard have the ability to recognize the priority level of data packets. These devices can also assign a priority label or tag to packets. Compliant devices can also strip priority tags from packets. This priority tag determines the packet's degree of expeditiousness and determines the queue to which it will be assigned.

Priority tags are given values from 0 to 7 with 0 being assigned to the lowest priority data and 7 assigned to the highest. The highest priority tag 7 is generally only used for data associated with video or audio applications, which are sensitive to even slight delays, or for data from specified end users whose data transmissions warrant special consideration.

The Switch allows you to further tailor how priority tagged data packets are handled on your network. Using queues to manage priority tagged data allows you to specify its relative priority to suit the needs of your network. There may be circumstances where it would be advantageous to group two or more differently tagged packets into the same queue. Generally, however, it is recommended that the highest priority queue, Queue 1, be reserved for data packets with a priority value of 7. Packets that have not been given any priority value are placed in Queue 0 and thus given the lowest priority for delivery.

A weighted round robin system is employed on the Switch to determine the rate at which the queues are emptied of packets. The ratio used for clearing the queues is 4:1. This means that the highest priority queue, Queue 1, will clear 4 packets for every 1 packet cleared from Queue 0.

Remember, the priority queue settings on the Switch are for all ports, and all devices connected to the Switch will be affected. This priority queuing system will be especially beneficial if your network employs switches with the capability of assigning priority tags.

VLAN Description

A Virtual Local Area Network (VLAN) is a network topology configured according to a logical scheme rather than the physical layout. VLANs can be used to combine any collection of LAN segments into an autonomous user group that appears as a single LAN. VLANs also logically segment the network into different broadcast domains so that packets are forwarded only between ports within the VLAN. Typically, a VLAN corresponds to a particular subnet, although not necessarily.

VLANs can enhance performance by conserving bandwidth, and improve security by limiting traffic to specific domains.

A VLAN is a collection of end nodes grouped by logic instead of physical location. End nodes that frequently communicate with each other are assigned to the same VLAN, regardless of where they are physically on the network. Logically, a VLAN can be equated to a broadcast domain, because broadcast packets are forwarded to only members of the VLAN on which the broadcast was initiated.

Notes about VLANs on the xStack DES-3500 Series switches

No matter what basis is used to uniquely identify end nodes and assign these nodes VLAN membership, packets cannot cross VLANs without a network device performing a routing function between the VLANs.

The DES-3500 Series switches supports IEEE 802.1Q VLANs and Port-Based VLANs. The port untagging function can be used to remove the 802.1Q tag from packet headers to maintain compatibility with devices that are tag-unaware.

The Switch's default is to assign all ports to a single 802.1Q VLAN named "default."

The "default" VLAN has a VID = 1.

The member ports of Port-based VLANs may overlap, if desired.

IEEE 802.1Q VLANs

Some relevant terms:

- **Tagging** - The act of putting 802.1Q VLAN information into the header of a packet.
- **Untagging** - The act of stripping 802.1Q VLAN information out of the packet header.
- **Ingress port** - A port on a switch where packets are flowing into the Switch and VLAN decisions must be made.
- **Egress port** - A port on a switch where packets are flowing out of the Switch, either to another switch or to an end station, and tagging decisions must be made.

IEEE 802.1Q (tagged) VLANs are implemented on the Switch. 802.1Q VLANs require tagging, which enables them to span the entire network (assuming all switches on the network are IEEE 802.1Q-compliant).

VLANs allow a network to be segmented in order to reduce the size of broadcast domains. All packets entering a VLAN will only be forwarded to the stations (over IEEE 802.1Q enabled switches) that are members of that VLAN, and this includes broadcast, multicast and unicast packets from unknown sources.

VLANs can also provide a level of security to your network. IEEE 802.1Q VLANs will only deliver packets between stations that are members of the VLAN.

Any port can be configured as either tagging or untagging. The untagging feature of IEEE 802.1Q VLANs allows VLANs to work with legacy switches that don't recognize VLAN tags in packet headers. The tagging feature allows VLANs to span multiple 802.1Q-compliant switches through a single physical connection and allows Spanning Tree to be enabled on all ports and work normally.

The IEEE 802.1Q standard restricts the forwarding of untagged packets to the VLAN the receiving port is a member of.

The main characteristics of IEEE 802.1Q are as follows:

- Assigns packets to VLANs by filtering.
- Assumes the presence of a single global spanning tree.
- Uses an explicit tagging scheme with one-level tagging.
- 802.1Q VLAN Packet Forwarding
- Packet forwarding decisions are made based upon the following three types of rules:
- Ingress rules - rules relevant to the classification of received frames belonging to a VLAN.
- Forwarding rules between ports - decides whether to filter or forward the packet.
- Egress rules - determines if the packet must be sent tagged or untagged.

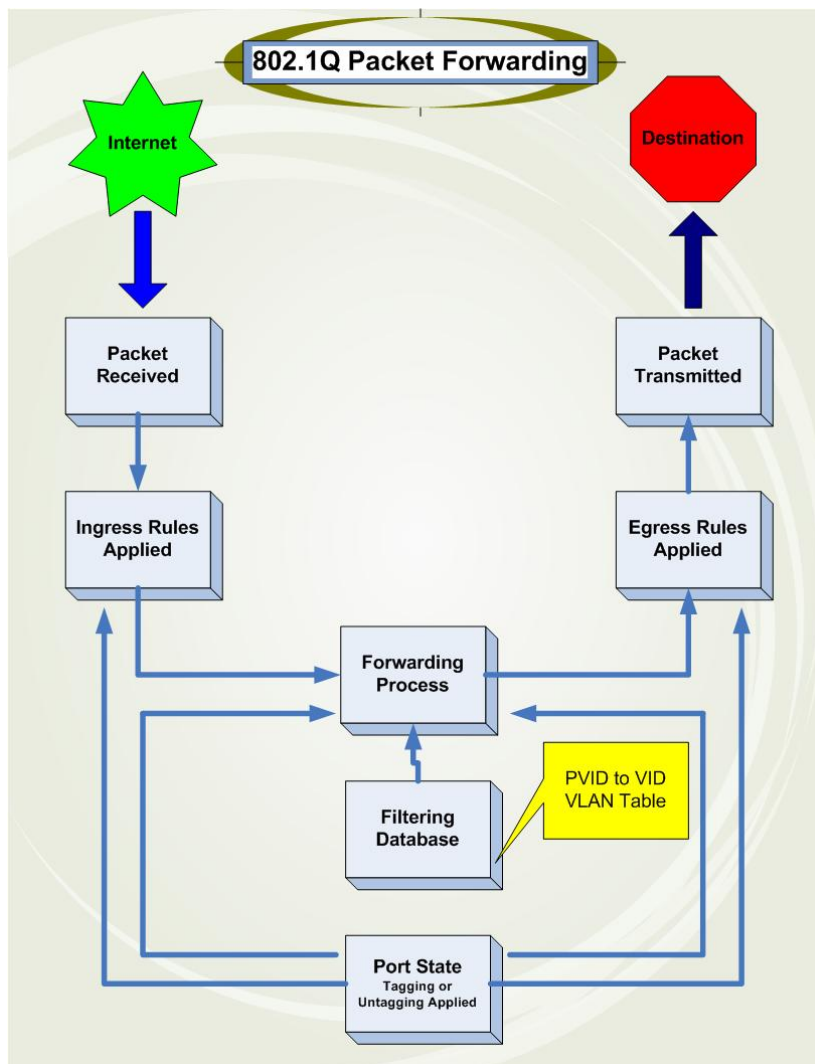

Figure 6- 40. IEEE 802.1Q Packet Forwarding

802.1Q VLAN Tags

The figure below shows the 802.1Q VLAN tag. There are four additional octets inserted after the source MAC address. Their presence is indicated by a value of 0x8100 in the EtherType field. When a packet's EtherType field is equal to 0x8100, the packet carries the IEEE 802.1Q/802.1p tag. The tag is contained in the following two octets and consists of 3 bits of user priority, 1 bit of Canonical Format Identifier (CFI - used for encapsulating Token Ring packets so they can be carried across Ethernet backbones), and 12 bits of VLAN ID (VID). The 3 bits of user priority are used by 802.1p. The VID is the VLAN identifier and is used by the 802.1Q standard. Because the VID is 12 bits long, 4094 unique VLANs can be identified.

The tag is inserted into the packet header making the entire packet longer by 4 octets. All of the information originally contained in the packet is retained.

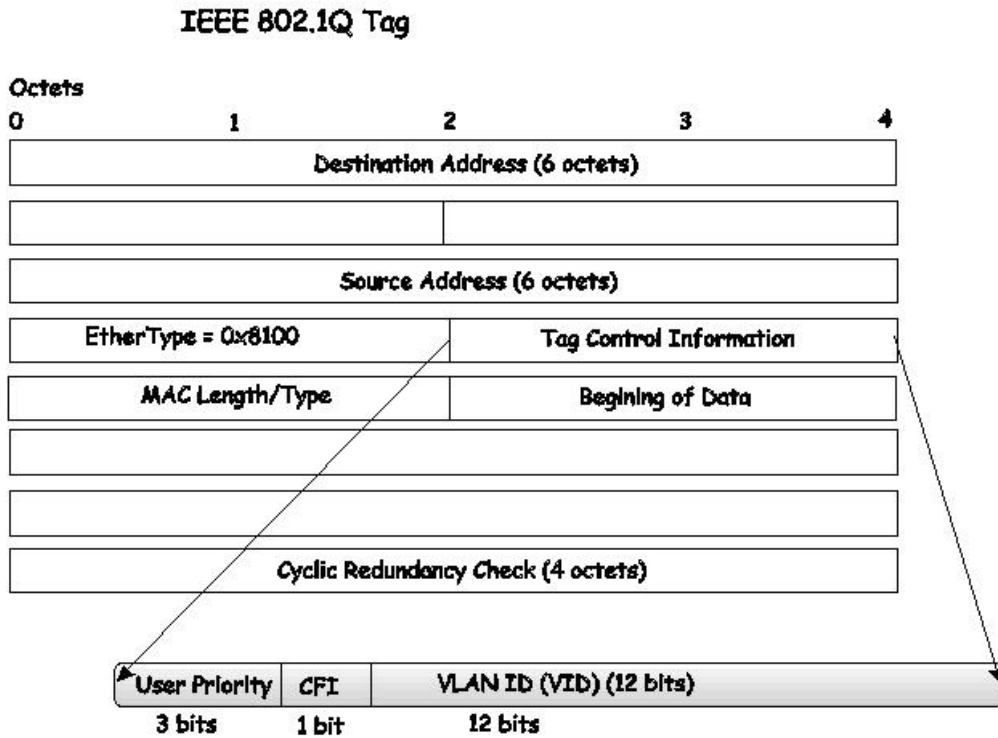

Figure 6- 41. IEEE 802.1Q Tag

The EtherType and VLAN ID are inserted after the MAC source address, but before the original EtherType/Length or Logical Link Control. Because the packet is now a bit longer than it was originally, the Cyclic Redundancy Check (CRC) must be recalculated.

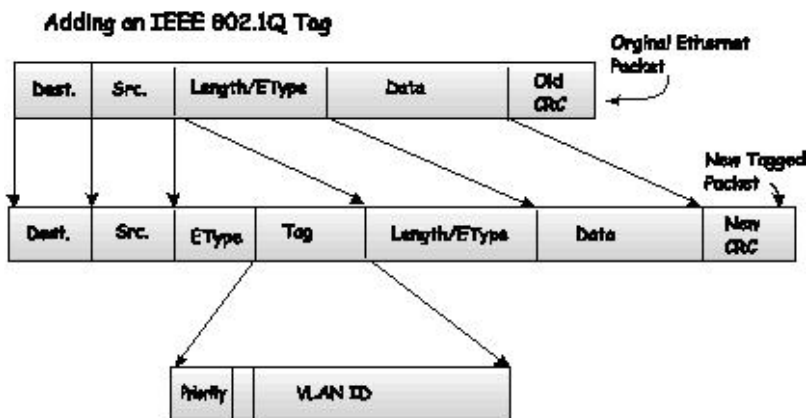

Figure 6- 42. Adding an IEEE 802.1Q Tag

Port VLAN ID

Packets that are tagged (are carrying the 802.1Q VID information) can be transmitted from one 802.1Q compliant network device to another with the VLAN information intact. This allows 802.1Q VLANs to span network devices (and indeed, the entire network, if all network devices are 802.1Q compliant).

Unfortunately, not all network devices are 802.1Q compliant. These devices are referred to as tag-unaware. 802.1Q devices are referred to as tag-aware.

Prior to the adoption of 802.1Q VLANs, port-based and MAC-based VLANs were in common use. These VLANs relied upon a Port VLAN ID (PVID) to forward packets. A packet received on a given port would be assigned that port's PVID and then be forwarded to the port that corresponded to the packet's destination address (found in the Switch's forwarding table). If the PVID of the port that received the packet is different from the PVID of the port that is to transmit the packet, the Switch will drop the packet.

Within the Switch, different PVIDs mean different VLANs (remember that two VLANs cannot communicate without an external router). So, VLAN identification based upon the PVIDs cannot create VLANs that extend outside a given switch (or switch stack).

Every physical port on a switch has a PVID. 802.1Q ports are also assigned a PVID, for use within the Switch. If no VLANs are defined on the Switch, all ports are then assigned to a default VLAN with a PVID equal to 1. Untagged packets are assigned the PVID of the port on which they were received. Forwarding decisions are based upon this PVID, in so far as VLANs are concerned. Tagged packets are forwarded according to the VID contained within the tag. Tagged packets are also assigned a PVID, but the PVID is not used to make packet-forwarding decisions, the VID is.

Tag-aware switches must keep a table to relate PVIDs within the Switch to VIDs on the network. The Switch will compare the VID of a packet to be transmitted to the VID of the port that is to transmit the packet. If the two VIDs are different, the Switch will drop the packet. Because of the existence of the PVID for untagged packets and the VID for tagged packets, tag-aware and tag-unaware network devices can coexist on the same network.

A switch port can have only one PVID, but can have as many VIDs as the Switch has memory in its VLAN table to store them.

Because some devices on a network may be tag-unaware, a decision must be made at each port on a tag-aware device before packets are transmitted - should the packet to be transmitted have a tag or not? If the transmitting port is connected to a tag-unaware device, the packet should be untagged. If the transmitting port is connected to a tag-aware device, the packet should be tagged.

Tagging and Untagging

Every port on an 802.1Q compliant switch can be configured as tagging or untagging.

Ports with tagging enabled will put the VID number, priority and other VLAN information into the header of all packets that flow into and out of it. If a packet has previously been tagged, the port will not alter the packet, thus keeping the VLAN information intact. Other 802.1Q compliant devices on the network to make packet-forwarding decisions can then use the VLAN information in the tag.

Ports with untagging enabled will strip the 802.1Q tag from all packets that flow into and out of those ports. If the packet doesn't have an 802.1Q VLAN tag, the port will not alter the packet. Thus, all packets received by and forwarded by an untagging port will have no 802.1Q VLAN information. (Remember that the PVID is only used internally within the Switch). Untagging is used to send packets from an 802.1Q-compliant network device to a non-compliant network device.

Ingress Filtering

A port on a switch where packets are flowing into the Switch and VLAN decisions must be made is referred to as an ingress port. If ingress filtering is enabled for a port, the Switch will examine the VLAN information in the packet header (if present) and decide whether or not to forward the packet.

If the packet is tagged with VLAN information, the ingress port will first determine if the ingress port itself is a member of the tagged VLAN. If it is not, the packet will be dropped. If the ingress port is a member of the 802.1Q VLAN, the Switch then determines if the destination port is a member of the 802.1Q VLAN. If it is not, the packet is dropped. If the destination port is a member of the 802.1Q VLAN, the packet is forwarded and the destination port transmits it to its attached network segment.

If the packet is not tagged with VLAN information, the ingress port will tag the packet with its own PVID as a VID (if the port is a tagging port). The switch then determines if the destination port is a member of the same VLAN (has the same VID) as the ingress port. If it does not, the packet is dropped. If it has the same VID, the packet is forwarded and the destination port transmits it on its attached network segment.

This process is referred to as ingress filtering and is used to conserve bandwidth within the Switch by dropping packets that are not on the same VLAN as the ingress port at the point of reception. This eliminates the subsequent processing of packets that will just be dropped by the destination port.

Default VLANs

The Switch initially configures one VLAN, VID = 1, called "default." The factory default setting assigns all ports on the Switch to the "default." As new VLANs are configured in Port-based mode, their respective member ports are removed from the "default."

Packets cannot cross VLANs. If a member of one VLAN wants to connect to another VLAN, the link must be through an external router.



NOTE: If no VLANs are configured on the Switch, then all packets will be forwarded to any destination port. Packets with unknown source addresses will be flooded to all ports. Broadcast and multicast packets will also be flooded to all ports.

An example is presented below:

VLAN Name	VID	Switch Ports
System (default)	1	5, 6, 7, 8, 21, 22, 23, 24
Engineering	2	9, 10, 11, 12
Marketing	3	13, 14, 15, 16
Finance	4	17, 18, 19, 20
Sales	5	1, 2, 3, 4

Table 6- 2. VLAN Example - Assigned Ports

Port-based VLANs

Port-based VLANs limit traffic that flows into and out of switch ports. Thus, all devices connected to a port are members of the VLAN(s) the port belongs to, whether there is a single computer directly connected to a switch, or an entire department.

On port-based VLANs, NICs do not need to be able to identify 802.1Q tags in packet headers. NICs send and receive normal Ethernet packets. If the packet's destination lies on the same segment, communications take place using normal Ethernet protocols. Even though this is always the case, when the destination for a packet lies on another switch port, VLAN considerations come into play to decide if the packet gets dropped by the Switch or delivered.

VLAN Segmentation

Take for example a packet that is transmitted by a machine on Port 1 that is a member of VLAN 2. If the destination lies on another port (found through a normal forwarding table lookup), the Switch then looks to see if the other port (Port 10) is a member of VLAN 2 (and can therefore receive VLAN 2 packets). If Port 10 is not a member of VLAN 2, then the packet will be dropped by the Switch and will not reach its destination. If Port 10 is a member of VLAN 2, the packet will go through. This selective forwarding feature based on VLAN criteria is how VLANs segment networks. The key point being that Port 1 will only transmit on VLAN 2.

Asymmetric VLANs

The xStack DES-3500 Switch Series has the capability to create and utilize Asymmetric VLANs on the Switch. Asymmetric VLANs allow devices to transmit packets on one VLAN and receive it on another VLAN. This configuration is accomplished through the use of three functions: enabling Asymmetric VLANs, VLAN creation, and GVRP configuration. Consider the example below.

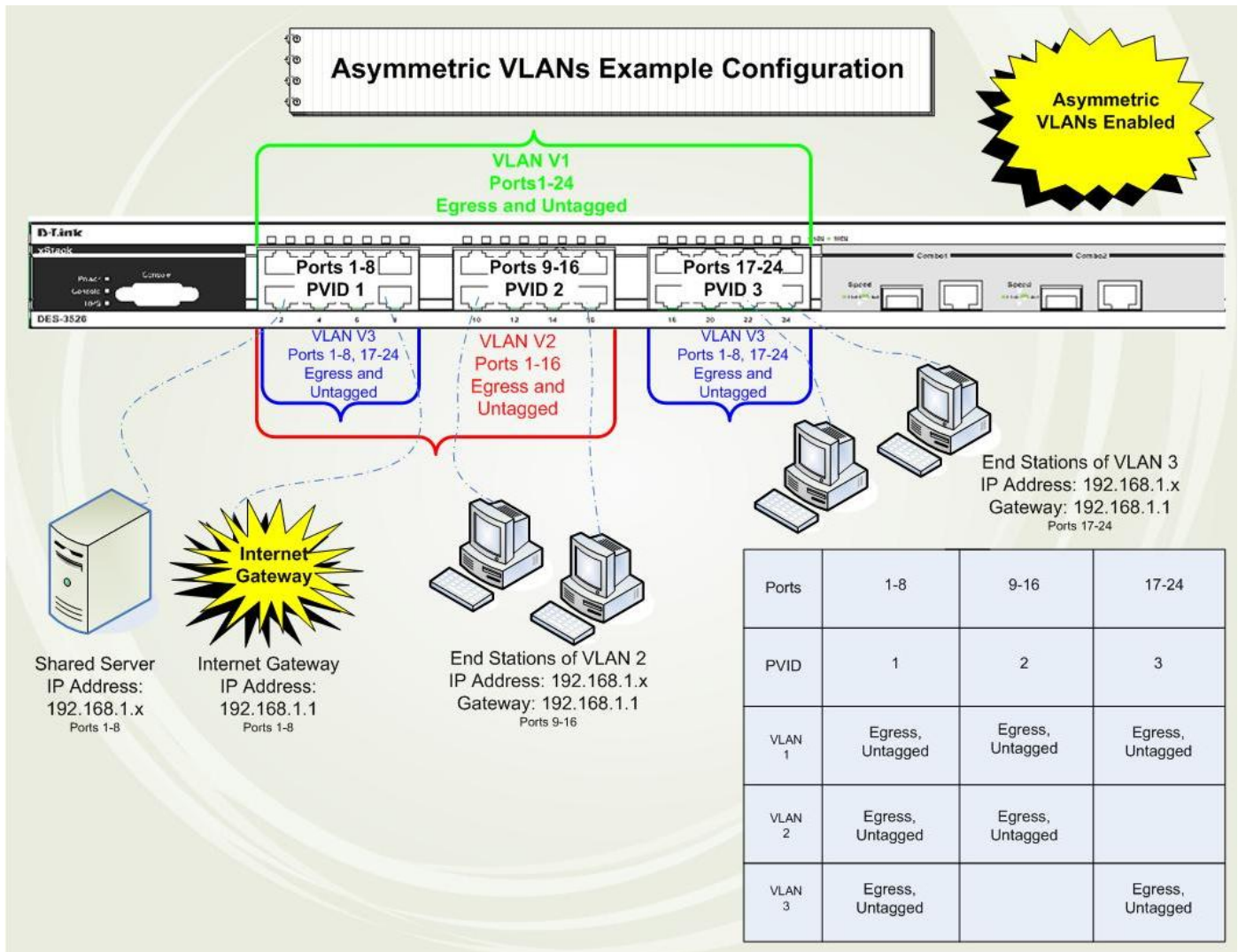

Figure 6- 43. Asymmetric VLANs Example

In order to accomplish an Asymmetric VLAN configuration, the user must do a three part configuration:

1. Enable Asymmetric VLANs using the Advanced Settings window located in the Configuration folder. Overlapping VLANs cannot be configured unless this function is enabled.
2. Configure the VLAN settings. The example above uses ports 1-8 to hold the devices to be shared on the network, such as shared servers and shared printers. Therefore, this group of ports is to be included for all VLANs. VLAN V2 is then configured to include ports 1-8 (shared VLAN ports) and the set of ports to be separated from the other subsetted VLANs (ports 9-16). VLAN V3 is then configured to include ports 1-8 (shared ports) and the set of ports to be separated from the other subsetted VLANs (17-24). Therefore we have two VLANs who both share ports and have ports that are separated from each other and thus cannot communicate with each other.
3. Configure the PVID settings for the Switch through the GVRP function located in the VLANs folder. The user is to set the shared set of ports as PVID 1, the other separated groups of ports as PVID 2 and PVID 3.

After completing the previous configuration, the user is now able to share the network resources set on the shared group of ports (nominated as PVID 1), with both smaller subsets of VLANs (nominated PVID 2 and PVID 3). Yet, VLAN V1 and VLAN V2 are incapable of sharing information with each other and the Overlapping VLAN configuration has been successfully created.

VLAN and Trunk Groups

The members of a trunk group have the same VLAN setting. Any VLAN setting on the members of a trunk group will apply to the other member ports.



NOTE: In order to use VLAN segmentation in conjunction with port trunk groups, you can first set the port trunk group(s), and then you may configure VLAN settings. If you wish to change the port trunk grouping with VLANs already in place, you will not need to reconfigure the VLAN settings after changing the port trunk group settings. VLAN settings will automatically change in conjunction with the change of the port trunk group settings.

Static VLAN Entry

In the **Configuration** folder, open the **VLAN** folder and click the **Static VLAN Entry** link to open the following window:

802.1Q Static VLANs			
Add new 802.1Q VLAN			Add
Current 802.1Q Static VLANs Entries			
VLAN ID	VLAN name	Modify	Delete
1	default	Modify	X
4094	Trinity	Modify	X

Figure 6- 44. Current 802.1Q Static VLANs Entries window

The **802.1Q Static VLANs** window lists all previously configured VLANs by VLAN ID and VLAN Name. To delete an existing 802.1Q VLAN, click the corresponding X button under the Delete heading.

To create a new 802.1Q VLAN, click the **Add** button in the **802.1Q Static VLANs** window. A new window will appear, as shown below, to configure the port settings and to assign a unique name and number to the new VLAN. See the table below for a description of the parameters in the new window.

802.1Q Static VLAN													
VID	VLAN Name												Advertisement
<input type="text"/>	<input type="text"/>												Disabled
Port Settings	1	2	3	4	5	6	7	8	9	10	11	12	13
Tag	<input checked="" type="checkbox"/>	<input checked="" type="checkbox"/>	<input checked="" type="checkbox"/>	<input checked="" type="checkbox"/>	<input checked="" type="checkbox"/>	<input checked="" type="checkbox"/>	<input checked="" type="checkbox"/>	<input checked="" type="checkbox"/>	<input checked="" type="checkbox"/>	<input checked="" type="checkbox"/>	<input checked="" type="checkbox"/>	<input checked="" type="checkbox"/>	<input checked="" type="checkbox"/>
None	<input type="radio"/>	<input type="radio"/>	<input type="radio"/>	<input type="radio"/>	<input type="radio"/>	<input type="radio"/>	<input type="radio"/>	<input type="radio"/>	<input type="radio"/>	<input type="radio"/>	<input type="radio"/>	<input type="radio"/>	<input type="radio"/>
Egress	<input type="radio"/>	<input type="radio"/>	<input type="radio"/>	<input type="radio"/>	<input type="radio"/>	<input type="radio"/>	<input type="radio"/>	<input type="radio"/>	<input type="radio"/>	<input type="radio"/>	<input type="radio"/>	<input type="radio"/>	<input type="radio"/>
Forbidden	<input type="radio"/>	<input type="radio"/>	<input type="radio"/>	<input type="radio"/>	<input type="radio"/>	<input type="radio"/>	<input type="radio"/>	<input type="radio"/>	<input type="radio"/>	<input type="radio"/>	<input type="radio"/>	<input type="radio"/>	<input type="radio"/>
Port Settings	14	15	16	17	18	19	20	21	22	23	24	25	26
Tag	<input checked="" type="checkbox"/>	<input checked="" type="checkbox"/>	<input checked="" type="checkbox"/>	<input checked="" type="checkbox"/>	<input checked="" type="checkbox"/>	<input checked="" type="checkbox"/>	<input checked="" type="checkbox"/>	<input checked="" type="checkbox"/>	<input checked="" type="checkbox"/>	<input checked="" type="checkbox"/>	<input checked="" type="checkbox"/>	<input checked="" type="checkbox"/>	<input checked="" type="checkbox"/>
None	<input type="radio"/>	<input type="radio"/>	<input type="radio"/>	<input type="radio"/>	<input type="radio"/>	<input type="radio"/>	<input type="radio"/>	<input type="radio"/>	<input type="radio"/>	<input type="radio"/>	<input type="radio"/>	<input type="radio"/>	<input type="radio"/>
Egress	<input type="radio"/>	<input type="radio"/>	<input type="radio"/>	<input type="radio"/>	<input type="radio"/>	<input type="radio"/>	<input type="radio"/>	<input type="radio"/>	<input type="radio"/>	<input type="radio"/>	<input type="radio"/>	<input type="radio"/>	<input type="radio"/>
Forbidden	<input type="radio"/>	<input type="radio"/>	<input type="radio"/>	<input type="radio"/>	<input type="radio"/>	<input type="radio"/>	<input type="radio"/>	<input type="radio"/>	<input type="radio"/>	<input type="radio"/>	<input type="radio"/>	<input type="radio"/>	<input type="radio"/>
Apply													
Show All Static VLAN Entries													

Figure 6- 45. 802.1Q Static VLAN window - Add

To return to the **Current 802.1Q Static VLANs Entries** window, click the [Show All Static VLAN Entries](#) link. To change an existing 802.1Q VLAN entry, click the **Modify** button of the corresponding entry you wish to modify. A new menu will appear to configure the port settings and to assign a unique name and number to the new VLAN. See the table below for a description of the parameters in the new menu.



NOTE: The Switch supports up to 255 static VLAN entries.

802.1Q Static VLAN																										
VID		VLAN Name															Advertisement									
1		default															Enabled									
Port Settings	1	2	3	4	5	6	7	8	9	10	11	12	13	14	15	16	17	18	19	20	21	22	23	24	25	
Tag	<input type="checkbox"/>	<input type="checkbox"/>	<input type="checkbox"/>	<input type="checkbox"/>	<input type="checkbox"/>	<input type="checkbox"/>	<input type="checkbox"/>	<input type="checkbox"/>	<input type="checkbox"/>	<input type="checkbox"/>	<input type="checkbox"/>	<input type="checkbox"/>	<input type="checkbox"/>	<input type="checkbox"/>	<input type="checkbox"/>	<input type="checkbox"/>	<input type="checkbox"/>	<input type="checkbox"/>	<input type="checkbox"/>	<input type="checkbox"/>	<input type="checkbox"/>	<input type="checkbox"/>	<input type="checkbox"/>	<input type="checkbox"/>	<input type="checkbox"/>	<input type="checkbox"/>
None	<input type="radio"/>	<input type="radio"/>	<input type="radio"/>	<input type="radio"/>	<input type="radio"/>	<input type="radio"/>	<input type="radio"/>	<input type="radio"/>	<input type="radio"/>	<input type="radio"/>	<input type="radio"/>	<input type="radio"/>	<input type="radio"/>	<input type="radio"/>	<input type="radio"/>	<input type="radio"/>	<input type="radio"/>	<input type="radio"/>	<input type="radio"/>	<input type="radio"/>	<input type="radio"/>	<input type="radio"/>	<input type="radio"/>	<input type="radio"/>	<input type="radio"/>	<input type="radio"/>
Egress	<input type="radio"/>	<input type="radio"/>	<input type="radio"/>	<input type="radio"/>	<input type="radio"/>	<input type="radio"/>	<input type="radio"/>	<input type="radio"/>	<input type="radio"/>	<input type="radio"/>	<input type="radio"/>	<input type="radio"/>	<input type="radio"/>	<input type="radio"/>	<input type="radio"/>	<input type="radio"/>	<input type="radio"/>	<input type="radio"/>	<input type="radio"/>	<input type="radio"/>	<input type="radio"/>	<input type="radio"/>	<input type="radio"/>	<input type="radio"/>	<input type="radio"/>	<input type="radio"/>
Forbidden	<input type="radio"/>	<input type="radio"/>	<input type="radio"/>	<input type="radio"/>	<input type="radio"/>	<input type="radio"/>	<input type="radio"/>	<input type="radio"/>	<input type="radio"/>	<input type="radio"/>	<input type="radio"/>	<input type="radio"/>	<input type="radio"/>	<input type="radio"/>	<input type="radio"/>	<input type="radio"/>	<input type="radio"/>	<input type="radio"/>	<input type="radio"/>	<input type="radio"/>	<input type="radio"/>	<input type="radio"/>	<input type="radio"/>	<input type="radio"/>	<input type="radio"/>	<input type="radio"/>
Port Settings	26	27	28	29	30	31	32	33	34	35	36	37	38	39	40	41	42	43	44	45	46	47	48	49	50	
Tag	<input type="checkbox"/>	<input type="checkbox"/>	<input type="checkbox"/>	<input type="checkbox"/>	<input type="checkbox"/>	<input type="checkbox"/>	<input type="checkbox"/>	<input type="checkbox"/>	<input type="checkbox"/>	<input type="checkbox"/>	<input type="checkbox"/>	<input type="checkbox"/>	<input type="checkbox"/>	<input type="checkbox"/>	<input type="checkbox"/>	<input type="checkbox"/>	<input type="checkbox"/>	<input type="checkbox"/>	<input type="checkbox"/>	<input type="checkbox"/>	<input type="checkbox"/>	<input type="checkbox"/>	<input type="checkbox"/>	<input type="checkbox"/>	<input type="checkbox"/>	<input type="checkbox"/>
None	<input type="radio"/>	<input type="radio"/>	<input type="radio"/>	<input type="radio"/>	<input type="radio"/>	<input type="radio"/>	<input type="radio"/>	<input type="radio"/>	<input type="radio"/>	<input type="radio"/>	<input type="radio"/>	<input type="radio"/>	<input type="radio"/>	<input type="radio"/>	<input type="radio"/>	<input type="radio"/>	<input type="radio"/>	<input type="radio"/>	<input type="radio"/>	<input type="radio"/>	<input type="radio"/>	<input type="radio"/>	<input type="radio"/>	<input type="radio"/>	<input type="radio"/>	<input type="radio"/>
Egress	<input type="radio"/>	<input type="radio"/>	<input type="radio"/>	<input type="radio"/>	<input type="radio"/>	<input type="radio"/>	<input type="radio"/>	<input type="radio"/>	<input type="radio"/>	<input type="radio"/>	<input type="radio"/>	<input type="radio"/>	<input type="radio"/>	<input type="radio"/>	<input type="radio"/>	<input type="radio"/>	<input type="radio"/>	<input type="radio"/>	<input type="radio"/>	<input type="radio"/>	<input type="radio"/>	<input type="radio"/>	<input type="radio"/>	<input type="radio"/>	<input type="radio"/>	<input type="radio"/>
Forbidden	<input type="radio"/>	<input type="radio"/>	<input type="radio"/>	<input type="radio"/>	<input type="radio"/>	<input type="radio"/>	<input type="radio"/>	<input type="radio"/>	<input type="radio"/>	<input type="radio"/>	<input type="radio"/>	<input type="radio"/>	<input type="radio"/>	<input type="radio"/>	<input type="radio"/>	<input type="radio"/>	<input type="radio"/>	<input type="radio"/>	<input type="radio"/>	<input type="radio"/>	<input type="radio"/>	<input type="radio"/>	<input type="radio"/>	<input type="radio"/>	<input type="radio"/>	<input type="radio"/>
Apply																										
Show All Static VLAN Entries																										

Figure 6- 46. 802.1Q Static VLAN window - Modify

The following fields can then be set in either the **Add** or **Modify** 802.1Q Static VLANs windows:

Parameter	Description
VID (VLAN ID)	Allows the entry of a VLAN ID in the Add window, or displays the VLAN ID of an existing VLAN in the Modify window. VLANs can be identified by either the VID or the VLAN name.
VLAN Name	Allows the entry of a name for the new VLAN in the Add window, or for editing the VLAN name in the Modify window.
Advertisement	Enabling this function will allow the Switch to send out GVRP packets to outside sources, notifying that they may join the existing VLAN.
Port Settings	Allows an individual port to be specified as member of a VLAN.
Tag	Specifies the port as either 802.1Q tagging or 802.1Q untagged. Checking the box will designate the port as Tagged.
None	Allows an individual port to be specified as a non-VLAN member.
Egress	Select this to specify the port as a static member of the VLAN. Egress member ports are ports that will be transmitting traffic for the VLAN. These ports can be either tagged or untagged.
Forbidden	Select this to specify the port as not being a member of the VLAN and that the port is forbidden from becoming a member of the VLAN dynamically.

Click **Apply** to implement changes made.

GVRP Setting

In the **Configuration** menu, open the **VLANs** folder and click **GVRP Setting**.

The **802.1Q Port Settings** window, shown below, allows you to determine whether the Switch will share its VLAN configuration information with other GARP VLAN Registration Protocol (GVRP) enabled switches. In addition, Ingress Checking can be used to limit traffic by filtering incoming packets whose PVID does not match the PVID of the port. Results can be seen in the table under the configuration settings, as seen below.

802.1Q Port Settings						
From	To	PVID	GVRP	Ingress	Acceptable Frame Type	Apply
Port 1	Port 1	1	Disabled	Disabled	Admit All	Apply

802.1Q Port Table				
Port	PVID	GVRP	Ingress Checking	Acceptable Frame Type
1	1	Disabled	Enabled	All Frames
2	4094	Disabled	Enabled	All Frames
3	4094	Disabled	Enabled	All Frames
4	4094	Disabled	Enabled	All Frames
5	1	Disabled	Enabled	All Frames
6	1	Disabled	Enabled	All Frames
7	1	Disabled	Enabled	All Frames
8	1	Disabled	Enabled	All Frames
9	1	Disabled	Enabled	All Frames
10	1	Disabled	Enabled	All Frames
11	1	Disabled	Enabled	All Frames
12	1	Disabled	Enabled	All Frames
13	1	Disabled	Enabled	All Frames
14	1	Disabled	Enabled	All Frames
15	1	Disabled	Enabled	All Frames
16	1	Disabled	Enabled	All Frames
17	1	Disabled	Enabled	All Frames
18	1	Disabled	Enabled	All Frames
19	1	Disabled	Enabled	All Frames
20	1	Disabled	Enabled	All Frames
21	1	Disabled	Enabled	All Frames
22	1	Disabled	Enabled	All Frames
23	1	Disabled	Enabled	All Frames
24	1	Disabled	Enabled	All Frames
25	1	Disabled	Enabled	All Frames
26	1	Disabled	Enabled	All Frames

Figure 6- 47. 802.1Q Port Settings window

The following fields can be set:

Parameter	Description
From/To	These two fields allow you to specify the range of ports that will be included in the Port-based VLAN that you are creating using the 802.1Q Port Settings window.
PVID	The read-only field in the 802.1Q Port Table shows the current PVID assignment for each port, which may be manually assigned to a VLAN when created in the 802.1Q Port Settings table. The Switch's default is to assign all ports to the default VLAN with a VID of 1. The PVID is used by the port to tag outgoing, untagged packets, and to make filtering decisions about incoming packets. If the port is specified to accept only tagged frames - as tagging, and an untagged packet is forwarded to the port for transmission, the port will add an 802.1Q tag using the PVID to write the VID in the tag. When the packet arrives at its destination, the receiving device will use the PVID to make VLAN forwarding decisions. If the port receives a packet, and Ingress filtering is enabled, the port will compare the VID of the incoming packet to its PVID. If the two are unequal, the port will drop the packet. If the two are equal, the port will receive the packet.
GVRP	The Group VLAN Registration Protocol (GVRP) enables the port to dynamically become a member of a VLAN. GVRP is <i>Disabled</i> by default.
Ingress	This field can be toggled using the space bar between <i>Enabled</i> and <i>Disabled</i> . <i>Enabled</i> enables the port to compare the VID tag of an incoming packet with the PVID number assigned to the port. If the two are different, the port filters (drops) the packet. <i>Disabled</i> disables ingress filtering. Ingress Checking is <i>Disabled</i> by default.
Acceptable Frame Type	This field denotes the type of frame that will be accepted by the port. The user may choose between <i>Tagged Only</i> , which means only VLAN tagged frames will be accepted, and <i>Admit All</i> , which mean both tagged and untagged frames will be accepted. <i>Admit All</i> is enabled by default.

Click **Apply** to implement changes made.

Traffic Control

On a computer network, packets such as Multicast packets and Broadcast packets continually flood the network as normal procedure. At times, this traffic may increase do to a malicious endstation on the network or a malfunctioning device, such as a faulty network card. Thus, switch throughput problems will arise and consequently affect the overall performance of the switch network. To help rectify this packet storm, the Switch will monitor and control the situation.

The packet storm is monitored to determine if too many packets are flooding the network, based on the threshold level provided by the user. Once a packet storm has been detected, the Switch will drop packets coming into the Switch until the storm has subsided. This method can be utilized by selecting the **Drop** option of the **Action** field in the window below.

The Switch will also scan and monitor packets coming into the Switch by monitoring the Switch's chip counter. This method is only viable for Broadcast and Multicast storms because the chip only has counters for these two types of packets. Once a storm has been detected (that is, once the packet threshold set below has been exceeded), the Switch will shutdown the port to all incoming traffic with the exception of STP BPDU packets, for a time period specified using the Countdown field. If this field times out and the packet storm continues, the port will be placed in a Shutdown Forever mode which will produce a warning message to be sent to the Trap Receiver. Once in Shutdown Forever mode, one method of recovering this port is to manually recoup it using the **Port Configuration** window in the **Administration** folder, and selecting the disabled port and returning it to an Enabled status. Otherwise, the Shutdown Forever mode will be Auto-Recovery after 5 mins. To utilize this method of Storm Control, choose the **Shutdown** option of the **Action** field in the window below.

Traffic Control Settings

Storm Type	Broadcast ▾	State: Disable ▾
Action	shutdown ▾	
Group List	From: Port 1 ▾	To: Port 1 ▾ <input type="button" value="Note"/>
Threshold (pps)	128000	
Time Interval (sec)	5	
Countdown (min)	0	

Traffic Control Table (Action Indication D: drop S: shutdown *: shutdown forever)

Port	Broadcast/ Threshold/Action	Multicast/ Threshold/Action	Unicast/ Threshold/Action	Time Interval	Count down
1	Disabled / 128000 / D	Disabled / 128000 / D	Disabled / 128000 / D	5	0
2	Disabled / 128000 / D	Disabled / 128000 / D	Disabled / 128000 / D	5	0
3	Disabled / 128000 / D	Disabled / 128000 / D	Disabled / 128000 / D	5	0
4	Disabled / 128000 / D	Disabled / 128000 / D	Disabled / 128000 / D	5	0
5	Disabled / 128000 / D	Disabled / 128000 / D	Disabled / 128000 / D	5	0
6	Disabled / 128000 / D	Disabled / 128000 / D	Disabled / 128000 / D	5	0

Figure 6- 48. Traffic Control Setting window

Use the **Traffic Control Setting** window to enable or disable storm control and adjust the threshold for multicast and broadcast storms, as well as Unicast (Destination Look Up Failure). Traffic control settings are applied to individual Switch modules. To view the following window, click **Configuration > Traffic Control**:

The user may set the following parameters:

Parameter	Description
Trap Setting	
Traffic Control Trap	<p>Enable sending of Storm Trap messages when the type of action taken by the Traffic Control function in handling a Traffic Storm is one of the following:</p> <p><i>None</i> – Will send no Storm trap warning messages regardless of action taken by the Traffic Control mechanism.</p> <p><i>Storm Occurred</i> – Will send Storm Trap warning messages upon the occurrence of a Traffic Storm only.</p> <p><i>Storm Cleared</i> – Will send Storm Trap messages when a Traffic Storm has been cleared by the Switch only.</p> <p><i>Both</i> – Will send Storm Trap messages when a Traffic Storm has been both detected and cleared by the Switch.</p> <p>This function cannot be implemented in the Hardware mode. (When Drop is chosen in the Action field.</p>
Traffic Control Settings	
Storm Type	Select the type of Storm Type to detect, either Broadcast Multicast or Unicast . Once selected , use the pull-down menu to enable or disable this storm detection.
Action	<p>Select the method of traffic Control from the pull down menu. The choices are:</p> <p><i>shutdown</i> – Utilizes the Switch’s software Traffic Control mechanism to determine the Packet Storm occurring. Once detected, the port will deny all incoming traffic to the port except STP BPDU packets, which are essential in keeping the Spanning Tree operational on the Switch. If the countdown timer has expired and yet the Packet Storm continues, the port will be placed in Shutdown Forever mode and is no longer operational until the user manually resets the port using the config ports enable command or waits for 5 mins to let the Shutdown Forever mode enter Auto-Recovery. Choosing this option obligates the user to configure the Interval setting as well, which will provide packet count samplings from the Switch’s chip to determine if a Packet Storm is occurring.</p> <p><i>drop</i> – Utilizes the hardware Traffic Control mechanism, which means the Switch’s hardware will determine the Packet Storm based on the Threshold value stated and drop packets until the issue is resolved.</p>
Group List	Select the ports to be manually recovered from the Shutdown state.
Threshold	Specifies the maximum number of packets per second that will trigger the Traffic Control function to commence. The configurable threshold range is from 0-255000 with a default setting of 128000.
Time Interval	The Interval will set the time between Multicast and Broadcast packet counts sent from the Switch’s chip to the Traffic Control function. These packet counts are the determining factor in deciding when incoming packets exceed the Threshold value. The Interval may be set between 5 and 30 seconds with the default setting of 5 seconds.
Count Down	The Count Down timer is set to determine the amount of time, in minutes, that the Switch will wait before shutting down the port that is experiencing a traffic storm. This parameter is only useful for ports configured as Shutdown in their Action field and therefore will not operate for Hardware based Traffic Control implementations. The possible time settings for this field are 0, 5-30 minutes. 0 is the default setting for this field and 0 will denote that the port will immediately shutdown.

Click **Apply** to implement the settings made.



NOTE: Traffic Control cannot be implemented on ports that are set for Link Aggregation (Port Trunking).



NOTE: Ports that are in the Shutdown forever mode will be seen as Discarding in Spanning Tree windows and implementations though these ports will still be forwarding BPDUs to the Switch's CPU.



NOTE: Ports that are in Shutdown Forever mode will be seen as link down in all windows and screens until the user recovers these ports or waits for 5 mins to let the Shutdown Forever mode enter Auto-Recovery.



NOTE: When configuring the traffic storm settings, remember that when it is configured for **shutdown**, the Group List will refer to individual ports. Yet, when the traffic control is configured for **drop**, the group list refers to groups of ports. (Ex – 1 refers to ports 1 through 8, 2 refers to ports 9-16...)

The group list settings for drop are as follows:

Group 1 - Inclusive for ports 1-8.

Group 2 - Inclusive for ports 9-16.

Group 3 - Inclusive for ports 17-24.

Group 4 - Inclusive for ports 9-16 (DES-3550). Inclusive for Gigabit port 25 (DES-3526).

Group 5 - Inclusive for ports 33-40 (DES-3550). Inclusive for Gigabit port 26 (DES-3526).

Group 6 - Inclusive for ports 41-48 (DES-3550 only).

Group 7 - Inclusive for Gigabit port 49 (DES-3550 only).

Group 8 - Inclusive for Gigabit port 50 (DES-3550 only).



Port Security

A given port's (or a range of ports') dynamic MAC address learning can be locked such that the current source MAC addresses entered into the MAC address forwarding table can not be changed once the port lock is enabled. Using the Admin State pull-down menu to Enabled, and clicking Apply can lock the port.

Port Security is a security feature that prevents unauthorized computers (with source MAC addresses) unknown to the Switch prior to locking the port (or ports) from connecting to the Switch's locked ports and gaining access to the network.

Figure 6- 49. Port Security Settings window

The following parameters can be set:

Parameter	Description
Port Security Trap/Log	
State	Use the pull-down menu the enable or disable Port Security Trap/Log messages to be sent to the Switch's log file and to the SNMP manager.
Port Security Settings	
From/To	A consecutive group of ports may be configured starting with the selected port.
Admin State	This pull-down menu allows you to enable or disable Port Security (locked MAC address table for the selected ports).
Max. Learning Addr. (0-64)	The number of MAC addresses that will be in the MAC address-forwarding table for the selected switch and group of ports.
Lock Address Mode	This pull-down menu allows you to select how the MAC address table locking will be implemented on the Switch, for the selected group of ports. The options are: <ul style="list-style-type: none"> • <i>Permanent</i> – The locked addresses will not age out after the aging timer expires. • <i>Delete OnTimeout</i> – The locked addresses will age out after the aging timer expires. • <i>Delete On Reset</i> – The locked addresses will not age out until the Switch has been reset.

Click **Apply** to implement changes made.

QoS

The DES-3500 Series switches supports 802.1p priority queuing Quality of Service. The following section discusses the implementation of QoS (Quality of Service) and benefits of using 802.1p priority queuing.

Advantages of QoS

QoS is an implementation of the IEEE 802.1p standard that allows network administrators a method of reserving bandwidth for important functions that require a large bandwidth or have a high priority, such as VoIP (voice-over Internet Protocol), web browsing applications, file server applications or video conferencing. Not only can a larger bandwidth be created, but other less critical traffic can be limited, so excessive bandwidth can be saved. The Switch has separate hardware queues on every physical port to which packets from various applications can be mapped to, and, in turn prioritized. View the following map to see how the DES-3500 Series switches implements 802.1P priority queuing.

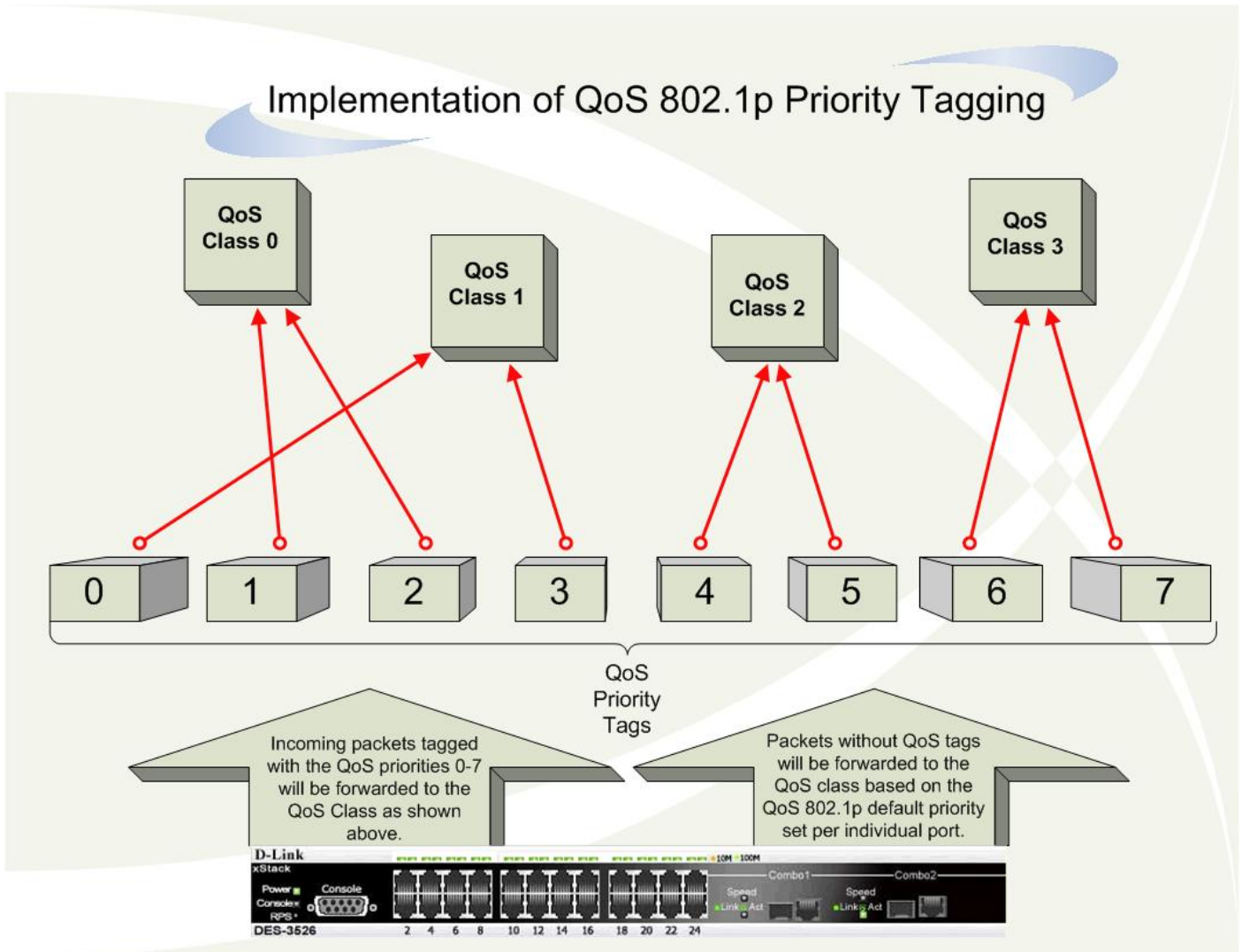

Figure 6- 50. Mapping QoS on the Switch

The picture above shows the default priority setting for the Switch. Class-3 has the highest priority of the four priority queues on the Switch. In order to implement QoS, the user is required to instruct the Switch to examine the header of a packet to see if it has the proper identifying tag tagged. Then the user may forward these tagged packets to designated queues on the Switch where they will be emptied, based on priority.

For example, lets say a user wishes to have a video conference between two remotely set computers. The administrator can add priority tags to the video packets being sent out, utilizing the Access Profile commands. Then, on the receiving end, the administrator instructs the Switch to examine packets for this tag, acquires the tagged packets and maps them to a class queue on the Switch. Then in turn, the administrator will set a priority for this queue so that will be emptied before any other packet is forwarded. This results in the end user receiving all packets sent as quickly as possible, thus prioritizing the queue and allowing for an uninterrupted stream of packets, which optimizes the use of bandwidth available for the video conference.

Understanding QoS

The Switch has four priority queues. These priority queues are labeled as 3, the high queue to 0, the lowest queue. The eight priority tags, specified in IEEE 802.1p are mapped to the Switch's priority tags as follows:

- Priority 0 is assigned to the Switch's Q1 queue.
- Priority 1 is assigned to the Switch's Q0 queue.
- Priority 2 is assigned to the Switch's Q0 queue.
- Priority 3 is assigned to the Switch's Q1 queue.
- Priority 4 is assigned to the Switch's Q2 queue.
- Priority 5 is assigned to the Switch's Q2 queue.
- Priority 6 is assigned to the Switch's Q3 queue.
- Priority 7 is assigned to the Switch's Q3 queue.

For strict priority-based scheduling, any packets residing in the higher priority queues are transmitted first. Multiple strict priority queues empty based on their priority tags. Only when these queues are empty, are packets of lower priority transmitted.

For weighted round robin queuing, the number of packets sent from each priority queue depends upon the assigned weight. For a configuration of 8 CoS queues, A~H with their respective weight value: 8~1, the packets are sent in the following sequence: A1, B1, C1, D1, E1, F1, G1, H1, A2, B2, C2, D2, E2, F2, G2, A3, B3, C3, D3, E3, F3, A4, B4, C4, D4, E4, A5, B5, C5, D5, A6, B6, C6, A7, B7, A8, A1, B1, C1, D1, E1, F1, G1, H1.

For weighted round robin queuing, if each CoS queue has the same weight value, then each CoS queue has an equal opportunity to send packets just like round robin queuing.

For weighted round-robin queuing, if the weight for a CoS is set to 0, then it will continue processing the packets from this CoS until there are no more packets for this CoS. The other CoS queues that have been given a nonzero value, and depending upon the weight, will follow a common weighted round-robin scheme.

Remember that the DES-3500 Series switches has four priority queues (and four Classes of Service) for each port on the Switch.

Port Bandwidth

The bandwidth control settings are used to place a ceiling on the transmitting and receiving data rates for any selected port. In the **Configuration** folder, click **Port Bandwidth**, to view the window shown below.

Bandwidth Settings					
From	To	Type	No Limit	Rate	Apply
Port 1	Port 1	RX	Disabled	1	Apply

Port Bandwidth Table		
Port	RX Rate (Mbit/sec)	TX Rate (Mbit/sec)
1	No Limit	No Limit
2	No Limit	No Limit
3	No Limit	No Limit
4	No Limit	No Limit
5	No Limit	No Limit
6	No Limit	No Limit
7	No Limit	No Limit
8	No Limit	No Limit
9	No Limit	No Limit
10	No Limit	No Limit
11	No Limit	No Limit
12	No Limit	No Limit
13	No Limit	No Limit
14	No Limit	No Limit
15	No Limit	No Limit
16	No Limit	No Limit
17	No Limit	No Limit
18	No Limit	No Limit
19	No Limit	No Limit
20	No Limit	No Limit
21	No Limit	No Limit
22	No Limit	No Limit
23	No Limit	No Limit
24	No Limit	No Limit
25	No Limit	No Limit
26	No Limit	No Limit

Figure 6- 51. Bandwidth Settings window

The following parameters can be set or are displayed:

Parameter	Description
From/To	A consecutive group of ports may be configured starting with the selected port.
Type	This drop-down menu allows you to select between <i>RX</i> (receive), <i>TX</i> (transmit), and <i>Both</i> . This setting will determine whether the bandwidth ceiling is applied to receiving, transmitting, or both receiving and transmitting packets.
No Limit	This drop-down menu allows you to specify that the selected port will have no bandwidth limit. <i>Enabled</i> disables the limit.
Rate	This field allows you to enter the data rate, in Mbit/s, that will be the limit for the selected port.

Click **Apply** to set the bandwidth control for the selected ports. Results of configured Bandwidth Settings will be displayed in the **Port Bandwidth Table**.

Scheduling

Changing the output scheduling used for the hardware queues in the Switch can customize QoS. As with any changes to QoS implementation, careful consideration should be given to how network traffic in lower priority queues is affected. Changes in scheduling may result in unacceptable levels of packet loss or significant transmission delay. If you choose to customize this setting, it is important to monitor network performance, especially during peak demand, as bottlenecks can quickly develop if the QoS settings are not suitable. In the **Configuration** folder open the **QoS** folder and click **QoS Output Scheduling**, to view the window shown below.

QoS Output Scheduling		
	Max. Packets(0-255)	Max. Latency(0-255)
Class-0	<input type="text" value="0"/>	<input type="text" value="0"/>
Class-1	<input type="text" value="0"/>	<input type="text" value="0"/>
Class-2	<input type="text" value="0"/>	<input type="text" value="0"/>
Class-3	<input type="text" value="0"/>	<input type="text" value="0"/>
		<input type="button" value="Apply"/>

Figure 6- 52. QoS Output Scheduling window

You may assign the following values to the QoS classes to set the scheduling.

Parameter	Description
Max. Packets (0-255)	Specifies the maximum number of packets the above specified hardware priority queue would be allowed to transmit before allowing the next lowest priority queue to transmit its packets. A value between 0 and 255 can be specified.
Max. Latency (0-255)	Specifies the maximum amount of time the above specified hardware priority queue will be allowed to transmit packets before allowing the next lowest hardware priority queue to begin transmitting its packets. A value between 0 and 255 can be specified - with this value multiplied by 16 ms to arrive at the total allowed time for the queue to transmit packets. For example, a value of 3 specifies 3 X 16 = 48 ms. The queue will continue transmitting the last packet until it is finished when the max latency timer expires.

Click **Apply** to implement changes made.



NOTE: The settings you assign to the queues, numbers 0-7, represent the IEEE 802.1p priority tag number. Do not confuse these settings with port numbers.

802.1p Default Priority

The Switch allows the assignment of a default 802.1p priority to each port on the Switch. In the **Configuration** folder open the **QoS** folder and click **802.1p Default Priority**, to view the window shown to the right. This window allows you to assign a default 802.1p priority to any given port on the Switch. The priority queues are numbered from 0, the lowest priority, to 7, the highest priority. Click **Apply** to implement your settings.

802.1p Default Priority Settings			
From	To	Priority(0-7)	Apply
Port 1	Port 1	0	Apply

802.1p Default Priority Table	
Port	Priority
1	0
2	0
3	0
4	0
5	0
6	0
7	0
8	0
9	0
10	0
11	0
12	0
13	0
14	0
15	0
16	0
17	0
18	0
19	0
20	0
21	0
22	0
23	0
24	0
25	0
26	0

Figure 6- 53. 802.1p Default Priority Settings window

802.1p User Priority

The DES-3500 Series switches allows the assignment of a user priority to each of the 802.1p priorities. In the **Configuration** folder open the **QoS** folder and click **802.1p User Priority**, to view the screen shown below. Once you have assigned a priority to the port groups on the Switch, you can then assign this Class to each of the 4 levels of 802.1p priorities. Click **Apply** to set your changes.

QoS Class of Traffic	
Priority-0	Class-1
Priority-1	Class-0
Priority-2	Class-0
Priority-3	Class-1
Priority-4	Class-2
Priority-5	Class-2
Priority-6	Class-3
Priority-7	Class-3

Apply

Figure 6- 54. QoS Class of Traffic window

Traffic Segmentation

Traffic segmentation is used to limit traffic flow from a single port to a group of ports on either a single switch (in standalone mode) or a group of ports on another switch in a switch stack (Single IP). This method of segmenting the flow of traffic is similar to using VLANs to limit traffic, but is more restrictive. It provides a method of directing traffic that does not increase the overhead of the Master switch CPU.

In the **Configuration** folder open the **QoS** folder and click **Traffic Segmentation**, to view the screen shown below.

Traffic Segmentation Setting																											
Port	1	2	3	4	5	6	7	8	9	10	11	12	13	14	15	16	17	18	19	20	21	22	23	24	25	26	
	<input type="checkbox"/>	<input type="checkbox"/>	<input type="checkbox"/>	<input type="checkbox"/>	<input type="checkbox"/>	<input type="checkbox"/>	<input type="checkbox"/>	<input type="checkbox"/>	<input type="checkbox"/>	<input type="checkbox"/>	<input type="checkbox"/>	<input type="checkbox"/>	<input type="checkbox"/>	<input type="checkbox"/>	<input type="checkbox"/>	<input type="checkbox"/>	<input type="checkbox"/>	<input type="checkbox"/>	<input type="checkbox"/>	<input type="checkbox"/>	<input type="checkbox"/>	<input type="checkbox"/>	<input type="checkbox"/>	<input type="checkbox"/>	<input type="checkbox"/>	<input type="checkbox"/>	<input type="checkbox"/>
Forward Portlist	1	2	3	4	5	6	7	8	9	10	11	12	13	14	15	16	17	18	19	20	21	22	23	24	25	26	
	<input type="checkbox"/>	<input type="checkbox"/>	<input type="checkbox"/>	<input type="checkbox"/>	<input type="checkbox"/>	<input type="checkbox"/>	<input type="checkbox"/>	<input type="checkbox"/>	<input type="checkbox"/>	<input type="checkbox"/>	<input type="checkbox"/>	<input type="checkbox"/>	<input type="checkbox"/>	<input type="checkbox"/>	<input type="checkbox"/>	<input type="checkbox"/>	<input type="checkbox"/>	<input type="checkbox"/>	<input type="checkbox"/>	<input type="checkbox"/>	<input type="checkbox"/>	<input type="checkbox"/>	<input type="checkbox"/>	<input type="checkbox"/>	<input type="checkbox"/>	<input type="checkbox"/>	<input type="checkbox"/>
																										Apply	
Traffic Segmentation Table																											
Port	Forward Portlist																										
1	1-26																										
2	1-26																										
3	1-26																										
4	1-26																										
5	1-26																										
6	1-26																										
7	1-26																										
8	1-26																										
9	1-26																										
10	1-26																										
11	1-26																										
12	1-26																										
13	1-26																										
14	1-26																										
15	1-26																										
16	1-26																										
17	1-26																										
18	1-26																										
19	1-26																										
20	1-26																										
21	1-26																										
22	1-26																										
23	1-26																										
24	1-26																										
25	1-26																										
26	1-26																										

Figure 6- 55. Traffic Segmentation Setting window

This page allows you to determine which port on a given switch will be allowed to forward packets to other ports on that switch. The user may set the following parameters:

Parameter	Description
Port	Check the corresponding boxes for the port(s) you wish to transmit packets.
Forward Portlist	Check the boxes to select which of the ports on the Switch will be able to forward packets. These ports will be allowed to receive packets from the port specified above.

Clicking the **Apply** button will enter the combination of transmitting port and allowed receiving ports into the Switch's **Traffic Segmentation Table**.

System Severity Alerts

The Switch can be configured to allow alerts be logged or sent as a trap to an SNMP agent or both. The level at which the alert triggers either a log entry or a trap message can be set as well. Use the System Severity Settings menu to set the criteria for alerts. The current settings are displayed below the Settings menu.



NOTE: For detailed information regarding Log entries that will appear in this window, please refer to Appendix C at the back of this manual.

Figure 6- 56. System Severity Settings

Use the drop-down menus to configure the parameters described below.

Parameter	Description
Severity Name	Choose how the alerts are used from the drop-down menu. Select <i>log</i> to send the alert of the Severity Type configured to the Switch’s log for analysis. Choose <i>trap</i> to send it to an SNMP agent for analysis, or select <i>all</i> to send the chosen alert type to an SNMP agent and the Switch’s log for analysis.
Severity Type	Choose what level of alert will trigger sending the log entry or trap message as defined by the Severity Name. Select <i>critical</i> to send only critical events to the Switch’s log or SNMP agent. Choose <i>warning</i> to send critical and warning events to the Switch’s log or SNMP agent. Select <i>information</i> send informational, warning and critical events to the Switch’s log or SNMP agent.

Click **Apply** to implement the new System Severity alert level.

System Log Server

The Switch can send Syslog messages to up to four designated servers using the **System Log Server**. In the **Configuration** folder, click **System Log Server**, to view the window shown below.

Figure 6- 57. System Log Servers window

The parameters configured for adding and editing **System Log Server** settings are the same. See the table below for a description.

Figure 6- 58. System Log Server window – Add

The following parameters can be set:

Parameter	Description																																																
Index	Syslog server settings index (1-4).																																																
Server IP	The IP address of the Syslog server.																																																
Severity	This drop-down menu allows you to select the level of messages that will be sent. The options are <i>Warning</i> , <i>Informational</i> , and <i>All</i> .																																																
Facility	<p>Some of the operating system daemons and processes have been assigned Facility values. Processes and daemons that have not been explicitly assigned a Facility may use any of the "local use" facilities or they may use the "user-level" Facility. Those Facilities that have been designated are shown in the following: Bold font means the facility values that the Switch currently now.</p> <table border="1"> <thead> <tr> <th>Numerical Code</th> <th>Facility</th> </tr> </thead> <tbody> <tr><td>0</td><td>kernel messages</td></tr> <tr><td>1</td><td>user-level messages</td></tr> <tr><td>2</td><td>mail system</td></tr> <tr><td>3</td><td>system daemons</td></tr> <tr><td>4</td><td>security/authorization messages</td></tr> <tr><td>5</td><td>messages generated internally by syslog line printer subsystem</td></tr> <tr><td>7</td><td>network news subsystem</td></tr> <tr><td>8</td><td>UUCP subsystem</td></tr> <tr><td>9</td><td>clock daemon</td></tr> <tr><td>10</td><td>security/authorization messages</td></tr> <tr><td>11</td><td>FTP daemon</td></tr> <tr><td>12</td><td>NTP subsystem</td></tr> <tr><td>13</td><td>log audit</td></tr> <tr><td>14</td><td>log alert</td></tr> <tr><td>15</td><td>clock daemon</td></tr> <tr><td>16</td><td>local use 0 (local0)</td></tr> <tr><td>17</td><td>local use 1 (local1)</td></tr> <tr><td>18</td><td>local use 2 (local2)</td></tr> <tr><td>19</td><td>local use 3 (local3)</td></tr> <tr><td>20</td><td>local use 4 (local4)</td></tr> <tr><td>21</td><td>local use 5 (local5)</td></tr> <tr><td>22</td><td>local use 6 (local6)</td></tr> <tr><td>23</td><td>local use 7 (local7)</td></tr> </tbody> </table>	Numerical Code	Facility	0	kernel messages	1	user-level messages	2	mail system	3	system daemons	4	security/authorization messages	5	messages generated internally by syslog line printer subsystem	7	network news subsystem	8	UUCP subsystem	9	clock daemon	10	security/authorization messages	11	FTP daemon	12	NTP subsystem	13	log audit	14	log alert	15	clock daemon	16	local use 0 (local0)	17	local use 1 (local1)	18	local use 2 (local2)	19	local use 3 (local3)	20	local use 4 (local4)	21	local use 5 (local5)	22	local use 6 (local6)	23	local use 7 (local7)
Numerical Code	Facility																																																
0	kernel messages																																																
1	user-level messages																																																
2	mail system																																																
3	system daemons																																																
4	security/authorization messages																																																
5	messages generated internally by syslog line printer subsystem																																																
7	network news subsystem																																																
8	UUCP subsystem																																																
9	clock daemon																																																
10	security/authorization messages																																																
11	FTP daemon																																																
12	NTP subsystem																																																
13	log audit																																																
14	log alert																																																
15	clock daemon																																																
16	local use 0 (local0)																																																
17	local use 1 (local1)																																																
18	local use 2 (local2)																																																
19	local use 3 (local3)																																																
20	local use 4 (local4)																																																
21	local use 5 (local5)																																																
22	local use 6 (local6)																																																
23	local use 7 (local7)																																																
UDP Port (514 or 6000-65535)	Type the UDP port number used for sending Syslog messages. The default is 0.																																																
Status	Choose <i>Enabled</i> or <i>Disabled</i> to activate or deactivate.																																																

To set the System Log Server configuration, click **Apply**. To delete an entry from the **System Log Server** window, click the corresponding  button under "Delete" heading. under the Delete heading of the entry you wish to delete. To return to the **Current System Log Servers** window, click the [Show All System Log Servers link](#).

SNTP Settings

Time Setting

To configure the time settings for the Switch, open the **Configuration** folder, then the **SNTP** folder and click on the **Current Time Setting** link, revealing the following window for the user to configure.

The screenshot shows a web-based configuration window titled "Current Time: Status". It is divided into three main sections:

- Current Time: Status**: Shows "Current Time" as "0 days 00:52:52" and "Time Source" as "System Clock".
- Current Time: SNTP Settings**: Includes a "SNTP State" dropdown set to "Disabled", "SNTP Primary Server" and "SNTP Secondary Server" text boxes both containing "0.0.0.0", and "SNTP Poll Interval in Seconds" set to "720". An "Apply" button is at the bottom right.
- Current Time: Set Current Time**: Includes "Year" (2002), "Month" (January), "Day" (01), and "Time in HH MM" (00:00). An "Apply" button is at the bottom right.

Figure 6- 59. Current Time: Status window

The following parameters can be set or are displayed:

Parameter	Description
Current Time: Status	
Current Time	The current local date and time for the system.
Time Source	Displays the time source for the system.
Current Time: SNTP Settings	
SNTP State	Use this pull-down menu to <i>Enabled</i> or <i>Disabled</i> SNTP.
SNTP Primary Server	This is the IP address of the primary server the SNTP information will be taken from.
SNTP Secondary Server	This is the IP address of the secondary server the SNTP information will be taken from.
SNTP Poll Interval in Seconds	This is the interval, in seconds, between requests for updated SNTP information.
Current Time: Set Current Time	
Year	Enter the current year, if you want to update the system clock.
Month	Enter the current month, if you would like to update the system clock.
Day	Enter the current day, if you would like to update the system clock.
Time in HH MM	Enter the current time in hours and minutes, if you would like to update the system clock.

Click **Apply** to implement your changes.

Time Zone and DST

The following are windows used to configure time zones and Daylight Savings time settings for SNTP. Open the **Configuration** folder, then the **SNTP** folder and click on the **Time Zone and DST** link, revealing the following window.

Time Zone and DST Settings

Daylight Saving Time State: Disabled

Daylight Saving Time Offset in Minutes: 60

Time Zone Offset from GMT in +/-HH:MM: - 06 00

Apply

DST Repeating Settings

From: Which Day: First

From: Day of Week: Sunday

From: Month: April

From: Time in HH:MM: 00 00

To: Which Day: Last

To: Day of Week: Sunday

To: Month: October

To: Time in HH:MM: 00 00

Apply

DST Annual Settings

From: Month: April

From: Day: 29

From: Time in HH:MM: 00 00

To: Month: October

To: Day: 12

To: Time in HH:MM: 00 00

Apply

Figure 6- 60. Time Zone and DST Settings window

The following parameters can be set:

Parameter	Description
Time Zone and DST Settings	
Daylight Saving Time State	Use this pull-down menu set the DST Settings as disabled, repeating, or annual.
Daylight Saving Time Offset in Minutes	Use this pull-down menu to specify the amount of time that will constitute your local DST offset 30, 60, 90, or 120 minutes.
Time Zone Offset from GMT in +/-HH:MM	Use these pull-down menus to specify your local time zone's offset from Greenwich Mean Time (GMT.)
DST Repeating Settings	
Using repeating mode will enable DST seasonal time adjustment. Repeating mode requires that the DST beginning and ending date be specified using a formula. For example, specify to begin DST on Saturday during the second week of April and end DST on Sunday during the last week of October.	
From: Which Day	Enter the week of the month that DST will start.
From: Day of Week	Enter the day of the week that DST will start on.
From: Month	Enter the month DST will start on.
From: time in HH:MM	Enter the time of day that DST will start on.
To: Which Day	Enter the week of the month the DST will end.

To: Day of Week	Enter the day of the week that DST will end.
To: Month	Enter the month that DST will end.
To: time in HH:MM	Enter the time DST will end.
DST Annual Settings	
Using annual mode will enable DST seasonal time adjustment. Annual mode requires that the DST beginning and ending date be specified concisely. For example, specify to begin DST on April 3 and end DST on October 14.	
From: Month	Enter the month DST will start on, each year.
From: Day	Enter the day of the week DST will start on, each year.
From: Time in HH:MM	Enter the time of day DST will start on, each year.
To: Month	Enter the month DST will end on, each year.
To: Day	Enter the day of the week DST will end on, each year.
To: Time in HH:MM	Enter the time of day that DST will end on, each year.

Click **Apply** to implement changes made to the **Time Zone and DST** window.

Access Profile Table

Configuring the Access Profile Table

Access profiles allow you to establish criteria to determine whether or not the Switch will forward packets based on the information contained in each packet's header.



Note: Treatment of the Access Profile feature has been changed for the Release III version of the firmware. There are also some restrictions on the use of access profiles on the Switch. For more information on the changes for Release III and the limitations on access profiles, please read the CLI Reference Manual's discussion of Access Control Lists (ACL) Commands.

Creating an access profile is divided into two basic parts. The first is to specify which part or parts of a frame the Switch will examine, such as the MAC source address or the IP destination address. The second part is entering the criteria the Switch will use to determine what to do with the frame.

To display the currently configured Access Profiles on the Switch, open the **Configuration** folder and click on the **Access Profile Table** link. This will open the **Access Profile Table** window, as shown below.

Add		Clear All			
Free ACL Rules Table					
System	Port 1-8	Port 9-16	Port 17-24	Port 25	Port 26
800	200	200	200	100	100
Access Profile Table					
Profile ID	Type	Owner	Access Rule	Delete	
1	Ethernet	ACL	Modify	✕	
2	IP	ACL	Modify	✕	
3	Packet Content Mask	ACL	Modify	✕	

Figure 6- 61. Access Profile Table window

All free ACL rules will be listed in the **Free ACL Rules Table** as above. To add an entry to the Access Profile Table, click the **Add** button. This will open the **Access Profile Configuration** window, as shown below. There are three **Access Profile Configuration** windows; one for Ethernet (or MAC address-based) profile configuration, one for IP address-based profile configuration and one for the Packet Content Mask. You can switch between the three **Access Profile Configuration** windows by using the Type drop-down menu. To clear all access profiles, click **Clear All** button on the above window.

The window shown below is the **Access Profile Configuration** window for Ethernet.



Note: Up to nine Access Profiles of the possible 255 profile IDs available may be created for the Switch. The Profile ID is used for relative priority for an Access Profile should a conflict arise between a rule created in one profile and a rule created in a different profile. Please read the CLI Reference Manual chapter discussing Access Control List (ACL) Commands.

Access Profile Configuration	
Profile ID(1-255)	1
Type	Ethernet
VLAN	<input type="checkbox"/>
Source MAC	<input type="checkbox"/> 00-00-00-00-00-00
Destination MAC	<input type="checkbox"/> 00-00-00-00-00-00
802.1p	<input type="checkbox"/>
Ethernet type	<input type="checkbox"/>
Apply	
Show All Access Profile Table Entries	

Figure 6- 62. Access Profile Configuration window (Ethernet)

The following parameters can be set, for the Ethernet type:

Parameter	Description
Profile ID (1-255)	Type in a unique identifier number for this profile set. The number is used to set the relative priority for the profile. Priority is set relative to other profiles where the lowest profile ID has the highest priority. If a conflict occurs among configured access rules, the profile ID establishes relative priority of the rules. The value can be set from 1 to 255 however there is a limit to the total number of profiles that can be created.
Type	Select profile based on Ethernet (MAC Address), IP address or packet content mask. This will change the menu according to the requirements for the type of profile. <ul style="list-style-type: none"> • Select <i>Ethernet</i> to instruct the Switch to examine the layer 2 part of each packet header. • Select <i>IP</i> to instruct the Switch to examine the IP address in each frame's header. • Select <i>Packet Content Mask</i> to specify a mask to hide the content of the packet header.
VLAN	Selecting this option instructs the Switch to examine the VLAN identifier of each packet header and use this as the full or partial criterion for forwarding.
Source Mac	Source MAC Mask - Enter a MAC address mask for the source MAC address.
Destination Mac	Destination MAC Mask - Enter a MAC address mask for the destination MAC address.
802.1p	Selecting this option instructs the Switch to examine the 802.1p priority value of each packet header and use this as the, or part of the criterion for forwarding.
Ethernet type	Selecting this option instructs the Switch to examine the Ethernet type value in each frame's header.

The window shown below is the **Access Profile Configuration** window for IP.

Figure 6- 63. Access Profile Configuration window (IP)

The following parameters can be set, for IP:

Parameter	Description
Profile ID (1-255)	Type in a unique identifier number for this profile set. The number is used to set the relative priority for the profile. Priority is set relative to other profiles where the lowest profile ID has the highest priority. If a conflict occurs among configured access rules, the profile ID establishes relative priority of the rules. The value can be set from 1 to 255 however there is a limit to the total number of profiles that can be created.
Type	Select profile based on Ethernet (MAC Address), IP address or packet content mask. This will change the menu according to the requirements for the type of profile. <ul style="list-style-type: none"> • Select <i>Ethernet</i> to instruct the Switch to examine the layer 2 part of each packet header. • Select <i>IP</i> to instruct the Switch to examine the IP address in each frame's header. • Select <i>Packet Content Mask</i> to specify a mask to hide the content of the packet header.
VLAN	Selecting this option instructs the Switch to examine the VLAN part of each packet header and use this as the, or part of the criterion for forwarding.
Source IP Mask	Enter an IP address mask for the source IP address.
Destination IP Mask	Enter an IP address mask for the destination IP address.
DSCP	Selecting this option instructs the Switch to examine the DiffServ Code part of each packet header and use this as the, or part of the criterion for forwarding.
Protocol	Selecting this option instructs the Switch to examine the protocol type value in each frame's header. You must then specify what protocol(s) to include according to the following guidelines:

	<p>Select <i>ICMP</i> to instruct the Switch to examine the Internet Control Message Protocol (ICMP) field in each frame's header.</p> <ul style="list-style-type: none"> • Select <i>Type</i> to further specify that the access profile will apply an ICMP type value, or specify <i>Code</i> to further specify that the access profile will apply an ICMP code value. <p>Select <i>IGMP</i> to instruct the Switch to examine the Internet Group Management Protocol (IGMP) field in each frame's header.</p> <ul style="list-style-type: none"> • Select <i>Type</i> to further specify that the access profile will apply an IGMP type value <p>Select <i>TCP</i> to use the TCP port number contained in an incoming packet as the forwarding criterion. Selecting TCP requires that you specify a source port mask and/or a destination port mask. The user may also identify which flag bits to deny. Flag bits are parts of a packet that determine what to do with the packet. The user may deny packets by denying certain flag bits within the packets, by checking the boxes corresponding to the flag bits of the TCP field. The user may choose between urg (urgent), ack (acknowledgement), psh (push), rst (reset), syn (synchronize), fin (finish).</p> <ul style="list-style-type: none"> • <i>src port mask</i> - Specify a TCP port mask for the source port in hex form (hex 0x0-0xffff), which you wish to deny. • <i>dest port mask</i> - Specify a TCP port mask for the destination port in hex form (hex 0x0-0xffff) which you wish to deny. <p>Select <i>UDP</i> to use the UDP port number contained in an incoming packet as the forwarding criterion. Selecting UDP requires that you specify a source port mask and/or a destination port mask.</p> <ul style="list-style-type: none"> • <i>src port mask</i> - Specify a TCP port mask for the source port in hex form (hex 0x0-0xffff). • <i>dest port mask</i> - Specify a TCP port mask for the destination port in hex form (hex 0x0-0xffff). <p><i>protocol id</i> - Enter a value defining the protocol ID in the packet header to mask. Specify up to 5, Layer 4 port masks for the destination port in hex form (hex 0x0-0xffffffff).</p>
--	---

The window shown below is the **Access Profile Configuration** window for Packet Content Mask.

Figure 6- 64. Access Profile Configuration window (Packet Content Mask)

This screen will aid the user in Switch to mask packet headers beginning with the offset value specified. The following fields are used to configure the Packet Content Mask:

Parameter	Description
Profile ID (1-255)	Type in a unique identifier number for this profile set. This value can be set from 1 to 255.
Type	Select profile based on <i>Ethernet</i> (MAC Address), <i>IP</i> address or <i>Packet Content Mask</i> . This will change the menu according to the requirements for the type of profile. <ul style="list-style-type: none"> • Select <i>Ethernet</i> to instruct the Switch to examine the layer 2 part of each packet header. • Select <i>IP</i> to instruct the Switch to examine the IP address in each frame's header. • Select <i>Packet Content Mask</i> to specify a mask to hide the content of the packet header.
Offset	This field will instruct the Switch to mask the packet header beginning with the offset value specified: <ul style="list-style-type: none"> • <i>value (0-15)</i> - Enter a value in hex form to mask the packet from the beginning of the packet to the 16th byte. • <i>value (16-31)</i> – Enter a value in hex form to mask the packet from byte 16 to byte 31. • <i>value (32-47)</i> – Enter a value in hex form to mask the packet from byte 32 to byte 47. • <i>value (48-63)</i> – Enter a value in hex form to mask the packet from byte 48 to byte 63. • <i>value (64-79)</i> – Enter a value in hex form to mask the packet from byte 64 to byte 79.

Click **Apply** to implement changes made.

To establish the rule for a previously created Access Profile:

In the **Configuration** folder, click the **Access Profile Table** link opening the **Access Profile Table** window. Under the heading Access Rule, clicking **Modify**, will open the following window.

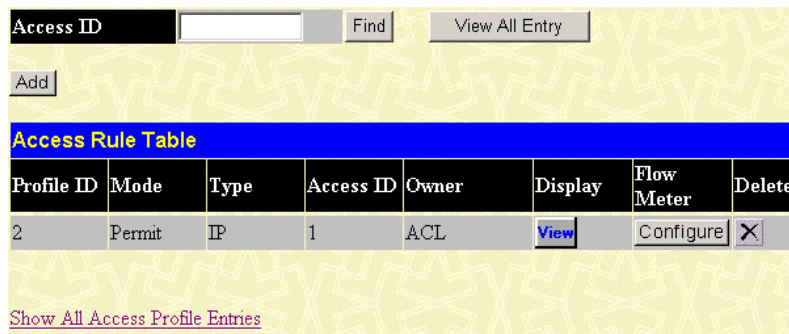

Figure 6- 65. Access Rule Table window

The user may search for the settings of a particular Access ID by entering that ID into the Access ID field above and clicking Find. The user may display all Access ID entries by clicking the View All Entry button.

To create a new rule set for an access profile click the **Add** button. A new window is displayed. To remove a previously created rule, click the corresponding **X** button.

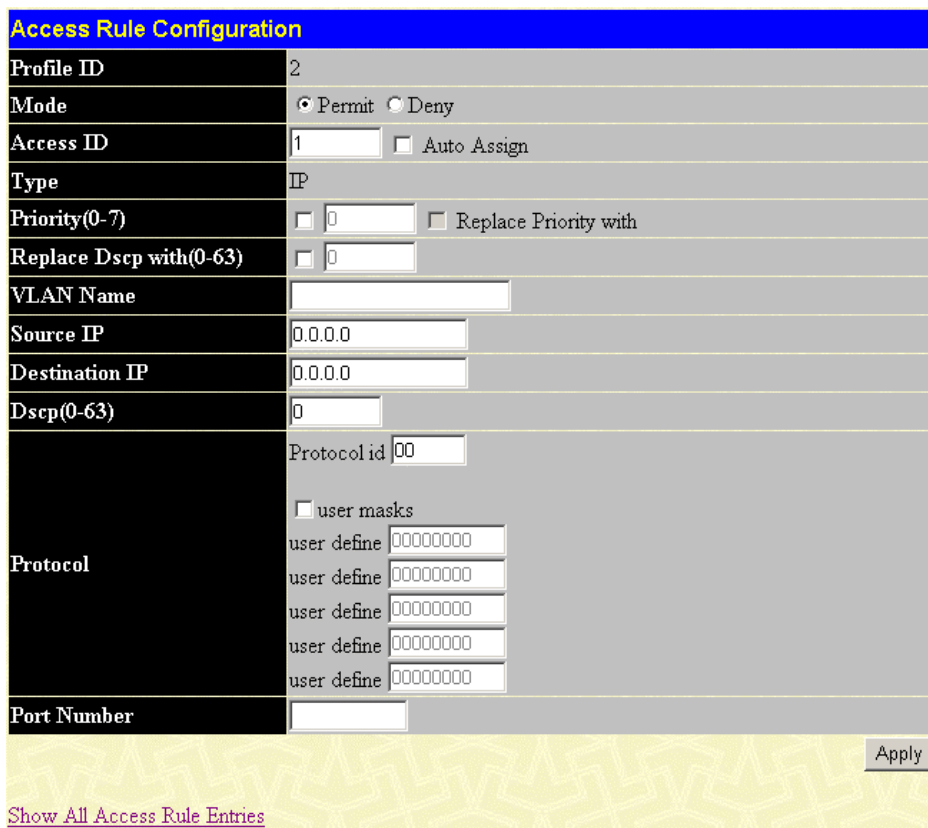

Figure 6- 66. Access Rule Configuration window (IP)

Configure the following Access Rule Configuration settings:

Parameter	Description
Profile ID	This is the identifier number for this profile set.
Mode	Select <i>Permit</i> to specify that the Switch, according to any additional rule, forward the packets that match the access profile added (see below). Select <i>Deny</i> to specify that packets that match the access profile are not forwarded by the Switch and will be filtered.
Access ID (1-65535)	Type in a unique identifier number for this access. This value can be set from 1 - 65535. Auto Assign – Checking this field will instruct the Switch to automatically assign an Access

	ID for the rule being created.
Type	Selected profile based on Ethernet (MAC Address), IP address or Packet Content Mask. <ul style="list-style-type: none"> • <i>Ethernet</i> instructs the Switch to examine the layer 2 part of each packet header. • <i>IP</i> instructs the Switch to examine the IP address in each frame's header. • <i>Packet Content Mask</i> instructs the Switch to examine the packet header
Priority (0-7)	This parameter is specified if you want to re-write the 802.1p default priority previously set in the Switch, which is used to determine the CoS queue to which packets are forwarded to. Once this field is specified, packets accepted by the Switch that match this priority are forwarded to the CoS queue specified previously by the user. <i>Replace Priority with</i> – Click the corresponding box if you want to re-write the 802.1p default priority of a packet to the value entered in the Priority (0-7) field, which meets the criteria specified previously in this command, before forwarding it on to the specified CoS queue. Otherwise, a packet will have its incoming 802.1p user priority re-written to its original value before being forwarded by the Switch. For more information on priority queues, CoS queues and mapping for 802.1p, see the QoS section of this manual.
Replace DSCP (0-63)	Select this option to instruct the Switch to replace the DSCP value (in a packet that meets the selected criteria) with the value entered in the adjacent field.
VLAN Name	Allows the entry of a name for a previously configured VLAN.
Source IP	Source IP Address - Enter an IP Address mask for the source IP address.
Destination IP	Destination IP Address - Enter an IP Address mask for the destination IP address.
DSCP (0-63)	This field allows the user to enter a DSCP value in the space provided, which will instruct the Switch to examine the DiffServ Code part of each packet header and use this as the, or part of the criterion for forwarding. The user may choose a value between 0 and 63.
Protocol	This field allows the user to modify the protocol used to configure the Access Rule Table; depending on which protocol the user has chosen, or configured in the Access Profile Table.
Port Number	Enter the switch port number(s) to which you wish this rule to apply.

To view the settings of a previously correctly configured rule, click [View](#) in the Access Rule Table to view the following window:

Access Rule Display	
Profile ID	2
Access ID	1
Mode	Permit
Type	IP
Priority	-----
Replace Dscp with	-----
VLAN Name	default
Source IP	-----
Destination IP	-----
Dscp	-----
Protocol	-----
Port Number	Port 3

[Show All Access Rule Entries](#)

Figure 6- 67. Access Rule Display window (IP)

Click **Configure** button of the above **Access Rule Table** to open the following **ACL Meter Setting** window, which is used to limit the bandwidth of the ingress traffic. When the users create an ACL rule to filter packets, a metering rule can be created to associate with this ACL rule to limit traffic. The step of bandwidth is 1000Kbps on ether ports and 8000Kbps on giga ports. Be aware that due to limited metering rules, not all ACL rules can associate with a metering rule.

ACL Meter Setting

Profile ID	1
Access ID	1
Metering Rate (0-999936)(Kbps)	0
Rate Exceeding Action	Drop

[Show All Access Rule Entries](#)

Note1: "Metering Rate = 0" means "to disable ACL Meter"
 Note2: "Warning! Bandwidth limits are set in increments of 1000Kbps. Bandwidth limits, which are not entered in multiples of 1000, will be rounded down to the nearest 1000Kbps setting. (Ex: 1999Kbps will be set as 1000Kbps)"

Figure 6- 68 ACL Meter Setting window (Configuration)

To configure the Access Rule for *Ethernet*, open the Access Profile Table and click **Modify** for an Ethernet entry. This will open the following window:

Access ID

Profile ID	Mode	Type	Access ID	Owner	Display	Flow Meter	Delete
1	Permit	Ethernet	1	ACL	<input type="button" value="View"/>	<input type="button" value="Configure"/>	<input type="button" value="X"/>

[Show All Access Profile Entries](#)

Figure 6- 69. Access Rule Table window (Ethernet)

The user may search for the settings of a particular Access ID by entering that ID into the Access ID field above and clicking Find. The user may display all Access ID entries by clicking the View All Entry button.

To remove a previously created rule, select it and click the button. To add a new Access Rule, click the **Add** button:

Figure 6- 70. Access Rule Configuration window (Ethernet)

To set the Access Rule for Ethernet, adjust the following parameters and click **Apply**.

Parameters	Description
Profile ID	This is the identifier number for this profile set.
Mode	Select <i>Permit</i> to specify that the Switch, according to any additional rule, forwards the packets that match the access profile added (see below). Select <i>Deny</i> to specify that packets that match the access profile are not forwarded by the Switch and will be filtered.
Access ID (1-65535)	Type in a unique identifier number for this access. This value can be set from 1 - 65535. <i>Auto Assign</i> – Checking this field will instruct the Switch to automatically assign an Access ID for the rule being created.
Type	Selected profile based on Ethernet (MAC Address), IP address or Packet Content Mask. <ul style="list-style-type: none"> <i>Ethernet</i> instructs the Switch to examine the layer 2 part of each packet header. <i>IP</i> instructs the Switch to examine the IP address in each frame's header. <i>Packet Content Mask</i> instructs the Switch to examine the packet header
Priority (0-7)	This parameter is specified if you want to re-write the 802.1p default priority previously set in the Switch, which is used to determine the CoS queue to which packets are forwarded to. Once this field is specified, packets accepted by the Switch that match this priority are forwarded to the CoS queue specified previously by the user. <i>Replace Priority with</i> – Click the corresponding box if you want to re-write the 802.1p default priority of a packet to the value entered in the Priority (0-7) field, which meets the criteria specified previously in this command, before forwarding it on to the specified CoS queue. Otherwise, a packet will have its incoming 802.1p user priority re-written to its original value before being forwarded by the Switch. For more information on priority queues, CoS queues and mapping for 802.1p, see the QoS section of this manual.
Replace Dscp (0-63)	Select this option to instruct the Switch to replace the DSCP value (in a packet that meets the selected criteria) with the value entered in the adjacent field.
VLAN Name	Allows the entry of a name for a previously configured VLAN.
Source MAC	Source MAC Address - Enter a MAC Address for the source MAC address.
Destination MAC	Destination MAC Address - Enter a MAC Address mask for the destination MAC address.

802.1p (0-7)	Enter a value from 0 to 7 to specify that the access profile will apply only to packets with this 802.1p priority value.
Ethernet Type	Specifies that the access profile will apply only to packets with this hexadecimal 802.1Q Ethernet type value (hex 0x0-0xffff) in the packet header. The Ethernet type value may be set in the form: hex 0x0-0xffff, which means the user may choose any combination of letters and numbers ranging from a-f and from 0-9999.
Port Number	Enter the switch port number(s) to which you wish this rule to apply.

To view the settings of a previously correctly configured rule, click [View](#) in the **Access Rule Table** to view the following window:

Access Rule Display	
Profile ID	1
Access ID	1
Mode	Permit
Type	Ethernet
Priority	-----
Replace Dscp with	-----
VLAN Name	default
Source MAC	-----
Destination MAC	-----
802.1p	-----
Ethernet Type	-----
Port Number	Port 2

[Show All Access Rule Entries](#)

Figure 6- 71. Access Rule Display window (Ethernet)

To configure the Access Rule for Packet Content Mask, open the Access Profile Table and click **Modify** for a Packet Content Mask entry. This will display the Access Rule Table.

Access ID	<input type="text"/>	Find	View All Entry				
Add							
Access Rule Table							
Profile ID	Mode	Type	Access ID	Owner	Display	Flow Meter	Delete
3	Permit	Packet Content Mask	1	ACL	View	Configure	X

[Show All Access Profile Entries](#)

Figure 6- 72. Access Rule Table window (Packet Content Mask)

The user may search for the settings of a particular Access ID by entering that ID into the Access ID field above and clicking Find. The user may display all Access ID entries by clicking the View All Entry button.

To remove a previously created rule, select it and click the button. Access rules are indexed using the Access ID number. To locate a specific Access Rule in the table, enter the Access ID and click **Find**. To display all rules in the table, click the **View All Entries** button.

To add a new Access Rule, click the **Add** button above the Access Rule Table to view the Access Rule Configuration menu.

Figure 6-73. Access Rule Configuration window (Packet Content Mask)

To set the Access Rule for the Packet Content Mask, adjust the following parameters and click **Apply**.

Parameter	Description
Profile ID	This is the identifier number for this profile set.
Mode	Select <i>Permit</i> to specify that the Switch, according to any additional rule, forwards the packets that match the access profile added (see below). Select <i>Deny</i> to specify that packets that match the access profile are not forwarded by the Switch and will be filtered.
Access ID	Type in a unique identifier number for this access or use Auto Assign .
Type	Selected profile based on <i>Ethernet</i> (MAC Address), <i>IP</i> address or <i>Packet Content Mask</i> . <ul style="list-style-type: none"> <i>Ethernet</i> instructs the Switch to examine the layer 2 part of each packet header. <i>IP</i> instructs the Switch to examine the IP address in each frame's header. <i>Packet Content Mask</i> instructs the Switch to examine the packet header.
Priority (0-7)	This parameter is specified if you want to re-write the 802.1p default priority previously set in the Switch, which is used to determine the CoS queue to which packets are forwarded to. Once this field is specified, packets accepted by the Switch that match this priority are forwarded to the CoS queue specified previously by the user.

	<p>Replace Priority with – Click the corresponding box if you want to re-write the 802.1p default priority of a packet to the value entered in the Priority (0-7) field, which meets the criteria specified previously in this command, before forwarding it on to the specified CoS queue. Otherwise, a packet will have its incoming 802.1p user priority re-written to its original value before being forwarded by the Switch.</p> <p>For more information on priority queues, CoS queues and mapping for 802.1p, see the QoS section of this manual.</p>
Replace Dscp (0-63)	Select this option to instruct the Switch to replace the DSCP value (in a packet that meets the selected criteria) with the value entered in the adjacent field.
Offset	<p>This field will instruct the Switch to mask the packet header beginning with the offset value specified:</p> <ul style="list-style-type: none"> • <i>value (0-15)</i> - Enter a value in hex form to mask the packet from the beginning of the packet to the 16th byte. • <i>value (16-31)</i> - Enter a value in hex form to mask the packet from byte 16 to byte 31. • <i>value (32-47)</i> - Enter a value in hex form to mask the packet from byte 32 to byte 47. • <i>value (48-63)</i> - Enter a value in hex form to mask the packet from byte 48 to byte 63. • <i>value (64-79)</i> - Enter a value in hex form to mask the packet from byte 64 to byte 79.
Port Number	Enter the switch port number(s) to which you wish this rule to apply.

To view the settings of a previously correctly configured rule, click [View](#) in the **Access Rule Table** to view the following window:

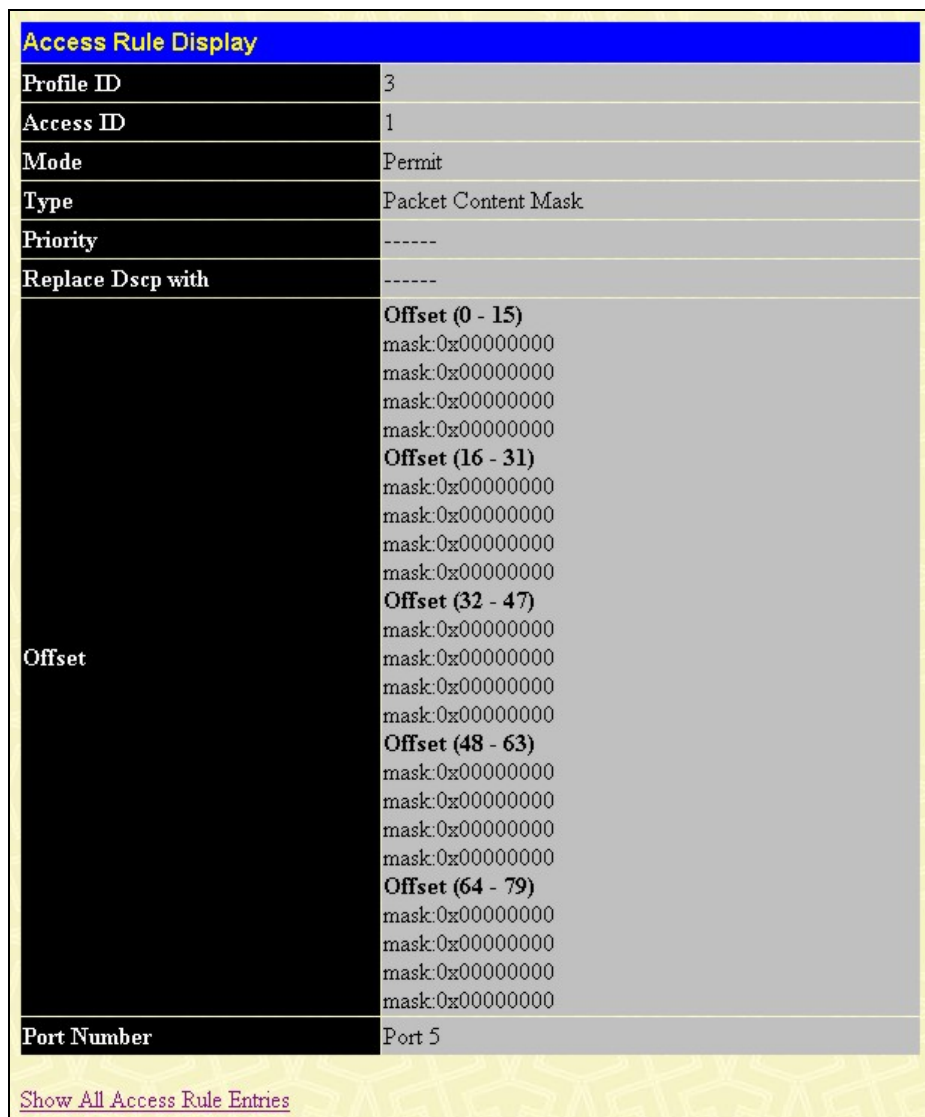

Figure 6- 74. Access Rule Display window (Packet Content)

CPU Interface Filtering

Due to a chipset limitation and the need for extra switch security, the xStack DES-3500 Series switches incorporate CPU Interface filtering. This added feature increases the running security of the Switch by enabling the user to create a list of access rules for packets destined for the Switch’s CPU interface. Employed similarly to the Access Profile feature previously mentioned, CPU interface filtering examines Ethernet, IP and Packet Content Mask packet headers destined for the CPU and will either forward them or filter them, based on the user’s implementation. As an added feature for the CPU Filtering, the Switch allows the CPU filtering mechanism to be enabled or disabled globally, permitting the user to create various lists of rules without immediately enabling them.

Creating an access profile for the CPU is divided into two basic parts. The first is to specify which part or parts of a frame the Switch will examine, such as the MAC source address or the IP destination address. The second part is entering the criteria the Switch will use to determine what to do with the frame. The entire process is described below.

CPU Interface Filtering Profile Table

Click **Configuration > CPU Interface Filtering** to display the CPU Access Profile Table entries created on the Switch. To view the configurations for an entry, click the hyperlinked **Profile ID** number.

The screenshot shows the 'CPU Interface Filtering' configuration window. At the top, there is a 'State' dropdown menu set to 'Disable' and an 'Apply' button. Below this is an 'Add Profile' button. The main section is titled 'CPU Interface Filtering Profile Table' and contains a table with the following data:

Profile ID	Type	Summary	Access Rule	Delete
1	Ethernet	VLAN Enabled	Add	✕
3	IP	VLAN Enabled	Add	✕
4	Packet Content Mask	Offset (0 - 15) mask:0x00000000 mask:0x00000000 mask:0x00000000 mask:0x00000000	Add	✕

Figure 6- 75. CPU Interface Filtering window

To add an entry to the **CPU Interface Filtering Profile Table**, click the **Add** button. This will open the **CPU Interface Filtering Profile Configuration** page, as shown below. There are three **CPU Access Profile Configuration** pages; one for **Ethernet** (or MAC address-based) profile configuration, one for **IP** address-based profile configuration and one for the **Packet Content Mask**. You can switch between the three **CPU Access Profile Configuration** pages by using the **Type** drop-down menu. The page shown below is the **Ethernet CPU Interface Filtering Configuration** page.

The screenshot shows the 'CPU Interface Filtering Profile Configuration' window for Ethernet. It contains the following fields:

- Profile ID (1-5)**: 2
- Type**: Ethernet (dropdown menu)
- VLAN**:
- Source MAC**: 00-00-00-00-00-00
- Destination MAC**: 00-00-00-00-00-00
- 802.1p**:
- Ethernet type**:

At the bottom right is an 'Apply' button. At the bottom left is a link: [Show All CPU Interface Filtering Profile Table Entries](#)

Figure 6- 76. CPU Interface Filtering Profile Configuration window for Ethernet

The following fields may be modified:

Parameter	Description
Profile ID (1-5)	Type in a unique identifier number for this profile set. This value can be set from 1 - 5.
Type	Select profile based on Ethernet (MAC Address), IP address or packet content mask. This will change the menu according to the requirements for the type of profile. <ul style="list-style-type: none"> Select <i>Ethernet</i> to instruct the Switch to examine the layer 2 part of each packet header. Select <i>IP</i> to instruct the Switch to examine the IP address in each frame's header. Select <i>Packet Content Mask</i> to specify a mask to hide the content of the packet header.
VLAN	Selecting this option instructs the Switch to examine the VLAN identifier of each packet header and use this as the full or partial criterion for forwarding.
Source MAC	Source MAC Mask - Enter a MAC address mask for the source MAC address.
Destination MAC	Destination MAC Mask - Enter a MAC address mask for the destination MAC address.
802.1p	Enter a value from 0-7 to specify that the access profile will apply only to packets with this 802.1p priority value.
Ethernet type	Selecting this option instructs the Switch to examine the Ethernet type value in each frame's header.

Click **Apply** to set this entry in the Switch's memory.

The page shown below is the **CPU Interface Filtering Profile Configuration** for **IP** page.

CPU Interface Filtering Profile Configuration

Profile ID(1-5)

Type

VLAN

Source IP Mask

Destination IP Mask

Dscp

Protocol ICMP type code

IGMP type

TCP src port mask
 dest port mask
 flag bit
 urg ack psh
 rst syn fin

UDP src port mask
 dest port mask

protocolid user value
 user masks

[Show All CPU Interface Filtering Profile Table Entries](#)

Figure 6- 77. CPU Interface Filtering Profile Configuration window for IP

The following parameters can be modified:

Parameter	Description
Profile ID (1-5)	Type in a unique identifier number for this profile set. This value can be set from 1 - 5.
Type	<p>Select profile based on Ethernet (MAC Address), IP address or Packet Content Mask. This will change the menu according to the requirements for the type of profile.</p> <ul style="list-style-type: none"> Select <i>Ethernet</i> to instruct the Switch to examine the layer 2 part of each packet header. Select <i>IP</i> to instruct the Switch to examine the IP address in each frame's header. Select <i>Packet Content Mask</i> to specify a mask to hide the content of the packet header.
VLAN	Selecting this option instructs the Switch to examine the VLAN part of each packet header and use this as the, or part of the criterion for forwarding.
Source IP Mask	Enter an IP address mask for the source IP address.
Destination IP Mask	Enter an IP address mask for the destination IP address.
DSCP	Selecting this option instructs the Switch to examine the DiffServ Code part of each packet header and use this as the, or part of the criterion for forwarding.
Protocol	<p>Selecting this option instructs the Switch to examine the protocol type value in each frame's header. You must then specify what protocol(s) to include according to the following guidelines:</p> <p>Select <i>ICMP</i> to instruct the Switch to examine the Internet Control Message Protocol (ICMP) field in each frame's header.</p> <ul style="list-style-type: none"> Select <i>Type</i> to further specify that the access profile will apply an ICMP type value, or specify <i>Code</i> to further specify that the access profile will apply an ICMP code value. <p>Select <i>IGMP</i> to instruct the Switch to examine the Internet Group Management Protocol (IGMP) field in each frame's header.</p> <ul style="list-style-type: none"> Select <i>Type</i> to further specify that the access profile will apply an IGMP type value. <p>Select <i>TCP</i> to use the TCP port number contained in an incoming packet as the forwarding criterion. Selecting TCP requires that you specify a source port mask and/or a destination port mask. The user may also identify which flag bits to filter. Flag bits are parts of a packet that determine what to do with the packet. The user may filter packets by filtering certain flag bits within the packets, by checking the boxes corresponding to the flag bits of the TCP field. The user may choose between <i>urg</i> (urgent), <i>ack</i> (acknowledgement), <i>psh</i> (push), <i>rst</i> (reset), <i>syn</i> (synchronize), <i>fin</i> (finish).</p> <ul style="list-style-type: none"> <i>src port mask</i> - Specify a TCP port mask for the source port in hex form (hex 0x0-0xffff), which you wish to filter. <i>dest port mask</i> - Specify a TCP port mask for the destination port in hex form (hex 0x0-0xffff) which you wish to filter. <p>Select <i>UDP</i> to use the UDP port number contained in an incoming packet as the forwarding criterion. Selecting UDP requires that you specify a source port mask and/or a destination port mask.</p> <ul style="list-style-type: none"> <i>src port mask</i> - Specify a TCP port mask for the source port in hex form (hex 0x0-0xffff). <i>dest port mask</i> - Specify a TCP port mask for the destination port in hex form (hex 0x0-0xffff). <p><i>protocol id</i> - Enter a value defining the protocol ID in the packet header to mask. Specify the protocol ID mask in hex form (hex 0x0-0xffffffff).</p>

Click **Apply** to set this entry in the Switch's memory.

The page shown below is the **CPU Interface Filtering Profile Configuration** window for the **Packet Content Mask**.

Figure 6- 78. CPU Interface Filtering Profile Configuration window for Packet Content Mask

This screen will aid the user in configuring the Switch to mask packet headers beginning with the offset value specified. The following fields are used to configure the **Packet Content Mask**:

Parameter	Description
Profile ID (1-4)	Type in a unique identifier number for this profile set. This value can be set from 1 - 5.
Type	Select profile based on Ethernet (MAC Address), IP address or packet content mask. This will change the menu according to the requirements for the type of profile. <ul style="list-style-type: none"> • Select <i>Ethernet</i> to instruct the Switch to examine the layer 2 part of each packet header. • Select <i>IP</i> to instruct the Switch to examine the IP address in each frame's header. • Select <i>Packet Content Mask</i> to specify a mask to hide the content of the packet header.
Offset	This field will instruct the Switch to mask the packet header beginning with the offset value specified: <ul style="list-style-type: none"> • <i>value (0-15)</i> - Enter a value in hex form to mask the packet from the beginning of the packet to the 15th byte. • <i>value (16-31)</i> – Enter a value in hex form to mask the packet from byte 16 to byte 31. • <i>value (32-47)</i> – Enter a value in hex form to mask the packet from byte 32 to byte 47. • <i>value (48-63)</i> – Enter a value in hex form to mask the packet from byte 48 to byte 63. • <i>value (64-79)</i> – Enter a value in hex form to mask the packet from byte 64 to byte 79.

Click **Apply** to implement changes made.

To establish the rule for a previously created CPU Access Profile:

In the **Configuraion** folder, click **CPU Interface Filtering** to open the **CPU Interface Filtering Profile Table**. In this window, the user may add a rule to a previously created CPU access profile by clicking the corresponding **Add Rule** button of the entry to configure **Ethernet**, **IP** or **Packet Content Mask**.

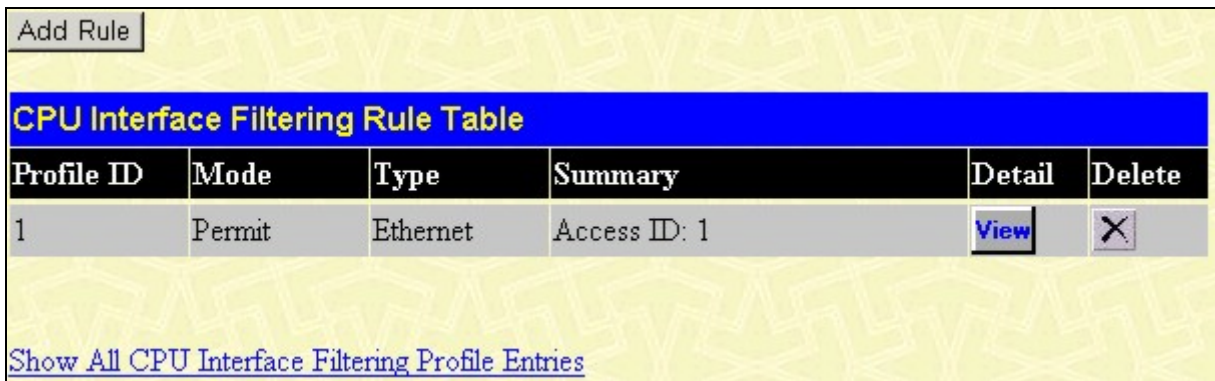

Figure 6- 79. CPU Interface Filtering Rule Table

Click the **Add Rule** button to continue on to the **CPU Interface Filtering Rule Table** window. A new and unique window, for Ethernet, IP and Packet Content will open as shown in the examples below.

To change a rule for a previously created CPU Access Profile Rule:

In this window, the user may change a rule that has been previously created by clicking the corresponding **Modify** button of the entry.

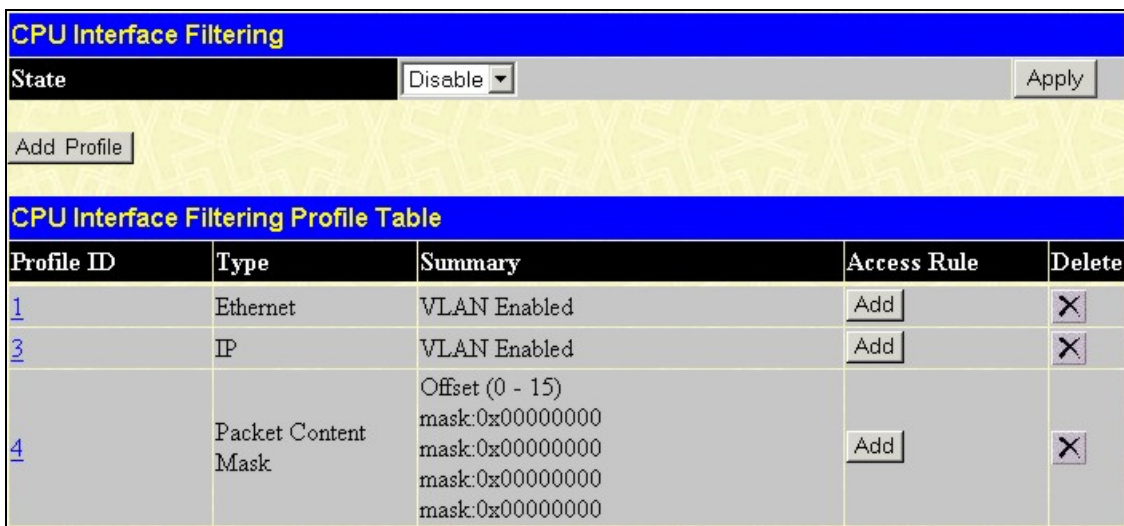

Figure 6- 80. CPU Interface Filtering window

The **CPU Interface Filtering Rule Table** will open. Click [View](#) to observe a previously created rule or to delete. The following window is the configuration page for the Ethernet Rule.

CPU Interface Filtering Rule Configuration	
Profile ID	1
Mode	<input checked="" type="radio"/> Permit <input type="radio"/> Deny
Access ID (1-65535)	2
Type	Ethernet
VLAN Name	
Source MAC	00-00-00-00-00-00
Destination MAC	00-00-00-00-00-00
802.1p (0-7)	0
Ethernet Type	
Apply	
Show All CPU Interface Filtering Rule Entries	

Figure 6- 81. CPU Interface filtering rule Configuration window for Ethernet

To set the CPU Access Rule for Ethernet, adjust the following parameters and click **Apply**.

Parameters	Description
Profile ID	This is the identifier number for this profile set.
Mode	Select <i>Permit</i> to specify that the packets that match the access profile are forwarded by the Switch, according to any additional rule added (see below). Select <i>Deny</i> to specify that packets that match the access profile are not forwarded by the Switch and will be filtered.
Access ID	Type in a unique identifier number for this access and priority. This value can be set from 1 - 65535.
Type	Selected profile based on Ethernet (MAC Address), IP address or Packet Content. <ul style="list-style-type: none"> <i>Ethernet</i> instructs the Switch to examine the layer 2 part of each packet header. <i>IP</i> instructs the Switch to examine the IP address in each frame's header. <i>Packet Content Mask</i> instructs the Switch to examine the packet header.
VLAN Name	Allows the entry of a name for a previously configured VLAN.
Source MAC	Source MAC Address - Enter a MAC Address for the source MAC address.
Destination MAC	Destination MAC Address - Enter a MAC Address mask for the destination MAC address.
802.1P (0-7)	Enter a value from 0-7 to specify that the access profile will apply only to packets with this 802.1p priority value.
Ethernet Type	Specifies that the access profile will apply only to packets with this hexadecimal 802.1Q Ethernet type value (hex 0x0-0xffff) in the packet header. The Ethernet type value may be set in the form: hex 0x0-0xffff, which means the user may choose any combination of letters and numbers ranging from a-f and from 0-9999.

To view the settings of a previously configured rule, click [View](#) in the **CPU Interface Filtering Rule Table** to view the following screen:

CPU Interface Filtering Rule Display	
Profile ID	1
Access ID	1
Mode	Permit
Type	Ethernet
Priority	-----
Replace Dscp	-----
VLAN Name	default
Source MAC	-----
Destination MAC	-----
802.1p	-----
Ethernet Type	-----

[Show All CPU Interface Filtering Rule Entries](#)

Figure 6- 82. CPU Interface Filtering Rule Display for Ethernet

The following window is the **CPU Interface Filtering Rule Configuration** for IP.

CPU Interface Filtering Rule Configuration	
Profile ID	1
Mode	<input checked="" type="radio"/> Permit <input type="radio"/> Deny
Access ID (1-65535)	<input type="text" value="2"/>
Type	IP
VLAN Name	<input type="text"/>
Source IP	<input type="text" value="0.0.0.0"/>
Destination IP	<input type="text" value="0.0.0.0"/>
Dscp (0-63)	<input type="text" value="0"/>
Protocol	Protocol id <input type="text" value="00"/>
	<input type="checkbox"/> user masks
	user define <input type="text" value="00000000"/>
	user define <input type="text" value="00000000"/>
	user define <input type="text" value="00000000"/>
	user define <input type="text" value="00000000"/> user define <input type="text" value="00000000"/>

[Show All CPU Interface Filtering Rule Entries](#)

Figure 6- 83. CPU Interface Filtering Rule Configuration window for IP

Configure the following **CPU Interface Filtering Rule Configuration** settings for IP:

Parameter	Description
Profile ID	This is the identifier number for this profile set.
Mode	Select <i>Permit</i> to specify that the packets that match the access profile are forwarded by the Switch, according to any additional rule added (see below). Select <i>Deny</i> to specify that packets that match the access profile are not forwarded by the Switch and will be filtered.
Access ID	Type in a unique identifier number for this access. This value can be set from 1 -65535.
Type	Selected profile based on Ethernet (MAC Address), IP address or Packet Content. <ul style="list-style-type: none"> <i>Ethernet</i> instructs the Switch to examine the layer 2 part of each packet header. <i>IP</i> instructs the Switch to examine the IP address in each frame's header. <i>Packet Content Mask</i> instructs the Switch to examine the packet header.
VLAN Name	Allows the entry of a name for a previously configured VLAN.
Source IP	Source IP Address - Enter an IP Address mask for the source IP address.
Destination IP	Destination IP Address- Enter an IP Address mask for the destination IP address.
Dscp (0-63)	This field allows the user to enter a DSCP value in the space provided, which will instruct the Switch to examine the DiffServ Code part of each packet header and use this as the, or part of the criterion for forwarding. The user may choose a value between 0 and 63.
Protocol	This field allows the user to modify the protocol used to configure the CPU Interface Filtering Rule Table ; depending on which protocol the user has chosen in the CPU Interface Filtering Profile Table .

To view the settings of a previously correctly configured rule, click [View](#) in the **CPU Interface Filtering Rule Table** to view the following screen:

CPU Interface Filtering Rule Display	
Profile ID	3
Access ID	3
Mode	Permit
Type	IP
Priority	-----
Replace Dscp	-----
VLAN Name	default
Source IP	-----
Destination IP	-----
Dscp	-----
Protocol	-----
Show All CPU Interface Filtering Rule Entries	

Figure 6- 84. CPU Interface Filtering Rule Display for IP

The following window is the **CPU Interface Filtering Rule Configuration** for Packet Content.

Figure 6- 85. CPU Interface Filtering Rule Configuration window for Packet Content Mask

To set the rule for CPU Packet Content, adjust the following parameters and click **Apply**.

Parameters	Description
Profile ID	This is the identifier number for this profile set.
Mode	Select <i>Permit</i> to specify that the packets that match the access profile are forwarded by the Switch, according to any additional rule added (see below). Select <i>Deny</i> to specify that packets that match the access profile are not forwarded by the Switch and will be filtered.
Access ID	Type in a unique identifier number for this access. This value can be set from 1 - 65535.
Type	Selected profile based on Ethernet (MAC Address), IP address or Packet Content. <ul style="list-style-type: none"> • <i>Ethernet</i> instructs the Switch to examine the layer 2 part of each packet header. • <i>IP</i> instructs the Switch to examine the IP address in each frame's header. • <i>Packet Content Mask</i> instructs the Switch to examine the packet header.
Offset	This field will instruct the Switch to mask the packet header beginning with the offset value specified: <ul style="list-style-type: none"> • <i>value (0-15)</i> - Enter a value in hex form to mask the packet from the beginning of the packet to the 15th byte. • <i>value (16-31)</i> - Enter a value in hex form to mask the packet from byte 16 to <i>byte 31</i>. • <i>value (32-47)</i> - Enter a value in hex form to mask the packet from byte 32 to byte 47. • <i>value (48-63)</i> - Enter a value in hex form to mask the packet from byte 48 to byte 63. • <i>value (64-79)</i> - Enter a value in hex form to mask the packet from byte 64 to byte 79.

To view the settings of a previously correctly configured rule, click [View](#) in the **Access Rule Table** to view the following screen:

CPU Interface Filtering Rule Display	
Profile ID	2
Access ID	1
Mode	Permit
Type	Packet Content Mask
Priority	-----
Offset	Offset (0 - 15)
	mask:0x00000000
	mask:0x00000000
	mask:0x00000000
	mask:0x00000000
	Offset (16 - 31)
	mask:0x00000000
	mask:0x00000000
	mask:0x00000000
	mask:0x00000000
	Offset (32 - 47)
	mask:0x00000000
	mask:0x00000000
	mask:0x00000000
	mask:0x00000000
	Offset (48 - 63)
	mask:0x00000000
	mask:0x00000000
	mask:0x00000000
	mask:0x00000000
Offset (64 - 79)	
mask:0x00000000	
mask:0x00000000	
mask:0x00000000	
mask:0x00000000	

[Show All CPU Interface Filtering Rule Entries](#)

Figure 6- 86. CPU Interface Filtering Rule Display for IP

Port Access Entity (802.1X)

802.1x Port-Based and MAC-Based Access Control

The IEEE 802.1x standard is a security measure for authorizing and authenticating users to gain access to various wired or wireless devices on a specified Local Area Network by using a Client and Server based access control model. This is accomplished by using a RADIUS server to authenticate users trying to access a network by relaying Extensible Authentication Protocol over LAN (EAPOL) packets between the Client and the Server. The following figure represents a basic EAPOL packet:

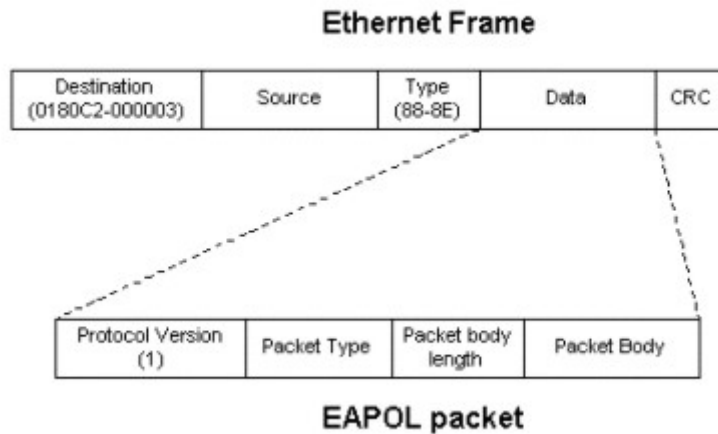

Figure 6- 87. EAPOL Packet

Utilizing this method, unauthorized devices are restricted from connecting to a LAN through a port to which the user is connected. EAPOL packets are the only traffic that can be transmitted through the specific port until authorization is granted. The 802.1x Access Control protocol consists of three components, each of which is vital to creating and maintaining a stable and working Access Control security method.

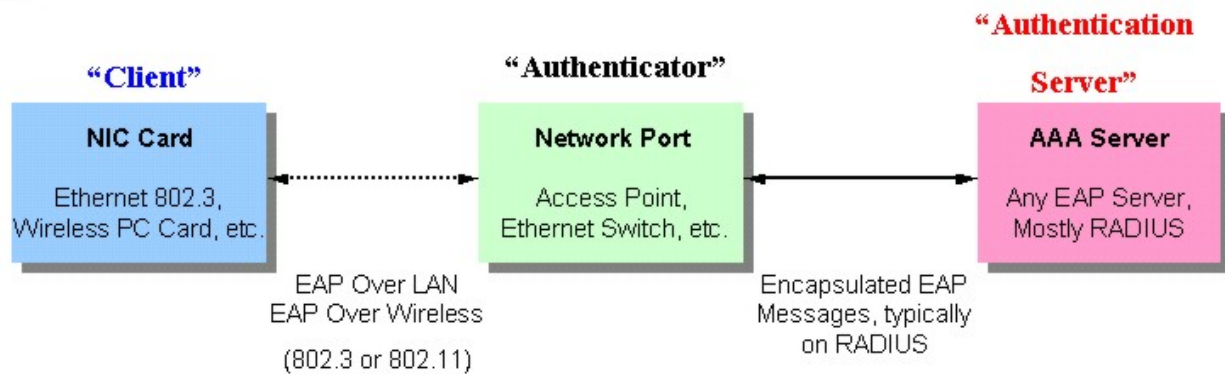

Figure 6- 88. Three Functions of 802.1x

The following section will explain Client, Authenticator, and Authentication Server in greater detail.

Authentication Server

The Authentication Server is a remote device that is connected to the same network as the Client and Authenticator, must be running a RADIUS Server program and must be configured properly on the Authenticator (Switch). The Authentication Server (RADIUS) must authenticate clients connected to a port on the Switch before attaining any services offered by the Switch on the LAN. The role of the Authentication Server is to certify the identity of the Client attempting to access the network by exchanging secure information between the RADIUS server and the Client through EAPOL packets and, in turn, informs the Switch whether or not the Client is granted access to the LAN and/or switch services.

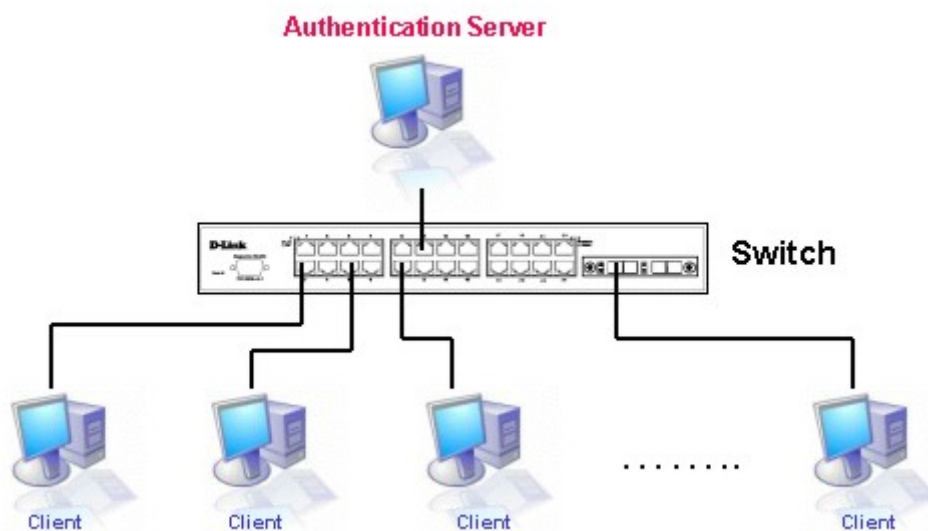

Figure 6- 89. Authentication Server

Authenticator

The Authenticator (the Switch) is an intermediary between the Authentication Server and the Client. The Authenticator serves two purposes when utilizing 802.1x. The first purpose is to request certification information from the Client through EAPOL packets, which is the only information allowed to pass through the Authenticator before access is granted to the Client. The second purpose of the Authenticator is to verify the information gathered from the Client with the Authentication Server, and to then relay that information back to the Client.

Three steps must be implemented on the Switch to properly configure the Authenticator.

1. The 802.1x State must be enabled. (**Configuration > Switch Information > Advanced Settings > 802.1x Status**)
2. The 802.1x settings must be implemented by port. (**Port Access Entity > PAE System Control > Port Capability > Capability**)
3. A RADIUS server must be configured on the Switch. (**Port Access Entity > RADIUS Server > Authentic RADIUS Server**)

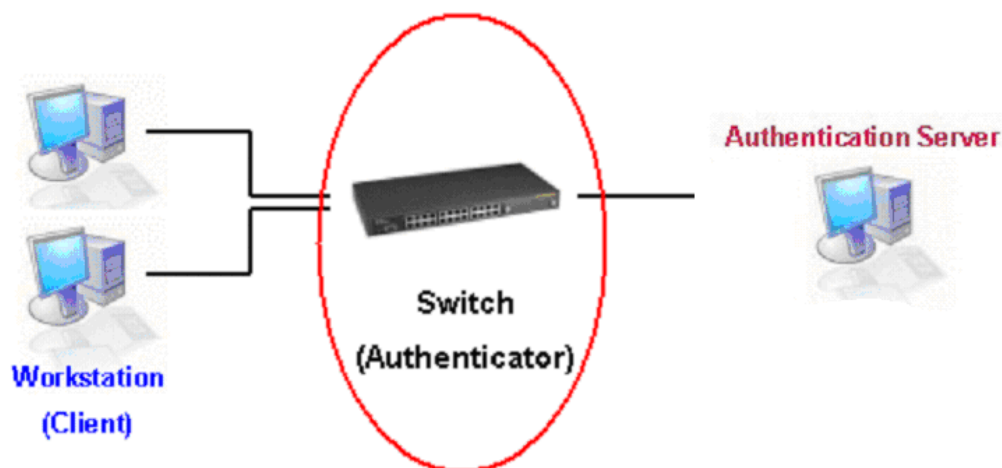

Figure 6- 90. Authenticator

Client

The Client is simply the workstation that wishes to gain access to the LAN or switch services. All workstation must be running software that is compliant with the 802.1x protocol. For users running Windows XP, that software is included within the operating system. All other users are required to attain 802.1x client software from an outside source. The Client will request access to the LAN and or Switch through EAPOL packets and, in turn will respond to requests from the Switch.

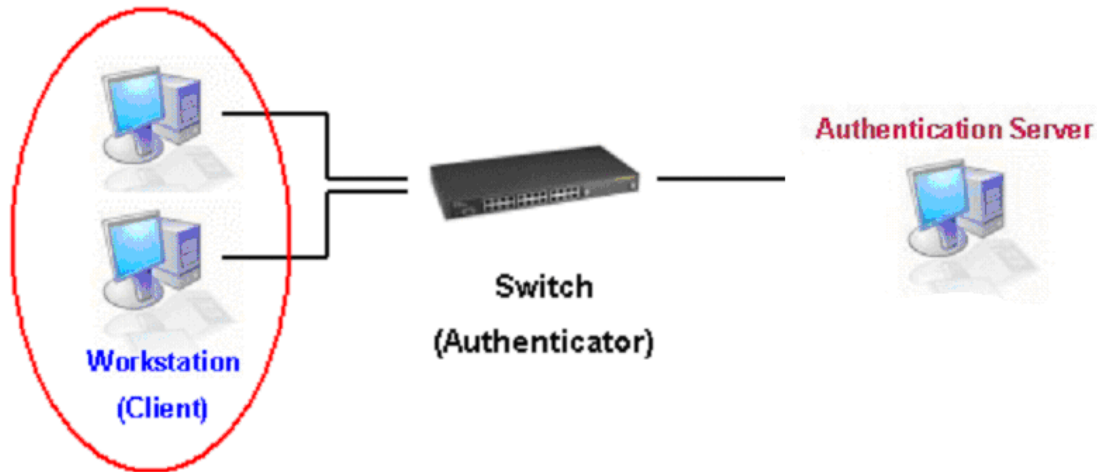

Figure 6- 91. Client

Authentication Process

Utilizing the three components stated above, the 802.1x protocol provides a stable and secure way of authorizing and authenticating users attempting to access the network. Only EAPOL traffic is allowed to pass through the specified port before a successful authentication is made. This port is “locked” until the point when a Client with the correct username and password (and MAC address if 802.1x is enabled by MAC address) is granted access and therefore successfully “unlocks” the port. Once unlocked, normal traffic is allowed to pass through the port. The D-Link implementation of 802.1x allows network administrators to choose between two types of Access Control used on the Switch, which are:

1. Port-Based Access Control – This method requires only one user to be authenticated per port by a remote RADIUS server to allow the remaining users on the same port access to the network.
2. MAC-Based Access Control – Using this method, the Switch will automatically learn up to sixteen MAC addresses by port and set them in a list. The Switch using a remote RADIUS server before being allowed access to the Network must authenticate each MAC address.

Port-Based Network Access Control

The original intent behind the development of 802.1x was to leverage the characteristics of point-to-point in LANs. Any single LAN segment in such an infrastructure has no more than two devices attached to it, one of which is a Bridge Port. The Bridge Port detects events that indicate the attachment of an active device at the remote end of the link, or an active device becoming inactive. These events can be used to control the authorization state of the Port and initiate the process of authenticating the attached device if the Port is unauthorized. This is the Port-Based Network Access Control.

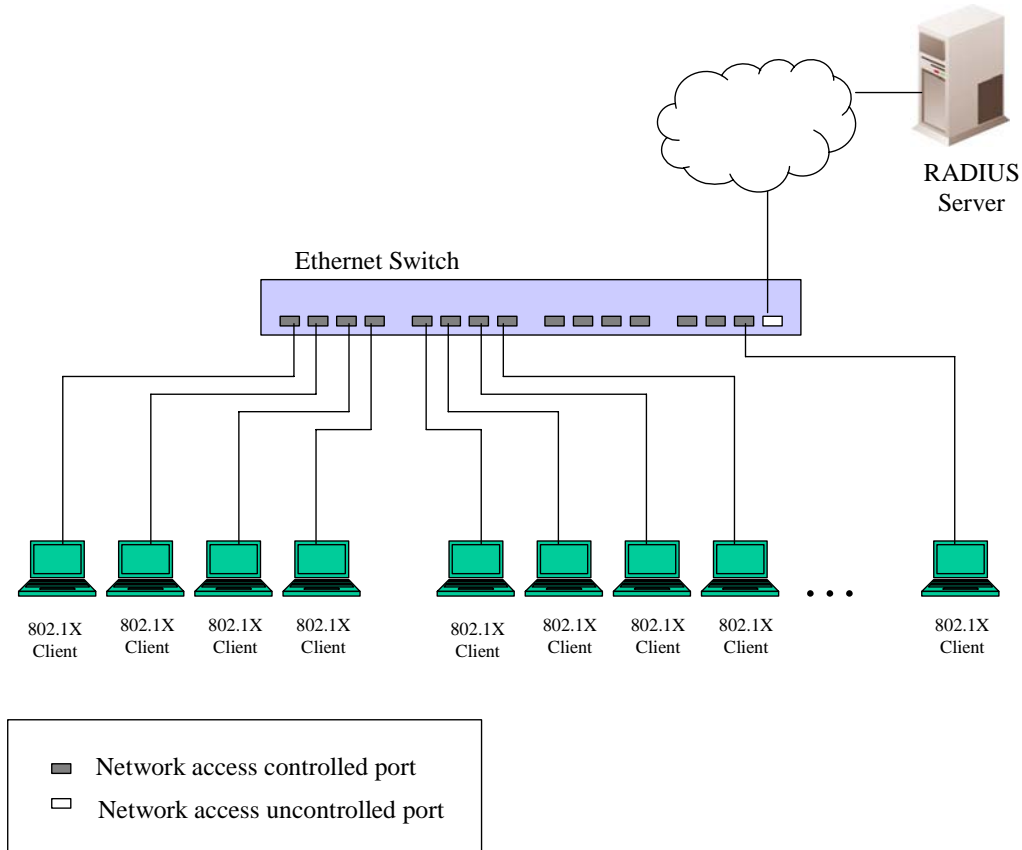

Figure 6- 92. Example of Typical Port-Based Configuration

Once the connected Client has successfully been authenticated, the Port then becomes Authorized, and all subsequent traffic on the Port is not subject to access control restriction until an event occurs that causes the Port to become Unauthorized. Hence, if the Port is actually connected to a shared media LAN segment with more than one attached device, successfully authenticating one of the attached devices effectively provides access to the LAN for all devices on the shared segment. Clearly, the security offered in this situation is open to attack.

MAC-Based Network Access Control

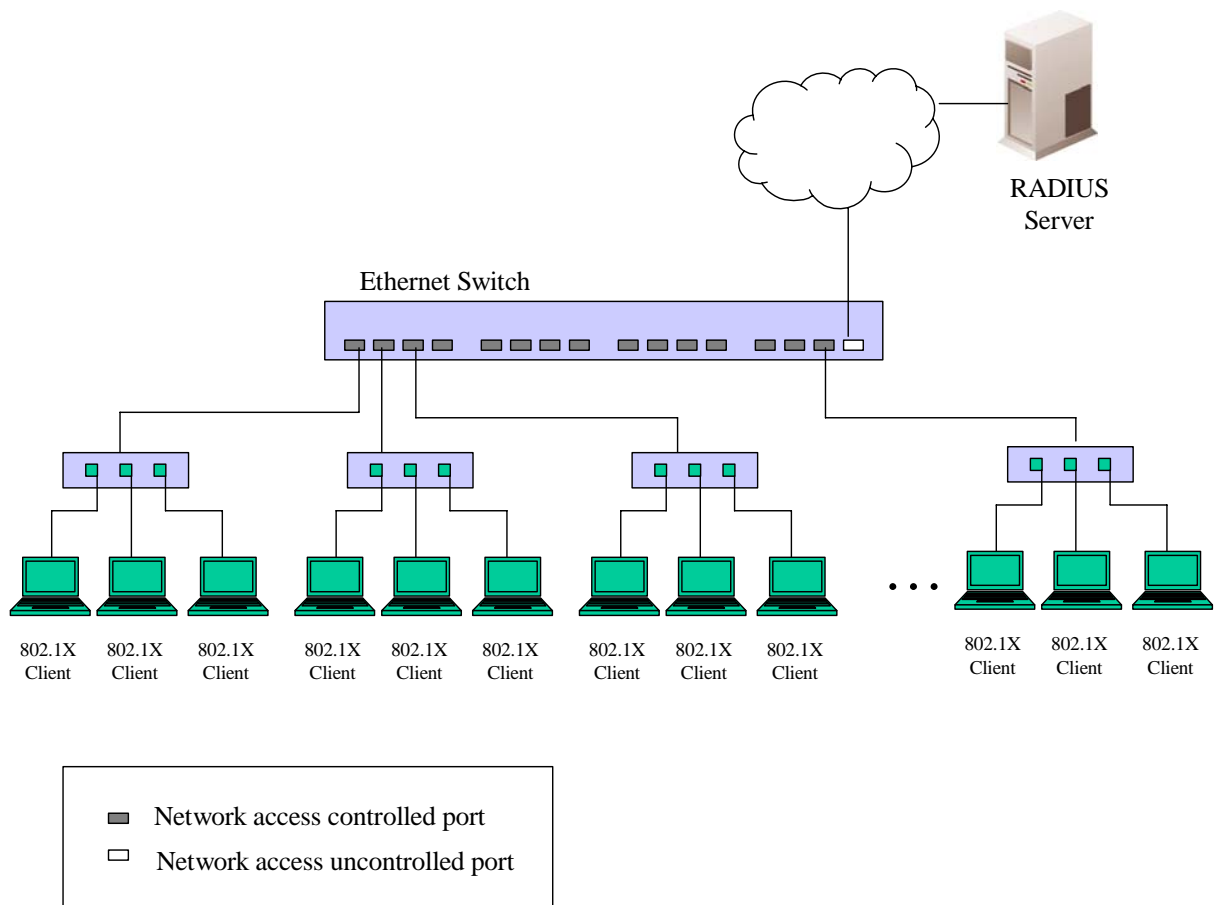

Figure 6- 93. Example of Typical MAC-Based Configuration

In order to successfully make use of 802.1x in a shared media LAN segment, it would be necessary to create “virtual” Ports, one for each attached device that required access to the LAN. The Switch would regard the single physical Port connecting it to the shared media segment as consisting of a number of distinct virtual Ports, each virtual Port being independently controlled from the point of view of EAPOL exchanges and authorization state. The Switch learns each attached device’s individual MAC address, and effectively creates a virtual Port that the attached device can then use to communicate with the LAN via the Switch.

Configure Authenticator

To configure the 802.1X Authenticator Settings, click **Port Access Entity** > **Configure Authenticator**:

802.1X Authenticator Settings										
Port	AdminCtrlDir	OperCtrlDir	Port Ctrl	TxPeriod	Quiet Period	Supp-Timeout	Server-Timeout	MaxReq	ReAuth Period	ReAuth Enabled
1	both	both	Auto	30	60	30	30	2	3600	No
2	both	both	Auto	30	60	30	30	2	3600	No
3	both	both	Auto	30	60	30	30	2	3600	No
4	both	both	Auto	30	60	30	30	2	3600	No
5	both	both	Auto	30	60	30	30	2	3600	No
6	both	both	Auto	30	60	30	30	2	3600	No
7	both	both	Auto	30	60	30	30	2	3600	No
8	both	both	Auto	30	60	30	30	2	3600	No
9	both	both	Auto	30	60	30	30	2	3600	No
10	both	both	Auto	30	60	30	30	2	3600	No
11	both	both	Auto	30	60	30	30	2	3600	No
12	both	both	Auto	30	60	30	30	2	3600	No
13	both	both	Auto	30	60	30	30	2	3600	No
14	both	both	Auto	30	60	30	30	2	3600	No
15	both	both	Auto	30	60	30	30	2	3600	No
16	both	both	Auto	30	60	30	30	2	3600	No
17	both	both	Auto	30	60	30	30	2	3600	No
18	both	both	Auto	30	60	30	30	2	3600	No
19	both	both	Auto	30	60	30	30	2	3600	No
20	both	both	Auto	30	60	30	30	2	3600	No
21	both	both	Auto	30	60	30	30	2	3600	No
22	both	both	Auto	30	60	30	30	2	3600	No
23	both	both	Auto	30	60	30	30	2	3600	No
24	both	both	Auto	30	60	30	30	2	3600	No
25	both	both	Auto	30	60	30	30	2	3600	No
26	both	both	Auto	30	60	30	30	2	3600	No

Figure 6-94. 802.1X Authenticator Settings window

To configure the settings by port, click on the hyperlinked port number under the Port heading, which will display the following table to configure:

802.1X Authenticator Settings	
From	Port 1
To	Port 1
AdminCtrlDir	both
PortControl	Auto
TxPeriod	30
QuietPeriod	60
Supp Timeout	30
Server Timeout	30
MaxReq	2
ReAuthPeriod	3600
ReAuth	Disabled
Show Authenticators Setting Apply	

Figure 6-95. 802.1X Authenticator Settings window (Modify)

This window allows you to set the following features:

Parameter	Description
From [] To []	Enter the port or ports to be set.
AdmCtrlDir	<p>Sets the administrative-controlled direction to either <i>in</i> or <i>both</i>.</p> <p>If <i>in</i> is selected, control is only exerted over incoming traffic through the port you selected in the first field.</p> <p>If <i>both</i> are selected, control is exerted over both incoming and outgoing traffic through the controlled port selected in the first field.</p>
PortControl	<p>This allows you to control the port authorization state.</p> <p>Select <i>forceAuthorized</i> to disable 802.1X and cause the port to transition to the authorized state without any authentication exchange required. This means the port transmits and receives normal traffic without 802.1X-based authentication of the client.</p> <p>If <i>forceUnauthorized</i> is selected, the port will remain in the unauthorized state, ignoring all attempts by the client to authenticate. The Switch cannot provide authentication services to the client through the interface.</p> <p>If <i>Auto</i> is selected, it will enable 802.1X and cause the port to begin in the unauthorized state, allowing only EAPOL frames to be sent and received through the port. The authentication process begins when the link state of the port transitions from down to up, or when an EAPOL-start frame is received. The Switch then requests the identity of the client and begins relaying authentication messages between the client and the authentication server.</p> <p>The default setting is <i>Auto</i>.</p>
TxPeriod	This sets the TxPeriod of time for the authenticator PAE state machine. This value determines the period of an EAP Request/Identity packet transmitted to the client. The default setting is 30 seconds.
QuietPeriod	This allows you to set the number of seconds that the Switch remains in the quiet state following a failed authentication exchange with the client. The default setting is 60 seconds.
SuppTimeout	This value determines timeout conditions in the exchanges between the Authenticator and the client. The default setting is 30 seconds.
ServerTimeout	This value determines timeout conditions in the exchanges between the Authenticator and the authentication server. The default setting is 30 seconds.
MaxReq	The maximum number of times that the Switch will retransmit an EAP Request to the client before it times out of the authentication sessions. The default setting is 2.
ReAuthPeriod	A constant that defines a nonzero number of seconds between periodic reauthentication of the client. The default setting is 3600 seconds.
ReAuth	Determines whether regular reauthentication will take place on this port. The default setting is <i>Disabled</i> .

Click **Apply** to implement your configuration changes. To view configurations for the 802.1X Authenticator Settings on a port-by-port basis, see the 802.1X Authenticator Settings table.

PAE System Control

Existing 802.1x port settings are displayed and can be configured using the windows below.

Port Capability

Click **Port Access Entity > PAE System Control > Port Capability** to view the following window:

802.1X Capability Settings			
From	To	Capability	Apply
Port 1	Port 1	None	Apply

802.1X Capability Table	
Port	Capability
1	None
2	None
3	None
4	None
5	None
6	None
7	None
8	None
9	None
10	None
11	None
12	None
13	None
14	None
15	None
16	None
17	None
18	None
19	None
20	None
21	None
22	None
23	None
24	None
25	None
26	None

Figure 6- 96. 802.1x Capability Settings window

To set up the Switch's 802.1x port-based authentication, select which ports are to be configured in the From and To fields. Next, enable the ports by selecting *Authenticator* from the drop-down menu under Capability. Click **Apply** to let your change take effect. Configure the following 802.1x capability settings:

Parameter	Description
From and To	Ports being configured for 802.1x settings.
Capability	Two role choices can be selected: <i>Authenticator</i> - A user must pass the authentication process to gain access to the network. <i>None</i> - The port is not controlled by the 802.1x functions.

Initializing Ports for Port Based 802.1x

Existing 802.1x port and MAC settings are displayed and can be configured using the window below. Click **Port Access Entity > PAE System Control > Initialize Port(s)** to open the following window:

Initialize Port				
From	To	Apply		
Port 1	Port 1	Apply		
Initialize Port Table				
Port	MAC Address	Auth PAE State	Backend State	PortStatus
1	---	N/A	N/A	Authorized
2	---	N/A	N/A	Authorized
3	---	N/A	N/A	Authorized
4	---	N/A	N/A	Authorized
5	---	N/A	N/A	Authorized
6	---	N/A	N/A	Authorized
7	---	N/A	N/A	Authorized
8	---	N/A	N/A	Authorized
9	---	N/A	N/A	Authorized
10	---	N/A	N/A	Authorized

Figure 6- 97. Initialize Port window

This window allows you to initialize a port or group of ports. The Initialize Port Table in the bottom half of the window displays the current status of the port(s).

This window displays the following information:

Parameter	Description
From and To	Select ports to be initialized.
Port	A read-only field indicating a port on the Switch.
MAC Address	The MAC address of the Switch connected to the corresponding port, if any.
Auth PAE State	The Authenticator PAE State will display one of the following: <i>Initialize, Disconnected, Connecting, Authenticating, Authenticated, Aborting, Held, ForceAuth, ForceUnauth,</i> and <i>N/A</i> .
Backend State	The Backend Authentication State will display one of the following: <i>Request, Response, Success, Fail, Timeout, Idle, Initialize,</i> and <i>N/A</i> .
Port Status	The status of the controlled port can be <i>Authorized, Unauthorized,</i> or <i>N/A</i> .

Initializing Ports for MAC Based 802.1x

To initialize ports for the MAC side of 802.1x, the user must first enable 802.1x by MAC address in the **Advanced Settings** window. Click **Configuration > Port Access Entity > PAE System Control > Initialize Port(s)** to open the following window:

Figure 6- 98. Initialize Port(s) window (MAC based 802.1x)

To initialize ports, first choose the range of ports in the From and To field. Then the user must specify the MAC address to be initialized by entering it into the MAC Address field and checking the corresponding check box. To begin the initialization, click **Apply**.



NOTE: The user must first globally enable 802.1X in the **Switch Information (Advanced Settings)** window in the **Configuration** folder before initializing ports. Information in the Initialize Ports Table cannot be viewed before enabling 802.1X.

Reauthenticate Port(s) for Port Based 802.1x

This window allows you to reauthenticate a port or group of ports by choosing a port or group of ports by using the pull down menus From and To and clicking **Apply**. The Reauthenticate Port Table displays the current status of the reauthenticated port(s) once you have clicked **Apply**.

Click **Configuration > Port Access Entity > PAE System Control > Reauthenticate Port(s)** to open the **Reauthenticate Port(s)** window:

Port	MAC Address	Auth State	BackendState	OperDir	PortStatus
1	---	N/A	N/A	both	Authorized
2	---	N/A	N/A	both	Authorized
3	---	N/A	N/A	both	Authorized
4	---	N/A	N/A	both	Authorized
5	---	N/A	N/A	both	Authorized
6	---	N/A	N/A	both	Authorized
7	---	N/A	N/A	both	Authorized
8	---	N/A	N/A	both	Authorized
9	---	N/A	N/A	both	Authorized
10	---	N/A	N/A	both	Authorized

Figure 6- 99. Reauthenticate Port window

This window displays the following information:

Parameter	Description
Port	The port number of the reauthenticated port.
MAC Address	Displays the physical address of the Switch where the port resides.
Auth State	The Authenticator State will display one of the following: <i>Initialize, Disconnected, Connecting, Authenticating, Authenticated, Aborting, Held, ForceAuth, ForceUnauth, and N/A.</i>
BackendState	The Backend State will display one of the following: <i>Request, Response, Success, Fail, Timeout, Idle, Initialize, and N/A.</i>
OpenDir	Operational Controlled Directions are <i>both</i> and <i>in</i> .
PortStatus	The status of the controlled port can be <i>Authorized, Unauthorized, or N/A.</i>

RADIUS Server

The RADIUS feature of the Switch allows you to facilitate centralized user administration as well as providing protection against a sniffing, active hacker. The Web Manager offers three windows.

Click **Port Access Entity > RADIUS Server > Authentic RADIUS Server** to open the **RADIUS Server Authentication Setting** window shown below:

Figure 6- 100. RADIUS Server Authentication Setting window

This window displays the following information:

Parameter	Description
Succession	Choose the desired RADIUS server to configure: <i>First, Second</i> or <i>Third</i> .
RADIUS Server	Set the RADIUS server IP.
Authentic Port	Set the RADIUS authentic server(s) UDP port. The default port is 1812.
Accounting Port	Set the RADIUS account server(s) UDP port. The default port is 1813.
Key	Set the key the same as that of the RADIUS server.
Confirm Key	Confirm the shared key is the same as that of the RADIUS server.
Accounting Method	This allows you to <i>Add/Modify</i> or <i>Delete</i> the RADIUS Server.

Guest VLANs

On 802.1x security enabled networks, there is a need for non 802.1x supported devices to gain limited access to the network, due to lack of the proper 802.1x software or incompatible devices, such as computers running Windows 98 or lower operating systems, or the need for guests to gain access to the network without full authorization. To supplement these circumstances, this switch now implements Guest 802.1x VLANs. These VLANs should have limited access rights and features separate from other VLANs on the network.

To implement Guest 802.1x VLANs, the user must first create a VLAN on the network with limited rights and then enable it as an 802.1x guest VLAN. Then the administrator must configure the guest accounts accessing the Switch to be placed in a Guest VLAN when trying to access the Switch. Upon initial entry to the Switch, the client wishing services on the Switch will need to be authenticated by a remote RADIUS Server or local authentication on the Switch to be placed in a fully operational VLAN. If authenticated and the authenticator possesses the VLAN placement information, that client will be accepted into the fully operational target VLAN and normal switch functions will be open to the client. If the authenticator does not have target VLAN placement information, the client will be returned to its originating VLAN. Yet, if the client is denied authentication by the authenticator, it will be placed in the Guest VLAN where it has limited rights and access. The adjacent figure should give the user a better understanding of the Guest VLAN process.

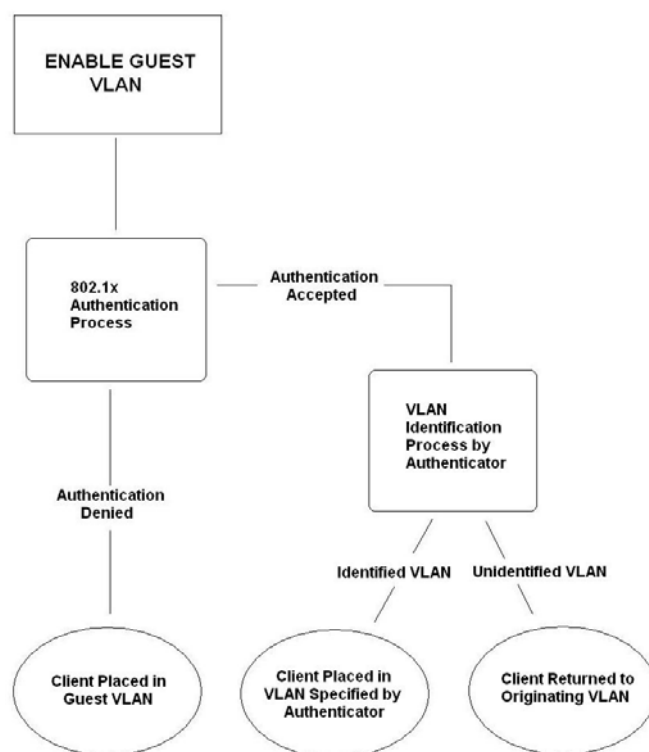

Figure 6- 101 Guest VLAN Authentication Process

Limitations Using the Guest VLAN

1. Guest VLANs are only supported for port-based VLANs. MAC-based VLANs cannot undergo this procedure.
2. Ports supporting Guest VLANs cannot be GVRP enabled and vice versa.
3. A port cannot be a member of a Guest VLAN and a static VLAN simultaneously.
4. Once a client has been accepted into the target VLAN, it can no longer access the Guest VLAN.
5. If a port is a member of multiple VLANs, it cannot become a member of the Guest VLAN.

Guest VLAN Configuration

In the **Security** menu, open the **802.1X** folder and click **Guest VLAN**, which will display the following window for the user to configure. Remember, to set a guest 802.1x VLAN, the user must first configure a normal VLAN which can be enabled here for Guest VLAN status.

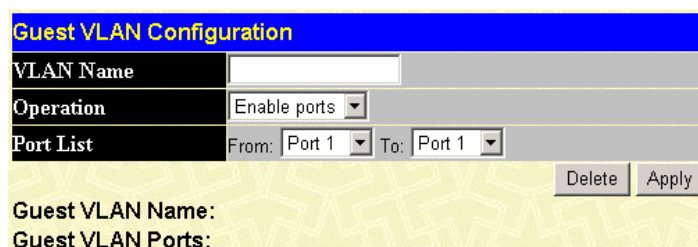

Figure 6- 102 Guest VLAN Configuration window

The following fields may be modified to enable the guest 802.1x VLAN:

Parameter	Description
VLAN Name	Enter the pre-configured VLAN name to create as a guest 802.1x VLAN.
Operation	Allows the user to enable or disable ports for the guest 802.1x VLAN, using the Port List stated below.
Port List	Set the port list of ports to be enabled or disabled for the guest 802.1x VLAN using the pull down menus.

Click **Apply** to implement the guest 802.1x VLAN. Once properly configured, the **Guest VLAN Name** and associated ports will be listed in the lower part of the window, as seen in the example above.



NOTE: For more information and configuration examples for the 802.1X Guest VLAN function, please refer to the Guest VLAN Configuration Example located on the D-Link website.

IP-MAC Binding

The IP network layer uses a four-byte address. The Ethernet link layer uses a six-byte MAC address. Binding these two address types together allows the transmission of data between the layers. The primary purpose of IP-MAC binding is to restrict the access to a switch to a number of authorized users. Only the authorized client can access the Switch's port by checking the pair of IP-MAC addresses with the pre-configured database. If an unauthorized user tries to access an IP-MAC binding enabled port, the system will block the access by dropping its packet. The maximum number of IP-MAC binding entries is dependant on chip capability (e.g. the ARP table size) and storage size of the device. For the xStack DES-3500 Series switches, the maximum number of IP-MAC Binding entries is 512. The creation of authorized users can be manually configured by CLI or Web. The function is port-based, meaning a user can enable or disable the function on the individual port.

ACL Mode

Due to some special cases that have arisen with the IP-MAC binding, this Switch has been equipped with a special ACL Mode for IP-MAC Binding, which should alleviate this problem for users. When enabled in the **IP-MAC Binding Port** window, the Switch will create two entries in the Access Profile Table as shown below. The entries may only be created if there are at least two Access Profile IDs available on the Switch. If not, when the ACL Mode is enabled, an error message will be prompted to the user. When the ACL Mode is enabled, the Switch will only accept IP packets from a created entry in the IP-MAC Binding Setting window. All others will be discarded.

To view the particular configurations associated with these two entries, click their corresponding hyperlinked Profile IDs, which will display the following:

Access Profile Entry Display	
Profile ID	2
Type	Packet Content Mask
Offset	Offset (0 - 15) mask:0x00000000 mask:0x0000ffff mask:0xffff mask:0x00000000
	Offset (16 - 31) mask:0x00000000 mask:0x00000000 mask:0x00000000 mask:0x0000ffff
	Offset (32 - 47) mask:0xffff0000 mask:0x00000000 mask:0x00000000 mask:0x00000000
	Offset (48 - 63) mask:0x00000000 mask:0x00000000 mask:0x00000000 mask:0x00000000
	Offset (64 - 79) mask:0x00000000 mask:0x00000000 mask:0x00000000 mask:0x00000000

Access Profile Entry Display	
Profile ID	3
Type	Packet Content Mask
Offset	Offset (0 - 15) mask:0x00000000 mask:0x00000000 mask:0x00000000 mask:0x00000000
	Offset (16 - 31) mask:0xffff0000 mask:0x00000000 mask:0x00000000 mask:0x00000000
	Offset (32 - 47) mask:0x00000000 mask:0x00000000 mask:0x00000000 mask:0x00000000
	Offset (48 - 63) mask:0x00000000 mask:0x00000000 mask:0x00000000 mask:0x00000000
	Offset (64 - 79) mask:0x00000000 mask:0x00000000 mask:0x00000000 mask:0x00000000

Figure 6- 103. Access Profile Entry Display for IP-MAC ACL Mode Enabled Entries

These two entries cannot be modified or deleted using the Access Profile Table, and any attempt to do so will result in the following warning message:



Figure 6- 104. IP-MAC ACL Mode warning

The user may only remove these two entries by disabling the ACL Mode in the IP-MAC Binding Port window.

Also, rules will be created for every port on the Switch. To view the ACL rule configurations set for the ACL mode, click the corresponding **Modify** button of the entry in the **Access Profile Table**, which will produce an **Access Rule Table** as the next following figure shows. Note that the option, **Flow Meter**, is only available to be configured for ACL owner.

Add		Clear All			
Free ACL Rules Table					
System	Port 1-8	Port 9-16	Port 17-24	Port 25	Port 26
794	194	200	200	100	100
Access Profile Table					
Profile ID	Type	Owner	Access Rule	Delete	
1	Ethernet	ACL	<input type="button" value="Modify"/>	<input type="button" value="X"/>	
2	IP	ACL	<input type="button" value="Modify"/>	<input type="button" value="X"/>	
3	Packet Content Mask	ACL	<input type="button" value="Modify"/>	<input type="button" value="X"/>	
4	Packet Content Mask	Address_binding	<input type="button" value="Modify"/>	<input type="button" value="X"/>	
5	Packet Content Mask	Address_binding	<input type="button" value="Modify"/>	<input type="button" value="X"/>	

Figure 6- 105. Access Profile Table for IP-MAC Binding rule



NOTE: When configuring the ACL mode function of the IP-MAC binding function, please pay close attention to previously set ACL entries. Since the ACL mode entries will fill the first two available access profiles and access profile IDs denote the ACL priority, the ACL mode entries may take precedence over other configured ACL entries. This may render some user-defined ACL parameters inoperable due to the overlapping of settings combined with the ACL entry priority (defined by profile ID). For more information on ACL settings, please see “Configuring the Access Profile” section mentioned previously in this chapter.



NOTE: Once ACL profiles have been created by the Switch through the IP-MAC binding function, the user cannot modify, delete or add ACL rules to these ACL mode access profile entries. Any attempt to modify, delete or add ACL rules will result in a configuration error as seen in the previous figure.



NOTE: When uploading configuration files to the Switch, be aware of the ACL configurations loaded, as compared to the ACL mode access profile entries set by this function, which may cause both access profile types to experience problems.

The user may view the configurations on a port-by-port basis by clicking the **View** button under the Display heading of the corresponding port entry. These entries cannot be modified or deleted, and new rules cannot be added. Yet, these windows will offer vital information to the user when configuring other access profile entries. Click **Next** to view the next page of rules. The user may also search for an entry by **Access ID** by entering that ID into the field and clicking **Find**.

Access ID Find

Access Rule Table							
Profile ID	Mode	Type	Access ID	Owner	Display	Flow Meter	Delete
4	Permit	Packet Content Mask	1	Address_binding	<input type="button" value="View"/>		<input type="button" value="X"/>
4	Permit	Packet Content Mask	2	Address_binding	<input type="button" value="View"/>		<input type="button" value="X"/>
4	Permit	Packet Content Mask	3	Address_binding	<input type="button" value="View"/>		<input type="button" value="X"/>
4	Permit	Packet Content Mask	4	Address_binding	<input type="button" value="View"/>		<input type="button" value="X"/>
4	Permit	Packet Content Mask	5	Address_binding	<input type="button" value="View"/>		<input type="button" value="X"/>
4	Permit	Packet Content Mask	6	Address_binding	<input type="button" value="View"/>		<input type="button" value="X"/>
4	Permit	Packet Content Mask	7	Address_binding	<input type="button" value="View"/>		<input type="button" value="X"/>
4	Permit	Packet Content Mask	8	Address_binding	<input type="button" value="View"/>		<input type="button" value="X"/>
4	Permit	Packet Content Mask	9	Address_binding	<input type="button" value="View"/>		<input type="button" value="X"/>
4	Permit	Packet Content Mask	10	Address_binding	<input type="button" value="View"/>		<input type="button" value="X"/>
4	Permit	Packet Content Mask	11	Address_binding	<input type="button" value="View"/>		<input type="button" value="X"/>
4	Permit	Packet Content Mask	12	Address_binding	<input type="button" value="View"/>		<input type="button" value="X"/>
4	Permit	Packet Content Mask	13	Address_binding	<input type="button" value="View"/>		<input type="button" value="X"/>
4	Permit	Packet Content Mask	14	Address_binding	<input type="button" value="View"/>		<input type="button" value="X"/>
4	Permit	Packet Content Mask	15	Address_binding	<input type="button" value="View"/>		<input type="button" value="X"/>
4	Permit	Packet Content Mask	16	Address_binding	<input type="button" value="View"/>		<input type="button" value="X"/>
4	Permit	Packet Content Mask	17	Address_binding	<input type="button" value="View"/>		<input type="button" value="X"/>
4	Permit	Packet Content Mask	18	Address_binding	<input type="button" value="View"/>		<input type="button" value="X"/>
4	Permit	Packet Content Mask	19	Address_binding	<input type="button" value="View"/>		<input type="button" value="X"/>
4	Permit	Packet Content Mask	20	Address_binding	<input type="button" value="View"/>		<input type="button" value="X"/>

[Show All Access Profile Entries](#)

Figure 6- 106 Access Rule Table for IP-MAC Binding rule (Modify)

IP-MAC Binding Port

To enable or disable IP-MAC binding on specific ports, click **IP-MAC Binding Port** in the **IP-MAC Binding** folder on the **Configuration Menu** to open the **IP-MAC Binding Ports Setting** window. Select a port or a range of ports with the **From** and **To** fields. Enable or disable the port with the **State** field. Enable or disable zero IP address with the **Allow Zero IP** field. The user may also enable the ACL Mode for IP-MAC Binding which will create two Access Profile Entries on the Switch, as previously stated. Click **Apply** to save changes.

IP-MAC Binding Mode

ACL Mode Disable ▾

Trap/Log

State Disable ▾

IP-MAC Binding Ports Setting

From	To	State	Allow Zero IP	Apply
Port 1 ▾	Port 1 ▾	Disabled ▾	Disabled ▾	<input type="button" value="Apply"/>

IP-MAC Binding Port State Table

Port	State	Allow Zero IP	Port	State	Allow Zero IP
1	Disabled	Disabled	14	Disabled	Disabled
2	Disabled	Disabled	15	Disabled	Disabled
3	Disabled	Disabled	16	Disabled	Disabled
4	Disabled	Disabled	17	Disabled	Disabled
5	Disabled	Disabled	18	Disabled	Disabled
6	Disabled	Disabled	19	Disabled	Disabled
7	Disabled	Disabled	20	Disabled	Disabled
8	Disabled	Disabled	21	Disabled	Disabled
9	Disabled	Disabled	22	Disabled	Disabled
10	Disabled	Disabled	23	Disabled	Disabled
11	Disabled	Disabled	24	Disabled	Disabled
12	Disabled	Disabled	25	Disabled	Disabled

Figure 6- 107. IP-MAC Binding Ports window

IP-MAC Binding Table

The window shown below can be used to create IP-MAC binding entries. Click the **IP-MAC Binding Table** on the **IP-MAC Binding** folder on the **Configuration** menu to view the **IP-MAC Binding Setting** window. Enter the IP and MAC addresses of the authorized users in the appropriate fields and click **Add**. To modify either the IP address or the MAC address of the binding entry, make the desired changes in the appropriate field and Click **Modify**. To find an IP-MAC binding entry, enter the IP and MAC addresses and click **Find**. To delete an entry click **Delete**. To clear all the entries from the table click **Delete All**.

IP-MAC Binding Setting													
IP Address	0.0.0.0												
MAC Address	00-00-00-00-00-00												
All Ports	<input checked="" type="checkbox"/>												
Ports	1	2	3	4	5	6	7	8	9	10	11	12	13
	<input type="checkbox"/>	<input type="checkbox"/>	<input type="checkbox"/>	<input type="checkbox"/>	<input type="checkbox"/>	<input type="checkbox"/>	<input type="checkbox"/>	<input type="checkbox"/>	<input type="checkbox"/>	<input type="checkbox"/>	<input type="checkbox"/>	<input type="checkbox"/>	<input type="checkbox"/>
Ports	14	15	16	17	18	19	20	21	22	23	24	25	26
	<input type="checkbox"/>	<input type="checkbox"/>	<input type="checkbox"/>	<input type="checkbox"/>	<input type="checkbox"/>	<input type="checkbox"/>	<input type="checkbox"/>	<input type="checkbox"/>	<input type="checkbox"/>	<input type="checkbox"/>	<input type="checkbox"/>	<input type="checkbox"/>	<input type="checkbox"/>
Mode	ACL												
<input type="button" value="Add"/> <input type="button" value="Modify"/> <input type="button" value="Find"/> <input type="button" value="Delete All"/>													
Total Entries: 1													
IP-MAC Binding Table													
IP Address	MAC Address	Port	Mode	Delete									
10.0.25.100	00-15-f2-b5-73-32	1-26	ACL	<input type="button" value="X"/>									

Figure 6- 108. IP-MAC Binding Table window

The following fields can be set or modified:

Parameter	Description
IP Address	Enter the IP address you wish to bind to the MAC address set below.
MAC Address	Enter the MAC address you wish to bind to the IP Address set above.
All Ports	Click this check box to configure this IP-MAC binding entry (IP Address + MAC Address) for all ports on the Switch.
Ports	Specify the switch ports for which to configure this IP-MAC binding entry (IP Address + MAC Address).
Mode	<p>The user may set the IP-MAC Binding Mode here by using the pull-down menu. The choices are:</p> <p><i>ARP</i> – Choosing this selection will set a normal IP-Mac Binding entry for the IP address and MAC address entered.</p> <p><i>ACL</i> – Choosing this entry will allow only packets from the source IP-MAC binding entry created here. All other packets with a different IP address will be discarded by the Switch. This mode can only be used if the ACL Mode has been enabled in the IP-MAC Binding Ports window as seen previously.</p>

IP-MAC Binding Blocked

To view unauthorized devices that have been blocked by IP-MAC binding restrictions open the **IP-MAC Binding Blocked** window show below. Click **IP-MAC Binding Blocked** in the **IP-MAC Blocked** folder on the **Configuration** menu to open the **IP-MAC Binding Blocked** window.

The screenshot shows the 'IP-MAC Binding Blocked' window. At the top, there is a search area with a 'VLAN Name' field (empty) and a 'MAC Address' field containing '00-00-00-00-00-00'. Below these fields are 'Find' and 'Delete All' buttons. A status bar indicates 'Total Entries: 21'. The main area contains a table titled 'IP-MAC Binding Blocked Table' with the following data:

VID	VLAN NAME	MAC Address	Delete
1	default	00-03-09-18-10-01	X
1	default	00-03-44-ae-bc-12	X
1	default	00-07-e9-13-8f-50	X
1	default	00-0c-6e-55-bc-82	X
1	default	00-0c-f8-20-90-01	X
1	default	00-0c-f8-41-c0-01	X
1	default	00-0c-f8-42-40-01	X
1	default	00-0c-f8-44-10-01	X
1	default	00-0d-60-8f-49-38	X
1	default	00-50-ba-10-d8-eb	X
1	default	00-50-ba-da-01-58	X
1	default	00-50-ba-da-02-3e	X
1	default	00-50-ba-da-04-1f	X
1	default	00-80-c8-2e-c7-4c	X
1	default	00-80-c8-3b-ef-32	X
1	default	00-80-c8-4c-69-f8	X
1	default	00-80-c8-92-2d-58	X
1	default	00-80-c8-92-67-9f	X
1	default	00-e0-18-45-c7-15	X
1	default	00-e0-18-70-b3-b4	X

At the bottom right of the window is a 'Next' button.

Figure 6- 109. IP-MAC Binding Blocked window

To find an unauthorized device that has been blocked by the IP-MAC binding restrictions, enter the **VLAN** name and **MAC Address** in the appropriate fields and click **Find**. To delete an entry click the delete button next to the entry's MAC address. To delete all the entries in the **IP-MAC Binding Blocked Table** click **Delete All**.

Limited IP Multicast Range

The **Limited IP Multicast Range** window allows the user to specify which multicast address(es) reports are to be received on specified ports on the switch. This function will therefore limit the number of reports received and the number of multicast groups configured on the Switch. The user may set an IP address or range of IP addresses to accept reports (Permit) or deny reports (Deny) coming into the specified switch ports.

Limited IP Multicast Range Profile Setting

First of all, you have to create a multicast address profile, click **Configuration > Limited IP Multicast Range** to open the **Limited IP Multicast Range Profile Settings** window shown below. Then specify multicast ranges of multicast addresses in the profile by entering the lowest and highest multicast IP addresses of the range into **From Multicast IP** and **To Multicast IP** fields. Click **Apply** to implement the setting. The new multicast range profile will be listed in **The Port Information Table**. To remove the existing profile from **The Port Information Table** list, click the corresponding  button under “Delete” heading.

Limited IP Multicast Range Setting			
Name	From Multicast IP	To Multicast IP	Apply
<input type="text"/>	<input type="text" value="0.0.0.0"/>	<input type="text" value="0.0.0.0"/>	<input type="button" value="Apply"/>

The Port Information Table				
Number	Name	From Multicast IP	To Multicast IP	Delete
1	M-Range-1	224.0.0.0	239.0.0.0	

Figure 6- 110. Limited Multicast Range Profile Settings window

Parameter	Description
Name	Enter a meaningful description for the profile.
From Multicast IP	Enter the lowest multicast IP address of the range.
To Multicast IP	Enter the highest multicast IP address of the range.

Limited IP Multicast Range Status Setting

After Multicast Range Profiles are created, you may start to configure the multicast address filtering function on a port or a range of ports by configuring **Limited IP Multicast Range Status** window as below. To enter the following window, click **Configuration > Limited IP Multicast Range** to open the **Limited IP Multicast Range Status Settings** window.

Limited IP Multicast Range Status

From	To	State	Access	Apply
Port 1 ▾	Port 1 ▾	Disabled ▾	Permit ▾	Apply

The Port Information Table

Port	State	Access
1	Disabled	Deny
2	Disabled	Deny
3	Disabled	Deny
4	Disabled	Deny
5	Disabled	Deny
6	Disabled	Deny
7	Disabled	Deny
8	Disabled	Deny
9	Disabled	Deny
10	Disabled	Deny
11	Disabled	Deny
12	Disabled	Deny
13	Disabled	Deny
14	Disabled	Deny
15	Disabled	Deny
16	Disabled	Deny
17	Disabled	Deny
18	Disabled	Deny
19	Disabled	Deny
20	Disabled	Deny
21	Disabled	Deny
22	Disabled	Deny
23	Disabled	Deny
24	Disabled	Deny
25	Disabled	Deny
26	Disabled	Deny

Figure 6- 111 Limited Multicast Range Status Settings window

Parameter	Description
From...To	Select a port or group of ports using the pull-down menus.
State	Toggle the State field to either <i>Enabled</i> or <i>Disabled</i> a given port or group of ports where access is to be either permitted or denied.
Access	Two options are available: <i>Permint</i> and <i>Deny</i> . The default mode is <i>Permit</i> . <i>Permint</i> specifies that the packet that match the addresses defined in the profiles will be permitted. <i>Deny</i> specifies that the packet that match the addresses defined in the profiles will be denied.

Click **Apply** to implement the configuration.

Limited IP Multicast Range Setting

To specify a port or a range of ports to a mulctast range, click **Configuration > Limited IP Multicast Range** to open the **Limited IP Multicast Range Settings** window as below.

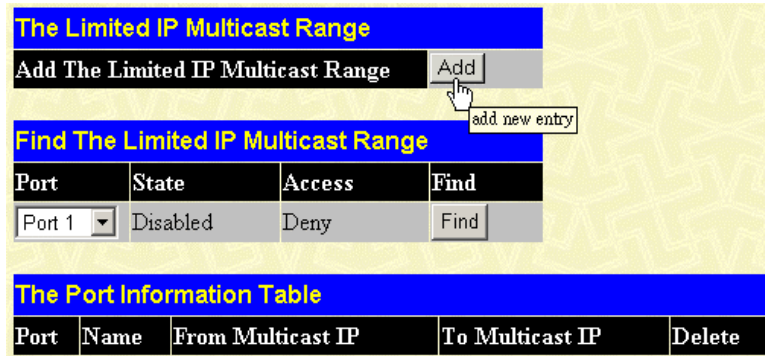

Figure 6- 112 Limited Multicast Range Settings window

Then click **Add** button to open the next following window – **Limited IP Multicast Range Setting**. Using **From** and **To** pull-down menus to designate a port or a range of ports, and enter an existing multicast range profile name, which was created in the **Limited IP Multicast Range Profile Settings** window, in the **Name of Multicast Range** field, then click **Apply** button to implement the setting.

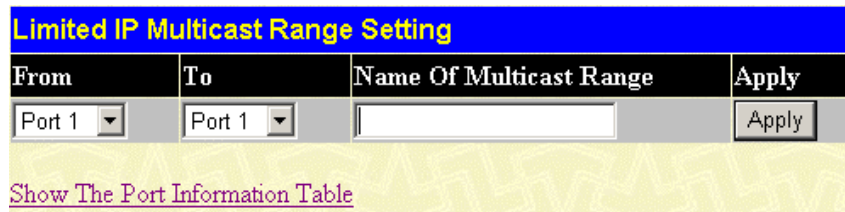
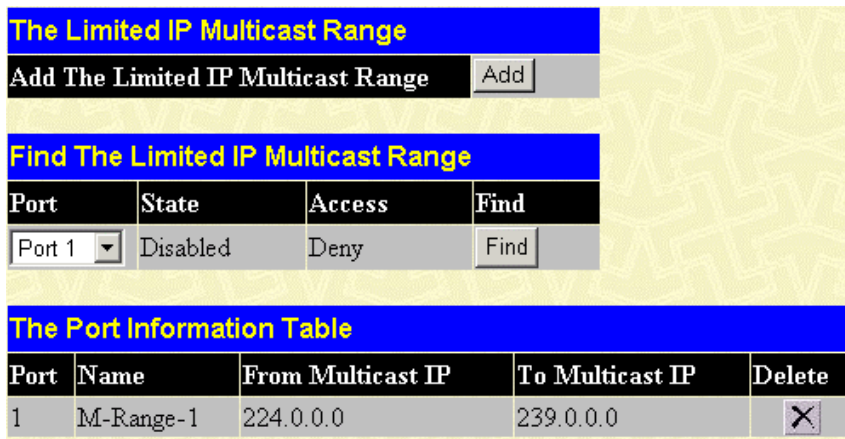

Figure 6- 113 Limited Multicast Range Settings window (Add)

The **Limited IP Multicast Range** window allows you to show multicast address range by ports. Using **Port** pull-down men to select a desired port number and click **Find** button, then the detail information will be listed in **The Port Information Table**. To remove the crrent configuration, click the corresponding **X** button under “Delete” heading.



Layer 3 IP Networking

Static ARP Table

The Address Resolution Protocol (ARP) is a TCP/IP protocol that converts IP addresses into physical addresses. This table allows network managers to view, define, modify and delete ARP information for specific devices.

Static entries can be defined in the ARP Table. When static entries are defined, a permanent entry is entered and is used to translate IP address to MAC addresses.

To open the **Static ARP Table** open the **Configuration** folder, and then open the **Layer 3 IP Networking** folder and click on the **Static ARP Table** link.

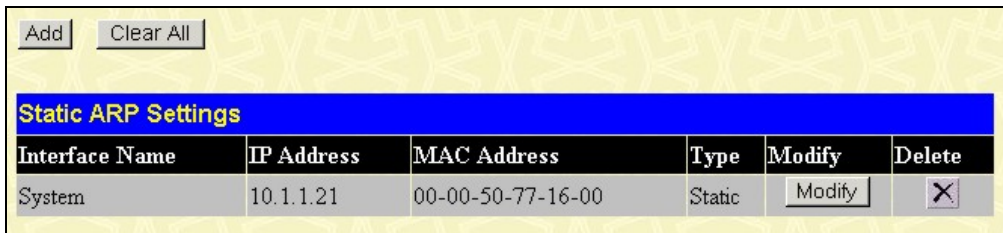

Figure 6- 114. Static ARP Settings window

To add a new entry, click the **Add** button, revealing the following window to configure:

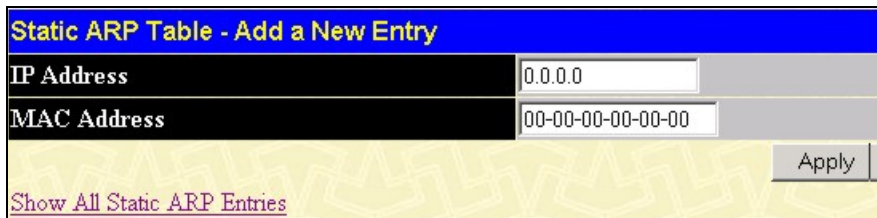

Figure 6- 115. Static ARP Table – Add a New Entry window

To modify an entry, click the **Modify** button, revealing the following window to configure:

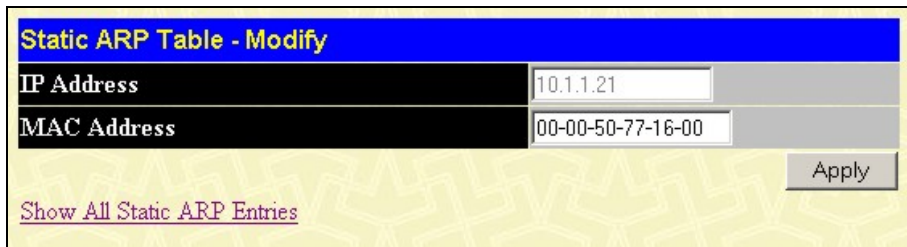

Figure 6- 116. Static ARP Table - Modify

The following fields can be set:

Parameter	Description
IP Address	The IP address of the ARP entry.
MAC Address	The MAC address of the ARP entry.

After entering the IP Address and MAC Address of the Static ARP entry, click **Apply** to implement the new entry. To completely clear the Static ARP Settings, click the **Clear All** button.



NOTE: The Switch supports up to 255 static ARP entries.

DHCP/BOOTP Relay

The relay hops count limit allows the maximum number of hops (routers) that the DHCP/BOOTP messages can be relayed through to be set. If a packet's hop count is more than the hop count limit, the packet is dropped. The range is between 1 and 16 hops, with a default value of 4. The relay time threshold sets the minimum time (in seconds) that the Switch will wait before forwarding a BOOTREQUEST packet. If the value in the seconds field of the packet is less than the relay time threshold, the packet will be dropped. The range is between 0 and 65,536 seconds, with a default value of 0 seconds.

DHCP / BOOTP Relay Global Settings

To enable and configure DHCP/BOOTP Relay Global Settings on the Switch, click **Configuration > Layer 3 Networking > DHCP/BOOTP Relay > DHCP/BOOTP Relay Global Settings**:

DHCP/BOOTP Relay Global Settings	
BOOTP Relay State	Disabled
BOOTP Relay Hops Count Limit (1-16)	4
BOOTP Relay Time Threshold (0-65535)	0
DHCP Relay Agent Information Option 82 State	Disabled
DHCP Relay Agent Information Option 82 Check	Disabled
DHCP Relay Agent Information Option 82 Policy	Replace
Apply	

Figure 6- 117. DHCP/ BOOTP Relay Global Settings window

The following fields can be set:

Parameter	Description
Relay State	This field can be toggled between <i>Enabled</i> and <i>Disabled</i> using the pull-down menu. It is used to enable or disable the DHCP/BOOTP Relay service on the Switch. The default is <i>Disabled</i> .
Relay Hops Count Limit (1-16)	This field allows an entry between 1 and 16 to define the maximum number of router hops DHCP/BOOTP messages can be forwarded across. The default hop count is 4.
Relay Time Threshold (0-65535)	Allows an entry between 0 and 65535 seconds, and defines the maximum time limit for routing a DHCP/BOOTP packet. If a value of 0 is entered, the Switch will not process the value in the seconds field of the BOOTP or DHCP packet. If a non-zero value is entered, the Switch will use that value, along with the hop count to determine whether to forward a given BOOTP or DHCP packet.
DHCP Agent Information Option 82 State	<p>This field can be toggled between <i>Enabled</i> and <i>Disabled</i> using the pull-down menu. It is used to enable or disable the DHCP Agent Information Option 82 on the Switch. The default is <i>Disabled</i>.</p> <p><i>Enabled</i> –When this field is toggled to <i>Enabled</i> the relay agent will insert and remove DHCP relay information (option 82 field) in messages between DHCP servers and clients. When the relay agent receives the DHCP request, it adds the option 82 information, and the IP address of the relay agent (if the relay agent is configured), to the packet. Once the option 82 information has been added to the packet it is sent on to the DHCP server. When the DHCP server receives the packet, if the server is capable of option 82, it can implement policies like restricting the number of IP addresses that can be assigned to a single remote ID or circuit ID. Then the DHCP server echoes the option 82 field in the DHCP reply. The DHCP server unicasts the reply to the back to the relay agent if the request was relayed to the server by the relay agent. The switch verifies that it originally inserted the option 82 data. Finally, the relay agent removes the option 82 field and forwards the packet to the switch port that connects to the DHCP client that sent the DHCP request.</p> <p><i>Disabled</i>- If the field is toggled to <i>Disabled</i> the relay agent will not insert and remove DHCP relay information (option 82 field) in messages between DHCP servers and clients, and the check and policy settings will have no effect.</p>

DHCP Agent Information Option 82 Check	<p>This field can be toggled between <i>Enabled</i> and <i>Disabled</i> using the pull-down menu. It is used to enable or disable the Switches ability to check the validity of the packet's option 82 field.</p> <p><i>Enabled</i>- When the field is toggled to <i>Enable</i>, the relay agent will check the validity of the packet's option 82 field. If the switch receives a packet that contains the option-82 field from a DHCP client, the switch drops the packet because it is invalid. In packets received from DHCP servers, the relay agent will drop invalid messages.</p> <p><i>Disabled</i>- When the field is toggled to <i>Disabled</i>, the relay agent will not check the validity of the packet's option 82 field.</p>
DHCP Agent Information Option 82 Policy	<p>This field can be toggled between <i>Replace</i>, <i>Drop</i>, and <i>Keep</i> by using the pull-down menu. It is used to set the Switches policy for handling packets when the DHCP Agent Information Option 82 Check is set to <i>Disabled</i>. The default is <i>Replace</i>.</p> <p><i>Replace</i>- The option 82 field will be replaced if the option 82 field already exists in the packet received from the DHCP client.</p> <p><i>Drop</i>- The packet will be dropped if the option 82 field already exists in the packet received from the DHCP client.</p> <p><i>Keep</i>-The option 82 field will be retained if the option 82 field already exists in the packet received from the DHCP client.</p>

Click **Apply** to implement any changes that have been made.



NOTE: If the Switch receives a packet that contains the option-82 field from a DHCP client and the information-checking feature is enabled, the switch drops the packet because it is invalid. However, in some instances, you might configure a client with the option-82 field. In this situation, you should disable the information-check feature so that the switch does not remove the option-82 field from the packet. You can configure the action that the switch takes when it receives a packet with existing option-82 information by configuring the **DHCP Agent Information Option 82 Policy**.

The Implementation of DHCP Information Option 82 in the xStack DES-3500 Series switches

The `config dhcp_relay option_82` command configures the DHCP relay agent information option 82 setting of the switch. The formats for the circuit ID sub-option and the remote ID sub-option are as follows:



NOTE: For the circuit ID sub-option of a standalone switch, the module field is always zero.

Circuit ID sub-option format:

1.	2.	3.	4.	5.	6.	7.
1	6	0	4	VLAN	Module	Port
1 byte	1 byte	1 byte	1 byte	2 bytes	1 byte	1 byte

- a. Sub-option type
- b. Length
- c. Circuit ID type
- d. Length
- e. VLAN : the incoming VLAN ID of DHCP client packet.
- f. Module : For a standalone switch, the Module is always 0; For a stackable switch, the Module is the Unit ID.
- g. Port : The incoming port number of DHCP client packet, port number starts from 1.

Remote ID sub-option format:

1.	2.	3.	4.	5.
2	8	0	6	MAC address
1 byte	1 byte	1 byte	1 byte	6 bytes

1. Sub-option type
2. Length
3. Remote ID type
4. Length
5. MAC address: The Switch's system MAC address.

Figure 6- 118. Circuit ID and Remote ID Sub-option Format

DHCP/BOOTP Relay Interface Settings

The **DHCP/ BOOTP Relay Interface Settings** allow the user to set up a server, by IP address, for relaying DHCP/ BOOTP information to the Switch. The user may enter a previously configured IP interface on the Switch that will be connected directly to the DHCP/BOOTP server using the following window. Properly configured settings will be displayed in the **BOOTP Relay Table** at the bottom of the following window, once the user clicks the **Add** button under the **Apply** heading. The user may add up to four server IPs per IP interface on the Switch. Entries may be deleted by clicking it's corresponding **X**. To enable and configure **DHCP/BOOTP Relay Global Settings** on the Switch, click **Configuration > Layer 3 Networking > DHCP/BOOTP Relay > DHCP/BOOTP Relay Interface Settings**:

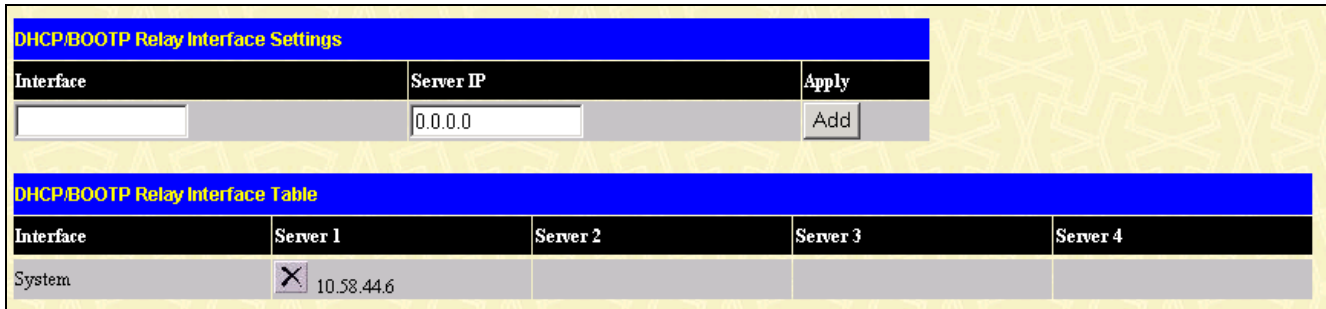

DHCP/BOOTP Relay Interface Settings				
Interface	Server IP	Apply		
	0.0.0.0	Add		

DHCP/BOOTP Relay Interface Table				
Interface	Server 1	Server 2	Server 3	Server 4
System	X 10.58.44.6			

Figure 6- 119. DHCP/BOOTP Relay Interface Settings and DHCP/BOOTP Relay Interface Table window

The following parameters may be configured or viewed.

Parameter	Description
Interface	The IP interface on the Switch that will be connected directly to the Server.
Server IP	Enter the IP address of the DHCP/BOOTP server. Up to four server IPs can be configured per IP Interface

Section 7

Management

- Security IP**
- User Accounts**
- Access Authentication Control (TACACS)**
- Secure Sockets Layer (SSL)**
- Secure Shell (SSH)**
- SNMP Manager**
- Safeguard Engine Settings**

The following section will aid the user in configuring security functions for the Switch. The Switch includes various functions for security, including TACACS, Security IPs, SSL, SSH and SNMP, all discussed in detail in the following section.

Security IP

Go to the **Management** folder and click on the **Security IP** link; the following window will appear.

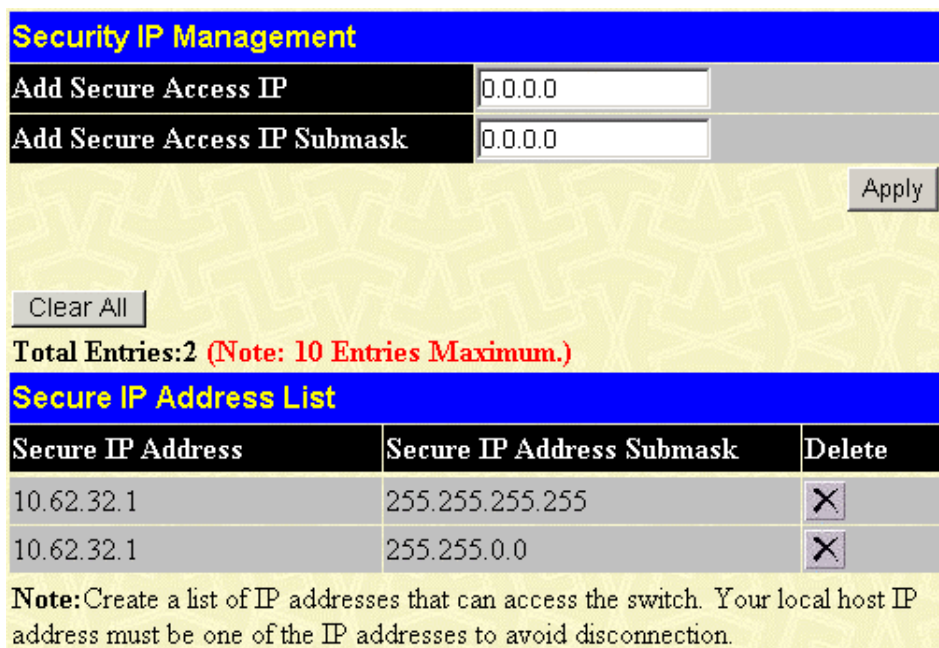

Figure 7- 1. Security IP Management window

Use the Security IP Management to permit remote stations to manage the Switch. If you choose to define one or more designated management stations, only the chosen stations, as defined by IP address, will be allowed management privilege through the web manager or Telnet session. You are allowed to enter IP address or IP submask to manage the Switch, and then click the **Apply** button to implement the setting. To remove an individual security IP address from the Switch, click the corresponding button under the Delete heading. To remove all security IP addresses from the Switch, click the button.

User Accounts

Use the **User Account Management** window to control user privileges. To view existing User Accounts, open the **Security Management** folder and click on the **User Accounts** link. This will open the **User Account Management** window, as shown below.

User Account Management		
User Name	Access Right	
Trinity	Admin	<input type="button" value="Add"/> <input type="button" value="Modify"/>

Figure 7- 2. User Accounts Management window

To add a new user, click on the **Add** button. To modify or delete an existing user, click on the **Modify** button for that user.

User Account Modify Table	
User Name	<input type="text"/>
New Password	<input type="text"/>
Confirm New Password	<input type="text"/>
Access Right	Admin ▾
<input type="button" value="Apply"/>	
Show All User Account Entries	

Figure 7- 3. User Accounts Modify Table window - Add

Add a new user by typing in a User Name, and New Password and retype the same password in the Confirm New Password. Choose the level of privilege (*Admin, Operator, or User*) from the Access Right drop-down menu.



NOTICE: In case of lost passwords or password corruption, please refer to the D-Link website and the White Paper entitled “Password Recovery Procedure”, which will guide you through the steps necessary to resolve this issue.

User Account Modify Table	
User Name	Trinity
Old Password	<input type="text"/>
New Password	<input type="text"/>
Confirm New Password	<input type="text"/>
Access Right	Admin
<input type="button" value="Apply"/> <input type="button" value="Delete"/>	
Show All User Account Entries	

Figure 7- 4. User Accounts Modify Table window - Modify

Modify or delete an existing user account in the User Account Modify Table. To delete the user account, click on the **Delete** button. To change the password, type in the New Password and retype it in the Confirm New Password entry field. The level of privilege (*Admin, Operator, or User*) can be viewed in the Access Right field.

Admin and User Privileges

There are three levels of user privileges, *Admin*, *Operator*, and *User*. Some menu selections available to users with *Admin* privileges may not be available to those with *User* privileges.

The following table summarizes the *Admin*, *Operator*, and *User* privileges:

Management	Admin	Operator	User
Network Monitoring	Yes	Yes	Read Only
Community Strings and Trap Stations	Yes	Yes	Read Only
Update Firmware and Configuration Files	Yes	Read Only	Read Only
Authentication Policy	Yes	No	No
System Utilities	Yes	No	No
Factory Reset	Yes	No	No
Create/Config/Delete User Accounts	Yes	No	No
View User Accounts	Yes	No	No

Table 7- 1. Admin and User Privileges

After establishing a User Account with Admin-level privileges, be sure to save the changes by opening the **Maintenance** folder, opening the **Save Changes** window and clicking the **Save Configuration** button.

Access Authentication Control

The TACACS/XTACACS/TACACS+/RADIUS commands let you secure access to the Switch using the TACACS/XTACACS/TACACS+/RADIUS protocols. When a user logs in to the Switch or tries to access the administrator level privilege, he or she is prompted for a password. If TACACS/XTACACS/TACACS+/RADIUS authentication is enabled on the Switch, it will contact a TACACS/XTACACS/TACACS+/RADIUS server to verify the user. If the user is verified, he or she is granted access to the Switch.

There are currently three versions of the TACACS security protocol, each a separate entity. The Switch's software supports the following versions of TACACS:

- **TACACS** (Terminal Access Controller Access Control System) - Provides password checking and authentication, and notification of user actions for security purposes utilizing via one or more centralized TACACS servers, utilizing the UDP protocol for packet transmission.
- **Extended TACACS (XTACACS)** - An extension of the TACACS protocol with the ability to provide more types of authentication requests and more types of response codes than TACACS. This protocol also uses UDP to transmit packets.
- **TACACS+ (Terminal Access Controller Access Control System plus)** - Provides detailed access control for authentication for network devices. TACACS+ is facilitated through Authentication commands via one or more centralized servers. The TACACS+ protocol encrypts all traffic between the Switch and the TACACS+ daemon, using the TCP protocol to ensure reliable delivery

In order for the TACACS/XTACACS/TACACS+/RADIUS security function to work properly, a TACACS/XTACACS/TACACS+/RADIUS server must be configured on a device other than the Switch, called an Authentication Server Host and it must include usernames and passwords for authentication. When the user is prompted by the Switch to enter usernames and passwords for authentication, the Switch contacts the TACACS/XTACACS/TACACS+/RADIUS server to verify, and the server will respond with one of three messages:

- The server verifies the username and password, and the user is granted normal user privileges on the Switch.
- The server will not accept the username and password and the user is denied access to the Switch.
- The server doesn't respond to the verification query. At this point, the Switch receives the timeout from the server and then moves to the next method of verification configured in the method list.

The Switch has four built-in **Authentication Server Groups**, one for each of the TACACS, XTACACS, TACACS+ and RADIUS protocols. These built-in Authentication Server Groups are used to authenticate users trying to access the Switch. The users will set **Authentication Server Hosts** in a preferable order in the built-in Authentication Server Groups and when a user tries to gain access to the Switch, the Switch will ask the first Authentication Server Hosts for authentication. If no authentication is made, the second server host in the list will be queried, and so on. The built-in Authentication Server Groups can only have hosts that are running the specified protocol. For example, the TACACS Authentication Server Groups can only have TACACS Authentication Server Hosts.

The administrator for the Switch may set up six different authentication techniques per user-defined method list (TACACS/XTACACS/TACACS+/RADIUS/local/none) for authentication. These techniques will be listed in an order preferable, and defined by the user for normal user authentication on the Switch, and may contain up to eight authentication techniques. When a user attempts to access the Switch, the Switch will select the first technique listed for authentication. If the first technique goes through its Authentication Server Hosts and no authentication is returned, the Switch will then go to the next technique listed in the server group for authentication, until the authentication has been verified or denied, or the list is exhausted.

Please note that users granted access to the Switch will be granted normal user privileges on the Switch. To gain access to administrator level privileges, the user must access the **Enable Admin** window, which is only available for logging in the Switch from the three versions of the TACACS server, and then enter a password, which was previously configured by the administrator of the Switch.



NOTE: TACACS, XTACACS and TACACS+ are separate entities and are not compatible. The Switch and the server must be configured exactly the same, using the same protocol. (For example, if the Switch is set up for TACACS authentication, so must be the host server.)

Policy & Parameters

This command will enable an administrator-defined authentication policy for users trying to access the Switch. When enabled, the device will check the Login Method List and choose a technique for user authentication upon login.

To access the following window, click **Security Management > Access Authentication Control > Policy & Parameters**:

Figure 7- 5. Policy & Parameters Settings window

The following parameters can be set:

Parameters	Description
Authentication Policy	Use the pull-down menu to enable or disable the Authentication Policy on the Switch.
Response Timeout (0-255)	This field will set the time the Switch will wait for a response of authentication from the user. The user may set a time between 0 and 255 seconds. The default setting is 0 seconds.
User Attempts (1-255)	This command will configure the maximum number of times the Switch will accept authentication attempts. Users failing to be authenticated after the set amount of attempts will be denied access to the Switch and will be locked out of further authentication attempts. Command line interface users will have to wait 60 seconds before another authentication attempt. Telnet and web users will be disconnected from the Switch. The user may set the number of attempts from 1 to 255. The default setting is 3.

Click **Apply** to implement changes made.

Application's Authentication Settings

This window is used to configure switch configuration applications (console, Telnet, SSH, web) for login at the user level and at the administration level (Enable Admin) utilizing a previously configured method list. To view the following window, click **Security Management > Access Authentication Control > Application Authentication Settings**:

Figure 7- 6. Application's Authentication Settings window

The following parameters can be set:

Parameter	Description
Application	Lists the configuration applications on the Switch. The user may configure the Login Method List and Enable Method List for authentication for users utilizing the Console (Command Line Interface) application, the Telnet application, SSH and the WEB (HTTP) application.
Login Method List	Using the pull down menu, configure an application for normal login on the user level, utilizing a previously configured method list. The user may use the default Method List or other Method List configured by the user. See the Login Method Lists window, in this section, for more information.

Enable Method List	Using the pull down menu, configure an application for normal login on the user level, utilizing a previously configured method list. The user may use the default Method List or other Method List configured by the user. See the Enable Method Lists window, in this section, for more information
---------------------------	--

Click **Apply** to implement changes made.

Authentication Server Group Settings

This window will allow users to set up *Authentication Server Groups* on the Switch. A server group is a technique used to group TACACS/XTACACS/TACACS+/RADIUS server hosts into user-defined categories for authentication using method lists. The user may define the type of server group by protocol or by previously defined server group. The Switch has three built-in Authentication Server Groups that cannot be removed but can be modified. Up to eight authentications server hosts may be added to any particular group.

To view the following window, click **Security Management > Access Authentication Control > Authentication Server Group**:



Figure 7- 7. Authentication Server Group Settings window

This screen displays the Authentication Server Groups on the Switch. The Switch has four built-in Authentication Server Groups that cannot be removed but can be modified. To modify a particular group, click its hyperlinked Group Name, which will then display the following window.

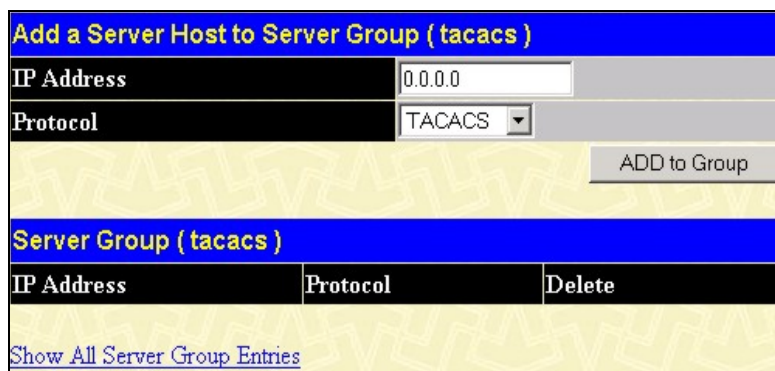

Figure 7- 8. Add a Server Host to Server Group (TACACS) window

To add an Authentication Server Host to the list, enter its IP address in the IP Address field, choose the protocol associated with the IP address of the Authentication Server Host and click **Add to Group** to add this Authentication Server Host to the group.

To add a user-defined server group that is not displayed on the screen, click the add button, revealing the following window for the user to configure.



Figure 7- 9. Authen Server Group Table Add Settings

Enter a group name of up to 15 alphanumeric characters to identify the users Group Name and click *Add*. The user's new Group Name will then appear in the Authentication Server Group Settings window as seen below, defined as Trinity.

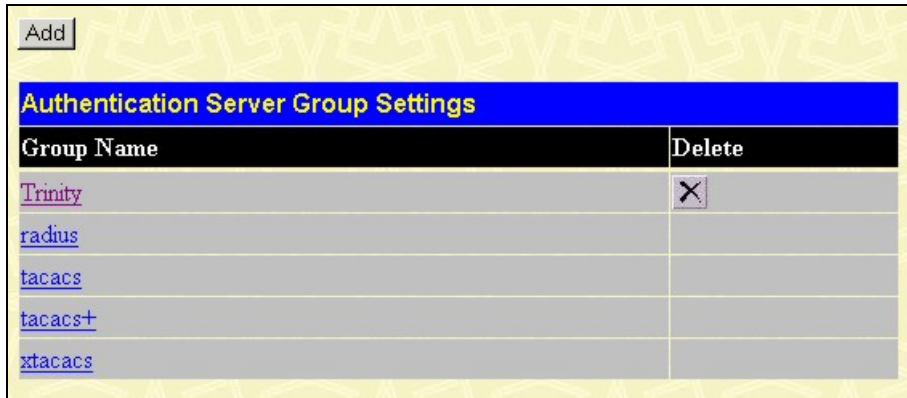

Figure 7- 10. Authentication Server Group Settings window

The new group may be modified in the same way as the other groups, by clicking the hyperlinked name. Yet, unlike the other groups, the user-defined Group Name can have any combination of Protocol hosts to be in this group. (Ex. TACACS – XTACACS – TACACS+)



NOTE: The user must configure Authentication Server Hosts using the Authentication Server Hosts window before adding hosts to the list. Authentication Server Hosts must be configured for their specific protocol on a remote centralized server before this function can work properly.



NOTE: The three built in server groups can only have server hosts running the same TACACS daemon. TACACS/XTACACS/TACACS+ protocols are separate entities and are not compatible with each other.

Authentication Server Hosts

This window will set user-defined *Authentication Server Hosts* for the TACACS/XTACACS/TACACS+/RADIUS security protocols on the Switch. When a user attempts to access the Switch with Authentication Policy enabled, the Switch will send authentication packets to a remote TACACS/XTACACS/TACACS+/RADIUS server host on a remote host. The TACACS/XTACACS/TACACS+/RADIUS server host will then verify or deny the request and return the appropriate message to the Switch. More than one authentication protocol can be run on the same physical server host but, remember that TACACS/XTACACS/TACACS+/RADIUS are separate entities and are not compatible with each other. The maximum supported number of server hosts is 16.

To view the following window, click **Security Management > Access Authentication Control > Authentication Server Host:**

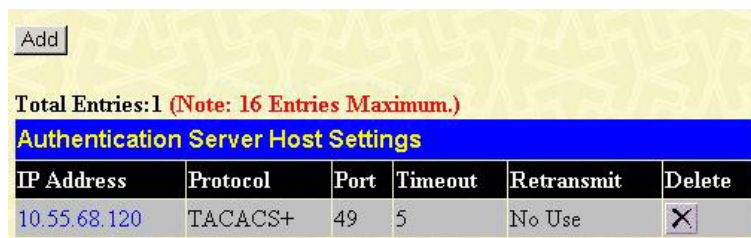

Figure 7- 11. Authentication Server Host Settings window

To add an Authentication Server Host, click the **Add** button, revealing the following window:

Authentication Server Host Setting - Add	
IP Address	<input type="text" value="0.0.0.0"/>
Protocol	TACACS <input type="button" value="v"/>
Port(1-65535)	<input type="text" value="49"/>
Timeout(1-255)	<input type="text" value="5"/>
Retransmit(1-255)	<input type="text" value="2"/>
Key	<input type="text"/>
<input type="button" value="Apply"/>	
Show All Authentication Server Host Entries	

Figure 7- 12. Authentication Server Host Settings – Add window

Configure the following parameters to add an Authentication Server Host:

Parameter	Description
IP Address	The IP address of the remote server host the user wishes to add.
Protocol	The protocol used by the server host. The user may choose one of the following: <ul style="list-style-type: none"> • TACACS - Enter this parameter if the server host utilizes the TACACS protocol. • XTACACS - Enter this parameter if the server host utilizes the XTACACS protocol. • TACACS+ - Enter this parameter if the server host utilizes the TACACS+ protocol. • RADIUS - Enter this parameter if the server host utilizes the RADIUS protocol.
Port (1-65535)	Enter a number between 1 and 65535 to define the virtual port number of the authentication protocol on a server host. The default port number is 49 for TACACS/XTACACS/TACACS+ servers and 1813 for RADIUS servers but the user may set a unique port number for higher security.
Timeout (1-255)	Enter the time in seconds the Switch will wait for the server host to reply to an authentication request. The default value is 5 seconds.
Retransmit (1-255)	Enter the value in the retransmit field to change how many times the device will resend an authentication request when the TACACS server does not respond. The default value is 2 seconds.
Key	Authentication key to be shared with a configured TACACS+ or RADIUS servers only. Specify an alphanumeric string up to 254 characters.

Click **Apply** to add the server host.



NOTE: More than one authentication protocol can be run on the same physical server host but, remember that TACACS/XTACACS/TACACS+ are separate entities and are not compatible with each other.

Login Method Lists

This command will configure a user-defined or default Login Method List of authentication techniques for users logging on to the Switch. The sequence of techniques implemented in this command will affect the authentication result. For example, if a user enters a sequence of techniques, for example TACACS - XTACACS- local, the Switch will send an authentication request to the first TACACS host in the server group. If no response comes from the server host, the Switch will send an authentication request to the second TACACS host in the server group and so on, until the list is exhausted. At that point, the Switch will restart the same sequence with the following protocol listed, XTACACS. If no authentication takes place using the XTACACS list, the local account database set in the Switch is used to authenticate the user. When the local method is used, the privilege level will be dependant on the local account privilege configured on the Switch.

Successful login using any of these techniques will give the user a "User" privilege only. If the user wishes to upgrade his or her status to the administrator level, the user must use the **Enable Admin** window, in which the user must enter a previously configured password, set by the administrator. (See the Enable Admin part of this section for more detailed information concerning the Enable Admin command.)

To view the following window click **Security Management > Access Authentication Control > Login Method Lists**:

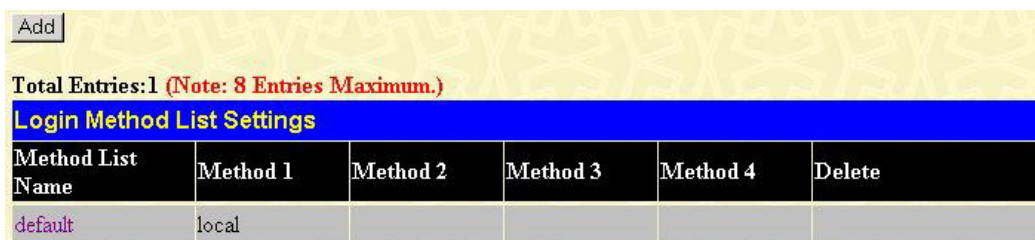

Figure 7- 13. Login Method Lists Settings window

The Switch contains one Method List that is set and cannot be removed, yet can be modified. To delete a Login Method List defined by the user, click the *X* under the Delete heading corresponding to the entry desired to be deleted. To modify a Login Method List, click on its hyperlinked Method List Name. To configure a new Method List, click the **Add** button.

Both actions will result in the same window to configure:

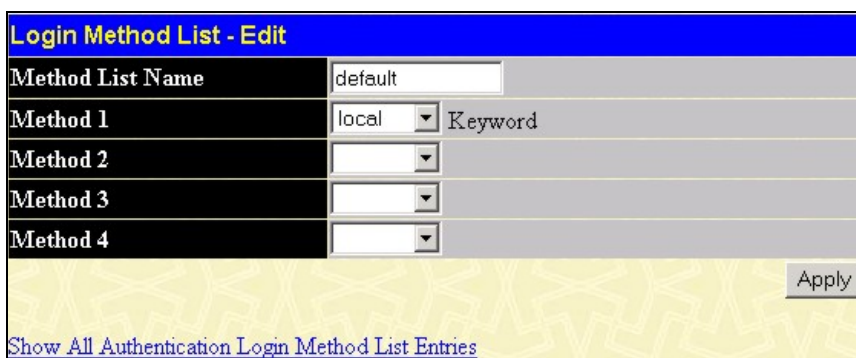

Figure 7- 14. Login Method List - Edit window (default)

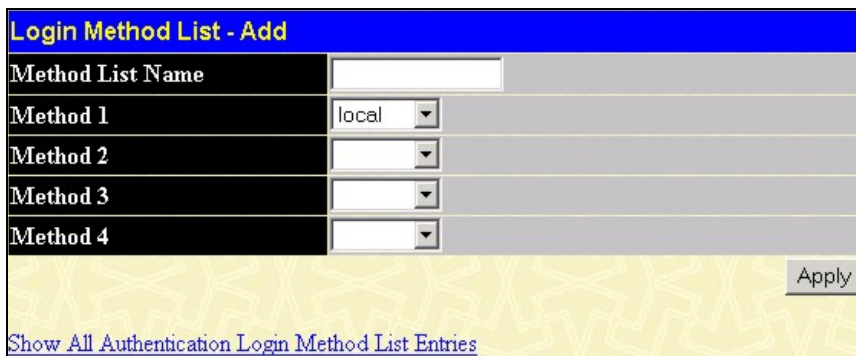

Figure 7- 15. Login Method List – Add window

To define a Login Method List, set the following parameters and click **Apply**:

Parameter	Description
Method List Name	Enter a method list name defined by the user of up to 15 characters.
Method 1, 2, 3, 4	<p>The user may add one, or a combination of up to four of the following authentication methods to this method list:</p> <ul style="list-style-type: none"> • <i>tacacs</i> - Adding this parameter will require the user to be authenticated using the TACACS protocol from a remote TACACS server. • <i>xtacacs</i> - Adding this parameter will require the user to be authenticated using the XTACACS protocol from a remote XTACACS server. • <i>tacacs+</i> - Adding this parameter will require the user to be authenticated using the TACACS+ protocol from a remote TACACS+ server. • <i>radius</i> - Adding this parameter will require the user to be authenticated using the RADIUS protocol from a remote RADIUS server. • <i>server_group</i> - Adding this parameter will require the user to be authenticated using a user-defined server group previously configured on the Switch. • <i>local</i> - Adding this parameter will require the user to be authenticated using the local user account database on the Switch. • <i>none</i> - Adding this parameter will require an authentication to access the Switch.

Enable Method Lists

The **Enable Method List Settings** window is used to set up Method Lists to promote users with user level privileges to Administrator (Admin) level privileges using authentication methods on the Switch. Once a user acquires normal user level privileges on the Switch, he or she must be authenticated by a method on the Switch to gain administrator privileges on the Switch, which is defined by the Administrator. A maximum of eight Enable Method Lists can be implemented on the Switch, one of which is a default Enable Method List. This default Enable Method List cannot be deleted but can be configured.

The sequence of methods implemented in this command will affect the authentication result. For example, if a user enters a sequence of methods like TACACS - XTACACS - Local Enable, the Switch will send an authentication request to the first TACACS host in the server group. If no verification is found, the Switch will send an authentication request to the second TACACS host in the server group and so on, until the list is exhausted. At that point, the Switch will restart the same sequence with the following protocol listed, XTACACS. If no authentication takes place using the XTACACS list, the Local Enable password set in the Switch is used to authenticate the user.

Successful authentication using any of these methods will give the user an "Admin" privilege.



NOTE: To set the Local Enable Password, see the next section, entitled Local Enable Password.

To view the following table, click **Security Management > Access Authentication Control > Enable Method Lists**:

Enable Method List Settings					
Method List Name	Method 1	Method 2	Method 3	Method 4	Delete
default	local_enable				

Figure 7- 16. Enable Method List Settings window

To delete an Enable Method List defined by the user, click the X under the Delete heading corresponding to the entry desired to be deleted. To modify an Enable Method List, click on its hyperlinked Method List Name. To configure a Method List, click the **Add** button.

Both actions will result in the same window to configure:

Figure 7- 17. Enable Method List - Edit window

Figure 7- 18. Enable Method List - Add window

To define an Enable Login Method List, set the following parameters and click **Apply**:

Parameter	Description
Method List Name	Enter a method list name defined by the user of up to 15 characters.
Method 1, 2, 3, 4	<p>The user may add one, or a combination of up to four of the following authentication methods to this method list:</p> <ul style="list-style-type: none"> <i>local_enable</i> - Adding this parameter will require the user to be authenticated using the local enable password database on the Switch. The user in the next section entitled Local Enable Password must set the local enable password. <i>none</i> - Adding this parameter will require an authentication to access the Switch. <i>radius</i> - Adding this parameter will require the user to be authenticated using the RADIUS protocol from a remote RADIUS server. <i>tacacs</i> - Adding this parameter will require the user to be authenticated using the TACACS protocol from a remote TACACS server. <i>xtacacs</i> - Adding this parameter will require the user to be authenticated using the XTACACS protocol from a remote XTACACS server. <i>tacacs+</i> - Adding this parameter will require the user to be authenticated using the TACACS protocol from a remote TACACS server. <i>server_group</i> - Adding a previously configured server group will require the user to be authenticated using a user-defined server group previously configured on the Switch.

Local Enable Password

This window will configure the locally enabled password for the Enable Admin command. When a user chooses the "local_enable" method to promote user level privileges to administrator privileges, he or she will be prompted to enter the password configured here that is locally set on the Switch.

To view the following window, click **Security Management > Access Authentication Control > Local Enable Password**:

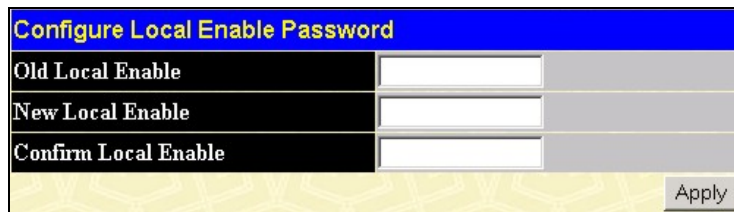

Figure 7- 19. Configure Local Enable Password window

To set the Local Enable Password, set the following parameters and click **Apply**.

Parameter	Description
Old Local Enabled	If a password was previously configured for this entry, enter it here in order to change it to a new password.
New Local Enabled	Enter the new password that you wish to set on the Switch to authenticate users attempting to access Administrator Level privileges on the Switch. The user may set a password of up to 15 characters.
Confirm Local Enabled	Confirm the new password entered above. Entering a different password here from the one set in the New Local Enabled field will result in a fail message.

Enable Admin

The **Enable Admin** window is for users who have logged on to the Switch on the normal user level, and wish to be promoted to the administrator level. After logging on to the Switch, users will have only user level privileges. To gain access to administrator level privileges, the user will open this window and will have to enter an authentication password. Possible authentication methods for this function include TACACS/XTACACS/TACACS+/RADIUS, user defined server groups, local enable (local account on the Switch), or no authentication (none). Because XTACACS and TACACS do not support the enable function, the user must create a special account on the server host, which has the username "enable", and a password configured by the administrator that will support the "enable" function. This function becomes inoperable when the authentication policy is disabled.

To view the following window, click **Security Management > Access Authentication Control > Enable Admin**:



Figure 7- 20. Enable Admin Screen

When this window appears, click the **Enable Admin** button revealing a dialog box for the user to enter authentication (password, username), as seen below. A successful entry will promote the user to Administrator level privileges on the Switch.



Figure 7- 21. Enter Network Password dialog box

Secure Socket Layer (SSL)

Secure Sockets Layer or SSL is a security feature that will provide a secure communication path between a host and client through the use of authentication, digital signatures and encryption. These security functions are implemented through the use of a *ciphersuite*, which is a security string that determines the exact cryptographic parameters, specific encryption algorithms and key sizes to be used for an authentication session and consists of three levels:

1. **Key Exchange:** The first part of the cyphersuite string specifies the public key algorithm to be used. This switch utilizes the Rivest Shamir Adleman (RSA) public key algorithm and the Digital Signature Algorithm (DSA), specified here as the *DHE DSS* Diffie-Hellman (DHE) public key algorithm. This is the first authentication process between client and host as they “exchange keys” in looking for a match and therefore authentication to be accepted to negotiate encryptions on the following level.
2. **Encryption:** The second part of the ciphersuite that includes the encryption used for encrypting the messages sent between client and host. The Switch supports two types of cryptology algorithms:
 - Stream Ciphers – There are two types of stream ciphers on the Switch, *RC4 with 40-bit keys* and *RC4 with 128-bit keys*. These keys are used to encrypt messages and need to be consistent between client and host for optimal use.
 - CBC Block Ciphers – CBC refers to Cipher Block Chaining, which means that a portion of the previously encrypted block of encrypted text is used in the encryption of the current block. The Switch supports the *3DES EDE* encryption code defined by the Data Encryption Standard (DES) to create the encrypted text.
3. **Hash Algorithm:** This part of the ciphersuite allows the user to choose a message digest function which will determine a Message Authentication Code. This Message Authentication Code will be encrypted with a sent message to provide integrity and prevent against replay attacks. The Switch supports two hash algorithms, *MD5* (Message Digest 5) and *SHA* (Secure Hash Algorithm).

These three parameters are uniquely assembled in four choices on the Switch to create a three-layered encryption code for secure communication between the server and the host. The user may implement any one or combination of the ciphersuites available, yet different ciphersuites will affect the security level and the performance of the secured connection. The information included in the ciphersuites is not included with the Switch and requires downloading from a third source in a file form called a *certificate*. This function of the Switch cannot be executed without the presence and implementation of the certificate file and can be downloaded to the Switch by utilizing a TFTP server. The Switch supports SSLv3 and TLSv1. Other versions of SSL may not be compatible with this Switch and may cause problems upon authentication and transfer of messages from client to host.

Download Certificate

This window is used to download a certificate file for the SSL function on the Switch from a TFTP server. The certificate file is a data record used for authenticating devices on the network. It contains information on the owner, keys for authentication and digital signatures. Both the server and the client must have consistent certificate files for optimal use of the SSL function. The Switch only supports certificate files with .der file extensions. The Switch is shipped with a certificate pre-loaded though the user may need to download more, depending on user circumstances.

To view the following window, click **Configuration > Secure Socket Layer (SSL) > Download Certificate**:

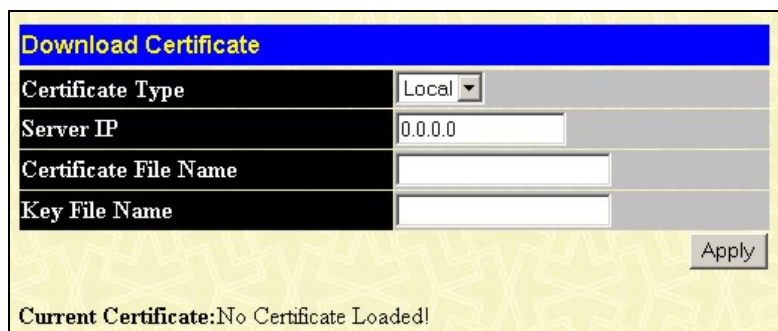

Figure 7- 22. Download Certificate window

To download certificates, set the following parameters and click **Apply**.

Parameter	Description
Certificate Type	Enter the type of certificate to be downloaded. This type refers to the server responsible for issuing certificates. This field has been limited to <i>local</i> for this firmware release.
Server IP	Enter the IP address of the TFTP server where the certificate files are located.
Certificate File Name	Enter the path and the filename of the certificate file to download. This file must have a .der extension. (Ex. c:/cert.der)
Key File Name	Enter the path and the filename of the key file to download. This file must have a .der extension (Ex. c:/pkey.der)

Configuration

This window will allow the user to enable SSL on the Switch and implement any one or combination of listed ciphersuites on the Switch. A *ciphersuite* is a security string that determines the exact cryptographic parameters, specific encryption algorithms and key sizes to be used for an authentication session. The Switch possesses four possible ciphersuites for the SSL function, which are all enabled by default. To utilize a particular ciphersuite, disable the unwanted ciphersuites, leaving the desired one for authentication.

When the SSL function has been enabled, the web will become disabled. To manage the Switch through the web based management while utilizing the SSL function, the web browser must support SSL encryption and the header of the URL must begin with https://. (Ex. https://10.90.90.90) Any other method will result in an error and no access can be authorized for the web-based management.

To view the following window, click **Configuration > Secure Socket Layer (SSL) > Configuration:**

Ciphersuite	
RSA with RC4 128 MD5	Enabled 0x0004
RSA with 3DES EDE CBC SHA	Enabled 0x000a
DHE DSS with 3DES EDE CBC SHA	Enabled 0x0013
RSA Export with RC4 40 MD5	Enabled 0x0003
SSL Status	Disabled
Apply	

Figure 7- 23. Ciphersuite window

To set up the SSL function on the Switch, configure the following parameters and click **Apply**.

Parameter	Description
RSA with RC4 128 MD5	This ciphersuite combines the RSA key exchange, stream cipher RC4 encryption with 128-bit keys and the MD5 Hash Algorithm. Use the pull-down menu to enable or disable this ciphersuite. This field is <i>Enabled</i> by default.
RSA with 3DES EDE CBC SHA	This ciphersuite combines the RSA key exchange, CBC Block Cipher 3DES_EDE encryption and the SHA Hash Algorithm. Use the pull-down menu to enable or disable this ciphersuite. This field is <i>Enabled</i> by default.
DHS DSS with 3DES EDE CBC SHA	This ciphersuite combines the DSA Diffie Hellman key exchange, CBC Block Cipher 3DES_EDE encryption and SHA Hash Algorithm. Use the pull-down menu to enable or disable this ciphersuite. This field is <i>Enabled</i> by default.
RSA EXPORT with RC4 40 MD5	This ciphersuite combines the RSA Export key exchange and stream cipher RC4 encryption with 40-bit keys. Use the pull-down menu to enable or disable this ciphersuite. This field is <i>Enabled</i> by default.
SSL Status	Use the pull-down menu to enable or disable the SSL status on the switch. The default is <i>Disabled</i> .



NOTE: Certain implementations concerning the function and configuration of SSL are not available on the web-based management of this Switch and need to be configured using the command line interface. For more information on SSL and its functions, see the **DES-3500 Series Command Line Reference Manual**, located on the documentation CD of this product.



NOTE: Enabling the SSL command will disable the web-based switch management. To log on to the Switch again, the header of the URL must begin with https://. Entering anything else into the address field of the web browser will result in an error and no authentication will be granted.

Secure Shell (SSH)

SSH is an abbreviation of Secure Shell, which is a program allowing secure remote login and secure network services over an insecure network. It allows a secure login to remote host computers, a safe method of executing commands on a remote end node, and will provide secure encrypted and authenticated communication between two non-trusted hosts. SSH, with its array of unmatched security features is an essential tool in today’s networking environment. It is a powerful guardian against numerous existing security hazards that now threaten network communications.

The steps required to use the SSH protocol for secure communication between a remote PC (the SSH client) and the Switch (the SSH server) are as follows:

1. Create a user account with admin-level access using the User Accounts window in the **Security Management** folder. This is identical to creating any other admin-level User Account on the Switch, including specifying a password. This password is used to logon to the Switch, once a secure communication path has been established using the SSH protocol.
2. Configure the User Account to use a specified authorization method to identify users that are allowed to establish SSH connections with the Switch using the **SSH User Authentication** window. There are three choices as to the method SSH will use to authorize the user, which are *Host Based*, *Password* and *Public Key*.
3. Configure the encryption algorithm that SSH will use to encrypt and decrypt messages sent between the SSH client and the SSH server, using the **SSH Algorithm** window.
4. Finally, enable SSH on the Switch using the **SSH Configuration** window.

After completing the preceding steps, a SSH Client on a remote PC can be configured to manage the Switch using a secure, in band connection.

SSH Configuration

The following window is used to configure and view settings for the SSH server and can be opened by clicking **Security Management > Secure Shell (SSH) > SSH Configuration**:

Current SSH Configuration Settings	
SSH Server Status	Disabled
Max Session	8
Time Out	300
Auth. Fail	2
Session Rekeying	Never
Ports	22
New SSH Configuration Settings	
SSH Server Status	Disabled ▾
Max Session(1-8)	8
Time Out(120-600)	300
Auth. Fail(2-20)	2
Session Rekeying	Never ▾
Apply	

Figure 7- 24. Current SSH Configuration Settings

To configure the SSH server on the Switch, modify the following parameters and click **Apply**:

Parameter	Description
SSH Server Status	Use the pull-down menu to enable or disable SSH on the Switch. The default is <i>Disabled</i> .
Max Session (1-8)	Enter a value between 1 and 8 to set the number of users that may simultaneously access the Switch. The default setting is 8.
Time Out (120-600)	Allows the user to set the connection timeout. The use may set a time between 120 and 600 seconds. The default setting is 300 seconds.

Auth. Fail (2-20)	Allows the Administrator to set the maximum number of attempts that a user may try to log on to the SSH Server utilizing the SSH authentication. After the maximum number of attempts has been exceeded, the Switch will be disconnected and the user must reconnect to the Switch to attempt another login. The number of maximum attempts may be set between 2 and 20. The default setting is 2.
Session Rekeying	Using the pull-down menu uses this field to set the time period that the Switch will change the security shell encryptions. The available options are <i>Never</i> , <i>10 min</i> , <i>30 min</i> , and <i>60 min</i> . The default setting is <i>Never</i> .

SSH Algorithm

The SSH Algorithm window allows the configuration of the desired types of SSH algorithms used for authentication encryption. There are four categories of algorithms listed and specific algorithms of each may be enabled or disabled by using their corresponding pull-down menus. All algorithms are enabled by default. To open the following window, click **Security Management > Secure Shell (SSH) > SSH Algorithm**:

Encryption Algorithm	
3DES-CBC	Enabled
Blow-fish-CBC	Enabled
AES128-CBC	Enabled
AES192-CBC	Enabled
AES256-CBC	Enabled
ARC4	Enabled
Cast128-CBC	Enabled
Twofish128	Enabled
Twofish192	Enabled
Twofish256	Enabled
Data Integrity Algorithm	
HMAC-SHA1	Enabled
HMAC-MD5	Enabled
Public Key Algorithm	
HMAC-RSA	Enabled
HMAC-DSA	Enabled
Authentication Algorithm	
Password	Enabled
Publickey	Enabled
Host-based	Enabled
Apply	

Figure 7- 25. Encryption Algorithm window

The following algorithms may be set:

Parameter	Description
Encryption Algorithm	
3DES-CBC	Use the pull-down to enable or disable the Triple Data Encryption Standard encryption algorithm with Cipher Block Chaining. The default is <i>Enabled</i> .
Blow-fish CBC	Use the pull-down to enable or disable the Blowfish encryption algorithm with Cipher Block Chaining. The default is <i>Enabled</i> .
AES128-CBC	Use the pull-down to enable or disable the Advanced Encryption Standard AES128 encryption algorithm with Cipher Block Chaining. The default is <i>Enabled</i> .

AES192-CBC	Use the pull-down to enable or disable the Advanced Encryption Standard AES192 encryption algorithm with Cipher Block Chaining. The default is <i>Enabled</i> .
AES256-CBC	Use the pull-down to enable or disable the Advanced Encryption Standard AES-256 encryption algorithm with Cipher Block Chaining. The default is <i>Enabled</i> .
ARC4	Use the pull-down to enable or disable the Arcfour encryption algorithm with Cipher Block Chaining. The default is <i>Enabled</i> .
Cast128-CBC	Use the pull-down to enable or disable the Cast128 encryption algorithm with Cipher Block Chaining. The default is <i>Enabled</i> .
Twofish128	Use the pull-down to enable or disable the twofish128 encryption algorithm. The default is <i>Enabled</i> .
Twofish192	Use the pull-down to enable or disable the twofish192 encryption algorithm. The default is <i>Enabled</i> .
Twofish256	Use the pull-down to enable or disable the twofish256 encryption algorithm. The default is <i>Enabled</i> .
Data Integrity Algorithm	
HMAC-SHA1	Use the pull-down to enable or disable the HMAC (Hash for Message Authentication Code) mechanism utilizing the Secure Hash algorithm. The default is <i>Enabled</i> .
HMAC-MD5	Use the pull-down to enable or disable the HMAC (Hash for Message Authentication Code) mechanism utilizing the MD5 Message Digest encryption algorithm. The default is <i>Enabled</i> .
Public Key Algorithm	
HMAC-RSA	Use the pull-down to enable or disable the HMAC (Hash for Message Authentication Code) mechanism utilizing the RSA encryption algorithm. The default is <i>Enabled</i> .
HMAC-DSA	Use the pull-down to enable or disable the HMAC (Hash for Message Authentication Code) mechanism utilizing the Digital Signature Algorithm encryption. The default is <i>Enabled</i> .
Authentication Algorithm	
Password	This parameter may be enabled if the administrator wishes to use a locally configured password for authentication on the Switch. The default is <i>Enabled</i> .
Public Key	This parameter may be enabled if the administrator wishes to use a publickey configuration set on a SSH server, for authentication on the Switch. The default is <i>Enabled</i> .
Host-based	This parameter may be enabled if the administrator wishes to use a host computer for authentication. This parameter is intended for Linux users requiring SSH authentication techniques and the host computer is running the Linux operating system with a SSH program previously installed. The default is <i>Enabled</i> .

Click **Apply** to implement changes made.

SSH User Authentication

The following windows are used to configure parameters for users attempting to access the Switch through SSH. To access the following window, click **Security Management > Secure Shell > SSH User Authentication**.

Current Accounts			
User Name	Auth. Mode	Host Name	Host IP
Trinity	Password		

Figure 7- 26. Current Accounts window

In the example screen above, the User Account “Trinity” has been previously set using the User Accounts window in the **Security Management** folder. A User Account **MUST** be set in order to set the parameters for the SSH user. To configure the parameters for a SSH user, click on the hyperlinked User Name in the **Current Accounts** window, which will reveal the following window to configure.

User Name	<input type="text" value="Darren"/>
Auth. Mode	<input type="text" value="Password"/>
Host Name	<input type="text"/>
Host IP	<input type="checkbox"/> <input type="text" value="0.0.0.0"/>
<input type="button" value="Apply"/>	
Show All User Authentication Entries	

Figure 7- 27. User Accounts Modify Table window

The user may set the following parameters:

Parameter	Description
User Name	Enter a User Name of no more than 15 characters to identify the SSH user. This User Name must be a previously configured user account on the Switch.
Auth. Mode	<p>The administrator may choose one of the following to set the authorization for users attempting to access the Switch.</p> <p><i>Host Based</i> – This parameter should be chosen if the administrator wishes to use a remote SSH server for authentication purposes. Choosing this parameter requires the user to input the following information to identify the SSH user.</p> <ul style="list-style-type: none"> <i>Host Name</i> – Enter an alphanumeric string of no more than 31 characters to identify the remote SSH user. <i>Host IP</i> – Enter the corresponding IP address of the SSH user. <p><i>Password</i> – This parameter should be chosen if the administrator wishes to use an administrator-defined password for authentication. Upon entry of this parameter, the Switch will prompt the administrator for a password, and then to re-type the password for confirmation.</p> <p><i>Public Key</i> – This parameter should be chosen if the administrator wishes to use the publickey on a SSH server for authentication.</p>
Host Name	Enter an alphanumeric string of no more than 31 characters to identify the remote SSH user. This parameter is only used in conjunction with the Host Based choice in the Auth. Mode field.
Host IP	Enter the corresponding IP address of the SSH user. This parameter is only used in conjunction with the Host Based choice in the Auth. Mode field.

Click **Apply** to implement changes made.



NOTE: To set the SSH User Authentication parameters on the Switch, a User Account must be previously configured. For more information on configuring local User Accounts on the Switch, see the User Accounts section of this manual located in this section.

SNMP Manager

SNMP Settings

Simple Network Management Protocol (SNMP) is an OSI Layer 7 (Application Layer) designed specifically for managing and monitoring network devices. SNMP enables network management stations to read and modify the settings of gateways, routers, switches, and other network devices. Use SNMP to configure system features for proper operation, monitor performance and detect potential problems in the Switch, switch group or network.

Managed devices that support SNMP include software (referred to as an agent), which runs locally on the device. A defined set of variables (managed objects) is maintained by the SNMP agent and used to manage the device. These objects are defined in a Management Information Base (MIB), which provides a standard presentation of the information controlled by the on-board SNMP agent. SNMP defines both the format of the MIB specifications and the protocol used to access this information over the network.

The DES-3500 Series switches support the SNMP versions 1, 2c, and 3. You can specify which version of the SNMP you want to use to monitor and control the Switch. The three versions of SNMP vary in the level of security provided between the management station and the network device.

In SNMP v.1 and v.2, user authentication is accomplished using 'community strings', which function like passwords. The remote user SNMP application and the Switch SNMP must use the same community string. SNMP packets from any station that has not been authenticated are ignored (dropped).

The default community strings for the Switch used for SNMP v.1 and v.2 management access are:

- **public** - Allows authorized management stations to retrieve MIB objects.
- **private** - Allows authorized management stations to retrieve and modify MIB objects.

SNMPv3 uses a more sophisticated authentication process that is separated into two parts. The first part is to maintain a list of users and their attributes that are allowed to act as SNMP managers. The second part describes what each user on that list can do as an SNMP manager.

The Switch allows groups of users to be listed and configured with a shared set of privileges. The SNMP version may also be set for a listed group of SNMP managers. Thus, you may create a group of SNMP managers that are allowed to view read-only information or receive traps using SNMPv1 while assigning a higher level of security to another group, granting read/write privileges using SNMPv3.

Using SNMPv3 individual users or groups of SNMP managers can be allowed to perform or be restricted from performing specific SNMP management functions. The functions allowed or restricted are defined using the Object Identifier (OID) associated with a specific MIB. An additional layer of security is available for SNMPv3 in that SNMP messages may be encrypted. To read more about how to configure SNMPv3 settings for the Switch read the next section.

Traps

Traps are messages that alert network personnel of events that occur on the Switch. The events can be as serious as a reboot (someone accidentally turned OFF the Switch), or less serious like a port status change. The Switch generates traps and sends them to the trap recipient (or network manager). Typical traps include trap messages for Authentication Failure, Topology Change and Broadcast/Multicast Storm.

MIBs

The Switch in the Management Information Base (MIB) stores management and counter information. The Switch uses the standard MIB-II Management Information Base module. Consequently, values for MIB objects can be retrieved from any SNMP-based network management software. In addition to the standard MIB-II, the Switch also supports its own proprietary enterprise MIB as an extended Management Information Base. Specifying the MIB Object Identifier may also retrieve the proprietary MIB. MIB values can be either read-only or read-write.

The DES-3500 Series switches incorporate a flexible SNMP management for the switching environment. SNMP management can be customized to suit the needs of the networks and the preferences of the network administrator. Use the SNMP V3 menus to select the SNMP version used for specific tasks.

The DES-3500 Series switches support the Simple Network Management Protocol (SNMP) versions 1, 2c, and 3. The administrator can specify the SNMP version used to monitor and control the Switch. The three versions of SNMP vary in the level of security provided between the management station and the network device.

SNMP settings are configured using the menus located on the SNMP V3 folder of the web manager. Workstations on the network that are allowed SNMP privileged access to the Switch can be restricted with the Management Station IP Address menu.

SNMP User Table

The **SNMP User Table** displays all of the SNMP User's currently configured on the Switch.

In the **SNMP Manager** folder, located in the **Security Management** folder, click on the **SNMP User Table** link. This will open the **SNMP User Table** window, as shown below.

SNMP User Table			
User Name	Group Name	SNMP Version	Delete
initial	initial	V3	X

Figure 7- 28. SNMP User Table window

To delete an existing SNMP User Table entry, click the button under the Delete heading corresponding to the entry you wish to delete.

To display the detailed entry for a given user, click on the hyperlinked User Name. This will open the **SNMP User Table Display** window, as shown below.

SNMP User Table Display	
User Name	initial
Group Name	initial
SNMP Version	V3
Auth-Protocol	None
Priv-Protocol	None

[Show All SNMP User Table Entries](#)

Figure 7- 29. SNMP User Table Display window

The following parameters are displayed:

Parameter	Description
User Name	An alphanumeric string of up to 32 characters. This is used to identify the SNMP users.
Group Name	This name is used to specify the SNMP group created can request SNMP messages.
SNMP Version	V1 - Indicates that SNMP version 1 is in use. V2 - Indicates that SNMP version 2 is in use. V3 - Indicates that SNMP version 3 is in use.
Auth-Protocol	None - Indicates that no authorization protocol is in use. MD5 - Indicates that the HMAC-MD5-96 authentication level will be used. SHA - Indicates that the HMAC-SHA authentication protocol will be used.
Priv-Protocol	None - Indicates that no authorization protocol is in use. DES - Indicates that DES 56-bit encryption is in use based on the CBC-DES (DES-56) standard.

To return to the SNMP User Table, click the [Show All SNMP User Table Entries](#) link.

To add a new entry to the **SNMP User Table Configuration** window, click on the **Add** button on the **SNMP User Table** window. This will open the **SNMP User Table Configuration** window, as shown below.

The image shows a configuration window titled "SNMP User Table Configuration". It contains several input fields and controls:

- User Name:** A text input field.
- Group Name:** A text input field.
- SNMP Version:** A dropdown menu currently set to "V1". To its right is an unchecked checkbox labeled "Encrypted".
- Auth-Protocol:** A dropdown menu currently set to "MD5". To its right is a text input field labeled "Password".
- Priv-Protocol:** A dropdown menu currently set to "DES". To its right is a text input field labeled "Password".
- Apply:** A button located at the bottom right of the configuration area.
- Show All SNMP User Table Entries:** A link located at the bottom left of the configuration area.

Figure 7- 30. SNMP User Table Configuration window

The following parameters can set:

Parameter	Description
User Name	Enter an alphanumeric string of up to 32 characters. This is used to identify the SNMP user.
Group Name	This name is used to specify the SNMP group created can request SNMP messages.
SNMP Version	V1 - Specifies that SNMP version 1 will be used. V2 - Specifies that SNMP version 2 will be used. V3 - Specifies that SNMP version 3 will be used.
Auth-Protocol	MD5 - Specifies that the HMAC-MD5-96 authentication level will be used. This field is only operable when V3 is selected in the SNMP Version field and the Encryption field has been checked. This field will require the user to enter a password. SHA - Specifies that the HMAC-SHA authentication protocol will be used. This field is only operable when V3 is selected in the SNMP Version field and the Encryption field has been checked. This field will require the user to enter a password.
Priv-Protocol	None - Specifies that no authorization protocol is in use. DES - Specifies that DES 56-bit encryption is in use, based on the CBC-DES (DES-56) standard. This field is only operable when V3 is selected in the SNMP Version field and the Encryption field has been checked. This field will require the user to enter a password between 8 and 16 alphanumeric characters.
Encrypted	Checking the corresponding box will enable encryption for SNMP V3 and is only operable in SNMP V3 mode.

To implement changes made, click **Apply**. To return to the SNMP User Table, click the [Show All SNMP User Table Entries](#) link.

SNMP View Table

The SNMP View Table is used to assign views to community strings that define which MIB objects can be accessed by a remote SNMP manager. To view the **SNMP View Table** window, open the **SNMP Manager** folder under **Security Management** and click the **SNMP View Table** entry. The following window should appear:

Add			
Total Entries:8 (Note: Insert a maximum of 30 entries into the table.)			
SNMP View Table			
View Name	Subtree	View Type	Delete
restricted	1.3.6.1.2.1.1	Included	X
restricted	1.3.6.1.2.1.11	Included	X
restricted	1.3.6.1.6.3.10.2.1	Included	X
restricted	1.3.6.1.6.3.11.2.1	Included	X
restricted	1.3.6.1.6.3.15.1.1	Included	X
CommunityView	1	Included	X
CommunityView	1.3.6.1.6.3	Excluded	X
CommunityView	1.3.6.1.6.3.1	Included	X

Figure 7- 31. SNMP View Table window

To delete an existing SNMP View Table entry, click the button in the Delete column corresponding to the entry you wish to delete. To create a new entry, click the **Add** button and a separate window will appear.

SNMP View Table Configuration	
View Name	<input type="text"/>
Subtree OID	<input type="text"/>
View Type	Included <input type="button" value="v"/>
<input type="button" value="Apply"/>	
Show All SNMP View Table Entries	

Figure 7- 32. SNMP View Table Configuration window

The SNMP Group created with this table maps SNMP users (identified in the SNMP User Table) to the views created in the previous window.

The following parameters can set:

Parameter	Description
View Name	Type an alphanumeric string of up to 32 characters. This is used to identify the new SNMP view being created.
Subtree OID	Type the Object Identifier (OID) Subtree for the view. The OID identifies an object tree (MIB tree) that will be included or excluded from access by an SNMP manager.
View Type	Select Included to include this object in the list of objects that an SNMP manager can access. Select Excluded to exclude this object from the list of objects that an SNMP manager can access.

To implement your new settings, click **Apply**. To return to the SNMP View Table, click the [Show All SNMP View Table Entries](#) link.

SNMP Group Table

An SNMP Group created with this table maps SNMP users (identified in the SNMP User Table) to the views created in the previous menu. To view the **SNMP Group Table** window, open the **SNMP Manager** folder in the **Security Management** folder and click the **SNMP Group Table** entry. The following window should appear:

SNMP Group Table			
Group Name	Security Model	Security Level	Delete
public	SNMPv1	NoAuthNoPriv	<input type="button" value="X"/>
public	SNMPv2	NoAuthNoPriv	<input type="button" value="X"/>
initial	SNMPv3	NoAuthNoPriv	<input type="button" value="X"/>
private	SNMPv1	NoAuthNoPriv	<input type="button" value="X"/>
private	SNMPv2	NoAuthNoPriv	<input type="button" value="X"/>
ReadGroup	SNMPv1	NoAuthNoPriv	<input type="button" value="X"/>
ReadGroup	SNMPv2	NoAuthNoPriv	<input type="button" value="X"/>
WriteGroup	SNMPv1	NoAuthNoPriv	<input type="button" value="X"/>
WriteGroup	SNMPv2	NoAuthNoPriv	<input type="button" value="X"/>

Figure 7- 33. SNMP Group Table window

To delete an existing SNMP Group Table entry, click the corresponding button under the Delete heading.

To display the current settings for an existing SNMP Group Table entry, click the hyperlink for the entry under the Group Name.

SNMP Group Table Display	
Group Name	public
Read View Name	CommunityView
Write View Name	
Notify View Name	CommunityView
Security Model	SNMPv1
Security Level	NoAuthNoPriv
Show All SNMP Group Table Entries	

Figure 7- 34. SNMP Group Table Display window

To add a new entry to the Switch's SNMP Group Table, click the **Add** button in the upper left-hand corner of the **SNMP Group Table** window. This will open the **SNMP Group Table Configuration** window, as shown below.

SNMP Group Table Configuration	
Group Name	<input type="text"/>
Read View Name	<input type="text"/>
Write View Name	<input type="text"/>
Notify View Name	<input type="text"/>
Security Model	SNMPv1 <input type="button" value="v"/>
Security Level	NoAuthNoPriv <input type="button" value="v"/>
<input type="button" value="Apply"/>	
Show All SNMP Group Table Entries	

Figure 7- 35. SNMP Group Table Configuration window

The following parameters can set:

Parameter	Description
Group Name	Type an alphanumeric string of up to 32 characters. This is used to identify the new SNMP group of SNMP users.
Read View Name	Specify a SNMP group name for users that are allowed SNMP read privileges to the Switch's SNMP agent. The view name must exist in the SNMP View Table.
Write View Name	Specify a SNMP group name for users that are allowed SNMP write privileges to the Switch's SNMP agent. The view name must exist in the SNMP View Table.
Notify View Name	Specify a SNMP group name for users that can receive SNMP trap messages generated by the Switch's SNMP agent. The view name must exist in the SNMP View Table.
Security Model	<p><i>SNMPv1</i> - Specifies that SNMP version 1 will be used.</p> <p><i>SNMPv2</i> - Specifies that SNMP version 2c will be used. The SNMPv2 supports both centralized and distributed network management strategies. It includes improvements in the Structure of Management Information (SMI) and adds some security features.</p> <p><i>SNMPv3</i> - Specifies that the SNMP version 3 will be used. SNMPv3 provides secure access to devices through a combination of authentication and encrypting packets over the network.</p>
Security Level	<p>The Security Level settings only apply to SNMPv3.</p> <p><i>NoAuthNoPriv</i> - Specifies that there will be no authorization and no encryption of packets sent between the Switch and a remote SNMP manager.</p> <p><i>AuthNoPriv</i> - Specifies that authorization will be required, but there will be no encryption of packets sent between the Switch and a remote SNMP manager.</p> <p><i>AuthPriv</i> - Specifies that authorization will be required, and that packets sent between the Switch and a remote SNMP manger will be encrypted.</p>

To implement your new settings, click **Apply**. To return to the SNMP Group Table, click the [Show All SNMP Group Table Entries](#) link.

SNMP Community Table Configuration

Use this table to create an SNMP community string to define the relationship between the SNMP manager and an agent. The community string acts like a password to permit access to the agent on the Switch. One or more of the following characteristics can be associated with the community string:

- An Access List of IP addresses of SNMP managers that are permitted to use the community string to gain access to the Switch's SNMP agent.
- Any MIB view that defines the subset of all MIB objects will be accessible to the SNMP community.
- Read/write or read-only level permission for the MIB objects accessible to the SNMP community.

To configure SNMP Community entries, open the **SNMP Manager** folder, located in the **Security Management** folder, and click the **SNMP Community Table** link, which will open the following window:

SNMP Community Table Configuration			
Community Name	View Name	Access Right	
<input type="text"/>	<input type="text"/>	Read Only ▾	
<input type="button" value="Apply"/>			
Total Entries: 2 (Note: Insert a maximum of 10 entries into the table.)			
SNMP Community Table			
Community Name	View Name	Access Right	Delete
private	CommunityView	Read Write	<input type="button" value="X"/>
public	CommunityView	Read Only	<input type="button" value="X"/>

Figure 7- 36. SNMP Community Table Configuration window

The following parameters can set:

Parameter	Description
Community Name	Type an alphanumeric string of up to 32 characters that is used to identify members of an SNMP community. This string is used like a password to give remote SNMP managers access to MIB objects in the Switch's SNMP agent.
View Name	Type an alphanumeric string of up to 32 characters that is used to identify the group of MIB objects that a remote SNMP manager is allowed to access on the Switch. The view name must exist in the SNMP View Table.
Access Right	<i>Read Only</i> - Specifies that SNMP community members using the community string created can only read the contents of the MIBs on the Switch. <i>Read Write</i> - Specifies that SNMP community members using the community string created can read from, and write to the contents of the MIBs on the Switch.

To implement the new settings, click **Apply**. To delete an entry from the SNMP Community Table, click the  under the Delete heading, corresponding to the entry you wish to delete.

SNMP Host Table

Use the **SNMP Host Table** window to set up SNMP trap recipients.

Open the **SNMP Manager** folder, located in the **Security Management** folder and click on the **SNMP Host Table** link. This will open the **SNMP Host Table** window, as shown below.

To delete an existing SNMP Host Table entry, click the corresponding  button under the Delete heading.

To display the current settings for an existing **SNMP Host Table** entry, click the blue link for the entry under the Host IP Address heading.

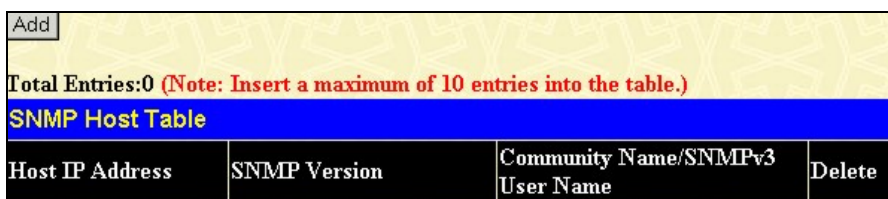

Figure 7- 37. SNMP Host Table window

To add a new entry to the Switch's SNMP Host Table, click the **Add** button in the upper left-hand corner of the window. This will open the **SNMP Host Table Configuration** window, as shown below.

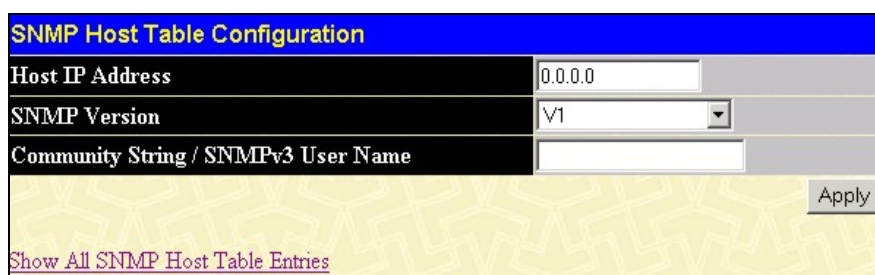

Figure 7- 38. SNMP Host Table Configuration window

The following parameters can set:

Parameter	Description
Host IP Address	Type the IP address of the remote management station that will serve as the SNMP host for the Switch.
SNMP Version	<i>V1</i> - To specifies that SNMP version 1 will be used. <i>V2</i> - To specify that SNMP version 2 will be used. <i>V3-NoAuth-NoPriv</i> - To specify that the SNMP version 3 will be used, with a NoAuth-NoPriv security level. <i>V3-Auth-NoPriv</i> - To specify that the SNMP version 3 will be used, with an Auth-NoPriv security

	level. V3-Auth-Priv - To specify that the SNMP version 3 will be used, with an Auth-Priv security level.
Community String/SNMP V3 User Name	Type in the community string or SNMP V3 user name as appropriate.

To implement your new settings, click **Apply**. To return to the SNMP Host Table, click the [Show All SNMP Host Table Entries](#) link.

SNMP Engine ID

The Engine ID is a unique identifier used for SNMP V3 implementations. This is an alphanumeric string used to identify the SNMP engine on the Switch.

To display the Switch's SNMP Engine ID, open the **SNMP Manger** folder, located in the **Security Management** and click on the **SNMP Engine ID** link. This will open the **SNMP Engine ID Configuration** window, as shown below.

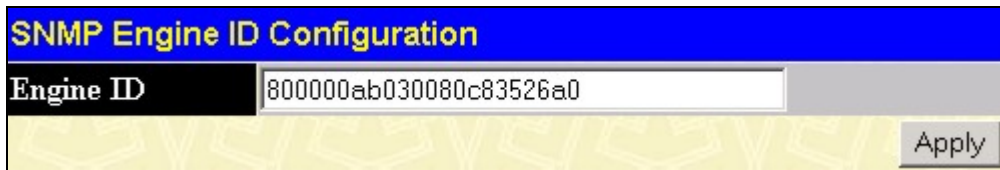

Figure 7- 39. SNMP Engine ID Configuration window

To change the Engine ID, type the new Engine ID in the space provided and click the **Apply** button.

Safeguard Engine

Periodically, malicious hosts on the network will attack the Switch by utilizing packet flooding (ARP Storm) or other methods. These attacks may increase the Safeguard Engine beyond its capability. To alleviate this problem, the Safeguard Engine function was added to the Switch's software.

The Safeguard Engine can help the overall operability of the Switch by minimizing the workload of the Switch while the attack is ongoing, thus making it capable to forward essential packets over its network in a limited bandwidth. When the Switch either (a) receives too many packets to process or (b) exerts too much memory, it will enter an **Exhausted** mode. When in this mode, the Switch will drop all ARP and IP broadcast packets for a calculated time interval. Every five seconds, the Switch will check to see if there are too many packets flooding the Switch. If the threshold has been crossed, the Switch will initially stop all ingress ARP and IP broadcast packets for five seconds. After another five-second checking interval arrives, the Switch will again check the ingress flow of packets. If the flooding has stopped, the Switch will again begin accepting all packets. Yet, if the checking shows that there continues to be too many packets flooding the Switch, it will stop accepting all ARP and IP broadcast packets for double the time of the previous stop period. This doubling of time for stopping ingress ARP and IP broadcast packets will continue until the maximum time has been reached, which is 320 seconds and every stop from this point until a return to normal ingress flow would be 320 seconds. For a better understanding, examine the following example of the Safeguard Engine.

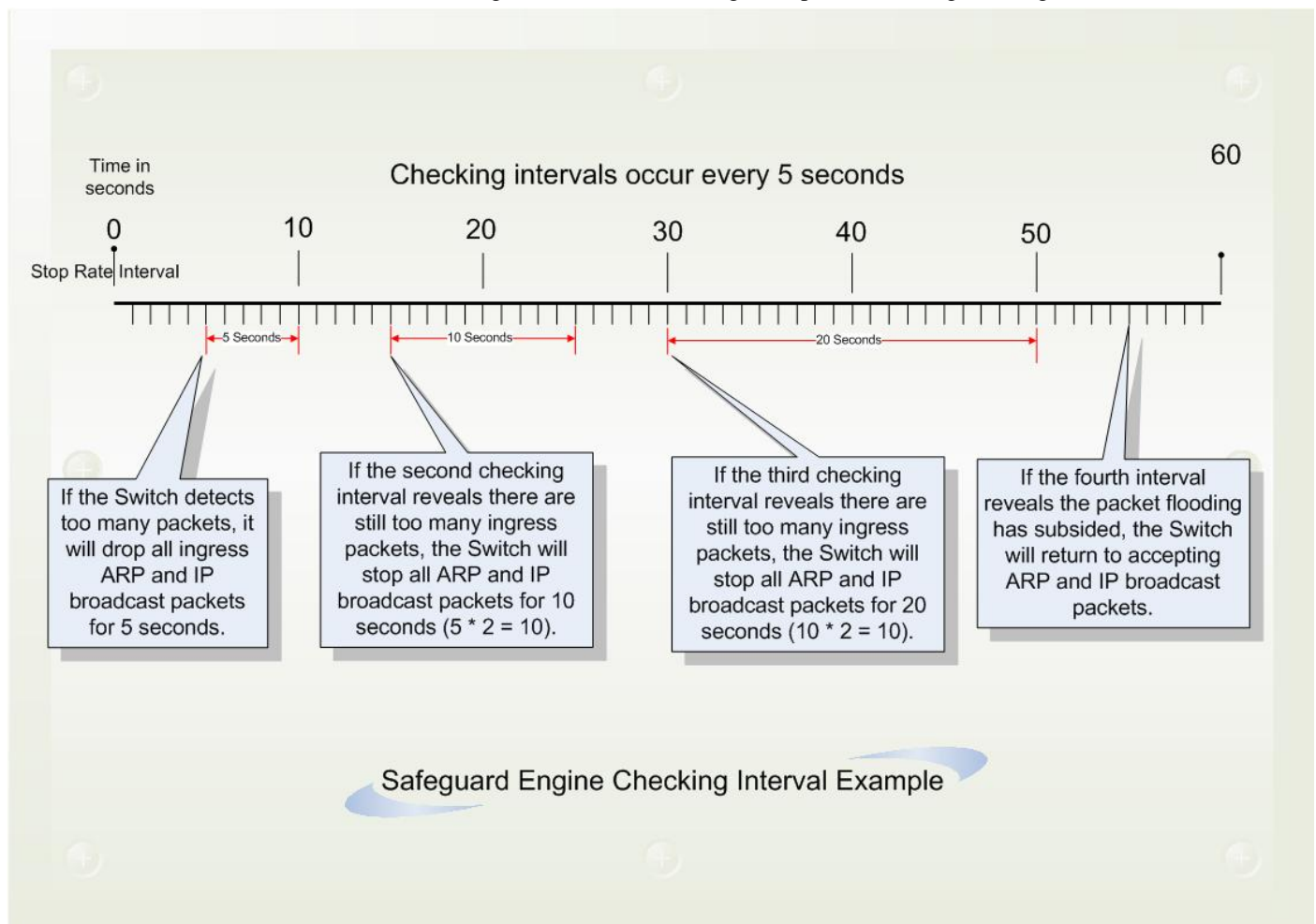

Figure 7- 40. Safeguard Engine example

For every consecutive checking interval that reveals a packet flooding issue, the Switch will double the time it will discard ingress ARP and IP broadcast packets. In the example above, the Switch doubled the time for dropping ARP and IP broadcast packets when consecutive flooding issues were detected at 5 second intervals. (First stop = 5 seconds, second stop = 10 seconds, third stop = 20 seconds) Once the flooding is no longer detected, the wait period for dropping ARP and IP broadcast packets will return to 5 seconds and the process will resume.

Once in Exhausted mode, the packet flow will decrease by half of the level that caused the Switch to enter Exhausted mode. After the packet flow has stabilized, the rate will initially increase by 25% and then return to a normal packet flow.

To configure the Safeguard Engine for the Switch, click **Security > Safeguard Engine >** which will open the following window.

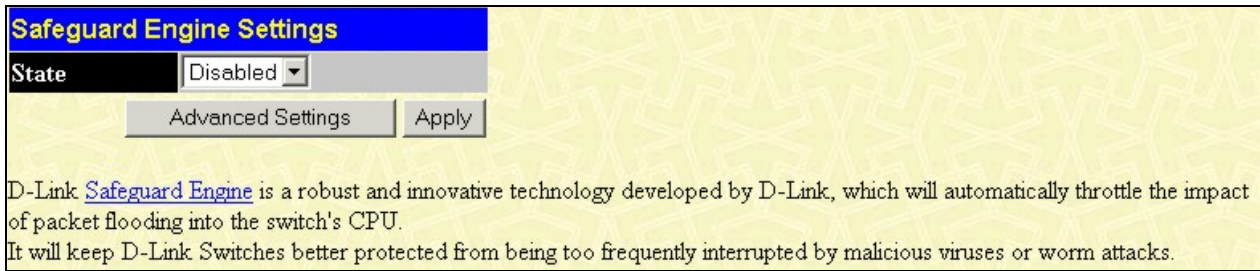

Figure 7- 41. Safeguard Engine window

To configure the Switch’s Safeguard Engine, change the **State** to *Enabled*. To configure the parameters for the Safeguard Engine, click the **Advanced Settings** button which will alter the previous screen to look like this:

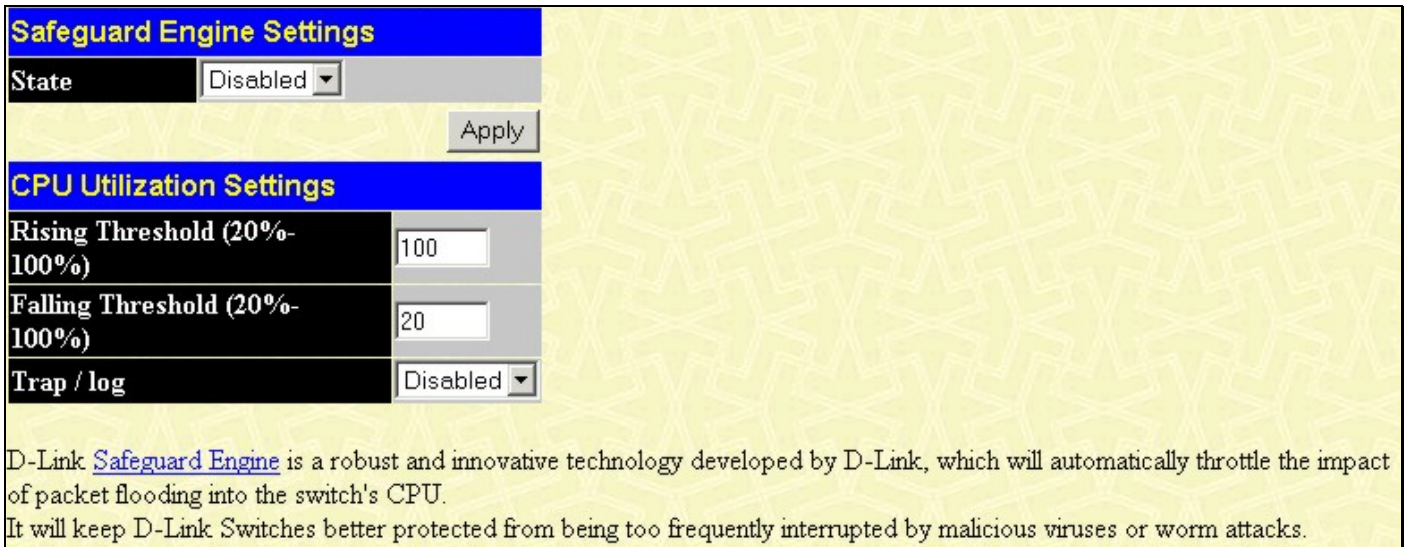

Figure 7- 42. Safeguard Engine window - Advanced Settings

To set the Safeguard Engine for the Switch, complete the following fields:

Parameter	Description
State	Toggle the State field to either <i>Enabled</i> or <i>Disabled</i> for the Safeguard Engine of the Switch.
Rising Threshold	Used to configure the acceptable level of CPU utilization before the Safeguard Engine mechanism is enabled. Once the CPU utilization reaches this percentage level, the Switch will move into the Exhausted state.
Falling Threshold	Used to configure the acceptable level of CPU utilization as a percentage, where the Switch leaves the Exhausted state and returns to normal mode.
Trap/log	Use the pull-down menu to enable or disable the sending of messages to the device’s SNMP agent and switch log once the Safeguard Engine has been activated by a high CPU utilization rate.

Filter

DHCP Server Screening Setting

Due to this function allow you not only to restrict all DHCP Server packets but also to receive any specified DHCP server packet by any specified DHCP client, it is useful when one or more than one DHCP servers are present on the network and both provide DHCP services to different distinct groups of clients. Enabling the DHCP filter in the first time will create both an access profile and access rule per port, then creat other access rules following. These rules are used to block all DHCP server packets. Similarly, addition of a permit DHCP entry will create one access profile and create one access rule only in the first time where DHCP client MAC address is the client MAC address, and the Source IP address is the same as the DHCP server’s IP address (UDP port number 67) that set in the **DHCP Client Screening Setting** window. These rules are used to permit the DHCP server packets with specific files, which the user configured.

When DHCP Server filter function is enabled in **DHCP Server Screening Setting** window, all DHCP Server packets will be filtered from a specific port.

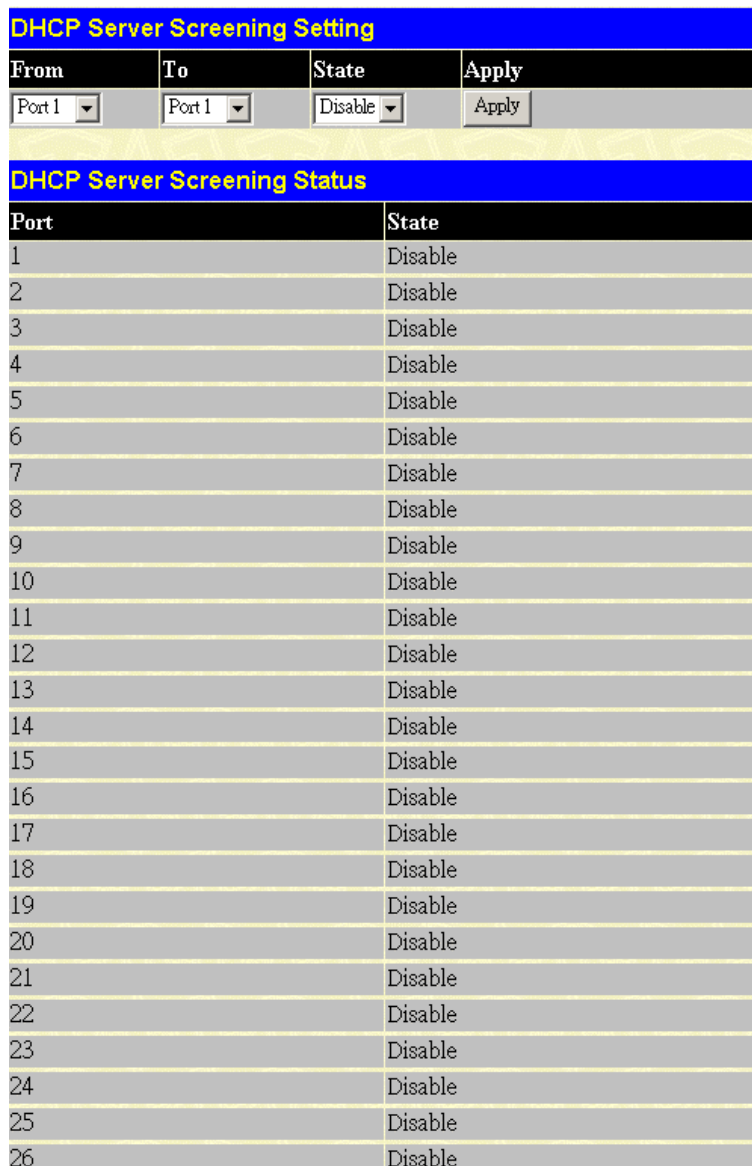

Figure 7- 43. DHCP Server Screening Setting window

The parameters of DHCP Server Screening window are described as below:

Parameter	Description
From/To	These two drop-down menus allow you to select a range of ports to which the filter settings will be applied.
State	Enable or disable DHCP Server filter for the ports selected using the pull-down menu. The default setting is Disable.

To implement the new settings, click **Apply**. Then the current configuration will be displayed in the **DHCP Server Screening Status** table.

DHCP Client Filtering Setting

This window allows you to create entries for specific Server IP address and Client MAC address binding by port-based. Be aware that the DHCP Server filter function must be enabled in **DHCP Server Screening Setting** window first. Once all setting is done, all DHCP Server packets will be filtered from a specific port except those that meet the Server IP Address and Client MAC Address binding set in the following **DHCP Client Screening Setting** window.

Figure 7- 44. DHCP Client Filtering Setting window

The parameters of the above window are described as below:

Parameter	Description
Server IP Address	Enter IP address of the Server.
Client MAC Address	Enter MAC address of the Client.
All Ports	Check it to select all port of the Switch.
Ports	Check the corresponding boxes for the port(s) you wish to apply the settings.

Click **Apply** to implement the new settings or **Modify** to renew the settings. Then the **DHCP Client Filtering Status** table will show up the current status for all existing entries. To delete any existing entry, click the corresponding  button under the Delete heading.

NetBIOS Filtering Setting

When the NetBIOS filter is enabled, all NetBIOS packets will be filtered from the specified port. Enabling the NetBIOS filter will create one access profile and create three access rules per port (UDP port numbers 137 and 138 and TCP port number 139).

For Extensive NetBIOS Filter, when it is enabled, all NetBIOS packets over 802.3 frames will be filtered from the specified port. This command is used to configure the state of the NetBIOS filter. Enabling the Extensive NetBIOS filter will create one access profile and create one access rule per port (DSAP (Destination Service Access Point) =F0, and SASP (Source Service Access Point) =F0).

NetBIOS Filtering Setting			
From	To	State	Apply
Port 1	Port 1	Disable	Apply

Extensive NetBIOS Filtering Setting			
From	To	Extensive State	Apply
Port 1	Port 1	Disable	Apply

NetBIOS Filtering Status		
Port	State	Extensive State
1	Disable	Disable
2	Disable	Disable
3	Disable	Disable
4	Disable	Disable
5	Disable	Disable
6	Disable	Disable
7	Disable	Disable
8	Disable	Disable
9	Disable	Disable
10	Disable	Disable
11	Disable	Disable
12	Disable	Disable
13	Disable	Disable
14	Disable	Disable
15	Disable	Disable
16	Disable	Disable
17	Disable	Disable
18	Disable	Disable
19	Disable	Disable
20	Disable	Disable
21	Disable	Disable
22	Disable	Disable
23	Disable	Disable
24	Disable	Disable
25	Disable	Disable
26	Disable	Disable

Figure 7- 45. NetBIOS Filtering Setting and Extensive NetBIOS Filter Setting window

The parameters are described as below:

Parameter	Description
From/To	These two drop-down menus allow you to select a range of ports to which the filter settings will be applied.
State	Enable or disable NetBIOS filter for the ports selected using the pull-down menu. The default setting is Disable.
Extensive State	Enable or disable Extensive NetBIOS filter for the ports selected using the pull-down menu. The default setting is Disable.

To implement the new settings, click **Apply**. Then the current configuration will be displayed in the **NetBIOS Filtering Status** table.

Section 8

Monitoring

- Port Utilization**
- CPU Utilization**
- Packets**
- Errors**
- Size**
- MAC Address**
- Switch History Log**
- IGMP Snooping Group**
- IGMP Snooping Forwarding**
- VLAN Status**
- Router Port**
- Port Access Control**
- Layer 3 Feature**
- Safeguard Engine Status**

Port Utilization

The **Utilization** window displays the percentage of the total available bandwidth being used on the port.

To view the port utilization, open the **Monitoring** folder and then the **Port Utilization** link:

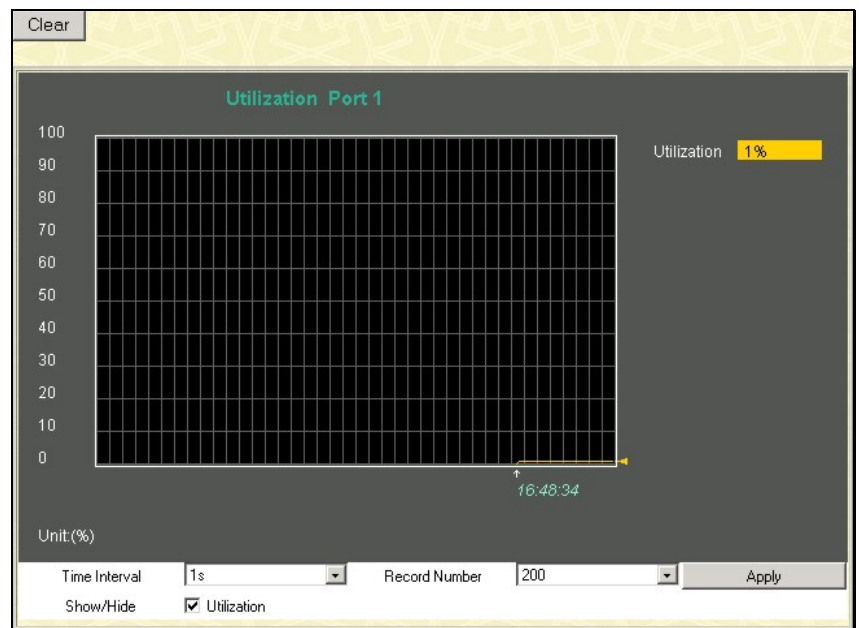

Figure 8- 1. Utilization window

The following field can be set:

Parameter	Description
Time Interval	Select the desired setting between 1s and 60s, where "s" stands for seconds. The default value is one second.
Record Number	Select number of times the Switch will be polled between 20 and 200. The default value is 200.

Click **Clear** to refresh the graph. Click **Apply** to set changes implemented.

CPU Utilization

The **CPU Utilization** window displays the percentage of the CPU being used, expressed as an integer percentage and calculated as a simple average by time interval. To view this window, open the **Monitoring** folder and click the **CPU Utilization** link.

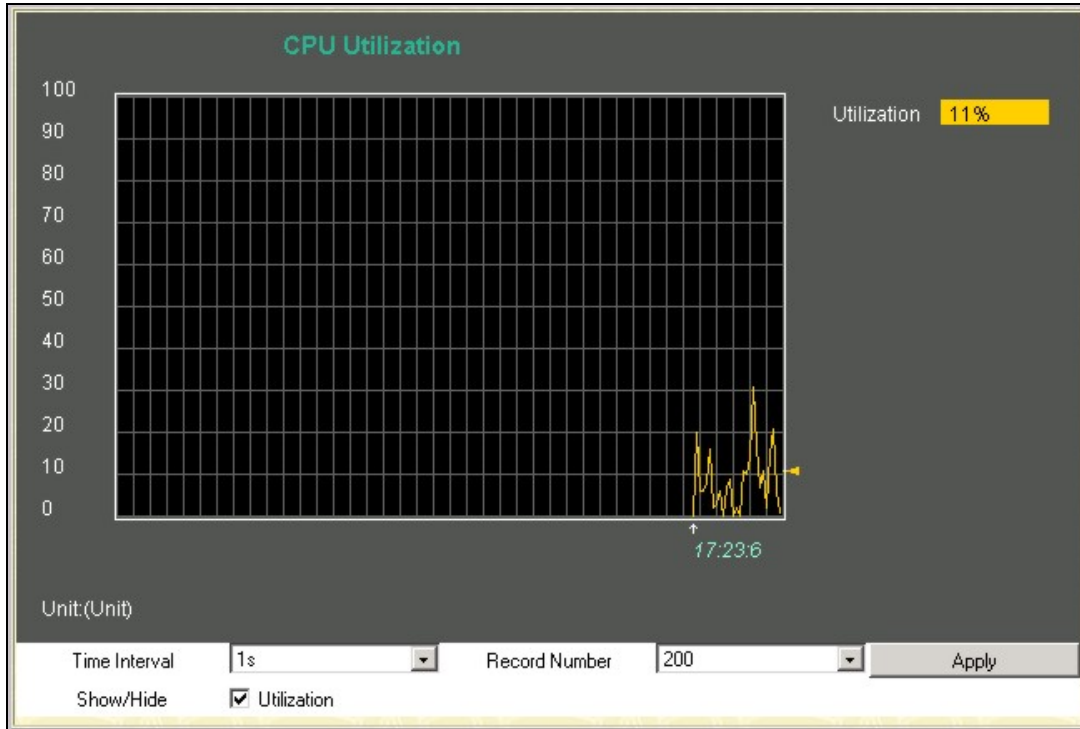

Figure 8- 2. CPU Utilization window

Click **Apply** to implement the configured settings. The window will automatically refresh with new updated statistics. The information is described as follows:

Parameter	Description
Time Interval	Select the desired setting between 1s and 60s, where "s" stands for seconds. The default value is one second.
Record Number	Select number of times the Switch will be polled between 20 and 200. The default value is 20.
Utilization	Check whether or not to display Utilization.

Packets

The Web Manager allows various packet statistics to be viewed as either a line graph or a table. Six windows are offered.

Received (RX)

Click the **Received (RX)** link in the **Packets** folder of the **Monitoring** menu to view the following graph of packets received on the Switch.

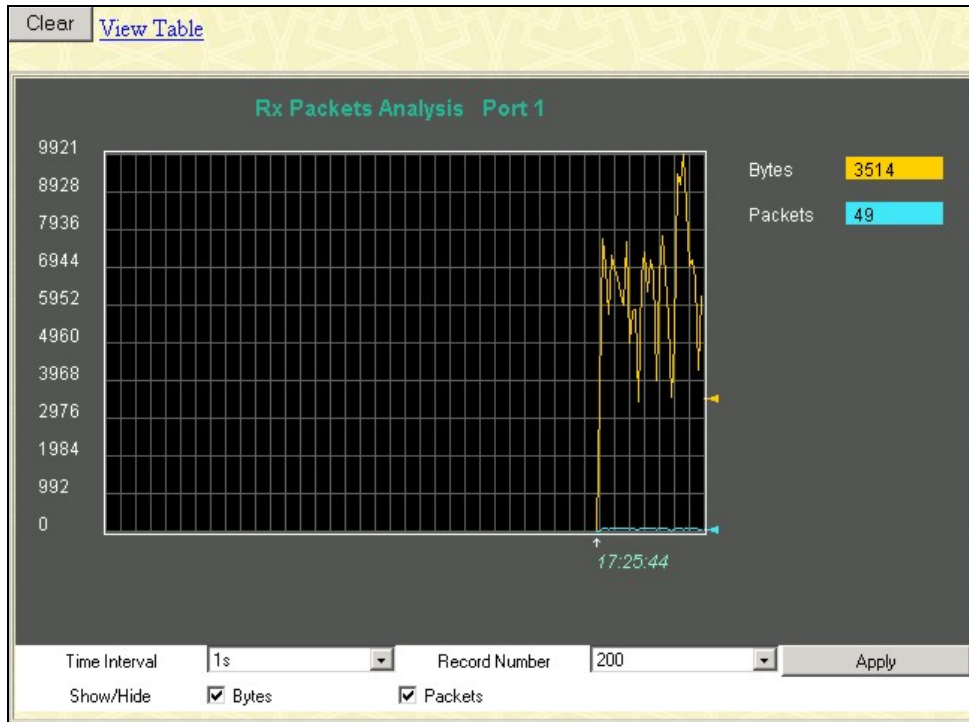

Figure 8- 3. Rx Packets Analysis window (line graph for Bytes and Packets)

To view the Received Packets Table, click the link [View Table](#), which will show the following table:

[View LineChart](#)

Packet Analysis of Port 1 Time Interval: 1s OK

Rx Packets	Total	Total/Sec
Bytes	2988642867	6754
Frames	22424630	86

Rx Packets	Total	Frames/Sec
Unicast	3501700	10
Multicast	6055624	2
Broadcast	12867306	74

Tx Packets	Total	Total/Sec
Bytes	396497496	3273
Frames	5850821	47

Figure 8- 4. Rx Packets Analysis window (table for Bytes and Packets)

The following fields may be set or viewed:

Parameter	Description
Time Interval	Select the desired setting between 1s and 60s, where "s" stands for seconds. The default value is one second.
Record Number	Select number of times the Switch will be polled between 20 and 200. The default value is 20.
Bytes	Counts the number of bytes received on the port.
Packets	Counts the number of packets received on the port.
Show/Hide	Check whether to display Bytes and Packets.
Clear	Clicking this button clears all statistics counters on this window.
View Table	Clicking this button instructs the Switch to display a table rather than a line graph.
View Line Chart	Clicking this button instructs the Switch to display a line graph rather than a table.

UMB Cast (RX)

Click the **UMB Cast (RX)** link in the **Packets** folder of the **Monitoring** menu to view the following graph of UMB cast packets received on the Switch.

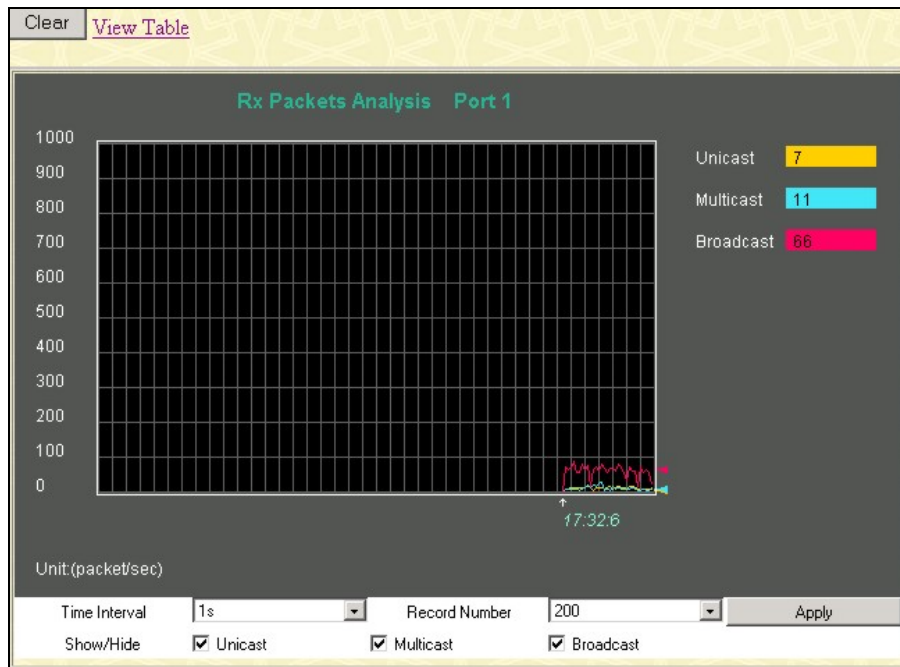

Figure 8- 5. Rx Packets Analysis window (line graph for Unicast, Multicast, and Broadcast Packets)

To view the UMB Cast Table, click the [View Table](#) link, which will show the following table:

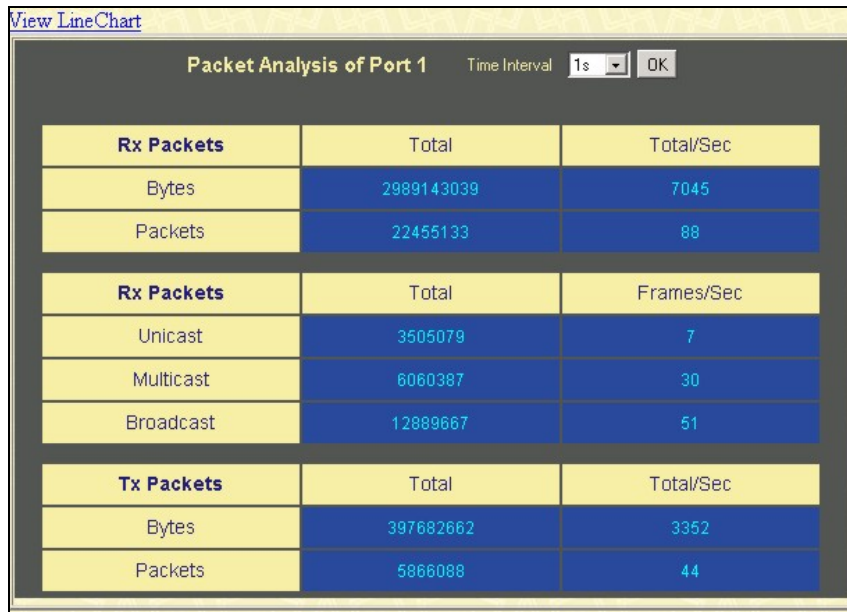

Figure 8- 6. Rx Packets Analysis window (table for Unicast, Multicast, and Broadcast Packets)

The following fields may be set or viewed:

Parameter	Description
Time Interval	Select the desired setting between 1s and 60s, where "s" stands for seconds. The default value is one second.
Record Number	Select number of times the Switch will be polled between 20 and 200. The default value is 20.
Unicast	Counts the total number of good packets that were received by a unicast address.
Multicast	Counts the total number of good packets that were received by a multicast address.
Broadcast	Counts the total number of good packets that were received by a broadcast address.
Show/Hide	Check whether or not to display Multicast, Broadcast, and Unicast Packets.
Clear	Clicking this button clears all statistics counters on this window.
View Table	Clicking this button instructs the Switch to display a table rather than a line graph.
View Line Chart	Clicking this button instructs the Switch to display a line graph rather than a table.

Transmitted (TX)

Click the **Transmitted (TX)** link in the **Packets** folder of the **Monitoring** menu to view the following graph of packets transmitted from the Switch.

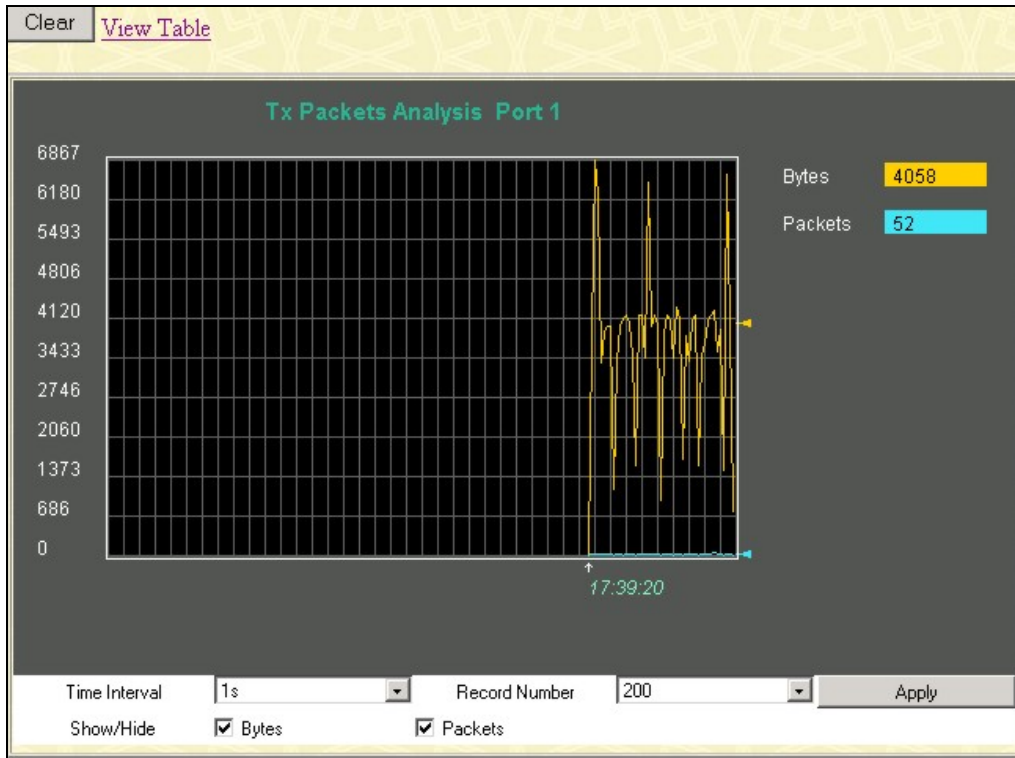

Figure 8- 7. Tx Packets Analysis window (line graph for Bytes and Packets)

To view the Transmitted (TX) Table, click the link [View Table](#), which will show the following table:

[View LineChart](#)

Packet Analysis of Port 1 Time Interval

Rx Packets	Total	Total/Sec
Bytes	2991951049	6917
Packets	22487982	87

Rx Packets	Total	Frames/Sec
Unicast	3509189	15
Multicast	6065216	11
Broadcast	12913577	61

Tx Packets	Total	Total/Sec
Bytes	399059734	3705
Packets	5882760	51

Figure 8- 8. Tx Packets Analysis window (table for Bytes and Packets)

The following fields may be set or viewed:

Parameter	Description
Time Interval	Select the desired setting between 1s and 60s, where "s" stands for seconds. The default value is one second.
Record Number	Select number of times the Switch will be polled between 20 and 200. The default value is 20.
Bytes	Counts the number of bytes successfully sent from the port.
Packets	Counts the number of packets successfully sent on the port.
Show/Hide	Check whether or not to display Bytes and Packets.
Clear	Clicking this button clears all statistics counters on this window.
View Table	Clicking this button instructs the Switch to display a table rather than a line graph.
View Line Chart	Clicking this button instructs the Switch to display a line graph rather than a table.

Errors

The Web Manager allows port error statistics compiled by the Switch's management agent to be viewed as either a line graph or a table. Four windows are offered.

Received (RX)

Click the **Received (RX)** link in the **Error** folder of the **Monitoring** menu to view the following graph of error packets received on the Switch.

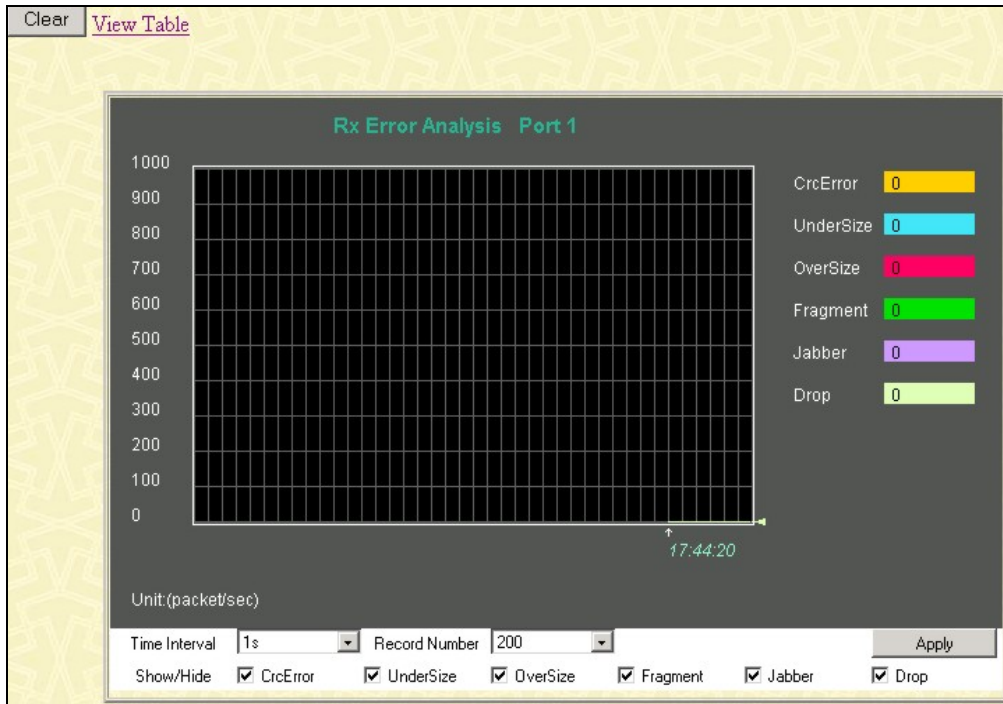

Figure 8- 9. Rx Error Analysis window (line graph)

To view the Received Error Packets Table, click the link **View Table**, which will show the following table:

The screenshot shows the 'Packet Analysis of Port 1' window. It has a 'View LineChart' link at the top left and a 'Time Interval' dropdown set to '1s' with an 'OK' button. Below this is a table with two columns: 'Rx Error' and 'Total'. The table contains the following data:

Rx Error	Total
Crc Error	0
Under Size	0
Over Size	0
Fragment	0
Jabber	0
Drop	996642

Figure 8- 10. Rx Error Analysis window (table)

The following fields can be set:

Parameter	Description
Time Interval	Select the desired setting between 1s and 60s, where "s" stands for seconds. The default value is one second.
Record Number	Select number of times the Switch will be polled between 20 and 200. The default value is 20.
Crc Error	Counts otherwise valid packets that did not end on a byte (octet) boundary.
Under Size	The number of packets detected that are less than the minimum permitted packets size of 64 bytes and have a good CRC. Undersize packets usually indicate collision fragments, a normal network occurrence.
Over Size	Counts packets received that were longer than 1518 octets, or if a VLAN frame is 1522 octets, and less than the MAX_PKT_LEN. Internally, MAX_PKT_LEN is equal to 1522.
Fragment	The number of packets less than 64 bytes with either bad framing or an invalid CRC. These are normally the result of collisions.
Jabber	The number of packets with lengths more than the MAX_PKT_LEN bytes. Internally, MAX_PKT_LEN is equal to 1522.
Drop	The number of packets that are dropped by this port since the last Switch reboot.
Show/Hide	Check whether or not to display Crc Error, Under Size, Over Size, Fragment, Jabber, and Drop errors.
Clear	Clicking this button clears all statistics counters on this window.
View Table	Clicking this button instructs the Switch to display a table rather than a line graph.
View Line Chart	Clicking this button instructs the Switch to display a line graph rather than a table.

Transmitted (TX)

Click the **Transmitted (TX)** link in the **Error** folder of the **Monitoring** menu to view the following graph of error packets received on the Switch.

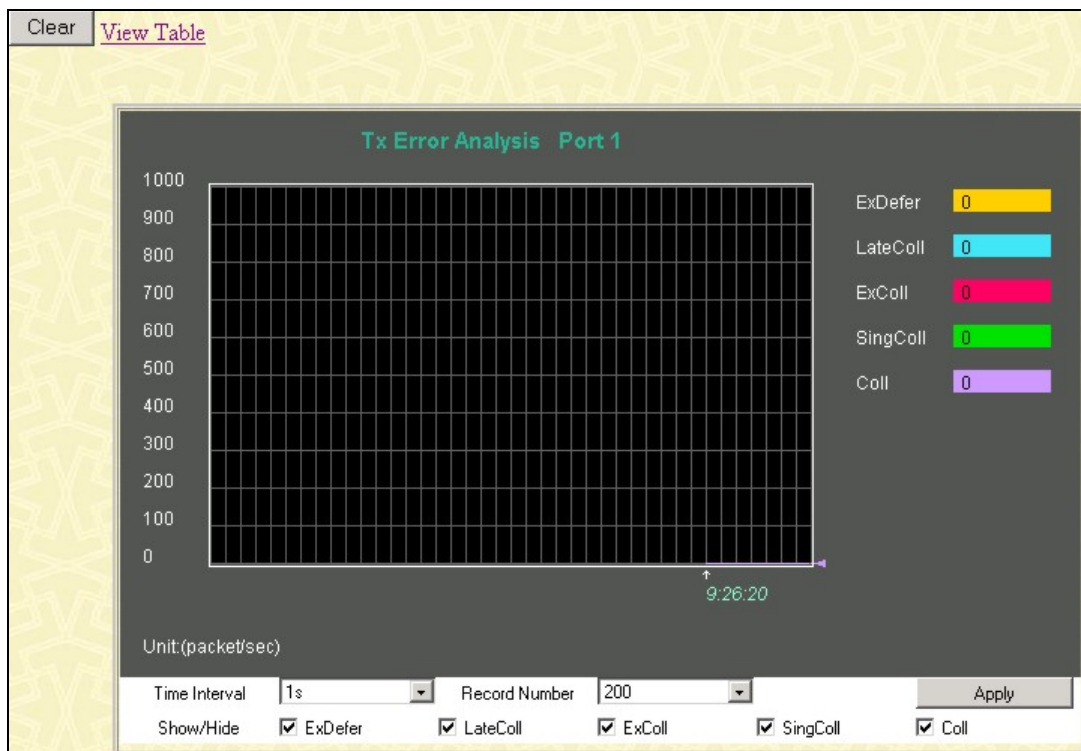

Figure 8- 11. Tx Error Analysis window (line graph)

To view the Transmitted Error Packets Table, click the link [View Table](#), which will show the following table:

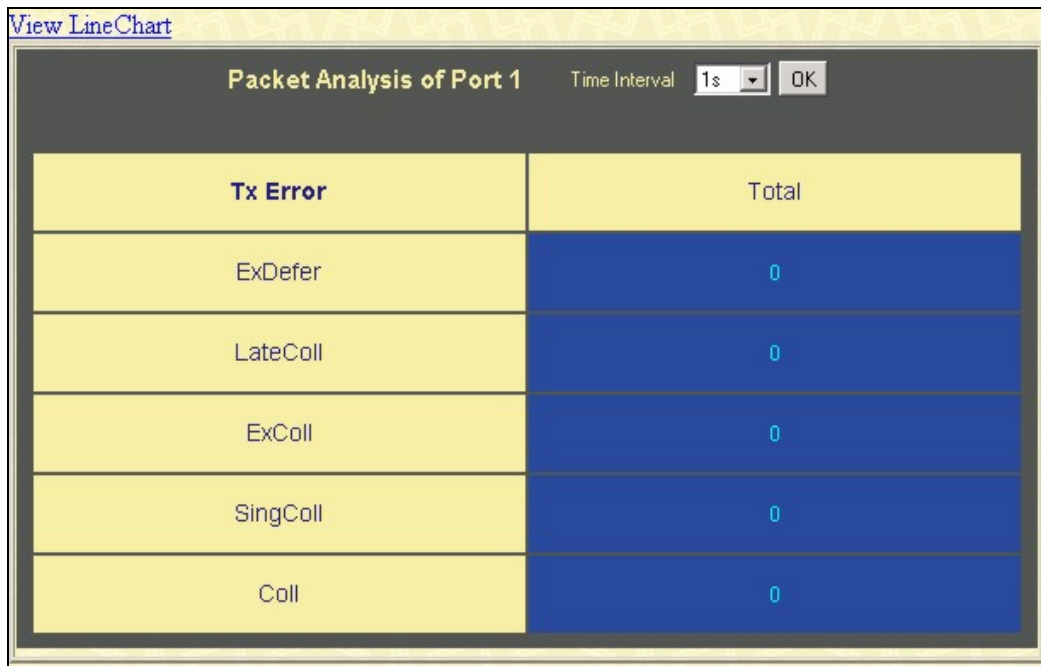

Figure 8- 12. Tx Error Analysis window (table)

The following fields may be set or viewed:

Parameter	Description
Time Interval	Select the desired setting between 1s and 60s, where "s" stands for seconds. The default value is one second.
Record Number	Select number of times the Switch will be polled between 20 and 200. The default value is 20.
ExDefer	Counts the number of packets for which the first transmission attempt on a particular interface was delayed because the medium was busy.
LateColl	Counts the number of times that a collision is detected later than 512 bit-times into the transmission of a packet.
ExColl	Excessive Collisions. The number of packets for which transmission failed due to excessive collisions.
SingColl	Single Collision Frames. The number of successfully transmitted packets for which transmission is inhibited by more than one collision.
Coll	An estimate of the total number of collisions on this network segment.
Show/Hide	Check whether or not to display ExDefer, LateColl, ExColl, SingColl, and Coll errors.
Clear	Clicking this button clears all statistics counters on this window.
View Table	Clicking this button instructs the Switch to display a table rather than a line graph.
View Line Chart	Clicking this button instructs the Switch to display a line graph rather than a table.

Size

The Web Manager allows packets received by the Switch, arranged in six groups and classed by size, to be viewed as either a line graph or a table. Two windows are offered.

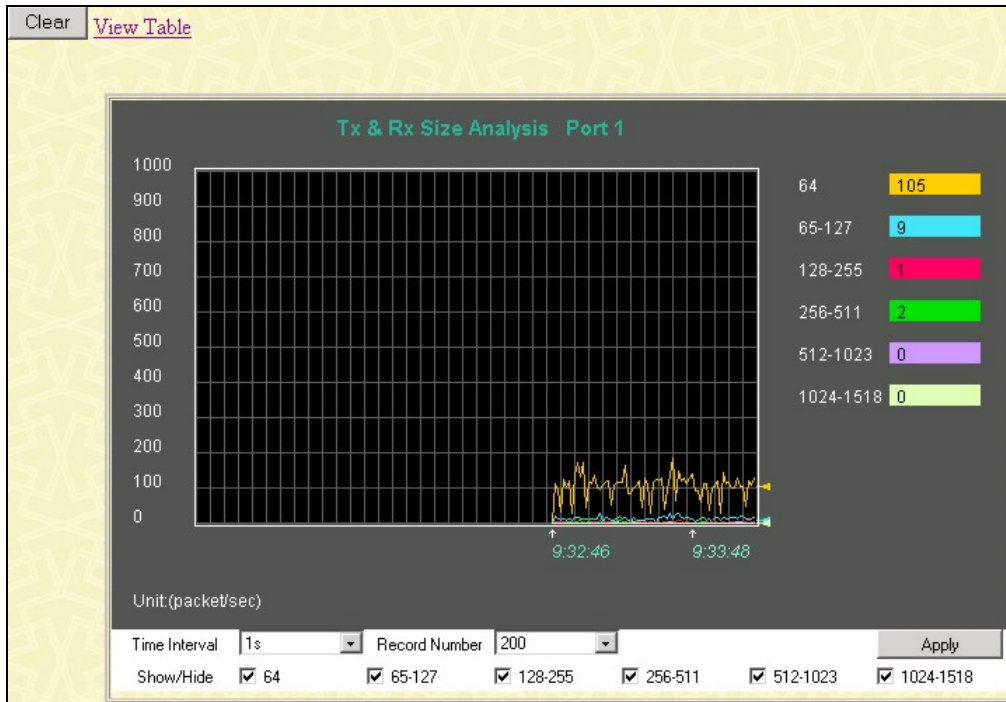

Figure 8- 13. Rx Size Analysis window (line graph)

To view the Packet Size Analysis Table, click the link [View Table](#), which will show the following table:

The screenshot shows a window titled "Packet Analysis of Port 1" with a "View Line Chart" link at the top left. The window contains a table with the following data:

Tx/Rx Size	Total	Frames/Sec
64	131554	41
65-127	16590	9
128-255	3840	6
256-511	1315	2
512-1023	326	0
1024-1518	220	0

At the top right of the window, there is a "Time Interval" dropdown set to "1s" and an "OK" button.

Figure 8- 14. Rx Size Analysis window (table)

The following fields can be set or viewed:

Parameter	Description
Time Interval	Select the desired setting between 1s and 60s, where "s" stands for seconds. The default value is one second.
Record Number	Select number of times the Switch will be polled between 20 and 200. The default value is 20.
64	The total number of packets (including bad packets) received that were 64 octets in length (excluding framing bits but including FCS octets).

65-127	The total number of packets (including bad packets) received that were between 65 and 127 octets in length inclusive (excluding framing bits but including FCS octets).
128-255	The total number of packets (including bad packets) received that were between 128 and 255 octets in length inclusive (excluding framing bits but including FCS octets).
256-511	The total number of packets (including bad packets) received that were between 256 and 511 octets in length inclusive (excluding framing bits but including FCS octets).
512-1023	The total number of packets (including bad packets) received that were between 512 and 1023 octets in length inclusive (excluding framing bits but including FCS octets).
1024-1518	The total number of packets (including bad packets) received that were between 1024 and 1518 octets in length inclusive (excluding framing bits but including FCS octets).
Show/Hide	Check whether or not to display 64, 65-127, 128-255, 256-511, 512-1023, and 1024-1518 packets received.
Clear	Clicking this button clears all statistics counters on this window.
View Table	Clicking this button instructs the Switch to display a table rather than a line graph.
View Line Chart	Clicking this button instructs the Switch to display a line graph rather than a table.

MAC Address

This allows the Switch's dynamic MAC address forwarding table to be viewed. When the Switch learns an association between a MAC address and a port number, it makes an entry into its forwarding table. These entries are then used to forward packets through the Switch.

To view the MAC Address forwarding table, from the **Monitoring** menu, click the **MAC Address** link:

The screenshot shows a web interface for viewing the MAC Address Table. At the top, there are search filters for VLAN ID, MAC Address, and Port, each with a 'Find' and 'Delete' button. Below these are 'View All Entry' and 'Delete All Entry' buttons. The main area is titled 'MAC Address Table' and contains a table with the following data:

VID	MAC Address	Port	Learned
1	00-00-00-44-73-07	1	Dynamic
1	00-00-00-44-73-08	1	Dynamic
1	00-00-00-52-33-00	1	Dynamic
1	00-00-50-06-73-bd	1	Dynamic
1	00-00-55-46-03-00	1	Dynamic
1	00-00-55-56-67-78	1	Dynamic
1	00-00-e2-58-db-cf	1	Dynamic
1	00-00-e2-82-7d-90	1	Dynamic
1	00-01-02-03-04-01	1	Dynamic
1	00-01-06-30-10-63	1	Dynamic
1	00-01-24-02-45-00	1	Dynamic
1	00-01-30-12-13-02	1	Dynamic
1	00-02-06-12-34-56	1	Dynamic
1	00-02-3f-70-d8-fe	1	Dynamic
1	00-03-09-18-10-01	1	Dynamic
1	00-03-10-31-30-00	1	Dynamic
1	00-03-47-93-11-34	1	Dynamic
1	00-05-5d-19-a5-ab	1	Dynamic
1	00-05-5d-68-5d-9a	1	Dynamic
1	00-05-5d-7e-91-c0	1	Dynamic

At the bottom of the table, there is a 'Next' button and a 'Total Entries: 221' label.

Figure 8- 15. MAC Address Table window

The following fields can be viewed or set:

Parameter	Description
VLAN ID	Enter a VLAN ID for the forwarding table to be browsed by.
MAC Address	Enter a MAC address for the forwarding table to be browsed by.
Find	Allows the user to move to a sector of the database corresponding to a user defined port, VLAN, or MAC address.
VID	The VLAN ID of the VLAN the port is a member of.
MAC Address	The MAC address entered into the address table.
Port	The port that the MAC address above corresponds to.
Learned	How the Switch discovered the MAC address. The possible entries are Dynamic, Self, and Static.
Next	Click this button to view the next page of the address table.
View All Entry	Clicking this button will allow the user to view all entries of the address table.
Delete All Entry	Clicking this button will allow the user to delete all entries of the address table.

Switch History Log

The Web manager allows the Switch's history log, as compiled by the Switch's management agent, to be viewed. To view the Switch history log, open the **Maintenance** folder and click the **Switch History Log** link.

Switch History		
Sequence	Time	Log Text
14	00000 days 00:00:38	Successful login through Web (Username: admin, IP: 10.42.73.20, MAC: 00-50-BA-F4-D6-7F)
13	00000 days 00:00:29	Port 24 link up, 100Mbps FULL duplex
12	00000 days 00:00:29	Spanning Tree Protocol is disabled
11	00000 days 00:00:28	System cold start
10	00002 days 00:52:22	Configuration and log saved to flash by console (Username: Anonymous)
9	00002 days 00:47:39	Successful login through Console (Username: Anonymous)
8	00001 days 06:23:16	Successful login through Web (Username: admin, IP: 10.42.73.20, MAC: 00-50-BA-F4-D6-7F)
7	00001 days 00:31:05	Successful login through Web (Username: admin, IP: 10.42.73.73, MAC: 00-0C-6E-AA-B9-C0)
6	00000 days 02:04:50	Port 7 link up, 100Mbps FULL duplex
5	00000 days 02:04:46	Port 7 link down
4	00000 days 02:04:17	Port 7 link up, 100Mbps FULL duplex
3	00000 days 00:00:28	Spanning Tree Protocol is disabled
2	00000 days 00:00:28	System cold start
1	00000 days 00:06:33	Configuration and log saved to flash by console (Username: Anonymous)

Figure 8- 16. Switch History window

The Switch can record event information in its own logs, to designated SNMP trap receiving stations, and to the PC connected to the console manager. Click **Next** to go to the next page of the Switch History Log. Clicking **Clear** will allow the user to clear the Switch History Log.

The information is described as follows:

Parameter	Description
Sequence	A counter incremented whenever an entry to the Switch's history log is made. The table displays the last entry (highest sequence number) first.
Time	Displays the time in days, hours, and minutes since the Switch was last restarted.
Log Text	Displays text describing the event that triggered the history log entry.



NOTE: For detailed information regarding Log entries that will appear in this window, please refer to Appendix C at the back of this manual.

IGMP Snooping Group

IGMP Snooping allows the Switch to read the Multicast Group IP address and the corresponding MAC address from IGMP packets that pass through the Switch. The number of IGMP reports that were snooped is displayed in the Reports field.

To view the **IGMP Snooping Table**, click **IGMP Snooping Group** in the **Monitoring** menu:

IGMP Snooping Table												
VLAN ID	Multicast Group	MAC Address	Queries	Reports								
0	0.0.0.0	00:00:00:00:00:00	Non-Querier	0								
Ports												
1	2	3	4	5	6	7	8	9	10	11	12	13
14	15	16	17	18	19	20	21	22	23	24	25	26
Total Entries: 0												

Figure 8- 17. IGMP Snooping Table window

The user may search the IGMP Snooping Table by VLAN ID (VID) by entering the VID in the top left hand corner and clicking **Search**.



NOTE: The Switch supports up to 128 IGMP Snooping groups.

The following field can be viewed:

Parameter	Description
VLAN ID	The VLAN ID (VID) of the multicast group.
Multicast Group	The IP address of the multicast group.
MAC Address	The MAC address of the multicast group.
Queries	A read-only field showing the status of the Querier State. Disabled implies that the Switch is not transmitting IGMP Snooping Query packets, while Enabled means those packets are being transmitted.
Reports	The total number of reports received for this group.
Port Map	These are the ports where the IGMP packets were snooped are displayed.



NOTE: To configure IGMP snooping for the DES-3500 Series switches, go to the **Configuration** folder and select **IGMP**. Configuration and other information concerning IGMP snooping may be found in Section 6 of this manual under IGMP.

IGMP Snooping Forwarding

This window will display the current IGMP snooping forwarding table entries currently configured on the Switch. To view the following screen, open the **Monitoring** folder and click the **IGMP Snooping Forwarding** link.

The screenshot displays the IGMP Snooping Forwarding Table window. At the top, there is a search interface with a text box containing '0' and a 'Search' button. Below this is a blue header bar labeled 'IGMP Snooping Forwarding Table'. The main content area contains a table with three columns: 'VLAN ID', 'Multicast Group', and 'MAC Address'. The data row shows '0' for VLAN ID, '0.0.0.0' for Multicast Group, and '00:00:00:00:00:00' for MAC Address. Below the table is a 'Port Member' section with a grid of 26 ports, numbered 1 through 26. At the bottom left, it states 'Total Entries: 0'.

Figure 8- 18. IGMP Snooping Forwarding Table window

The user may search the IGMP Snooping Forwarding Table by VID clicking the top left hand corner **Search** button. The following field can be viewed:

Parameter	Description
VLAN ID	The VLAN ID (VID) of the multicast group.
Multicast Group	The IP address of the multicast group.
MAC Address	The MAC address of the multicast group.
Port Map	These are the ports where the IGMP packets were snooped are displayed.

VLAN Status

This allows the VLAN status for each of the Switch's ports to be viewed by VLAN. This window displays the ports on the Switch that are currently Egress or Tag ports. To view the following table, open the **Monitoring** folder and click the **VLAN Status** Link.

Total VLAN Entries: 2												
VLAN Status												
VLAN ID	VLAN Name			Status	Advertisemnet							
1	default			Static	Enabled							
Tag Ports												
1	2	3	4	5	6	7	8	9	10	11	12	13
	V	V	V									
14	15	16	17	18	19	20	21	22	23	24	25	26
Egress Ports												
1	2	3	4	5	6	7	8	9	10	11	12	13
E				E	E	E	E	E	E	E	E	E
14	15	16	17	18	19	20	21	22	23	24	25	26
E	E	E	E	E	E	E	E	E	E	E	E	E
												Next

Figure 8- 19. VLAN Status window

Router Port

This displays which of the Switch's ports are currently configured as router ports. A router port configured by a user (using the console or Web-based management interfaces) is displayed as a static router port, designated by S. D designates a router port that is dynamically configured by the Switch. To view the following window, open the **Monitoring** folder and click the **Router Port** link.

Total Router Port Entries: 2												
Router Port												
VLAN ID	VLAN Name											
1	default											
Static Router Port												
1	2	3	4	5	6	7	8	9	10	11	12	13
14	15	16	17	18	19	20	21	22	23	24	25	26
Dynamic Router Port												
1	2	3	4	5	6	7	8	9	10	11	12	13
14	15	16	17	18	19	20	21	22	23	24	25	26
												Next

Figure 8- 20. Router Port window

Port Access Control

The following windows are used to monitor 802.1x statistics of the Switch, on a per port basis. To view the **Port Access Control** windows, open the monitoring folder and click the **Port Access Control** folder. There are six windows to monitor.

Authenticator State

The following section describes the 802.1X Status on the Switch. To view the Authenticator State, click **Monitoring > Port Access Control > Authenticator State**.

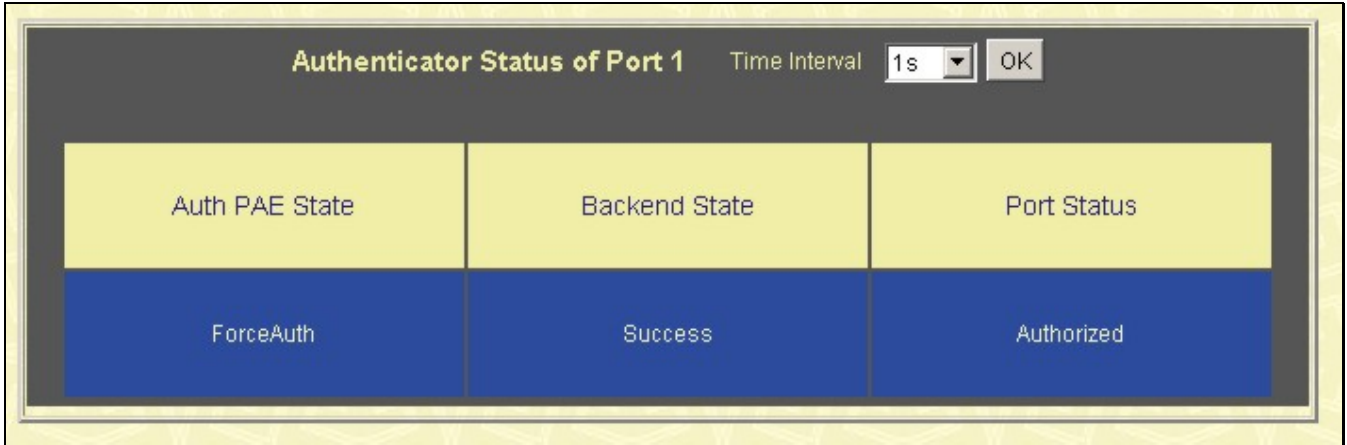

Figure 8- 21. Authenticator State window – Port-based 802.1x

Index	MAC Address	Auth PAE State	Backend State	Port Status
1	--	--	--	--
2	--	--	--	--
3	--	--	--	--
4	--	--	--	--
5	--	--	--	--
6	--	--	--	--
7	--	--	--	--
8	--	--	--	--
9	--	--	--	--
10	--	--	--	--
11	--	--	--	--
12	--	--	--	--
13	--	--	--	--
14	--	--	--	--
15	--	--	--	--
16	--	--	--	--

Figure 8- 22. Show Authenticator State window – MAC-Based 802.1x

This window displays the Authenticator State for individual ports on a selected device. To select unit within the switch stack, use the pull-down menu at the top of the window and click **Apply**. A polling interval between 1 and 60 seconds can be set using the drop-down menu at the top of the window and clicking **OK**.

The information on this window is described as follows:

Parameter	Description
Auth PAE State	The Authenticator PAE State value can be: <i>Initialize, Disconnected, Connecting, Authenticating, Authenticated, Aborting, Held, Force_Auth, Force_Unauth, or N/A</i> . N/A (Not Available) indicates that the port's authenticator capability is disabled.
Backend State	The Backend Authentication State can be <i>Request, Response, Success, Fail, Timeout, Idle, Initialize, or N/A</i> . N/A (Not Available) indicates that the port's authenticator capability is disabled.
Port Status	Controlled Port Status can be <i>Authorized, Unauthorized, or N/A</i> .

Layer 3 Feature

Browse ARP Table

The **ARP Table** window may be found in the **Monitoring** menu in the **Layer 3 Feature** folder. This window will show current ARP entries on the Switch. To search a specific ARP entry, enter an interface name into the Interface Name or an IP address and click **Find**.

Interface Name	<input type="text"/>		
IP Address	<input type="text" value="0.0.0.0"/>	<input type="button" value="Find"/>	<input type="button" value="Clear All"/>
ARP Table			
Interface Name	IP Address	MAC Address	Type
System	10.0.0.0	ff-ff-ff-ff-ff-ff	Local/Broadcast
System	10.0.25.77	00-d0-59-a9-2a-c4	Dynamic
System	10.0.46.1	00-80-c8-91-15-eb	Dynamic
System	10.0.51.12	00-50-ba-da-00-1d	Dynamic
System	10.0.58.4	00-0c-6e-43-13-ae	Dynamic
System	10.1.1.7	00-00-48-af-62-23	Dynamic
System	10.1.1.101	00-03-12-16-10-00	Dynamic
System	10.1.1.102	00-50-ba-97-d7-c0	Dynamic
System	10.1.1.103	00-50-ba-97-d7-c9	Dynamic
System	10.1.1.151	00-50-ba-70-d6-d0	Dynamic
System	10.1.1.152	00-13-00-00-00-01	Dynamic
System	10.1.1.154	00-50-ba-97-d9-56	Dynamic
System	10.1.1.156	00-50-ba-f5-f4-74	Dynamic
System	10.1.1.157	00-50-ba-71-20-d6	Dynamic
System	10.1.1.161	00-50-ba-70-e4-89	Dynamic
System	10.1.1.162	00-50-ba-70-e4-5a	Dynamic
System	10.1.1.163	00-50-ba-70-e4-55	Dynamic
System	10.1.1.164	00-50-ba-70-e4-65	Dynamic
System	10.1.1.166	00-50-ba-70-e4-58	Dynamic
System	10.1.1.167	00-50-ba-70-e4-45	Dynamic
Total Entries: 405			<input type="button" value="Next"/>

Figure 8- 23. ARP Table window

Safeguard Engine Status

The following window displays parameters configured for and about the **Safeguard Engine Status** currently set on the Switch.

Safeguard Engine Status	
State	Disabled
Current Status	Normal Mode
CPU Utilization Information	
Interval	5 sec
Rising Threshold (20-100)	100%
Falling Threshold (20-100)	20%
Trap / Log	Disabled

Figure 7- 46. Safeguard Engine Status and CPU Utilization Information window

The information is described as follows:

Parameter	Description
State	Displays the current running state of the Safeguard Engine, whether enabled or disabled.
Current Status	Displays the current running status of the Safeguard Engine, whether in exhausted mode or normal mode.
Interval	Displays the time interval between the checking of the rising and falling threshold of packets entering the Switch. The default setting is 5 seconds.
Rising Threshold	Displays the set percentage of the rising threshold of packets determinant of the Safeguard Engine.
Falling Threshold	Displays the set percentage of the falling threshold of packets determinant of the Safeguard Engine.
Trap/log	Displays the status of the sending of messages to the switch's log or SNMP trap. Enabled will denote the switch will send trap messages in the event of a Safeguard Engine engagement.

Section 9

Maintenance

- TFTP Services*
- Multiple Image Services*
- Switch History*
- Ping Test*
- Save Changes*
- Reboot Services*
- Logout*

TFTP Services

Trivial File Transfer Protocol (TFTP) services allow the Switch's firmware to be upgraded by transferring a new firmware file from a TFTP server to the Switch. A configuration file can also be loaded into the Switch from a TFTP server. Switch settings can be saved to the TFTP server, and a history log can be uploaded from the Switch to the TFTP server.

Download Firmware from TFTP Server

To update the Switch's firmware, open the **TFTP Services** folder, located in the **Maintenance** folder, and click the **Download Firmware** link:

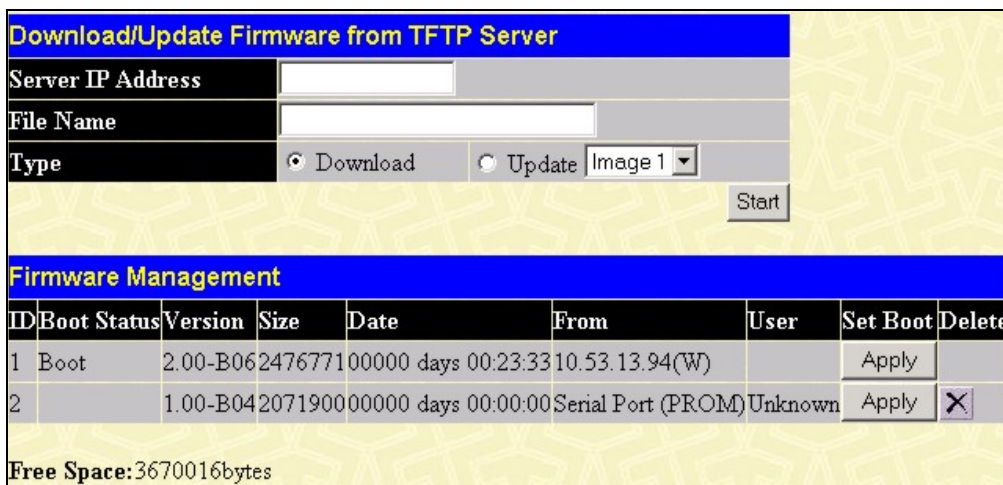

Figure 9- 1. Download/Update Firmware from TFTP Server window

The Switch can hold two firmware versions for the user, which can be specified in the **Type** field by clicking the **Update** radio button and selecting the *Image 1* or *Image 2*. To download or update firmware, configure the following fields and click **Start**.

Parameter	Description
Server IP	Enter the IP address of the server from which you wish to download firmware.
File Name	Specify the path and filename of the firmware on the Server.
Type	Specify the purpose of the firmware: <i>Download:</i> Clicking this radio button will specify a download to the Switch. This will be the firmware that the Switch will immediately use. <i>Update:</i> Clicking this radio button will save the firmware to the Switch's memory but not configure the Switch for this firmware. The Switch may hold two firmware versions specified as Section 1 and Section 2.

Information about firmware on the Switch can be viewed in the Firmware Management table in the same window. It holds the following information:

Parameter	Description
ID	The user-defined Section ID of the firmware on the Switch.
Boot Status	The firmware that is currently being run on the Switch will be identified in this field with the term "Boot".
Version	The runtime version of the firmware.
Size	The size of the firmware, in bytes.
Date	The date that the firmware was added to the Switch.
From	The IP address of the Server from which the firmware came.
User	The name of the user who downloaded the firmware.
Set Boot	Click the Apply button in this field to set the firmware version to be used upon the next boot up of the Switch.
Delete	Click the X in this column to permanently delete the corresponding firmware from the Switch.

Download Configuration File

To download a settings file from a TFTP server, click on the **TFTP Service** folder in the **Maintenance** folder and then the **Download Configuration File** link:

Figure 9- 2. Download Settings from TFTP Server window

Enter the IP address of the TFTP server and specify the location of the switch settings file on the TFTP server. Click **Start** to record the IP address of the TFTP server and to initiate the file transfer.

Upload Configuration

To upload the switch settings to a TFTP server, click on the **TFTP Services** folder, located in the **Maintenance** folder, and then click the **Upload Configuration** link:

Figure 9- 3. Upload Settings to TFTP Server window

Enter the IP address of the TFTP server and the path and filename for the switch settings on the TFTP server. Click **Start** to record the IP address of the TFTP server and to initiate the file transfer.

Upload Log

To upload the switch history log file to a TFTP server, open the **TFTP Services** folder in the **Maintenance** folder and then click the **Upload Log** link:

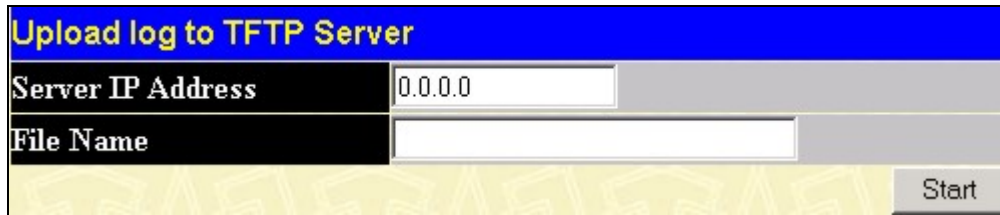

Upload log to TFTP Server	
Server IP Address	0.0.0.0
File Name	
Start	

Figure 9- 4. Upload Log to TFTP Server window

Enter the IP address of the TFTP server and the path and filename for the history log on the TFTP server. Click **Start** to record the IP address of the TFTP server and to initiate the file transfer.

Multiple Image Services

The **Multiple Image Services** folder allows users of the xStack family of switches to configure and view information regarding firmware located on the Switch. The Switch allows two firmware images to be stored in its memory and either can be configured to be the boot up firmware for the Switch. For information regarding firmware images located on the Switch, open the **Firmware Information** link. The default setting for the Switch's firmware will have the boot up firmware stored in Image 1, but the user may set either firmware stored to be the boot up firmware by using the **Config Firmware Image** window.

Firmware Information

The following screen allows the user to view information about current firmware images stored on the Switch. To access the following screen, click **Maintenance > MULTIPLE IMAGE Services > Firmware Information**.

Firmware Information						
BOX	ID	Version	Size	Update Time	From	User
1	1	*5.00-B25	2926425	00000 days 00:02:51	10.42.73.73	Anonymous

'*' means boot up firmware
 (T) means firmware update through TELNET
 (S) means firmware update through SNMP
 (W) means firmware update through WEB
 (SIM) means firmware update through Single IP Management

Figure 9- 5. Firmware Information window

This window holds the following information:

Parameter	Description
BOX	States the stacking ID number of the switch in the switch stack.
ID	States the image ID number of the firmware in the Switch's memory. The Switch can store 2 firmware images for use. Image ID 1 will be the default boot up firmware for the Switch unless otherwise configured by the user.
Version	States the firmware version.
Size	States the size of the corresponding firmware, in bytes.
Update Time	States the specific time the firmware version was downloaded to the Switch.
From	States the IP address of the origin of the firmware. There are five ways firmware may be downloaded to the Switch. <ul style="list-style-type: none"> • R – If the IP address has this letter attached to it, it denotes a firmware upgrade through the Console Serial Port (RS-232). • T - If the IP address has this letter attached to it, it denotes a firmware upgrade through Telnet. • S - If the IP address has this letter attached to it, it denotes a firmware upgrade through the Simple Network Management Protocol (SNMP). • W - If the IP address has this letter attached to it, it denotes a firmware upgrade through the web-based management interface. • SIM – If the IP address has this letter attached to it, it denotes a firmware upgrade

	through the Single IP Management feature.
User	States the user who downloaded the firmware. This field may read “Anonymous” or “Unknown” for users that are not identified.

Config Firmware Image

The **Config Firmware Image** window allows users to configure firmware images saved in the memory of the Switch. To access the following window, click **Maintenance > MULTIPLE IMAGE Services > Config Firmware Image**.

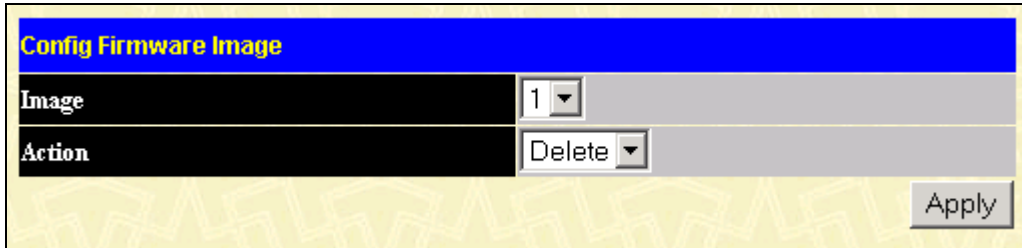

Figure 9- 6. Config Firmware Image window

This window offers the following information:

Parameter	Description
Image	Select the firmware image to be configured using the pull-down menu. The Switch allows two firmware images to be stored in the Switch’s memory.
Action	This field has two options for configuration. <ul style="list-style-type: none"> • <i>Delete</i> – Select this option to delete the firmware image specified in the Image field above. • <i>Boot</i> – Select this option to set the firmware image specified above as the boot up firmware for the Switch. This firmware will be set as the boot up firmware after a switch reboot has been performed. The default setting has firmware image ID 1 as the boot up firmware image for the Switch unless specified here.

Click **Apply** to implement changes made.

Ping Test

Ping is a small program that sends ICMP Echo packets to the IP address you specify. The destination node then responds to or "echoes" the packets sent from the Switch. This is very useful to verify connectivity between the Switch and other nodes on the network.

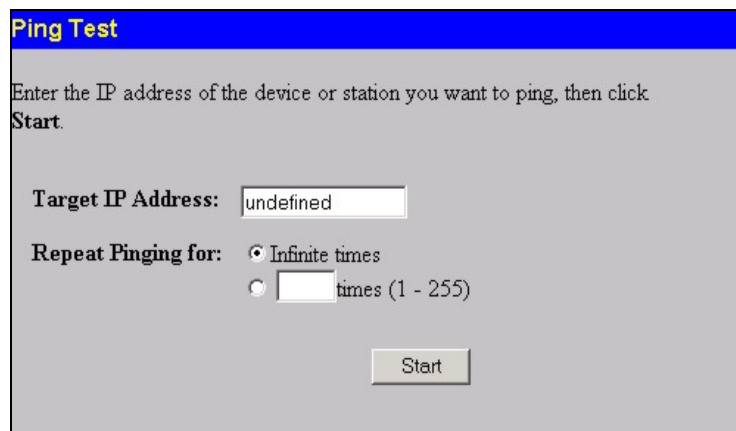

Figure 9- 7. Ping Test window

The user may use Infinite times radio button, in the Repeat Pinging for field, which will tell the ping program to keep sending ICMP Echo packets to the specified IP address until the program is stopped. The user may opt to choose a specific number of times to ping the Target IP Address by clicking its radio button and entering a number between 1 and 255. Click **Start** to initiate the Ping program.

Save Changes

The DES-3500 Series switches have two levels of memory; normal RAM and non-volatile or NV-RAM. Configuration changes are made effective by clicking the **Apply** button. When this is done, the settings will be immediately applied to the switching software in RAM, and will immediately take effect.

Some settings, though, require you to restart the Switch before they will take effect. Restarting the Switch erases all settings in RAM and reloads the stored settings from the NV-RAM. Thus, it is necessary to save all setting changes to NV-RAM before rebooting the Switch.

To retain any configuration changes permanently, click the **Save Changes** link in the **Maintenance** folder. The following window will appear:

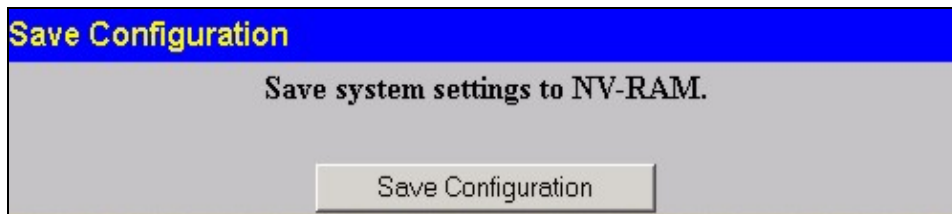

Figure 9- 8. Save Configuration window

Click the **Save Configuration** button to save the current switch configuration in NV-RAM. The following dialog box will confirm that the configuration has been saved:



Figure 9- 9. Save Configuration Confirmation dialog box

Click the **OK** button to continue. Once the Switch configuration settings have been saved to NV-RAM, they become the default settings for the Switch. These settings will be used every time the Switch is rebooted.

Reset

The Reset function has several options when resetting the Switch. Some of the current configuration parameters can be retained while resetting all other configuration parameters to their factory defaults.



NOTE: Only the Reset System option will enter the factory default parameters into the Switch's non-volatile RAM, and then restart the Switch. All other options enter the factory defaults into the current configuration, but do not save this configuration. Reset System will return the Switch's configuration to the state it was when it left the factory

Reset gives the option of retaining the Switch's User Accounts and History Log while resetting all other configuration parameters to their factory defaults. If the Switch is reset using this window, and **Save Changes** is not executed, the Switch will return to the last saved configuration when rebooted.

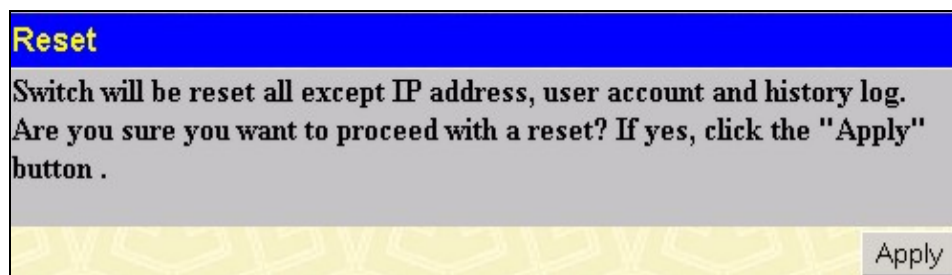

Figure 9- 10. Reset window

Reset System

In addition, the Reset System option is added to reset all configuration parameters to their factory defaults, save these parameters to the Switch's non-volatile RAM, and then restart the Switch. This option is equivalent to Reset Config followed by **Save Changes**.

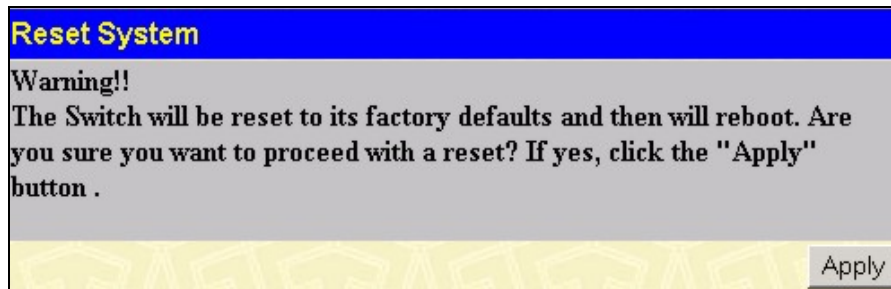

Figure 9- 11. Reset System window

Reset Config

The Reset Config option will reset all of the Switch's configuration parameters to their factory defaults, without saving these default values to the Switch's non-volatile RAM. If the Switch is reset with this option enabled, and **Save Changes** is not executed, the Switch will return to the last saved configuration when rebooted.

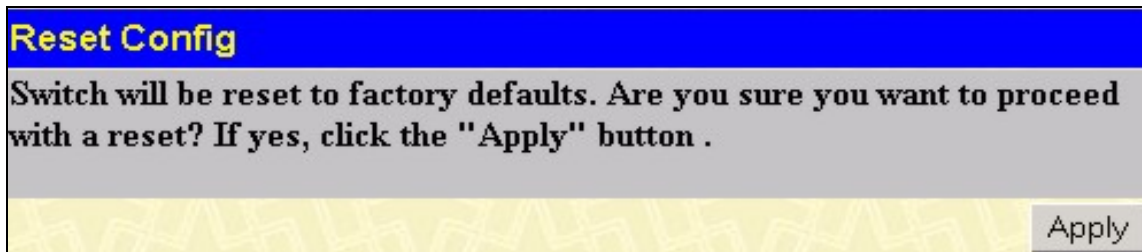

Figure 9- 12. Reset Config window

Reboot Device

The following window is used to restart the Switch.

All of the configuration information entered from the last time **Save Changes** was executed will be lost. Click the **Reboot** button to restart the Switch.

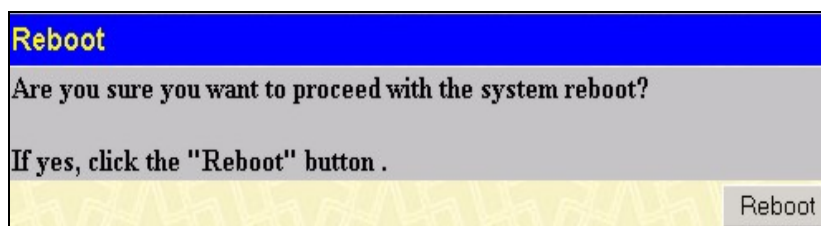

Figure 9- 13. Reboot window

Logout

Use the Logout page to logout of the Switch's Web-based management agent by clicking on the Log Out button.

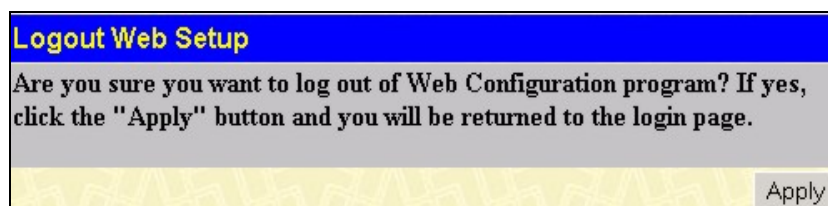

Figure 9- 14. Logout Web Setup window

Section 10

D-Link Single IP Management

Single IP Management (SIM) Overview

Topology

Firmware Upgrade

Configuration Backup/Restore

Single IP Management (SIM) Overview

Simply put, D-Link Single IP Management is a concept that will stack switches together over Ethernet instead of using stacking ports or modules. There are some advantages in implementing the "Single IP Management" feature:

1. SIM can simplify management of small workgroups or wiring closets while scaling the network to handle increased bandwidth demand.
2. SIM can reduce the number of IP address needed in your network.
3. SIM can eliminate any specialized cables for stacking connectivity and remove the distance barriers that typically limit your topology options when using other stacking technology.

Switches using D-Link Single IP Management (labeled here as SIM) must conform to the following rules:

- SIM is an optional feature on the Switch and can easily be enabled or disabled through the Command Line Interface or Web Interface. SIM grouping has no effect on the normal operation of the Switch in the user's network.
- There are three classifications for switches using SIM. The **Commander Switch (CS)**, which is the master switch of the group, **Member Switch (MS)**, which is a switch that is recognized by the CS a member of a SIM group, and a **Candidate Switch (CaS)**, which is a Switch that has a physical link to the SIM group but has not been recognized by the CS as a member of the SIM group.
- A SIM group can only have one Commander Switch (CS).
- All switches in a particular SIM group must be in the same IP subnet (broadcast domain). Members of a SIM group cannot cross a router.
- A SIM group accepts one Commander Switch (numbered 0) and up to 32 switches (numbered 0-31).

There is no limit to the number of SIM groups in the same IP subnet (broadcast domain), however a single switch can only belong to one group.

If multiple VLANs are configured, the SIM group will only utilize the system VLAN that has been assigned the switch's IP address.

SIM allows intermediate devices that do not support SIM. This enables the user to manage switches that are more than one hop away from the CS.

The SIM group is a group of switches that are managed as a single entity. The DES-3500 Series switches may take on three different roles:

1. **Commander Switch (CS)** - This is a switch that has been manually configured as the controlling device for a group, and takes on the following characteristics:
 - It has an IP Address.
 - It is not a command switch or member switch of another Single IP group.
 - It is connected to the member switches through its management VLAN.
2. **Member Switch (MS)** - This is a switch that has joined a single IP group and is accessible from the CS, and it takes on the following characteristics:
 - It is not a CS or MS of another IP group.
 - It is connected to the CS through the CS management VLAN.
3. **Candidate Switch(CaS)** - This is a switch that is ready to join a SIM group but is not yet a member of the SIM group. The Candidate Switch may join the SIM group through an automatic function of the DES-3500 Series switches, or by manually configuring it to be a MS of a SIM group. A switch configured as a CaS is not a member of a SIM group and will take on the following characteristics:

- It is not a CS or MS of another Single IP group.
- It is connected to the CS through the CS management VLAN

The following rules also apply to the above roles:

- Each device begins in a Commander state.
- CS's must change their role to CaS and then to MS, to become a MS of a SIM group. Thus the CS cannot directly be converted to a MS.
- The user can manually configure a CS to become a CaS.

A MS can become a CaS by:

- Being configured as a CaS through the CS.
- If report packets from the CS to the MS time out.
- The user can manually configure a CaS to become a CS
- The CaS can be configured through the CS to become a MS.

After configuring one switch to operate as the CS of a SIM group, additional DES-3500 Series switches may join the group either by an automatic method or by manually configuring the Switch to be a MS. The CS will then serve as the in band entry point for access to the MS. The CS's IP address will become the path to all MS's of the group and the CS's Administrator's password, and/or authentication will control access to all MS's of the SIM group.

With SIM enabled, the applications in the CS will redirect the packet instead of executing the packets. The applications will decode the packet from the administrator, modify some data, and then send it to the MS. After execution, the CS may receive a response packet from the MS, which it will encode and send it back to the administrator.

When a CS becomes a MS, it automatically becomes a member of the first SNMP community (include read/write and read only) to which the CS belongs. However, if a MS has its own IP address, it can belong to SNMP communities to which other switches in the group, including the CS, do not belong.

The Upgrade to v1.6

To better improve SIM management, the xStack DES-3500 Series switches have been upgraded to version 1.6 in this release. Many improvements have been made, including:

1. The Commander Switch (CS) now has the capability to automatically rediscover member switches that have left the SIM group, either through a reboot or web malfunction. This feature is accomplished through the use of Discover packets and Maintain packets that previously set SIM members will emit after a reboot. Once a MS has had its MAC address and password saved to the CS's database, if a reboot occurs in the MS, the CS will keep this MS information in its database and when a MS has been rediscovered, it will add the MS back into the SIM tree automatically. No configuration will be necessary to rediscover these switches.

There are some instances where pre-saved MS switches cannot be rediscovered. For example, if the Switch is still powered down, if it has become the member of another group, or if it has been configured to be a Commander Switch, the rediscovery process cannot occur.

2. The topology map now includes new features for connections that are a member of a port trunking group. It will display the speed and number of Ethernet connections creating this port trunk group, as shown in the adjacent picture.



NOTE: For more details regarding improvements made in SIMv1.6, please refer to the **D-Link Single IP Management** White Paper located on the D-Link website.

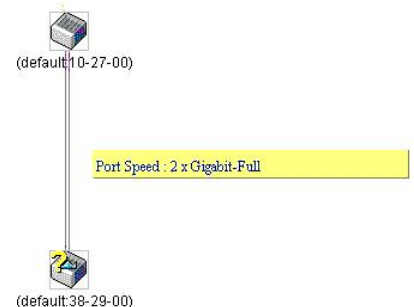

3. This version will support multiple switch upload and downloads for firmware, configuration files and log files, as follows:

Firmware – The switch now supports multiple MS firmware downloads from a TFTP server.

Configuration Files – This switch now supports multiple downloading and uploading of configuration files both to (for configuration restoration) and from (for configuration backup) MS's, using a TFTP server.

Log – The switch now supports uploading multiple MS log files to a TFTP server.

4. The user may zoom in and zoom out when utilizing the topology window to get a better, more defined view of the configurations.

SIM Using the Web Interface

All DES-3500 Series switches are set as Candidate (CaS) switches, as their factory default configuration and Single IP Management will be disabled. To enable SIM for the Switch using the Web interface, go to the **Single IP Management** folder and click the **SIM Settings** link, revealing the following window.

The screenshot shows a web interface window titled "SIM Settings" with a blue header. Below the header, there is a form with a "SIM State" label and a pull-down menu currently set to "Disabled". At the bottom right of the form is an "Apply" button.

Figure 10- 1. SIM Settings window (disabled)

Change the **SIM State** to *Enabled* using the pull-down menu and click **Apply**. The window will then refresh and the **SIM Settings** window will look like this:

The screenshot shows the "SIM Settings" window after being updated. The "SIM State" pull-down menu is now set to "Enabled". Below it, the "Role State" pull-down menu is set to "Candidate". There are two input fields: "Discovery Interval" with the value "30" and a range "(30..90 sec)", and "Holdtime" with the value "100" and a range "(100..255 sec)". An "Apply" button is located at the bottom right.

Figure 10- 2. SIM Settings window (enabled)

The following parameters can be set:

Parameters	Description
SIM State	Use the pull-down menu to either enable or disable the SIM state on the Switch. <i>Disabled</i> will render all SIM functions on the Switch inoperable.
Role State	Use the pull-down menu to change the SIM role of the Switch. The two choices are: <i>Candidate</i> - A Candidate Switch (CaS) is not the member of a SIM group but is connected to a Commander Switch. This is the default setting for the SIM role of the DES-3500 Series switches. <i>Commander</i> - Choosing this parameter will make the Switch a Commander Switch (CS). The user may join other switches to this Switch, over Ethernet, to be part of its SIM group. Choosing this option will also enable the Switch to be configured for SIM.
Discovery Interval	The user may set the discovery protocol interval, in seconds that the Switch will send out discovery packets. Returning information to a Commander Switch will include information about other switches connected to it. (Ex. MS, CaS). The user may set the Discovery Interval from 30 to 90 seconds.
Holdtime	This parameter may be set for the time, in seconds; the Switch will hold information sent to it from other switches, utilizing the Discovery Interval. The user may set the hold time from 100 to 255 seconds.
Group Name	The user may enter a Group Name of up to 64 characters to define the SIM group created.

Click **Apply** to implement the settings changed.

After enabling the Switch to be a Commander Switch (CS), the **Single IP Management** folder will then contain four added links to aid the user in configuring SIM through the web, including **Topology**, **Firmware Upgrade**, **Configuration Backup/Restore** and **Upload Log File**.

Topology

The **Topology** window will be used to configure and manage the Switch within the SIM group and requires Java script to function properly on your computer. The following message should appear the first time the user clicks the **Topology** link in the **Single IP Management** folder.

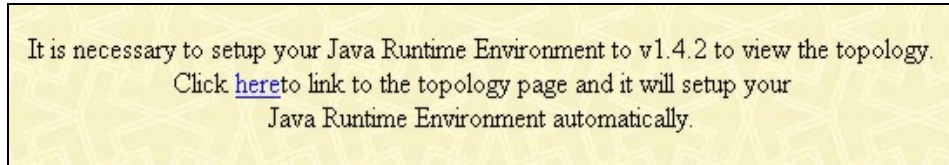

Figure 10- 3. Java window

Clicking the [here](#) link will setup the Java Runtime Environment on your server and lead you to the topology window, as seen below.

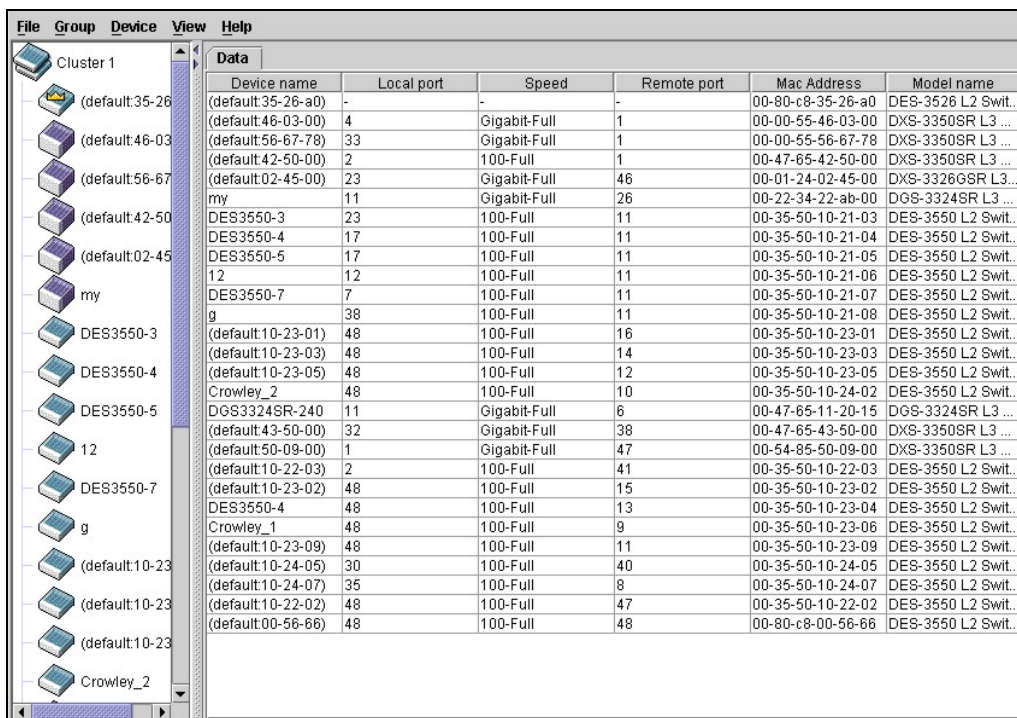

Figure 10- 4. Single IP Management window-Tree View

The Tree View window holds the following information under the Data tab:

Parameter	Description
Device Name	This field will display the Device Name of the switches in the SIM group configured by the user. If no Device Name is configured by the name, it will be given the name default and tagged with the last six digits of the MAC Address to identify it.
Local Port	Displays the number of the physical port on the CS that the MS or CaS is connected to. The CS will have no entry in this field. The CS will not display an entry in this field.
Speed	Displays the connection speed between the CS and the MS or CaS. The CS will not display an entry in this field.
Remote Port	Displays the number of the physical port on the MS or CaS that the CS is connected to. The CS will have no entry in this field. The CS will not display an entry in this field.
MAC Address	Displays the MAC Address of the corresponding Switch.
Model Name	Displays the full Model Name of the corresponding Switch.

To view the **Topology Map**, click the **View** menu in the toolbar and then **Topology**, which will produce the following window. The **Topology View** will refresh itself periodically (20 seconds by default).

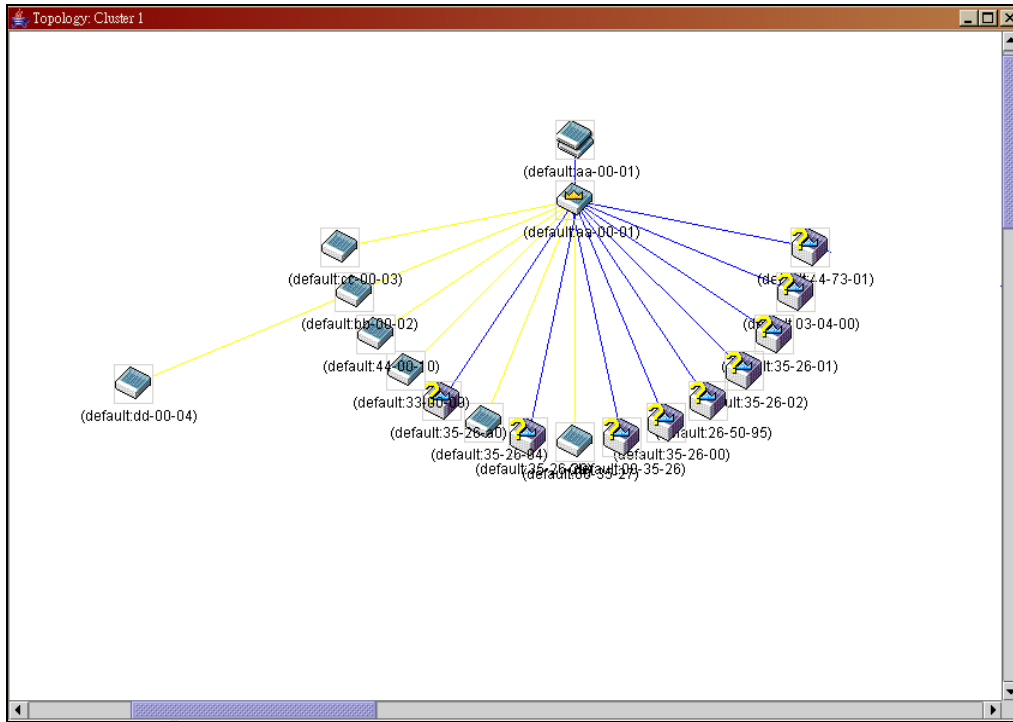













Figure 10- 5. Topology view

This window will display how the devices within the Single IP Management Group are connected to other groups and devices. Possible icons in this window are as follows:

Icon	Description
	Group
	Layer 2 commander switch
	Layer 3 commander switch
	Commander switch of other group
	Layer 2-member switch.
	Layer 3 member switch
	Member switch of other group
	Layer 2 candidate switch
	Layer 3 candidate switch
	Unknown device
	Non-SIM devices

Tool Tips

In the Topology view window, the mouse plays an important role in configuration and in viewing device information. Setting the mouse cursor over a specific device in the topology window (tool tip) will display the same information about a specific device as the Tree view does. See the window below for an example.

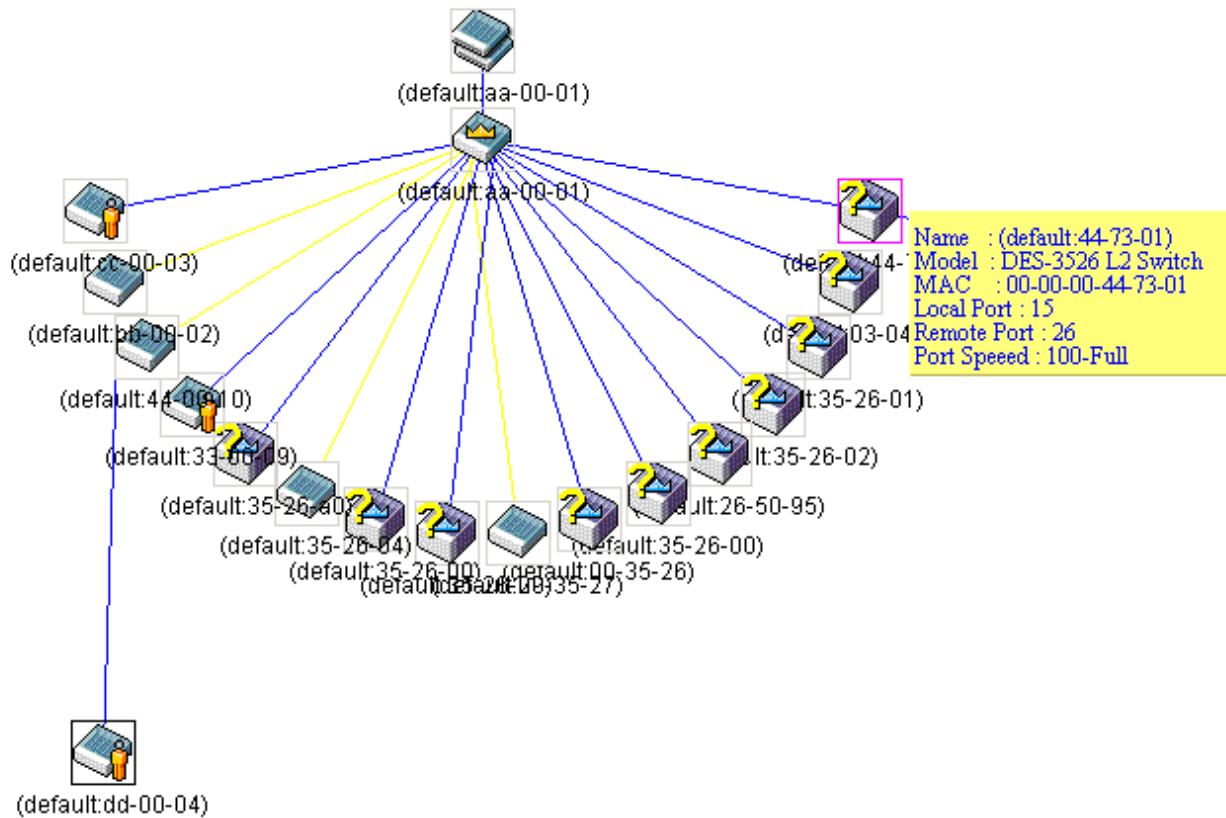

Figure 10- 6. Device Information Utilizing the Tool Tip

Setting the mouse cursor over a line between two devices will display the connection speed between the two devices, as shown below.

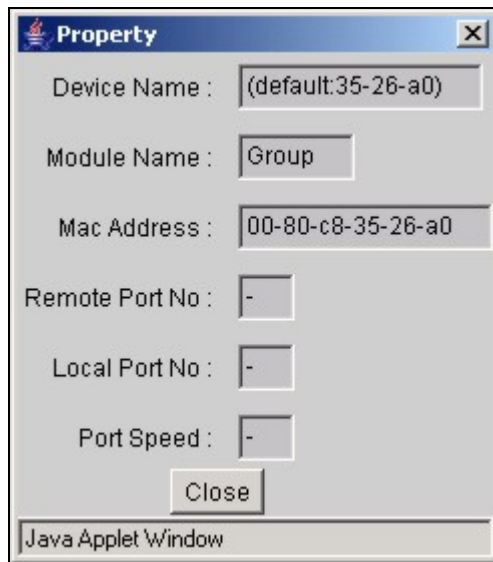

Figure 10- 9. Property window

Commander Switch Icon

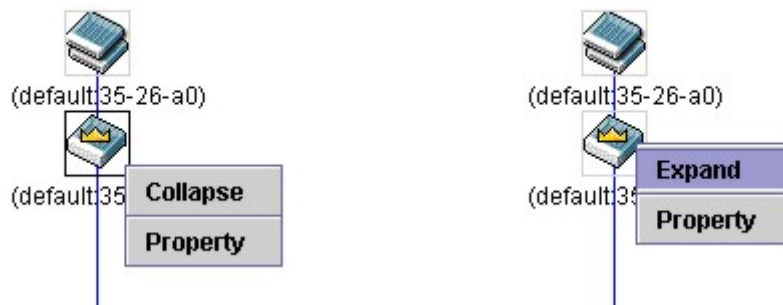

Figure 10- 10. Right-Clicking a Commander Icon

The following options may appear for the user to configure:

- **Collapse** - to collapse the group that will be represented by a single icon.
- **Expand** - to expand the SIM group, in detail.
- **Property** - to pop up a window to display the group information.

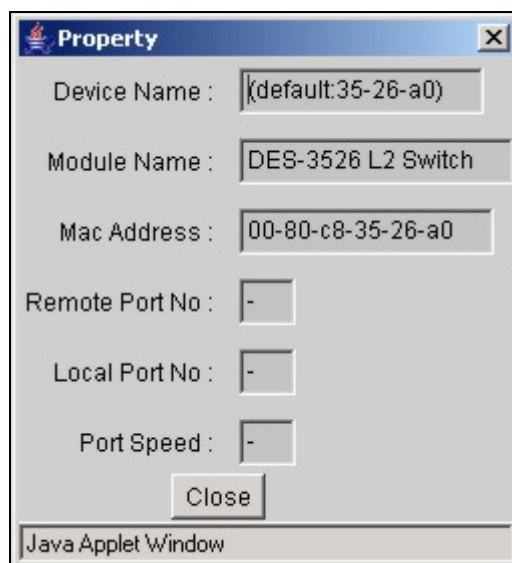

Figure 10- 11. Property window

Member Switch Icon

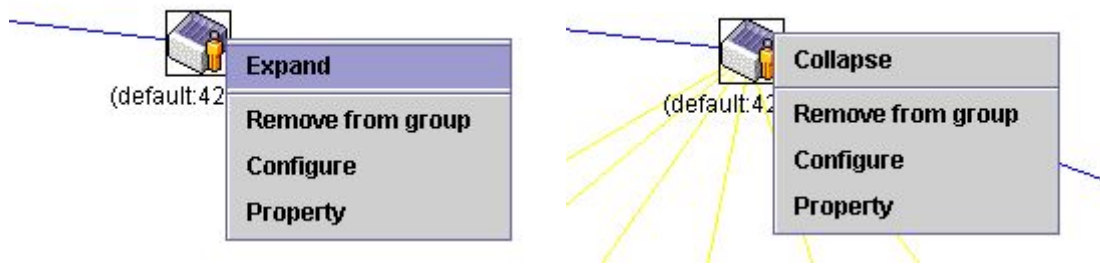

Figure 10- 12. Right-Clicking a Member icon

The following options may appear for the user to configure:

- **Collapse** - to collapse the group that will be represented by a single icon.
- **Expand** - to expand the SIM group, in detail.
- **Remove from group** - remove a member from a group.
- **Configure** - launch the web management to configure the Switch.
- **Property** - to pop up a window to display the device information.

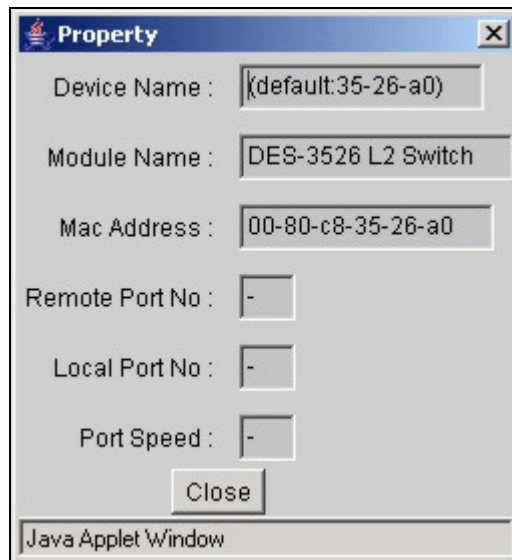

Figure 10- 13. Property window

Candidate Switch Icon

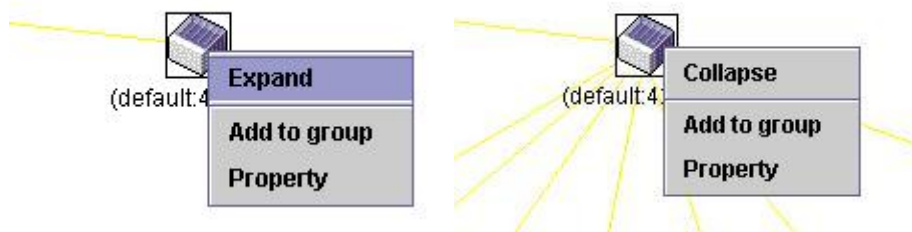

Figure 10- 14. Right-Clicking a Candidate icon

The following options may appear for the user to configure:

- **Collapse** - to collapse the group that will be represented by a single icon.
- **Expand** - to expand the SIM group, in detail.

- **Add to group** - add a candidate to a group. Clicking this option will reveal the following dialog box for the user to enter a password for authentication from the Candidate Switch before being added to the SIM group. Click **OK** to enter the password or **Cancel** to exit the window.



Figure 10- 15. Input password dialog box

- **Property** - to pop up a window to display the device information, as shown below.

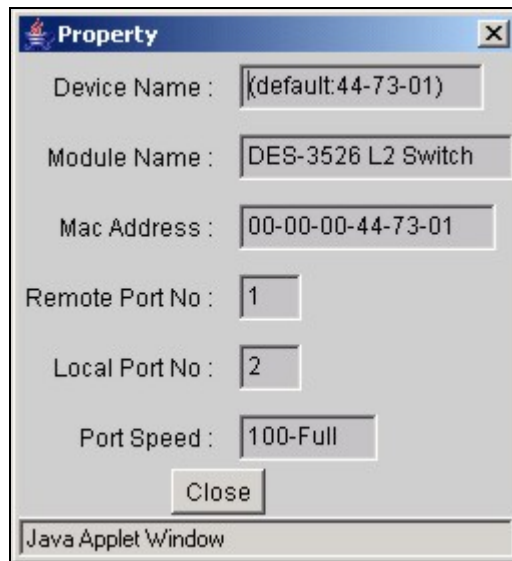

Figure 10- 16. Property window

This window holds the following information:

Parameter	Description
Device Name	This field will display the Device Name of the switches in the SIM group configured by the user. If no Device Name is configured by the name, it will be given the name default and tagged with the last six digits of the MAC Address to identify it.
Module Name	Displays the full module name of the switch that was right-clicked.
MAC Address	Displays the MAC Address of the corresponding Switch.
Remote Port No.	Displays the number of the physical port on the MS or CaS that the CS is connected to. The CS will have no entry in this field.
Local Port No.	Displays the number of the physical port on the CS that the MS or CaS is connected to. The CS will have no entry in this field.
Port Speed	Displays the connection speed between the CS and the MS or CaS. The CS will have no entry in this field.

Click **Close** to close the **Property** window.

Menu Bar

The **Single IP Management** window contains a menu bar for device configurations, as seen below.



Figure 10- 17. Menu Bar of the Topology View

The five menus on the menu bar are as follows.

File

- **Print Setup** - will view the image to be printed.
- **Print Topology** - will print the topology map.
- **Preference** - will set display properties, such as polling interval, and the views to open at SIM startup.

Group

- **Add to group** - add a candidate to a group. Clicking this option will reveal the following dialog box for the user to enter a password for authentication from the Candidate Switch before being added to the SIM group. Click **OK** to enter the password or **Cancel** to exit the window.



Figure 10- 18. Input password dialog box

- **Remove from Group** - remove an MS from the group.

Device

- **Configure** - will open the web manager for the specific device.

View

- **Refresh** - update the views with the latest status.
- **Topology** - display the Topology view.

Help

- **About** - Will display the SIM information, including the current SIM version.



NOTE: Upon this firmware release, some functions of the SIM can only be configured through the Command Line Interface. See the *DES-3500 Series Command Line Interface Reference Manual* for more information on SIM and its configurations.

Firmware Upgrade

This window is used to upgrade firmware from the Commander Switch to the Member Switch. Member Switches will be listed in the table and will be specified by Port (port on the CS where the MS resides), MAC Address, Model Name and Version. To specify a certain Switch for firmware download, click its corresponding check box under the Port heading. To update the firmware, enter the Server IP Address where the firmware resides and enter the Path/Filename of the firmware. Click **Download** to initiate the file transfer.

Firmware Upgrade			
Port	Mac Address	Model Name	Version
Server IP Address	<input type="text" value="0"/>	<input type="text" value="0"/>	<input type="text" value="0"/>
Path \ Filename	<input type="text"/>		
			<input type="button" value="Download"/>

Figure 10- 19. Firmware Upgrade window

Configuration File Backup/Restore

This window is used to upgrade configuration files from the Commander Switch to the Member Switch. Member Switches will be listed in the table and will be specified by Port (port on the CS where the MS resides), MAC Address, Model Name and Version. To specify a certain Switch for upgrading configuration files, click its corresponding radio button under the Port heading. To update the configuration file, enter the Server IP Address where the firmware resides and enter the Path/Filename of the firmware. Click **Download** to initiate the file transfer.

Configuration File Backup/Restore			
Port	Mac Address	Model Name	Version
Server IP Address	<input type="text" value="0"/>	<input type="text" value="0"/>	<input type="text" value="0"/>
Path \ Filename	<input type="text"/>		
			<input type="button" value="Upload"/> <input type="button" value="Download"/>

Figure 10- 20. Configuration File Backup/Restore window

Upload Log File

The following window is used to upload log files from SIM member switches to a specified PC. To view this window, click **Single IP Management > Upload Log File**. To upload a log file, enter the IP address of the SIM member switch and then enter the path on your PC to which to save this file. Click **Upload** to initiate the file transfer.

Upload Log File			
Port	Mac Address	Model Name	Version
Server IP Address	<input type="text" value="0"/>	<input type="text" value="0"/>	<input type="text" value="0"/>
Path \ Filename	<input type="text"/>		
			<input type="button" value="Upload"/>

Figure 10- 21. Upload Log File window

Appendix A

Technical Specifications

General	
Standards	IEEE 802.3 Nway auto-negotiation IEEE 802.3 10BASE-T Ethernet IEEE 802.3u 100BASE-TX Fast Ethernet IEEE 802.3ab 1000BASE-T Gigabit Ethernet IEEE 802.3z 1000BASE-T (SFP “Mini GBIC”) IEEE 802.1D Spanning Tree IEEE 802.1w Rapid Spanning Tree IEEE 802.1s Multiple Spanning Tree IEEE 802.1Q VLAN IEEE 802.1p Priority Queues IEEE 802.3ad Link Aggregation Control IEEE 802.3x Full-duplex Flow Control
Protocols	CSMA/CD
Data Transfer Rates:	Half-duplex Full-duplex
Ethernet	10 Mbps 20Mbps
Fast Ethernet	100Mbps 200Mbps
Gigabit Ethernet	n/a 2000Mbps
Fiber Optic	SFP (Mini GBIC) Support IEEE 802.3z 1000BASE-LX (DEM-310GT transceiver) IEEE 802.3z 1000BASE-SX (DEM-311GT transceiver) IEEE 802.3z 1000BASE-LH (DEM-314GT transceiver) IEEE 802.3z 1000BASE-ZX (DEM-315GT transceiver)
Topology	Star
Network Cables	Cat.5 Enhanced for 1000BASE-T UTP Cat.5, Cat. 5 Enhanced for 100BASE-TX UTP Cat.3, 4, 5 for 10BASE-T EIA/TIA-568 100-ohm screened twisted-pair (STP)(100m)
Number of Ports	24 10/100/1000 Mbps ports (DES-3526/DES-DES-3526DC) 48 10/100/1000 Mbps ports (DES-3550) 2 1000BASE-T Mini-GBIC Combo Ports

Physical and Environmental	
Internal power supply	AC Input: 100 – 120; 200 – 240 VAC, 50/60 Hz DC 60W DC Power Input: 48V Output: 12V
Power Consumption	For DES-3526/ DES-3526DC, Max. 23 watts For DES-3550, Max. 40 watts
DC fans	For DES-3526/ DES-3526DC, one 40 mm fan For DES-3550, two 40mm fan
Operating Temperature	0 - 40°C
Storage Temperature	-40 - 70°C
Humidity	5 - 95% non-condensing
Dimensions	For DES-3526/ DES-3526DC, 441(W) x 207(D) x 44(H) mm, 19-inch, 1U Rack-mount size For DES-3550, 441(W) x 309(D) x 44(H) mm
Weight	For DES-3526, 2.56 kg For DES-3526DC, 2.5 kg For DES-3550, 5Kg
EMI	CE class A, FCC Class A, C-Tick, VCCI class A
Safety	CSA International

Performance	
Transmission Method	Store-and-forward
Packet Buffer	16 MB per device
Packet Filtering/Forwarding Rate	Full-wire speed for all connections. 1,488,095 pps per port (for 1000Mbps)
MAC Address Learning	Automatic update. Supports 8K MAC address.
Priority Queues	4 Priority Queues per port.
Forwarding Table Age Time	Max age: 10-1000000 seconds. Default = 300.

Appendix B

Cables and Connectors

When connecting the Switch to another switch, a bridge or hub, a normal cable is necessary. Please review these products for matching cable pin assignment.

The following diagrams and tables show the standard RJ-45 receptacle/connector and their pin assignments.

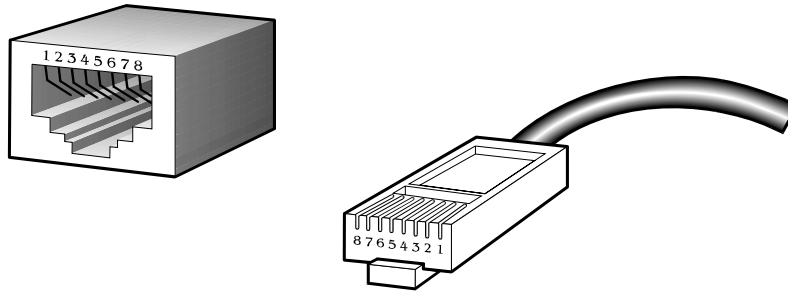

Figure B- 1. The standard RJ-45 port and connector

RJ-45 Pin Assignments		
Contact	MDI-X Port	MDI-II Port
1	RD+ (receive)	TD+ (transmit)
2	RD- (receive)	TD- (transmit)
3	TD+ (transmit)	RD+ (receive)
4	Not used	Not used
5	Not used	Not used
6	TD- (transmit)	RD- (receive)
7	Not used	Not used
8	Not used	Not used

Table B- 1. The standard RJ-45 pin assignments

Appendix C

System Log Entries

The following table lists all possible entries and their corresponding meanings that will appear in the System Log of this Switch.

Category	Event Description	Log Content	Severity	Remark
<i>system</i>	System started up by reboot	System warm start	Critical	
<i>system</i>	System started up by power recycle	System cold start	Critical	
	Configuration saved to flash	Configuration and log saved to flash by console (Username: <username>, IP: <ipaddr>, MAC: <macaddr>)	Informational	"by console" and "IP: <ipaddr>, MAC: <macaddr>" are XOR shown in log strings, which means if the user logs in through the console, no IP or MAC address information will be included in the log.
	Internal Power failed	Internal Power failed	Critical	
	Internal Power is recovered	Internal Power is recovered	Critical	
	Redundant Power failed	Redundant Power failed	Critical	
	Redundant Power is working	Redundant Power is working	Critical	
<i>up/down-load</i>	Firmware upgraded successfully	Firmware upgraded by console successfully (Username: <username>, IP: <ipaddr>, MAC: <macaddr>)	Informational	by console and "IP: <ipaddr>, MAC: <macaddr>" are XOR shown in log string, which means if the user logs in through the console, no IP or MAC address information will be included in the log.
	Firmware upgrade was unsuccessful	Firmware upgrade by console was unsuccessful! (Username: <username>, IP: <ipaddr>, MAC: <macaddr>)	Warning	by console and "IP: <ipaddr>, MAC: <macaddr>" are XOR shown in log string, which means if the user logs in through the console, no IP or MAC address information will be included in the log.
	Configuration successfully downloaded	Configuration successfully downloaded by console (Username: <username>, IP: <ipaddr>, MAC: <macaddr>)	Informational	by console and "IP: <ipaddr>, MAC: <macaddr>" are XOR shown in log string, which means if the user logs in through the console, no IP or MAC address information will be included in the log.
	Configuration download was unsuccessful	Configuration download by console was unsuccessful! (Username: <username>, IP: <ipaddr>, MAC: <macaddr>)	Warning	by console and "IP: <ipaddr>, MAC: <macaddr>" are XOR shown in log string, which means if the user logs in

Category	Event Description	Log Content	Severity	Remark
				through the console, no IP or MAC address information will be included in the log.
	Configuration successfully uploaded	Configuration successfully uploaded by console (Username: <username>, IP: <ipaddr>, MAC: <macaddr>)	Informational	by console and "IP: <ipaddr>, MAC: <macaddr>" are XOR shown in log string, which means if the user logs in through the console, no IP or MAC address information will be included in the log.
	Configuration upload was unsuccessful	Configuration upload by console was unsuccessful! (Username: <username>, IP: <ipaddr>, MAC: <macaddr>)	Warning	by console and "IP: <ipaddr>, MAC: <macaddr>" are XOR shown in log string, which means if the user logs in through the console, no IP or MAC address information will be included in the log.
	Log message successfully uploaded	Log message successfully uploaded by console (Username: <username>, IP: <ipaddr>, MAC: <macaddr>)	Informational	by console and "IP: <ipaddr>, MAC: <macaddr>" are XOR shown in log string, which means if the user logs in through the console, no IP or MAC address information will be included in the log.
	Log message upload was unsuccessful	Log message upload by console was unsuccessful! (Username: <username>, IP: <ipaddr>, MAC: <macaddr>)	Warning	by console and "IP: <ipaddr>, MAC: <macaddr>" are XOR shown in log string, which means if the user logs in through the console, no IP or MAC address information will be included in the log.
<i>Interface</i>	Port link up	Port <portNum> link up, <link state>	Informational	Port link state (ex: , 100Mbps FULL duplex)
	Port link down	Port <portNum> link down	Informational	
<i>Console</i>	Successful login through Console	Successful login through Console (Username: <username>)	Informational	If the user logs in through the console, no IP or MAC address information will be included in the log.
	Login failed through Console	Login failed through Console (Username: <username>)	Warning	If the user logs in through the console, no IP or MAC address information will be included in the log.
	Logout through Console	Logout through Console (Username: <username>)	Informational	If the user logs in through the console, no IP or MAC address information will be included in the log.
	Console session timed out	Console session timed out (Username: <username>)	Informational	If the user logs in through the console, no IP or MAC address information will be included in the log.
<i>Web</i>	Successful login through Web	Successful login through Web (Username: <username>, IP: <ipaddr>, MAC: <macaddr>)	Informational	

Category	Event Description	Log Content	Severity	Remark
	Login failed through Web	Login failed through Web (Username: <username>, IP: <ipaddr>, MAC: <macaddr>)	Warning	
	Logout through Web	Logout through Web (Username: <username>, IP: <ipaddr>, MAC: <macaddr>)	Informational	
	Successful login through SSL	Successful login through Web (SSL) (Username: <string>, IP: <ip>, MAC: <mac>)	Informational	
	Logout through SSL	Logout through Web (SSL) (Username: <string>, IP: <ip>, MAC: <mac>)	Informational	
	Login failed through SSL	Login failed through Web (SSL) (Username: <string>, IP: <ip>, MAC: <mac>)	Warning	
<i>Telnet</i>	Successful login through Telnet	Successful login through Telnet (Username: <username>, IP: <ipaddr>, MAC: <macaddr>)	Informational	
	Login failed through Telnet	Login failed through Telnet (Username: <username>, IP: <ipaddr>, MAC: <macaddr>)	Warning	
	Logout through Telnet	Logout through Telnet (Username: <username>, IP: <ipaddr>, MAC: <macaddr>)	Informational	
	Telnet session timed out	Telnet session timed out (Username: <username>, IP: <ipaddr>, MAC: <macaddr>)	Informational	
<i>SNMP</i>	SNMP request received with invalid community string	SNMP request received from <ipAddress> with invalid community string!	Informational	
<i>STP</i>	Topology changed	Topology changed	Informational	
	New Root selected	New Root selected	Informational	
	BPDU Loop Back on port	BPDU Loop Back on Port <portNum>	Warning	
	Spanning Tree Protocol is enabled	Spanning Tree Protocol is enabled	Informational	
	Spanning Tree Protocol is disabled	Spanning Tree Protocol is disabled	Informational	
<i>SSH</i>	Successful login through SSH	Successful login through SSH (Username: <username>, IP: <ipaddr>, MAC: <macaddr>)	Informational	
	Login failed through SSH	Login failed through SSH (Username: <username>, IP: <ipaddr>, MAC: <macaddr>)	Warning	

Category	Event Description	Log Content	Severity	Remark
	Logout through SSH	Logout through SSH (Username: <username>, IP: <ipaddr>, MAC: <macaddr>)	Informational	
	SSH session timed out	SSH session timed out (Username: <username>, IP: <ipaddr>, MAC: <macaddr>)	Informational	
	Enable SSH server	SSH server is enabled	Informational	
	Disable SSH server	SSH server is disabled	Informational	
AAA	Authentication Policy is enabled	Authentication Policy is enabled (Module: AAA)	Informational	
	Authentication Policy is disabled	Authentication Policy is disabled (Module: AAA)	Informational	
	Successful login through Console authenticated by AAA local method	Successful login through Console authenticated by AAA local method (Username: <username>)	Informational	
	Login failed through Console authenticated by AAA local method	Login failed through Console authenticated by AAA local method (Username: <username>)	Warning	
	Successful login through Web authenticated by AAA local method	Successful login through Web from <userIP> authenticated by AAA local method (Username: <username>, MAC: <macaddr>)	Informational	
	Login failed through Web authenticated by AAA local method	Login failed through Web from <userIP> authenticated by AAA local method (Username: <username>, MAC: <macaddr>)	Warning	
	Successful login through Web (SSL) authenticated by AAA local method	Successful login through Web (SSL) from <userIP> authenticated by AAA local method (Username: <username>, MAC: <macaddr>)	Informational	
	Login failed through Web (SSL) authenticated by AAA local method	Login failed through Web (SSL) from <userIP> authenticated by AAA local method (Username: <username>, MAC: <macaddr>)	Warning	
	Successful login through Telnet authenticated by AAA local method	Successful login through Telnet from <userIP> authenticated by AAA local method (Username: <username>, MAC: <macaddr>)	Informational	

Category	Event Description	Log Content	Severity	Remark
	Login failed through Telnet authenticated by AAA local method	Login failed through Telnet from <userIP> authenticated by AAA local method (Username: <username>, MAC: <macaddr>)	Warning	
	Successful login through SSH authenticated by AAA local method	Successful login through SSH from <userIP> authenticated by AAA local method (Username: <username>, MAC: <macaddr>)	Informational	
	Login failed through SSH authenticated by AAA local method	Login failed through SSH from <userIP> authenticated by AAA local method (Username: <username>, MAC: <macaddr>)	Warning	
	Successful login through Console authenticated by AAA none method	Successful login through Console authenticated by AAA none method (Username: <username>)	Informational	
	Successful login through Web authenticated by AAA none method	Successful login through Web from <userIP> authenticated by AAA none method (Username: <username>, MAC: <macaddr>)	Informational	
	Successful login through Web (SSL) authenticated by AAA none method	Successful login through Web (SSL) from <userIP> authenticated by AAA none method (Username: <username>, MAC: <macaddr>)	Informational	
	Successful login through Telnet authenticated by AAA none method	Successful login through Telnet from <userIP> authenticated by AAA none method (Username: <username>, MAC: <macaddr>)	Informational	
	Successful login through SSH authenticated by AAA none method	Successful login through SSH from <userIP> authenticated by AAA none method (Username: <username>, MAC: <macaddr>)	Informational	
	Successful login through Console authenticated by AAA server	Successful login through Console authenticated by AAA server <serverIP> (Username: <username>)	Informational	If the user logs in through the console, no IP or MAC address information will be included in the log.
	Login failed through Console authenticated by AAA server	Login failed through Console authenticated by AAA server <serverIP> (Username: <username>)	Warning	There are no IP and MAC if login by console.
	Login failed through Console due to AAA server timeout or	Login failed through Console due to AAA server timeout or improper configuration (Username: <username>)	Warning	

Category	Event Description	Log Content	Severity	Remark
	improper configuration	(Username: <username>)		
	Successful login through Web authenticated by AAA server	Successful login through Web from <userIP> authenticated by AAA server <serverIP> (Username: <username>, MAC: <macaddr>)	Informational	
	Login failed through Web authenticated by AAA server	Login failed through Web from <userIP> authenticated by AAA server <serverIP> (Username: <username>, MAC: <macaddr>)	Warning	
	Login failed through Web due to AAA server timeout or improper configuration	Login failed through Web from <userIP> due to AAA server timeout or improper configuration (Username: <username>, MAC: <macaddr>)	Warning	
	Successful login through Web (SSL) authenticated by AAA server	Successful login through Web (SSL) from <userIP> authenticated by AAA server <serverIP> (Username: <username>, MAC: <macaddr>)	Informational	
	Login failed through Web (SSL) authenticated by AAA server	Login failed through Web (SSL) from <userIP> authenticated by AAA server <serverIP> (Username: <username>, MAC: <macaddr>)	Warning	
	Login failed through Web (SSL) due to AAA server timeout or improper configuration	Login failed through Web(SSL) from <userIP> due to AAA server timeout or improper configuration (Username: <username>, MAC: <macaddr>)	Warning	
	Successful login through Telnet authenticated by AAA server	Successful login through Telnet from <userIP> authenticated by AAA server <serverIP> (Username: <username>, MAC: <macaddr>)	Informational	
	Login failed through Telnet authenticated by AAA server	Login failed through Telnet from <userIP> authenticated by AAA server <serverIP> (Username: <username>, MAC: <macaddr>)	Warning	
	Login failed through Telnet due to AAA server timeout or improper	Login failed through Telnet from <userIP> due to AAA server timeout or improper configuration (Username: <username>, MAC: <macaddr>)	Warning	

Category	Event Description	Log Content	Severity	Remark
	configuration	<macaddr>)		
	Successful login through SSH authenticated by AAA server	Successful login through SSH from <userIP> authenticated by AAA server <serverIP> (Username: <username>, MAC: <macaddr>)	Informational	
	Login failed through SSH authenticated by AAA server	Login failed through SSH from <userIP> authenticated by AAA server <serverIP> (Username: <username>, MAC: <macaddr>)	Warning	
	Login failed through SSH due to AAA server timeout or improper configuration	Login failed through SSH from <userIP> due to AAA server timeout or improper configuration (Username: <username>, MAC: <macaddr>)	Warning	
	Successful Enable Admin through Console authenticated by AAA local_enable method	Successful Enable Admin through Console authenticated by AAA local_enable method (Username: <username>)	Informational	
	Enable Admin failed through Console authenticated by AAA local_enable method	Enable Admin failed through Console authenticated by AAA local_enable method (Username: <username>)	Warning	
	Successful Enable Admin through Web authenticated by AAA local_enable method	Successful Enable Admin through Web from <userIP> authenticated by AAA local_enable method (Username: <username>, MAC: <macaddr>)	Informational	
	Enable Admin failed through Web authenticated by AAA local_enable method	Enable Admin failed through Web from <userIP> authenticated by AAA local_enable method (Username: <username>, MAC: <macaddr>)	Warning	
	Successful Enable Admin through Web (SSL) authenticated by AAA local_enable method	Successful Enable Admin through Web (SSL) from <userIP> authenticated by AAA local_enable method (Username: <username>, MAC: <macaddr>)	Informational	

Category	Event Description	Log Content	Severity	Remark
	Enable Admin failed through Web (SSL) authenticated by AAA local_enable method	Enable Admin failed through Web (SSL) from <userIP> authenticated by AAA local_enable method (Username: <username>, MAC: <macaddr>)	Warning	
	Successful Enable Admin through Telnet authenticated by AAA local_enable method	Successful Enable Admin through Telnet from <userIP> authenticated by AAA local_enable method (Username: <username>, MAC: <macaddr>)	Informational	
	Enable Admin failed through Telnet authenticated by AAA local_enable method	Enable Admin failed through Telnet from <userIP> authenticated by AAA local_enable method (Username: <username>, MAC: <macaddr>)	Warning	
	Successful Enable Admin through SSH authenticated by AAA local_enable method	Successful Enable Admin through SSH from <userIP> authenticated by AAA local_enable method (Username: <username>, MAC: <macaddr>)	Informational	
	Enable Admin failed through SSH authenticated by AAA local_enable method	Enable Admin failed through <Telnet or Web or SSH> from <userIP> authenticated by AAA local_enable method (Username: <username>, MAC: <macaddr>)	Warning	
	Successful Enable Admin through Console authenticated by AAA none method	Successful Enable Admin through Console authenticated by AAA none method (Username: <username>)	Informational	
	Successful Enable Admin through Web authenticated by AAA none method	Successful Enable Admin through Web from <userIP> authenticated by AAA none method (Username: <username>, MAC: <macaddr>)	Informational	
	Successful Enable Admin through Web (SSL) authenticated by AAA none method	Successful Enable Admin through Web (SSL) from <userIP> authenticated by AAA none method (Username: <username>, MAC: <macaddr>)	Informational	

Category	Event Description	Log Content	Severity	Remark
	Successful Enable Admin through Telnet authenticated by AAA none method	Successful Enable Admin through Telnet from <userIP> authenticated by AAA none method (Username: <username>, MAC: <macaddr>)	Informational	
	Successful Enable Admin through SSH authenticated by AAA none method	Successful Enable Admin through SSH from <userIP> authenticated by AAA none method (Username: <username>, MAC: <macaddr>)	Informational	
	Successful Enable Admin through Console authenticated by AAA server	Successful Enable Admin through Console authenticated by AAA server <serverIP> (Username: <username>)	Informational	
	Enable Admin failed through Console authenticated by AAA server	Enable Admin failed through Console authenticated by AAA server <serverIP> (Username: <username>)	Warning	
	Enable Admin failed through Console due to AAA server timeout or improper configuration	Enable Admin failed through Console due to AAA server timeout or improper configuration (Username: <username>)	Warning	
	Successful Enable Admin through Web authenticated by AAA server	Successful Enable Admin through Web from <userIP> authenticated by AAA server <serverIP> (Username: <username>, MAC: <macaddr>)	Informational	
	Enable Admin failed through Web authenticated by AAA server	Enable Admin failed through Web from <userIP> authenticated by AAA server <serverIP> (Username: <username>, MAC: <macaddr>)	Warning	
	Enable Admin failed through Web due to AAA server timeout or improper configuration	Enable Admin failed through Web from <userIP> due to AAA server timeout or improper configuration (Username: <username>, MAC: <macaddr>)	Warning	
	Successful Enable Admin through Web (SSL) authenticated by AAA server	Successful Enable Admin through Web (SSL) from <userIP> authenticated by AAA server <serverIP> (Username: <username>, MAC: <macaddr>)	Informational	

Category	Event Description	Log Content	Severity	Remark
	Enable Admin failed through Web (SSL) authenticated by AAA server	Enable Admin failed through Web (SSL) from <userIP> authenticated by AAA server <serverIP> (Username: <username>, MAC: <macaddr>)	Warning	
	Enable Admin failed through Web (SSL) due to AAA server timeout or improper configuration	Enable Admin failed through Web (SSL) from <userIP> due to AAA server timeout or improper configuration (Username: <username>, MAC: <macaddr>)	Warning	
	Successful Enable Admin through Telnet authenticated by AAA server	Successful Enable Admin through Telnet from <userIP> authenticated by AAA server <serverIP> (Username: <username>, MAC: <macaddr>)	Informational	
	Enable Admin failed through Telnet authenticated by AAA server	Enable Admin failed through Telnet from <userIP> authenticated by AAA server <serverIP> (Username: <username>, MAC: <macaddr>)	Warning	
	Enable Admin failed through Telnet due to AAA server timeout or improper configuration	Enable Admin failed through Telnet from <userIP> due to AAA server timeout or improper configuration (Username: <username>, MAC: <macaddr>)	Warning	
	Successful Enable Admin through SSH authenticated by AAA server	Successful Enable Admin through SSH from <userIP> authenticated by AAA server <serverIP> (Username: <username>, MAC: <macaddr>)	Informational	
	Enable Admin failed through SSH authenticated by AAA server	Enable Admin failed through SSH from <userIP> authenticated by AAA server <serverIP> (Username: <username>, MAC: <macaddr>)	Warning	
	Enable Admin failed through SSH due to AAA server timeout or improper configuration	Enable Admin failed through SSH from <userIP> due to AAA server timeout or improper configuration (Username: <username>, MAC: <macaddr>)	Warning	
	AAA server timed out	AAA server <serverIP> (Protocol: <protocol>) connection failed	Warning	<protocol> is one of TACACS, XTACACS, TACACS+ or RADIUS

Category	Event Description	Log Content	Severity	Remark
<i>Port Security</i>	port security has reached its maximum learning size and will not learn any new addresses	Port security violation (Port: <portNum>, MAC: <macaddr>)	Warning	
<i>IP-MAC-PORT Binding</i>	Unauthenticated IP address discarded by IP mac port binding	Unauthenticated IP-MAC address and discarded by ip mac port binding (IP: <ipaddr>, MAC: <macaddr>, Port <portNum>)	Warning	
<i>Safeguard Engine</i>	Safeguard Engine is in normal mode	SafeGuard Engine enters NORMAL mode	Informational	
	Safeguard Engine is in filtering packet mode	Safeguard Engine enters EXHAUSTED mode	Warning	
<i>Packet Storm</i>	Broadcast storm occurrence	Broadcast storm is occurring (port: <id>)	Warning	
	Broadcast storm has cleared	Broadcast storm has cleared (port: <id>)	Informational	
	Multicast storm occurrence	Multicast storm is occurring (port: <id>)	Warning	
	Multicast storm has cleared	Multicast storm has cleared (port: <id>)	Informational	
<i>Security</i>	Packet received containing a MAC address identical to the MAC address of the device's interface	Possible spoofing attack from <mac> port <u16>	Critical	

Appendix D

Cable Lengths

Use the following table to as a guide for the maximum cable lengths.

Standard	Media Type	Maximum Distance
Mini-GBIC	1000BASE-LX, Single-mode fiber module	10km
	1000BASE-SX, Multi-mode fiber module	550m
	1000BASE-LHX, Single-mode fiber module	40km
	1000BASE-ZX, Single-mode fiber module	80km
1000BASE-T	Category 5e UTP Cable	100m
	Category 5 UTP Cable (1000 Mbps)	
100BASE-TX	Category 5 UTP Cable (100 Mbps)	100m
10BASE-T	Category 3 UTP Cable (10 Mbps)	100m

Glossary

1000BASE-LX: A short laser wavelength on multimode fiber optic cable for a maximum length of 550 meters

1000BASE-SX: A long wavelength for a "long haul" fiber optic cable for a maximum length of 10 kilometers

100BASE-FX: 100Mbps Ethernet implementation over fiber.

100BASE-TX: 100Mbps Ethernet implementation over Category 5 and Type 1 Twisted Pair cabling.

10BASE-T: The IEEE 802.3 specification for Ethernet over Unshielded Twisted Pair (UTP) cabling.

aging: The automatic removal of dynamic entries from the Switch Database which have timed-out and are no longer valid.

ATM: Asynchronous Transfer Mode. A connection oriented transmission protocol based on fixed length cells (packets). ATM is designed to carry a complete range of user traffic, including voice, data and video signals.

auto-negotiation: A feature on a port, which allows it to advertise its capabilities for speed, duplex and flow control. When connected to an end station that also supports auto-negotiation, the link can self-detect its optimum operating setup.

backbone port: A port which does not learn device addresses, and which receives all frames with an unknown address. Backbone ports are normally used to connect the Switch to the backbone of your network. Note that backbone ports were formerly known as designated downlink ports.

backbone: The part of a network used as the primary path for transporting traffic between network segments.

bandwidth: Information capacity, measured in bits per second that a channel can transmit. The bandwidth of Ethernet is 10Mbps, the bandwidth of Fast Ethernet is 100Mbps.

baud rate: The switching speed of a line. Also known as line speed between network segments.

BOOTP: The BOOTP protocol allows you to automatically map an IP address to a given MAC address each time a device is started. In addition, the protocol can assign the subnet mask and default gateway to a device.

bridge: A device that interconnects local or remote networks no matter what higher-level protocols are involved. Bridges form a single logical network, centralizing network administration.

broadcast: A message sent to all destination devices on the network.

broadcast storm: Multiple simultaneous broadcasts that typically absorb available network bandwidth and can cause network failure.

console port: The port on the Switch accepting a terminal or modem connector. It changes the parallel arrangement of data within computers to the serial form used on data transmission links. This port is most often used for dedicated local management.

CSMA/CD: Channel access method used by Ethernet and IEEE 802.3 standards in which devices transmit only after finding the data channel clear for some period of time. When two devices transmit simultaneously, a collision occurs and the colliding devices delay their retransmissions for a random amount of time.

data center switching: The point of aggregation within a corporate network where a switch provides high-performance access to server farms, a high-speed backbone connection and a control point for network management and security.

Ethernet: A LAN specification developed jointly by Xerox, Intel and Digital Equipment Corporation. Ethernet networks operate at 10Mbps using CSMA/CD to run over cabling.

Fast Ethernet: 100Mbps technology based on the Ethernet/CD network access method.

Flow Control: (IEEE 802.3z) A means of holding packets back at the transmit port of the connected end station. Prevents packet loss at a congested switch port.

forwarding: The process of sending a packet toward its destination by an internetworking device.

full duplex: A system that allows packets to be transmitted and received at the same time and, in effect, doubles the potential throughput of a link.

half duplex: A system that allows packets to be transmitted and received, but not at the same time. Contrast with full duplex.

IP address: Internet Protocol address. A unique identifier for a device attached to a network using TCP/IP. The address is written as four octets separated with full-stops (periods), and is made up of a network section, an optional subnet section and a host section.

IPX: Internetwork Packet Exchange. A protocol allowing communication in a NetWare network.

LAN - Local Area Network: A network of connected computing resources (such as PCs, printers, servers) covering a relatively small geographic area (usually not larger than a floor or building). Characterized by high data rates and low error rates.

latency: The delay between the time a device receives a packet and the time the packet is forwarded out of the destination port.

line speed: See baud rate.

main port: The port in a resilient link that carries data traffic in normal operating conditions.

MDI - Medium Dependent Interface: An Ethernet port connection where the transmitter of one device is connected to the receiver of another device.

MDI-X - Medium Dependent Interface Cross-over: An Ethernet port connection where the internal transmit and receive lines are crossed.

MIB - Management Information Base: Stores a device's management characteristics and parameters. MIBs are used by the Simple Network Management Protocol (SNMP) to contain attributes of their managed systems. The Switch contains its own internal MIB.

multicast: Single packets copied to a specific subset of network addresses. These addresses are specified in the destination-address field of the packet.

protocol: A set of rules for communication between devices on a network. The rules dictate format, timing, sequencing and error control.

resilient link: A pair of ports that can be configured so that one will take over data transmission should the other fail. See also main port and standby port.

RJ-45: Standard 8-wire connectors for IEEE 802.3 10BASE-T networks.

RMON: Remote Monitoring. A subset of SNMP MIB II that allows monitoring and management capabilities by addressing up to ten different groups of information.

RPS - Redundant Power System: A device that provides a backup source of power when connected to the Switch.

server farm: A cluster of servers in a centralized location serving a large user population.

SLIP - Serial Line Internet Protocol: A protocol, which allows IP to run over a serial line connection.

SNMP - Simple Network Management Protocol: A protocol originally designed to be used in managing TCP/IP internets. SNMP is presently implemented on a wide range of computers and networking equipment and may be used to manage many aspects of network and end station operation.

Spanning Tree Protocol (STP): A bridge-based system for providing fault tolerance on networks. STP works by allowing you to implement parallel paths for network traffic, and ensure that redundant paths are disabled when the main paths are operational and enabled if the main paths fail.

stack: A group of network devices that are integrated to form a single logical device.

standby port: The port in a resilient link that will take over data transmission if the main port in the link fails.

switch: A device, which filters, forwards and floods packets based on the packet's destination address. The switch learns the addresses associated with each switch port and builds tables based on this information to be used for the switching decision.

TCP/IP: A layered set of communications protocols providing Telnet terminal emulation, FTP file transfer, and other services for communication among a wide range of computer equipment.

telnet: A TCP/IP application protocol that provides virtual terminal service, letting a user log in to another computer system and access a host as if the user were connected directly to the host.

TFTP - Trivial File Transfer Protocol: Allows you to transfer files (such as software upgrades) from a remote device using your switch's local management capabilities.

UDP - User Datagram Protocol: An Internet standard protocol that allows an application program on one device to send a datagram to an application program on another device.

VLAN - Virtual LAN: A group of location- and topology-independent devices that communicate as if they are on a common physical LAN.

VLT - Virtual LAN Trunk: A Switch-to-Switch link which carries traffic for all the VLANs on each Switch.

VT100: A type of terminal that uses ASCII characters. VT100 screens have a text-based appearance.

FCC Warning

This equipment has been tested and found to comply with the limits for a Class A digital device, pursuant to Part 15 of the FCC Rules. These limits are designed to provide reasonable protection against harmful interference when the equipment is operated in a commercial environment. This equipment generates, uses, and can radiate radio frequency energy and, if not installed and used in accordance with this manual, may cause harmful interference to radio communications. Operation of this equipment in a residential area is likely to cause harmful interference in which case the user will be required to correct the interference at his own expense.

CE Mark Warning

This is a Class A product. In a domestic environment, this product may cause radio interference in which case the user may be required to take adequate measures.

Warnung!

Dies ist ein Produkt der Klasse A. Im Wohnbereich kann dieses Produkt Funkstörungen verursachen. In diesem Fall kann vom Benutzer verlangt werden, angemessene Massnahmen zu ergreifen.

Precaución!

Este es un producto de Clase A. En un entorno doméstico, puede causar interferencias de radio, en cuyo caso, puede requerirse al usuario para que adopte las medidas adecuadas.

Attention!

Ceci est un produit de classe A. Dans un environnement domestique, ce produit pourrait causer des interférences radio, auquel cas l'utilisateur devrait prendre les mesures adéquates.

Attenzione!

Il presente prodotto appartiene alla classe A. Se utilizzato in ambiente domestico il prodotto può causare interferenze radio, nel cui caso è possibile che l'utente debba assumere provvedimenti adeguati.

BSMI Warning**警告使用者**

這是甲類的資訊產品,在居住的環境中使用時,可能會造成射頻干擾,在這種情況下使用者會被要求採取某些適當的對策

Warranties/Registration

LIMITED WARRANTY

D-Link provides this limited warranty for its product only to the person or entity who originally purchased the product from D-Link or its authorized reseller or distributor. D-Link would fulfill the warranty obligation according to the local warranty policy in which you purchased our products.

Limited Hardware Warranty: D-Link warrants that the hardware portion of the D-Link products described below (“Hardware”) will be free from material defects in workmanship and materials from the date of original retail purchase of the Hardware, for the period set forth below applicable to the product type (“Warranty Period”) if the Hardware is used and serviced in accordance with applicable documentation; provided that a completed Registration Card is returned to an Authorized D-Link Service Office within ninety (90) days after the date of original retail purchase of the Hardware. If a completed Registration Card is not received by an authorized D-Link Service Office within such ninety (90) period, then the Warranty Period shall be ninety (90) days from the date of purchase.

<i>Product Type</i>	<i>Warranty Period</i>
Product (including Power Supplies and Fans)	One (1) Year
Spare parts and pare kits	Ninety (90) days

D-Link’s sole obligation shall be to repair or replace the defective Hardware at no charge to the original owner. Such repair or replacement will be rendered by D-Link at an Authorized D-Link Service Office. The replacement Hardware need not be new or of an identical make, model or part; D-Link may in its discretion may replace the defective Hardware (or any part thereof) with any reconditioned product that D-Link reasonably determines is substantially equivalent (or superior) in all material respects to the defective Hardware. The Warranty Period shall extend for an additional ninety (90) days after any repaired or replaced Hardware is delivered. If a material defect is incapable of correction, or if D-Link determines in its sole discretion that it is not practical to repair or replace the defective Hardware, the price paid by the original purchaser for the defective Hardware will be refunded by D-Link upon return to D-Link of the defective Hardware. All Hardware (or part thereof) that is replaced by D-Link, or for which the purchase price is refunded, shall become the property of D-Link upon replacement or refund.

Limited Software Warranty: D-Link warrants that the software portion of the product (“Software”) will substantially conform to D-Link’s then current functional specifications for the Software, as set forth in the applicable documentation, from the date of original delivery of the Software for a period of ninety (90) days (“Warranty Period”), if the Software is properly installed on approved hardware and operated as contemplated in its documentation. D-Link further warrants that, during the Warranty Period, the magnetic media on which D-Link delivers the Software will be free of physical defects. D-Link’s sole obligation shall be to replace the non-conforming Software (or defective media) with software that substantially conforms to D-Link’s functional specifications for the Software. Except as otherwise agreed by D-Link in writing, the replacement Software is provided only to the original licensee, and is subject to the terms and conditions of the license granted by D-Link for the Software. The Warranty Period shall extend for an additional ninety (90) days after any replacement Software is delivered. If a material non-conformance is incapable of correction, or if D-Link determines in its sole discretion that it is not practical to replace the non-conforming Software, the price paid by the original licensee for the non-conforming Software will be refunded by D-Link; provided that the non-conforming Software (and all copies thereof) is first returned to D-Link. The license granted respecting any Software for which a refund is given automatically terminates.

What You Must Do For Warranty Service:

Registration Card. The Registration Card provided at the back of this manual must be completed and returned to an Authorized D-Link Service Office for each D-Link product within ninety (90) days after the product is purchased and/or licensed. The addresses/telephone/fax list of the nearest Authorized D-Link Service Office is provided in the back of this manual. FAILURE TO PROPERLY COMPLETE AND TIMELY RETURN THE REGISTRATION CARD MAY AFFECT THE WARRANTY FOR THIS PRODUCT.

Submitting A Claim. Any claim under this limited warranty must be submitted in writing before the end of the Warranty Period to an Authorized D-Link Service Office. The claim must include a written description of the Hardware defect or Software

nonconformance in sufficient detail to allow D-Link to confirm the same. The original product owner must obtain a Return Material Authorization (RMA) number from the Authorized D-Link Service Office and, if requested, provide written proof of purchase of the product (such as a copy of the dated purchase invoice for the product) before the warranty service is provided. After an RMA number is issued, the defective product must be packaged securely in the original or other suitable shipping package to ensure that it will not be damaged in transit, and the RMA number must be prominently marked on the outside of the package. The packaged product shall be insured and shipped to Authorized D-Link Service Office with all shipping costs prepaid. D-Link may reject or return any product that is not packaged and shipped in strict compliance with the foregoing requirements, or for which an RMA number is not visible from the outside of the package. The product owner agrees to pay D-Link's reasonable handling and return shipping charges for any product that is not packaged and shipped in accordance with the foregoing requirements, or that is determined by D-Link not to be defective or non-conforming.

What Is Not Covered:

This limited warranty provided by D-Link does not cover:

Products that have been subjected to abuse, accident, alteration, modification, tampering, negligence, misuse, faulty installation, lack of reasonable care, repair or service in any way that is not contemplated in the documentation for the product, or if the model or serial number has been altered, tampered with, defaced or removed;

Initial installation, installation and removal of the product for repair, and shipping costs;

Operational adjustments covered in the operating manual for the product, and normal maintenance;

Damage that occurs in shipment, due to act of God, failures due to power surge, and cosmetic damage;

and Any hardware, software, firmware or other products or services provided by anyone other than D-Link.

Disclaimer of Other Warranties: EXCEPT FOR THE LIMITED WARRANTY SPECIFIED HEREIN, THE PRODUCT IS PROVIDED "AS-IS" WITHOUT ANY WARRANTY OF ANY KIND INCLUDING, WITHOUT LIMITATION, ANY WARRANTY OF MERCHANTABILITY, FITNESS FOR A PARTICULAR PURPOSE AND NON-INFRINGEMENT. IF ANY IMPLIED WARRANTY CANNOT BE DISCLAIMED IN ANY TERRITORY WHERE A PRODUCT IS SOLD, THE DURATION OF SUCH IMPLIED WARRANTY SHALL BE LIMITED TO NINETY (90) DAYS. EXCEPT AS EXPRESSLY COVERED UNDER THE LIMITED WARRANTY PROVIDED HEREIN, THE ENTIRE RISK AS TO THE QUALITY, SELECTION AND PERFORMANCE OF THE PRODUCT IS WITH THE PURCHASER OF THE PRODUCT.

Limitation of Liability: TO THE MAXIMUM EXTENT PERMITTED BY LAW, D-LINK IS NOT LIABLE UNDER ANY CONTRACT, NEGLIGENCE, STRICT LIABILITY OR OTHER LEGAL OR EQUITABLE THEORY FOR ANY LOSS OF USE OF THE PRODUCT, INCONVENIENCE OR DAMAGES OF ANY CHARACTER, WHETHER DIRECT, SPECIAL, INCIDENTAL OR CONSEQUENTIAL (INCLUDING, BUT NOT LIMITED TO, DAMAGES FOR LOSS OF GOODWILL, WORK STOPPAGE, COMPUTER FAILURE OR MALFUNCTION, LOSS OF INFORMATION OR DATA CONTAINED IN, STORED ON, OR INTEGRATED WITH ANY PRODUCT RETURNED TO D-LINK FOR WARRANTY SERVICE) RESULTING FROM THE USE OF THE PRODUCT, RELATING TO WARRANTY SERVICE, OR ARISING OUT OF ANY BREACH OF THIS LIMITED WARRANTY, EVEN IF D-LINK HAS BEEN ADVISED OF THE POSSIBILITY OF SUCH DAMAGES. THE SOLE REMEDY FOR A BREACH OF THE FOREGOING LIMITED WARRANTY IS REPAIR, REPLACEMENT OR REFUND OF THE DEFECTIVE OR NON-CONFORMING PRODUCT.

GOVERNING LAW: This Limited Warranty shall be governed by the laws of the state of California.

Some states do not allow exclusion or limitation of incidental or consequential damages, or limitations on how long an implied warranty lasts, so the foregoing limitations and exclusions may not apply. This limited warranty provides specific legal rights and the product owner may also have other rights which vary from state to state.

Trademarks

Copyright .2007 D-Link Corporation. Contents subject to change without prior notice. D-Link is a registered trademark of D-Link Corporation/D-Link Systems, Inc. All other trademarks belong to their respective proprietors.

Copyright Statement

No part of this publication may be reproduced in any form or by any means or used to make any derivative such as translation, transformation, or adaptation without permission from D-Link Corporation/D-Link Systems Inc., as stipulated by the United States Copyright Act of 1976.

FCC Warning

This equipment has been tested and found to comply with the limits for a Class A digital device, pursuant to Part 15 of the FCC Rules. These limits are designed to provide reasonable protection against harmful interference when the equipment is operated in a commercial environment. This equipment generates, uses, and can radiate radio frequency energy and, if not installed and used in accordance with this manual, may cause harmful interference to radio communications. Operation of this equipment in a residential area is likely to cause harmful interference in which case the user will be required to correct the interference at his own expense.

Subject to the terms and conditions set forth herein, D-Link Systems, Inc. ("D-Link") provides this Limited Warranty:

- Only to the person or entity that originally purchased the product from D-Link or its authorized reseller or distributor, and
- Only for products purchased and delivered within the fifty states of the United States, the District of Columbia, U.S. Possessions or Protectorates, U.S. Military Installations, or addresses with an APO or FPO.

Limited Warranty: D-Link warrants that the hardware portion of the D-Link product described below ("Hardware") will be free from material defects in workmanship and materials under normal use from the date of original retail purchase of the product, for the period set forth below ("Warranty Period"), except as otherwise stated herein.

Limited Lifetime Warranty for the product is defined as follows:

- Hardware: For as long as the original customer/end user owns the product, or five (5) years after product discontinuance, whichever occurs first (excluding power supplies and fans)
- Power supplies and fans: Three (3) Year
- Spare parts and spare kits: Ninety (90) days

The customer's sole and exclusive remedy and the entire liability of D-Link and its suppliers under this Limited Warranty will be, at D-Link's option, to repair or replace the defective Hardware during the Warranty Period at no charge to the original owner or to refund the actual purchase price paid. Any repair or replacement will be rendered by D-Link at an Authorized D-Link Service Office. The replacement hardware need not be new or have an identical make, model or part. D-Link may, at its option, replace the defective Hardware or any part thereof with any reconditioned product that D-Link reasonably determines is substantially equivalent (or superior) in all material respects to the defective Hardware. Repaired or replacement hardware will be warranted for the remainder of the original Warranty Period or ninety (90) days, whichever is longer, and is subject to the same limitations and exclusions. If a material defect is incapable of correction, or if D-Link determines that it is not practical to repair or replace the defective Hardware, the actual price paid by the original purchaser for the defective Hardware will be refunded by D-Link upon return to D-Link of the defective Hardware. All Hardware or part thereof that is replaced by D-Link, or for which the purchase price is refunded, shall become the property of D-Link upon replacement or refund.

Limited Software Warranty: D-Link warrants that the software portion of the product ("Software") will substantially conform to D-Link's then current functional specifications for the Software, as set forth in the applicable documentation, from the date of original retail purchase of the Software for a period of ninety (90) days ("Software Warranty Period"), provided that the Software is properly installed on approved hardware and operated as contemplated in its documentation. D-Link further warrants that, during the Software Warranty Period, the magnetic media on which D-Link delivers the Software will be free of physical defects. The customer's sole and exclusive remedy and the entire liability of D-Link and its suppliers under this Limited Warranty will be, at D-Link's option, to replace the non-conforming Software (or defective media) with software that substantially conforms to D-Link's functional specifications for the Software or to refund the portion of the actual purchase price paid that is attributable to the Software. Except as otherwise agreed by D-Link in writing, the replacement Software is provided only to the original licensee, and is subject to the terms and conditions of the license granted by D-Link for the Software. Replacement Software will be warranted for the remainder of the original Warranty Period and is subject to the same limitations and exclusions. If a material non-conformance is incapable of correction, or if D-Link determines in its sole discretion that it is not practical to replace the non-conforming Software, the price paid by the original licensee for the non-conforming Software will be refunded by D-Link; provided that the non-conforming Software (and all copies thereof) is first returned to D-Link. The license granted respecting any Software for which a refund is given automatically terminates.

Non-Applicability of Warranty: The Limited Warranty provided hereunder for Hardware and Software portions of D-Link's products will not be applied to and does not cover any refurbished product and any product purchased through the inventory clearance or liquidation sale or other sales in which D-Link, the sellers, or the liquidators expressly disclaim their warranty obligation pertaining to the product and in that case, the product is being sold "As-Is" without any warranty whatsoever including, without limitation, the Limited Warranty as described herein, notwithstanding anything stated herein to the contrary.

Submitting A Claim: The customer shall return the product to the original purchase point based on its return policy. In case the return policy period has expired and the product is within warranty, the customer shall submit a claim to D-Link as outlined below:

- The customer must submit with the product as part of the claim a written description of the Hardware defect or Software nonconformance in sufficient detail to allow D-Link to confirm the same, along with proof of purchase of the product (such as a copy of the dated purchase invoice for the product) if the product is not registered.
- The customer must obtain a Case ID Number from D-Link Technical Support at 1-877-453-5465, who will attempt to assist the customer in resolving any suspected defects with the product. If the product is considered defective, the customer must obtain a Return Material Authorization ("RMA") number by completing the RMA form and entering the assigned Case ID Number at <https://rma.dlink.com/>.
- After an RMA number is issued, the defective product must be packaged securely in the original or other suitable shipping package to ensure that it will not be damaged in transit, and the RMA number must be prominently marked on the outside of the package. Do not include any manuals or accessories in the shipping package. D-Link will only replace the defective portion of the product and will not ship back any accessories.
- The customer is responsible for all in-bound shipping charges to D-Link. No Cash on Delivery ("COD") is allowed. Products sent COD will either be rejected by D-Link or become the property of D-Link. Products shall be fully insured by the customer and shipped to **D-Link Systems, Inc., 17595 Mt. Herrmann, Fountain Valley, CA 92708**. D-Link will not be held responsible for any packages that are lost in transit to D-Link. The repaired or replaced packages will be shipped to the customer via UPS Ground or any common carrier selected by D-Link. Return shipping charges shall be prepaid by D-Link if you use an address in the United States, otherwise we will ship the product to you freight collect. Expedited shipping is available upon request and provided shipping charges are prepaid by the customer.

D-Link may reject or return any product that is not packaged and shipped in strict compliance with the foregoing requirements, or for which an RMA number is not visible from the outside of the package. The product owner agrees to pay D-Link's reasonable handling and return shipping charges for any product that is not packaged and shipped in accordance with the foregoing requirements, or that is determined by D-Link not to be defective or non-conforming.

What Is Not Covered: The Limited Warranty provided herein by D-Link does not cover: Products that, in D-Link's judgment, have been subjected to abuse, accident, alteration, modification, tampering, negligence, misuse, faulty installation, lack of reasonable care, repair or service in any way that

is not contemplated in the documentation for the product, or if the model or serial number has been altered, tampered with, defaced or removed; Initial installation, installation and removal of the product for repair, and shipping costs; Operational adjustments covered in the operating manual for the product, and normal maintenance; Damage that occurs in shipment, due to act of God, failures due to power surge, and cosmetic damage; Any hardware, software, firmware or other products or services provided by anyone other than D-Link; and Products that have been purchased from inventory clearance or liquidation sales or other sales in which D-Link, the sellers, or the liquidators expressly disclaim their warranty obligation pertaining to the product. While necessary maintenance or repairs on your Product can be performed by any company, we recommend that you use only an Authorized D-Link Service Office. Improper or incorrectly performed maintenance or repair voids this Limited Warranty.

Disclaimer of Other Warranties: EXCEPT FOR THE LIMITED WARRANTY SPECIFIED HEREIN, THE PRODUCT IS PROVIDED "AS-IS" WITHOUT ANY WARRANTY OF ANY KIND WHATSOEVER INCLUDING, WITHOUT LIMITATION, ANY WARRANTY OF MERCHANTABILITY, FITNESS FOR A PARTICULAR PURPOSE AND NON-INFRINGEMENT. IF ANY IMPLIED WARRANTY CANNOT BE DISCLAIMED IN ANY TERRITORY WHERE A PRODUCT IS SOLD, THE DURATION OF SUCH IMPLIED WARRANTY SHALL BE LIMITED TO NINETY (90) DAYS. EXCEPT AS EXPRESSLY COVERED UNDER THE LIMITED WARRANTY PROVIDED HEREIN, THE ENTIRE RISK AS TO THE QUALITY, SELECTION AND PERFORMANCE OF THE PRODUCT IS WITH THE PURCHASER OF THE PRODUCT.

Limitation of Liability: TO THE MAXIMUM EXTENT PERMITTED BY LAW, D-LINK IS NOT LIABLE UNDER ANY CONTRACT, NEGLIGENCE, STRICT LIABILITY OR OTHER LEGAL OR EQUITABLE THEORY FOR ANY LOSS OF USE OF THE PRODUCT, INCONVENIENCE OR DAMAGES OF ANY CHARACTER, WHETHER DIRECT, SPECIAL, INCIDENTAL OR CONSEQUENTIAL (INCLUDING, BUT NOT LIMITED TO, DAMAGES FOR LOSS OF GOODWILL, LOSS OF REVENUE OR PROFIT, WORK STOPPAGE, COMPUTER FAILURE OR MALFUNCTION, FAILURE OF OTHER EQUIPMENT OR COMPUTER PROGRAMS TO WHICH D-LINK'S PRODUCT IS CONNECTED WITH, LOSS OF INFORMATION OR DATA CONTAINED IN, STORED ON, OR INTEGRATED WITH ANY PRODUCT RETURNED TO D-LINK FOR WARRANTY SERVICE) RESULTING FROM THE USE OF THE PRODUCT, RELATING TO WARRANTY SERVICE, OR ARISING OUT OF ANY BREACH OF THIS LIMITED WARRANTY, EVEN IF D-LINK HAS BEEN ADVISED OF THE POSSIBILITY OF SUCH DAMAGES. THE SOLE REMEDY FOR A BREACH OF THE FOREGOING LIMITED WARRANTY IS REPAIR, REPLACEMENT OR REFUND OF THE DEFECTIVE OR NON-CONFORMING PRODUCT. THE MAXIMUM LIABILITY OF D-LINK UNDER THIS WARRANTY IS LIMITED TO THE PURCHASE PRICE OF THE PRODUCT COVERED BY THE WARRANTY. THE FOREGOING EXPRESS WRITTEN WARRANTIES AND REMEDIES ARE EXCLUSIVE AND ARE IN LIEU OF ANY OTHER WARRANTIES OR REMEDIES, EXPRESS, IMPLIED OR STATUTORY.

Governing Law. This Limited Warranty shall be governed by the laws of the State of California. Some states do not allow exclusion or limitation of incidental or consequential damages, or limitations on how long an implied warranty lasts, so the foregoing limitations and exclusions may not apply. This Limited Warranty provides specific legal rights and you may also have other rights which vary from state to state.

Trademarks: D-Link is a registered trademark of D-Link Systems, Inc. Other trademarks or registered trademarks are the property of their respective owners.

Copyright Statement: No part of this publication or documentation accompanying this product may be reproduced in any form or by any means or used to make any derivative such as translation, transformation, or adaptation without permission from D-Link Corporation/D-Link Systems, Inc., as stipulated by the United States Copyright Act of 1976 and any amendments thereto. Contents are subject to change without prior notice. Copyright 2007 by D-Link Corporation/D-Link Systems, Inc. All rights reserved.

CE Mark Warning: This is a Class A product. In a residential environment, this product may cause radio interference, in which case the user may be required to take adequate measures.

FCC Statement: This equipment has been tested and found to comply with the limits for a Class A digital device, pursuant to part 15 of the FCC Rules. These limits are designed to provide reasonable protection against harmful interference in a commercial installation. This equipment generates, uses, and can radiate radio frequency energy and, if not installed and used in accordance with the instructions, may cause harmful interference to radio communication. However, there is no guarantee that interference will not occur in a particular installation. Operation of this equipment in a residential environment is likely to cause harmful interference to radio or television reception. If this equipment does cause harmful interference to radio or television reception, which can be determined by turning the equipment off and on, the user is encouraged to try to correct the interference by one or more of the following measures:

- Reorient or relocate the receiving antenna.
- Increase the separation between the equipment and receiver.
- Connect the equipment into an outlet on a circuit different from that to which the receiver is connected.
- Consult the dealer or an experienced radio/TV technician for help.

For detailed warranty information applicable to products purchased outside the United States, please contact the corresponding local D-Link office.

Product Registration:

Register your D-Link product online at <http://support.dlink.com/register/>

Product registration is entirely voluntary and failure to complete or return this form will not diminish your warranty rights.



D-Link Europe Limited Lifetime Warranty

Dear Customer,

Please read below to understand the details of the warranty coverage you have.

Warranty terms for D-LINK xStack products:

All D-Link xStack products* are supplied with a 5 year warranty as standard. To enable the Limited Lifetime Warranty on this product you must register the product, within the first three months of purchase**, on the following website: <http://www.dlink.biz/productregistration/>

D-Link will then provide you with a Limited Lifetime Warranty reference number for this product. Please retain your original dated proof of purchase with a note of the serial number, and Limited Lifetime Warranty reference number together with this warranty statement and place each document in a safe location. When you make a warranty claim on a defective product, you may be asked to provide this information.

Nothing in this Limited Lifetime Warranty affects your statutory rights as a consumer. The following are special terms applicable to your Limited Lifetime hardware warranty.

Warranty beneficiary

The warranty beneficiary is the original end user. The original end user is defined as the person that purchases the product as the first owner.

Duration of Limited Lifetime Warranty

As long as the original end-user continues to own or use the product with the following conditions:

- fan and power supplies are limited to a five (5) year warranty only
- in the event of discontinuance of product manufacture, D-Link warranty support is limited to five (5) years from the announcement of discontinuance. If a product is no longer available for replacement, D-Link will issue a product comparable or better to the one originally purchased.

Replacement, Repair or Refund Procedure for Hardware

D-Link or its service center will use commercially reasonable efforts to ship a replacement part within ten (10) working days after receipt of the RMA request. Actual delivery times may vary depending on customer location. D-Link reserves the right to refund the purchase price as its exclusive warranty remedy.

To Receive a Return Materials Authorization (RMA) Number, please visit: <http://service.dlink.biz> and for Italy and Spain, please use: <http://rma.dlink.es> or <http://rma.dlink.it>.



D-Link Limited Lifetime Warranty

Hardware: D-Link warrants the D-Link hardware named above against defects in materials and workmanship for the period specified above. If D-Link receives notice of such defects during the warranty period, D-Link will, at its option, either repair or replace products proving to be defective. Replacement products may be either new or like-new.

Software. D-Link warrants that D-Link software will not fail to execute its programming instructions, for the period specified above, due to defects in material and workmanship when properly installed and used. If D-Link receives notice of such defects during the warranty period, D-Link will replace software media that does not execute its programming instructions due to such defects.

Warranty exclusions

This warranty does not apply if the software, product or any other equipment upon which the software is authorized to be used (a) has been altered, except by D-Link or its authorized representative, (b) has not been installed, operated, repaired, or maintained in accordance with instructions supplied by D-Link (improper use or improper maintenance), (c) has been subjected to abnormal physical or electrical stress, misuse, negligence, or accident; (d) is licensed, for beta, evaluation, testing or demonstration purposes for which D-Link does not charge a purchase price or license fee or (e) defects are caused by force majeure (lightning, floods, war, etc.), soiling, by extraordinary environmental influences or by other circumstances of which D-Link is not responsible.

Disclaimer of warranty

Please note, some countries do not allow the disclaimer of implied terms in contracts with consumers and the disclaimer below may not apply to you.

To the extent allowed by local law, the above warranties are exclusive and no other warranty, condition or other term, whether written or oral, is expressed or implied. D-Link specifically disclaims any implied warranties, conditions and terms of merchantability, satisfactory quality, and fitness for a particular purpose.

To the extent allowed by local law, the remedies in this warranty statement are customer's sole and exclusive remedies. Except as indicated above, in no event will D-Link or its suppliers be liable for loss of data or for indirect, special, incidental, consequential (including lost profit or data), or other damage, whether based in a contract, tort, or otherwise.

To the extent local law mandatorily requires a definition of "Lifetime Warranty" different from that provided here, then the local law definition will supersede and take precedence.

Valid law

The warranty is subject to the valid laws in the country of purchase and is to be interpreted in the warranty terms with the said laws. You may have additional legal rights that are not restricted by this warranty. Nothing in this Limited Lifetime Warranty affects your statutory rights as a consumer.

* DES-6500 series is excluded from the Limited Lifetime Warranty offering and will be supplied with a standard 5 year warranty.

** Failure to register this product within the first three months of purchase [by the first user only] will invalidate the Limited Lifetime Warranty.

Tech Support

Technical Support

You can find software updates and user documentation on the D-Link website.

D-Link provides free technical support for customers within the United States and within Canada for the duration of the service period, and warranty confirmation service, during the warranty period on this product. U.S. and Canadian customers can contact D-Link technical support through our website, or by phone.

Tech Support for customers within the United States:

D-Link Technical Support over the Telephone:

(877) 354-6555

Monday to Friday 8:00am to 5:00pm PST

D-Link Technical Support over the Internet:

<http://support.dlink.com>

email: support@dlink.com

Tech Support for customers within Canada:

D-Link Technical Support over the Telephone:

(877) 354-6560

Monday to Friday 7:30am to 9:00pm EST

D-Link Technical Support over the Internet:

<http://support.dlink.com>

email: support@dlink.ca

D-Link[®]
Building Networks for People

Technical Support

You can find software updates and user documentation on the D-Link websites.

If you require product support, we encourage you to browse our FAQ section on the website before contacting the support line. We have many FAQ's that we hope will provide you a speedy resolution for your problem.

For Customers within the United Kingdom & Ireland:

D-Link UK & Ireland Technical Support over the Internet:

<http://www.dlink.co.uk>

<ftp://ftp.dlink.co.uk>

D-Link UK & Ireland Technical Support over the Telephone:

08456 12 0003 (United Kingdom)

+1890 886 899 (Ireland)

Lines Open

8.00am-10.00pm Mon-Fri

10.00am-7.00pm Sat & Sun

For Customers within Canada:

D-Link Canada Technical Support over the Telephone:

1-800-361-5265 (Canada)

Mon. to Fri. 7:30AM to 9:00PM EST

D-Link Canada Technical Support over the Internet:

<http://support.dlink.ca>

email: support@dlink.ca

D-Link[®]
Building Networks for People

Technische Unterstützung

Aktualisierte Versionen von Software und Benutzerhandbuch finden Sie auf der Website von D-Link.

D-Link bietet kostenfreie technische Unterstützung für Kunden innerhalb Deutschlands, Österreichs, der Schweiz und Osteuropas.

Unsere Kunden können technische Unterstützung über unsere Website, per E-Mail oder telefonisch anfordern.

Web: <http://www.dlink.de>

E-Mail: support@dlink.de

Telefon: +49 (1805)2787

0,12 €/Min aus dem Festnetz der Deutschen Telekom.

Telefonische technische Unterstützung erhalten Sie Montags bis Freitags von 09.00 bis 17.30 Uhr.

Unterstützung erhalten Sie auch bei der Premiumhotline für D-Link Produkte unter der Rufnummer 09001-475767

Montag bis Freitag von 6-22 Uhr und am Wochenende von 11-18 Uhr.

1,75€/Min aus dem Festnetz der Deutschen Telekom.

Wenn Sie Kunde von D-Link außerhalb Deutschlands, Österreichs, der Schweiz und Osteuropas sind, wenden Sie sich bitte an die zuständige Niederlassung aus der Liste im Benutzerhandbuch.

D-Link[®]
Building Networks for People

Assistance technique

Vous trouverez la documentation et les logiciels les plus récents sur le site web **D-Link**.

Vous pouvez contacter le service technique de **D-Link** par notre site internet ou par téléphone.

Support technique destiné aux clients établis en France:

Assistance technique D-Link par téléphone :

0820 0803 03

N° INDIGO - 0,12€ TTC/min*

*Prix en France Métropolitaine au 3 mars 2005

Du lundi au samedi – de 9h00 à 19h00

Assistance technique D-Link sur internet :

<http://www.dlink.fr>

e-mail : support@dlink.fr

Support technique destiné aux clients établis au Canada :

Assistance technique D-Link par téléphone :

(800) 361-5265

Lun.-Ven. 7h30 à 21h00 HNE.

Assistance technique D-Link sur internet :

<http://support.dlink.ca>

e-mail : support@dlink.ca

D-Link[®]
Building Networks for People

Asistencia Técnica

Puede encontrar las últimas versiones de software así como documentación técnica en el sitio web de **D-Link**.

D-Link ofrece asistencia técnica gratuita para clientes residentes en España durante el periodo de garantía del producto.

Asistencia Técnica de D-Link por teléfono:

+34 902 30 45 45

Lunes a Viernes de 9:00 a 14:00 y de 15:00 a 18:00

Asistencia Técnica de D-Link a través de Internet:

<http://www.dlink.es/support/>

e-mail: soporte@dlink.es

D-Link[®]
Building Networks for People

Supporto tecnico

Gli ultimi aggiornamenti e la documentazione sono disponibili sul sito D-Link.

Supporto tecnico per i clienti residenti in Italia

D-Link Mediterraneo S.r.L.

Via N. Bonnet 6/B 20154 Milano

Supporto Tecnico dal lunedì al venerdì dalle ore
9.00 alle ore 19.00 con orario continuato
Telefono: 02-39607160

URL : <http://www.dlink.it/supporto.html>

Email: tech@dlink.it

D-Link[®]
Building Networks for People

Technical Support

You can find software updates and user documentation on the D-Link website.

D-Link provides free technical support for customers within Benelux for the duration of the warranty period on this product.

Benelux customers can contact D-Link technical support through our website, or by phone.

Tech Support for customers within the Netherlands:

D-Link Technical Support over the Telephone:

0900 501 2007

Monday to Friday 9:00 am to 10:00 pm

D-Link Technical Support over the Internet:

www.dlink.nl

Tech Support for customers within Belgium:

D-Link Technical Support over the Telephone:

070 66 06 40

Monday to Friday 9:00 am to 10:00 pm

D-Link Technical Support over the Internet:

www.dlink.be

Tech Support for customers within Luxemburg:

D-Link Technical Support over the Telephone:

+32 70 66 06 40

Monday to Friday 9:00 am to 10:00 pm

D-Link Technical Support over the Internet:

www.dlink.be

D-Link®
Building Networks for People

Pomoc techniczna

Najnowsze wersje oprogramowania i dokumentacji użytkownika można znaleźć w serwisie internetowym firmy D-Link.

D-Link zapewnia bezpłatną pomoc techniczną klientom w Polsce w okresie gwarancyjnym produktu.

Klienci z Polski mogą się kontaktować z działem pomocy technicznej firmy D-Link za pośrednictwem Internetu lub telefonicznie.

Telefoniczna pomoc techniczna firmy D-Link:

(+48 12) 25-44-000

Pomoc techniczna firmy D-Link świadczona przez Internet:

URL: <http://www.dlink.pl>

e-mail: dlink@fixit.pl

D-Link[®]
Building Networks for People

Technická podpora

Aktualizované verze software a uživatelských příruček najdete na webové stránce firmy D-Link.

D-Link poskytuje svým zákazníkům bezplatnou technickou podporu

Zákazníci mohou kontaktovat oddělení technické podpory přes webové stránky, mailem nebo telefonicky

Web: <http://www.dlink.cz/support/>

E-mail: support@dlink.cz

Telefon: 224 247 503

Telefonická podpora je v provozu:

PO- PÁ od 09.00 do 17.00

D-Link[®]
Building Networks for People

Technikai Támogatás

Meghajtó programokat és frissítéseket a **D-Link** Magyarország weblapjáról tölthet le.

Telefonon technikai segítséget munkanapokon hétfőtől-csütörtökig 9.00 – 16.00 óráig és pénteken 9.00 – 14.00 óráig kérhet a **(1) 461-3001** telefonszámon vagy a **support@dlink.hu** emailcímen.

Magyarországi technikai támogatás :

D-Link Magyarország

1074 Budapest, Alsóerdősor u. 6. – R70 Irodaház 1 em.

Tel. : 06 1 461-3001

Fax : 06 1 461-3004

email : support@dlink.hu

URL : <http://www.dlink.hu>

D-Link[®]
Building Networks for People

Teknisk Support

Du kan finne programvare oppdateringer og bruker dokumentasjon på D-Links web sider.

D-Link tilbyr sine kunder gratis teknisk support under produktets garantitid.

Kunder kan kontakte D-Links teknisk support via våre hjemmesider, eller på tlf.

Teknisk Support:

D-Link Teknisk telefon Support:

800 10 610

(Hverdager 08:00-20:00)

D-Link Teknisk Support over Internett:

<http://www.dlink.no>

D-Link[®]
Building Networks for People

Teknisk Support

Du finder software opdateringer og bruger-dokumentation på D-Link's hjemmeside.

D-Link tilbyder gratis teknisk support til kunder i Danmark i hele produktets garantiperiode.

Danske kunder kan kontakte D-Link's tekniske support via vores hjemmeside eller telefonisk.

D-Link teknisk support over telefonen:

Tlf. 7026 9040

Hverdager: kl. 08:00 – 20:00

D-Link teknisk support på Internettet:

<http://www.dlink.dk>

D-Link[®]
Building Networks for People

Teknistä tukea asiakkaille Suomessa:

D-Link tarjoaa teknistä tukea asiakkailleen.

Tuotteen takuun voimassaoloajan.

Tekninen tuki palvelee seuraavasti:

Arkisin klo. 9 - 21

numerosta

0800-114 677

Internetin kautta

Ajurit ja lisätietoja tuotteista.

<http://www.dlink.fi>

Sähköpostin kautta

voit myös tehdä kyselyitä.

D-Link[®]
Building Networks for People

Teknisk Support

På vår hemsida kan du hitta mer information om mjukvaru uppdateringar och annan användarinformation.

D-Link tillhandahåller teknisk support till kunder i Sverige under hela garantitiden för denna produkt.

Teknisk Support för kunder i Sverige:

D-Link Teknisk Support via telefon:

0770-33 00 35

Vardagar 08.00-20.00

D-Link Teknisk Support via Internet:

<http://www.dlink.se>

D-Link®
Building Networks for People

Suporte Técnico

Você pode encontrar atualizações de software e documentação de utilizador no site de D-Link Portugal <http://www.dlink.pt>.

A D-Link fornece suporte técnico gratuito para clientes no Portugal durante o período de vigência de garantia deste produto.

Suporte Técnico para clientes no Portugal:

Assistência Técnica:

Email: suporte@dlink.es

<http://www.dlink.pt/support/>

<ftp://ftp.dlink.es>

D-Link[®]
Building Networks for People

Τεχνική Υποστήριξη

Μπορείτε να βρείτε software updates και πληροφορίες για τη χρήση των προϊόντων στις ιστοσελίδες της D-Link

Η D-Link προσφέρει στους πελάτες της δωρεάν υποστήριξη στον Ελλαδικό χώρο

Μπορείτε να επικοινωνείτε με το τμήμα τεχνικής υποστήριξης μέσω της ιστοσελίδας ή μέσω τηλεφώνου

Για πελάτες εντός του Ελλαδικού χώρου:

Τηλεφωνική υποστήριξη D-Link :

Τηλ: 210 86 11 114

Φαξ: 210 86 53 172

(Δευτέρα-Παρασκευή 09:00-17:00)

e-mail: support@dlink.gr

Τεχνική υποστήριξη D-Link μέσω Internet:

<http://www.dlink.gr>

<ftp://ftp.dlink.it>

D-Link[®]
Building Networks for People

Technical Support

You can find software updates and user documentation on the D-Link website.

Tech Support for customers in Australia:

Tel: 1300-766-868

Monday to Friday 8:00am to 8:00pm EST

Saturday 9:00am to 1:00pm EST

<http://www.dlink.com.au>

e-mail: support@dlink.com.au

India:

Tel: 1800-222-002

Monday to Friday 9:30AM to 7:00PM

<http://www.dlink.co.in/support/productsupport.aspx>

Indonesia, Malaysia, Singapore and Thailand:

Tel: +62-21-3851275 (Indonesia)

Tel: 1800-882-880 (Malaysia)

Tel: +65 66229355 (Singapore)

Tel: +66-2-719-8978/9 (Thailand)

Monday to Friday 9:00am to 6:00pm

<http://www.dlink.com.sg/support/>

e-mail: support@dlink.com.sg

Korea:

Tel: +82-2-890-5496

Monday to Friday 9:00am to 6:00pm

<http://www.d-link.co.kr>

e-mail: lee@d-link.co.kr

New Zealand:

Tel: 0800-900-900

Monday to Friday 8:30am to 8:30pm

Saturday 9:00am to 5:00pm

<http://www.dlink.co.nz>

e-mail: support@dlink.co.nz

D-Link®
Building Networks for People

Technical Support

You can find software updates and user documentation on the D-Link website.

Tech Support for customers in Egypt:

Tel: +202-2919035 or +202-2919047
Sunday to Thursday 9:00am to 5:00pm
<http://support.dlink-me.com>
e-mail: amostafa@dlink-me.com

Iran:

Tel: +98-21-88822613
Sunday to Thursday 9:00am to 6:00pm
<http://support.dlink-me.com>
e-mail: support.ir@dlink-me.com

Israel:

Tel: +972-9-9715701
Sunday to Thursday 9:00am to 5:00pm
<http://www.dlink.co.il/support/>
e-mail: support@dlink.co.il

Pakistan:

Tel: +92-21-4548158 or +92-21-4548310
Sunday to Thursday 9:00am to 6:00pm
<http://support.dlink-me.com>
e-mail: support.pk@dlink-me.com

South Africa and Sub Sahara Region:

Tel: +27-12-665-2165

08600 DLINK (for South Africa only)

Monday to Friday 8:30am to 9:00pm South Africa Time

<http://www.d-link.co.za>

Turkey:

Tel: +90-212-2895659
Monday to Friday 9:00am to 6:00pm
<http://www.dlink.com.tr>
e-mail: turkiye@dlink-me.com
e-mail: support@d-link.co.za

U.A.E and North Africa:

Tel: +971-4-391-6480 (U.A.E)

Sunday to Wednesday 9:00am to 6:00pm GMT+4

Thursday 9:00am to 1:00pm GMT+4

<http://support.dlink-me.com>

e-mail: support@dlink-me.com

D-Link[®]
Building Networks for People

Техническая поддержка

Обновления программного обеспечения и документация доступны на Интернет-сайте D-Link.

D-Link предоставляет бесплатную поддержку для клиентов в течение гарантийного срока.

Клиенты могут обратиться в группу технической поддержки D-Link по телефону или через Интернет.

Техническая поддержка D-Link:

+495-744-00-99

Техническая поддержка через Интернет

<http://www.dlink.ru>

e-mail: support@dlink.ru

D-Link[®]
Building Networks for People

Asistencia Técnica

D-Link Latin América pone a disposición de sus clientes, especificaciones, documentación y software mas reciente a través de nuestro Sitio Web

www.dlinkla.com

El servicio de soporte técnico tiene presencia en numerosos países de la Región Latino América, y presta asistencia gratuita a todos los clientes de D-Link, en forma telefónica e internet, a través de la casilla

soporte@dlinkla.com

Soporte Técnico Help Desk Argentina:

TTeléfono: 0800-12235465 Lunes a Viernes 09:00 am a 22:00 pm

Soporte Técnico Help Desk Chile:

Teléfono: 800 8 35465 Lunes a Viernes 08:00 am a 21:00 pm

Soporte Técnico Help Desk Colombia:

Teléfono: 01800-9525465 Lunes a Viernes 07:00 am a 20:00 pm

Soporte Técnico Help Desk Ecuador:

Teléfono: 1800-035465 Lunes a Viernes 07:00 am a 20:00 pm

Soporte Técnico Help Desk El Salvador:

Teléfono: 800-6335 Lunes a Viernes 06:00 am a 19:00 pm

Soporte Técnico Help Desk Guatemala:

Teléfono: 1800-8350255 Lunes a Viernes 06:00 am a 19:00 pm

Soporte Técnico Help Desk Panamá:

Teléfono: 00800 0525465 Lunes a Viernes 07:00 am a 20:00 pm

Soporte Técnico Help Desk Costa Rica:

Teléfono: 0800 0521478 Lunes a Viernes 06:00 am a 19:00 pm

Soporte Técnico Help Desk Perú:

Teléfono: 0800-00968 Lunes a Viernes 07:00 am a 20:00 pm

Soporte Técnico Help Desk República Dominicana:

Teléfono: 1888 7515478 Lunes a Viernes 06:00 am a 19:00 pm

Soporte Técnico Help Desk Venezuela:

Teléfono: 0800-1005767 Lunes a Viernes 08:00 am a 21:00 pm

D-Link®
Building Networks for People

Suporte Técnico

Você pode encontrar atualizações de software e documentação de usuário no site da D-Link Brasil www.dlinkbrasil.com.br.

A D-Link fornece suporte técnico gratuito para clientes no Brasil durante o período de vigência da garantia deste produto.

Suporte Técnico para clientes no Brasil:

Telefone

São Paulo +11-2185-9301

Segunda à sexta

Das 8h30 às 18h30

Demais Regiões do Brasil 0800 70 24 104

E-mail:

e-mail: suporte@dlinkbrasil.com.br

D-Link[®]
Building Networks for People

D-Link 友訊科技 台灣分公司 技術支援資訊

如果您還有任何本使用手冊無法協助您解決的產品相關問題，台灣地區用戶可以透過我們的網站、電子郵件或電話等方式與D-Link台灣地區技術支援工程師聯絡。

D-Link 免付費技術諮詢專線

0800-002-615

服務時間：週一至週五，早上8:30 到晚上7:00

(不含周六、日及國定假日)

網 站：<http://www.dlink.com.tw>

電子郵件：dssqa_service@dlink.com.tw

如果您是台灣地區以外的用戶，請參考D-Link網站 全球各地分公司的聯絡資訊以取得相關支援服務。

產品保固期限、台灣區維修據點查詢，請參考以下網頁說明：

<http://www.dlink.com.tw>

產品維修：

使用者可直接送至全省聯強直營維修站或請洽您的原購買經銷商。

D-Link[®]
Building Networks for People

Dukungan Teknis

Update perangkat lunak dan dokumentasi pengguna dapat diperoleh pada situs web D-Link.

Dukungan Teknis untuk pelanggan:

Dukungan Teknis D-Link melalui telepon:

Tel: +62-21-3851275

Senin sampai Jumat 9:00 - 12:30, 14:00 - 18:00

Waktu Singapura

Dukungan Teknis D-Link melalui Internet:

e-mail: support@dlink.com.sg

D-Link[®]
Building Networks for People

技术支持

办公地址：北京市朝阳区建国路 71 号惠通时代广场 C1
座 202

室 邮编:100025

技术支持中心电话：8008296688/(028) 66052968

技术支持中心传真：(028)85176948

维修中心地址：北京市朝阳区建国路 71 号惠通时代广场
C1 座 202 室 邮编：100025

维修中心电话：(010) 58635800

维修中心传真：(010) 58635799

网址：<http://www.dlink.com.cn>

办公时间：周一到周五，早 09:00 到晚 18:00

D-Link[®]
Building Networks for People

International Offices

U.S.A 17595 Mt. Herrmann Street Fountain Valley, CA 92708 TEL: 1-800-326-1688 URL: www.dlink.com	Germany Schwalbacher Strasse 74 D-65760 Eschborn, Germany TEL: +49 (0)6196 77 99 0 FAX: +49 (0)6196 77 99 300 URL: www.dlink.de	Spain Avenida Diagonal, 593-95, 9th floor 08014 Barcelona, Spain TEL: +34 93 409 07 70 FAX: +34 93 491 07 95 URL: www.dlink.es	Egypt 47,El Merghany street, Heliopolis Cairo-Egypt TEL: +202-2919035, +202-2919047 FAX: +202-2919051 URL: www.dlink-me.com
Canada 2180 Winston Park Drive Oakville, Ontario, L6H 5W1 Canada TEL: 1-905-8295033 FAX: 1-905-8295223 URL: www.dlink.ca	Greece 101, Panagoulis Str. 163-43 Heliopolis, Athens, Greece TEL: +30 210 9914512 FAX: +30 210 9916902 URL: www.dlink.gr	Sweden Gustavslundsvägen 151B S-167 51 Bromma Sweden TEL: +46 (0)8 564 619 00 FAX: +46 (0)8 564 619 01 URL: www.dlink.se	Israel 11 Hamanofim Street Ackerstein Towers, Regus Business Center P.O.B 2148, Hertzelia-Pituach 46120 Israel TEL: +972-9-9715700 FAX: +972-9-9715601 URL: www.dlink.co.il
Europe (U. K.) D-Link (Europe) Ltd D-Link House, Abbey Road Park Royal, London NW10 7BX United Kingdom TEL: +44 (0)20 8955 9000 FAX: +44 (0)20 8955 9001 URL: www.dlink.co.uk	Hungary Rákóczi út 70-72 HU-1074 Budapest, Hungary TEL: +36 (0) 1 461 30 00 FAX: +36 (0) 1 461 30 04 URL: www.dlink.hu	Switzerland Glatt Tower, 2.OG Postfach CH-8301 Glattzentrum Switzerland TEL: +41 (0)1 832 11 00 FAX: +41 (0)1 832 11 01 URL: www.dlink.ch	Latin America Av. Vitacura # 2939, floor 6th Las Condes, Santiago RM Chile TEL: 56-2-5838-950 FAX: 56-2-5838-952 URL: www.dlinkla.com
Austria Millennium Tower Handelskai 94-96 A-1200 WIEN, Austria TEL: +43 (0)1 240 27 270 FAX: +43 (0)1 240 27 271 URL: www.dlink.at	Italy Via Nino Bonnet n. 6/b 20154 – Milano, Italy TEL: +39 02 2900 0676 FAX: +39 02 2900 1723 URL: www.dlink.it	Singapore 1 International Business Park #03-12 The Synergy Singapore 609917 TEL: 65-6774-6233 FAX: 65-6774-6322 URL: www.dlink-intl.com	Brazil Av das Nacoes Unidas 11857 – 14- andar - cj 141/142 Brooklin Novo Sao Paulo - SP - Brazil CEP 04578-000 (Zip Code) TEL: (55 11) 21859300 FAX: (55 11) 21859322 URL: www.dlinkbrasil.com.br
Belgium Rue des Colonies 11 B-1000 Brussels, Belgium TEL: +32 (0)2 517 7111 FAX: +32 (0)2 517 6500 URL: www.dlink.be	Luxembourg Rue des Colonies 11 B-1000 Brussels, Belgium TEL: +32 (0)2 517 7111 FAX: +32 (0)2 517 6500 URL: www.dlink.be	Australia 1 Giffnock Avenue North Ryde, NSW 2113 Australia TEL: 61-2-8899-1800 FAX: 61-2-8899-1868 URL: www.dlink.com.au	South Africa Einstein Park II Block B 102-106 Witch-Hazel Avenue First Floor Block B Einstein Park II Highveld Techno Park Centurion Gauteng Republic of South Africa TEL: 27-12-665-2165 FAX: 27-12-665-2186 URL: www.d-link.co.za
Bulgaria 60A Bulgaria Blvd., Office 1, Sofia 1680, Bulgaria TEL: +359 2 958 22 42 FAX: +359 2 958 65 57 URL: www.dlink.eu	Netherlands Weena 290 3012NJ Rotterdam, Netherlands TEL: +31 (0)10 282 1445 FAX: +31 (0)10 282 1331 URL: www.dlink.nl	India D-Link House, Plot No.5, Kurla-Bandra Complex Road, Off. CST Road, Santacruz (E), Mumbai - 400 098 India TEL: 91-22-26526696/ 30616666 FAX: 91-22-26528914/ 8476 URL: www.dlink.co.in	Russia Grafsky per., 14, floor 6 Moscow 129626 Russia TEL: 7-495-744-0099 FAX: 7-495-744-0099 #350 URL: www.dlink.ru
Czech Republic Vaclavske namesti 36 110 00 Praha 1 Czech Republic TEL: +420 224 247 500 FAX: +420 224 234 967 Hot line CZ: +420 225 281 553 Hot line SK: +421 263 813 628 URL: www.dlink.cz	Norway Karihaugveien 89 N-1086 Oslo, Norway TEL: +47 99 300 100 FAX: +47 22 30 90 85 URL: www.dlink.no	Middle East (Dubai) P.O.Box: 500376 Office: 103, Building:3 Dubai Internet City Dubai, United Arab Emirates TEL: +971-4-3916480 FAX: +971-4-3908881 URL: www.dlink-me.com	Taiwan No. 289, Sinhu 3rd Rd., Neihu District, Taipei City 114, Taiwan TEL: 886-2-6600-0123 FAX: 886-2-6600-1188 URL: www.dlink.com.tw
Denmark Naverland 2, DK-2600 Glostrup, Copenhagen, Denmark TEL: +45 43 96 9 040 FAX: +45 43 42 43 47 URL: www.dlink.dk	Poland Budynek Aurum ul. Waliców 11 00-851 Warszawa, Poland TEL: +48 (0) 22 583 92 75 FAX: +48 (0) 22 583 92 76 URL: www.dlink.pl	Turkey Cayazaya Maslak Yolu S/A Kat: 5, Istanbul, Turkey TEL: 0212-289-5659 FAX: 0212-289-7606 URL: www.dlink.com.tr	China No.202, C1 Building, Huitong Office Park, No. 71, Jianguo Road, Chaoyang District, Beijing 100025, China TEL +86-10-58635800 FAX: +86-10-58635799 URL: www.dlink.com.cn
Finland Latokartanontie 7A FIN-00700 Helsinki, Finland TEL : +358 10 309 8840 FAX: + 358 10 309 8841 URL: www.dlink.fi	Portugal Rua Fernando Palha, 50 Edificio Simol 1900 Lisbon, Portugal TEL: +351 21 8688493 FAX: +351 21 8622492 URL: www.dlink.es	Iran Unit 6, No. 39, 6th Alley, Sanaei St, Karimkhan Ave Tehran-IRAN TEL: 9821 8882 2613 FAX: 9821 8883 5492	
France 41 boulevard Vauban 78280 Guyancourt France TEL: +33 (0)1 30 23 86 88 FAX: +33 (0)1 30 23 86 89 URL: www.dlink.fr	Romania B-dul Unirii nr. 55, bl. E4A, sc.2, et. 4, ap. 39, sector 3, Bucuresti, Romania TEL: +40(0)21 320 23 05 FAX: +40(0)21 320 23 07 URL: www.dlink.eu	Pakistan Office#311, Business Avenue Main Shahrah-e-Faisal Karachi-Pakistan TEL: 92-21-4548158, 4548310 FAX: 92-21-4535103	

Registration Card

All Countries and Regions Excluding USA

Print, type or use block letters.

Your name: Mr./Ms _____

Organization: _____ Dept. _____

Your title at organization: _____

Telephone: _____ Fax: _____

Organization's full address: _____

Country: _____

Date of purchase (Month/Day/Year): _____

Product Model	Product Serial No.	* Product installed in type of computer	* Product installed in computer serial No.

(* Applies to adapters only)

Product was purchased from:

Reseller's name: _____

Telephone: _____

Answers to the following questions help us to support your product:

1. Where and how will the product primarily be used?

Home Office Travel Company Business Home Business Personal Use

2. How many employees work at installation site?

1 employee 2-9 10-49 50-99 100-499 500-999 1000 or more

3. What network protocol(s) does your organization use ?

XNS/IPX TCP/IP DECnet Others _____

4. What network operating system(s) does your organization use ?

D-Link LANsmart Novell NetWare NetWare Lite SCO Unix/Xenix PC NFS 3Com 3+Open Cisco Network

Banyan Vines DECnet Pathwork Windows NT Windows 98 Windows 2000/ME Windows XP

Others _____

5. What network management program does your organization use ?

D-View HP OpenView/Windows HP OpenView/Unix SunNet Manager Novell NMS

NetView 6000 Others _____

6. What network medium/media does your organization use ?

Fiber-optics Thick coax Ethernet Thin coax Ethernet 10BASE-T UTP/STP

100BASE-TX 1000BASE-T Wireless 802.11b and 802.11g wireless 802.11a Others _____

7. What applications are used on your network?

Desktop publishing Spreadsheet Word processing CAD/CAM

Database management Accounting Others _____

8. What category best describes your company?

Aerospace Engineering Education Finance Hospital Legal Insurance/Real Estate Manufacturing

Retail/Chain store/Wholesale Government Transportation/Utilities/Communication VAR

System house/company Other _____

9. Would you recommend your D-Link product to a friend?

Yes No Don't know yet

10. Your comments on this product?

PLEASE
PLACE STAMP
HERE

TO:

D-Link®