



**XSTACK**<sup>®</sup>

## Web UI Reference Guide

Product Model: xStack<sup>®</sup> DGS-3200 Series  
Layer 2 Managed Gigabit Ethernet Switch  
Release 2.00



---

Information in this document is subject to change without notice.

© 2011 D-Link Corporation. All rights reserved.

Reproduction in any manner whatsoever without the written permission of D-Link Corporation is strictly forbidden.

Trademarks used in this text: D-Link and the D-LINK logo are trademarks of D-Link Corporation; Microsoft and Windows are registered trademarks of Microsoft Corporation.

Other trademarks and trade names may be used in this document to refer to either the entities claiming the marks and names or their products. D-Link Corporation disclaims any proprietary interest in trademarks and trade names other than its own.

June 2011 P/N 651GS3200045G

# Table of Contents

Intended Readers .....	xi
Typographical Conventions .....	xi
Notes, Notices, and Cautions .....	xi
Safety Cautions .....	xii
General Precautions for Rack-Mountable Products .....	xiii
Lithium Battery Precaution .....	xiv
Protecting Against Electrostatic Discharge .....	xiv
<b>Web-based Switch Configuration.....</b>	<b>1</b>
Introduction .....	1
Logging onto the Web Manager.....	1
Web-based User Interface .....	2
Areas of the User Interface .....	2
Web Pages.....	3
<b>Configuration .....</b>	<b>4</b>
Device Information .....	5
System Information .....	5
Serial Port Settings.....	6
IP Address .....	6
Setting the Switch’s IP Address using the Console Interface .....	7
Port Configuration.....	8
Port Auto Negotiation Information .....	8
Port Detail Information .....	8
Port Settings .....	9
Port Description Settings.....	11
Port Error Disabled .....	12
Jumbo Frame Settings.....	12
Static ARP Settings .....	12
Gratuitous ARP .....	13
Gratuitous ARP Global Settings .....	13
Gratuitous ARP Settings .....	13
User Accounts .....	14
Admin and User Privileges .....	15
Command Logging Settings.....	15
System Log Configuration .....	16
System Log Settings.....	16
System Log Host.....	16
System Severity Settings.....	17
MAC Address Aging Time .....	18
Web Settings .....	18
Telnet Settings.....	19
Password Encryption.....	19

CLI Paging Settings .....	19
Firmware Information .....	20
Dual Configuration Settings.....	21
Power Saving .....	23
LED State Settings.....	23
Power Saving Settings .....	24
Power Saving LED Settings.....	25
Power Saving Port Settings.....	25
MAC Notification Settings .....	26
MAC Notification Global Settings.....	26
MAC Notification Port Settings.....	26
SNMP Settings .....	27
SNMP Global State Settings.....	28
SNMP Linkchange Traps Settings.....	28
SNMP View Table.....	29
SNMP Group Table .....	30
SNMP User Table.....	31
SNMP Community Table.....	32
SNMP Host Table.....	33
SNMP v6Host Table.....	34
SNMP Engine ID.....	34
SNMP Trap Configuration.....	35
RMON .....	35
CPU Filter L3 Control Packet Settings .....	36
Single IP Management .....	36
Single IP Settings.....	38
Topology.....	39
Firmware Upgrade .....	46
Configuration File Backup/Restore.....	46
Upload Log File.....	46
SD Card FS Settings (DGS-3200-24 Only) .....	47
SD Card Management (DGS-3200-24 Only).....	48
SD Card Backup Settings.....	48
SD Card Execute Settings.....	48
<b>L2 Features.....</b>	<b>50</b>
VLAN .....	50
802.1Q VLAN.....	50
802.1v Protocol VLAN .....	58
802.1v Protocol Group Settings.....	58
802.1v Protocol VLAN Settings .....	59
GVRP Settings.....	60
MAC-based VLAN Settings .....	61
Private VLAN Settings .....	61
PVID Auto Assign Settings .....	64
Voice VLAN.....	64

Voice VLAN Global Settings .....	64
Voice VLAN Port Settings .....	65
Voice VLAN OUI Settings .....	66
Voice VLAN Device .....	66
Voice VLAN LLDP-MED Voice Device .....	67
VLAN Trunk Settings .....	67
Browse VLAN .....	68
Layer 2 Protocol Tunneling Settings .....	68
Egress Filter Settings .....	69
L2 Multicast Control .....	69
IGMP Snooping .....	70
IGMP Snooping Settings .....	70
IGMP Snooping Rate Limit Settings .....	72
IGMP Snooping Static Group Settings .....	73
IGMP Router Port .....	74
IGMP Snooping Group .....	74
IGMP Snooping Forwarding Table .....	75
IGMP Snooping Counter .....	75
IGMP Host Table .....	76
MLD Snooping .....	77
MLD Snooping Settings .....	77
MLD Snooping Rate Limit Settings .....	80
MLD Snooping Static Group Settings .....	80
MLD Router Port .....	81
MLD Snooping Group .....	82
MLD Snooping Forwarding Table .....	82
MLD Snooping Counter .....	83
MLD Host Table .....	84
Multicast VLAN .....	84
IGMP Multicast Group Profile Settings .....	84
IGMP Snooping Multicast VLAN Settings .....	85
Multicast Filtering .....	87
IPv4 Multicast Filtering .....	87
IPv4 Multicast Profile Settings .....	87
IPv4 Limited Multicast Range Settings .....	88
IPv4 Max Multicast Group Settings .....	89
Multicast Filtering Mode .....	89
Port Mirroring .....	90
Spanning Tree .....	91
STP Bridge Global Settings .....	93
STP Port Settings .....	94
MST Configuration Identification .....	96
STP Instance Settings .....	97
MSTP Port Information .....	97
Link Aggregation .....	98

Port Trunking.....	98
LACP Port Settings.....	101
Forwarding & Filtering .....	101
Unicast Forwarding.....	101
Multicast Forwarding.....	102
LLDP.....	103
LLDP .....	103
LLDP Global Settings.....	103
LLDP Port Settings.....	104
LLDP Management Address List .....	105
LLDP Basic TLVs Settings .....	105
LLDP Dot1 TLVs Settings .....	106
LLDP Dot3 TLVs Settings .....	107
LLDP Statistics System .....	108
LLDP Local Port Information.....	109
LLDP Remote Port Information .....	110
LLDP-MED .....	111
LLDP-MED System Settings.....	111
LLDP-MED Port Settings.....	111
LLDP-MED Local Port Information.....	112
LLDP-MED Remote Port Information .....	113
NLB FDB Settings .....	113
<b>L3 Features.....</b>	<b>115</b>
IPv4 Static/Default Route Settings.....	115
IPv4 Route Table .....	115
IPv6 Interface Settings .....	116
IPv6 Route Settings.....	117
IPv6 Neighbor Settings .....	117
<b>QoS .....</b>	<b>119</b>
Bandwidth Control.....	121
Queue Bandwidth Control Settings.....	122
Traffic Control .....	122
802.1p Default Priority.....	125
802.1p User Priority.....	125
QoS Scheduling Mechanism .....	126
<b>Security .....</b>	<b>127</b>
RADIUS.....	127
Authentication RADIUS Server Settings.....	127
RADIUS Accounting Settings .....	128
RADIUS Authentication.....	129
RADIUS Account Client.....	130
IP-MAC-Port Binding (IMPB).....	131
IMPB Global Settings .....	133
IMPB Port Settings .....	134

IMPB Entry Settings .....	135
MAC Block List .....	136
DHCP Snooping .....	137
DHCP Snooping Maximum Entry Settings .....	137
DHCP Snooping Entry .....	137
ND Snoop .....	138
ND Snoop Maximum Entry Settings .....	138
ND Snoop Entry .....	139
Port Security .....	139
Port Security Settings .....	139
Port Lock Entries .....	140
DHCP Server Screening .....	141
DHCP Screening Port Settings .....	141
DHCP Offer Filtering .....	142
802.1X (Port-based and Host-based Access Control) .....	143
Authentication Server .....	144
Authenticator .....	144
Client .....	145
Authentication Process .....	145
Understanding 802.1X Port-based and Host-based Network Access Control .....	146
802.1X Global Settings .....	148
802.1X Port Settings .....	149
802.1X User Settings .....	151
Guest VLAN Settings .....	151
Authenticator State .....	152
Authenticator Statistics .....	152
Authenticator Session Statistics .....	153
Authenticator Diagnostics .....	154
Initialize Port-based Port(s) .....	155
Initialize Host-based Port(s) .....	156
Reauthenticate Port-based Port(s) .....	156
Reauthenticate Host-based Port(s) .....	156
SSL .....	157
SSL Settings .....	157
SSL Certification Settings .....	159
SSH .....	159
SSH Settings .....	160
SSH Authentication Method and Algorithm Settings .....	161
SSH User Authentication List .....	162
Access Authentication Control .....	163
Enable Admin .....	164
Authentication Policy Settings .....	164
Application Authentication Settings .....	165
Authentication Server Group .....	165
Authentication Server Settings .....	167

Login Method Lists Settings .....	168
Enable Method Lists Settings.....	169
Local Enable Password Settings .....	170
<b>MAC-based Access Control (MAC) .....</b>	<b>170</b>
MAC-based Access Control Settings .....	171
MAC-based Access Control Local Settings .....	173
MAC-based Access Control Authentication State .....	173
<b>Web-based Access Control (WAC) .....</b>	<b>174</b>
WAC Global Settings.....	176
WAC User Settings.....	177
WAC Port Settings.....	178
WAC Authenticating State.....	179
WAC Customize Page .....	179
<b>Japanese Web-based Access Control (JWAC).....</b>	<b>180</b>
JWAC Global Settings .....	180
JWAC Port Settings .....	182
JWAC User Settings .....	183
JWAC Authentication State .....	184
JWAC Customize Page Language .....	185
JWAC Customize Page.....	185
<b>Compound Authentication .....</b>	<b>186</b>
Compound Authentication Settings .....	189
Compound Authentication Guest VLAN Settings .....	191
Compound Authentication MAC Format Settings .....	191
<b>IGMP Access Control Settings .....</b>	<b>192</b>
<b>ARP Spoofing Prevention Settings .....</b>	<b>193</b>
<b>BPDU Attack Protection .....</b>	<b>194</b>
<b>Loopback Detection Settings .....</b>	<b>195</b>
<b>Traffic Segmentation.....</b>	<b>196</b>
<b>Safeguard Engine Settings .....</b>	<b>197</b>
<b>Trusted Host Settings .....</b>	<b>198</b>
<b>ACL .....</b>	<b>200</b>
ACL Configuration Wizard.....	200
Access Profile List .....	201
CPU Access Profile List.....	215
Time Range Settings .....	228
<b>Network Application.....</b>	<b>230</b>
DHCP/BOOTP Relay.....	230
DHCP/BOOTP Relay Global Settings .....	230
DHCP/BOOTP Relay Interface Settings.....	233
DHCPv6 Relay.....	233
DHCPv6 Relay Global Settings .....	233
DHCPv6 Relay Settings.....	234
DHCP Server.....	234



DHCP Server Global Settings .....	235
DHCP Server Exclude Address Settings .....	235
DHCP Server Pool Settings .....	236
DHCP Server Manual Binding.....	237
DHCP Server Dynamic Binding .....	238
DHCP Conflict IP .....	238
DHCP Local Relay Settings.....	238
DHCP Auto Configuration Settings .....	239
DHCP Option 12 Settings .....	240
DNS Resolver .....	240
DNS Resolver Global Settings.....	240
DNS Resolver Static Name Server Settings .....	241
DNS Resolver Dynamic Name Server Table .....	241
DNS Resolver Static Host Name Settings.....	241
DNS Resolver Dynamic Host Name Table.....	242
PPPoE Circuit ID Insertions Settings.....	242
SMTP Settings .....	243
SNTP Settings.....	244
Time Settings .....	244
Time Zone Settings .....	244
Ping Test .....	246
<b>OAM.....</b>	<b>248</b>
Ethernet OAM.....	248
Ethernet OAM Settings.....	248
Ethernet OAM Configuration Settings.....	249
Ethernet OAM Event Log.....	250
Ethernet OAM Statistics .....	250
DULD Settings.....	251
Cable Diagnostics .....	252
<b>Monitoring.....</b>	<b>254</b>
Device Environment.....	254
CPU Utilization.....	254
DRAM & Flash Utilization.....	255
Port Utilization.....	256
Packet Size .....	256
Packets .....	258
Received (RX) .....	258
UMB_Cast (RX).....	260
Transmitted (TX) .....	261
Errors.....	263
Received (RX) .....	263
Transmitted (TX) .....	265
Browse ARP Table.....	266
Browse Router Port.....	266

Browse MLD Router Port .....	267
Browse Session Table .....	267
IGMP Snooping Group .....	268
MLD Snooping Group .....	268
MAC Address Table .....	269
System Log .....	270
<b>Save and Tools.....</b>	<b>271</b>
Save Configuration.....	272
Save Log .....	272
Save All.....	273
Download Configuration File/Download Configuration File to NV-RAM .....	273
Download Configuration File to SD Card.....	274
Download Firmware/Download Firmware to NV-RAM .....	274
Download Firmware to SD Card.....	274
Upload Configuration File/Upload Configuration File to TFTP.....	275
Upload Log File/Upload Log File to TFTP.....	275
Reset.....	276
Reboot System .....	276
<b>Appendix A – Mitigating ARP Spoofing Attacks Using Packet Content ACL.....</b>	<b>277</b>
<b>Appendix B – Password Recovery Procedure .....</b>	<b>284</b>
<b>Appendix C – System Log Entries.....</b>	<b>285</b>
<b>Appendix D – Trap Logs .....</b>	<b>304</b>

## Intended Readers

The **DGS-3200 Series Web UI Reference Guide** contains information for setup and management of the Switch. This manual is intended for network managers familiar with network management concepts and terminology.

## Typographical Conventions

Convention	Description
[ ]	In a command line, square brackets indicate an optional entry. For example: [copy filename] means that optionally you can type copy followed by the name of the file. Do not type the brackets.
<b>Bold font</b>	Indicates a button, a toolbar icon, menu, or menu item. For example: Open the <b>File</b> menu and choose <b>Cancel</b> . Used for emphasis. May also indicate system messages or prompts appearing on screen. For example: <b>You have mail</b> . <b>Bold</b> font is also used to represent filenames, program names and commands. For example: <b>use the copy command</b> .
<b>Boldface Typewriter Font</b>	Indicates commands and responses to prompts that must be typed exactly as printed in the manual.
Initial capital letter	Indicates a window name. Names of keys on the keyboard have initial capitals. For example: Click Enter.
<i>Italics</i>	Indicates a window name or a field. Also can indicate a variables or parameter that is replaced with an appropriate word or string. For example: type <i>filename</i> means that the actual filename should be typed instead of the word shown in italic.
<b>Menu Name &gt; Menu Option</b>	<b>Menu Name &gt; Menu Option</b> Indicates the menu structure. <b>Device &gt; Port &gt; Port Properties</b> means the Port Properties menu option under the Port menu option that is located under the Device menu.

## Notes, Notices, and Cautions



A **NOTE** indicates important information that helps make better use of the device.



A **NOTICE** indicates either potential damage to hardware or loss of data and tells how to avoid the problem.



A **CAUTION** indicates a potential for property damage, personal injury, or death.

## Safety Cautions

Use the following safety guidelines to ensure your own personal safety and to help protect your system from potential damage.

Throughout this safety section, the caution icon (  ) is used to indicate cautions and precautions that need to be reviewed and followed.

To reduce the risk of bodily injury, electrical shock, fire, and damage to the equipment observe the following precautions.

- Observe and follow service markings.
  - Do not service any product except as explained in the system documentation.
  - Opening or removing covers that are marked with the triangular symbol with a lightning bolt may expose the user to electrical shock.
  - Only a trained service technician should service components inside these compartments.
- If any of the following conditions occur, unplug the product from the electrical outlet and replace the part or contact your trained service provider:
  - Damage to the power cable, extension cable, or plug.
  - An object has fallen into the product.
  - The product has been exposed to water.
  - The product has been dropped or damaged.
  - The product does not operate correctly when the operating instructions are correctly followed.
- Keep your system away from radiators and heat sources. Also, do not block cooling vents.
- Do not spill food or liquids on system components, and never operate the product in a wet environment. If the system gets wet, see the appropriate section in the troubleshooting guide or contact your trained service provider.
- Do not push any objects into the openings of the system. Doing so can cause fire or electric shock by shorting out interior components.
- Use the product only with approved equipment.
- Allow the product to cool before removing covers or touching internal components.
- Operate the product only from the type of external power source indicated on the electrical ratings label. If unsure of the type of power source required, consult your service provider or local power company.
- To help avoid damaging the system, be sure the voltage selection switch (if provided) on the power supply is set to match the power available at the Switch's location:
  - 115 volts (V)/60 hertz (Hz) in most of North and South America and some Far Eastern countries such as South Korea and Taiwan
  - 100 V/50 Hz in eastern Japan and 100 V/60 Hz in western Japan
  - 230 V/50 Hz in most of Europe, the Middle East, and the Far East
- Also, be sure that attached devices are electrically rated to operate with the power available in your location.
- Use only approved power cable(s). If you have not been provided with a power cable for your system or for any AC-powered option intended for your system, purchase a power cable that is approved for use in your country. The power cable must be rated for the product and for the voltage and current marked on the product's electrical ratings label. The voltage and current rating of the cable should be greater than the ratings marked on the product.
- To help prevent electric shock, plug the system and peripheral power cables into properly grounded electrical outlets. These cables are equipped with three-prong plugs to help ensure proper grounding. Do not use adapter plugs or remove the grounding prong from a cable. If using an extension cable is necessary, use a 3-wire cable with properly grounded plugs.
- Observe extension cable and power strip ratings. Make sure that the total ampere rating of all products plugged into the extension cable or power strip does not exceed 80 percent of the ampere ratings limit for the extension cable or power strip.
- To help protect the system from sudden, transient increases and decreases in electrical power, use a surge suppressor, line conditioner, or uninterruptible power supply (UPS).
- Position system cables and power cables carefully; route cables so that they cannot be stepped on or tripped over. Be sure that nothing rests on any cables.

- Do not modify power cables or plugs. Consult a licensed electrician or your power company for site modifications. Always follow your local/national wiring rules.
- When connecting or disconnecting power to hot-pluggable power supplies, if offered with your system, observe the following guidelines:
  - Install the power supply before connecting the power cable to the power supply.
  - Unplug the power cable before removing the power supply.
  - If the system has multiple sources of power, disconnect power from the system by unplugging all power cables from the power supplies.
- Move products with care; ensure that all casters and/or stabilizers are firmly connected to the system. Avoid sudden stops and uneven surfaces.

## General Precautions for Rack-Mountable Products

Observe the following precautions for rack stability and safety. Also, refer to the rack installation documentation accompanying the system and the rack for specific caution statements and procedures.

- Systems are considered to be components in a rack. Thus, "component" refers to any system as well as to various peripherals or supporting hardware.



**CAUTION:** Installing systems in a rack without the front and side stabilizers installed could cause the rack to tip over, potentially resulting in bodily injury under certain circumstances. Therefore, always install the stabilizers before installing components in the rack. After installing system/components in a rack, never pull more than one component out of the rack on its slide assemblies at one time. The weight of more than one extended component could cause the rack to tip over and may result in serious injury.

- Before working on the rack, make sure that the stabilizers are secured to the rack, extended to the floor, and that the full weight of the rack rests on the floor. Install front and side stabilizers on a single rack or front stabilizers for joined multiple racks before working on the rack.
- Always load the rack from the bottom up, and load the heaviest item in the rack first.
- Make sure that the rack is level and stable before extending a component from the rack.
- Use caution when pressing the component rail release latches and sliding a component into or out of a rack; the slide rails can pinch your fingers.
- After a component is inserted into the rack, carefully extend the rail into a locking position, and then slide the component into the rack.
- Do not overload the AC supply branch circuit that provides power to the rack. The total rack load should not exceed 80 percent of the branch circuit rating.
- Ensure that proper airflow is provided to components in the rack.
- Do not step on or stand on any component when servicing other components in a rack.



**NOTE:** A qualified electrician must perform all connections to DC power and to safety grounds. All electrical wiring must comply with applicable local or national codes and practices.



**CAUTION:** Never defeat the ground conductor or operate the equipment in the absence of a suitably installed ground conductor. Contact the appropriate electrical inspection authority or an electrician if uncertain that suitable grounding is available.



**CAUTION:** The system chassis must be positively grounded to the rack cabinet frame. Do not attempt to connect power to the system until grounding cables are connected. Completed power and safety ground wiring must be inspected by a qualified electrical inspector. An energy hazard will exist if the safety ground cable is omitted or disconnected.



**CAUTION:** When mounting the Switch on a cement wall, a proper concrete sleeve anchor should be used, such as the one that is included in the optional D-Link Wall Mount kit (DRE-KIT018).

## Lithium Battery Precaution



**CAUTION:** Incorrectly replacing the lithium battery of the Switch may cause the battery to explode. Replace this battery only with the same or equivalent type recommended by the manufacturer. Discard used batteries according to the manufacturer's instructions.

## Protecting Against Electrostatic Discharge

Static electricity can harm delicate components inside the system. To prevent static damage, discharge static electricity from your body before touching any of the electronic components, such as the microprocessor. This can be done by periodically touching an unpainted metal surface on the chassis.

The following steps can also be taken prevent damage from electrostatic discharge (ESD):

1. When unpacking a static-sensitive component from its shipping carton, do not remove the component from the antistatic packing material until ready to install the component in the system. Just before unwrapping the antistatic packaging, be sure to discharge static electricity from your body.
2. When transporting a sensitive component, first place it in an antistatic container or packaging.
3. Handle all sensitive components in a static-safe area. If possible, use antistatic floor pads, workbench pads and an antistatic grounding strap.

# Web-based Switch Configuration

## Introduction

### Logging onto the Web Manager

#### Web-Based User Interface

## Introduction

All software functions of the Switch can be managed, configured, and monitored via the embedded web-based (HTML) interface. Manage the Switch from remote stations anywhere on the network through a standard browser, such as Internet Explorer 5.5 or later, Netscape 8.0 or later, Firefox 2.0 or later, or Apple Safari 3.0. The browser acts as a universal access tool and can communicate directly with the Switch using the HTTP protocol.

The Web-based management module and the Console program (and Telnet) are different ways to access the same internal switching software and configure it. Thus, all settings encountered in web-based management are the same as those found in the console program.

## Logging onto the Web Manager

To begin managing the Switch, simply run the browser installed on your computer and point it to the IP address you have defined for the device. The URL in the address bar should read something like: `http://123.123.123.123`, where the numbers 123 represent the IP address of the Switch.



**NOTE:** The factory default IP address is 10.90.90.90.

This opens the management module's user authentication window, as seen below.



**Figure 1 - 1. Enter Network Password window**

Leave both the **User Name** field and the **Password** field blank and click **OK**. This will open the Web-based user interface. The Switch management features available in the web-based manager are explained below.

## Web-based User Interface

The user interface provides access to various Switch configuration and management windows, allows the user to view performance statistics, and permits graphical monitoring of the system status.

### Areas of the User Interface

The figure below shows the user interface. Three distinct areas divide the user interface, as described in the table.

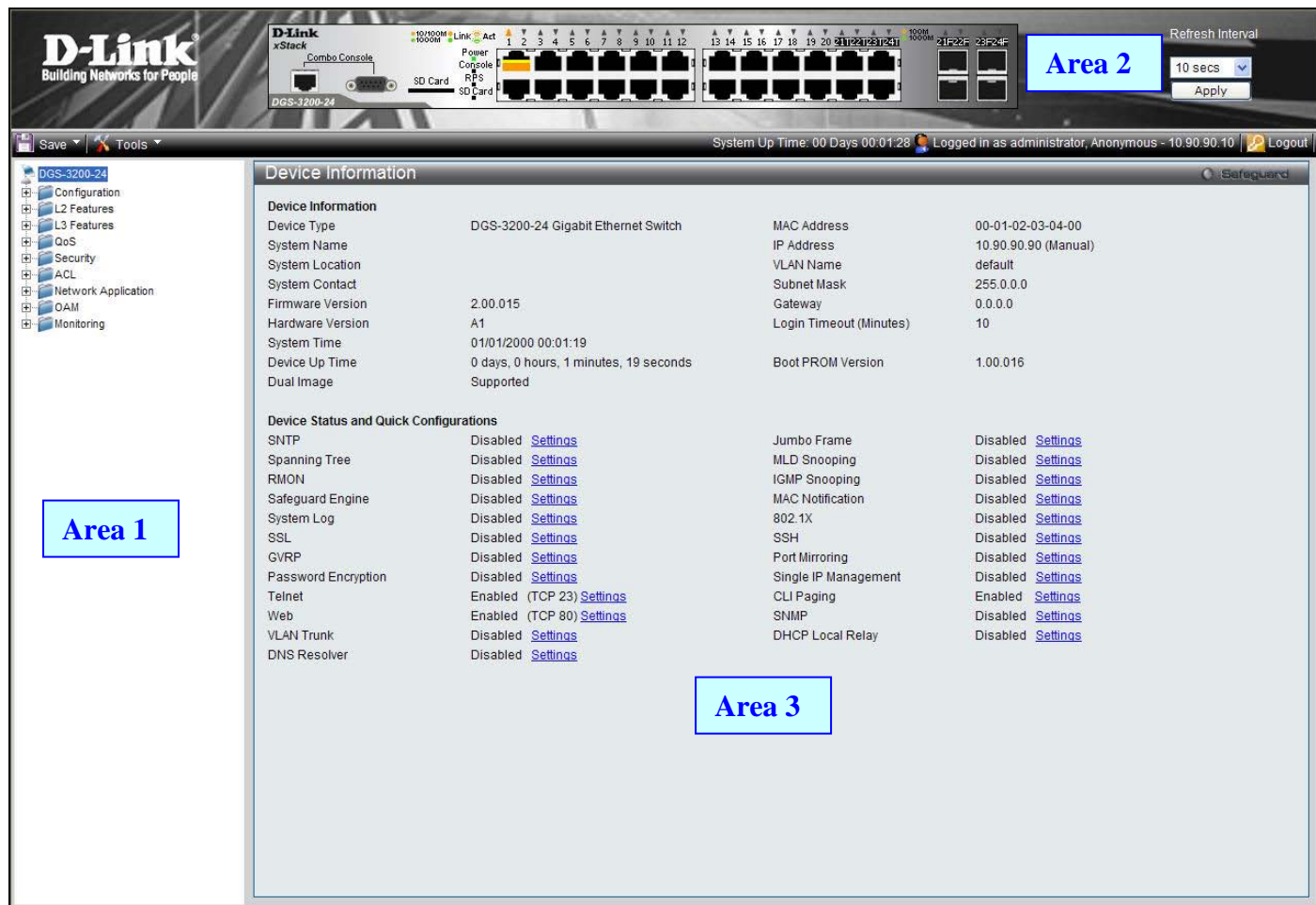

Figure 1 - 2. Main Web-Manager window

Area	Function
Area 1	Select the folder or window to display. Open folders and click the hyperlinked window buttons and subfolders contained within them to display windows.
Area 2	Presents a graphical near real-time image of the front panel of the Switch. This area displays the Switch's ports and expansion modules and shows port activity, depending on the specified mode. Some management functions, including port monitoring are accessible here. Click the D-Link logo to go to the D-Link website.
Area 3	Presents Switch status based on user selection and the entry of configuration data. In addition, hyperlinks are offered for many Switch features to enable quick configuration.



## Web Pages

When connecting to the management mode of the Switch with a web browser, a login screen is displayed. Enter a user name and password to access the Switch's management mode.

Below is a list of the main folders available in the Web interface:

**Configuration** - In this section the user will be able to configure features regarding the Switch's configuration.

**L2 Features** - In this section the user will be able to configure features regarding the Layer 2 functionality of the Switch.

**L3 Features** - In this section the user will be able to configure features regarding the Layer 3 functionality of the Switch.

**QoS** - In this section the user will be able to configure features regarding the Quality of Service functionality of the Switch.

**Security** - In this section the user will be able to configure features regarding the Switch's security.

**ACL** - In this section the user will be able to configure features regarding the Access Control List functionality of the Switch.

**Network Application** - In this section the user will be able to configure features regarding network applications handled by the Switch.

**OAM** - In this section the user will be able to configure features regarding the Switch's operations, administration and maintenance (OAM).

**Monitoring** - In this section the user will be able to monitor the Switch's configuration and statistics.



**NOTE:** Be sure to configure the user name and password in the **User Accounts** window before connecting the Switch to the greater network.

# Configuration

*Device Information*

*System Information*

*Serial Port Settings*

*IP Address*

*Port Configuration*

*Static ARP Settings*

*Gratuitous ARP*

*User Accounts*

*System Log Configuration*

*System Severity Settings*

*MAC Address Aging Time*

*Web Settings*

*Telnet Settings*

*Password Encryption*

*CLI Paging Settings*

*Firmware Information*

*Power Saving*

*MAC Notification Settings*

*SNMP Settings*

*CPU Filter L3 Control Packet Settings*

*Single IP Management*

*SD Card FS Settings (DGS-3200-24 only)*

*SD Card Management (DGS-3200-24 only)*

## Device Information

This window contains the main settings for all major functions for the Switch. It appears automatically when you log on to the Switch. To return to the **Device Information** window after viewing other windows, click the **DGS-3200-10/DGS-3200-16/DGS-3200-24** folder. The **Device Information** window shows the Switch's MAC Address (assigned by the factory and unchangeable), the Boot PROM Version, Firmware Version, Hardware Version, and many other important types of information. This is helpful to keep track of PROM and firmware updates and to obtain the Switch's MAC address for entry into another network device's address table, if necessary. In addition, this window displays the status of functions on the Switch to quickly assess their current global status. Many functions are hyper-linked for easy access to enable quick configuration from this window.

The screenshot shows the 'Device Information' window with a 'Safeguard' icon in the top right. The window is divided into two main sections. The first section, 'Device Information', lists various system parameters in a table format. The second section, 'Device Status and Quick Configurations', lists various network features with their current status and a link to their settings.

Device Information			
Device Type	DGS-3200-24 Gigabit Ethernet Switch	MAC Address	00-01-02-03-04-00
System Name		IP Address	10.90.90.90 (Manual)
System Location		VLAN Name	default
System Contact		Subnet Mask	255.0.0.0
Firmware Version	2.00.015	Gateway	0.0.0.0
Hardware Version	A1	Login Timeout (Minutes)	10
System Time	01/01/2000 00:01:19	Boot PROM Version	1.00.016
Device Up Time	0 days, 0 hours, 1 minutes, 19 seconds		
Dual Image	Supported		

Device Status and Quick Configurations			
SNTP	Disabled	Jumbo Frame	Disabled
Spanning Tree	Disabled	MLD Snooping	Disabled
RMON	Disabled	IGMP Snooping	Disabled
Safeguard Engine	Disabled	MAC Notification	Disabled
System Log	Disabled	802.1X	Disabled
SSL	Disabled	SSH	Disabled
GVRP	Disabled	Port Mirroring	Disabled
Password Encryption	Disabled	Single IP Management	Disabled
Telnet	Enabled (TCP 23)	CLI Paging	Enabled
Web	Enabled (TCP 80)	SNMP	Disabled
VLAN Trunk	Disabled	DHCP Local Relay	Disabled
DNS Resolver	Disabled		

Figure 2 - 1. Device Information window

## System Information

The user can enter a System Name, System Location, and System Contact to aid in defining the Switch.

To view the following window, click **Configuration > System Information**:

The screenshot shows the 'System Information Settings' window with a 'Safeguard' icon in the top right. The window displays the same device information as Figure 2-1. Below this information, there are three input fields for 'System Name', 'System Location', and 'System Contact'. An 'Apply' button is located in the bottom right corner.

Figure 2 - 2. System Information window

The fields that can be configured are described below:

Parameter	Description
<b>System Name</b>	Enter a system name for the Switch, if desired. This name will identify it in the Switch network.
<b>System Location</b>	Enter the location of the Switch, if so desired.
<b>System Contact</b>	Enter a contact name for the Switch, if so desired.

Click **Apply** to implement changes made.

## Serial Port Settings

The user can adjust the Baud Rate and the Auto Logout values.

To view the following window, click **Configuration > Serial Port Settings**:



**Figure 2 - 3. Serial Port Settings window**

The fields that can be configured are described below:

Parameter	Description
<b>Baud Rate</b>	This field specifies the baud rate for the serial port on the Switch. There are four possible baud rates to choose from, <i>9600</i> , <i>19200</i> , <i>38400</i> and <i>115200</i> . For a connection to the Switch using the CLI interface, the baud rate must be set to <i>115200</i> , which is the default setting.
<b>Auto Logout</b>	Select the logout time used for the console interface. This automatically logs the user out after an idle period of time, as defined. Choose from the following options: <i>2 mins</i> , <i>5 mins</i> , <i>10 mins</i> , <i>15 mins</i> or <i>Never</i> . The default setting is <i>10 mins</i> .

Click **Apply** to implement changes made.

## IP Address

The IP address may initially be set using the console interface prior to connecting to it through the Ethernet. If the Switch IP address has not yet been changed, read the introduction of the *DGS-3200 Series CLI Manual* for more information. The Web manager will display the Switch's current IP settings.

To view the following window, click **Configuration > IP Address**:

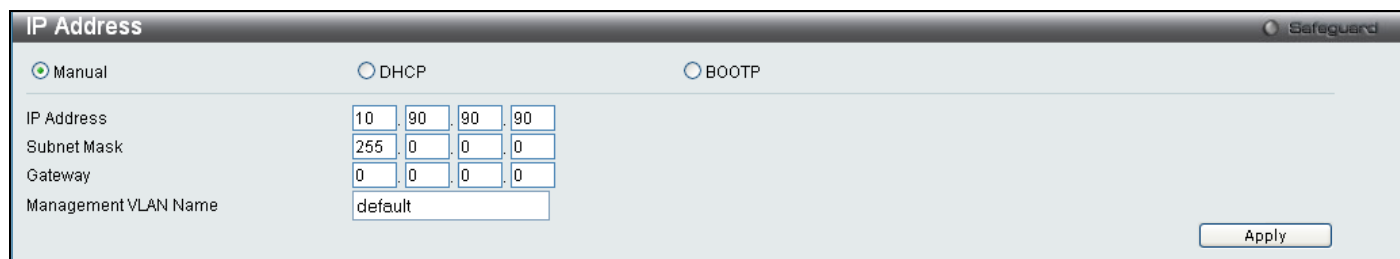

**Figure 2 - 4. IP Address window**

To manually assign the Switch's IP address, subnet mask, and default gateway address:

1. Click the Manual radio button at the top of the window.
2. Enter the appropriate IP Address and Subnet Mask.
3. If accessing the Switch from a different subnet from the one it is installed on, enter the IP address of the default Gateway. If managing the Switch from the subnet on which it is installed, the user may leave the default address (0.0.0.0) in this field.

- If the Switch has no previously configured VLANs, the user can use the Management VLAN Name entitled “default”. This default Management VLAN contains all of the Switch ports as members. If the Switch has previously configured VLANs, the user will need to enter the VLAN ID of the VLAN that contains the port connected to the management station that will access the Switch. The Switch will allow management access from stations with the same VID listed here.



**NOTE:** The Switch's factory default IP address is 10.90.90.90 with a subnet mask of 255.0.0.0 and a default gateway of 0.0.0.0.

To use the DHCP or BOOTP protocols to assign the Switch an IP address, subnet mask, and default gateway address:

Use the radio button at the top of the window to choose either DHCP or BOOTP. This selects the method the Switch assigns an IP address on the next reboot.

The following parameters may be configured or viewed:

Parameter	Description
<b>Manual</b>	Allows the entry of an IP address, subnet mask, and a default gateway for the Switch. These fields should be of the form xxx.xxx.xxx.xxx, where each xxx is a number (represented in decimal form) between 0 and 255. This address should be a unique address on the network assigned for use by the network administrator.
<b>DHCP</b>	The Switch will send out a DHCP broadcast request when it is powered up. The DHCP protocol allows IP addresses, network masks, and default gateways to be assigned by a DHCP server. If this option is set, the Switch will first look for a DHCP server to provide it with this information before using the default or previously entered settings.
<b>BOOTP</b>	The Switch will send out a BOOTP broadcast request when it is powered up. The BOOTP protocol allows IP addresses, network masks, and default gateways to be assigned by a central BOOTP server. If this option is set, the Switch will first look for a BOOTP server to provide it with this information before using the default or previously entered settings.
<b>Subnet Mask</b>	A Bitmask that determines the extent of the subnet that the Switch is on. Should be of the form xxx.xxx.xxx.xxx, where each xxx is a number (represented in decimal) between 0 and 255. The value should be 255.0.0.0 for a Class A network, 255.255.0.0 for a Class B network, and 255.255.255.0 for a Class C network, but custom subnet masks are allowed.
<b>Gateway</b>	IP address that determines where packets with a destination address outside the current subnet should be sent. This is usually the address of a router or a host acting as an IP gateway. If your network is not part of an intranet, or you do not want the Switch to be accessible outside your local network, you can leave this field unchanged.
<b>Management VLAN Name</b>	This allows the entry of a VLAN name from which a management station will be allowed to manage the Switch using TCP/IP (in-band via Web manager or Telnet). Management stations that are on VLANs other than the one entered here will not be able to manage the Switch in-band unless their IP addresses are entered in the <b>Trusted Host</b> window ( <b>Security &gt; Trusted Host</b> ). If VLANs have not yet been configured for the Switch, the default VLAN contains all of the Switch's ports. There are no entries in the Trusted Host table, by default, so any management station that can connect to the Switch can access the Switch until a management VLAN is specified or Management Station IP addresses are assigned.

Click **Apply** to implement changes made.

## Setting the Switch's IP Address using the Console Interface

Each Switch must be assigned its own IP Address, which is used for communication with an SNMP network manager or other TCP/IP application (for example BOOTP, TFTP). The Switch's default IP address is 10.90.90.90. The default Switch IP address can be changed to meet the specification of your networking address scheme.

The IP address for the Switch must be set before the Web-based manager can manage the switch. The Switch IP address can be automatically set using BOOTP or DHCP protocols, in which case the actual address assigned to the Switch must be known. The IP address may be set using the Command Line Interface (CLI) over the console serial port as follows:

- Starting at the command line prompt, enter the commands **config ipif System ipaddress xxx.xxx.xxx.xxx/yyy.yyy.yyy.yyy**. Where the x's represent the IP address to be assigned to the IP interface named System and the y's represent the corresponding subnet mask.
- Alternatively, the user can enter **config ipif System ipaddress xxx.xxx.xxx.xxx/z**. Where the x's represent the IP address to be assigned to the IP interface named System and the z represents the corresponding number of subnets in CIDR notation.

The IP interface named System on the Switch can be assigned an IP address and subnet mask, which can then be used to connect a management station to the Switch's Telnet or Web-based management agent.

Successful entry of the command will produce a "Success" message, indicating that the command execution was correctly. The user may now utilize this address to configure or manage the Switch through Telnet, the Command Line Interface (CLI) or the Web-based management (GUI).

## Port Configuration

### Port Auto Negotiation Information

The following window displays the detailed auto negotiation information.

To view the following window, click **Configuration > Port Configuration > Port Auto Negotiation Information**:

Port	AN	RS	CS	CB	CAB	CRB	RFA	RFR
01	Enabled		Complete	10M_Half,1...	10M_Half,1...	10M_Half,1...		
02	Enabled		Configurin...	10M_Half,1...	10M_Half,1...			
03	Enabled		Configurin...	10M_Half,1...	10M_Half,1...			
04	Enabled		Configurin...	10M_Half,1...	10M_Half,1...			
05	Enabled		Configurin...	10M_Half,1...	10M_Half,1...			
06	Enabled		Configurin...	10M_Half,1...	10M_Half,1...			
07	Enabled		Configurin...	10M_Half,1...	10M_Half,1...			
08	Enabled		Configurin...	10M_Half,1...	10M_Half,1...			
09	Enabled		Configurin...	10M_Half,1...	10M_Half,1...			
10	Enabled		Configurin...	10M_Half,1...	10M_Half,1...			
11	Enabled		Configurin...	10M_Half,1...	10M_Half,1...			
12	Enabled		Configurin...	10M_Half,1...	10M_Half,1...			
13	Enabled		Configurin...	10M_Half,1...	10M_Half,1...			
14	Enabled		Configurin...	10M_Half,1...	10M_Half,1...			
15	Enabled		Configurin...	10M_Half,1...	10M_Half,1...			
16	Enabled		Configurin...	10M_Half,1...	10M_Half,1...			
17	Enabled		Configurin...	10M_Half,1...	10M_Half,1...			
18	Enabled		Configurin...	10M_Half,1...	10M_Half,1...			
19	Enabled		Configurin...	10M_Half,1...	10M_Half,1...			
20	Enabled		Configurin...	10M_Half,1...	10M_Half,1...			
21 (C)	Enabled		Configurin...	10M_Half,1...	10M_Half,1...			
21 (F)	Enabled		Configurin...	1000M_Full	1000M_Full		NoError	NoError
22 (C)	Enabled		Configurin...	10M_Half,1...	10M_Half,1...			
22 (F)	Enabled		Configurin...	1000M_Full	1000M_Full		NoError	NoError
23 (C)	Enabled		Configurin...	10M_Half,1...	10M_Half,1...			
23 (F)	Enabled		Configurin...	1000M_Full	1000M_Full		NoError	NoError
24 (C)	Enabled		Configurin...	10M_Half,1...	10M_Half,1...			
24 (F)	Enabled		Configurin...	1000M_Full	1000M_Full		NoError	NoError

**Note:** AN means Auto Negotiation; RS means Remote Signaling; CS means Config Status; CB means Capability Bits; CAB means Capability Advertised Bits; CRB means Capability Received Bits; RFA means Remote Fault Advertised; RFR means Remote Fault Received

Figure 2 - 5. Port Auto Negotiation Information window

## Port Detail Information

This window displays the detail information of ports.

To view the following window, click **Configuration > Port Configuration > Port Detail Information**:

Port Detail Information										
Port	HT	MA	BW	DM	LCOC	BPDUFM	QS	MT		
1	Gigabits E...	00-01-02-0...	100000Kbit	Full Duple...	2 hours 54...	Enabled	FIFO	1000Base-T	<a href="#">TX</a>	<a href="#">RX</a>
2	Gigabits E...	00-01-02-0...	1000000Kbi...	Full Duple...	2 hours 54...	Enabled	FIFO	1000Base-T	<a href="#">TX</a>	<a href="#">RX</a>
3	Gigabits E...	00-01-02-0...	1000000Kbi...	Full Duple...	2 hours 54...	Enabled	FIFO	1000Base-T	<a href="#">TX</a>	<a href="#">RX</a>
4	Gigabits E...	00-01-02-0...	1000000Kbi...	Full Duple...	2 hours 54...	Enabled	FIFO	1000Base-T	<a href="#">TX</a>	<a href="#">RX</a>
5	Gigabits E...	00-01-02-0...	1000000Kbi...	Full Duple...	2 hours 54...	Enabled	FIFO	1000Base-T	<a href="#">TX</a>	<a href="#">RX</a>
6	Gigabits E...	00-01-02-0...	1000000Kbi...	Full Duple...	2 hours 54...	Enabled	FIFO	1000Base-T	<a href="#">TX</a>	<a href="#">RX</a>
7	Gigabits E...	00-01-02-0...	1000000Kbi...	Full Duple...	2 hours 54...	Enabled	FIFO	1000Base-T	<a href="#">TX</a>	<a href="#">RX</a>
8	Gigabits E...	00-01-02-0...	1000000Kbi...	Full Duple...	2 hours 54...	Enabled	FIFO	1000Base-T	<a href="#">TX</a>	<a href="#">RX</a>
9	Gigabits E...	00-01-02-0...	1000000Kbi...	Full Duple...	2 hours 54...	Enabled	FIFO	1000Base-T	<a href="#">TX</a>	<a href="#">RX</a>
10	Gigabits E...	00-01-02-0...	1000000Kbi...	Full Duple...	2 hours 54...	Enabled	FIFO	1000Base-T	<a href="#">TX</a>	<a href="#">RX</a>
11	Gigabits E...	00-01-02-0...	1000000Kbi...	Full Duple...	2 hours 54...	Enabled	FIFO	1000Base-T	<a href="#">TX</a>	<a href="#">RX</a>
12	Gigabits E...	00-01-02-0...	1000000Kbi...	Full Duple...	2 hours 54...	Enabled	FIFO	1000Base-T	<a href="#">TX</a>	<a href="#">RX</a>
13	Gigabits E...	00-01-02-0...	1000000Kbi...	Full Duple...	2 hours 54...	Enabled	FIFO	1000Base-T	<a href="#">TX</a>	<a href="#">RX</a>
14	Gigabits E...	00-01-02-0...	1000000Kbi...	Full Duple...	2 hours 54...	Enabled	FIFO	1000Base-T	<a href="#">TX</a>	<a href="#">RX</a>
15	Gigabits E...	00-01-02-0...	1000000Kbi...	Full Duple...	2 hours 54...	Enabled	FIFO	1000Base-T	<a href="#">TX</a>	<a href="#">RX</a>
16	Gigabits E...	00-01-02-0...	1000000Kbi...	Full Duple...	2 hours 54...	Enabled	FIFO	1000Base-T	<a href="#">TX</a>	<a href="#">RX</a>
17	Gigabits E...	00-01-02-0...	1000000Kbi...	Full Duple...	2 hours 54...	Enabled	FIFO	1000Base-T	<a href="#">TX</a>	<a href="#">RX</a>
18	Gigabits E...	00-01-02-0...	1000000Kbi...	Full Duple...	2 hours 54...	Enabled	FIFO	1000Base-T	<a href="#">TX</a>	<a href="#">RX</a>
19	Gigabits E...	00-01-02-0...	1000000Kbi...	Full Duple...	2 hours 54...	Enabled	FIFO	1000Base-T	<a href="#">TX</a>	<a href="#">RX</a>
20	Gigabits E...	00-01-02-0...	1000000Kbi...	Full Duple...	2 hours 54...	Enabled	FIFO	1000Base-T	<a href="#">TX</a>	<a href="#">RX</a>
21	Gigabits E...	00-01-02-0...	1000000Kbi...	Full Duple...	2 hours 54...	Enabled	FIFO	1000Base-X	<a href="#">TX</a>	<a href="#">RX</a>
22	Gigabits E...	00-01-02-0...	1000000Kbi...	Full Duple...	2 hours 54...	Enabled	FIFO	1000Base-X	<a href="#">TX</a>	<a href="#">RX</a>
23	Gigabits E...	00-01-02-0...	1000000Kbi...	Full Duple...	2 hours 54...	Enabled	FIFO	1000Base-X	<a href="#">TX</a>	<a href="#">RX</a>
24	Gigabits E...	00-01-02-0...	1000000Kbi...	Full Duple...	2 hours 54...	Enabled	FIFO	1000Base-X	<a href="#">TX</a>	<a href="#">RX</a>

**Note:** HT means Hardware Type; MA means MAC Addressg; BW means Bandwidth; DM means Duplex Mode; LCOC means Last Clear Of Counter; BPDUFM means BPDU Filtering Mode; QS means Queuing Strategy; MT means Media Type

Figure 2 - 6. Port Detail Information window

Click the **Refresh** button to update the information.

## Port Settings

This windows is used to configure and display the switch ports settings.

To view the following window, click **Configuration > Port Configuration > Port Settings:**

Port	State	Speed/Duplex	Flow Control	Connection	Address Learning
01	Enabled	Auto	Disabled	100M/Full/None	Enabled
02	Enabled	Auto	Disabled	Link Down	Enabled
03	Enabled	Auto	Disabled	Link Down	Enabled
04	Enabled	Auto	Disabled	Link Down	Enabled
05	Enabled	Auto	Disabled	Link Down	Enabled
06	Enabled	Auto	Disabled	Link Down	Enabled
07	Enabled	Auto	Disabled	Link Down	Enabled
08	Enabled	Auto	Disabled	Link Down	Enabled
09	Enabled	Auto	Disabled	Link Down	Enabled
10	Enabled	Auto	Disabled	Link Down	Enabled
11	Enabled	Auto	Disabled	Link Down	Enabled
12	Enabled	Auto	Disabled	Link Down	Enabled
13	Enabled	Auto	Disabled	Link Down	Enabled
14	Enabled	Auto	Disabled	Link Down	Enabled
15	Enabled	Auto	Disabled	Link Down	Enabled
16	Enabled	Auto	Disabled	Link Down	Enabled
17	Enabled	Auto	Disabled	Link Down	Enabled
18	Enabled	Auto	Disabled	Link Down	Enabled
19	Enabled	Auto	Disabled	Link Down	Enabled
20	Enabled	Auto	Disabled	Link Down	Enabled
21 (C)	Enabled	Auto	Disabled	Link Down	Enabled
21 (F)	Enabled	Auto	Disabled	Link Down	Enabled
22 (C)	Enabled	Auto	Disabled	Link Down	Enabled
22 (F)	Enabled	Auto	Disabled	Link Down	Enabled
23 (C)	Enabled	Auto	Disabled	Link Down	Enabled
23 (F)	Enabled	Auto	Disabled	Link Down	Enabled

Note: ANE means Auto Negotiation Error.

Figure 2 - 7. Port Settings window

The following parameters may be configured or viewed:

Parameter	Description
<b>From Port / To Port</b>	Use the drop-down menus to select the ports to be configured.
<b>State</b>	Use the drop-down menu to enable or disable a given port or group of ports.
<b>Speed/Duplex</b>	<p>Toggle the Speed/Duplex field to either select the speed and duplex/half-duplex state of the port. <i>Auto</i> denotes auto-negotiation between 10 and 100 Mbps devices, in full- or half-duplex. The <i>Auto</i> setting allows the port to automatically determine the fastest settings the device the port is connected to can handle, and then to use those settings. The other options are <i>10M Half</i>, <i>10M Full</i>, <i>100M Half</i>, <i>100M Full</i>, <i>1000M Full_Master</i>, <i>1000M Full_Slave</i>, and <i>1000M Full</i>. There is no automatic adjustment of port settings with any option other than <i>Auto</i>.</p> <p>The Switch allows the user to configure three types of gigabit connections; <i>1000M Full_Master</i>, <i>1000M Full_Slave</i>, and <i>1000M Full</i>. Gigabit connections only support full duplex connections and take on certain characteristics that are different from the other choices listed.</p> <p>The <i>1000M Full_Master</i> and <i>1000M Full_Slave</i> parameters refer to connections running a 100BASE-T cable for connection between the Switch port and other device capable of a gigabit connection. The master setting (<i>1000M Full_Master</i>) will allow the port to advertise capabilities related to duplex, speed and physical layer type. The master setting will also determine the master and slave relationship between the two connected physical layers. This relationship is necessary for establishing the timing control between the two physical layers. The timing control is set on a master physical layer by a local source. The slave setting (<i>1000M Full_Slave</i>) uses loop timing, where the timing comes from a data stream received from the master. If one connection is set for <i>1000M Full_Master</i>, the other side of the connection must be set for <i>1000M Full_Slave</i>. Any other configuration will result in a link down status for both ports.</p>



<b>Flow Control</b>	Displays the flow control scheme used for the various port configurations. Ports configured for full-duplex use 802.3x flow control, half-duplex ports use backpressure flow config, and Auto ports use an automatic selection of the two. The default is <i>Disabled</i> .
<b>Address Learning</b>	Enable or disable MAC address learning for the selected ports. When <i>Enabled</i> , destination and source MAC addresses are automatically listed in the forwarding table. When address learning is <i>Disabled</i> , MAC addresses must be manually entered into the forwarding table. This is sometimes done for reasons of security or efficiency. See the section on Forwarding/Filtering for information on entering MAC addresses into the forwarding table. The default setting is <i>Enabled</i> .
<b>Medium Type</b>	If configuring the Combo ports, this defines the type of transport medium to be used, whether <i>Copper</i> or <i>Fiber</i> .
<b>Auto Negotiation</b>	Use the drop-down menu to specify the auto-negotiation configuration. <i>Restart An</i> – Select to restart the auto-negotiation process <i>Remote Fault Advertisedt</i> - The remote fault advertisement option will be configured.

Click **Apply** to implement the new settings on the Switch.

Click the **Refresh** button to refresh the display section of this page.

## Port Description Settings

The Switch supports a port description feature where the user may name various ports.

To view the following window, click **Configuration > Port Configuration > Port Description**:

**Figure 2 - 8. Port Description window**

Use the From Port and To Port drop-down menu to choose a port or range of ports to describe. Users may then enter a description for the chosen port(s). If configuring the Combo ports, the Medium Type defines the type of transport medium to be used, whether *Copper* or *Fiber*.

Click **Apply** to set the descriptions in the **Port Description** window.

## Port Error Disabled

The following window will display the information about ports that have had their connection status disabled, for reasons such as storm control or link down status.

To view the following window, click **Configuration > Port Configuration > Port Error Disabled**:

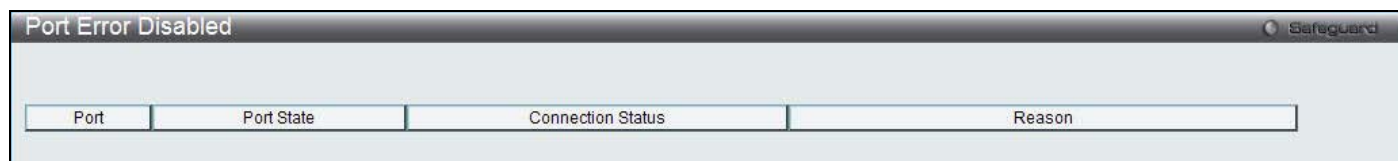

Figure 2 - 9. Port Error Disabled window

The following parameters are displayed:

Parameter	Description
<b>Port</b>	Displays the port that has been error disabled.
<b>Port State</b>	Describes the current running state of the port, whether enabled or disabled.
<b>Connection Status</b>	This field will read the uplink status of the individual ports, whether enabled or disabled.
<b>Reason</b>	Describes the reason why the port has been error-disabled, such as it has become a shutdown port for storm control.

## Jumbo Frame Settings

The Switch supports jumbo frames. Jumbo frames are Ethernet frames with more than 1,500 bytes of payload. The Switch supports jumbo frames with a maximum frame size of 10240 bytes.

To view the following window, click **Configuration > Port Configuration > Jumbo Frame Settings**:

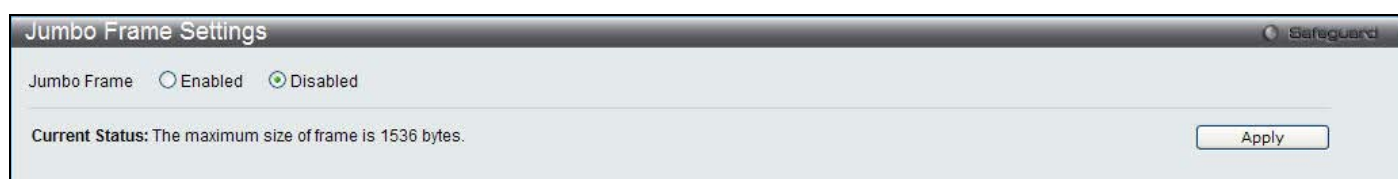

Figure 2 - 10. Jumbo Frame window

The following parameter can be configured:

Parameter	Description
<b>Jumbo Frame</b>	This field will enable or disable the Jumbo Frame function on the Switch. The default is Disabled. The maximum frame size is 10240 bytes.

To enable or disable Jumbo Frame, use the radio button and click **Apply**.

## Static ARP Settings

The Address Resolution Protocol is a TCP/IP protocol that converts IP addresses into physical addresses. This table allows network managers to view, define, modify, and delete ARP information for specific devices.

Static entries can be defined in the ARP table. When static entries are defined, a permanent entry is entered and is used to translate IP addresses to MAC addresses.

To view the following window, click **Configuration > Static ARP Settings**:

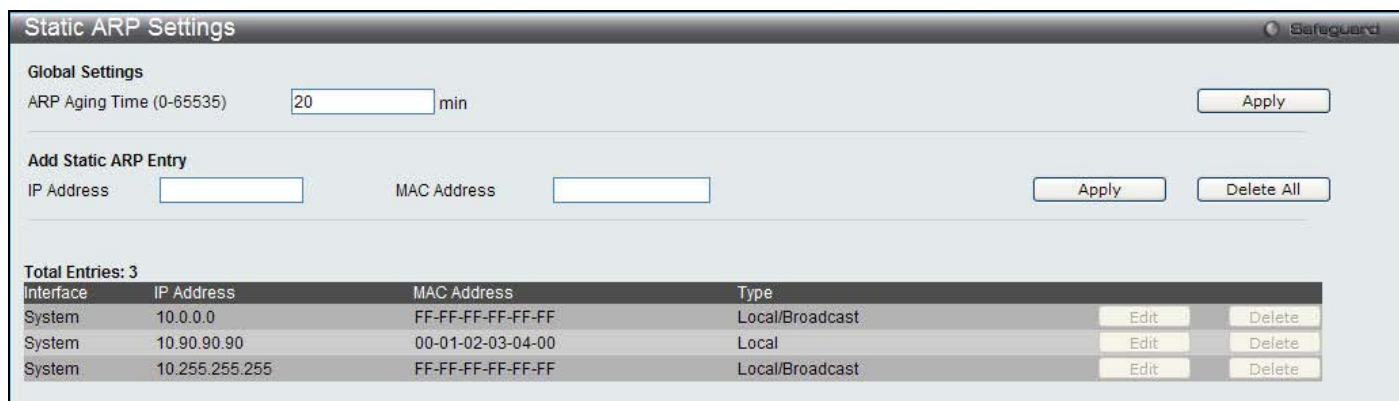

Figure 2 - 11. Static ARP Settings window

The following parameters may be configured or viewed:

Parameter	Description
<b>ARP Aging Time (0-65535)</b>	The ARP entry age-out time, in seconds. The default is 20 minutes.
<b>IP Address</b>	The IP address of the ARP entry.
<b>MAC Address</b>	The MAC address of the ARP entry.

After entering a global ARP Aging Time in seconds, click **Apply** to allow it to take effect. The default value is 20 seconds.

After entering the IP Address and MAC Address of the Static ARP entry, click **Apply** to implement the new entry. To completely clear the static ARP entries, click the **Delete All** button.

To modify a static ARP entry, click the **Edit** button located on the right side of the entry in the ARP table at the bottom of the window.

To delete a static ARP entry, click the **Delete** button located on the right side of the entry in the static ARP table at the bottom of the window.

## Gratuitous ARP

### Gratuitous ARP Global Settings

The window is used to enable or disable the gratuitous ARP global settings.

To view the following window, click **Configuration > Gratuitous ARP > Gratuitous ARP Global Settings**:

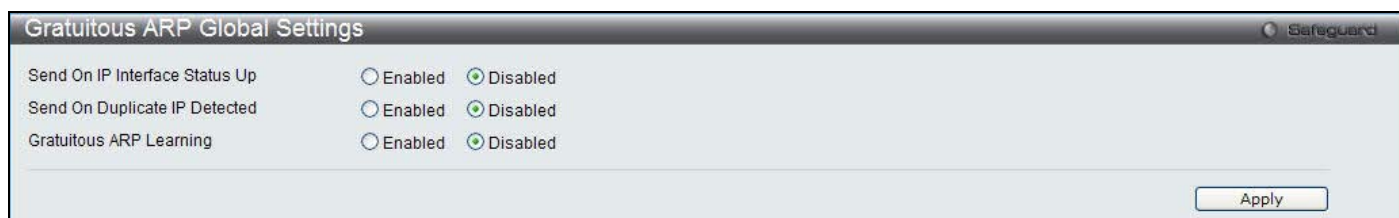

Figure 2 - 12. Gratuitous ARP Global Settings window

Click the **Apply** button to accept the changes made.

### Gratuitous ARP Settings

The user can configure the IP interface's gratuitous ARP parameter.

To view the following window, click **Configuration > Gratuitous ARP > Gratuitous ARP Settings**:

Figure 2 - 13. Gratuitous ARP Settings window

The fields that can be configured are described below:

Parameter	Description
<b>Trap</b>	Use the drop-down menu to enable or disable the trap option. By default the trap is disabled.
<b>Log</b>	Use the drop-down menu to enable or disable the logging option. By default the event log is enabled.
<b>Interface Name</b>	Enter the interface name of the Layer 3 interface. Select All to enable or disable gratuitous ARP trap or log on all interfaces.
<b>Interval Time (0-65535)</b>	Enter the periodically send gratuitous ARP interval time in seconds. 0 means that gratuitous ARP request will not be sent periodically. By default the interval time is 0.

Click the **Apply** button to accept the changes made.

## User Accounts

The Switch allows the control of user privileges.

To view the following window, click **Configuration > User Accounts**:

Figure 2 - 14. User Accounts window

To add a new user, type in a User Name and New Password and retype the same password in the Confirm New Password field. Choose the level of privilege (*Admin* or *User*) from the Access Right drop-down menu.

Figure 2 - 15. User Accounts window (Edit)

Modify or delete an existing user account in the table at the bottom of the window. To delete the user account, click the **Delete** button. To change the password, click the **Edit** button next to the entry in the table at the bottom of the window. Enter an Old Password, New Password, and retype the new password in the Confirm Password field offered, use the drop-down menu to select the type of encryption desired (*Plain Text* or *Sha 1*), and then click **Apply**. The level of privilege (*Admin* or *User*) can be viewed in the Access Right column in the table at the bottom of the window.



**NOTICE:** In case of lost passwords or password corruption, please refer to the Appendix D, “Password Recovery Procedure,” which will guide you through the steps necessary to resolve this issue.

## Admin and User Privileges

There are two levels of user privileges, **Admin** and **User**. Some menu selections available to users with **Admin** privileges may not be available to those with **User** privileges.

The following table summarizes the Admin and User privileges:

Management	Admin	User
Configuration	Yes	Read-only
Network Monitoring	Yes	Read-only
Community Strings and Trap Stations	Yes	Read-only
Update Firmware and Configuration Files	Yes	No
System Utilities	Yes	No
Factory Reset	Yes	No
User Account Management		
Add/Update/Delete User Accounts	Yes	No
View User Accounts	Yes	No

## Command Logging Settings

This window is used to enable or disable the command logging settings.

To view the following window, click **Configuration > Command Logging Settings**:



Figure 2 - 16. Command Logging Settings window

The following parameters may be configured or viewed:

Parameter	Description
Command Logging State	Use the radio buttons to enable or disable the function.

Click the **Apply** button to accept the changes made.



**NOTE:** When the switch is under the booting or executing downloaded configuration procedure, all configuration commands will not be logged. When the user uses AAA authentication to logged in, the user name should not be changed if the user has used the Enable Admin function to replace its privilege.

## System Log Configuration

### System Log Settings

The window is used to choose a method for which to save the Switch's log to the flash memory of the Switch.

To view the following window, click **Configuration > System Log Configuration > System Log Settings**:

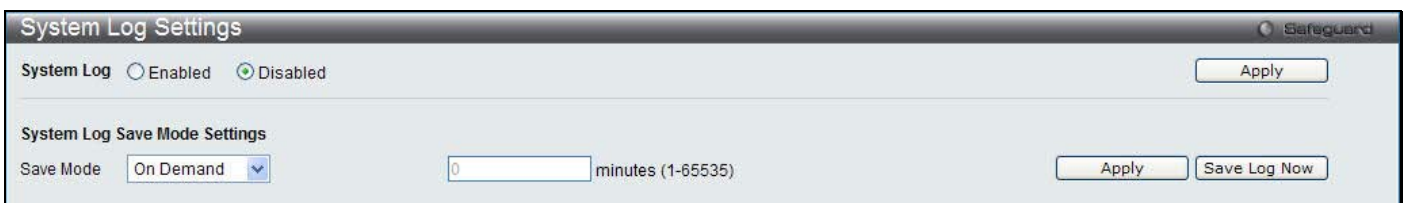

Figure 2 - 17. System Log Settings window

Use the drop-down menu to choose the method for saving the switch log to the flash memory. The user has three options:

- *Time Interval* – Users who choose this method can configure a time interval by which the Switch will save the log files, in the box adjacent to this configuration field. The user may set a time between 1 and 65535 minutes.
- *On Demand* – Users who choose this method will only save log files when they manually tell the Switch to do so, either using the **Save Log** link in the **Save** folder or clicking the **Save Log Now** button on this window.
- *Log Trigger* – Users who choose this method will have log files saved to the Switch every time a log event occurs on the Switch.

The default setting is *On Demand*. Click **Apply** to save changes made. Click **Save Log Now** to immediately save log files currently on the switch.

### System Log Host

The Switch can send Syslog messages to up to four designated servers using the System Log Server.

To view the following window, click **Configuration > System Log Configuration > System Log Host**:

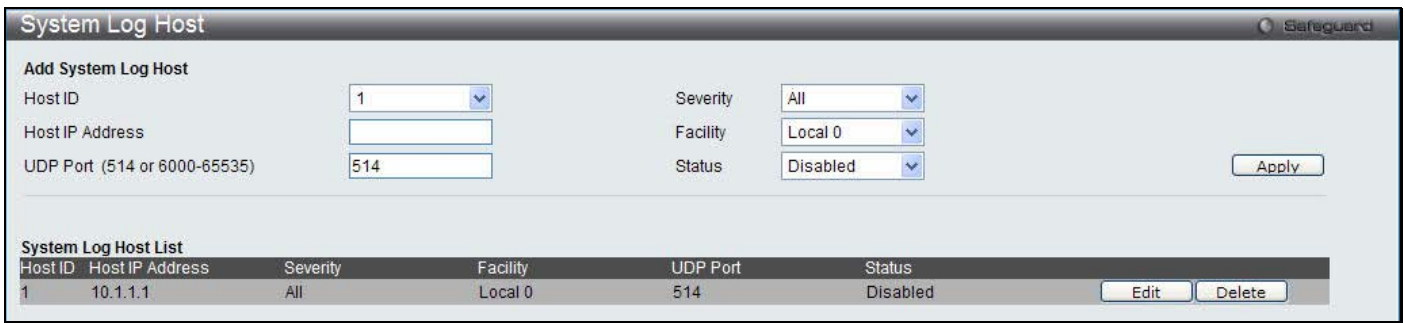

Figure 2 - 18. System Log Host window

The following parameters may be configured or viewed:

Parameter	Description
<b>Host ID</b>	Syslog server settings index ( 1 to 4).
<b>Host IP Address</b>	The Ipv4 address of the Syslog server.
<b>UDP Port (514 or 6000-65535)</b>	Type the UDP port number used for sending Syslog messages. The default is 514.
<b>Severity</b>	This drop-down menu allows you to select the level of messages that will be sent. The options are <i>Warning</i> , <i>Informational</i> , and <i>All</i> .
<b>Facility</b>	Use the drop-down menu to select <i>Local 0</i> , <i>Local 1</i> , <i>Local 2</i> , <i>Local 3</i> , <i>Local 4</i> , <i>Local 5</i> , <i>Local 6</i> , or <i>Local 7</i> .
<b>Status</b>	Choose <i>Enabled</i> or <i>Disabled</i> to activate or deactivate.

To set the System Log Server configuration, click **Apply**. Click the **Edit** button to configure the specific entry. To delete an entry from the System Log Host List table, click the corresponding **Delete** button next to the entry.

## System Severity Settings

The Switch can be configured to allow alerts be logged or sent as a trap to an SNMP agent or both. The level at which the alert triggers either a log entry or a trap message can be set as well. Use the **System Severity Settings** window to set the criteria for alerts. The current settings are displayed below the System Severity Table.

To view the following window, click **Configuration > System Severity Settings**:



Figure 2 - 19. System Severity Settings window

The following parameters may be configured or viewed:

Parameter	Description
<b>System Severity</b>	Choose how the alerts are used from the drop-down menu. Select <i>Log</i> to send the alert of the Severity Type configured to the Switch's log for analysis. Choose <i>Trap</i> to send it to an SNMP agent for analysis, or select <i>All</i> to send the chosen alert type to an SNMP agent and the Switch's log for analysis.
<b>Severity Level</b>	Choose what level of alert will trigger sending the log entry or trap message as defined by the

Severity Name. Select *Critical* to send only critical events to the Switch's log or SNMP agent. Choose *Warning* to send critical and warning events to the Switch's log or SNMP agent. Select *Information* to send informational, warning, and critical events to the Switch's log or SNMP agent.

Click **Apply** to implement the new System Severity Settings.

## MAC Address Aging Time

Users can configure the MAC Address aging time on the Switch.

To view the following window, click **Configuration > MAC Address Aging Time**:

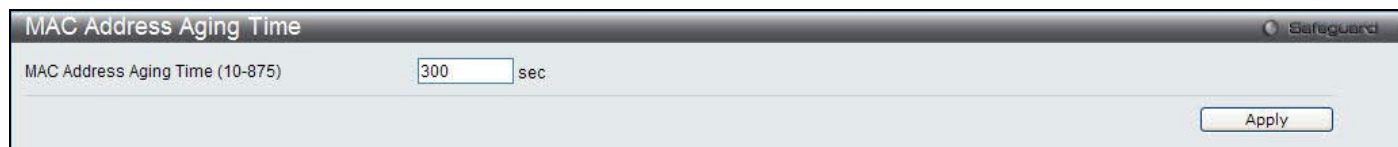

Figure 2 – 20. MAC Address Aging Time window

The following parameter may be configured or viewed:

Parameter	Description
<b>MAC Address Aging Time (10-875)</b>	Specify the length of time a learned MAC Address will remain in the forwarding table without being accessed (that is, how long a learned MAC Address is allowed to remain idle). To change this, type in a different value to represent the MAC address age-out time in seconds. The MAC Address Aging Time can be set to any value between 10 and 875 seconds. The default setting is 300 seconds.

Click **Apply** to set the MAC Address Aging Time.

## Web Settings

Users can configure the Web settings on the Switch.

To view the following window, click **Configuration > Web Settings**:

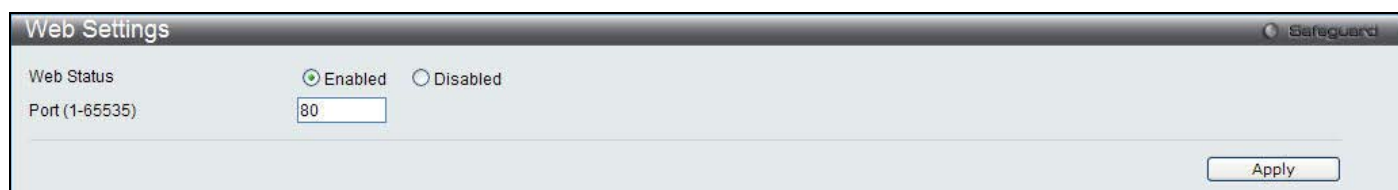

Figure 2 – 21. Web Settings window

The following parameters may be configured or viewed:

Parameter	Description
<b>Web Status</b>	Web-based management is Enabled by default. If you choose to disable this by clicking Disabled, you will lose the ability to configure the system through the web interface as soon as these settings are applied.
<b>Port (1-65535)</b>	The TCP port number used for Web-based management of the Switch. The “well-known” TCP port for the Web protocol is 80.

Click **Apply** to set the web settings.



## Telnet Settings

Users can configure Telnet Settings on the Switch.

To view the following window, click **Configuration > Telnet Settings**:

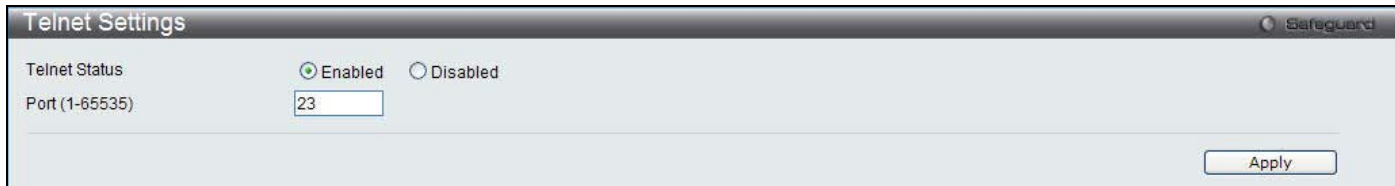

Figure 2 – 22. Telnet Settings window

The following parameters may be configured or viewed:

Parameter	Description
<b>Telnet Status</b>	Telnet configuration is Enabled by default. If you do not want to allow configuration of the system through Telnet choose Disabled.
<b>Port (1-65535)</b>	The TCP port number used for Telnet management of the Switch. The “well-known” TCP port for the Telnet protocol is 23.

Click **Apply** to set the Telnet setting.

## Password Encryption

Users can configure Password Encryption on the Switch.

To view the following window, click **Configuration > Password Encryption**:

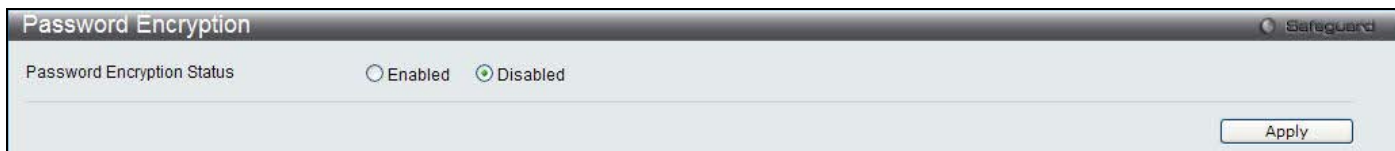

Figure 2 – 23. Password Encryption window

The following parameter may be configured or viewed:

Parameter	Description
<b>Password Encryption Status</b>	Password encryption is Disabled by default. To enable password encryption, click the Enabled radio button.

Click **Apply** to set the password encryption.

## CLI Paging Settings

Users can stop the scrolling of multiple pages beyond the limits of the console when using the Command Line Interface.

To view the following window, click **Configuration > CLI Paging Settings**:

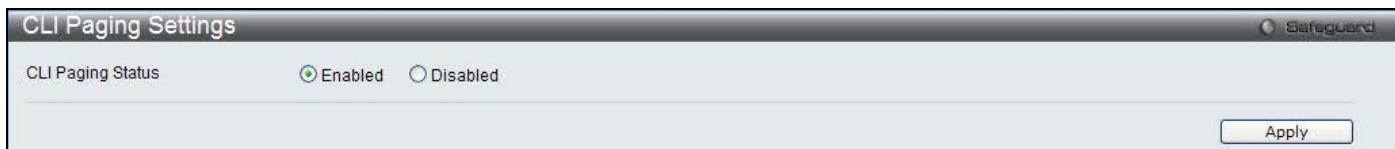

Figure 2 – 24. CLI Paging Settings window

The following parameter may be configured or viewed:

Parameter	Description
<b>CLI Paging Status</b>	Command Line Interface paging stops each page at the end of the console. This allows you to stop the scrolling of multiple pages of text beyond the limits of the console. CLI Paging is Enabled by default. To disable it, click the Disabled radio button.

Click **Apply** to set the CLI Paging setting.

## Firmware Information

Users can view, set the next boot-up status, and delete current firmware images stored on the Switch.

To view the following window, click **Configuration > Firmware Information**:

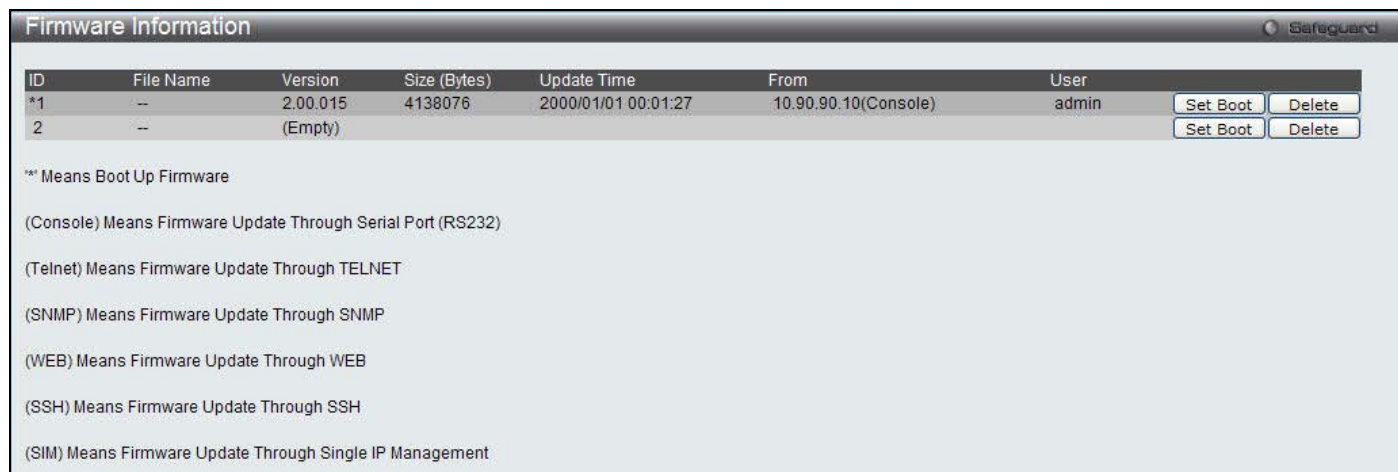

**Figure 2 – 25. Firmware Information window (DGS-3200-10 and DGS-3200-16 models)**



**Figure 2 – 26. Firmware Information window (DGS-3200-24 model)**

The following parameters may be configured or viewed:

Parameter	Description
<b>ID</b>	States the image ID number of the firmware in the Switch’s memory. The Switch can store 2 firmware images for use. Image ID 1 will be the default boot-up firmware for the Switch unless otherwise configured by the user.

<b>Version</b>	States the firmware version.
<b>Size</b>	States the size of the corresponding firmware, in bytes.
<b>Update Time</b>	States the specific time the firmware version was downloaded to the Switch.
<b>From</b>	<p>States the IP address of the origin of the firmware. There are six ways firmware may be downloaded to the Switch. Boot-up files are denoted by an asterisk (*) next to the file.</p> <p><i>Console</i> – If the IP address has the word <i>Console</i> next to it, it denotes a firmware upgrade through the Console Serial Port (RS-232).</p> <p><i>Telnet</i> – If the IP address has the word <i>Telnet</i> next to it, it denotes a firmware upgrade through Telnet.</p> <p><i>SNMP</i> – If the IP address has the word <i>SNMP</i> next to it, it denotes a firmware upgrade through the Simple Network Management Protocol (SNMP).</p> <p><i>WEB</i> – If the IP address has the word <i>WEB</i> next to it, it denotes a firmware upgrade through the web-based management interface.</p> <p><i>SSH</i> – If the IP address has the word <i>SSH</i> next to it, it denotes a firmware upgrade through the Secure Shell (SSH).</p> <p><i>SIM</i> – If the IP address has the word <i>SIM</i> next to it, it denotes a firmware upgrade through the Single IP Management feature.</p>
<b>User</b>	States the user who downloaded the firmware. This field may read “Anonymous” or “Unknown” for users that are not identified.
<b>Path Name (DGS-3200-24 model only)</b>	<p>This parameter is used to boot the Switch up from a firmware image stored on an SD card. To boot the Switch from a firmware image stored on an SD card carry out the following:</p> <ul style="list-style-type: none"> <li>• Input the path of the firmware image on the SD-card (such as "c:\DGS3200.had").</li> <li>• Click the adjacent <b>Set Boot</b> button to use the firmware image, stored on the SD-card, as the bootup image.</li> </ul>

To set firmware as the boot-up firmware the next time the Switch is restarted, click the **Set Boot** button. To remove the firmware from this window, click the **Delete** button.

## Dual Configuration Settings

Users can display dual configuration settings on the Switch. The Switch allows two configurations to be stored in its memory and either can be configured as the boot-up configuration for the Switch (the DGS-3200-24 also allows configurations to be stored on an SD-card). The user may select a boot-up configuration for the Switch by clicking the **Boot** button to select it. This will instruct the Switch to use this newly selected configuration the next time the Switch is restarted. To delete a configuration, click the adjacent **Delete** button. To set a configuration as the active configuration, click the adjacent **Active** button.

To view the following window, click **Configuration > Dual Configuration Settings**:

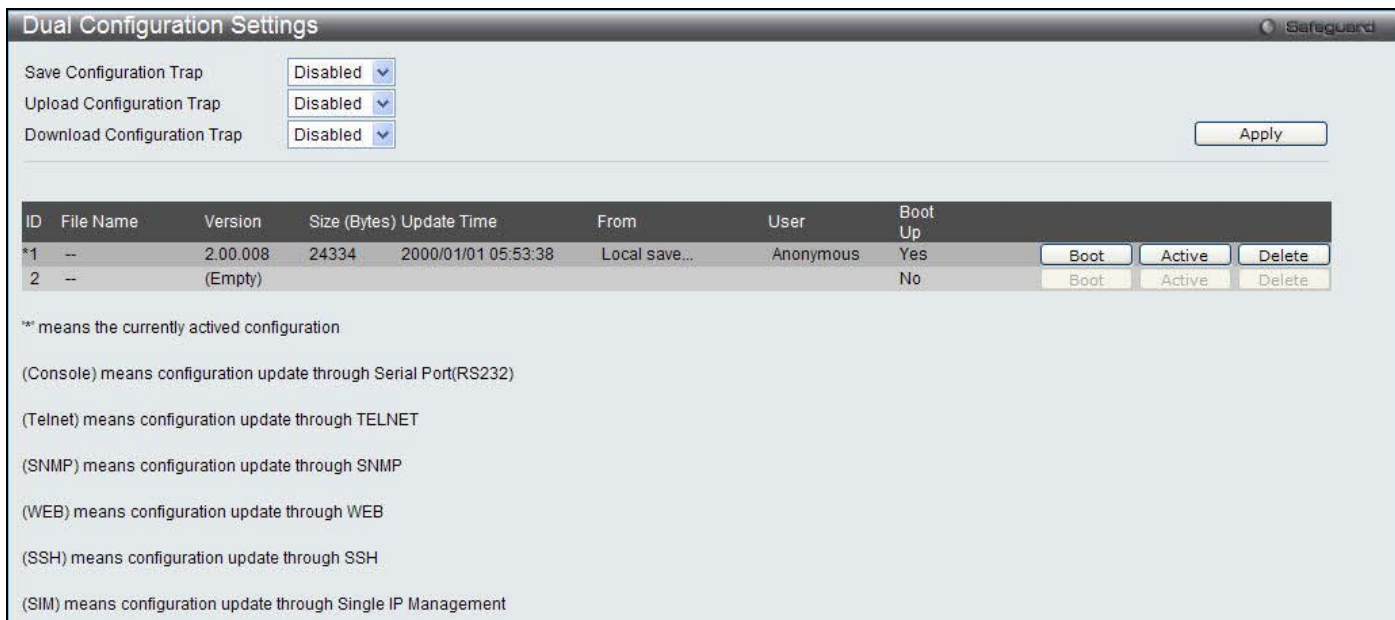

Figure 2 - 27. Dual Configuration Settings window (DGS-3200-10 and DGS-3200-16 models)

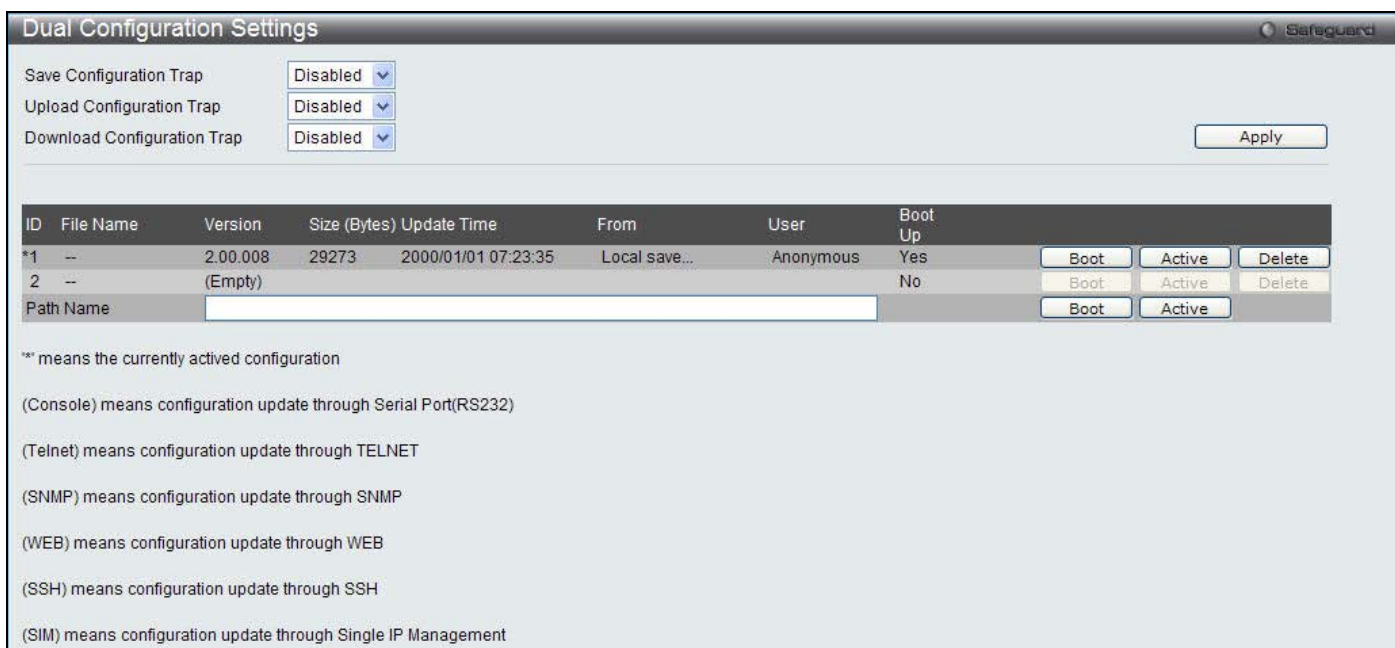

Figure 2 - 28. Dual Configuration Settings window (DGS-3200-24 model)

The following parameters may be configured or viewed:

Parameter	Description
<b>ID</b>	States the configuration ID number of the configuration in the Switch's memory. The Switch can store 2 configurations for use. Configuration ID 1 will be the default boot-up configuration for the Switch unless otherwise configured by the user.
<b>File Name</b>	States the file name.
<b>Version</b>	States the configuration version.
<b>Size (Bytes)</b>	States the size of the corresponding configuration, in bytes.
<b>Update Time</b>	States the specific time the configuration version was downloaded to the Switch.
<b>From</b>	States the IP address of the origin of the configuration. There are five ways a configuration may be downloaded to the Switch. Boot-up files are denoted by an asterisk (*) next to the file.

	<p>Console – If the IP address has the word <i>Console</i> next to it, it denotes a configuration upgrade through the Console Serial Port (RS-232).</p> <p>Telnet – If the IP address has the word <i>Telnet</i> next to it, it denotes a configuration upgrade through Telnet.</p> <p>SNMP – If the IP address has the word <i>SNMP</i> next to it, it denotes a configuration upgrade through the Simple Network Management Protocol (SNMP).</p> <p>WEB – If the IP address has the word <i>WEB</i> next to it, it denotes a configuration upgrade through the web-based management interface.</p> <p>SSH – If the IP address has the word <i>SSH</i> next to it, it denotes a configuration upgrade using Secure Shell (SSH).</p> <p>SIM – If the IP address has the word <i>SIM</i> next to it, it denotes a configuration upgrade through the Single IP Management feature.</p>
<b>User</b>	States the user who downloaded the configuration. This field may read “Anonymous” or “Unknown” for users that are not identified.
<b>Boot Up</b>	States if the configuration will be used to boot up the Switch or not. <i>Yes</i> indicates that the configuration will be used as the boot up configuration. <i>No</i> indicates that the configuration will not be used as the boot up configuration.
<b>Path Name (DGS-3200-24 model only)</b>	<p>This parameter is used to boot the Switch up from a configuration stored on an SD card.</p> <p>To boot the Switch from a configuration stored on an SD card carry out the following:</p> <ul style="list-style-type: none"> <li>• Input the path of configuration on the SD-card (such as "c:\DGS3200.had").</li> <li>• Click the adjacent <b>Set Boot</b> button to use the configuration, stored on the SD-card, as the bootup configuration.</li> <li>• Click the adjacent <b>Active</b> button to make the configuration, stored on the SD-card, the active configuration.</li> </ul>

#### *Setting the Boot Up Configuration:*

- Click the **Boot** button next to the configuration you want to use as the Boot Up configuration.
- A **Success** message appears to indicate that the configuration that will be used for booting up the Switch has changed.
- The *Boot Up* parameter next to the configuration that will be used to boot up the Switch will read *Yes*.

#### *Setting the Active Configuration:*

- Click the **Active** button next to the configuration you want to use as the Active configuration.
- A **Success** message appears to indicate that the configuration that will be used as the active configuration has changed.
- An asterisk will appear next to *ID* of the configuration that is being used as the active configuration.

#### *Deleting a Configuration:*

- Click the **Delete** button next to the configuration you want to delete.
- A **Success** message appears to indicate that the configuration has been deleted.

## Power Saving

### LED State Settings

This window is used to configure the port LED state.

To view the following window, click **Configuration > Power Saving > LED State Settings**:



Figure 2 – 29. Port LED State Settings window

The following parameter may be configured:

Parameter	Description
Port LED State	Click the radio buttons to enable or disable the port LED state.

Click **Apply** to save the settings.

## Power Saving Settings

This window allows the user to implement the Switch’s built-in power saving features and set the schedule to enforce the settings. When the Power Saving Mode Link Detection State is *Enabled*, a port which has a link down status will be turned off to save power to the Switch. This will not affect the port’s capabilities when the port status is link up. When the Power Saving Mode Length Detection State is *Enabled*, the Switch will automatically determine the length of the cable and adjust the power flow accordingly. When Power Saving Mode LED State is *Enabled*, the LED’s state of ports will be turned off during the configured time range. When Power Saving Mode Port State is *Enabled*, the ports will be shut down during the configured time range. When Power Saving Mode Hibernation State is *Enabled*, the Switch will go into a low power state and be idle during the configured time range. It will shut down all the ports, all network function (telnet, ping, etc.) will not work, and only the console connection will work via the RS232 port. If the Switch is an endpoint type PSE (Power Sourcing Equipment), it will not provide power to the port.

To view the following window, click **Configuration > Power Saving > Power Saving Settings**:



Figure 2 – 30. Power Saving Settings window

The following parameter may be configured or viewed:

Parameter	Description
Power Saving Mode Link Detection State	Click the radio buttons to enable or disable the link detection state.
Power Saving Mode Length Detection State	Click the radio buttons to enable or disable length detection state.
Power Saving Mode LED State	Click the radio buttons to enable or disable LED state.
Power Saving Mode	Click the radio buttons to enable or disable port state.

<b>Port State</b>	
<b>Power Saving Mode Hibernation State</b>	Click the radio buttons to enable or disable hibernation state.
<b>Action</b>	Use the drop down menu to add or delete the schedule.
<b>Time Range Name</b>	Specify the name of the schedule.

Click **Apply** to set the password encryption. Click the **Clear Time Range** to remove all the entries.

## Power Saving LED Settings

This window is used to add or delete the power saving schedule on the LED of all ports.

To view the following window, click **Configuration > Power Saving > Power Saving LED Settings**:

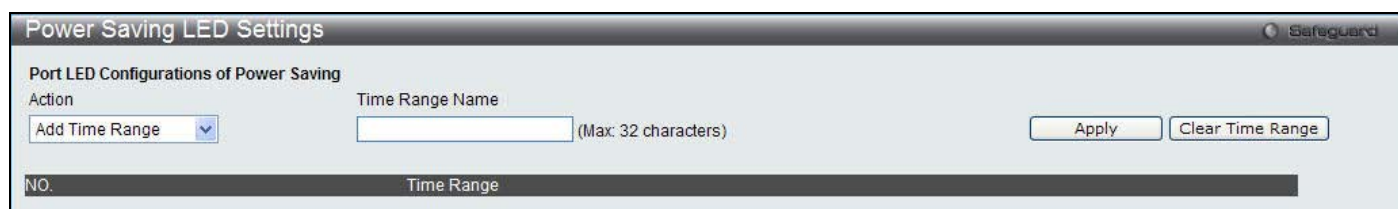

Figure 2 – 31. Power Saving LED Settings window

The following parameter may be configured:

Parameter	Description
<b>Action</b>	Use the drop down menu to add or delete the schedule.
<b>Time Range Name</b>	Specify the name of the schedule.

Click the **Apply** button to save the settings. Click the **Clear Time Range** to remove all the entries.

## Power Saving Port Settings

This window is used to set the power saving state.

To view the following window, click **Configuration > Power Saving > Power Saving Port Settings**:

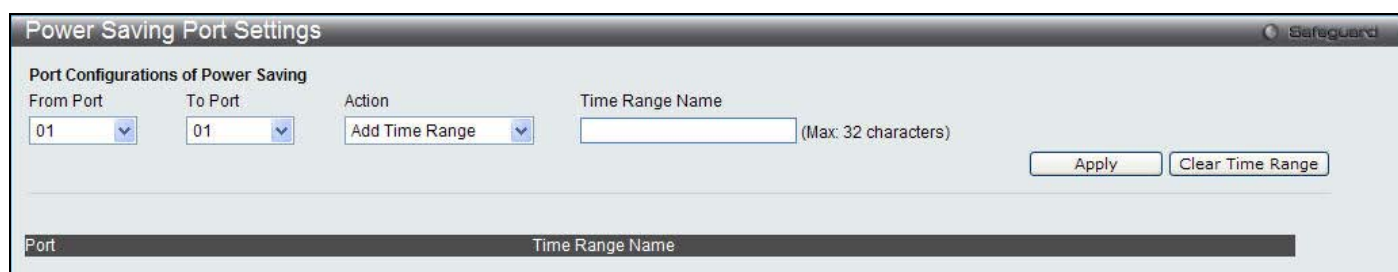

Figure 2 – 32. Power Saving Port Settings window

The following parameter may be configured:

Parameter	Description
<b>From Port / To Port</b>	Use the drop-down menu to select the ports to be configured.
<b>Action</b>	Use the drop down menu to add or delete the schedule.
<b>Time Range Name</b>	Specify the name of the schedule.

Click the **Apply** button to save the settings.

Click the **Clear Time Range** to remove all the entries.

## MAC Notification Settings

MAC Notification is used to monitor MAC addresses learned and entered into the forwarding database.

### MAC Notification Global Settings

This window allows you to globally set MAC notification on the Switch.

To view the following window, click **Configuration > MAC Notification Settings > MAC Notification Global Settings**:

**Figure 2 - 33. MAC Notification Global Settings window**

The following parameters may be viewed and modified:

Parameter	Description
<b>State</b>	Enable or disable MAC notification globally on the Switch
<b>Interval (1-2147483647)</b>	The time in seconds between notifications.
<b>History Size (1-500)</b>	The maximum number of entries listed in the history log used for notification. Up to 500 entries can be specified.

Click **Apply** to implement your changes.

### MAC Notification Port Settings

Users can set MAC notification for individual ports on the Switch.

To view the following window, click **Configuration > MAC Notification Settings > MAC Notification Port Settings**:



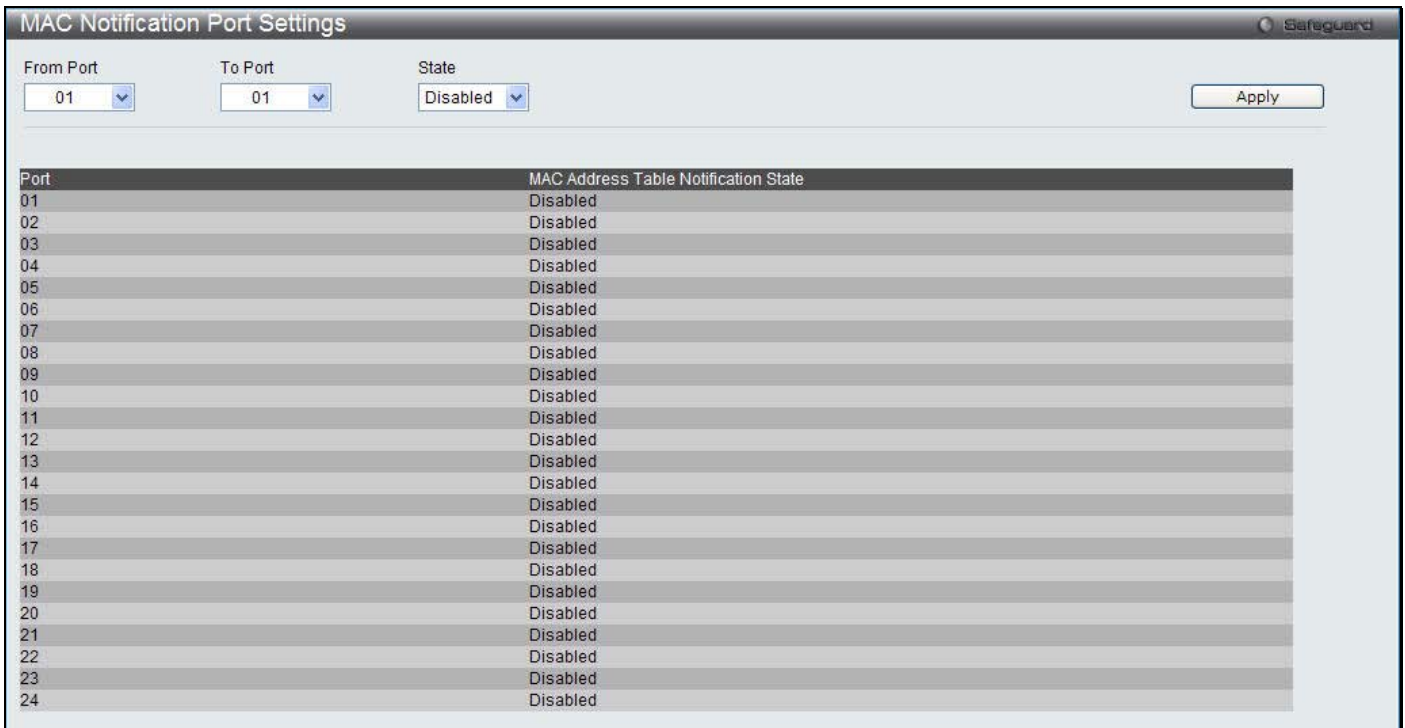

Figure 2 - 34. MAC Notification Port Settings window

To change MAC notification settings for a port or group of ports on the Switch, configure the following parameters:

Parameter	Description
<b>From Port</b>	Select a beginning port to enable for MAC notification using the drop-down menu.
<b>To Port</b>	Select an ending port to enable for MAC notification using the drop-down menu.
<b>State</b>	Enable MAC Notification for the ports selected using the drop-down menu.

Click **Apply** to implement changes made.

## SNMP Settings

Simple Network Management Protocol (SNMP) is an OSI Layer 7 (Application Layer) designed specifically for managing and monitoring network devices. SNMP enables network management stations to read and modify the settings of gateways, routers, switches, and other network devices. Use SNMP to configure system features for proper operation, monitor performance and detect potential problems in the Switch, switch group or network.

Managed devices that support SNMP include software (referred to as an agent), which runs locally on the device. A defined set of variables (managed objects) is maintained by the SNMP agent and used to manage the device. These objects are defined in a Management Information Base (MIB), which provides a standard presentation of the information controlled by the on-board SNMP agent. SNMP defines both the format of the MIB specifications and the protocol used to access this information over the network.

The Switch supports the SNMP versions 1, 2c, and 3. The three versions of SNMP vary in the level of security provided between the management station and the network device.

In SNMP v.1 and v.2, user authentication is accomplished using ‘community strings’, which function like passwords. The remote user SNMP application and the Switch SNMP must use the same community string. SNMP packets from any station that has not been authenticated are ignored (dropped).

The default community strings for the Switch used for SNMP v.1 and v.2 management access are:

- **public** – Allows authorized management stations to retrieve MIB objects.
- **private** – Allows authorized management stations to retrieve and modify MIB objects.

SNMPv3 uses a more sophisticated authentication process that is separated into two parts. The first part is to maintain a list of users and their attributes that are allowed to act as SNMP managers. The second part describes what each user on that list can do as an SNMP manager.

The Switch allows groups of users to be listed and configured with a shared set of privileges. The SNMP version may also be set for a listed group of SNMP managers. Thus, you may create a group of SNMP managers that are allowed to view read-only information or receive traps using SNMPv1 while assigning a higher level of security to another group, granting read/write privileges using SNMPv3.

Using SNMPv3 individual users or groups of SNMP managers can be allowed to perform or be restricted from performing specific SNMP management functions. The functions allowed or restricted are defined using the Object Identifier (OID) associated with a specific MIB. An additional layer of security is available for SNMPv3 in that SNMP messages may be encrypted. To read more about how to configure SNMPv3 settings for the Switch read the next section.

## Traps

Traps are messages that alert network personnel of events that occur on the Switch. The events can be as serious as a reboot (someone accidentally turned OFF the Switch), or less serious like a port status change. The Switch generates traps and sends them to the trap recipient (or network manager). Typical traps include trap messages for Authentication Failure, Topology Change and Broadcast/Multicast Storm.

## MIBs

The Switch in the Management Information Base (MIB) stores management and counter information. The Switch uses the standard MIB-II Management Information Base module. Consequently, values for MIB objects can be retrieved from any SNMP-based network management software. In addition to the standard MIB-II, the Switch also supports its own proprietary enterprise MIB as an extended Management Information Base. Specifying the MIB Object Identifier may also retrieve the proprietary MIB. MIB values can be either read-only or read-write.

The Switch incorporates a flexible SNMP management for the switching environment. SNMP management can be customized to suit the needs of the networks and the preferences of the network administrator. Use the SNMP V3 menus to select the SNMP version used for specific tasks.

The Switch supports the Simple Network Management Protocol (SNMP) versions 1, 2c, and 3. The administrator can specify the SNMP version used to monitor and control the Switch. The three versions of SNMP vary in the level of security provided between the management station and the network device.

SNMP settings are configured using the menus located on the SNMP Settings folder of the Web manager. Workstations on the network that are allowed SNMP privileged access to the Switch can be restricted with the Management Station IP Address menu.

## SNMP Global State Settings

SNMP global state settings can be enabled or disabled.

To view the following window, click **Configuration > SNMP Settings > SNMP Global State Settings**:

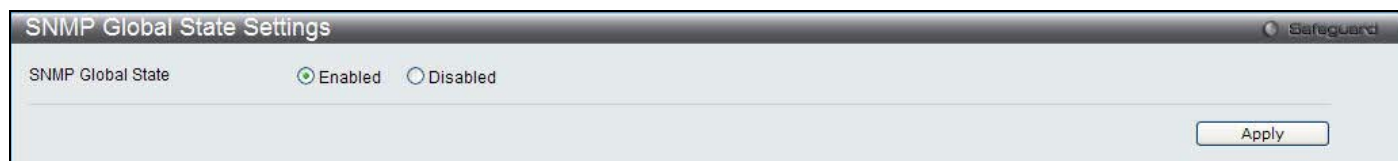

Figure 2 - 35. SNMP Global State Settings window

Click the **Apply** button to let your change take effect.

## SNMP Linkchange Traps Settings

Users can set SNMP linkchange traps.

To view the following window, click **Configuration > SNMP Settings > SNMP Linkchange Trap Settings**:

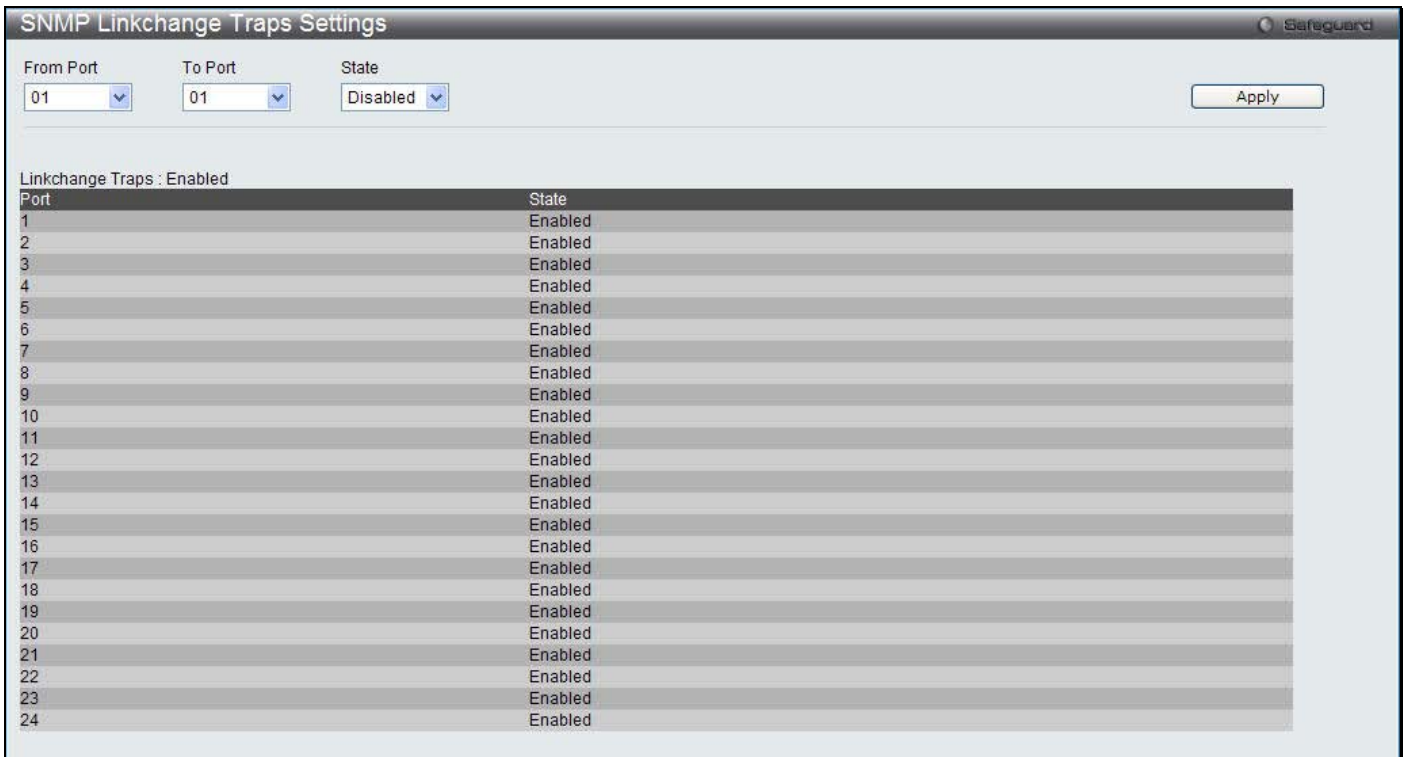

Figure 2 - 36. SNMP Linkchange Trap Settings window

The following parameters may be configured:

Parameter	Description
<b>From Port / To Port</b>	Use the drop-down menu to select the ports to be configured.
<b>State</b>	Use the drop-down menu to enable or disable the SNMP linkchange traps.

Click **Apply** to implement the changes.

## SNMP View Table

Users can assign views to community strings that define which MIB objects can be accessed by a remote SNMP manager. The SNMP Group created with this table maps SNMP users (identified in the SNMP User Table) to the views created in the previous window.

To view the following window, click **Configuration > SNMP Settings > SNMP View Table**:

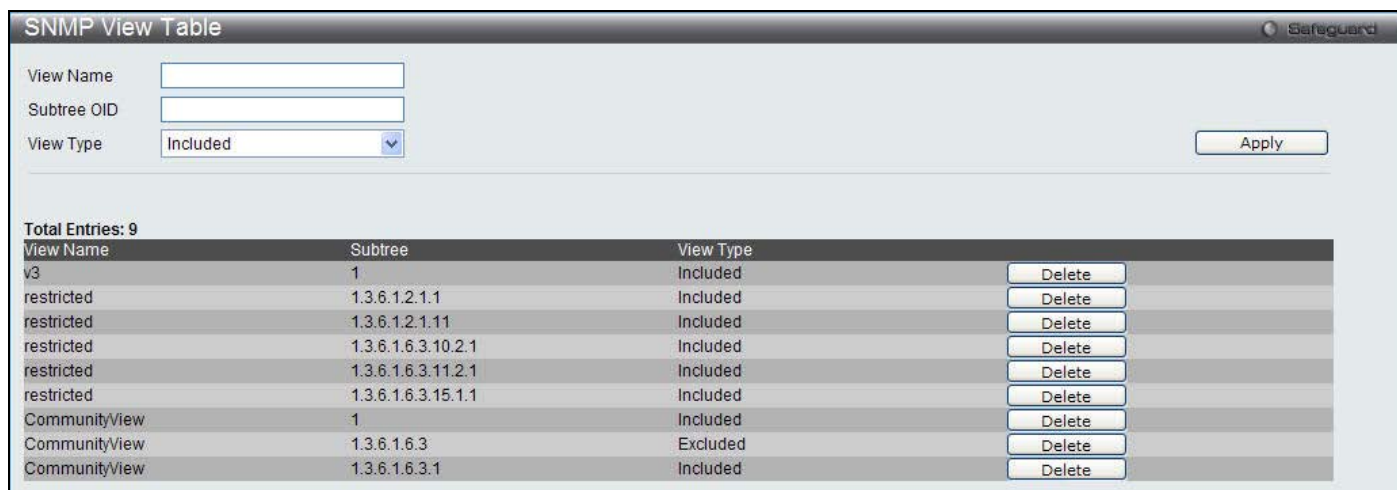

Figure 2 - 37. SNMP View Table window

The following parameters can be set:

Parameter	Description
<b>View Name</b>	Type an alphanumeric string of up to 32 characters. This is used to identify the new SNMP view being created.
<b>Subtree OID</b>	Type the Object Identifier (OID) Subtree for the view. The OID identifies an object tree (MIB tree) that will be included or excluded from access by an SNMP manager.
<b>View Type</b>	Select <i>Included</i> to include this object in the list of objects that an SNMP manager can access. Select <i>Excluded</i> to exclude this object from the list of objects that an SNMP manager can access.

To delete an existing SNMP View Table entry, click the **Delete** button corresponding to the entry to delete. To create a new entry, enter the information above the table and then click the **Apply** button.

## SNMP Group Table

An SNMP Group created with this table maps SNMP users (identified in the SNMP User Table) to the views created in the previous window.

To view the following window, click **Configuration > SNMP Settings > SNMP Group Table**:

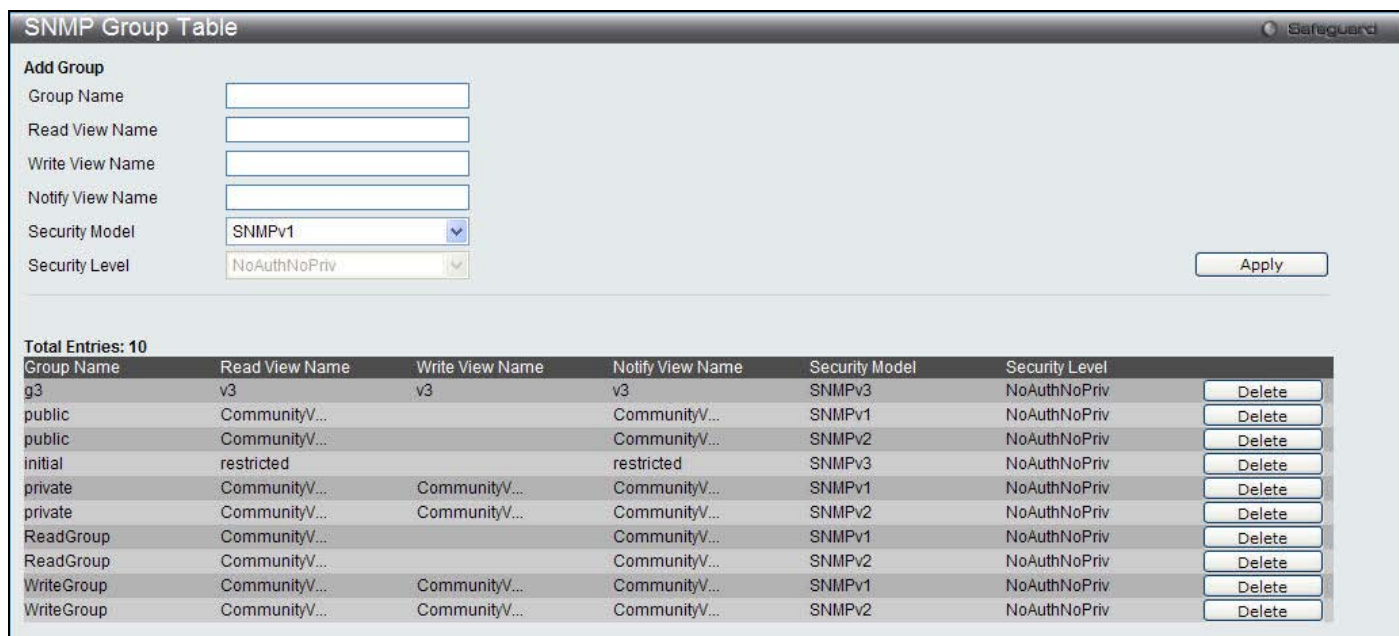

Figure 2 - 38. SNMP Group Table window

The following parameters can be set:

Parameter	Description
<b>Group Name</b>	Type an alphanumeric string of up to 32 characters. This is used to identify the new SNMP group of SNMP users.
<b>Read View Name</b>	This name is used to specify the SNMP group created can request SNMP messages.
<b>Write View Name</b>	Specify an SNMP group name for users that are allowed SNMP write privileges to the Switch's SNMP agent.
<b>Notify View Name</b>	Specify a SNMP group name for users that can receive SNMP trap messages generated by the Switch's SNMP agent.
<b>Security Model</b>	<p><i>SNMPv1</i> – Specifies that SNMP version 1 will be used.</p> <p><i>SNMPv2</i> – Specifies that SNMP version 2c will be used. The SNMPv2 supports both centralized and distributed network management strategies. It includes improvements in the Structure of Management Information (SMI) and adds some security features.</p> <p><i>SNMPv3</i> – Specifies that the SNMP version 3 will be used. SNMPv3 provides secure access to devices through a combination of authentication and encrypting packets over the network.</p>
<b>Security Level</b>	<p>The Security Level settings only apply to SNMPv3.</p> <p><i>NoAuthNoPriv</i> – Specifies that there will be no authorization and no encryption of packets sent between the Switch and a remote SNMP manager.</p> <p><i>AuthNoPriv</i> – Specifies that authorization will be required, but there will be no encryption of packets sent between the Switch and a remote SNMP manager.</p> <p><i>AuthPriv</i> – Specifies that authorization will be required, and that packets sent between the Switch and a remote SNMP manger will be encrypted.</p>

To delete an existing SNMP Group Table entry, click the **Delete** button next to the corresponding entry.

To add a new entry to the Switch's SNMP Group Table, enter the information at the top of the window and then click **Apply**.

## SNMP User Table

This window displays all of the SNMP User's currently configured on the Switch.

To view the following window, click **Configuration > SNMP Settings > SNMP User Table**:

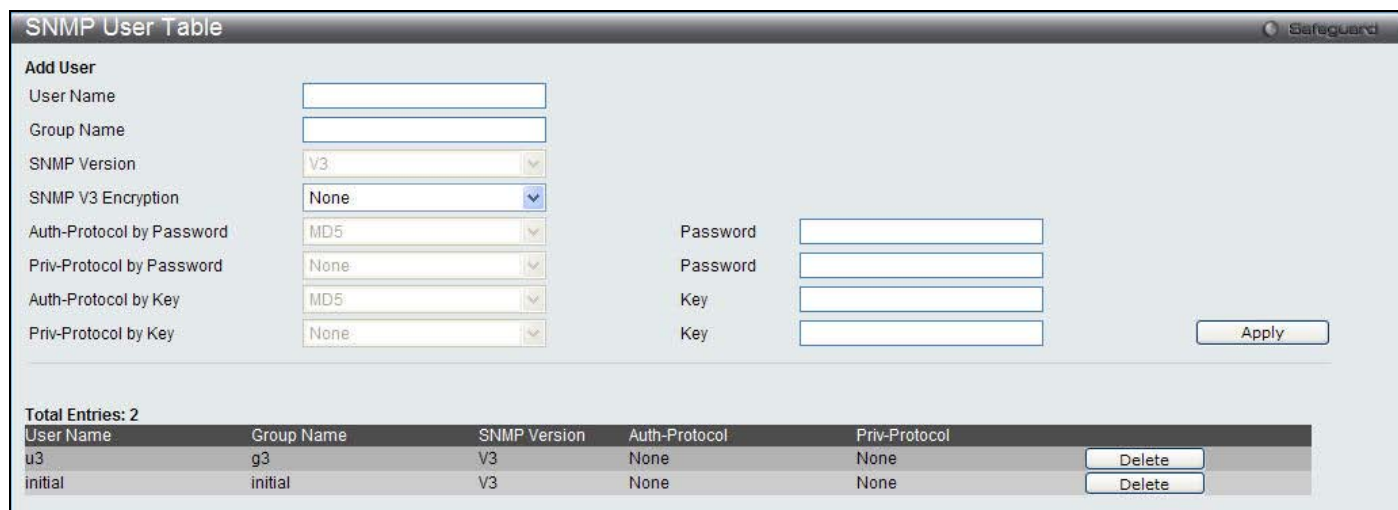

Figure 2 - 39. SNMP User Table window

The following parameters can be configured:

Parameter	Description
<b>User Name</b>	An alphanumeric string of up to 32 characters. This is used to identify the SNMP users.
<b>Group Name</b>	This name is used to specify the SNMP group created can request SNMP messages.
<b>SNMP Version</b>	V3 – Indicates that SNMP version 3 is in use.
<b>SNMP V3 Encryption</b>	Use the drop-down menu to enable encryption for SNMP V3. This is only operable in SNMP V3 mode. The choices are <i>None</i> , <i>Password</i> , or <i>Key</i> .
<b>Auth-Protocol</b>	<i>MD5</i> – Specifies that the HMAC-MD5-96 authentication level will be used. This field is only operable when V3 is selected in the SNMP Version field and the Encryption field has been checked. This field will require the user to enter a password. <i>SHA</i> – Specifies that the HMAC-SHA authentication protocol will be used. This field is only operable when V3 is selected in the SNMP Version field and the Encryption field has been checked. This field will require the user to enter a password.
<b>Priv-Protocol</b>	<i>None</i> – Specifies that no authorization protocol is in use. <i>DES</i> – Specifies that DES 56-bit encryption is in use, based on the CBC-DES (DES-56) standard. This field is only operable when V3 is selected in the SNMP Version field and the Encryption field has been checked. This field will require the user to enter a password between 8 and 16 alphanumeric characters.

To delete an existing SNMP User Table entry, click the **Delete** button corresponding to the entry to delete.

To implement changes made, click **Apply**.

## SNMP Community Table

Users can create an SNMP community string to define the relationship between the SNMP manager and an agent. The community string acts like a password to permit access to the agent on the Switch. One or more of the following characteristics can be associated with the community string:

- An Access List of IP addresses of SNMP managers that are permitted to use the community string to gain access to the Switch's SNMP agent.
- Any MIB view that defines the subset of all MIB objects will be accessible to the SNMP community.
- Read/write or read-only level permission for the MIB objects accessible to the SNMP community.

To view the following window, click **SNMP Settings > Configuration > SNMP Community Table**:



Figure 2 - 40. SNMP Community Table window

The following parameters can be set:

Parameter	Description
<b>Community Name</b>	Type an alphanumeric string of up to 32 characters that is used to identify members of an SNMP community. This string is used like a password to give remote SNMP managers access to MIB objects in the Switch's SNMP agent.
<b>View Name</b>	Type an alphanumeric string of up to 32 characters that is used to identify the group of MIB objects that a remote SNMP manager is allowed to access on the Switch. The view name must exist in the SNMP View Table.
<b>Access Right</b>	<i>Read Only</i> – Specifies that SNMP community members using the community string created can only read the contents of the MIBs on the Switch. <i>Read Write</i> – Specifies that SNMP community members using the community string created can read from, and write to the contents of the MIBs on the Switch.

To implement the new settings, click **Apply**. To delete an entry from the SNMP Community Table, click the **Delete** button corresponding to the entry to delete.

## SNMP Host Table

Users can set up SNMP trap recipients for IPv4.

To view the following window, click **Configuration > SNMP Settings > SNMP Host Table**:



Figure 2 - 41. SNMP Host Table window

The following parameters can be set:

Parameter	Description
<b>Host IP Address</b>	Type the IP address of the remote management station that will serve as the SNMP host for the Switch.
<b>SNMP Version</b>	<i>V1</i> – To specify that SNMP version 1 will be used. <i>V2c</i> – To specify that SNMP version 2c will be used. <i>V3-NoAuthNoPriv</i> – To specify that the SNMP version 3 will be used, with a NoAuth-NoPriv

	<p>security level.</p> <p><i>V3-AuthNoPriv</i> – To specify that the SNMP version 3 will be used, with an Auth-NoPriv security level.</p> <p><i>V3-AuthPriv</i> – To specify that the SNMP version 3 will be used, with an Auth-Priv security level.</p>
<b>Community String / SNMP V3 User Name</b>	Type in the community string or SNMP V3 user name as appropriate.

To add a new entry to the Switch’s SNMP Host Table, enter the information at the top of the window and then click the **Apply** button. To delete an existing SNMP Host Table entry, click the **Delete** button corresponding to the entry to delete.

## SNMP v6Host Table

Users can set up SNMP trap recipients for IPv6.

To view the following window, click **Configuration > SNMP Settings > SNMP v6Host Table**:



**Figure 2 - 42. SNMP v6Host Table window**

The following parameters can be configured:

Parameter	Description
<b>Host IPv6 Address</b>	Type the IP address of the remote management station that will serve as the SNMP host for the Switch.
<b>SNMP Version</b>	<p><i>V1</i> – To specify that SNMP version 1 will be used.</p> <p><i>V2c</i> – To specify that SNMP version 2c will be used.</p> <p><i>V3-NoAuthNoPriv</i> – To specify that the SNMP version 3 will be used, with a NoAuth-NoPriv security level.</p> <p><i>V3-AuthNoPriv</i> – To specify that the SNMP version 3 will be used, with an Auth-NoPriv security level.</p> <p><i>V3-AuthPriv</i> – To specify that the SNMP version 3 will be used, with an Auth-Priv security level.</p>
<b>Community String / SNMPv3 User Name</b>	Type in the community string or SNMP V3 user name as appropriate.

To add a new entry to the Switch’s SNMP v6Host Table, enter the information at the top of the window and then click the **Apply** button. To delete an existing SNMP v6Host Table entry, click the **Delete** button corresponding to the entry to delete.

## SNMP Engine ID

The Engine ID is a unique identifier used for SNMP V3 implementations on the Switch.

To view the following window, click **Configuration > SNMP Settings > SNMP Engine ID**:





Figure 2 - 43. SNMP Engine ID window

The following parameter can be configured:

Parameter	Description
Engine ID	The SNMP engine ID displays the identification of the SNMP engine on the Switch. The default value is suggested in RFC2271. The very first bit is 1, and the first four octets are set to the binary equivalent of the agent's SNMP management private enterprise number as assigned by IANA (D-Link is 171). The fifth octet is 03 to indicate the rest is the MAC address of this device. The sixth to eleventh octets is the MAC address.

Click **Apply** to implement the changes.

## SNMP Trap Configuration

Users can enable and disable global SNMP trap support, SNMP authentication failure trap support, Linkchange Traps, Coldstart Traps, and Warmstart Traps. To enable Linkchange Traps for a specific port or range of ports, go to the SNMP Linkchange Traps Settings window.

To view the following window, click **Configuration > SNMP Settings > SNMP Trap Configuration**:



Figure 2 - 44. SNMP Trap Configuration window

To enable or disable the SNMP Traps, SNMP Authenticate Traps, Linkchange Traps, Coldstart Traps, and Warmstart Traps, use the corresponding drop-down menu to change and click **Apply**.

## RMON

Users can enable and disable remote monitoring (RMON) status for the SNMP function on the Switch. In addition, RMON Rising and Falling Alarm Traps can be enabled and disabled.

To view the following window, click **Configuration > SNMP Settings > RMON**:

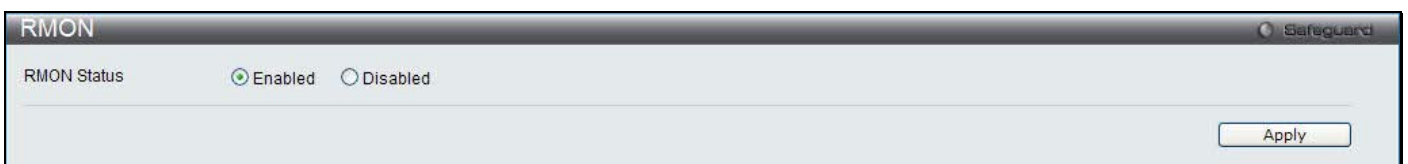

Figure 2 - 45. RMON window

To enable or disable RMON for SNMP, use the radio buttons. Click **Apply** when finished.

## CPU Filter L3 Control Packet Settings

Users can discard and display Layer 3 control packets sent to the CPU from specific ports.

To view the following window, click **Configuration > CPU Filter L3 Control Packet Settings**:

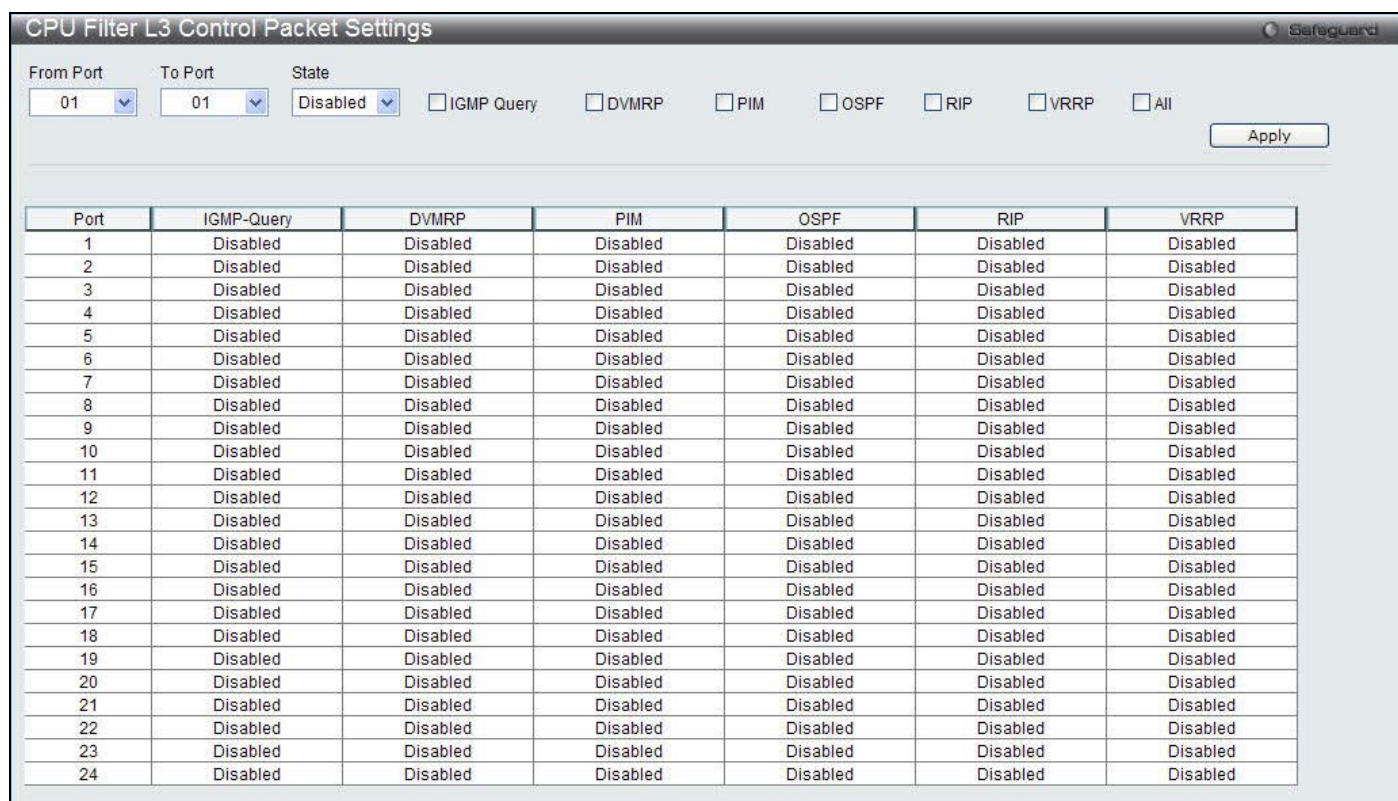

Figure 2 - 46. CPU Filter L3 Control Packet Settings window

To set CPU filter Layer 3 control packet settings on the Switch, use the From Port and To Port drop-down menus to select the desired port range, change the State to *Enabled*, and tick the desired Layer 3 categories (IGMP Query, DVMRP, PIM, OSPF, RIP, VRRP, or All). Click **Apply** when finished.

## Single IP Management

Simply put, D-Link Single IP Management is a concept that will stack switches together over Ethernet instead of using stacking ports or modules. There are some advantages in implementing the “Single IP Management” feature:

1. SIM can simplify management of small workgroups or wiring closets while scaling the network to handle increased bandwidth demand.
2. SIM can reduce the number of IP address needed in your network.
3. SIM can eliminate any specialized cables for stacking connectivity and remove the distance barriers that typically limit your topology options when using other stacking technology.

Switches using D-Link Single IP Management (labeled here as SIM) must conform to the following rules:

- SIM is an optional feature on the Switch and can easily be enabled or disabled through the Command Line Interface or Web Interface. SIM grouping has no effect on the normal operation of the Switch in the user’s network.
- There are three classifications for switches using SIM. The **Commander Switch (CS)**, which is the master switch of the group, **Member Switch (MS)**, which is a switch that is recognized by the CS a member of a SIM group, and a **Candidate Switch (CaS)**, which is a Switch that has a physical link to the SIM group but has not been recognized by the CS as a member of the SIM group.
- A SIM group can only have one Commander Switch (CS).

- All switches in a particular SIM group must be in the same IP subnet (broadcast domain). Members of a SIM group cannot cross a router.
- A SIM group accepts up to 32 switches (numbered 1-32), not including the Commander Switch (numbered 0).
- There is no limit to the number of SIM groups in the same IP subnet (broadcast domain); however a single switch can only belong to one group.
- If multiple VLANs are configured, the SIM group will only utilize the default VLAN on any switch.
- SIM allows intermediate devices that do not support SIM. This enables the user to manage switches that are more than one hop away from the CS.

The SIM group is a group of switches that are managed as a single entity. The Switch may take on three different roles:

1. **Commander Switch (CS)** – This is a switch that has been manually configured as the controlling device for a group, and takes on the following characteristics:
  - It has an IP Address.
  - It is not a command switch or member switch of another Single IP group.
  - It is connected to the member switches through its management VLAN.
2. **Member Switch (MS)** – This is a switch that has joined a single IP group and is accessible from the CS, and it takes on the following characteristics:
  - It is not a CS or MS of another IP group.
  - It is connected to the CS through the CS management VLAN.
3. **Candidate Switch (CaS)** – This is a switch that is ready to join a SIM group but is not yet a member of the SIM group. The Candidate Switch may join the SIM group of the Switch by manually configuring it to be a MS of a SIM group. A switch configured as a CaS is not a member of a SIM group and will take on the following characteristics:
  - It is not a CS or MS of another Single IP group.
  - It is connected to the CS through the CS management VLAN

The following rules also apply to the above roles:

- Each device begins in a Candidate state.
- CS's must change their role to CaS and then to MS, to become a MS of a SIM group. Thus, the CS cannot directly be converted to a MS.
- The user can manually configure a CS to become a CaS.
- A MS can become a CaS by:
  - Being configured as a CaS through the CS.
  - If report packets from the CS to the MS time out.
- The user can manually configure a CaS to become a CS
- The CaS can be configured through the CS to become a MS.

After configuring one switch to operate as the CS of a SIM group, additional DGS-3200 Series switches may join the group by manually configuring the Switch to be a MS. The CS will then serve as the in band entry point for access to the MS. The CS's IP address will become the path to all MS's of the group and the CS's Administrator's password, and/or authentication will control access to all MS's of the SIM group.

With SIM enabled, the applications in the CS will redirect the packet instead of executing the packets. The applications will decode the packet from the administrator, modify some data, and then send it to the MS. After execution, the CS may receive a response packet from the MS, which it will encode and send it back to the administrator.

When a CaS becomes a MS, it automatically becomes a member of the first SNMP community (including read/write and read only) to which the CS belongs. However, if a MS has its own IP address, it can belong to SNMP communities to which other switches in the group, including the CS, do not belong.

## **Upgrade to v1.61**

To better improve SIM management, the DGS-3200 Series switches have been upgraded to version 1.61 in this release. Many improvements have been made, including:

- The Commander Switch (CS) now has the capability to automatically rediscover member switches that have left the SIM group, either through a reboot or web malfunction. This feature is accomplished through the use of Discover packets and Maintenance packets that previously set SIM members will emit after a reboot. Once a MS has had its MAC address and password saved to the CS's database, if a reboot occurs in the MS, the CS will keep this MS information in its database and when a MS has been rediscovered, it will add the MS back into the SIM tree automatically. No configuration will be necessary to rediscover these switches.

There are some instances where pre-saved MS switches cannot be rediscovered. For example, if the Switch is still powered down, if it has become the member of another group, or if it has been configured to be a Commander Switch, the rediscovery process cannot occur.

- The topology map now includes new features for connections that are a member of a port trunking group. It will display the speed and number of Ethernet connections creating this port trunk group, as shown in the adjacent picture.

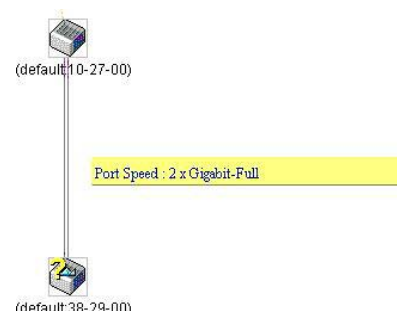

- This version will support switch upload and downloads for firmware, configuration files and log files, as follows:
  - Firmware** – The switch now supports MS firmware downloads from a TFTP server.
  - Configuration Files** – This switch now supports downloading and uploading of configuration files both to (for configuration restoration) and from (for configuration backup) MS's, using a TFTP server.
  - Log** – The Switch now supports uploading MS log files to a TFTP server.
- The user may zoom in and zoom out when utilizing the topology window to get a better, more defined view of the configurations.

## Single IP Settings

The Switch is set as a Candidate (CaS) as the factory default configuration and Single IP Management is disabled.

To enable SIM for the Switch using the Web interface, click **Configuration > Single IP Management > Single IP Settings**:

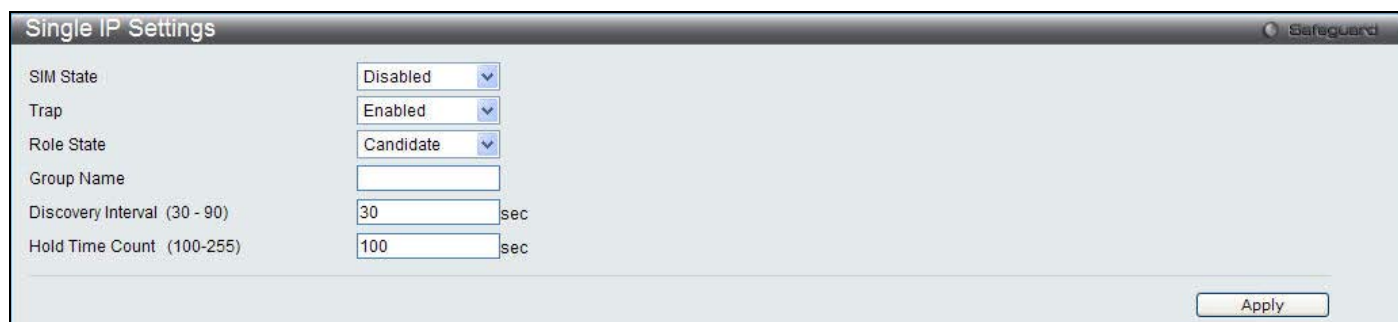

Figure 2 - 47. Single IP Settings window

The following parameters can be configured:

Parameter	Description
<b>SIM State</b>	Use the drop-down menu to either enable or disable the SIM state on the Switch. <i>Disabled</i> will render all SIM functions on the Switch inoperable.
<b>Trap</b>	Use the drop-down menu to either enable or disable a trap. This is designed to control the sending of traps issued from a member switch.
<b>Role State</b>	Use the drop-down menu to change the SIM role of the Switch. The two choices are: <i>Candidate</i> – A Candidate Switch (CaS) is not the member of a SIM group but is connected to a Commander Switch. This is the default setting for the SIM role of the Switch. <i>Commander</i> – Choosing this parameter will make the Switch a Commander Switch (CS). The

	user may join other switches to this Switch, over Ethernet, to be part of its SIM group. Choosing this option will also enable the Switch to be configured for SIM.
<b>Group Name</b>	Enter a Group Name in this textbox. This is optional.
<b>Discovery Interval (30-90)</b>	The user may set the discovery protocol interval, in seconds that the Switch will send out discovery packets. Returning information to a Commander Switch will include information about other switches connected to it. (Ex. MS, CaS). The user may set the Discovery Interval from 30 to 90 seconds. The default value is 30 seconds.
<b>Hold Time Count (100-255)</b>	This parameter may be set for the time, in seconds; the Switch will hold information sent to it from other switches, utilizing the Discovery Interval. The user may set the hold time from 100 to 255 seconds. The default value is 100 seconds.

Click **Apply** to implement the changes. After enabling the Switch to be a Commander Switch (CS), the **Single IP Management** folder will then contain four added links to aid the user in configuring SIM through the web, including **Topology**, **Firmware Upgrade**, **Configuration Backup/Restore** and **Upload Log**.

## Topology

This window will be used to configure and manage the Switch within the SIM group and requires Java script to function properly on your computer.

The Java Runtime Environment on your server should initiate and lead you to the **Topology** window, as seen below.

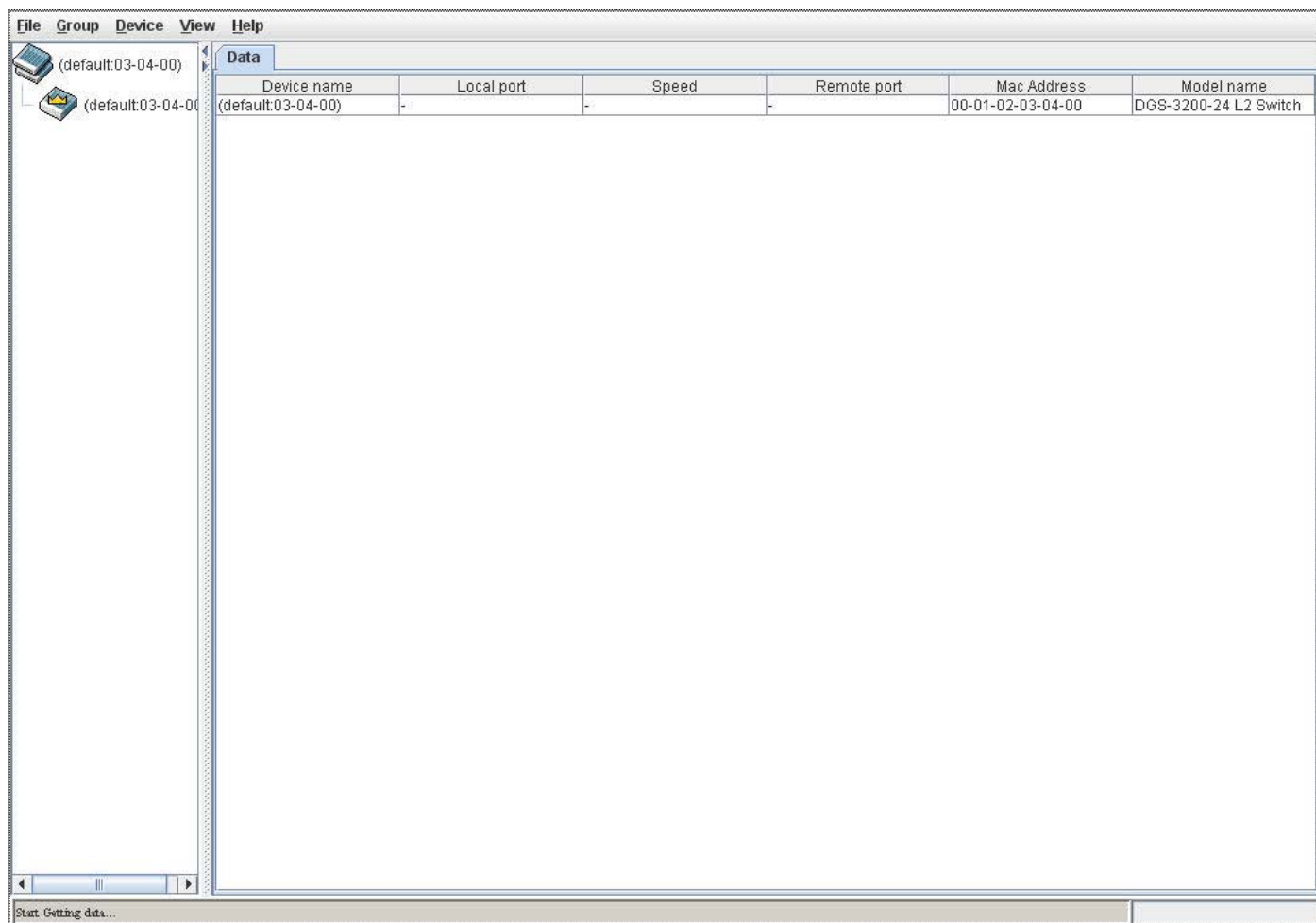

Figure 2 - 48. Topology window

The **Topology** window holds the following information on the **Data** tab:

Parameter	Description
<b>Device Name</b>	This field will display the Device Name of the switches in the SIM group configured by the user.



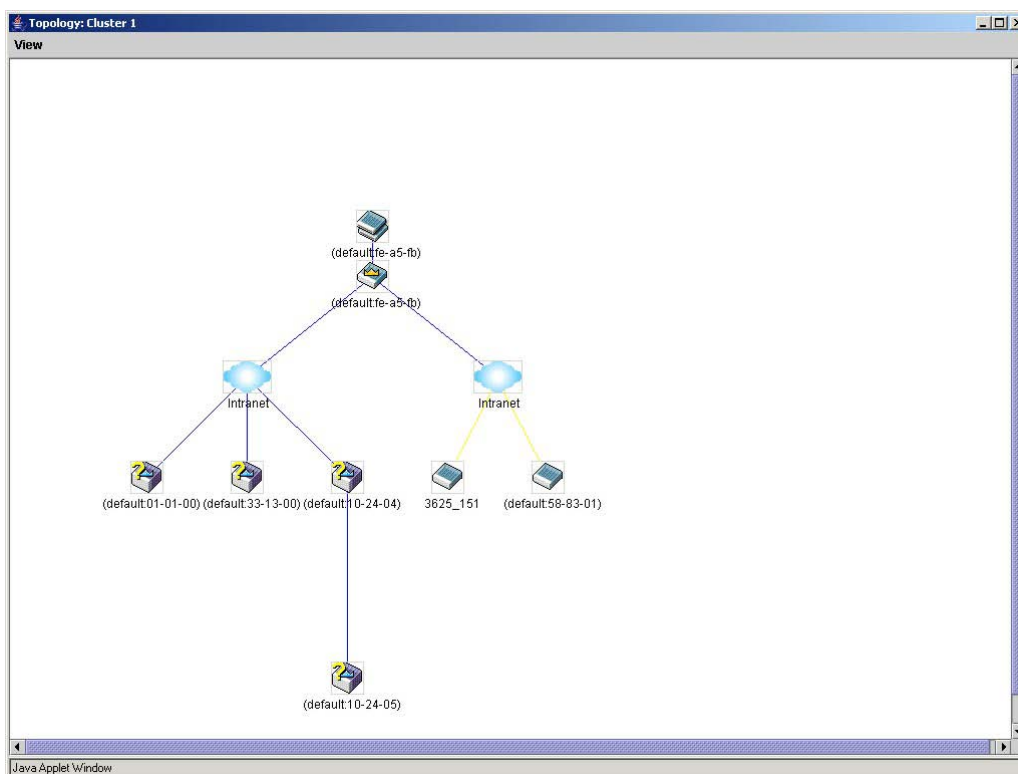

	If no device is configured by the name, it will be given the name default and tagged with the last six digits of the MAC Address to identify it.
<b>Local Port</b>	Displays the number of the physical port on the CS that the MS or CaS is connected to. The CS will have no entry in this field.
<b>Speed</b>	Displays the connection speed between the CS and the MS or CaS.
<b>Remote Port</b>	Displays the number of the physical port on the MS or CaS to which the CS is connected. The CS will have no entry in this field.
<b>MAC Address</b>	Displays the MAC Address of the corresponding Switch.
<b>Model Name</b>	Displays the full Model Name of the corresponding Switch.







To view the **Topology View** window, open the **View** drop-down menu in the toolbar and then click **Topology**, which will open the following Topology Map. This window will refresh itself periodically (20 seconds by default).



**Figure 2 - 49. Topology View window**

This window will display how the devices within the Single IP Management Group connect to other groups and devices. Possible icons on this window are as follows:

Icon	Description
	Group
	Layer 2 commander switch
	Layer 3 commander switch
	Commander switch of other group
	Layer 2 member switch.

	Layer 3 member switch
	Member switch of other group
	Layer 2 candidate switch
	Layer 3 candidate switch
	Unknown device
	Non-SIM devices

## Tool Tips

In the Topology view window, the mouse plays an important role in configuration and in viewing device information. Setting the mouse cursor over a specific device in the topology window (tool tip) will display the same information about a specific device as the Tree view does. See the window below for an example.

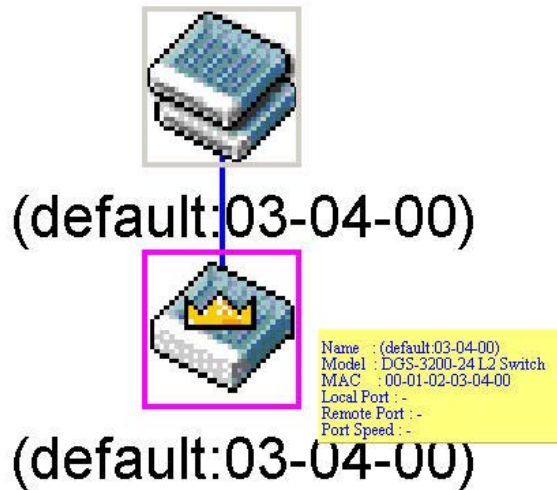

Figure 2 - 50. Device Information Utilizing the Tool Tip

Setting the mouse cursor over a line between two devices will display the connection speed between the two devices, as shown below.





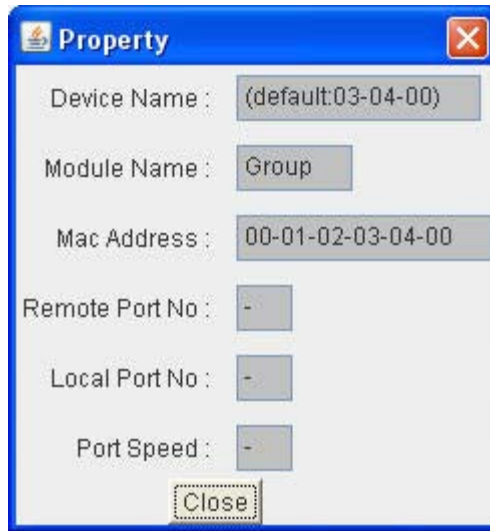

Figure 2 - 53. Property window

Parameter	Description
<b>Device Name</b>	This field will display the Device Name of the switches in the SIM group configured by the user. If no Device Name is configured by the name, it will be given the name default and tagged with the last six digits of the MAC Address to identify it.
<b>Module Name</b>	Displays the full module name of the switch that was right-clicked.
<b>MAC Address</b>	Displays the MAC Address of the corresponding Switch.
<b>Remote Port No.</b>	Displays the number of the physical port on the MS or CaS that the CS is connected to. The CS will have no entry in this field.
<b>Local Port No.</b>	Displays the number of the physical port on the CS that the MS or CaS is connected to. The CS will have no entry in this field.
<b>Port Speed</b>	Displays the connection speed between the CS and the MS or CaS

## Commander Switch Icon

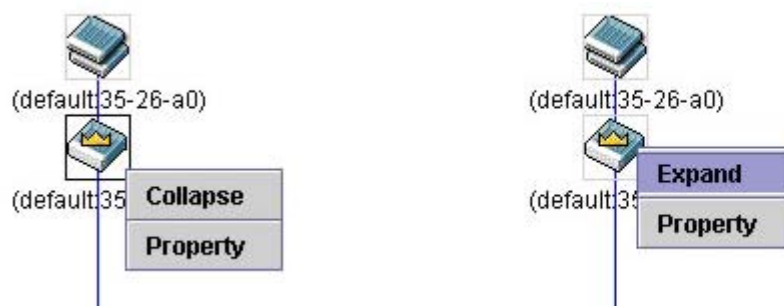

Figure 2 - 54. Right-Clicking a Commander Icon

The following options may appear for the user to configure:

- **Collapse** – To collapse the group that will be represented by a single icon.
- **Expand** – To expand the SIM group, in detail.
- **Property** – To pop up a window to display the group information.

## Member Switch Icon

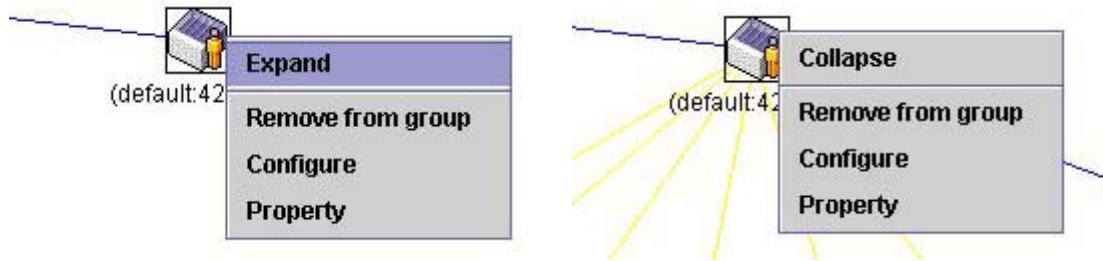

Figure 2 - 55. Right-Clicking a Member icon

The following options may appear for the user to configure:

- **Collapse** – To collapse the group that will be represented by a single icon.
- **Expand** – To expand the SIM group, in detail.
- **Remove from group** – Remove a member from a group.
- **Configure** – Launch the web management to configure the Switch.
- **Property** – To pop up a window to display the device information.

## Candidate Switch Icon

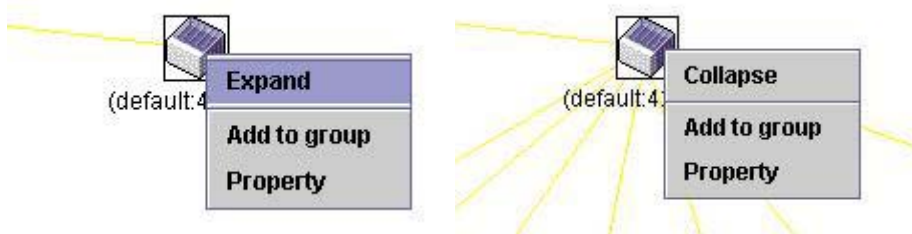

Figure 2 - 56. Right-Clicking a Candidate icon

The following options may appear for the user to configure:

- **Collapse** – To collapse the group that will be represented by a single icon.
- **Expand** – To expand the SIM group, in detail.
- **Add to group** – Add a candidate to a group. Clicking this option will reveal the following dialog box for the user to enter a password for authentication from the Candidate Switch before being added to the SIM group. Click **OK** to enter the password or **Cancel** to exit the dialog box.



Figure 2 - 57. Input password dialog box

- **Property** – To pop up a window to display the device information.

## Menu Bar

The **Single IP Management** window contains a menu bar for device configurations, as seen below.



Figure 2 - 58. Menu Bar of the Topology View

The five menus on the menu bar are as follows.

### File

- **Print Setup** – Will view the image to be printed.
- **Print Topology** – Will print the topology map.
- **Preference** – Will set display properties, such as polling interval, and the views to open at SIM startup.

### Group

- **Add to group** – Add a candidate to a group. Clicking this option will reveal the following dialog box for the user to enter a password for authentication from the Candidate Switch before being added to the SIM group. Click **OK** to enter the password or **Cancel** to exit the dialog box.



Figure 2 - 59. Input password dialog box

- **Remove from Group** – Remove an MS from the group.

### Device

- **Configure** – Will open the Web manager for the specific device.

### View

- **Refresh** – Update the views with the latest status.
- **Topology** – Display the Topology view.

### Help

- **About** – Will display the SIM information, including the current SIM version.

## Firmware Upgrade

The Commander Switch may be used for firmware upgrades of member switches. Member Switches will be listed in the table and will be specified by Port (port on the CS where the MS resides), MAC Address, Model Name and Version. To specify a certain Switch for firmware download, click its corresponding check box under the Port heading. To update the firmware, enter the Server IP Address where the firmware resides and enter the Path/File name of the firmware. Click **Download** to initiate the file transfer.

To view the following window, click **Configuration > Single IP Management > Firmware Upgrade**:

Figure 2 - 60. Firmware Upgrade window for Single IP Management

## Configuration File Backup/Restore

The Commander Switch can instruct configuration file backup and restore to the Member Switch using a TFTP server. Member Switches will be listed in the table and will be specified by Port (port on the CS where the MS resides), MAC Address, Model Name and Version. To specify a certain Switch for upgrading configuration files, click its corresponding radio button under the Port heading. To update the configuration file, enter the Server IP Address where the file resides and enter the Path/File name of the configuration file. Click **Restore** to initiate the file transfer from a TFTP server to the Switch. Click **Backup** to backup the configuration file to a TFTP server.

To view the following window, click **Configuration > Single IP Management > Configuration File Backup/Restore**:

Figure 2 - 61. Configuration File Backup/Restore window for Single IP Management

## Upload Log File

The Commander Switch can order a log file from a member switch sent to a server. Provide the Server IP address for storing the log and the log file path and filename on the member switch. Click **Upload** to send the log file to a TFTP server.

To view the following window, click **Configuration > Single IP Management > Upload Log File**:

Figure 2 - 62. Upload Log File window for Single IP Management

## SD Card FS Settings (DGS-3200-24 Only)

Users can plug an SD flash card into a front slot on the DGS-3200-24 (DGS-3200-10 and DGS-3200-16 do not support this feature). The SD flash card allows users to carry out the following:

- Save the Switch log to the SD card
- Save the Switch configuration to the SD card
- Save the Switch Runtime image to the SD card
- Save the Switch Prom image to the SD card
- Copy images from the SD card to the flash memory on the Switch to replace Runtime image 1 or Runtime image 2
- Copy configuration files from the SD card to the flash memory on the Switch to replace configuration 1 or configuration 2
- Replace the Prom image by copying a Prom image from the SD card to the flash memory
- Download Runtime image and save to the SD card
- Download configuration and save to the SD card
- Access the files on the SD card via a PC (e.g. using Microsoft Windows)
- Boot up the Switch using a runtime image stored on the SD card
- Boot up the Switch using a configuration stored on the SD card
- SD card is hot swappable
- Switch automatically creates new directories and files automatically on the SD card. A warning message will display if there is an existing file or folder with the same name, asking the user to overwrite or keep the existing file or folder

To view the following window, click **Configuration > SD Card FS Settings**:

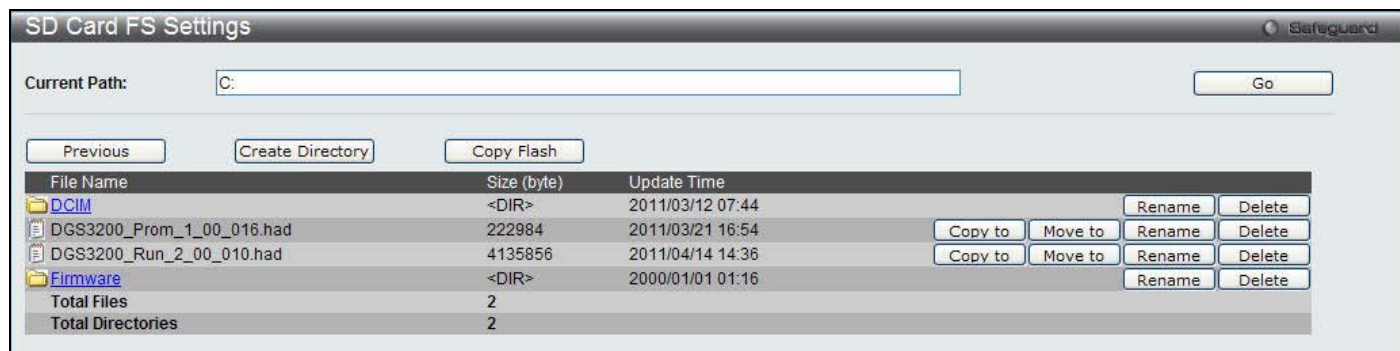

Figure 2 - 63. SD Card FS Settings window

To use a firmware image and configuration on an SD card, carry out the following steps:

1. Insert the SD flash card into the SD card slot on the front of the Switch.
2. Type the path of the firmware image in the **Current Path** field.
3. Click **Go**.

In addition to using a firmware image and configuration from an SD flash card, the SD Card FS Settings window allows users to manage the directories and files stored on the SD card. The table below describes the buttons used to manage the files and directories, stored on the SD flash card.

Parameter	Description
<b>Previous</b>	Click this button to navigate to the previous folder.
<b>Create Directory</b>	Click this button to create a new directory.
<b>Copy Flash</b>	Click this button to copy files from/to the SD Flash card or internal Flash memory.
<b>Format</b>	If you have inserted a new SD Flash card this button will appear.

	Click this button to format the new SD Flash card.
<b>Copy to</b>	Click this button to copy a file to another location.
<b>Move to</b>	Click this button to move a file to another location.
<b>Rename</b>	Click this button to rename the corresponding file or folder.
<b>Delete</b>	Click this button to delete the corresponding file or folder.

## SD Card Management (DGS-3200-24 Only)

### SD Card Backup Settings

This window is used to create a schedule to back up the configuration or log to file system.

To view the following window, click **Configuration > SD Card management > SD Card Backup Settings**:

Figure 2 - 64. SD Card Backup Settings window

The following parameter may be configured:

Parameter	Description
<b>Type</b>	Use the drop-down menu to back up configuration or log.
<b>Time Range Name</b>	Specify the schedule to back up the configuration or log.
<b>File Name</b>	Specify the backup file name.
<b>State</b>	Use the drop-down menu to enable or disable the backup schedule.

Click **Add** to create a new entry. Click **Delete All** to remove all the entries from the table. Click **Edit** to modify the specific entry. Click **Delete** to remove the specific entry.

### SD Card Execute Settings

This window is used to configure a schedule to execute the configuration on file system.

To view the following window, click **Configuration > SD Card management > SD Card Execute Settings**:

Figure 2 - 65. SD Card Execute Settings window

The following parameter may be configured:

Parameter	Description
<b>File Name</b>	The filename of the configuration on file system.
<b>Increment</b>	If this option is specified, the current configuration will not be reset before executing the configuration.
<b>Reset</b>	If this option is specified, the current configuration will be reset before executing the configuration.
<b>Time Range Name</b>	The time range for schedule to execute the configuration.
<b>State</b>	Enable or disable the executive schedules.

Click **Execute** to execute configuration on file system. Click **Add** to create a new entry. Click **Delete All** to remove all the entries from the table. Click **Edit** to modify the specific entry. Click **Delete** to remove the specific entry.

# L2 Features

**VLAN**

**Layer 2 Protocol Tunneling Settings**

**Egress Filter Settings**

**L2 Multicast Control**

**Multicast Filtering**

**Port Mirroring**

**Spanning Tree**

**Link Aggregation**

**Forwarding & Filtering**

**LLDP**

**NLB FDB Settings**

## VLAN

### 802.1Q VLAN

#### Understanding IEEE 802.1p Priority

Priority tagging is a function defined by the IEEE 802.1p standard designed to provide a means of managing traffic on a network where many different types of data may be transmitted simultaneously. It is intended to alleviate problems associated with the delivery of time critical data over congested networks. The quality of applications that are dependent on such time critical data, such as video conferencing, can be severely and adversely affected by even very small delays in transmission.

Network devices that are in compliance with the IEEE 802.1p standard have the ability to recognize the priority level of data packets. These devices can also assign a priority label or tag to packets. Compliant devices can also strip priority tags from packets. This priority tag determines the packet's degree of expeditiousness and determines the queue to which it will be assigned.

Priority tags are given values from 0 to 7 with 0 being assigned to the lowest priority data and 7 assigned to the highest. The highest priority tag 7 is generally only used for data associated with video or audio applications, which are sensitive to even slight delays, or for data from specified end users whose data transmissions warrant special consideration.

The Switch allows you to further tailor how priority tagged data packets are handled on your network. Using queues to manage priority tagged data allows you to specify its relative priority to suit the needs of your network. There may be circumstances where it would be advantageous to group two or more differently tagged packets into the same queue. Generally, however, it is recommended that the highest priority queue, Queue 7, be reserved for data packets with a priority value of 7. Packets that have not been given any priority value are placed in Queue 0 and thus given the lowest priority for delivery.

Strict mode and weighted round robin system are employed on the Switch to determine the rate at which the queues are emptied of packets. The ratio used for clearing the queues is 4:1. This means that the highest priority queue, Queue 7, will clear 4 packets for every 1 packet cleared from Queue 0.

Remember, the priority queue settings on the Switch are for all ports, and all devices connected to the Switch will be affected. This priority queuing system will be especially beneficial if your network employs switches with the capability of assigning priority tags.

## VLAN Description

A Virtual Local Area Network (VLAN) is a network topology configured according to a logical scheme rather than the physical layout. VLANs can be used to combine any collection of LAN segments into an autonomous user group that appears as a single LAN. VLANs also logically segment the network into different broadcast domains so that packets are forwarded only between ports within the VLAN. Typically, a VLAN corresponds to a particular subnet, although not necessarily.



VLANs can enhance performance by conserving bandwidth, and improve security by limiting traffic to specific domains.

A VLAN is a collection of end nodes grouped by logic instead of physical location. End nodes that frequently communicate with each other are assigned to the same VLAN, regardless of where they are physically on the network. Logically, a VLAN can be equated to a broadcast domain, because broadcast packets are forwarded to only members of the VLAN on which the broadcast was initiated.

## Notes about VLANs on the Switch

- No matter what basis is used to uniquely identify end nodes and assign these nodes VLAN membership, packets cannot cross VLANs without a network device performing a routing function between the VLANs.
- The Switch supports IEEE 802.1Q VLANs. The port untagging function can be used to remove the 802.1Q tag from packet headers to maintain compatibility with devices that are tag-unaware.
- The Switch's default is to assign all ports to a single 802.1Q VLAN named "default."
- The "default" VLAN has a VID = 1.
- The member ports of Port-based VLANs may overlap, if desired.

## IEEE 802.1Q VLANs

Some relevant terms:

- **Tagging** – The act of putting 802.1Q VLAN information into the header of a packet.
- **Untagging** – The act of stripping 802.1Q VLAN information out of the packet header.
- **Ingress port** – A port on a switch where packets are flowing into the Switch and VLAN decisions must be made.
- **Egress port** – A port on a switch where packets are flowing out of the Switch, either to another switch or to an end station, and tagging decisions must be made.

IEEE 802.1Q (tagged) VLANs are implemented on the Switch. 802.1Q VLANs require tagging, which enables them to span the entire network (assuming all switches on the network are IEEE 802.1Q-compliant).

VLANs allow a network to be segmented in order to reduce the size of broadcast domains. All packets entering a VLAN will only be forwarded to the stations (over IEEE 802.1Q enabled switches) that are members of that VLAN, and this includes broadcast, multicast and unicast packets from unknown sources.

VLANs can also provide a level of security to your network. IEEE 802.1Q VLANs will only deliver packets between stations that are members of the VLAN.

Any port can be configured as either tagging or untagging. The untagging feature of IEEE 802.1Q VLANs allows VLANs to work with legacy switches that don't recognize VLAN tags in packet headers. The tagging feature allows VLANs to span multiple 802.1Q-compliant switches through a single physical connection and allows Spanning Tree to be enabled on all ports and work normally.

The IEEE 802.1Q standard restricts the forwarding of untagged packets to the VLAN the receiving port is a member of.

The main characteristics of IEEE 802.1Q are as follows:

- Assigns packets to VLANs by filtering.
- Assumes the presence of a single global spanning tree.
- Uses an explicit tagging scheme with one-level tagging.
- 802.1Q VLAN Packet Forwarding
- Packet forwarding decisions are made based upon the following three types of rules:
- Ingress rules – rules relevant to the classification of received frames belonging to a VLAN.
- Forwarding rules between ports – decides whether to filter or forward the packet.
- Egress rules – determines if the packet must be sent tagged or untagged.

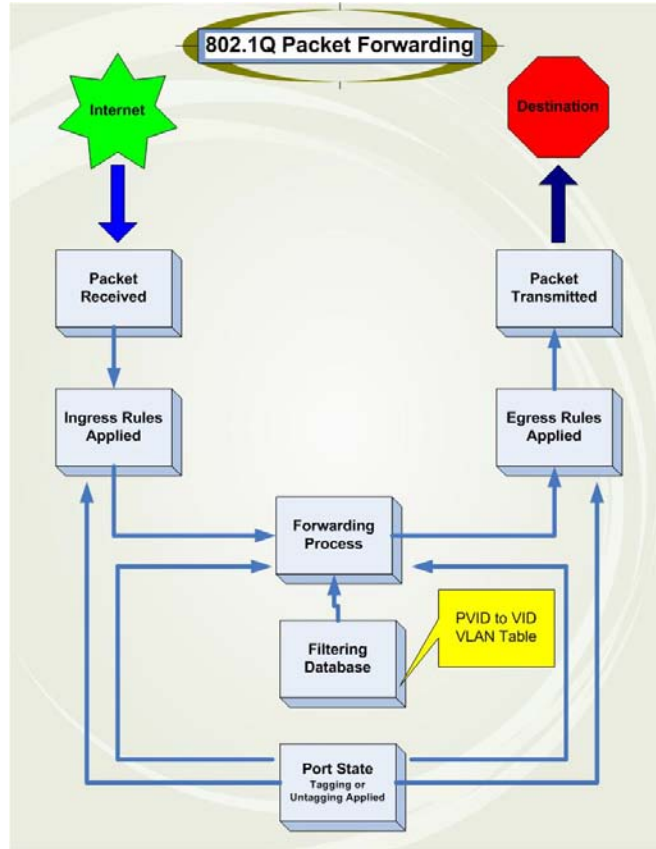

Figure 3 - 1. IEEE 802.1Q Packet Forwarding

## 802.1Q VLAN Tags

The figure below shows the 802.1Q VLAN tag. There are four additional octets inserted after the source MAC address. Their presence is indicated by a value of 0x8100 in the EtherType field. When a packet's EtherType field is equal to 0x8100, the packet carries the IEEE 802.1Q/802.1p tag. The tag is contained in the following two octets and consists of 3 bits of user priority, 1 bit of Canonical Format Identifier (CFI – used for encapsulating Token Ring packets so they can be carried across Ethernet backbones), and 12 bits of VLAN ID (VID). The 3 bits of user priority are used by 802.1p. The VID is the VLAN identifier and is used by the 802.1Q standard. Because the VID is 12 bits long, 4094 unique VLANs can be identified.

The tag is inserted into the packet header making the entire packet longer by 4 octets. All of the information originally contained in the packet is retained.

### IEEE 802.1Q Tag

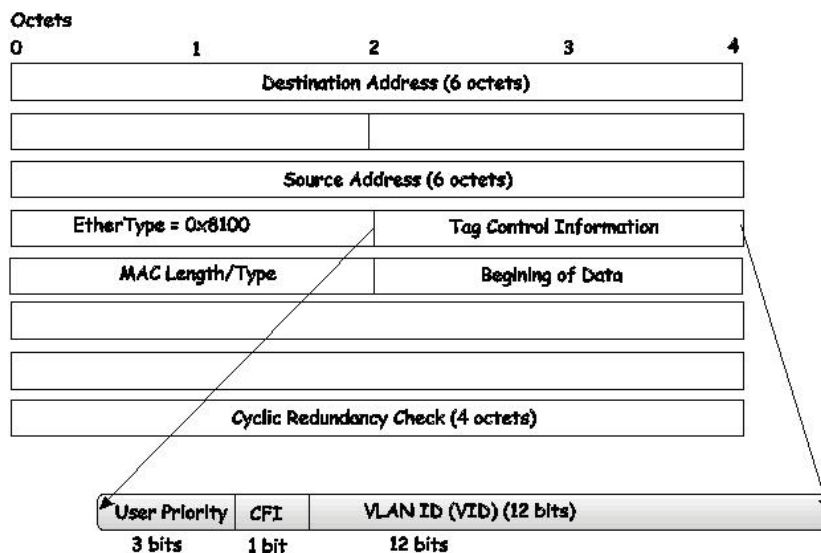

Figure 3 - 2. IEEE 802.1Q Tag

The EtherType and VLAN ID are inserted after the MAC source address, but before the original EtherType/Length or Logical Link Control. Because the packet is now a bit longer than it was originally, the Cyclic Redundancy Check (CRC) must be recalculated.

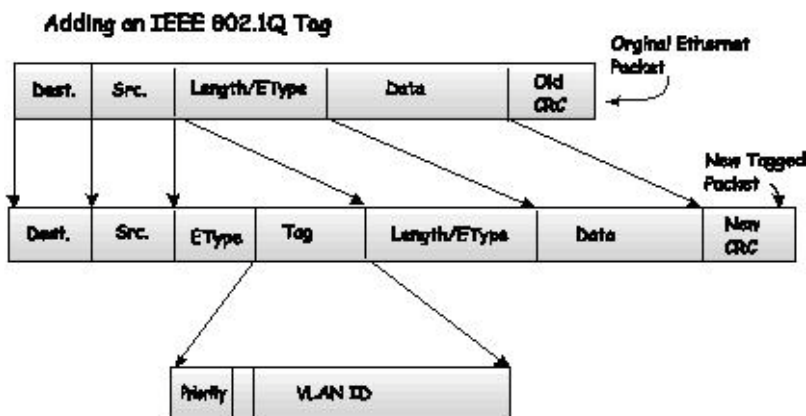

Figure 3 - 3. Adding an IEEE 802.1Q Tag

## Port VLAN ID

Packets that are tagged (are carrying the 802.1Q VID information) can be transmitted from one 802.1Q compliant network device to another with the VLAN information intact. This allows 802.1Q VLANs to span network devices (and indeed, the entire network, if all network devices are 802.1Q compliant).

Unfortunately, not all network devices are 802.1Q compliant. These devices are referred to as tag-unaware. 802.1Q devices are referred to as tag-aware.

Prior to the adoption of 802.1Q VLANs, port-based and MAC-based VLANs were in common use. These VLANs relied upon a Port VLAN ID (PVID) to forward packets. A packet received on a given port would be assigned that port's PVID and then be forwarded to the port that corresponded to the packet's destination address (found in the Switch's forwarding table). If the PVID of the port that received the packet is different from the PVID of the port that is to transmit the packet, the Switch will drop the packet.

Within the Switch, different PVIDs mean different VLANs (remember that two VLANs cannot communicate without an external router). So, VLAN identification based upon the PVIDs cannot create VLANs that extend outside a given switch (or switch stack).

Every physical port on a switch has a PVID. 802.1Q ports are also assigned a PVID, for use within the Switch. If no VLANs are defined on the Switch, all ports are then assigned to a default VLAN with a PVID equal to 1. Untagged packets are assigned the PVID of the port on which they were received. Forwarding decisions are based upon this PVID, in so far as VLANs are concerned. Tagged packets are forwarded according to the VID contained within the tag. Tagged packets are also assigned a PVID, but the PVID is not used to make packet-forwarding decisions, the VID is.

Tag-aware switches must keep a table to relate PVIDs within the Switch to VIDs on the network. The Switch will compare the VID of a packet to be transmitted to the VID of the port that is to transmit the packet. If the two VIDs are different, the Switch will drop the packet. Because of the existence of the PVID for untagged packets and the VID for tagged packets, tag-aware and tag-unaware network devices can coexist on the same network.

A switch port can have only one PVID, but can have as many VIDs as the Switch has memory in its VLAN table to store them.

Because some devices on a network may be tag-unaware, a decision must be made at each port on a tag-aware device before packets are transmitted – should the packet to be transmitted have a tag or not? If the transmitting port is connected to a tag-unaware device, the packet should be untagged. If the transmitting port is connected to a tag-aware device, the packet should be tagged.

## Tagging and Untagging

Every port on an 802.1Q compliant switch can be configured as tagging or untagging.

Ports with tagging enabled will put the VID number, priority and other VLAN information into the header of all packets that flow into and out of it. If a packet has previously been tagged, the port will not alter the packet, thus keeping the VLAN information

intact. Other 802.1Q compliant devices on the network to make packet-forwarding decisions can then use the VLAN information in the tag.

Ports with untagging enabled will strip the 802.1Q tag from all packets that flow into and out of those ports. If the packet doesn't have an 802.1Q VLAN tag, the port will not alter the packet. Thus, all packets received by and forwarded by an untagging port will have no 802.1Q VLAN information. (Remember that the PVID is only used internally within the Switch). Untagging is used to send packets from an 802.1Q-compliant network device to a non-compliant network device.

## Ingress Filtering

A port on a switch where packets are flowing into the Switch and VLAN decisions must be made is referred to as an ingress port. If ingress filtering is enabled for a port, the Switch will examine the VLAN information in the packet header (if present) and decide whether or not to forward the packet.

If the packet is tagged with VLAN information, the ingress port will first determine if the ingress port itself is a member of the tagged VLAN. If it is not, the packet will be dropped. If the ingress port is a member of the 802.1Q VLAN, the Switch then determines if the destination port is a member of the 802.1Q VLAN. If it is not, the packet is dropped. If the destination port is a member of the 802.1Q VLAN, the packet is forwarded and the destination port transmits it to its attached network segment.

If the packet is not tagged with VLAN information, the ingress port will tag the packet with its own PVID as a VID (if the port is a tagging port). The switch then determines if the destination port is a member of the same VLAN (has the same VID) as the ingress port. If it does not, the packet is dropped. If it has the same VID, the packet is forwarded and the destination port transmits it on its attached network segment.

This process is referred to as ingress filtering and is used to conserve bandwidth within the Switch by dropping packets that are not on the same VLAN as the ingress port at the point of reception. This eliminates the subsequent processing of packets that will just be dropped by the destination port.

## Default VLANs

The Switch initially configures one VLAN, VID = 1, called "default." The factory default setting assigns all ports on the Switch to the "default." As new VLANs are configured in Port-based mode, their respective member ports are removed from the "default."

Packets cannot cross VLANs. If a member of one VLAN wants to connect to another VLAN, the link must be through an external router.



**NOTE:** If no VLANs are configured on the Switch, then all packets will be forwarded to any destination port. Packets with unknown source addresses will be flooded to all ports. Broadcast and multicast packets will also be flooded to all ports.

An example is presented below:

VLAN Name	VID	Switch Ports
System (default)	1	5, 6, 7
Engineering	2	9, 10
Sales	5	1, 2, 3, 4

Table 3 - 1. VLAN Example – Assigned Ports

## Port-based VLANs

Port-based VLANs limit traffic that flows into and out of switch ports. Thus, all devices connected to a port are members of the VLAN(s) the port belongs to, whether there is a single computer directly connected to a switch, or an entire department.

On port-based VLANs, NICs do not need to be able to identify 802.1Q tags in packet headers. NICs send and receive normal Ethernet packets. If the packet's destination lies on the same segment, communications take place using normal Ethernet protocols. Even though this is always the case, when the destination for a packet lies on another switch port, VLAN considerations come into play to decide if the packet gets dropped by the Switch or delivered.

## VLAN Segmentation

Take for example a packet that is transmitted by a machine on Port 1 that is a member of VLAN 2. If the destination lies on another port (found through a normal forwarding table lookup), the Switch then looks to see if the other port (Port 10) is a member of VLAN 2 (and can therefore receive VLAN 2 packets). If Port 10 is not a member of VLAN 2, then the packet will be dropped by the Switch and will not reach its destination. If Port 10 is a member of VLAN 2, the packet will go through. This selective forwarding feature based on VLAN criteria is how VLANs segment networks. The key point being that Port 1 will only transmit on VLAN 2.

## VLAN and Trunk Groups

The members of a trunk group have the same VLAN setting. Any VLAN setting on the members of a trunk group will apply to the other member ports.



**NOTE:** In order to use VLAN segmentation in conjunction with port trunk groups, first set the port trunk group(s), and then configure the VLAN settings. To change the port trunk grouping with VLANs already in place it is unnecessary to reconfigure the VLAN settings after changing the port trunk group settings. VLAN settings will automatically change in conjunction with the change of the port trunk group settings.

To view the following window, click **L2 Features > VLAN > 802.1Q VLAN**:

VID	VLAN Name	Advertisement	Tagged Ports	Untagged Ports	Forbidden Ports
1	default	Enabled		1,2,3,4, 5,6,7,8, 9,10,11,12...	

**Figure 3 - 4. VLAN List tab of the 802.1Q VLAN window**

The **VLAN List** tab lists all previously configured VLANs by VLAN ID and VLAN Name. To delete an existing 802.1Q VLAN, click the corresponding **Delete** button.

To create a new 802.1Q VLAN or modify an existing 802.1Q VLAN, click the **Add/Edit VLAN** tab. A new tab will appear, as shown below, to configure the port settings and to assign a unique name and number to the new VLAN. See the table on the next page for a description of the parameters in the new window.

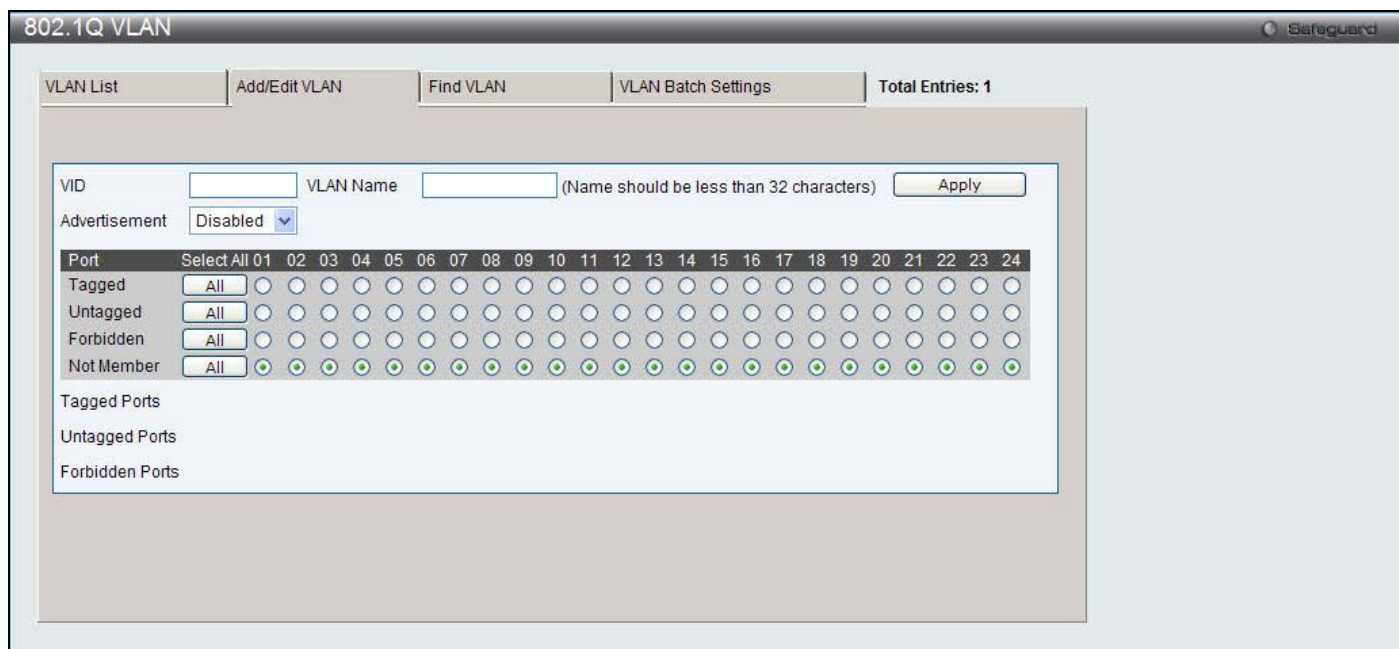

Figure 3 - 5. Add/Edit VLAN tab of the 802.1Q VLAN window

The following fields can then be set in the **Add/Edit VLAN** tab:

Parameter	Description
<b>VID (VLAN ID)</b>	Allows the entry of a VLAN ID or displays the VLAN ID of an existing VLAN in the <b>Add/Edit VLAN</b> tab. VLANs can be identified by either the VID or the VLAN name.
<b>VLAN Name</b>	Allows the entry of a name for the new VLAN or for editing the VLAN name in the <b>Add/Edit VLAN</b> tab.
<b>Advertisement</b>	Enabling this function will allow the Switch to send out GVRP packets to outside sources, notifying that they may join the existing VLAN.
<b>Port</b>	Shows all ports of the Switch for the 802.1Q configuration option.
<b>Tagged</b>	Specifies the port as 802.1Q tagging. Clicking the radio button will designate the port as tagged.
<b>Untagged</b>	Specifies the port as 802.1Q untagged. Clicking the radio button will designate the port as untagged.
<b>Forbidden</b>	Click the radio button to specify the port as not being a member of the VLAN and that the port is forbidden from becoming a member of the VLAN dynamically.
<b>Not Member</b>	Click the radio button to allow an individual port to be specified as a non-VLAN member.

Click **Apply** to implement changes made.

To search for a VLAN, click the **Find VLAN** tab. A new tab will appear, as shown below. Enter the VLAN ID number in the field offered and then click the **Find** button. You will be redirected to the **VLAN List** tab. See the table on the next page for a description of the parameters in the new window.

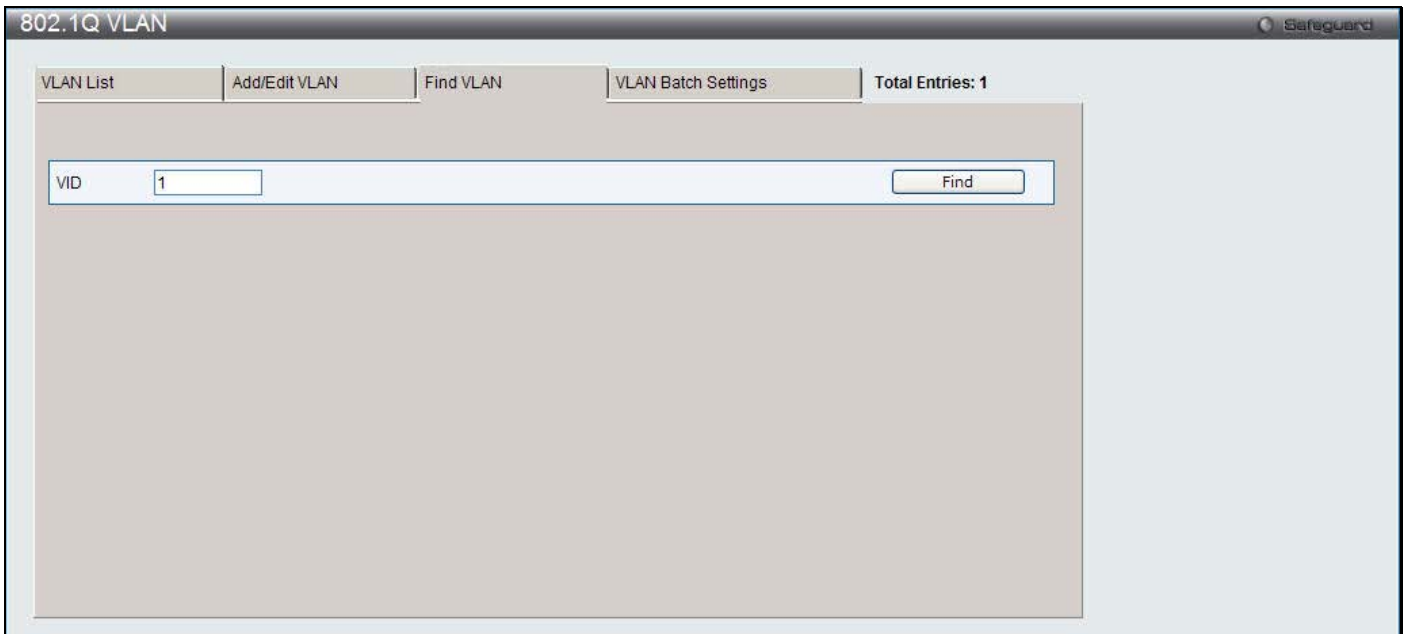

Figure 3 - 6. Find VLAN tab of the 802.1Q VLAN window

To create a VLAN Batch entry click the **VLAN Batch Settings** tab, as shown below.

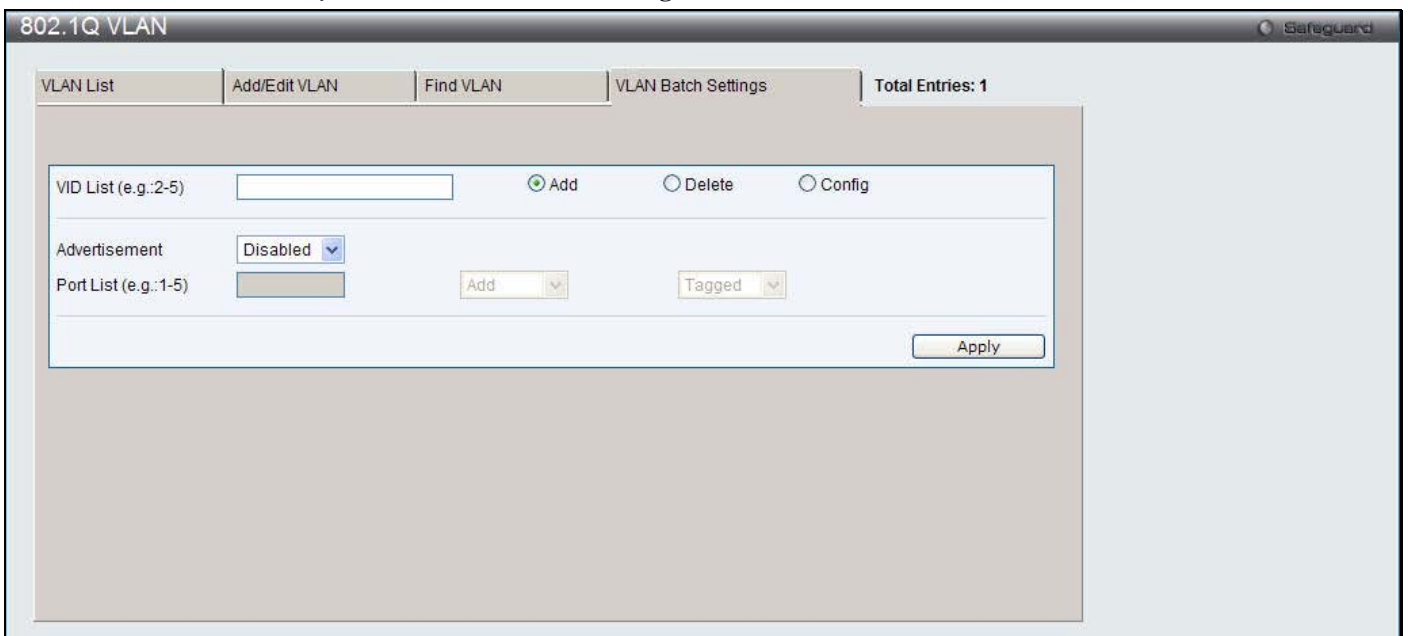

Figure 3 - 7. VLAN Batch Settings tab of the 802.1Q VLAN window

The following fields can be set in the **VLAN Batch Settings** windows:

Parameter	Description
<b>VID List (e.g.: 2-5)</b>	Enter a VLAN ID List that can be added, deleted or configured.
<b>Advertisement</b>	Enabling this function will allow the Switch to send out GVRP packets to outside sources, notifying that they may join the existing VLAN.
<b>Port List (e.g.: 1-5)</b>	Allows an individual port list to be added or deleted as a member of the VLAN.
<b>Tagged</b>	Specifies the port as 802.1Q tagged. Use the drop-down menu to designate the port as tagged.

<b>Untagged</b>	Specifies the port as 802.1Q untagged. Use the drop-down menu to designate the port as untagged.
<b>Forbidden</b>	Specifies the port as not being a member of the VLAN and that the port is forbidden from becoming a member of the VLAN dynamically. Use the drop-down menu to designate the port as forbidden.

Click **Apply** to implement changes made.



**NOTE:** The Switch supports up to 4k static VLAN entries.

## 802.1v Protocol VLAN

The **802.1v Protocol VLAN** folder contains two windows: **802.1v Protocol Group Settings** and **802.1v Protocol VLAN Settings**.

### 802.1v Protocol Group Settings

Users can create Protocol VLAN groups and add protocols to that group. The 802.1v Protocol VLAN Group Settings support multiple VLANs for each protocol and allows the user to configure the untagged ports of different protocols on the same physical port. For example, it allows the user to configure an 802.1Q and 802.1v untagged port on the same physical port. The lower half of the table displays any previously created groups.

To view the following window, click **L2 Features > VLAN > 802.1v Protocol VLAN > 802.1v Protocol Group Settings**:

**Figure 3 - 8. 802.1v Protocol Group Settings window**

The following fields can be set:

Parameter	Description
<b>Group ID</b>	Select an ID number for the group, between 1 and 8.
<b>Group Name</b>	This is used to identify the new Protocol VLAN group. Type an alphanumeric string of up to 32 characters.
<b>Protocol</b>	This function maps packets to protocol-defined VLANs by examining the type octet within the packet header to discover the type of protocol associated with it. Use the drop-down menu to toggle between <i>Ethernet II</i> , <i>IEEE802.3 LLC</i> , and <i>IEEE802.3 SNAP</i> .
<b>Protocol Value</b>	Enter a value for the Group. The protocol value is used to identify a protocol of the frame type specified. The form of the input is 0x0 to 0xffff. Depending on the frame type, the octet string will have one of the following values: For Ethernet II, this is a 16-bit (2-octet) hex value. For example, IPv4 is 800, IPv6 is 86dd, ARP is 806, etc. For IEEE802.3 SNAP, this is this is a 16-



bit (2-octet) hex value. For IEEE802.3 LLC, this is the 2-octet IEEE 802.2 Link Service Access Point (LSAP) pair. The first octet is for Destination Service Access Point (DSAP) and the second octet is for Source.

Click **Add** to make a new entry. Click **Delete All** to remove an entry. Click **Delete Settings** to remove the configuration from the specific entry. Click **Delte Group** to remove the specific entry from the group.

## 802.1v Protocol VLAN Settings

Users can configure Protocol VLAN settings. The lower half of the table displays any previously created settings.

To view the following window, click **L2 Features > VLAN > 802.1v Protocol VLAN > 802.1v Protocol VLAN Settings**:

VID	VLAN Name	1v Group ID	1P Priority	Port
1	default	1	-	1
1	default	1	-	2
1	default	1	-	3
1	default	1	-	4
1	default	1	-	5

Figure 3 - 9. 802.1v Protocol VLAN Settings window

The following fields can be set:

Parameter	Description
<b>Group ID</b>	Highlight the corresponding RADIUS button to select a previously configured Group ID from the drop-down menu.
<b>Group Name</b>	Highlight the corresponding RADIUS button to select a previously configured Group Name from the drop-down menu.
<b>VID (1-4094)</b>	Highlight the RADIUS button to enter the VID. This is the VLAN ID that, along with the VLAN Name, identifies the VLAN the user wishes to create.
<b>VLAN Name</b>	Highlight the RADIUS button to enter a VLAN Name. This is the VLAN Name that, along with the VLAN ID, identifies the VLAN the user wishes to create.
<b>802.1p Priority</b>	<p>This parameter is specified if you want to re-write the 802.1p default priority previously set in the Switch, which is used to determine the CoS queue to which packets are forwarded to. Once this field is specified, packets accepted by the Switch that match this priority are forwarded to the CoS queue specified previously by the user.</p> <p>Click the corresponding box if you want to set the 802.1p default priority of a packet to the value entered in the Priority (0-7) field, which meets the criteria specified previously in this command, before forwarding it on to the specified CoS queue. Otherwise, a packet will have its incoming 802.1p user priority re-written to its original value before being forwarded by the Switch.</p> <p>For more information on priority queues, CoS queues and mapping for 802.1p, see the QoS section of this manual.</p>
<b>Port List</b>	Select the specified ports you wish to configure by entering the port number in this field, or tick the Select All Ports check box.

<b>Search Port List</b>	This function allows the user to search all previously configured port list settings and display them on the lower half of the table.
-------------------------	---

Click **Add** to create a new entry. To search for a port list enter the port number you wish to view and click **Find**. To display all previously configured port lists on the bottom half of the screen click the **Show All** button, to clear all previously configured lists click the **Delete All** button. Click **Delete** to remove the specific entry.

## GVRP Settings

Users can determine whether the Switch will share its VLAN configuration information with other GARP VLAN Registration Protocol (GVRP) enabled switches. In addition, Ingress Checking can be used to limit traffic by filtering incoming packets whose PVID does not match the PVID of the port. Results can be seen in the table under the configuration settings.

To view the following window, click **L2 Features > VLAN > GVRP Settings**:

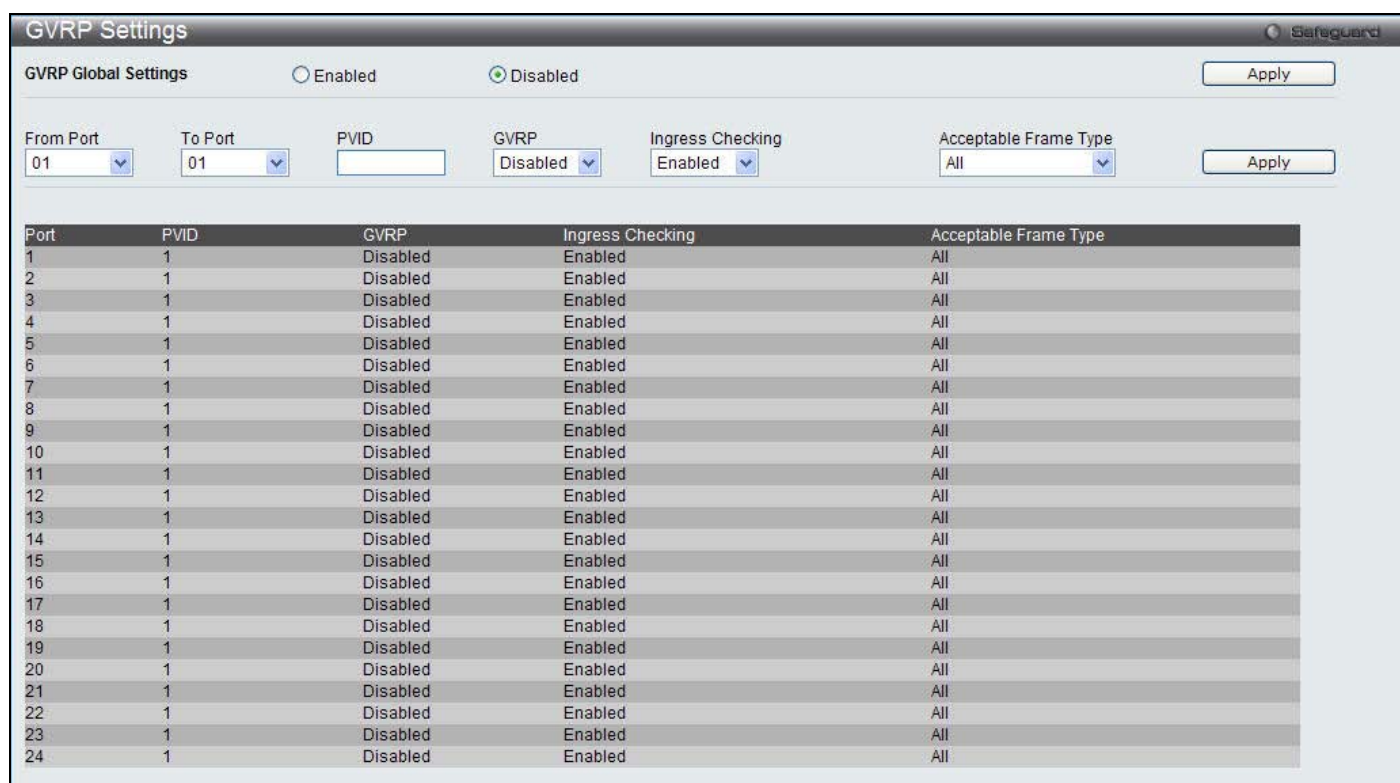

Figure 3 - 10. GVRP Settings window

The following fields can be set:

Parameter	Description
<b>GVRP Global Settings</b>	Click the radio buttons to enable or disable GVRP settings.
<b>From Port / To Port</b>	Use the drop-down menus to select a range of ports that will be included in the Port-based VLAN.
<b>PVID</b>	This field is used to manually assign a PVID to a VLAN. The Switch's default is to assign all ports to the default VLAN with a VID of 1. The PVID is used by the port to tag outgoing, untagged packets, and to make filtering decisions about incoming packets. If the port is specified to accept only tagged frames - as tagging, and an untagged packet is forwarded to the port for transmission, the port will add an 802.1Q tag using the PVID to write the VID in the tag. When the packet arrives at its destination, the receiving device will use the PVID to make VLAN forwarding decisions. If the port receives a packet, and Ingress filtering is <i>Enabled</i> , the port will compare the VID of the incoming packet to its PVID. If the two are unequal, the port will drop the packet. If the two are equal, the port will receive the packet.
<b>GVRP</b>	The GARP VLAN Registration Protocol (GVRP) enables the port to dynamically become a member of a VLAN. GVRP is <i>Disabled</i> by default.

<b>Ingress Checking</b>	This drop-down menu allows the user to enable the port to compare the VID tag of an incoming packet with the PVID number assigned to the port. If the two are different, the port filters (drops) the packet. <i>Disabled</i> disables ingress filtering. Ingress checking is <i>Enabled</i> by default.
<b>Acceptable Frame Type</b>	This field denotes the type of frame that will be accepted by the port. The user may choose between <i>Tagged Only</i> , which means only VLAN tagged frames will be accepted, and <i>All</i> , which mean both tagged and untagged frames will be accepted. <i>All</i> is enabled by default.

Click **Apply** to implement changes made.

## MAC-based VLAN Settings

Users can create new MAC-based VLAN entries and search, edit, and delete existing entries. When an entry is created for a port, the port will automatically become the untagged member port of the specified VLAN. When a static MAC-based VLAN entry is created for a user, the traffic from this user will be able to be serviced under the specified VLAN regardless of the authentication function operating on this port.

To view the following window, click **L2 Features > VLAN > MAC-based VLAN Settings**:

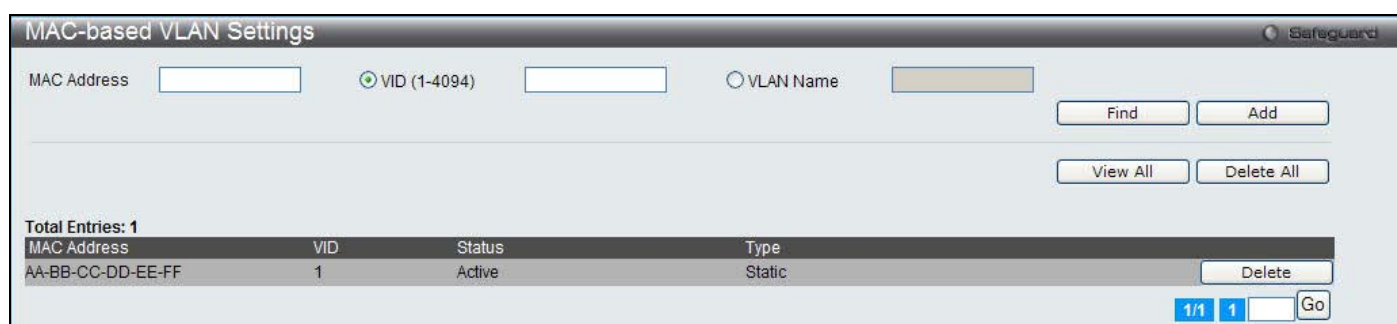

**Figure 3 - 11. MAC-based VLAN Settings window**

The following fields can be set:

Parameter	Description
<b>MAC Address</b>	Specify the MAC address to be reauthenticated by entering it into the MAC Address field.
<b>VID (1-4094)</b>	Click this button and enter the VLAN ID.
<b>VLAN Name</b>	Enter the VLAN name of a previously configured VLAN.

Click **Find** to search for the information entered. Click **Add** to add the entry. Click **View All** to see all the entries. Click **Delete All** to remove all the entries. Click **Delete** to remove the specific entry.

## Private VLAN Settings

The Switch allows users to create private VLANs. A private VLAN divides the Layer 2 broadcast domain of a VLAN into subdomains and are particularly useful for service providers who need to assign a unique VLAN to each of their customers. Each subdomain is made up of several pairs of private VLANs, with each private VLAN pair consisting of a primary and secondary VLAN. All of the VLAN pairs in a private VLAN domain are members of the same primary VLAN. Each subdomain is identified using the secondary VLAN ID.

The diagram below illustrates the structure of a Private VLAN domain:

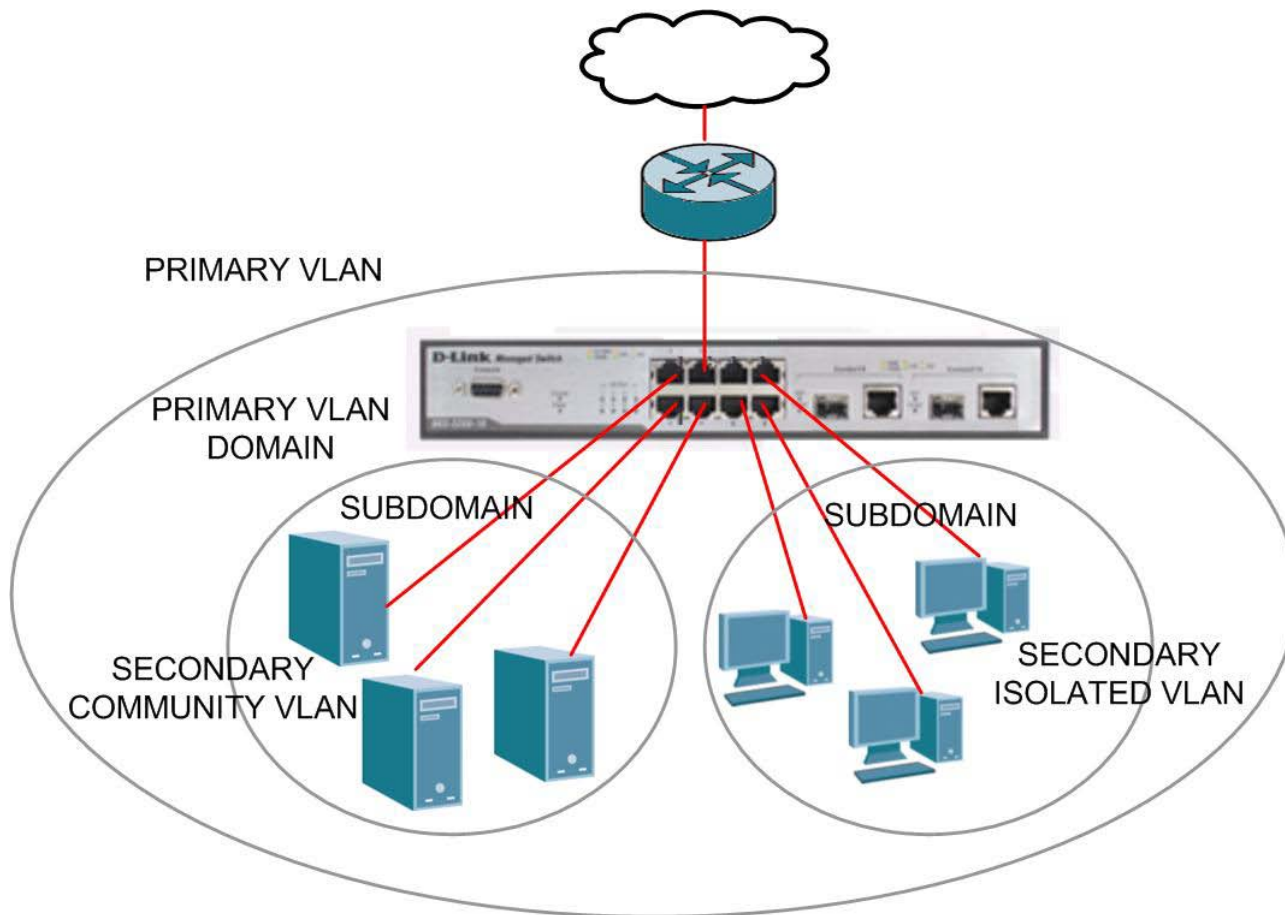

Figure 3 - 12. Private VLAN domain

The ports in a private VLAN can be one of the following three types:

Port Type	Description
<b>Promiscuous</b>	A promiscuous port is a port that is a member of a primary VLAN that can communicate with all interfaces, including ports that have been configured as community and isolated ports on secondary VLANs that are associated with the primary VLAN.
<b>Isolated</b>	An isolated port is used to describe a host port that is a member of an isolated secondary VLAN. An isolated port is completely isolated at Layer 2 from other ports within the same private VLAN domain, apart from promiscuous ports. All traffic destined to isolated ports is blocked, except for traffic originating from promiscuous ports. Any traffic originating from an isolated port is only forwarded to promiscuous ports.
<b>Community</b>	A community port is used to describe a host port that is a member of a community secondary VLAN. A community port can communicate with both ports that are members of the same community VLAN and promiscuous ports. Interfaces that are configured as community ports are isolated at Layer 2 from all other interfaces that are members of a different community and from isolated ports that are members of the same private VLAN domain.

To view the following window, click **L2 Features > VLAN > Private VLAN Settings**:

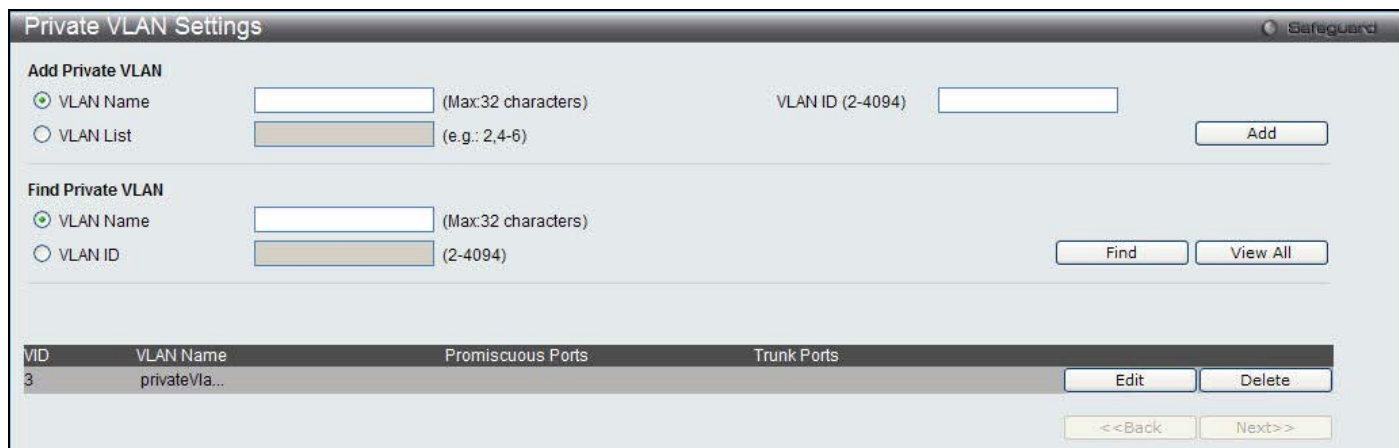

Figure 3 - 13. Private VLAN Settings window

The following parameters can be configured:

Parameter	Description
VLAN Name	Click the radio button and enter the name of the private VLAN.
VLAN ID (2-4094)	Specify the VLAN ID of the Private VLAN.
VLAN List	Specify a list of VLAN IDs.

Click **Add** to create the new Private VLAN entry. Click **Find** to search for the specific information entered. Click **View All** to see all the entries. Click **Edit** to configure the specific entry. Click **Delete** to remove the specific entry.

Click **Edit** to see the following window.

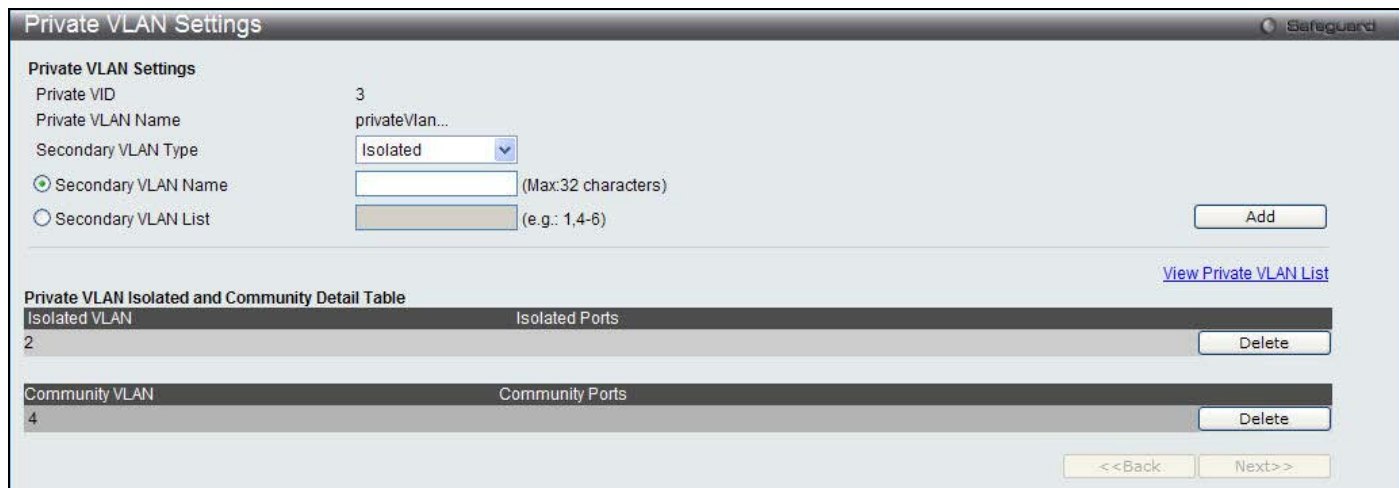

Figure 3 - 14. Private VLAN Settings - Edit window

The following parameters can be configured:

Parameter	Description
Secondary VLAN Type	Use the drop-down menu to specify the Secondary VLAN Type. The available options are described below:  <i>Isolated</i> - An Isolated VLAN is a secondary VLAN whose distinctive characteristic is that all hosts connected to its ports are isolated at Layer 2. The primary advantage of an isolated VLAN is that it allows a Private VLAN to only use two VLAN identifiers to provide port isolation and serve any number of end users. A Private VLAN can only support one isolated VLAN.

	<i>Community-</i> A Community VLAN is a secondary VLAN that is associated with a group of ports that connects to a certain "community" of end devices with mutual trust relationships. There can be multiple distinct community VLANs in a Private VLAN domain.
<b>Secondary VLAN Name</b>	Click the radio button and enter the secondary VLAN name.
<b>Secondary VLAN List</b>	Click the radio button and enter a list of VLAN IDs.

Click **Add** to create a new entry. Click **Delete** to remove the specific entry.

## PVID Auto Assign Settings

Users can enable or disable PVID Auto Assign Status. The default setting is enabled.

To view the following window, click **L2 Features > VLAN > PVID Auto Assign Settings**:

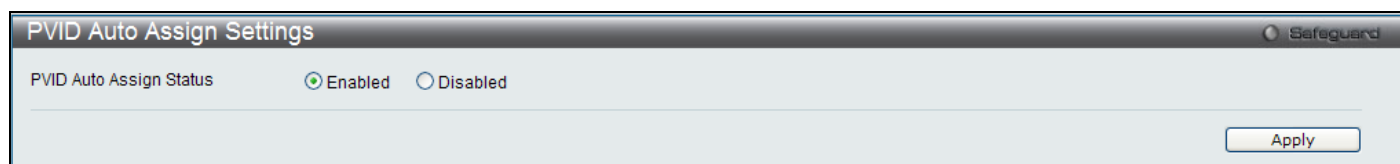

Figure 3 - 15. PVID Auto Assign Settings window

Click **Apply** to implement the changes made. Please see the previous section for more information about PVIDs.

## Voice VLAN

### Voice VLAN Global Settings

This window is used to enable the global voice VLAN function on the Switch.

To view the following window, click **L2 Features > VLAN > Voice VLAN > Voice VLAN Global Settings**:



Figure 3 - 16. Voice VLAN Global Settings window

The following parameters can be configured:

Parameter	Description
<b>Voice VLAN State</b>	Click to enable or disable the voice VLAN state.
<b>Voice VLAN Name</b>	Specify the name of the voice VLAN.
<b>Voie VID (1-4094)</b>	Specify the VLAN ID of the voice VLAN.

<b>Priority</b>	Specify the priority of the voice VLAN.
<b>Aging Time (1-65535)</b>	Specify the aging time between 1 and 65535 minutes.
<b>Log State</b>	Use the drop-down menu to enable the voice VLAN log state.

Click **Apply** to implement the changes made.

## Voice VLAN Port Settings

This window is used to configure the voice VLAN ports.

To view the following window, click **L2 Features > VLAN > Voice VLAN > Voice VLAN Port Settings**:

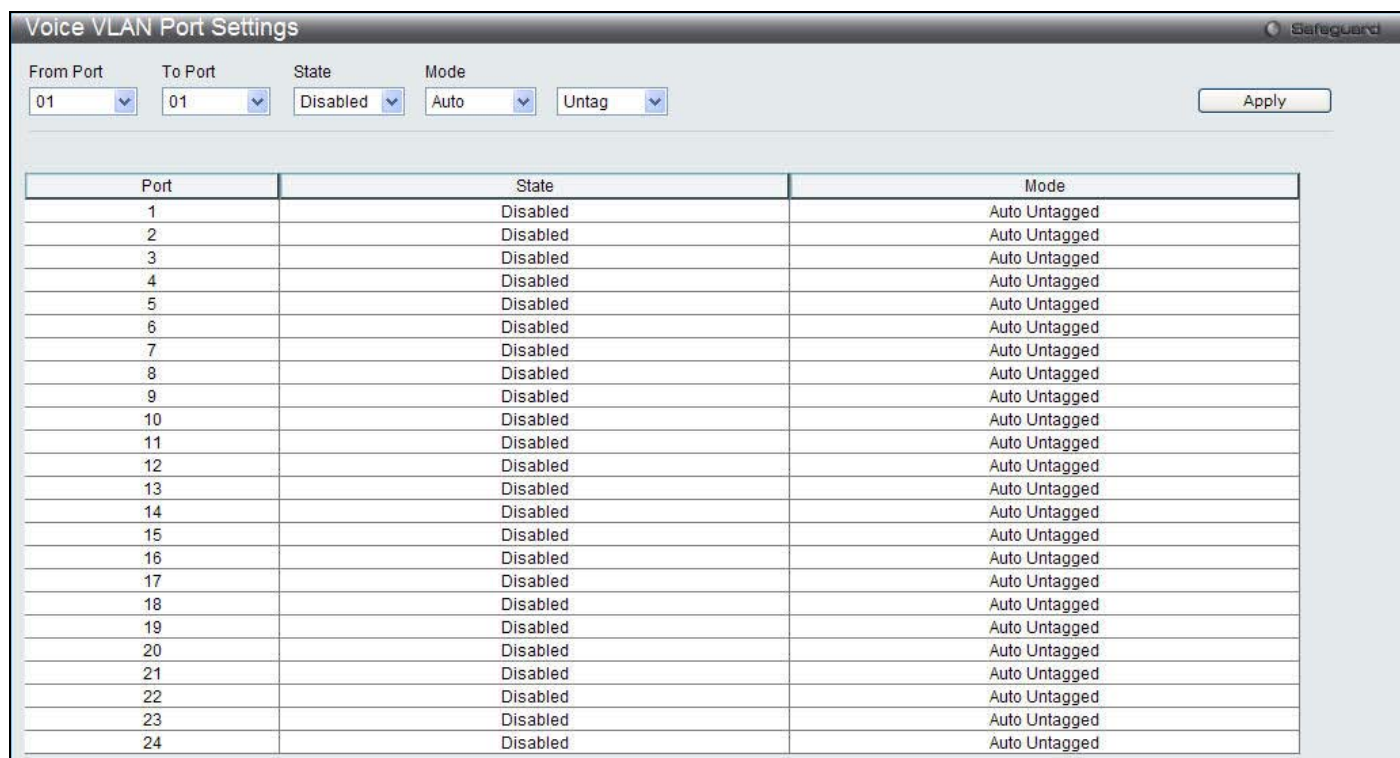

**Figure 3 - 17. Voice VLAN Port Settings window**

The following parameters can be configured:

Parameter	Description
<b>From Port / To Port</b>	Use the drop-down menus to select a range of ports to be configured.
<b>State</b>	Use the drop-down menu to enable or disable the voice VLAN function state on ports.
<b>Mode</b>	<p>Specify the voice VLAN mode.</p> <p><i>Auto</i> - When the mode is auto, the port may become the voice VLAN member port by auto-learning. If the MAC address of the received packet matches the configured OUI, the port will be learned as dynamic member port. The dynamic membership will be removed via the aging out mechanism.</p> <p><i>Tag</i> - Specify the port to join the voice VLAN as a tagged member.</p> <p><i>Untag</i> - Specify the port to join the voice VLAN as an untagged member.</p> <ul style="list-style-type: none"> <li>When the port is working in auto tagged mode, and learns about a voice device through the device's OUI, it will join the voice VLAN as a tagged member automatically. When the voice device sends voice VLAN tagged packets, the switch will change its priority. When the voice device sends untagged packets, it will</li> </ul>

	<p>forward them to port's PVID VLAN.</p> <ul style="list-style-type: none"> <li>• When the port is working in auto untagged mode, and the port captures a voice device through the device's OUI, it will join the voice VLAN as an untagged member automatically. When the voice device sends voice VLAN, tagged packets, the switch will change its priority. Should the voice device send untagged packets, the switch will assign priority to those and add the voice VLAN ID into this packet</li> <li>• When the switch receives LLDP-MED packets, it checks the VLAN ID, tagged flag and priority flag. The switch should follow the tagged flag and priority setting.</li> </ul> <p><i>Manual</i> - When the mode is set to manual, the port needs to be manually added into or removed from the voice VLAN by 802.1Q VLAN configuration command.</p>
--	--

Click **Apply** to implement the changes made.

## Voice VLAN OUI Settings

This window is used to configure the user-defined voice traffic's OUI.

To view the following window, click **L2 Features > VLAN > Voice VLAN > Voice VLAN OUI Settings**:

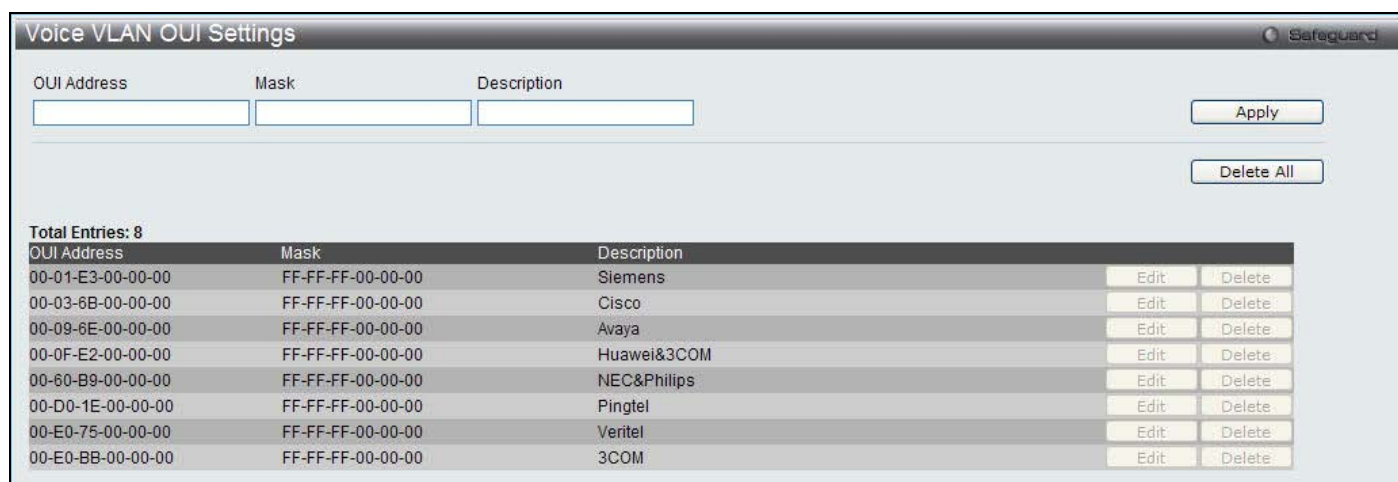

Figure 3 - 18. Voice VLAN OUI Settings window

The following parameters can be configured:

Parameter	Description
<b>OUI Address</b>	Specify a user-defined OUI MAC address.
<b>Mask</b>	Specify a user-defined OUI MAC address mask.
<b>Description</b>	Specify a description for the user-defined OUI.

Click **Apply** to implement the changes made. Click **Delete All** to remove all the user-defined entries. Click **Edit** to configure the specific entry. Click **Delete** to remove the specific entry.

## Voice VLAN Device

This window is used to show voice devices that are connected to the ports.

To view the following window, click **L2 Features > VLAN > Voice VLAN > Voice VLAN Device**:

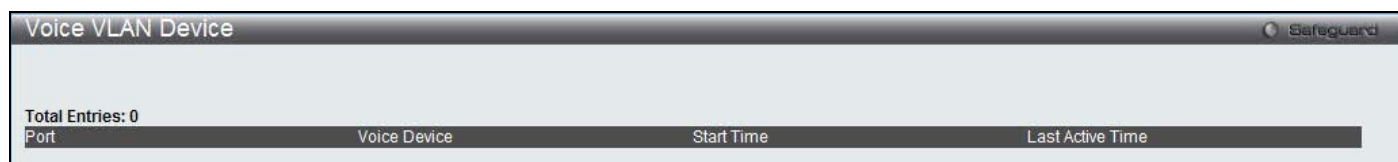



Figure 3 - 19. Voice VLAN Device window

## Voice VLAN LLDP-MED Voice Device

This window is used to show the voice devices being discovered by the LLDP-MED.

To view the following window, click **L2 Features > VLAN > Voice VLAN > Voice VLAN LLDP-MED Voice Device**:

Voice VLAN LLDP-MED Voice Device							
Total Entries: 0							
Index	Local Port	Chassis ID Subtype	Chassis ID	Port ID Subtype	Port ID	Create Time	Remain Time

Figure 3 - 20. Voice VLAN LLDP-MED Voice Device window

## VLAN Trunk Settings

Enable VLAN on a port to allow frames belonging to unknown VLAN groups to pass through that port. This is useful if you want to set up VLAN groups on end devices without having to configure the same VLAN groups on intermediary devices.

Refer to the following figure for an illustrated example. Suppose you want to create VLAN groups 1 and 2 (V1 and V2) on devices A and B. Without a VLAN Trunk, you must first configure VLAN groups 1 and 2 on all intermediary switches C, D and E; otherwise they will drop frames with unknown VLAN group tags. However, with VLAN Trunk enabled on a port(s) in each intermediary switch, you only need to create VLAN groups in the end devices (A and B). C, D and E automatically allow frames with VLAN group tags 1 and 2 (VLAN groups that are unknown to those switches) to pass through their VLAN trunking port(s).

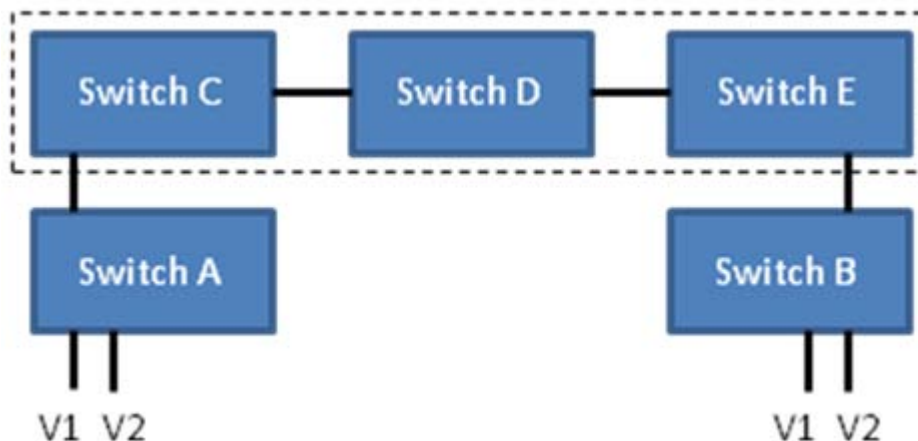

Users can combine a number of VLAN ports together to create VLAN trunks. To create VLAN Trunk Port settings on the Switch, select the ports to be configured, change the VLAN Trunk Global State to Enabled, and click **Apply**, the new settings will appear in the VLAN Trunk Settings table in the lower part of the window.

To view the following window, click **L2 Features > VLAN > VLAN Trunk Settings**:

VLAN Trunk Settings													
VLAN Trunk Global State												Apply	
<input type="radio"/> Enabled <input checked="" type="radio"/> Disabled												Apply	
VLAN Trunk Settings													
Port	01	02	03	04	05	06	07	08	09	10	11	12	Apply
	<input type="checkbox"/>	<input type="checkbox"/>	<input type="checkbox"/>	<input type="checkbox"/>	<input type="checkbox"/>	<input type="checkbox"/>	<input type="checkbox"/>	<input type="checkbox"/>	<input type="checkbox"/>	<input type="checkbox"/>	<input type="checkbox"/>	<input type="checkbox"/>	
	13	14	15	16	17	18	19	20	21	22	23	24	
	<input type="checkbox"/>	<input type="checkbox"/>	<input type="checkbox"/>	<input type="checkbox"/>	<input type="checkbox"/>	<input type="checkbox"/>	<input type="checkbox"/>	<input type="checkbox"/>	<input type="checkbox"/>	<input type="checkbox"/>	<input type="checkbox"/>	<input type="checkbox"/>	
Ports													

Figure 3 - 21. VLAN Trunk Settings window

The following parameters can be configured:

Parameter	Description
<b>VLAN Trunk Global State</b>	Use the radio buttons to <i>Enable</i> or <i>Disable</i> the VLAN trunking global state.
<b>Ports</b>	The ports to be configured.

Click **Apply** to implement the changes made.

## Browse VLAN

This window is used to display the VLAN status.

To view the following window, click **L2 Features > VLAN > Browse VLAN**:

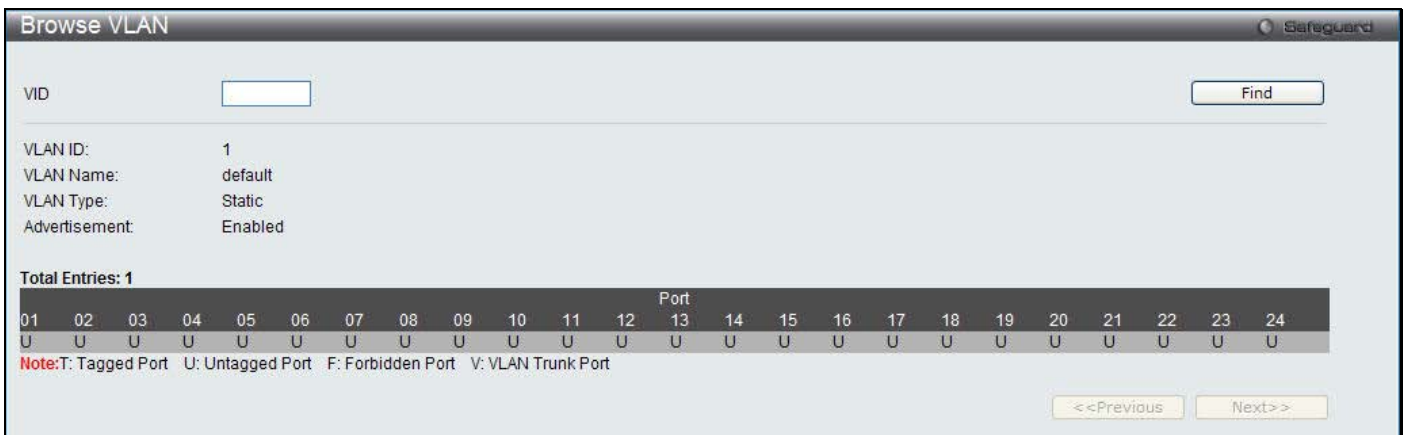

**Figure 3 - 22. Browse VLAN window**

Enter a VLAN ID in **VID** field and click **Find** to display the VLAN status.

## Layer 2 Protocol Tunneling Settings

This window is used to configure Layer 2 protocol tunneling settings.

To view the following window, click **L2 Features > Layer 2 Protocol Tunneling Settings**:



**Figure 3 - 23. Layer 2 Protocol Tunneling Settings window**

The following parameters can be configured:

Parameter	Description
<b>Layer 2 Protocol Tunneling State</b>	Click to enable or disable the Layer 2 protocol tunneling state.

<b>From Port / To Port</b>	Use the drop-down menus to select a range of ports to be configured.
<b>Type</b>	Specify the type of the ports. <i>UNI</i> - Specify the ports as UNI ports. <i>NNI</i> - Specify the ports as NNI ports. <i>None</i> - Disable tunnel on it.
<b>Tunneled Protocol</b>	Specify tunneled protocols on the UNI ports. <i>STP</i> - Specify to use the STP protocol. <i>GVRP</i> - Specify to use the GVRP protocol. <i>Protocol MAC</i> - Specify the destination MAC address of the L2 protocol packets that will tunneled on these UNI ports. The MAC address can be 01-00-0C-CC-CC-CC or 01-00-0C-CC-CC-CD. <i>All</i> - All tunnel-abled Layer 2 protocols will be tunneled on the ports.
<b>Threshold (0-65535)</b>	Specify the drop threshold for packets-per-second accepted on the UNI ports. The ports drop the PDU if the protocol's threshold is exceeded.

Click **Apply** to implement the changes made.

## Egress Filter Settings

Users can configure an egress filter on specific ports for unknown unicast and unregistered multicast packets.

The Switch drops all unknown unicast/multicast packets on egress ports when it detects unknown unicast/multicast packets for egress ports. Therefore, a user can select which port is permitted or not permitted to receive unknown unicast/multicast packets.

To view the following window, click **L2 Features > Egress Filter Settings**:

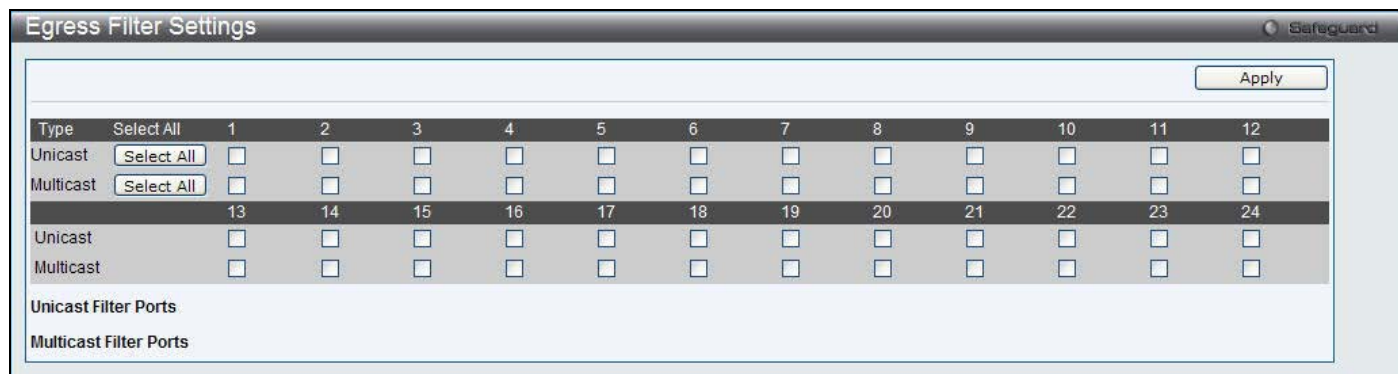

Figure 3 - 24. Egress Filter Settings window

The following fields can then be set:

Parameter	Description
<b>Unicast</b>	Select ports to filter unknown unicast packets. These packets will not be forwarded to those ports. Unselected ports will not filter unknown unicast packets and the packets may be forwarded to those ports.
<b>Multicast</b>	Select ports to filter unregistered multicast packets. These packets will not be forwarded to those ports. Unselected ports will not filter unregistered multicast packets and the packets may be forwarded to those ports.

Click **Apply** to implement changes made.

## L2 Multicast Control

## IGMP Snooping

Internet Group Management Protocol (IGMP) snooping allows the Switch to recognize IGMP queries and reports sent between network stations or devices and an IGMP host. When enabled for IGMP snooping, the Switch can open or close a port to a specific device based on IGMP messages passing through the Switch.

### IGMP Snooping Settings

In order to use IGMP Snooping it must first be enabled for the entire Switch under IGMP Global Settings at the top of the window. You may then fine-tune the settings for each VLAN by clicking the corresponding **Edit** button. When enabled for IGMP snooping, the Switch can open or close a port to a specific multicast group member based on IGMP messages sent from the device to the IGMP host or vice versa. The Switch monitors IGMP messages and discontinues forwarding multicast packets when there are no longer hosts requesting that they continue.

To view the following window, click **L2 Features > L2 Multicast Control > IGMP Snooping > IGMP Snooping Settings**:



Figure 3 - 25. IGMP Snooping Settings window

The following parameters may be viewed or configured:

Parameter	Description
<b>IGMP Snooping State</b>	Click the radio button to enable or disable the IGMP snooping state.
<b>Max Learned Entry Value (1-256)</b>	Specify the maximum number of groups that can be learned by the data driven mechanism.
<b>VID (VLAN ID)</b>	This is the VLAN ID that, along with the VLAN Name, identifies the VLAN the user wishes to modify the IGMP Snooping Settings for.
<b>VLAN Name</b>	This is the VLAN Name that, along with the VLAN ID, identifies the VLAN the user wishes to modify the IGMP Snooping Settings for.
<b>State</b>	Select <i>Enabled</i> to implement IGMP Snooping. This field is <i>Disabled</i> by default.
<b>Parameter Settings</b>	Click the <b>Edit</b> button next to the VLAN you want to edit the IGMP Snooping parameters for.

Click **Apply** to implement changes made. Click the **Edit** button to configure the IGMP Snooping Parameters Settings.

Click the [Modify Router Port](#) link to configure the IGMP Snooping Router Port Settings.

Click the **Edit** button to see the following window:

**Figure 3 - 26. IGMP Snooping Parameters Settings window**

The following parameters can be configured:

Parameter	Description
<b>Query Interval (1-65535)</b>	This parameter specifies the length of time between sending IGMP Queries. Default= 125.
<b>Max Response Time (1-25)</b>	This parameter is used to set the maximum amount of time allowed before sending an IGMP response report. Default= 10.
<b>Robustness Value (1-7)</b>	This parameter is used as a tuning variable that allows for a large number of packets being lost on subnetworks. Specify a value between 1 and 255. Specify a high value if you expect your subnetworks to lose a large number of packets. Default= 2.
<b>Last Member Query Interval (1-25)</b>	This parameter is used to set the maximum amount of time between group-specific query messages, including messages that have been sent in response to leave group messages. Default= 2.
<b>Data Driven Group Expiry Time (1-65535)</b>	Specify the data driven group lifetime in seconds.
<b>Querier State</b>	Choose <i>Enabled</i> from the drop-down menu to enable the transmission of IGMP Query Packets or choose <i>Disabled</i> to disable. Default = <i>Disabled</i> .
<b>Fast Leave</b>	Choose <i>Enabled</i> from the drop-down menu to enable the Fast Leave function or choose <i>Disabled</i> to disable. If Fast Leave is <i>Enabled</i> , the membership will immediately be removed when the system receives an IGMP leave message.
<b>State</b>	Use the drop-down menu to <i>Enable</i> or <i>Disable</i> the IGMP Snooping feature for the specified VLAN.
<b>Report Suppression</b>	Use the drop-down menu to enable or disable report suppression function. The Switch uses IGMP report suppression to forward only one IGMP report per multicast router query to multicast devices.
<b>Data Driven Learning State</b>	Use the drop-down menu to enable or disable the data driven learning of an IGMP snooping group.
<b>Data Driven Learning Aged Out</b>	Use the drop-down menu to enable or disable the aging on the entry.
<b>Version</b>	Use the drop-down menu to specify the version of IGMP packets that will be sent by the specified ports. If an IGMP packet received by the interface has a version higher than the specified version, the packet will be dropped.

After setting the above parameters, click the **Apply** button in the top section of the window to allow your changes to be implemented. Click the <<**Back** button to discard the changes made and return to the previous page.

Click the [Modify Router Port](#) link to see the following window:

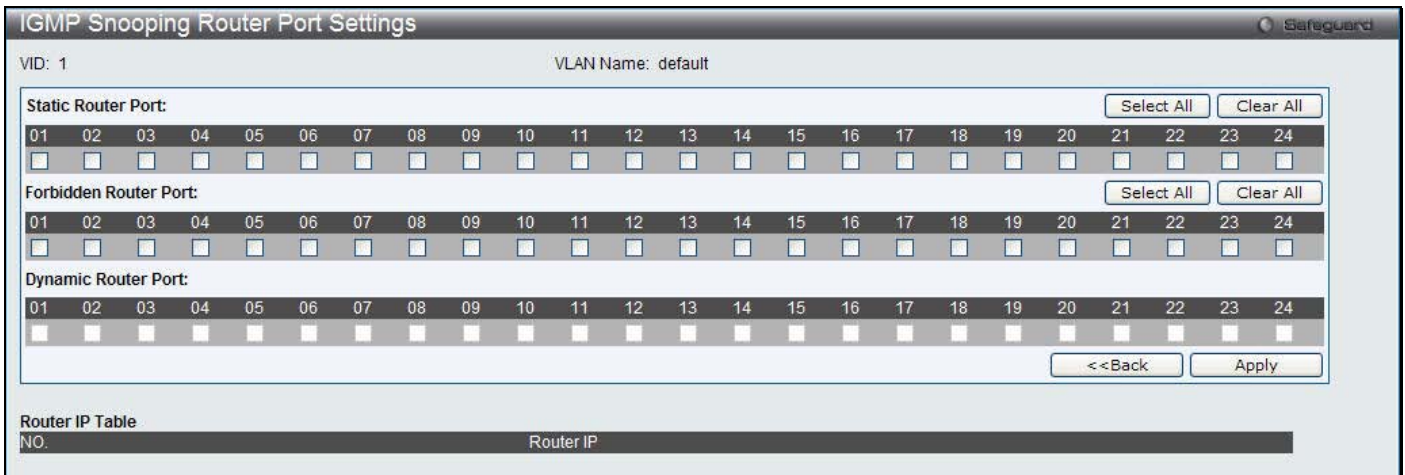

Figure 3 - 27. IGMP Snooping Router Port Settings window

The following parameters can be configured:

Parameter	Description
<b>Static Router Port</b>	This section is used to designate a range of ports as being connected to multicast-enabled routers. This will ensure that all packets with such a router as its destination will reach the multicast-enabled router regardless of the protocol.
<b>Forbidden Router Port</b>	This section is used to designate a range of ports as being not connected to multicast-enabled routers. This ensures that the forbidden router port will not propagate routing packets out.
<b>Dynamic Router Port</b>	Displays router ports that have been dynamically configured.

Click the **Select All** button to select all the ports for configuration. Click the **Clear All** button to unselect all the ports for configuration. Click the **Apply** button to accept the changes made. Click the **<<Back** button to discard the changes made and return to the previous page.

## IGMP Snooping Rate Limit Settings

This window is used to configure the IGMP snooping rate limit parameters.

To view the following window, click **L2 Features > L2 Multicast Control > IGMP Snooping > IGMP Snooping Rate Limit Settings**:

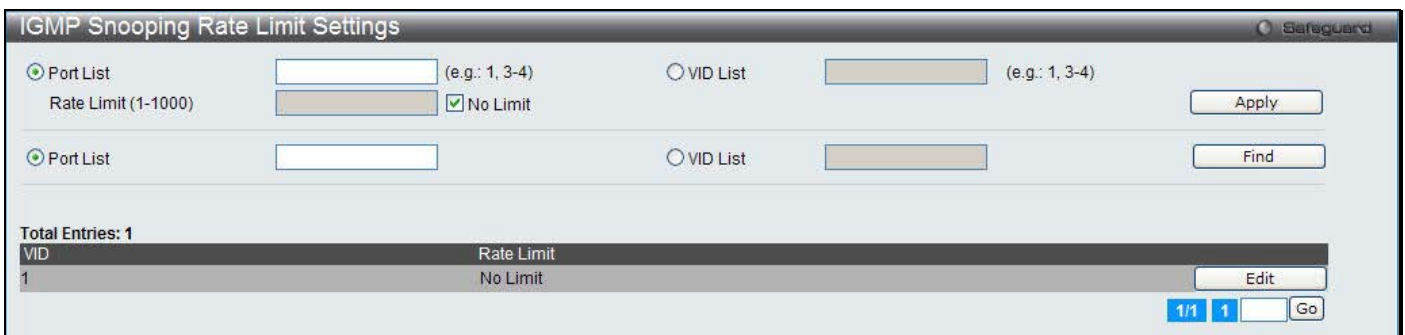

Figure 3 - 28. IGMP Snooping Rate Limit Settings window

The following parameters can be configured:

Parameter	Description
<b>Port List</b>	Enter the port list used for this configuration.
<b>VID List</b>	Enter the VID list used for this configuration.

<b>Rate Limit (1-1000)</b>	Enter the IGMP snooping rate limit used. By selecting the <b>No Limit</b> check box, the rate limit for the entered port(s) will be ignored.
----------------------------	--

Click the **Apply** button to accept the changes made. Click the **Find** button to locate a specific entry based on the information entered. Click the **Edit** button to re-configure the specific entry. Enter a page number and click the **Go** button to navigate to a specific page when multiple pages exist.

## IGMP Snooping Static Group Settings

This window is used to view the Switch’s IGMP Snooping Group Table. IGMP Snooping allows the Switch to read the Multicast Group IP address and the corresponding MAC address from IGMP packets that pass through the Switch.

To view the following window, click **L2 Features > L2 Multicast Control > IGMP Snooping > IGMP Snooping Static Group Settings**:



**Figure 3 - 29. IGMP Snooping Static Group Settings window**

The following parameters can be configured:

Parameter	Description
<b>VLAN Name</b>	The VLAN name of the multicast group.
<b>VID List</b>	The VID list of the multicast group.
<b>IPv4 Address</b>	Enter the IPv4 address.

Click the **Find** button to locate a specific entry based on the information entered. Click the **Create** button to add a new entry based on the information entered. Click the **Delete** button to remove the specific entry based on the information entered. Click the **View All** button to display all the existing entries. Click the **Edit** button to re-configure the specific entry. Enter a page number and click the **Go** button to navigate to a specific page when multiple pages exist.

Click the **Edit** button to see the following window.

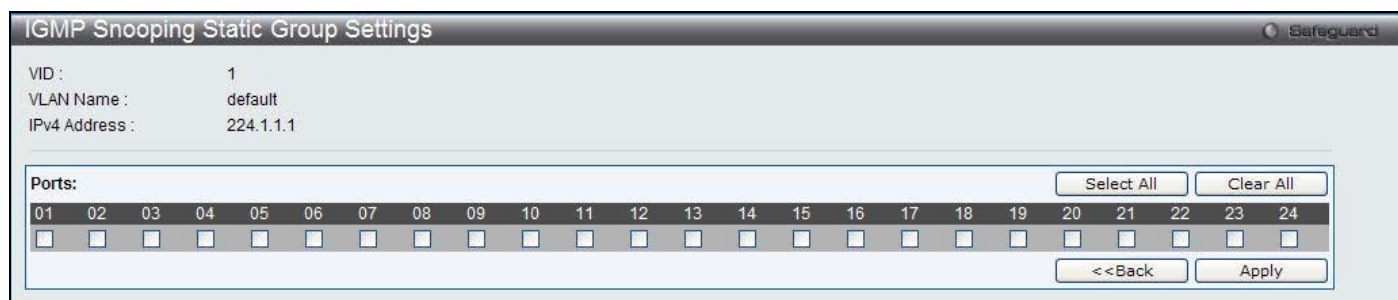

**Figure 3 - 30. IGMP Snooping Static Group Settings – Edit window**

Select the appropriate ports individually to include them in the IGMP snooping static group settings.

Click the **Select All** button to select all the ports for configuration. Click the **Clear All** button to unselect all the ports for configuration. Click the **Apply** button to accept the changes made. Click the **<<Back** button to discard the changes made and return to the previous page.

## IGMP Router Port

This window is used to display which of the Switch’s ports are currently configured as router ports. A router port configured by a user (using the console or Web-based management interfaces) is displayed as a static router port, designated by S. A router port that is dynamically configured by the Switch is designated by D, while a Forbidden port is designated by F.

To view the following window, click **L2 Features > L2 Multicast Control > IGMP Snooping > IGMP Router Port**:



Figure 3 - 31. IGMP Router Port window

Enter a VID (VLAN ID) in the field at the top of the window.

Click the **Find** button to locate a specific entry based on the information entered. Enter a page number and click the **Go** button to navigate to a specific page when multiple pages exist.

## IGMP Snooping Group

This window is used to display the Switch’s IGMP Snooping Group Table. IGMP Snooping allows the Switch to read the Multicast Group IP address and the corresponding MAC address from IGMP packets that pass through the Switch.

To view the following window, click **L2 Features > L2 Multicast Control > IGMP Snooping > IGMP Snooping Group**:

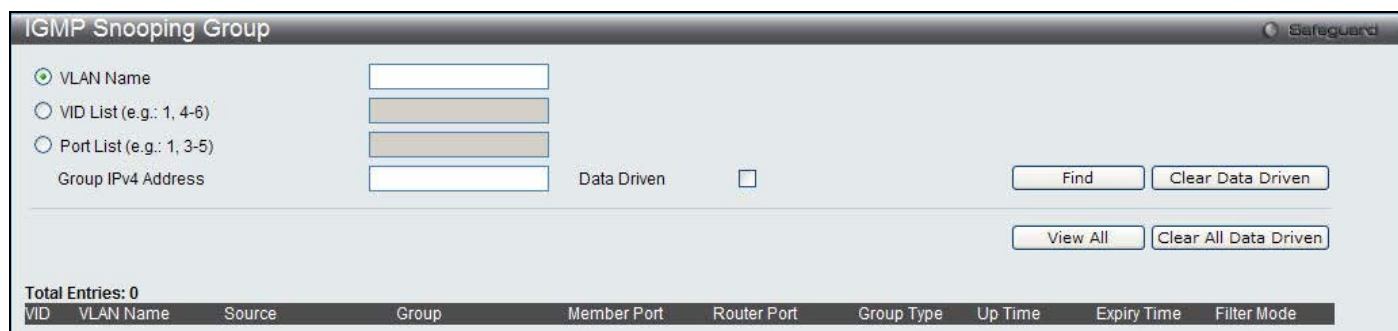

Figure 3 - 32. IGMP Snooping Group window

The following parameters can be configured:

Parameter	Description
<b>VLAN Name</b>	The VLAN name of the multicast group.
<b>VID List</b>	The VID list of the multicast group.
<b>Port List</b>	Specify the port number(s) used to find a multicast group.
<b>Group IPv4 Address</b>	Enter the IPv4 address.
<b>Data Driven</b>	Tick to display data-driven IGMP snooping group entries.

Click the **Find** button to locate a specific entry based on the information entered. Click **Clear Data Driven** to delete the specified IGMP snooping group learned by the data-driven mechanism. Click **View All** to see all the entries. Click **Clear All Data Driven** to delete all the IGMP snooping groups learned by the data-driven mechanism.



## IGMP Snooping Forwarding Table

This page displays the switch's current IGMP snooping forwarding table. It provides an easy way for user to check the list of ports that the multicast group comes from and specific sources that it will be forwarded to. The packet comes from the source VLAN. They will be forwarded to the forwarding VLAN. The IGMP snooping further restricts the forwarding ports.

To view the following window, click **L2 Features > L2 Multicast Control > IGMP Snooping > IGMP Snooping Forwarding Table**:

Figure 3 - 33. IGMP Snooping Forwarding Table window

The following parameters can be configured:

Parameter	Description
VLAN Name	The VLAN name of the multicast group.
VID List	The VID list of the multicast group.

Click the **Find** button to locate a specific entry based on the information entered. Click **View All** to see all the entries.

## IGMP Snooping Counter

This window is used to display the Switch's IGMP Snooping counter table.

To view the following window, click **L2 Features > L2 Multicast Control > IGMP Snooping > IGMP Snooping Counter**:

Figure 3 - 34. IGMP Snooping Counter window

The following parameters can be configured:

Parameter	Description
VLAN Name	The VLAN name of the multicast group.
VID List	The VID list of the multicast group.

<b>Port List</b>	Specify the port number(s) used to find a multicast group.
------------------	--

Click the **Find** button to locate a specific entry based on the information entered. Click **View All** to see all the entries. Click the [Packet Statistics](#) link to view the IGMP Snooping Counter Table.

Click the [Packet Statistics](#) link to see the following window.

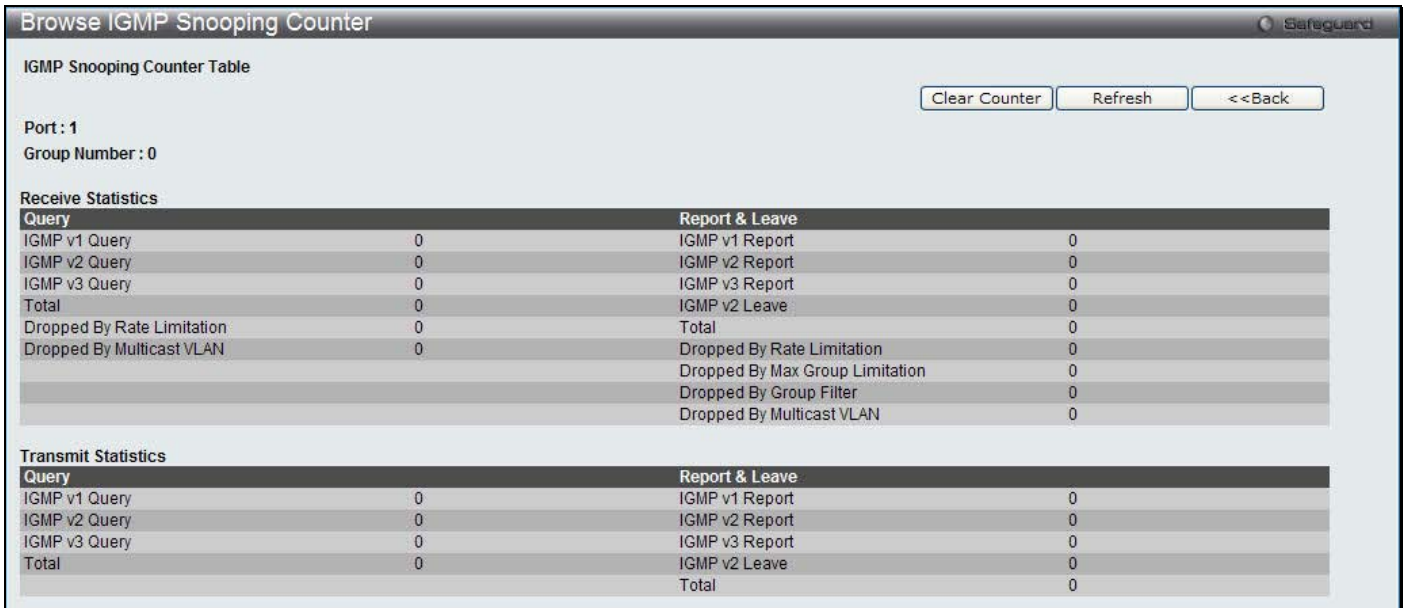

**Figure 3 - 35. Browse IGMP Snooping Counter window**

Click the **Clear Counter** button to clear all the information displayed in the fields. Click the **Refresh** button to refresh the display table so that new information will appear. Click the **<<Back** button to return to the previous page.

## IGMP Host Table

This window is used to display the IGMP hosts that have joined groups on specific ports or specific VLANs.

To view the following window, click **L2 Features > L2 Multicast Control > IGMP Snooping > IGMP Host Table**:



**Figure 3 - 36. IGMP Host Table window**

The following parameters can be configured:

Parameter	Description
<b>VLAN Name</b>	Specify the name of the VLAN on which the router port resides.
<b>VID List</b>	Specify a list of VLANs on which the router port resides.
<b>Port List</b>	Specify the list of ports to display the host information.
<b>Group Address</b>	Specify the group to display the host information.

Click the **Find** button to locate a specific entry based on the information entered. Click **View All** to see all the entries.

## MLD Snooping

### MLD Snooping Settings

Multicast Listener Discovery (MLD) Snooping is an IPv6 function used similarly to IGMP snooping in IPv4. It is used to discover ports on a VLAN that are requesting multicast data. Instead of flooding all ports on a selected VLAN with multicast traffic, MLD snooping will only forward multicast data to ports that wish to receive this data through the use of queries and reports produced by the requesting ports and the source of the multicast traffic.

MLD snooping is accomplished through the examination of the layer 3 part of an MLD control packet transferred between end nodes and a MLD router. When the Switch discovers that this route is requesting multicast traffic, it adds the port directly attached to it into the correct IPv6 multicast table, and begins the process of forwarding multicast traffic to that port. This entry in the multicast routing table records the port, the VLAN ID, and the associated multicast IPv6 multicast group address, and then considers this port to be an active listening port. The active listening ports are the only ones to receive multicast group data.

### MLD Control Messages

Three types of messages are transferred between devices using MLD snooping. These three messages are all defined by four ICMPv6 packet headers, labeled 130, 131, 132, and 143.

1. **Multicast Listener Query** – Similar to the IGMPv2 Host Membership Query for IPv4, and labeled as 130 in the ICMPv6 packet header, this message is sent by the router to ask if any link is requesting multicast data. There are two types of MLD query messages emitted by the router. The General Query is used to advertise all multicast addresses that are ready to send multicast data to all listening ports, and the Multicast Specific query, which advertises a specific multicast address that is also ready. These two types of messages are distinguished by a multicast destination address located in the IPv6 header and a multicast address in the Multicast Listener Query Message.
2. **Multicast Listener Report, Version 1** – Comparable to the Host Membership Report in IGMPv2, and labeled as 131 in the ICMP packet header, this message is sent by the listening port to the Switch stating that it is interested in receiving multicast data from a multicast address in response to the Multicast Listener Query message.
3. **Multicast Listener Done** – Akin to the Leave Group Message in IGMPv2, and labeled as 132 in the ICMPv6 packet header, this message is sent by the multicast listening port stating that it is no longer interested in receiving multicast data from a specific multicast group address, therefore stating that it is “done” with the multicast data from this address. Once this message is received by the Switch, it will no longer forward multicast traffic from a specific multicast group address to this listening port.
4. **Multicast Listener Report, Version 2** - Comparable to the Host Membership Report in IGMPv3, and labeled as 143 in the ICMP packet header, this message is sent by the listening port to the Switch stating that it is interested in receiving multicast data from a multicast address in response to the Multicast Listener Query message.

Users can configure the settings for MLD snooping.

To view the following window, click **L2 Features > L2 Multicast Control > MLD Snooping > MLD Snooping Settings**:



Figure 3 - 37. MLD Snooping Settings window

The following parameters can be viewed or configured:

Parameter	Description
<b>MLD Snooping State</b>	Click the radio button to enable or disable the MLD snooping state.
<b>Max Learned Entry Value (1-256)</b>	Specify the maximum number of groups that can be learned by the data driven mechanism.
<b>VID</b>	This is the VLAN ID that, along with the VLAN Name, identifies the VLAN for which to modify the MLD Snooping Settings.
<b>VLAN Name</b>	This is the VLAN Name that, along with the VLAN ID, identifies the VLAN for which to modify the MLD Snooping Settings.
<b>State</b>	Used to enable or disable MLD snooping for the specified VLAN. This field is <i>Disabled</i> by default.

Click **Apply** to implement changes made. Click the **Edit** button to configure the MLD Snooping Parameters Settings.

Click the [Modify Router Port](#) link to configure the MLD Snooping Router Port Settings.

Click the **Edit** button to see the following window:

**Figure 3 - 38. MLD Snooping Parameters Settings window**

The following parameters can be configured:

Parameter	Description
<b>Query Interval (1-65535 sec)</b>	This parameter is used to specify the amount of time in seconds between general query transmissions. Default: <i>125 seconds</i> .
<b>Max Response Time (1-25 sec)</b>	This parameter is used to specify the maximum amount of time in seconds to wait for reports from listeners. Default: <i>10 seconds</i> .
<b>Robustness Variable (1-7)</b>	<p>This parameter is used to provide fine-tuning that allows for expected packet losses on a subnet. The value of the robustness variable is used in calculating the following MLD message intervals:</p> <ul style="list-style-type: none"> <li>Group listener interval—Amount of time that must pass before a multicast router decides there are no more listeners of a group on a network. This interval is calculated as follows: (robustness variable * query interval) + (1 * query response interval).</li> <li>Other querier present interval—Amount of time that must pass before a multicast router decides that there is no longer another multicast router that is the querier. This interval is calculated as follows: (robustness variable * query interval) + (0.5 * query response interval).</li> <li>Last listener query count—Number of group-specific queries sent before the router assumes there are no local listeners of a group. The default number is the value of the robustness variable.</li> <li>By default, the robustness variable is set to 2. You might want to increase this value if you expect a subnet to lose a high number of packets.</li> </ul>

<b>Last Member Query Interval (1-25)</b>	This parameter is used to set the maximum amount of time between group-specific query messages, including messages that have been sent in response to leave group messages.
<b>Data Driven Group Expiry Time (1-65535)</b>	Specify the data driven group lifetime in seconds.
<b>Querier State</b>	Choose <i>Enabled</i> from the drop-down menu to specify that the Switch should act as an <i>MLD Querier</i> (sends MLD query packets). Choose <i>Disabled</i> from the drop-down menu to specify that the Switch should act as a <i>Non-Querier</i> (does not send MLD query packets).
<b>Fast Done</b>	Choose <i>Enabled</i> from the drop-down menu to enable the Fast Done function or choose <i>Disabled</i> to disable. If it is enabled, the membership is immediately removed when the system receive the MLD leave message.
<b>State</b>	Use the drop-down menu to specify if MLD Snooping should be <i>Enabled</i> or <i>Disabled</i> from the specified VLAN.
<b>Report Suppression</b>	Use the drop-down menu to enable or disable report suppression function. The Switch uses MLD report suppression to forward only one MLD report per multicast router query to multicast devices.
<b>Data Driven Learning State</b>	Use the drop-down menu to enable or disable the data driven learning of a MLD snooping group.
<b>Data Driven Learning Aged Out</b>	Use the drop-down menu to enable or disable the aging on the entry.
<b>Version</b>	Use the drop-down menu to specify the version of MLD packets that will be sent by the specified ports. If an MLD packet received by the interface has a version higher than the specified version, the packet will be dropped.

After setting the above parameters, click the **Apply** button in the top section of the window to allow your changes to be implemented. Click the <<**Back** button to discard the changes made and return to the previous page.

Click the [Modify Router Port](#) link to see the following window:

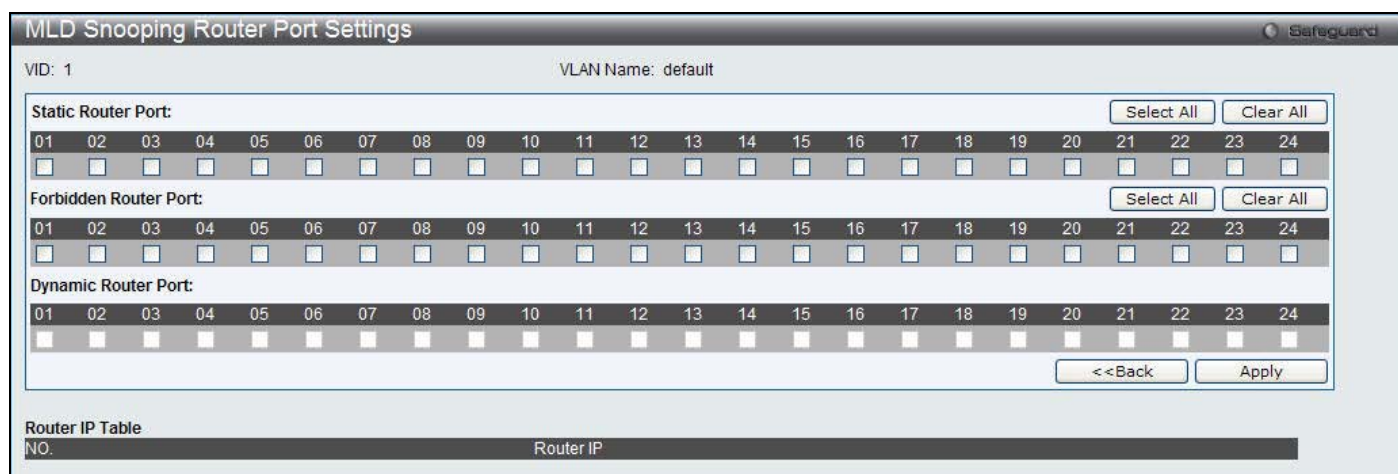

**Figure 3 - 39. MLD Snooping Router Port Settings window**

The following parameters can be configured:

Parameter	Description
<b>Static Router Port</b>	This section is used to designate a range of ports as being connected to multicast-enabled routers. This will ensure that all packets with such a router as its destination will reach the multicast-enabled router regardless of the protocol.
<b>Forbidden Router Port</b>	This section is used to designate a range of ports as being not connected to multicast-

	enabled routers. This ensures that the forbidden router port will not propagate routing packets out.
<b>Dynamic Router Port</b>	Displays router ports that have been dynamically configured.

Click the **Select All** button to select all the ports for configuration. Click the **Clear All** button to unselect all the ports for configuration. Click the **Apply** button to accept the changes made. Click the **<<Back** button to discard the changes made and return to the previous page.

## MLD Snooping Rate Limit Settings

This window is used to configure the MLD snooping rate limit parameters.

To view the following window, click **L2 Features > L2 Multicast Control > MLD Snooping > MLD Snooping Rate Limit Settings**:

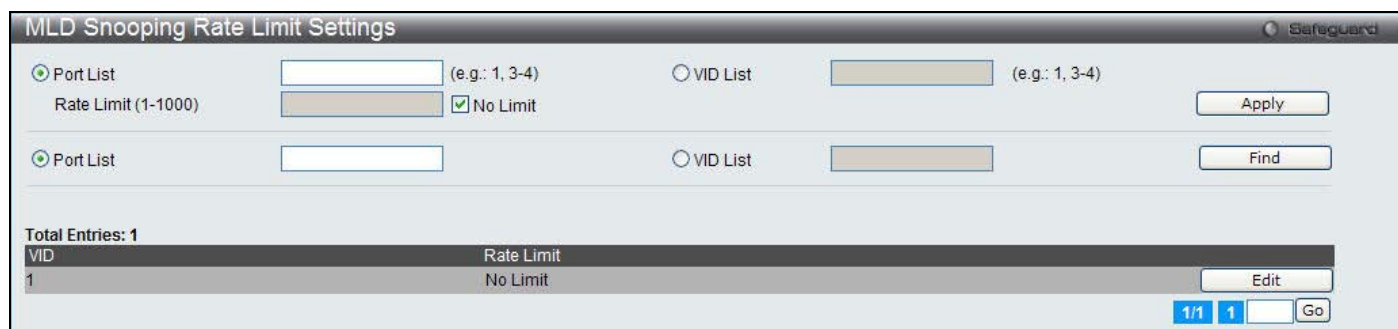

Figure 3 - 40. MLD Snooping Rate Limit Settings window

The following parameters can be configured:

Parameter	Description
<b>Port List</b>	Enter the port list used for this configuration.
<b>VID List</b>	Enter the VID list used for this configuration.
<b>Rate Limit (1-1000)</b>	Enter the MLD snooping rate limit used. By selecting the <b>No Limit</b> check box, the rate limit for the entered port(s) will be ignored.

Click the **Apply** button to accept the changes made. Click the **Find** button to locate a specific entry based on the information entered. Click the **Edit** button to re-configure the specific entry. Enter a page number and click the **Go** button to navigate to a specific page when multiple pages exist.

## MLD Snooping Static Group Settings

This window is used to view the Switch’s MLD Snooping Group Table. MLD Snooping allows the Switch to read the Multicast Group IP address and the corresponding MAC address from MLD packets that pass through the Switch.

To view the following window, click **L2 Features > L2 Multicast Control > MLD Snooping > MLD Snooping Static Group Settings**:



**Figure 3 - 41. MLD Snooping Static Group Settings window**

The following parameters can be configured:

Parameter	Description
VLAN Name	The VLAN name of the multicast group.
VID List	The VID list of the multicast group.
IPv6 Address	Enter the IPv6 address.

Click the **Find** button to locate a specific entry based on the information entered. Click the **Create** button to add a new entry based on the information entered. Click the **Delete** button to remove the specific entry based on the information entered. Click the **View All** button to display all the existing entries. Click the **Edit** button to re-configure the specific entry. Enter a page number and click the **Go** button to navigate to a specific page when multiple pages exist.

Click **Edit** to see the following window.

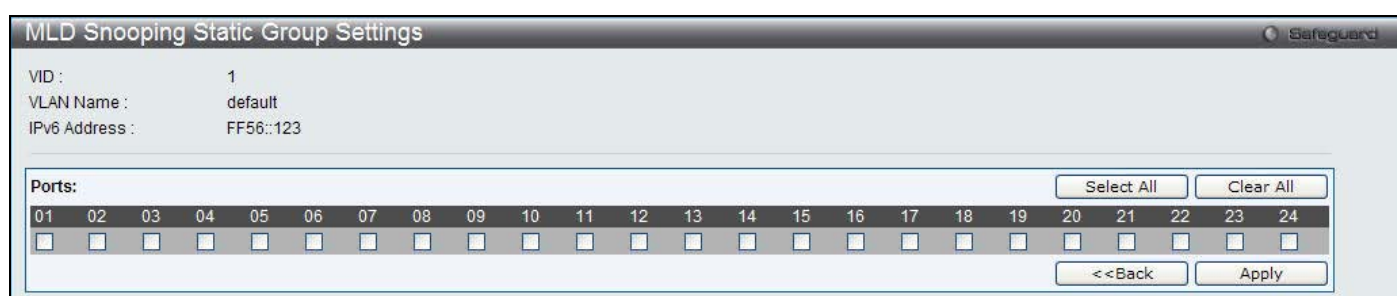

**Figure 3 - 42. MLD Snooping Static Group Settings – Edit window**

Select the appropriate ports individually to include them in the MLD snooping static group settings.

Click the **Select All** button to select all the ports for configuration. Click the **Clear All** button to unselect all the ports for configuration. Click the **Apply** button to accept the changes made. Click the **<<Back** button to discard the changes made and return to the previous page.

## MLD Router Port

This window is used to display which of the Switch’s ports are currently configured as router ports in IPv6. A router port configured by a user (using the console or Web-based management interfaces) is displayed as a static router port, designated by S. A router port that is dynamically configured by the Switch is designated by D, while a Forbidden port is designated by F.

To view the following window, click **L2 Features > L2 Multicast Control > MLD Snooping > MLD Router Port**:



**Figure 3 - 43. MLD Router Port window**

Enter a VID (VLAN ID) in the field at the top of the window.

Click the **Find** button to locate a specific entry based on the information entered. Enter a page number and click the **Go** button to navigate to a specific page when multiple pages exist.

## MLD Snooping Group

This window is used to display MLD Snooping Groups present on the Switch. MLD Snooping is an IPv6 function comparable to IGMP Snooping for IPv4.

To view the following window, click **L2 Features > L2 Multicast Control > MLD Snooping > MLD Snooping Group**:

Figure 3 - 44. MLD Snooping Group window

The following parameters can be configured:

Parameter	Description
<b>VLAN Name</b>	The VLAN name of the multicast group.
<b>VID List</b>	The VID list of the multicast group.
<b>Port List</b>	Specify the port number(s) used to find a multicast group.
<b>Group IPv6 Address</b>	Enter the IPv6 address.
<b>Data Driven</b>	Tick to display data-driven IGMP snooping group entries.

Click the **Find** button to locate a specific entry based on the information entered. Click **Clear Data Driven** to delete the specified IGMP snooping group learned by the data-driven mechanism. Click **View All** to see all the entries. Click **Clear All Data Driven** to delete all the IGMP snooping groups learned by the data-driven mechanism.

## MLD Snooping Forwarding Table

This window is used to display the switch's current MLD snooping forwarding table. It provides an easy way for user to check the list of ports that the multicast group comes from and specific sources that it will be forwarded to. The packet comes from the source VLAN. They will be forwarded to the forwarding VLAN. The MLD snooping further restricts the forwarding ports.

To view the following window, click **L2 Features > L2 Multicast Control > MLD Snooping > MLD Snooping Forwarding Table**:

Figure 3 - 45. MLD Snooping Forwarding Table window

The following parameters can be configured:

Parameter	Description
<b>VLAN Name</b>	The name of the VLAN for which you want to view MLD snooping forwarding table information.



**VID List** The ID of the VLAN for which you want to view MLD snooping forwarding table information.

Click the **Find** button to locate a specific entry based on the information entered. Click **View All** to see all the entries.

## MLD Snooping Counter

This window is used to display the statistics counter for MLD protocol packets that are received by the switch since MLD Snooping is enabled.

To view the following window, click **L2 Features > L2 Multicast Control > MLD Snooping > MLD Snooping Counter**:

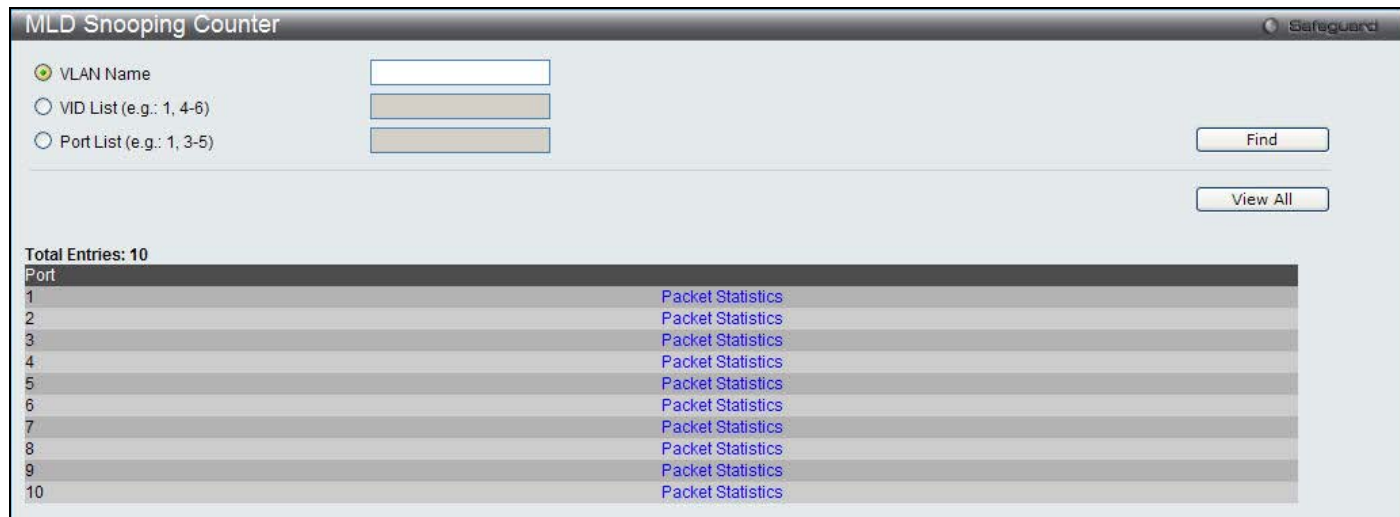

Figure 3 - 46. MLD Snooping Counter window

The following parameters can be configured:

Parameter	Description
<b>VLAN Name</b>	Specify a VLAN name to be displayed.
<b>VID List</b>	Specify a list of VLANs to be displayed.
<b>Port List</b>	Specify a list of ports to be displayed.

Click the **Find** button to locate a specific entry based on the information entered. Click **View All** to see all the entries. Click the [Packet Statistics](#) link to view the MLD Snooping Counter Table.

Click the [Packet Statistics](#) link to see the following window.

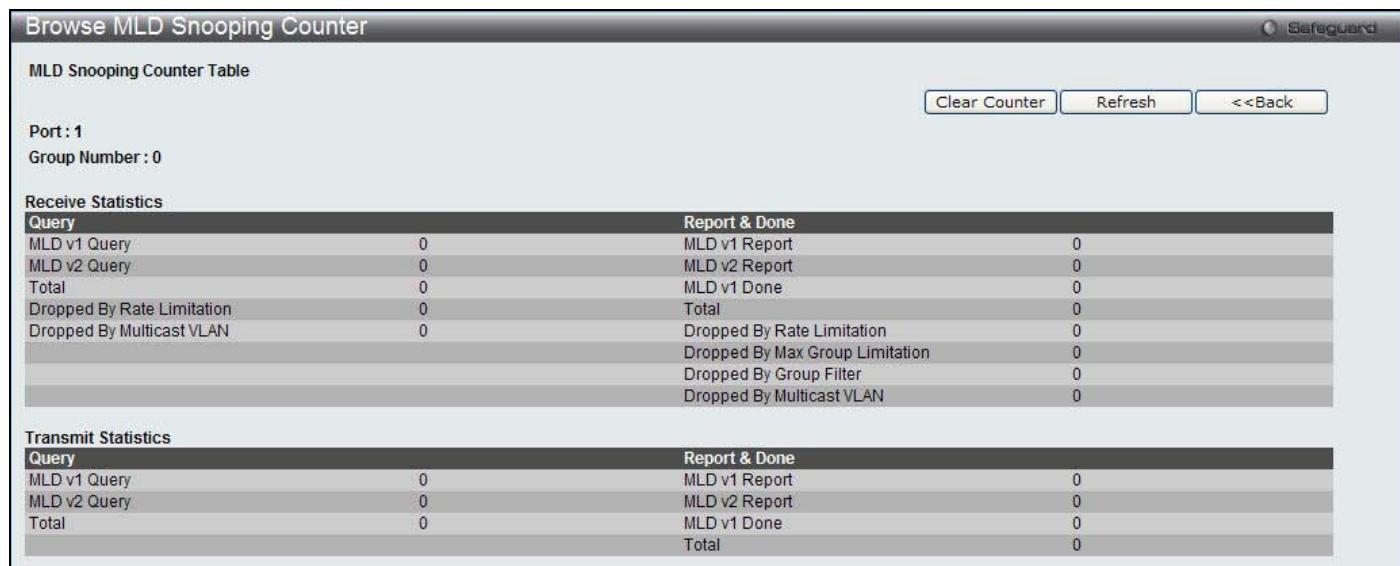

**Figure 3 - 47. Browse MLD Snooping Counter window**

Click the **Clear Counter** button to clear all the information displayed in the fields. Click the **Refresh** button to refresh the display table so that new information will appear. Click the **<<Back** button to return to the previous page.

## MLD Host Table

This window is used to display the MLD hosts that have joined groups on specific ports or specific VLANs.

To view the following window, click **L2 Features > L2 Multicast Control > MLD Snooping > MLD Host Table**:

**Figure 3 - 48. MLD Host Table window**

The following parameters can be configured:

Parameter	Description
<b>VLAN Name</b>	Specify the name of the VLAN on which the router port resides.
<b>VID List</b>	Specify a list of VIDs on which the router port resides.
<b>Port List</b>	Specify the list of ports to display the host information.
<b>Group Address</b>	Specify the group to display the host information.

Click the **Find** button to locate a specific entry based on the information entered. Click **View All** to see all the entries.

## Multicast VLAN

### IGMP Multicast Group Profile Settings

Users can add a profile to which multicast address reports are to be received on specified ports on the Switch. This function will therefore limit the number of reports received and the number of multicast groups configured on the Switch. The user may set an IP Multicast address or range of IP Multicast addresses to accept reports (Permit) or deny reports (Deny) coming into the specified switch ports.

To view the following window, click **L2 Features > L2 Multicast Control > Multicast VLAN > IGMP Multicast Group Profile Settings**:

**Figure 3 - 49. IGMP Multicast Group Profile Settings window**

The following parameters can be configured:

Parameter	Description
<b>Profile Name</b>	Enter a name for the IP Multicast Profile.

Click the **Add** button to add a new entry. Click the **Find** button to locate a specific entry based on the information entered. Click the **Delete All** button to remove all the entries listed. Click the **View All** button to display all the existing entries. Click the **Delete** button to remove the corresponding entry. Click the [Group List](#) link to configure the Multicast Group Profile Address Settings for the specific entry.

Click the [Group List](#) link to see the following window.

**Figure 3 - 50. Multicast Group Profile Multicast Address Settings window**

The following parameters can be configured:

Parameter	Description
<b>Multicast Address List</b>	Enter the multicast address list value.

Click the **Add** button to add a new entry based on the information entered. Click the **<<Back** button to discard the changes made and return to the previous page. Click the **Delete** button to remove the corresponding entry.

## IGMP Snooping Multicast VLAN Settings

This window is used to configure the IGMP snooping multicast VLAN parameters.

To view the following window, click **L2 Features > L2 Multicast Control > Multicast VLAN > IGMP Snooping Multicast VLAN Settings**:

**Figure 3 - 51. IGMP Snooping Multicast VLAN Settings window**

The following parameters can be configured:

Parameter	Description
<b>IGMP Multicast VLAN State</b>	Click the radio buttons to enable or disable the IGMP Multicast VLAN state.
<b>IGMP Multicast VLAN Forward Unmatched</b>	Click the radio buttons to enable or disable the IGMP Multicast VLAN Forwarding state.

<b>VLAN Name</b>	Enter the VLAN Name used.
<b>VID (2-4094)</b>	Enter the VID used.

Click the **Apply** button to accept the changes made for each individual section. Click the **Add** button to add a new entry based on the information entered. Click the **Edit** button to configure the IGMP Snooping Multicast VLAN Settings for the specific entry. Click the **Delete** button to remove the specific entry. Click the [Profile List](#) link to configure the IGMP Snooping Multicast VLAN Settings for the specific entry.

Click the **Edit** button to see the following window.

**Figure 3 - 52. IGMP Snooping Multicast VLAN Settings – Edit window**

The following parameters can be configured:

Parameter	Description
<b>State</b>	Use the drop-down menu to enable or disable the state.
<b>Replace Source IP</b>	With the IGMP snooping function, the IGMP report packet sent by the host will be forwarded to the source port. Before forwarding of the packet, the source IP address in the join packet needs to be replaced by this IP address. If none is specified, the source IP address will use zero IP address.
<b>Untagged Member Ports</b>	Specify the untagged member port of the multicast VLAN.
<b>Tagged Member Ports</b>	Specify the tagged member port of the multicast VLAN.
<b>Tagged Source Ports</b>	Specify the source port or range of source ports as tagged members of the multicast VLAN.

Click the **Select All** button to select all the ports for configuration. Click the **Clear All** button to unselect all the ports for configuration. Click the **Apply** button to accept the changes made. Click the **<<Back** button to discard the changes made and return to the previous page.

Click the [Profile List](#) link to see the following window.

**Figure 3 - 53. IGMP Snooping Multicast VLAN Group List Settings window**

The following parameters can be configured:

Parameter	Description
<b>Profile Name</b>	Use the drop-down menu to select the IGMP Snooping Multicast VLAN Group Profile name.

Click the **Add** button to add a new entry based on the information entered. Click the **Delete** button to remove the specific entry. Click the [Show IGMP Snooping Multicast VLAN Entries](#) link to view the IGMP Snooping Multicast VLAN Settings.

## Multicast Filtering

### IPv4 Multicast Filtering

#### IPv4 Multicast Profile Settings

Users can add a profile to which multicast address(s) reports are to be received on specified ports on the Switch. This function will therefore limit the number of reports received and the number of multicast groups configured on the Switch. The user may set an IPv4 Multicast address or range of IPv4 Multicast addresses to accept reports (Permit) or deny reports (Deny) coming into the specified switch ports.

To view the following window, click **L2 Features > Multicast Filtering > IPv4 Multicast Filtering > IPv4 Multicast Profile Settings**:



Figure 3 - 54. IPv4 Multicast Profile Settings window

The following parameters can be configured:

Parameter	Description
<b>Profile ID (1-24)</b>	Enter a Profile ID between 1 and 24.
<b>Profile Name</b>	Enter a name for the IP Multicast Profile.

Click the **Add** button to add a new entry based on the information entered. Click the **Find** button to locate a specific entry based on the information entered. Click the **Delete All** button to remove all the entries listed. Click the [Group List](#) link to configure the multicast address group list settings for the specific entry. Click the **Edit** button to re-configure the specific entry. Click the **Delete** button to remove the specific entry.

Click the [Group List](#) link to see the following window.



Figure 3 - 55. Multicast Address Group List Settings window

The following parameters can be configured:

Parameter	Description
<b>Multicast Address List</b>	Enter the multicast address list.

Click the **Add** button to add a new entry based on the information entered. Click the **<<Back** button to discard the changes made and return to the previous page. Click the **Edit** button to re-configure the specific entry. Click the **Delete** button to remove the specific entry.

## IPv4 Limited Multicast Range Settings

Users can configure the ports and VLANs on the Switch that will be involved in the Limited IPv4 Multicast Range. The user can configure the range of multicast ports that will be accepted by the source ports to be forwarded to the receiver ports.

To view the following window, click **L2 Features > Multicast Filtering > IPv4 Multicast Filtering > IPv4 Limited Multicast Range Settings**:



Figure 3 - 56. IPv4 Limited Multicast Range Settings window

The following parameters can be configured:

Parameter	Description
<b>Ports / VID List</b>	Select the appropriate port(s) or VLAN IDs used for the configuration.
<b>Access</b>	Assign access permissions to the ports selected. Options listed are <i>Permit</i> and <i>Deny</i> .
<b>Profile ID / Profile Name</b>	Use the drop-down menu to select the profile ID or profile name used and then assign <i>Permit</i> or <i>Deny</i> access to them.

Click the **Apply** button to accept the changes made. Click the **Add** button to add a new entry based on the information entered. Click the **Delete** button to remove the specific entry. Click the **Find** button to locate a specific entry based on the information entered. Enter a page number and click the **Go** button to navigate to a specific page when multiple pages exist.

## IPv4 Max Multicast Group Settings

Users can configure the ports and VLANs on the switch that will be a part of the maximum filter group, up to a maximum of 1024.

To view the following window, click **L2 Features > Multicast Filtering > IPv4 Multicast Filtering > IPv4 Multicast Group Settings**:

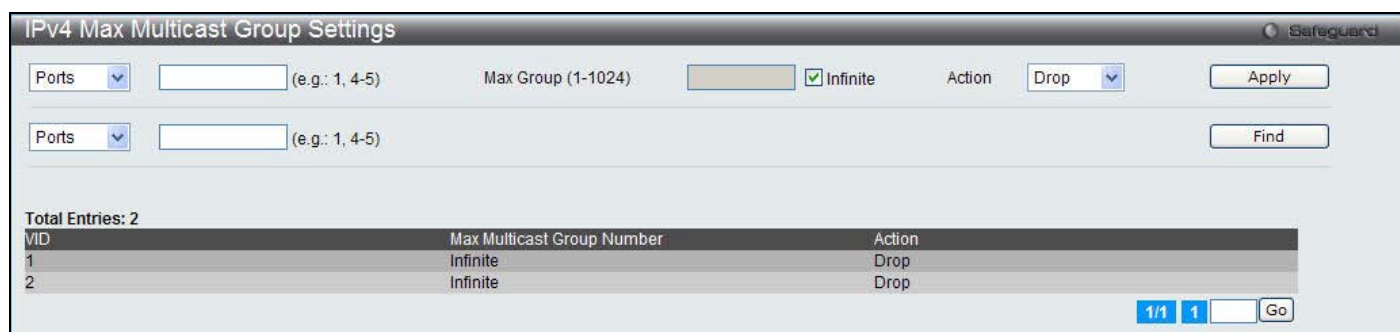

Figure 3 - 57. IPv4 Max Multicast Group Settings window

The following parameters can be configured:

Parameter	Description
<b>Ports / VID List</b>	Select the appropriate port(s) or VLAN IDs used for the configuration here.
<b>Max Group (1-1024)</b>	If the checkbox <b>Infinite</b> is not selected, the user can enter a <b>Max Group</b> value.
<b>Infinite</b>	Tick the check box to enable or disable the use of the Infinite value.
<b>Action</b>	Use the drop-down menu to select the appropriate action for this rule. The user can select <i>Drop</i> to initiate the drop action or the user can select <i>Replace</i> to initiate the replace action.

Click the **Apply** button to accept the changes made. Click the **Find** button to locate a specific entry based on the information entered. Enter a page number and click the **Go** button to navigate to a specific page when multiple pages exist.

## Multicast Filtering Mode

Users can configure the multicast filtering mode.

To view the following window, click **L2 Features > Multicast Filtering > IPv4 Multicast Filtering > Multicast Filtering Mode**:

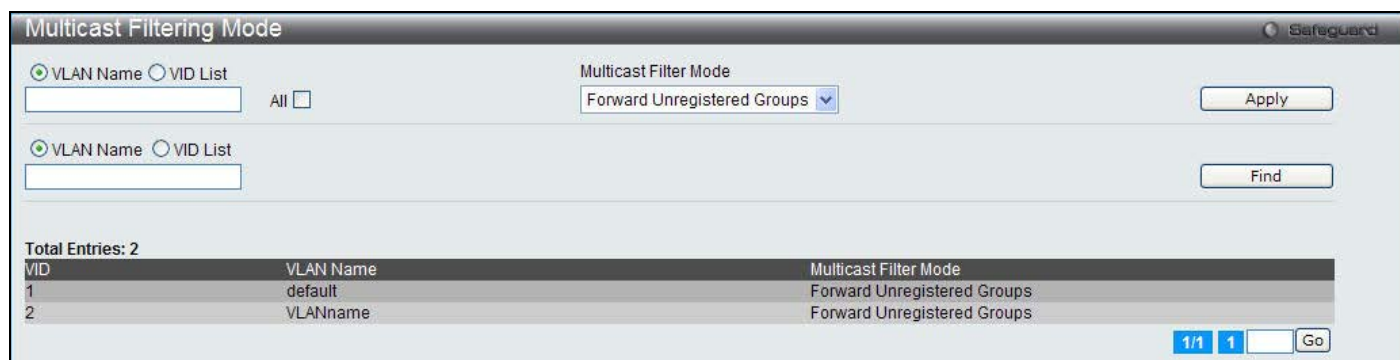

Figure 3 - 58. Multicast Filtering Mode window

Parameter	Description
<b>VLAN Name / VID List</b>	The VLAN to which the specified filtering action applies. Select the All option to apply the action to all VLANs on the Switch.
<b>Filtering Mode</b>	This drop-down menu allows you to select the action the Switch will take when it receives a

multicast packet that requires forwarding to a port in the specified VLAN.

- *Forward Unregistered Groups* – This will instruct the Switch to forward a multicast packet whose destination is an unregistered multicast group residing within the range of ports specified above.
- *Filter Unregistered Groups* – This will instruct the Switch to filter any multicast packets whose destination is an unregistered multicast group residing within the range of ports specified above.

Click **Apply** to implement changes made. Click the **Find** button to locate a specific entry based on the information entered. Enter a page number and click the **Go** button to navigate to a specific page when multiple pages exist.

## Port Mirroring

The Switch allows you to copy frames transmitted and received on a port and redirect the copies to another port. You can attach a monitoring device to the mirrored port, such as a sniffer or an RMON probe, to view details about the packets passing through the first port. This is useful for network monitoring and troubleshooting purposes.

To view the following window, click **L2 Features > Port Mirroring**:

Figure 3 - 59. Port Mirroring window

### To configure a mirror port:

1. Use the radio button to change the Target Port Settings Status to Enabled.
2. Use the drop-down menu to select the Target Port to which frames will be copied, which receives the copies from the source port
3. Select the Source Port Setting Direction, TX (Egress), Rx (Ingress), Both, or None.
4. Click **Apply** to let the changes take effect.



**NOTE:** You cannot mirror a fast port onto a slower port. For example, if you try to mirror the traffic from a 100 Mbps port onto a 10 Mbps port, this can cause throughput problems. The port you are copying frames from should always support an equal or lower speed than the port to which you are sending the copies. Also, the target port for the mirroring cannot be a member of a trunk group. Please note a target port and a source port cannot be the same port.





**NOTE:** Target mirror ports cannot be members of a trunking group. Attempting to do so will produce an error message and the configuration will not be set.

## Spanning Tree

This Switch supports three versions of the Spanning Tree Protocol: 802.1D-1998 STP, 802.1D-2004 Rapid STP, and 802.1Q-2005 MSTP. 802.1D-1998 STP will be familiar to most networking professionals. However, since 802.1D-2004 RSTP and 802.1Q-2005 MSTP have been recently introduced to D-Link managed Ethernet switches, a brief introduction to the technology is provided below followed by a description of how to set up 802.1D-1998 STP, 802.1D-2004 RSTP, and 802.1Q-2005 MSTP.

### 802.1Q-2005 MSTP

Multiple Spanning Tree Protocol, or MSTP, is a standard defined by the IEEE community that allows multiple VLANs to be mapped to a single spanning tree instance, which will provide multiple pathways across the network. Therefore, these MSTP configurations will balance the traffic load, preventing wide scale disruptions when a single spanning tree instance fails. This will allow for faster convergences of new topologies for the failed instance. Frames designated for these VLANs will be processed quickly and completely throughout interconnected bridges utilizing any of the three spanning tree protocols (STP, RSTP or MSTP).

This protocol will also tag BPDU packets so receiving devices can distinguish spanning tree instances, spanning tree regions and the VLANs associated with them. An MSTI ID will classify these instances. MSTP will connect multiple spanning trees with a Common and Internal Spanning Tree (CIST). The CIST will automatically determine each MSTP region, its maximum possible extent and will appear as one virtual bridge that runs a single spanning tree. Consequentially, frames assigned to different VLANs will follow different data routes within administratively established regions on the network, continuing to allow simple and full processing of frames, regardless of administrative errors in defining VLANs and their respective spanning trees.

Each switch utilizing the MSTP on a network will have a single MSTP configuration that will have the following three attributes:

1. A configuration name defined by an alphanumeric string of up to 32 characters (defined in the **MST Configuration Identification** window in the Configuration Name field).
2. A configuration revision number (named here as a Revision Level and found in the **MST Configuration Identification** window) and;
3. A 4094-element table (defined here as a VID List in the **MST Configuration Identification** window), which will associate each of the possible 4094 VLANs supported by the Switch for a given instance.

To utilize the MSTP function on the Switch, three steps need to be taken:

1. The Switch must be set to the MSTP setting (found in the **STP Bridge Global Settings** window in the STP Version field)
2. The correct spanning tree priority for the MSTP instance must be entered (defined here as a Priority in the **MSTI Config Information** window when configuring MSTI ID settings).
3. VLANs that will be shared must be added to the MSTP Instance ID (defined here as a VID List in the **MST Configuration Identification** window when configuring an MSTI ID settings).

### 802.1D-2004 Rapid Spanning Tree

The Switch implements three versions of the Spanning Tree Protocol, the Multiple Spanning Tree Protocol (MSTP) as defined by the IEEE 802.1Q-2005, the Rapid Spanning Tree Protocol (RSTP) as defined by the IEEE 802.1D-2004 specification and a version compatible with the IEEE 802.1D-1998 STP. RSTP can operate with legacy equipment implementing IEEE 802.1D-1998; however the advantages of using RSTP will be lost.

The IEEE 802.1D-2004 Rapid Spanning Tree Protocol (RSTP) evolved from the 802.1D-1998 STP standard. RSTP was developed in order to overcome some limitations of STP that impede the function of some recent switching innovations, in particular, certain Layer 3 functions that are increasingly handled by Ethernet switches. The basic function and much of the terminology is the same as STP. Most of the settings configured for STP are also used for RSTP. This section introduces some new Spanning Tree concepts and illustrates the main differences between the two protocols.

## Port Transition States

An essential difference between the three protocols is in the way ports transition to a forwarding state and in the way this transition relates to the role of the port (forwarding or not forwarding) in the topology. MSTP and RSTP combine the transition states disabled, blocking and listening used in 802.1D-1998 and creates a single state Discarding. In either case, ports do not forward packets. In the STP port transition states disabled, blocking or listening or in the RSTP/MSTP port state discarding, there is no functional difference, the port is not active in the network topology. Table 7-3 below compares how the three protocols differ regarding the port state transition.

All three protocols calculate a stable topology in the same way. Every segment will have a single path to the root bridge. All bridges listen for BPDU packets. However, BPDU packets are sent more frequently - with every Hello packet. BPDU packets are sent even if a BPDU packet was not received. Therefore, each link between bridges is sensitive to the status of the link. Ultimately this difference results in faster detection of failed links, and thus faster topology adjustment. A drawback of 802.1D-1998 is this absence of immediate feedback from adjacent bridges.

802.1Q-2005 MSTP	802.1D-2004 RSTP	802.1D-1998 STP	Forwarding	Learning
Disabled	Disabled	Disabled	No	No
<i>Discarding</i>	<i>Discarding</i>	<i>Blocking</i>	No	No
<i>Discarding</i>	<i>Discarding</i>	<i>Listening</i>	No	No
<i>Learning</i>	<i>Learning</i>	<i>Learning</i>	No	<b>Yes</b>
<b>Forwarding</b>	<b>Forwarding</b>	<b>Forwarding</b>	<b>Yes</b>	<b>Yes</b>

**Table 3 - 2. Comparing Port States**

RSTP is capable of a more rapid transition to a forwarding state - it no longer relies on timer configurations - RSTP compliant bridges are sensitive to feedback from other RSTP compliant bridge links. Ports do not need to wait for the topology to stabilize before transitioning to a forwarding state. In order to allow this rapid transition, the protocol introduces two new variables: the edge port and the point-to-point (P2P) port.

## Edge Port

The edge port is a configurable designation used for a port that is directly connected to a segment where a loop cannot be created. An example would be a port connected directly to a single workstation. Ports that are designated as edge ports transition to a forwarding state immediately without going through the listening and learning states. An edge port loses its status if it receives a BPDU packet, immediately becoming a normal spanning tree port. The edge port is supported when STP is selected in STP Version.

## P2P Port

A P2P port is also capable of rapid transition. P2P ports may be used to connect to other bridges. Under RSTP/MSTP, all ports operating in full-duplex mode are considered to be P2P ports, unless manually overridden through configuration.

## 802.1D-1998/802.1D-2004/802.1Q-2005 Compatibility

MSTP or RSTP can interoperate with legacy equipment and is capable of automatically adjusting BPDU packets to 802.1D-1998 format when necessary. However, any segment using 802.1D-1998 STP will not benefit from the rapid transition and rapid topology change detection of MSTP or RSTP. The protocol also provides for a variable used for migration in the event that legacy equipment on a segment is updated to use RSTP or MSTP.

The Spanning Tree Protocol (STP) operates on two levels:

1. On the switch level, the settings are globally implemented.
2. On the port level, the settings are implemented on a per user-defined group of ports basis.

## STP Bridge Global Settings

Use the STP Status radio buttons to enable or disable STP globally, and use the STP Version drop-down menu to choose the STP method.

To view the following windows, click **L2 Features > Spanning Tree > STP Bridge Global Settings**:

**Figure 3 - 60. STP Bridge Global Settings window – RSTP (default)**

**Figure 3 - 61. STP Bridge Global Settings window – MSTP**

**Figure 3 - 62. STP Bridge Global Settings window – STP Compatible**

See the table below for descriptions of the STP versions and corresponding setting options.



**NOTE:** The Bridge Hello Time cannot be longer than the Bridge Max Age. Otherwise, a configuration error will occur. Observe the following formulas when setting the above parameters:

Bridge Max Age  $\leq 2 \times$  (Bridge Forward Delay - 1 second)

Bridge Max Age  $> 2 \times$  (Bridge Hello Time + 1 second)

Configure the following parameters for STP:

Parameter	Description
<b>STP Status</b>	Use the radio button to globally enable or disable STP.
<b>STP Version</b>	Use the drop-down menu to choose the desired version of STP: <i>STP</i> - Select this parameter to set the Spanning Tree Protocol (STP) globally on the switch. <i>RSTP</i> - Select this parameter to set the Rapid Spanning Tree Protocol (RSTP) globally on the Switch. <i>MSTP</i> - Select this parameter to set the Multiple Spanning Tree Protocol (MSTP) globally on the Switch.
<b>Forwarding BPDU</b>	This field can be <i>Enabled</i> or <i>Disabled</i> . When <i>Enabled</i> , it allows the forwarding of STP BPDU packets from other network devices. The default is <i>Enabled</i> .
<b>Bridge Max Age (6 – 40)</b>	The Max Age may be set to ensure that old information does not endlessly circulate through redundant paths in the network, preventing the effective propagation of the new information. Set by the Root Bridge, this value will aid in determining that the Switch has spanning tree configuration values consistent with other devices on the bridged LAN. The user may choose a time between 6 and 40 seconds. The default value is 20 seconds.
<b>Bridge Hello Time (1 – 2)</b>	The Hello Time can be set from 1 to 2 seconds. This is the interval between two transmissions of BPDU packets sent by the Root Bridge to tell all other switches that it is indeed the Root Bridge. This field will only appear here when STP or RSTP is selected for the STP Version. For MSTP, the Hello Time must be set on a port per port basis. The default is 2 seconds.
<b>Bridge Forward Delay (4 – 30)</b>	The Forward Delay can be from 4 to 30 seconds. Any port on the Switch spends this time in the listening state while moving from the blocking state to the forwarding state. The default is 15 seconds
<b>TX Hold Count (1-10)</b>	Used to set the maximum number of Hello packets transmitted per interval. The count can be specified from 1 to 10. The default is 6.
<b>Max Hops (6-40)</b>	Used to set the number of hops between devices in a spanning tree region before the BPDU (bridge protocol data unit) packet sent by the Switch will be discarded. Each switch on the hop count will reduce the hop count by one until the value reaches zero. The Switch will then discard the BPDU packet and the information held for the port will age out. The user may set a hop count from 6 to 40. The default is 20.
<b>New Root Trap</b>	Used to enable or disable the sending of new root traps. The default is <i>Enabled</i> .
<b>Topology Change Trap</b>	Used to enable or disable the sending of topology change traps. The default is <i>Enabled</i> .

Click **Apply** to implement changes made.

## STP Port Settings

STP can be set up on a port per port basis.

To view the following window, click **L2 Features > Spanning Tree > STP Port Settings**:

STP Port Settings
Safeguard

From Port:

External Cost (0=Auto):

P2P:

Restricted TCN:

To Port:

Migrate:

State:

Forward BPDU:

Edge:

Restricted Role:

Port	External Cost	Hello Time	Edge	P2P	Port STP	Restricted Role	Restricted TCN	Forward BPDU
1	Auto/200000	2/2	False/No	Auto/Yes	Enabled	False	False	Enabled
2	Auto/200000	2/2	False/No	Auto/Yes	Enabled	False	False	Enabled
3	Auto/200000	2/2	False/No	Auto/Yes	Enabled	False	False	Enabled
4	Auto/200000	2/2	False/No	Auto/Yes	Enabled	False	False	Enabled
5	Auto/200000	2/2	False/No	Auto/Yes	Enabled	False	False	Enabled
6	Auto/200000	2/2	False/No	Auto/Yes	Enabled	False	False	Enabled
7	Auto/200000	2/2	False/No	Auto/Yes	Enabled	False	False	Enabled
8	Auto/200000	2/2	False/No	Auto/Yes	Enabled	False	False	Enabled
9	Auto/200000	2/2	False/No	Auto/Yes	Enabled	False	False	Enabled
10	Auto/200000	2/2	False/No	Auto/Yes	Enabled	False	False	Enabled
11	Auto/200000	2/2	False/No	Auto/Yes	Enabled	False	False	Enabled
12	Auto/200000	2/2	False/No	Auto/Yes	Enabled	False	False	Enabled
13	Auto/200000	2/2	False/No	Auto/Yes	Enabled	False	False	Enabled
14	Auto/200000	2/2	False/No	Auto/Yes	Enabled	False	False	Enabled
15	Auto/200000	2/2	False/No	Auto/Yes	Enabled	False	False	Enabled
16	Auto/200000	2/2	False/No	Auto/Yes	Enabled	False	False	Enabled
17	Auto/200000	2/2	False/No	Auto/Yes	Enabled	False	False	Enabled
18	Auto/200000	2/2	False/No	Auto/Yes	Enabled	False	False	Enabled
19	Auto/200000	2/2	False/No	Auto/Yes	Enabled	False	False	Enabled
20	Auto/200000	2/2	False/No	Auto/Yes	Enabled	False	False	Enabled
21	Auto/200000	2/2	False/No	Auto/Yes	Enabled	False	False	Enabled
22	Auto/200000	2/2	False/No	Auto/Yes	Enabled	False	False	Enabled
23	Auto/200000	2/2	False/No	Auto/Yes	Enabled	False	False	Enabled
24	Auto/200000	2/2	False/No	Auto/Yes	Enabled	False	False	Enabled

Figure 3 - 63. STP Port Settings window

It is advisable to define an STP Group to correspond to a VLAN group of ports.

The following parameters can be configured:

Parameter	Description
<b>From Port / To Port</b>	Use the drop-down menu to select a range of ports to be configured.
<b>External Cost (0=Auto)</b>	This defines a metric that indicates the relative cost of forwarding packets to the specified port list. Port cost can be set automatically or as a metric value. The default value is 0 (auto). Setting 0 for the external cost will automatically set the speed for forwarding packets to the specified port(s) in the list for optimal efficiency. The default port cost for a 100Mbps port is 200000 and the default port cost for a Gigabit port is 20000. Enter a value between 1 and 200000000 to determine the External Cost. The lower the number, the greater the probability the port will be chosen to forward packets.
<b>P2P</b>	Choosing the <i>True</i> parameter indicates a point-to-point (P2P) shared link. P2P ports are similar to edge ports; however they are restricted in that a P2P port must operate in full duplex. Like edge ports, P2P ports transition to a forwarding state rapidly thus benefiting from RSTP. A P2P value of <i>False</i> indicates that the port cannot have P2P status. <i>Auto</i> allows the port to have P2P status whenever possible and operate as if the P2P status were <i>True</i> . If the port cannot maintain this status, (for example if the port is forced to half-duplex operation) the P2P status changes to operate as if the P2P value were <i>False</i> . The default setting for this parameter is <i>Auto</i> .
<b>Restricted TCN</b>	Topology Change Notification is a simple BPDU that a bridge sends out to its root port to signal a topology change. Restricted TCN can be toggled between <i>True</i> and <i>False</i> . If set to <i>True</i> , this stops the port from propagating received topology change notifications and topology changes to other ports. The default is <i>False</i> .
<b>Migrate</b>	When operating in RSTP mode, selecting <i>Yes</i> forces the port that has been selected to transmit RSTP BPDUs.
<b>State</b>	This drop-down menu allows you to enable or disable STP for the selected group of ports. The default is <i>Enabled</i> .

<b>Forward BPDU</b>	Use the drop-down menu to enable or disable the flooding of BPDU packets when STP is disabled.
<b>Edge</b>	Choosing the <i>True</i> parameter designates the port as an edge port. Edge ports cannot create loops, however an edge port can lose edge port status if a topology change creates a potential for a loop. An edge port normally should not receive BPDU packets. If a BPDU packet is received, it automatically loses edge port status. Choosing the <i>False</i> parameter indicates that the port does not have edge port status. Alternatively, the <i>Auto</i> option is available.
<b>Restricted Role</b>	Use the drop-down menu to toggle Restricted Role between <i>True</i> and <i>False</i> . If set to <i>True</i> , the port will never be selected to be the Root port. The default is <i>False</i> .

Click **Apply** to implement changes made.

## MST Configuration Identification

This window allows the user to configure a MSTI instance on the Switch. These settings will uniquely identify a multiple spanning tree instance set on the Switch. The Switch initially possesses one CIST, or Common Internal Spanning Tree, of which the user may modify the parameters for but cannot change the MSTI ID for, and cannot be deleted.

To view the following window, click **L2 Features > Spanning Tree > MST Configuration Identification**:

**Figure 3 - 64. MST Configuration Identification window**

The window above contains the following information:

Parameter	Description
<b>Configuration Name</b>	This name uniquely identifies the MSTI (Multiple Spanning Tree Instance). If a Configuration Name is not set, this field will show the MAC address to the device running MSTP.
<b>Revision Level (0-65535)</b>	This value, along with the Configuration Name, identifies the MSTP region configured on the Switch.
<b>MSTI ID (1-15)</b>	Enter a number between 1 and 15 to set a new MSTI on the Switch.
<b>Type</b>	This field allows the user to choose a desired method for altering the MSTI settings. The user has two choices:  <i>Add VID</i> - Select this parameter to add VIDs to the MSTI ID, in conjunction with the VID List parameter.  <i>Remove VID</i> - Select this parameter to remove VIDs from the MSTI ID, in conjunction with the VID List parameter.
<b>VID List (e.g.: 2-5, 10)</b>	This field is used to specify the VID range from configured VLANs set on the Switch. Supported VIDs on the Switch range from ID number 1 to 4094.

Click **Apply** to implement changes made. To modify an entry on the table at the bottom of the window, click the corresponding **Edit** button. To remove an entry on the table at the bottom of the window, click the corresponding **Delete** button.

## STP Instance Settings

This window displays MSTIs currently set on the Switch and allows users to change the Priority of the MSTIs.

To view the following window, click **L2 Features > Spanning Tree > STP Instance Settings**:

**Figure 3 - 65. STP Instance Settings window**

The window above contains the following information:

Parameter	Description
<b>MSTI ID</b>	Enter the MSTI ID in this field. An entry of 0 denotes the CIST (default MSTI).
<b>Priority</b>	Enter the priority in this field. The available range of values is from 0 to 61440.

Click **Apply** to implement the new priority setting. To modify an entry on the table at the top of the window, click the corresponding **Edit** button. To view more information about an entry on the table at the top of the window, click the corresponding **View** button.

## MSTP Port Information

This window displays the current MSTI configuration information and can be used to update the port configuration for an MSTI ID. If a loop occurs, the MSTP function will use the port priority to select an interface to put into the forwarding state. Set a higher priority value for interfaces to be selected for forwarding first. In instances where the priority value is identical, the MSTP function will implement the lowest MAC address into the forwarding state and other interfaces will be blocked. Remember that lower priority values mean higher priorities for forwarding packets.

To view the following window, click **L2 Features > Spanning Tree > MSTP Port Information**:

**Figure 3 - 66. MSTP Port Information window**

The following parameters can be configured:

Parameter	Description
<b>Port</b>	Use the drop-down menu to select a port to be displayed.
<b>Internal Path Cost (1-20000000)</b>	This parameter is set to represent the relative cost of forwarding packets to specified ports when an interface is selected within an STP instance. Selecting this parameter with a value in the range of 1 to 20000000 will set the quickest route when a loop occurs. A lower

	Internal cost represents a quicker transmission. Selecting 0 (zero) for this parameter will set the quickest route automatically and optimally for an interface.
<b>Priority</b>	Enter a value between 0 and 240 to set the priority for the port interface. A higher priority will designate the interface to forward packets first. A lower number denotes a higher priority.

Click **Find** to see the information of the specific port. To modify the settings for a particular MSTI instance, click the **Edit** button and then enter a value in the Internal Path Cost field and use the drop-down menu to select a value for Priority.

## Link Aggregation

### Port Trunking

#### Understanding Port Trunk Groups

Port trunk groups are used to combine a number of ports together to make a single high-band-width data pipeline. Another advantage of implementing port trunk groups is redundancy, as if one of the ports or links fails in the port trunk group, the network connection to the remote Switch will be maintained. The table below shows the maximum amount of groups supported for each trunk group and the potential bit rate for the DGS-3200-10, DGS-3200-16, and DGS-3200-24 Switches.

Model	Maximum Number of Groups	Maximum Number of Ports	Potential Bit Rate
DGS-3200-10	5	8	8000 Mbps
DGS-3200-16	8	8	8000 Mbps
DGS-3200-24	12	8	8000 Mbps

Figure 3 - 67. Port Trunk Group Table for DGS-3200-10/DGS-3200-16/DGS-3200-24



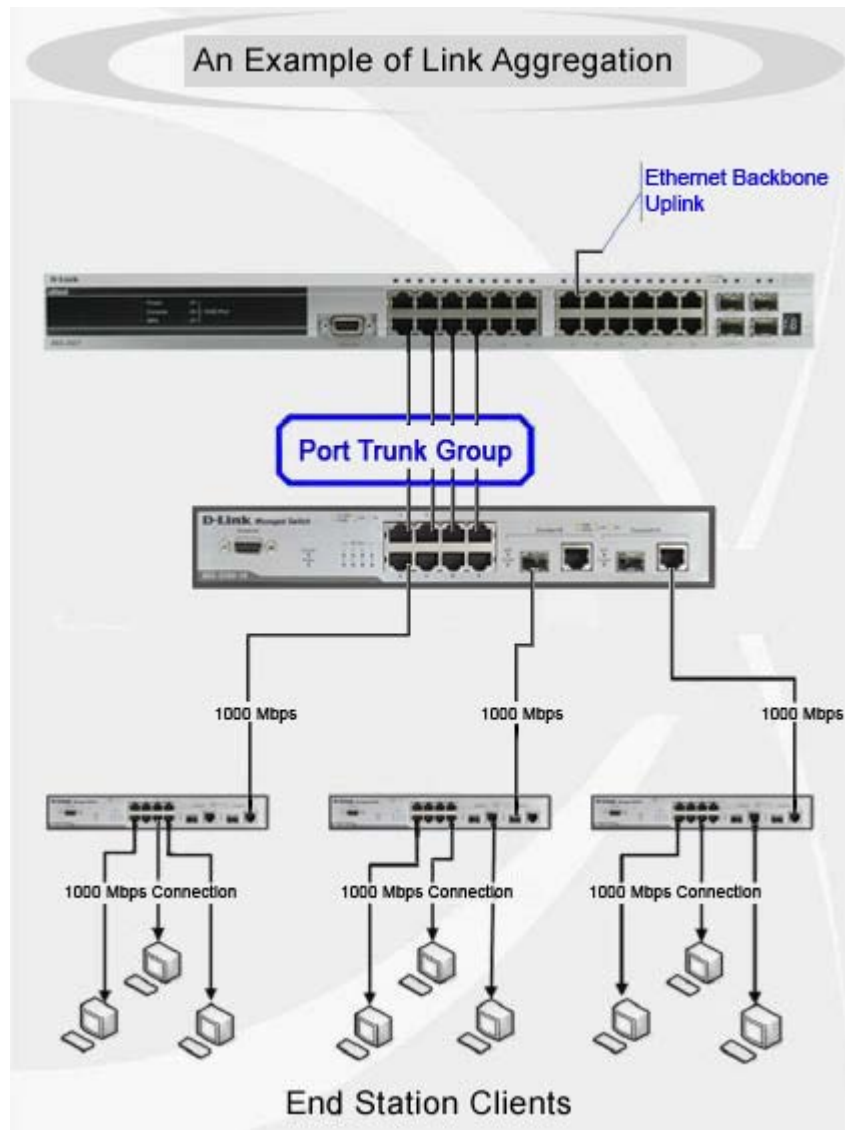

**Figure 3 - 68. Example of Typical Port Trunk Group**

The Switch treats all ports in a trunk group as a single port. Data transmitted to a specific host (destination address) will always be transmitted over the same port in a trunk group. This allows packets in a data stream to arrive in the same order they were sent.



**NOTE:** If any ports within the trunk group become disconnected, packets intended for the disconnected port will be load shared among the other linked ports of the link aggregation group.

Link aggregation allows several ports to be grouped together and to act as a single link. This gives a bandwidth that is a multiple of a single link's bandwidth.

Link aggregation is most commonly used to link a bandwidth intensive network device or devices, such as a server, to the backbone of a network.

The DGS-3200 Switch series supports the following link aggregation groups:

- The DGS-3200-10 model allows the creation of up to five link aggregation groups, each group consisting of 2 to 8 links (ports).
- The DGS-3200-16 model allows the creation of up to eight link aggregation groups, each group consisting of 2 to 8 links (ports).
- The DGS-3200-24 model allows the creation of up to twelve link aggregation groups, each group consisting of 2 to 8 links (ports).

The (optional) Gigabit ports can only belong to a single link aggregation group. All of the ports in the group must be members of the same VLAN, and their STP status, static multicast, traffic control; traffic segmentation and 802.1p default priority configurations must be identical. Port locking, port mirroring and 802.1X must not be enabled on the trunk group. Further, the LACP aggregated links must all be of the same speed and should be configured as full duplex.

The Master Port of the group is to be configured by the user, and all configuration options, including the VLAN configuration that can be applied to the Master Port, are applied to the entire link aggregation group.

Load balancing is automatically applied to the ports in the aggregated group, and a link failure within the group causes the network traffic to be directed to the remaining links in the group.

The Spanning Tree Protocol will treat a link aggregation group as a single link, on the switch level. For STP, the path cost of the link aggregation group is determined by the active port number of the link aggregation group. If two redundant link aggregation groups are configured on the Switch, STP will block one entire group; in the same way STP will block a single port that has a redundant link.

To view the following window, click **L2 Features > Link Aggregation > Port Trunking**:

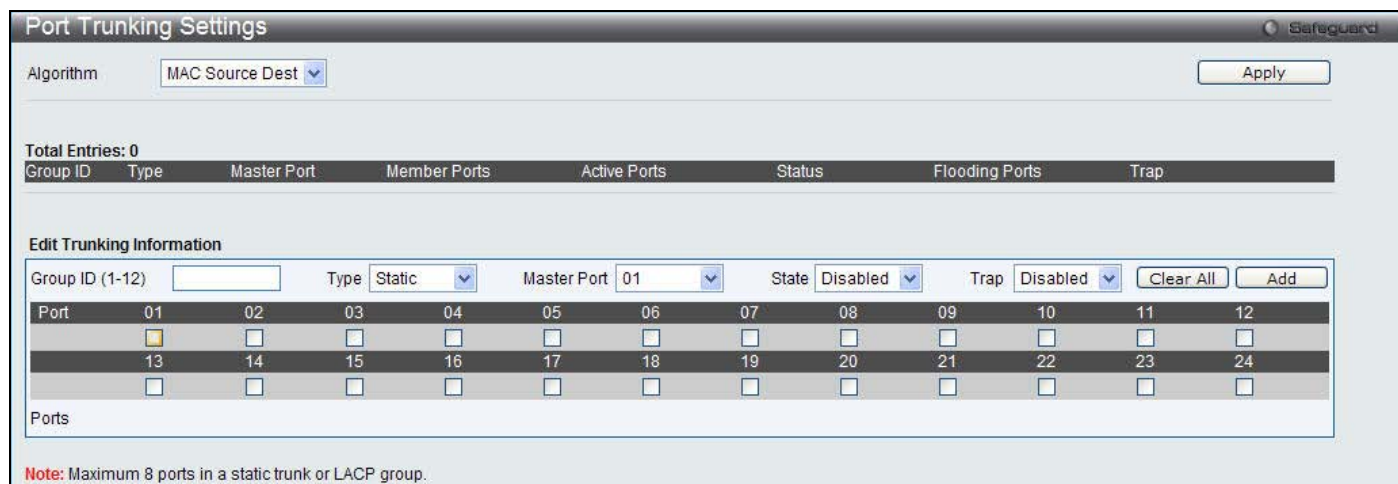

Figure 3 - 69. Port Trunking window

The following parameters can be configured or viewed:

Parameter	Description
<b>Algorithm</b>	Toggle between <i>MAC Source Dest</i> and <i>IP Source Dest</i> .
<b>Group ID (1-12)</b>	Select an ID number for the group, between 1 and 5 for the DGS-3200-10, between 1 and 8 for the DGS-3200-16, and between 1 and 12 for the DGS-3200-24.
<b>Type</b>	This drop-down menu allows users to select between <i>Static</i> and <i>LACP</i> (Link Aggregation Control Protocol). <i>LACP</i> allows for the automatic detection of links in a Port Trunking Group.
<b>Master Port</b>	Choose the Master Port for the trunk group using the drop-down menu.
<b>State</b>	Use the drop-down menu to toggle between <i>Enabled</i> and <i>Disabled</i> . This is used to turn a port trunking group on or off. This is useful for diagnostics, to quickly isolate a bandwidth intensive network device or to have an absolute backup aggregation group that is not under automatic control.
<b>Trap</b>	Use the drop-down menu to enable or disable trap. When set to enable, Link Up and Link Down notifications are enabled for this link aggregation group. When set to disable, Link Up and Link Down notifications are disabled for link aggregation group. By default, the trap status for a link aggregation group is disabled. This notification is generated when LACP logical interface link up (the first member port link up) and link down (the last member port link down).
<b>Member Ports</b>	Choose the members ports for the trunked group. Up to eight ports per group can be assigned to a group.
<b>Active Ports</b>	Shows the ports that are currently forwarding packets.

Click the **Apply** button to accept the changes made. Click the **Clear All** button to clear out all the information entered. Click the **Add** button to add a new entry based on the information entered.

## LACP Port Settings

In conjunction with the **Trunking** window, users can create port trunking groups on the Switch. Using the following window, the user may set which ports will be active and passive in processing and sending LACP control frames.

To view the following window, click **L2 Features > Link Aggregation > LACP Port Settings**:

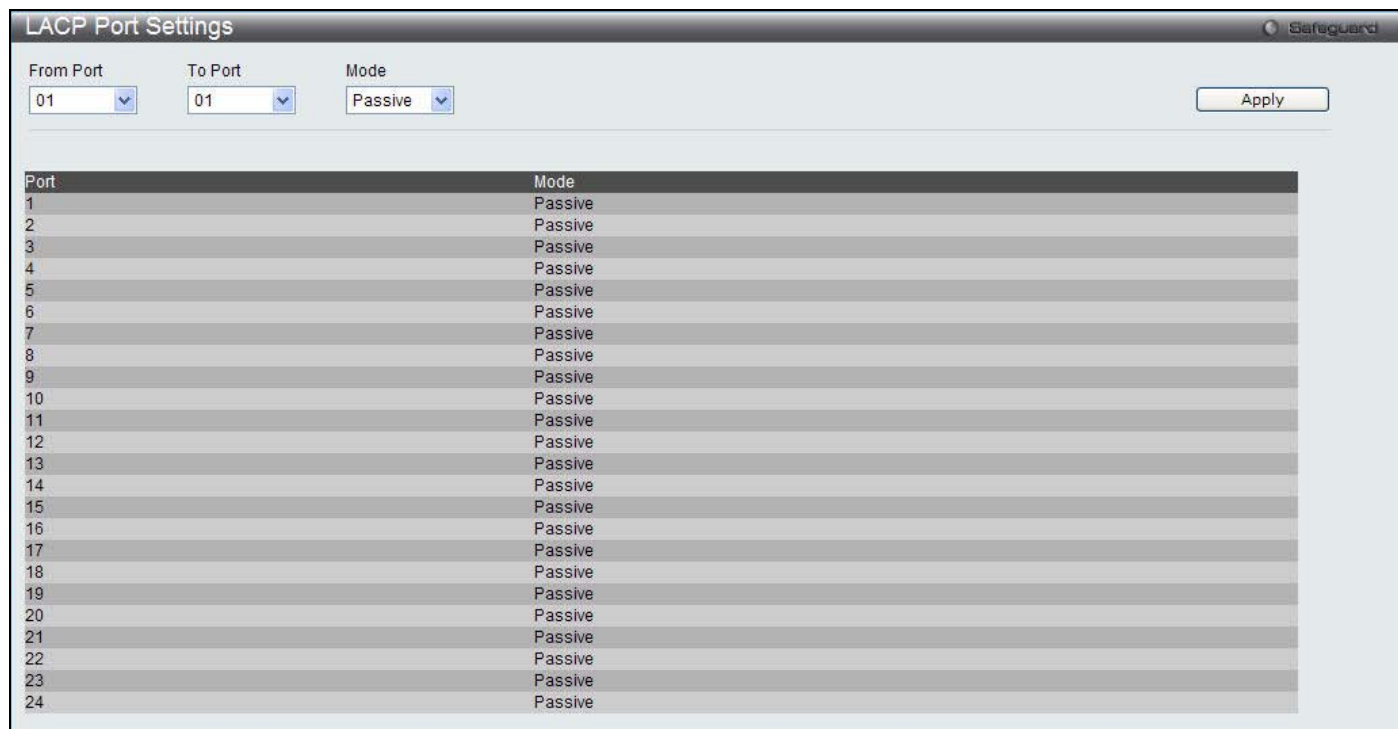

Figure 3 - 70. LACP Port Settings window

The user may set the following parameters:

Parameter	Description
<b>From Port / To Port</b>	Use the drop-down menus to select a range of ports to be configured.
<b>Mode</b>	<p><i>Active</i> - Active LACP ports are capable of processing and sending LACP control frames. This allows LACP compliant devices to negotiate the aggregated link so the group may be changed dynamically as needs require. In order to utilize the ability to change an aggregated port group, that is, to add or subtract ports from the group, at least one of the participating devices must designate LACP ports as active. Both devices must support LACP.</p> <p><i>Passive</i> - LACP ports that are designated as passive cannot initially send LACP control frames. In order to allow the linked port group to negotiate adjustments and make changes dynamically, one end of the connection must have "active" LACP ports (see above).</p>

Click **Apply** to implement the changes.

## Forwarding & Filtering

### Unicast Forwarding

Users can set up unicast forwarding on the Switch.

To view the following window, click **L2 Features > Forwarding & Filtering > Unicast Forwarding**:



Figure 3 - 71. Unicast Forwarding window

To add an entry to the Static Unicast Forwarding Table, define the following parameters. To modify an entry on the Static Unicast Forwarding Table, click the **Edit** button corresponding to the entry. To delete an entry in the Static Unicast Forwarding Table, click the corresponding **Delete** button.

Parameter	Description
<b>VLAN Name</b>	Click the radio button and specify the name of VLAN.
<b>VLAN List</b>	Click the radio button and specify a list of VLAN IDs.
<b>MAC Address</b>	The MAC address to which packets will be statically forwarded. This must be a unicast MAC address.
<b>Port / Drop</b>	Select <i>Port</i> and enter the port number to forward traffic to the specified device through this port. Select <i>Drop</i> to have the Switch to drop traffic.

Click **Apply** to implement the changes made.

## Multicast Forwarding

Users can set up multicast forwarding on the Switch.

To view the following window, click **L2 Features > Forwarding & Filtering > Multicast Forwarding**:

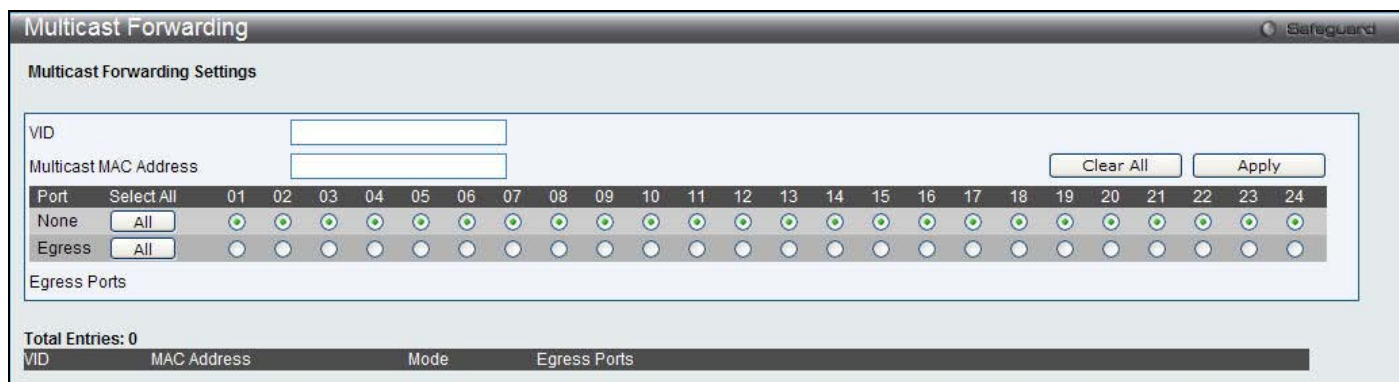

Figure 3 - 72. Multicast Forwarding window

The following parameters can be configured:

Parameter	Description
<b>VID</b>	The VLAN ID of the VLAN the corresponding MAC address belongs to.
<b>Multicast MAC Address</b>	The static destination MAC address of the multicast packets. This must be a multicast MAC address. The format of the destination MAC address is 01-xx-xx-xx-xx-xx.
<b>Port</b>	Allows the selection of ports that will be members of the static multicast group and ports that are either forbidden from joining dynamically, or that can join the multicast group dynamically, using GMRP. The options are:  <i>None</i> - No restrictions on the port dynamically joining the multicast group. When <i>None</i> is chosen, the port will not be a member of the Static Multicast Group.  <i>Egress</i> - The port is a static member of the multicast group.

Click **Apply** to implement the changes made. Click **Clear All** to remove all the information entered. Click **All** to select all ports.

## LLDP

## LLDP

### LLDP Global Settings

This window is used to configure the LLDP global settings.

To view the following window, click **L2 Features > LLDP > LLDP > LLDP Global Settings**:

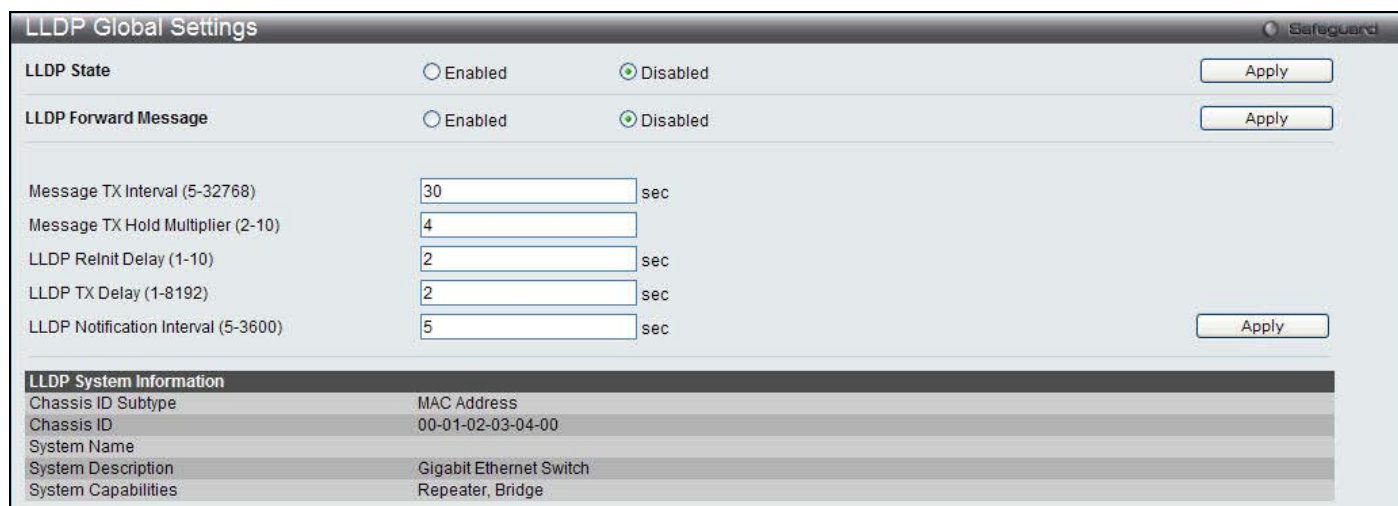

**Figure 3 - 73. LLDP Global Settings window**

The following parameters can be configured:

Parameter	Description
<b>LLDP State</b>	Click the radio buttons to enable or disable the LLDP feature.
<b>LLDP Forward Message</b>	When LLDP is disabled, this function controls the LLDP packet forwarding message based on individual ports. If LLDP is enabled on a port, it will flood the LLDP packet to all ports that have the same port VLAN and will advertise to other stations attached to the same IEEE 802 LAN.
<b>Message TX Interval (5-32768)</b>	This interval controls how often active ports retransmit advertisements to their neighbors. To change the packet transmission interval, enter a value between 5 and 35768 seconds.
<b>Message TX Hold Multiplier (2-10)</b>	This function calculates the Time-to-Live for creating and transmitting the LLDP advertisements to LLDP neighbors by changing the multiplier used by an LLDP Switch. When the Time-to-Live for an advertisement expires the advertised data is then deleted from the neighbor Switch's MIB.
<b>LLDP Reinit Delay (1-10)</b>	The LLDP re-initialization delay interval is the minimum time that an LLDP port will wait before reinitializing after receiving an LLDP disable command. To change the LLDP re-init delay, enter a value between 1 and 10 seconds.
<b>LLDP TX Delay (1-8192)</b>	LLDP TX Delay allows the user to change the minimum time delay interval for any LLDP port which will delay advertising any successive LLDP advertisements due to change in the LLDP MIB content. To change the LLDP TX Delay, enter a value between 1 and 8192 seconds.
<b>LLDP Notification</b>	LLDP Notification Interval is used to send notifications to configured SNMP trap

<b>Interval (5-3600)</b>	receiver(s) when an LLDP change is detected in an advertisement received on the port from an LLDP neighbor. To set the LLDP Notification Interval, enter a value between 5 and 3600 seconds.
--------------------------	--

Click **Apply** to implement the changes made.

## LLDP Port Settings

This window is used to configure the LLDP port parameters.

To view the following window, click **L2 Features > LLDP > LLDP > LLDP Port Settings**:

Port ID	Notification	Admin Status	IPv4(IPv6) Address
1	Disabled	TX and RX	
2	Disabled	TX and RX	
3	Disabled	TX and RX	
4	Disabled	TX and RX	
5	Disabled	TX and RX	
6	Disabled	TX and RX	
7	Disabled	TX and RX	
8	Disabled	TX and RX	
9	Disabled	TX and RX	
10	Disabled	TX and RX	
11	Disabled	TX and RX	
12	Disabled	TX and RX	
13	Disabled	TX and RX	
14	Disabled	TX and RX	
15	Disabled	TX and RX	
16	Disabled	TX and RX	
17	Disabled	TX and RX	
18	Disabled	TX and RX	
19	Disabled	TX and RX	
20	Disabled	TX and RX	
21	Disabled	TX and RX	
22	Disabled	TX and RX	
23	Disabled	TX and RX	
24	Disabled	TX and RX	

**Figure 3 - 74. LLDP Port Settings window**

The following parameters can be configured:

Parameter	Description
<b>From Port / To Port</b>	Use the drop-down menus to select a range of ports to be configured.
<b>Notification</b>	Use the drop-down menu to enable or disable the status of the LLDP notification. This function controls the SNMP trap however it cannot implement traps on SNMP when the notification is disabled.
<b>Admin Status</b>	This function controls the local LLDP agent and allows it to send and receive LLDP frames on the ports. This option contains <i>TX</i> , <i>RX</i> , <i>TX And RX</i> or <i>Disabled</i> . <i>TX</i> - the local LLDP agent can only transmit LLDP frames. <i>RX</i> - the local LLDP agent can only receive LLDP frames. <i>TX and RX</i> - the local LLDP agent can both transmit and receive LLDP frames. <i>Disabled</i> - the local LLDP agent can neither transmit nor receive LLDP frames. The default value is TX And RX.
<b>Subtype</b>	Use the drop-down menu to select the type of the IP address information will be sent.
<b>Action</b>	Use the drop-down menu to enable or disable the action field.

<b>Address</b>	Enter the IP address that will be sent.
----------------	---

Click **Apply** to implement the changes made.

## LLDP Management Address List

This window is used to view the LLDP management address list.

To view the following window, click **L2 Features > LLDP > LLDP > LLDP Management Address List**:



**Figure 3 - 75. LLDP Management Address List window**

The following parameters can be configured:

Parameter	Description
<b>IPv4 / IPv6</b>	Use the drop-down menu to select either IPv4 or IPv6.
<b>Address</b>	Enter the management IP address or the IP address of the entity you wish to advertise to. The IPv4 address is a management IP address, so the IP information will be sent with the frame.

Click the **Find** button to locate a specific entry based on the information entered.

## LLDP Basic TLVs Settings

TLV stands for Type-length-value, which allows the specific sending information as a TLV element within LLDP packets. This window is used to enable the settings for the Basic TLVs Settings. An active LLDP port on the Switch always included mandatory data in its outbound advertisements. There are four optional data types that can be configured for an individual port or group of ports to exclude one or more of these data types from outbound LLDP advertisements. The mandatory data type includes four basic types of information (end of LLDPDU TLV, chassis ID TLV, port ID TLV, and Time to Live TLV). The mandatory data types cannot be disabled. There are also four data types which can be optionally selected. These include Port Description, System Name, System Description and System Capability.

To view the following window, click **L2 Features > LLDP > LLDP > LLDP Basic TLVs Settings**:

Port	Port Description	System Name	System Description	System Capabilities
1	Disabled	Disabled	Disabled	Disabled
2	Disabled	Disabled	Disabled	Disabled
3	Disabled	Disabled	Disabled	Disabled
4	Disabled	Disabled	Disabled	Disabled
5	Disabled	Disabled	Disabled	Disabled
6	Disabled	Disabled	Disabled	Disabled
7	Disabled	Disabled	Disabled	Disabled
8	Disabled	Disabled	Disabled	Disabled
9	Disabled	Disabled	Disabled	Disabled
10	Disabled	Disabled	Disabled	Disabled
11	Disabled	Disabled	Disabled	Disabled
12	Disabled	Disabled	Disabled	Disabled
13	Disabled	Disabled	Disabled	Disabled
14	Disabled	Disabled	Disabled	Disabled
15	Disabled	Disabled	Disabled	Disabled
16	Disabled	Disabled	Disabled	Disabled
17	Disabled	Disabled	Disabled	Disabled
18	Disabled	Disabled	Disabled	Disabled
19	Disabled	Disabled	Disabled	Disabled
20	Disabled	Disabled	Disabled	Disabled
21	Disabled	Disabled	Disabled	Disabled
22	Disabled	Disabled	Disabled	Disabled
23	Disabled	Disabled	Disabled	Disabled
24	Disabled	Disabled	Disabled	Disabled

Figure 3 - 76. LLDP Basic TLVs Settings window

The following parameters can be configured:

Parameter	Description
<b>From Port / To Port</b>	Use the drop-down menus to select a range of ports to be configured.
<b>Port Description</b>	Use the drop-down menu to enable or disable the Port Description option.
<b>System Name</b>	Use the drop-down menu to enable or disable the System Name option.
<b>System Description</b>	Use the drop-down menu to enable or disable the System Description option.
<b>System Capabilities</b>	Use the drop-down menu to enable or disable the System Capabilities option.

Click **Apply** to implement the changes made.

## LLDP Dot1 TLVs Settings

LLDP Dot1 TLVs are organizationally specific TLVs which are defined in IEEE 802.1 and used to configure an individual port or group of ports to exclude one or more of the IEEE 802.1 organizational port VLAN ID TLV data types from outbound LLDP advertisements.

To view the following window, click **L2 Features > LLDP > LLDP > LLDP Dot1 TLVs Settings**:



Port	PVID State	Port and Protocol VID State	VID	VLAN Name State	VID	Protocol Identity State	Protocol Identity
1	Disabled	Disabled		Disabled		Disabled	
2	Disabled	Disabled		Disabled		Disabled	
3	Disabled	Disabled		Disabled		Disabled	
4	Disabled	Disabled		Disabled		Disabled	
5	Disabled	Disabled		Disabled		Disabled	
6	Disabled	Disabled		Disabled		Disabled	
7	Disabled	Disabled		Disabled		Disabled	
8	Disabled	Disabled		Disabled		Disabled	
9	Disabled	Disabled		Disabled		Disabled	
10	Disabled	Disabled		Disabled		Disabled	
11	Disabled	Disabled		Disabled		Disabled	
12	Disabled	Disabled		Disabled		Disabled	
13	Disabled	Disabled		Disabled		Disabled	
14	Disabled	Disabled		Disabled		Disabled	
15	Disabled	Disabled		Disabled		Disabled	
16	Disabled	Disabled		Disabled		Disabled	
17	Disabled	Disabled		Disabled		Disabled	
18	Disabled	Disabled		Disabled		Disabled	
19	Disabled	Disabled		Disabled		Disabled	
20	Disabled	Disabled		Disabled		Disabled	
21	Disabled	Disabled		Disabled		Disabled	
22	Disabled	Disabled		Disabled		Disabled	
23	Disabled	Disabled		Disabled		Disabled	
24	Disabled	Disabled		Disabled		Disabled	

Figure 3 - 77. LLDP Dot1 TLVs Settings window

The following parameters can be configured:

Parameter	Description
<b>From Port / To Port</b>	Use the drop-down menus to select a range of ports to be configured.
<b>Dot1 TLV PVID</b>	Use the drop-down menu to enable or disable and configure the Dot1 TLV PVID option.
<b>Dot1 TLV Protocol VLAN</b>	Use the drop-down menu to enable or disable, and configure the Dot1 TLV Protocol VLAN option. After enabling this option, the user can select to use either <i>VLAN Name</i> , <i>VLAN ID</i> or <i>All</i> in the next drop-down menu. After selecting this, the user can enter either the VLAN name or VLAN ID in the space provided.
<b>Dot1 TLV VLAN</b>	Use the drop-down menu to enable or disable, and configure the Dot1 TLV VLAN option. After enabling this option, the user can select to use either <i>VLAN Name</i> , <i>VLAN ID</i> or <i>All</i> in the next drop-down menu. After selecting this, the user can enter either the VLAN name or VLAN ID in the space provided.
<b>Dot1 TLV Protocol Identity</b>	Use the drop-down menu to enable or disable, and configure the Dot1 TLV Protocol Identity option. After enabling this option the user can select to either use <i>EAPOL</i> , <i>LACP</i> , <i>GVRP</i> , <i>STP</i> , or <i>All</i> .

Click **Apply** to implement the changes made.

## LLDP Dot3 TLVs Settings

This window is used to configure an individual port or group of ports to exclude one or more IEEE 802.3 organizational specific TLV data type from outbound LLDP advertisements.

To view the following window, click **L2 Features > LLDP > LLDP > LLDP Dot3 TLVs Settings**:

Port	MAC / PHY Configuration Status	Link Aggregation	Maximum Frame Size
1	Disabled	Disabled	Disabled
2	Disabled	Disabled	Disabled
3	Disabled	Disabled	Disabled
4	Disabled	Disabled	Disabled
5	Disabled	Disabled	Disabled
6	Disabled	Disabled	Disabled
7	Disabled	Disabled	Disabled
8	Disabled	Disabled	Disabled
9	Disabled	Disabled	Disabled
10	Disabled	Disabled	Disabled
11	Disabled	Disabled	Disabled
12	Disabled	Disabled	Disabled
13	Disabled	Disabled	Disabled
14	Disabled	Disabled	Disabled
15	Disabled	Disabled	Disabled
16	Disabled	Disabled	Disabled
17	Disabled	Disabled	Disabled
18	Disabled	Disabled	Disabled
19	Disabled	Disabled	Disabled
20	Disabled	Disabled	Disabled
21	Disabled	Disabled	Disabled
22	Disabled	Disabled	Disabled
23	Disabled	Disabled	Disabled
24	Disabled	Disabled	Disabled

Figure 3 - 78. LLDP Dot3 TLVs Settings window

The following parameters can be configured:

Parameter	Description
<b>From Port / To Port</b>	Use the drop-down menus to select a range of ports to be configured.
<b>MAC / PHY configuration Status</b>	This TLV optional data type indicates that the LLDP agent should transmit the MAC/PHY configuration/status TLV. This indicates it is possible for two ends of an IEEE 802.3 link to be configured with different duplex and/or speed settings and still establish some limited network connectivity. More precisely, the information includes whether the port supports the auto-negotiation function, whether the function is enabled, whether it has auto-negotiated advertised capability, and what is the operational MAU type. The default state is Disabled.
<b>Link Aggregation</b>	The Link Aggregation option indicates that LLDP agents should transmit 'Link Aggregation TLV'. This indicates the current link aggregation status of IEEE 802.3 MACs. More precisely, the information should include whether the port is capable of doing link aggregation, whether the port is aggregated in an aggregated link, and what is the aggregated port ID. The default state is Disabled.
<b>Maximum Frame Size</b>	The Maximum Frame Size indicates that LLDP agent should transmit 'Maximum-frame-size TLV'. The default state is Disabled.

Click **Apply** to implement the changes made.

## LLDP Statistics System

This window displays an overview of the neighbor detection activity, LLDP Statistics and the settings for individual ports on the Switch.

To view the following window, click **L2 Features > LLDP > LLDP > LLDP Statistics System**:



Figure 3 - 79. LLDP Statistics System window

Select a **Port** number from the drop-down menu and click the **Find** button to view statistics for a certain port.

### LLDP Local Port Information

This window displays the information on a per port basis currently available for populating outbound LLDP advertisements in the local port brief table shown below.

To view the following window, click **L2 Features > LLDP > LLDP > LLDP Local Port Information**:

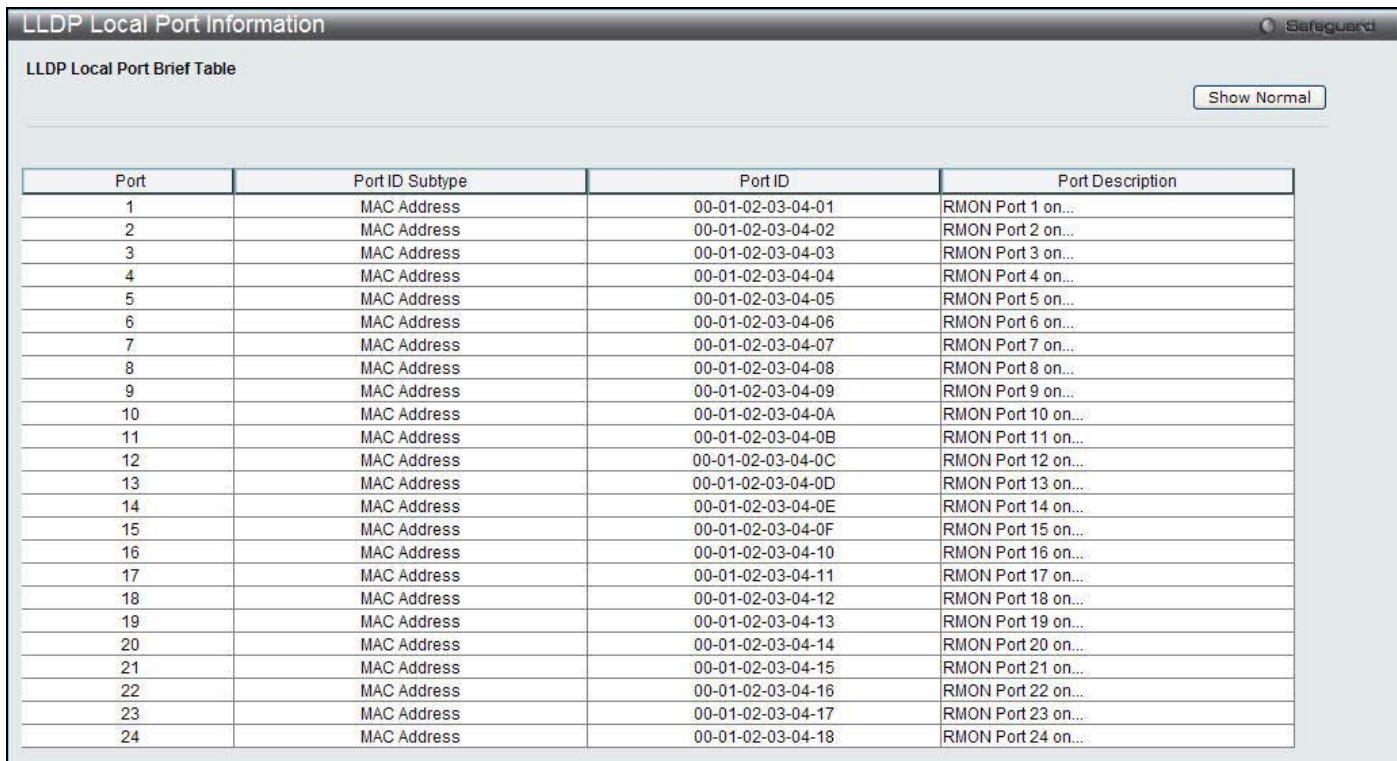

Figure 3 - 80. LLDP Local Port Information window

To view the normal LLDP Local Port information page per port, click the **Show Normal** button.

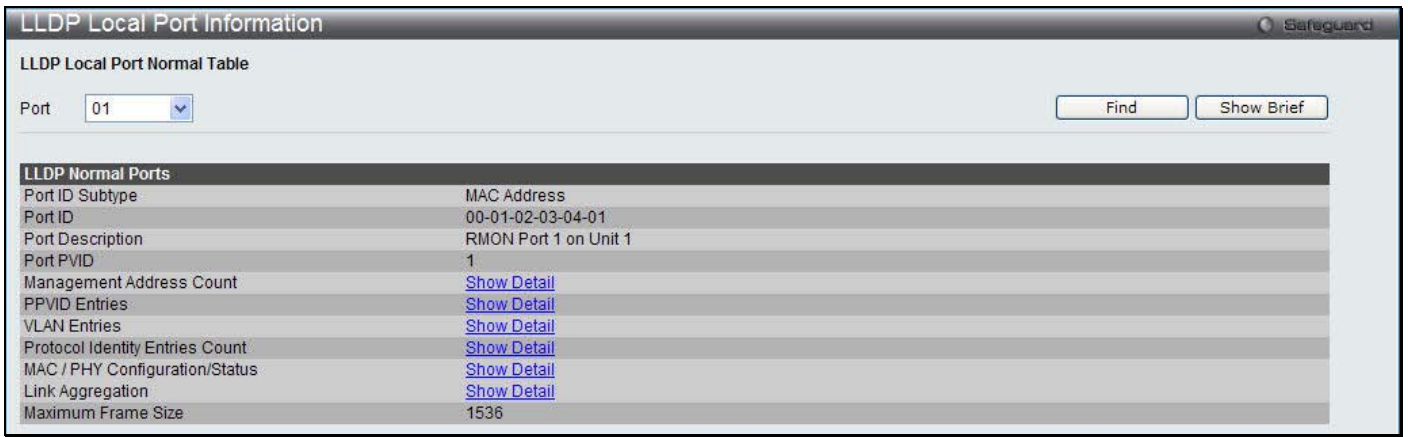

Figure 3 - 81. LLDP Local Port Information – Show Normal window

Select a **Port** number and click the **Find** button to locate a specific entry. To view the brief LLDP Local Port information page per port, click the **Show Brief** button.

To view more details about, for example, the **Management Address Count**, click the [Show Detail](#) hyperlink.



Figure 3 - 82. LLDP Local Port Information – Show Detail window

Click the <<**Back** button to return to the previous page.

## LLDP Remote Port Information

This window displays port information learned from the neighbors. The Switch receives packets from a remote station but is able to store the information as local.

To view the following window, click **L2 Features > LLDP > LLDP > LLDP Local Port Information**:



Figure 3 - 83. LLDP Remote Port Information window

Select a **Port** number and click the **Find** button to locate a specific entry.

To view the normal LLDP Local Port information page per port, click the **Show Normal** button.



Figure 3 - 84. LLDP Local Port Information – Show Normal window

Click the <<Back button to return to the previous page.

## LLDP-MED

### LLDP-MED System Settings

This window is used to configure the LLDP-MED log state and the fast start repeat count, and display the LLDP-MED system information.

To view the following window, click **L2 Features > LLDP > LLDP-MED > LLDP-MED System Settings**:

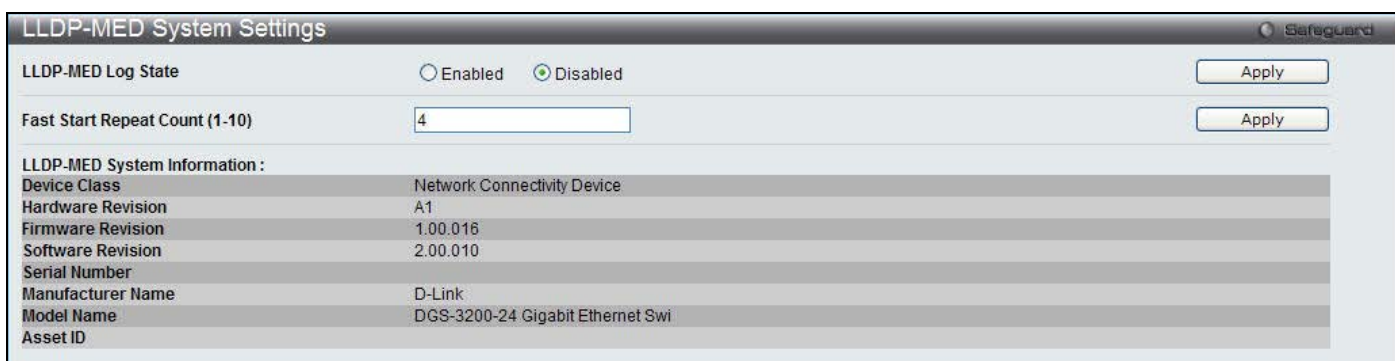

Figure 3 - 85. LLDP-MED System Settings window

The following parameters can be configured:

Parameter	Description
<b>LLDP-MED Log State</b>	Click the radio buttons to enable or disable the log state of LLDP-MED events.
<b>Fast Start Repeat Count (1-10)</b>	Enter a value between 1 and 10 for the fast start repeat count. When an LLDP-MED Capabilities TLV is detected for an MSAP identifier not associated with an existing LLDP remote system MIB, then the application layer shall start the fast start mechanism and set the 'medFastStart' timer to 'medFastStartRepeatCount' times 1. The default value is 4.

Click **Apply** to implement the changes made.

### LLDP-MED Port Settings

This window is used to enable or disable transmitting LLDP-MED TLVs.

To view the following window, click **L2 Features > LLDP > LLDP-MED > LLDP-MED Port Settings**:

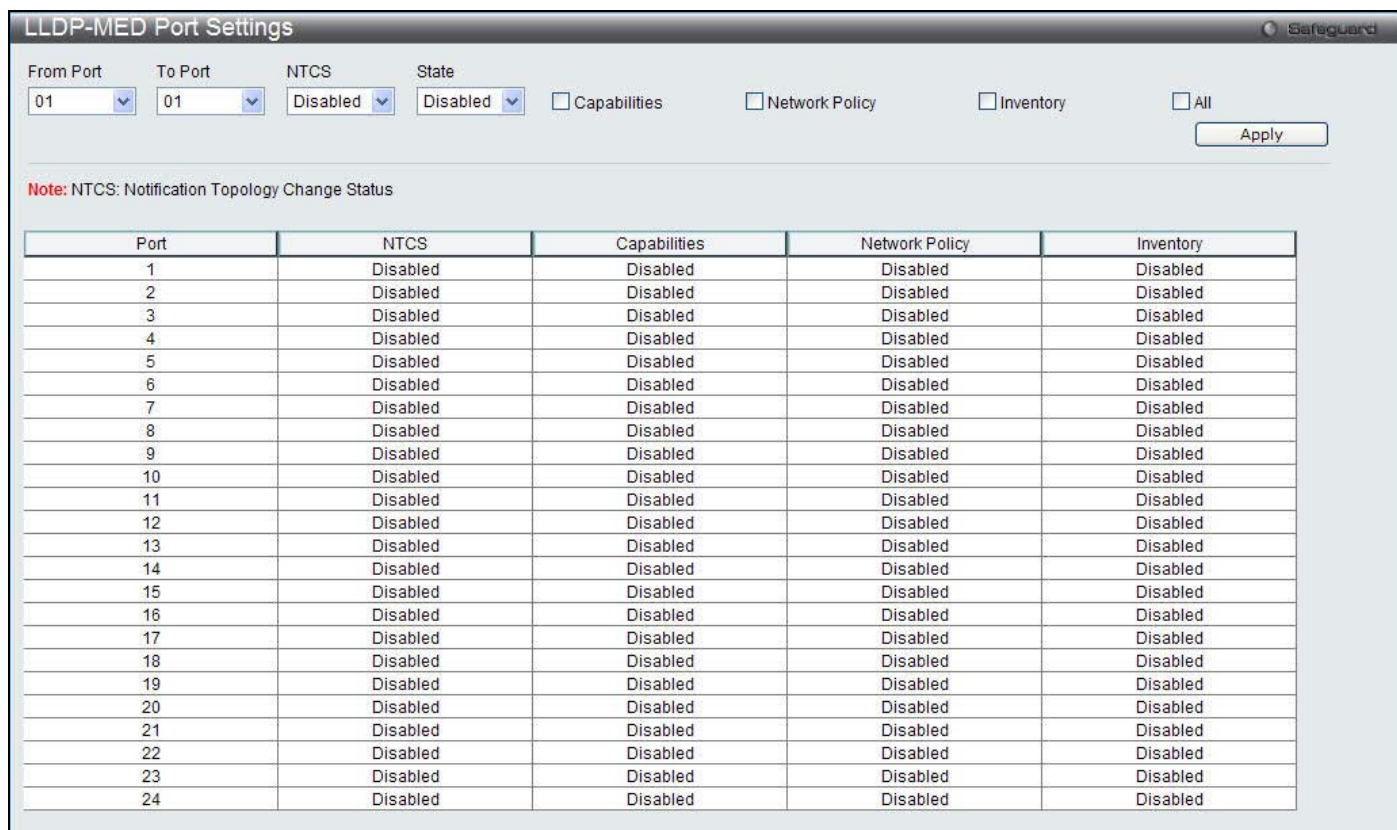

Figure 3 - 86. LLDP-MED Port Settings window

The following parameters can be configured:

Parameter	Description
<b>From Port / To Port</b>	Use the drop-down menus to select a range of ports to be configured.
<b>NTCS</b>	Use the drop-down menu to enable or disable Notification Topology Change Status.
<b>State</b>	Use the drop-down menu to enable or disable transmit LLDP-MED TLVs, and tick the check boxes of the TLV types that the LLDP agent should transmit. TLV types are <b>Capabilities</b> , <b>Network Policy</b> , and <b>Inventory</b> . Tick the <b>All</b> check box to select all TLV types.

Click **Apply** to implement the changes made.

## LLDP-MED Local Port Information

This window displays the per-port information currently available for populating outbound LLDP-MED advertisements.

To view the following window, click **L2 Features > LLDP > LLDP-MED > LLDP-MED Local Port Information**:



Figure 3 - 87. LLDP-MED Local Port Information window

Select a **Port** number and click the **Find** button to locate a specific entry.

## LLDP-MED Remote Port Information

This window displays the information learned from the neighbor parameters.

To view the following window, click **L2 Features > LLDP > LLDP-MED > LLDP-MED Remote Port Information**:



Figure 3 - 88. LLDP-MED Remote Port Information window

Select a **Port** number and click the **Find** button to locate a specific entry.

To view the normal LLDP Remote Port information page per port, click the **Show Normal** button.



Figure 3 - 89. LLDP-MED Remote Port Information – Show Normal window

Click the **<<Back** button to return to the previous page.

## NLB FDB Settings

The Switch supports Network Load Balancing (NLB). This is a MAC forwarding control for supporting the Microsoft server load balancing application where multiple servers can share the same IP address and MAC address. The requests from clients will be forwarded to all servers, but will only be processed by one of them. In multicast mode, the client uses a multicast MAC address as the destination MAC to reach the server. Regardless of the mode, the destination MAC is the shared MAC. The server uses its own MAC address (rather than the shared MAC) as the source MAC address of the reply packet. The NLB multicast FDB entry will be mutually exclusive with the L2 multicast entry.

To view the following window, click **L2 Features > NLB FDB Settings**:

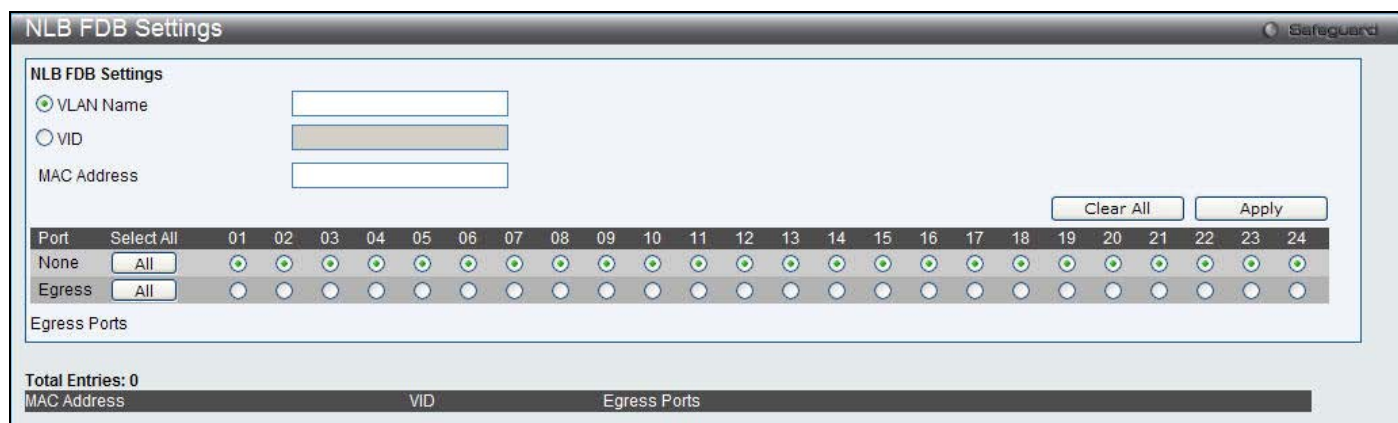

Figure 3 - 90. NLB FDB Settings window

The following parameters can be configured:

Parameter	Description
<b>VLAN Name</b>	Click the radio button and enter the VLAN name of the NLB multicast FDB entry to be created.
<b>VID</b>	Click the radio button and enter the VLAN by the VLAN ID.
<b>MAC Address</b>	Enter the MAC address of the NLB multicast FDB entry to be created.
<b>Port</b>	Choose the forwarding ports for the specified NLB multicast FDB entry. <i>None</i> – The port is not the forwarding port. <i>Egress</i> - The port is the forwarding port.

Click **Apply** to implement the changes made. Click **Clear All** to remove all the information entered. Click **All** to select all ports.



## L3 Features

*IPv4 Static/Default Router Settings*

*IPv4 Route Table*

*IPv6 Interface Settings*

*IPv6 Route Settings*

*IPv6 Neighbor Settings*

### IPv4 Static/Default Route Settings

The Switch supports static routing for IPv4 formatted addressing. Users can create up to 512 static route entries for IPv4. For IPv4 static routes, once a static route has been set, the Switch will send an ARP request packet to the next hop router that has been set by the user. Once an ARP response has been retrieved by the switch from that next hop, the route becomes enabled. However, if the ARP entry already exists, an ARP request will not be sent.

The Switch also supports a floating static route, which means that the user may create an alternative static route to a different next hop. This secondary next hop device route is considered as a backup static route for when the primary static route is down. If the primary route is lost, the backup route will uplink and its status will become Active.

Entries into the Switch's forwarding table can be made using both an IP address subnet mask and a gateway.

To view the following window, click **L3 Features > IPv4 Static/Default Route Settings**:

**Figure 4 - 1. IPv4 Route Settings Window**

The following parameters can be configured:

Parameter	Description
<b>Gateway</b>	This field allows the entry of a Gateway IP Address to be applied to the corresponding gateway of the IP address.
<b>Metric (1-65535)</b>	Represents the metric value of the IP interface entered into the table. This field may read a number between 1 and 65535.

Click **Apply** to implement the changes made. Click **Delete** to remove the specific entry.

### IPv4 Route Table

The IP routing table stores all the external routes information of the switch. This window displays all the external route information on the Switch.

To view the following window, click **L3 Features > IPv4 Route Table**:

IPv4 Route Table					
Total Entries: 1					
IP Address	Netmask	Gateway	Interface Name	Hops	Protocol
10.0.0.0	255.0.0.0	0.0.0.0	System	1	Local

Figure 4 - 2. IPv4 Route Settings Window

Enter a page number and click the **Go** button to navigate to a specific page when multiple pages exist.

## IPv6 Interface Settings

This window is used to display the Switch’s current IPv6 interface settings.

To view the following window, click **L3 Features > IPv6 Interface Settings**:

Interface Name:  VLAN Name:

Interface Admin State:  Create

Interface	VLAN Name	Active	
System	default	Enabled	<span>Edit</span> <span>Delete</span>

Figure 4 - 3. IPv6 Interface Settings Window

To configure IPv6 interface settings, enter an Interface Name, a VLAN Name, and make sure the Interface Admin. State is *Enabled*. Click the **Create** button. The new entry will appear in the Interface Table at the bottom of the window.

To modify an IPv6 Interface Table entry, click the corresponding **Edit** button. The following window opens:

Interface Name: System

VLAN Name:

IPv6 Address:

Admin. State:

DHCPv6 Client:

Link Status: LinkUp

Member Ports: 1-24

NS Retransmit time (0-4294967295):  ms Apply

Automatic Link Local Address:  Apply

IPv6 Type:  IPv6 Address:

Figure 4 - 4. IPv6 Interface Settings (Edit) Window

The following parameters can be configured or viewed:

Parameter	Description
<b>Interface Name</b>	The name of the IPv6 interface being modified.
<b>VLAN Name</b>	Enter the VLAN name of the IPv6 interface.
<b>IPv6 Address</b>	Enter the IPv6 address of the interface to be modified.
<b>Admin. State</b>	Toggle the state between <i>Enabled</i> and <i>Disabled</i> .
<b>DHCPv6 Client</b>	Use the drop-down menu to enable or disable DHCPv6 client.

<b>Link Status</b>	Displays whether the IPv6 Interface is <i>Up</i> or <i>Down</i> .
<b>Member Ports</b>	Displays the port numbers that are part of the IPv6 Interface.
<b>NS Retransmit Time (0-4294967295)</b>	Enter a value between 0 and 4294967295. This is the neighbor solicitation's retransmit timer in milliseconds. The default is zero.
<b>Automatic Link Local Address</b>	Toggle between <i>Enabled</i> and <i>Disabled</i> . Enabling this is helpful when no external source of network addressing information is available.

After making the desired changes, click the **Apply** button in the top section of the window.

## IPv6 Route Settings

A static entry of an IPv6 address can be entered into the Switch's routing table for IPv6 formatted addresses.

To view the following window, click **L3 Features > IPv6 Route Settings**:

Figure 4 - 5. IPv6 Route Settings Window

The following parameters can be configured:

Parameter	Description
<b>Interface Name</b>	The IP Interface where the static IPv6 route is created.
<b>Nexthop Address</b>	The corresponding IPv6 address for the next hop Gateway address in IPv6 format.
<b>Metric (1-65535)</b>	The metric of the IPv6 interface entered into the table representing the number of routers between the Switch and the IPv6 address above. Metric values allowed are between 1 and 65535.

Click **Apply** to implement the changes made. Click **Delete All** to remove all the entries.

## IPv6 Neighbor Settings

The user can configure the Switch's IPv6 neighbor settings. The Switch's current IPv6 neighbor settings will be displayed in the table at the bottom of this window.

To view the following window, click **L3 Features > IPv6 Neighbor Settings**:

Figure 4 - 6. IPv6 Neighbor Settings Window

The following parameters may be configured or viewed:

Parameter	Description
<b>Interface Name</b>	Enter the name of the IPv6 neighbor. To search for all the current interfaces on the Switch, go to the second Interface Name field in the middle part of the window, tick the All check box, and then click the <b>Find</b> button.
<b>Neighbor IPv6 Address</b>	Enter the neighbor IPv6 address.
<b>Link Layer MAC Address</b>	Enter the link layer MAC address.
<b>State</b>	Use the drop-down menu to select <i>All</i> , <i>Address</i> , <i>Static</i> , or <i>Dynamic</i> .

Enter the Interface Name, Neighbor IPv6 Address, and the Link Layer MAC Address and then click the **Add** button. The State can be set to *All*, *Address*, *Static*, or *Dynamic*.

To look for an IPv6 Neighbor Settings table entry, enter the Interface Name, select the desired State in the middle section of this window, and then click the **Find** button.

To delete all the entries being displayed on the table at the bottom of this window, click the **Clear** button.

**Section 5**

# QoS

**Bandwidth Control**

**Queue Bandwidth Control Settings**

**Traffic Control**

**802.1p Default Priority**

**802.1p User Priority**

**QoS Scheduling Mechanism**

QoS is an implementation of the IEEE 802.1p standard that allows network administrators a method of reserving bandwidth for important functions that require a large bandwidth or have a high priority, such as VoIP (voice-over Internet Protocol), web browsing applications, file server applications or video conferencing. Not only can a larger bandwidth be created, but other less critical traffic can be limited, so excessive bandwidth can be saved. The Switch has separate hardware queues on every physical port to which packets from various applications can be mapped to, and, in turn prioritized. View the following map to see how the Switch implements basic 802.1P priority queuing.

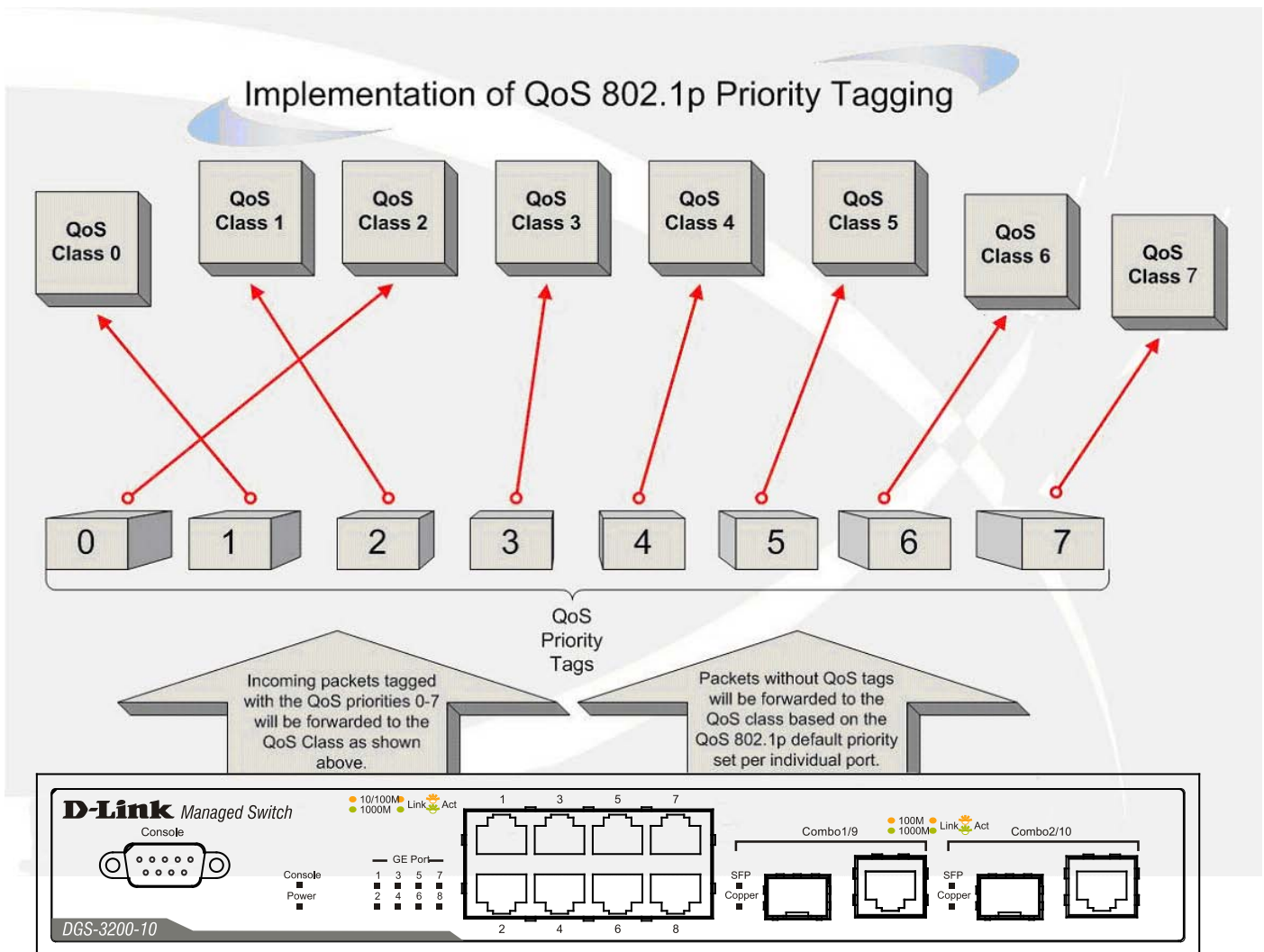

**Figure 5 - 1. An Example of the Default QoS Mapping on the Switch**

The picture above shows the default priority setting for the Switch. Class-7 has the highest priority of the seven priority classes of service on the Switch. In order to implement QoS, the user is required to instruct the Switch to examine the header of a packet to see if it has the proper identifying tag. Then the user may forward these tagged packets to designated classes of service on the Switch where they will be emptied, based on priority.

For example, let's say a user wishes to have a video conference between two remotely set computers. The administrator can add priority tags to the video packets being sent out, utilizing the Access Profile commands. Then, on the receiving end, the administrator instructs the Switch to examine packets for this tag, acquires the tagged packets and maps them to a class queue on the Switch. Then in turn, the administrator will set a priority for this queue so that will be emptied before any other packet is forwarded. This results in the end user receiving all packets sent as quickly as possible, thus prioritizing the queue and allowing for an uninterrupted stream of packets, which optimizes the use of bandwidth available for the video conference.

## Understanding QoS

The Switch supports 802.1p priority queuing. The Switch has eight priority queues. These priority queues are numbered from 7 (Class 7) — the highest priority queue — to 0 (Class 0) — the lowest priority queue. The eight priority tags specified in IEEE 802.1p (p0 to p7) are mapped to the Switch's priority queues as follows:

- Priority 0 is assigned to the Switch's Q2 queue.
- Priority 1 is assigned to the Switch's Q0 queue.
- Priority 2 is assigned to the Switch's Q1 queue.
- Priority 3 is assigned to the Switch's Q3 queue.
- Priority 4 is assigned to the Switch's Q4 queue.
- Priority 5 is assigned to the Switch's Q5 queue.
- Priority 6 is assigned to the Switch's Q6 queue.
- Priority 7 is assigned to the Switch's Q7 queue.

For strict priority-based scheduling, any packets residing in the higher priority classes of service are transmitted first. Multiple strict priority classes of service are emptied based on their priority tags. Only when these classes are empty, are packets of lower priority transmitted.

For weighted round-robin queuing, the number of packets sent from each priority queue depends upon the assigned weight. For a configuration of eight CoS queues, A~H with their respective weight value: 8~1, the packets are sent in the following sequence: A1, B1, C1, D1, E1, F1, G1, H1, A2, B2, C2, D2, E2, F2, G2, A3, B3, C3, D3, E3, F3, A4, B4, C4, D4, E4, A5, B5, C5, D5, A6, B6, C6, A7, B7, A8, A1, B1, C1, D1, E1, F1, G1, H1.

For weighted round-robin queuing, if each CoS queue has the same weight value, then each CoS queue has an equal opportunity to send packets just like round-robin queuing.

For weighted round-robin queuing, if the weight for a CoS is set to 0, then it will continue processing the packets from this CoS until there are no more packets for this CoS. The other CoS queues that have been given a nonzero value, and depending upon the weight, will follow a common weighted round-robin scheme.

Remember that the Switch has seven configurable priority queues (and seven Classes of Service) for each port on the Switch.



**NOTICE:** The Switch contains eight classes of service for each port on the Switch. One of these classes is reserved for internal use on the Switch and is therefore not configurable. All references in the following section regarding classes of service will refer to only the seven classes of service that may be used and configured by the administrator.

## Bandwidth Control

The bandwidth control settings are used to place a ceiling on the transmitting and receiving data rates for any selected port.

To view the following window, click **QoS > Bandwidth Control**:

The screenshot shows the 'Bandwidth Control' window with the following configuration: From Port: 01, To Port: 01, Type: RX, No Limit: Disabled, Rate: (empty) Kbit/sec. Below the configuration is a 'Bandwidth Control Table' with 24 rows, each representing a port from 1 to 24. Each row shows RX Rate, TX Rate, Effective RX, and Effective TX, all set to 'No Limit'.

Port	RX Rate (Kbit/sec)	TX Rate (Kbit/sec)	Effective RX (Kbit/sec)	Effective TX (Kbit/sec)
1	No Limit	No Limit	No Limit	No Limit
2	No Limit	No Limit	No Limit	No Limit
3	No Limit	No Limit	No Limit	No Limit
4	No Limit	No Limit	No Limit	No Limit
5	No Limit	No Limit	No Limit	No Limit
6	No Limit	No Limit	No Limit	No Limit
7	No Limit	No Limit	No Limit	No Limit
8	No Limit	No Limit	No Limit	No Limit
9	No Limit	No Limit	No Limit	No Limit
10	No Limit	No Limit	No Limit	No Limit
11	No Limit	No Limit	No Limit	No Limit
12	No Limit	No Limit	No Limit	No Limit
13	No Limit	No Limit	No Limit	No Limit
14	No Limit	No Limit	No Limit	No Limit
15	No Limit	No Limit	No Limit	No Limit
16	No Limit	No Limit	No Limit	No Limit
17	No Limit	No Limit	No Limit	No Limit
18	No Limit	No Limit	No Limit	No Limit
19	No Limit	No Limit	No Limit	No Limit
20	No Limit	No Limit	No Limit	No Limit
21	No Limit	No Limit	No Limit	No Limit
22	No Limit	No Limit	No Limit	No Limit
23	No Limit	No Limit	No Limit	No Limit
24	No Limit	No Limit	No Limit	No Limit

Figure 5 - 2. Bandwidth Control window

The following parameters can be set or are displayed:

Parameter	Description
<b>From Port / To Port</b>	Use the drop-down menus to select a range of ports to be configured.
<b>Type</b>	This drop-down menu allows a selection between <i>RX</i> (receive), <i>TX</i> (transmit), and <i>Both</i> . This setting will determine whether the bandwidth ceiling is applied to receiving, transmitting, or both receiving and transmitting packets.
<b>No Limit</b>	This drop-down menu allows the user to specify that the selected port will have no bandwidth limit or not.
<b>Rate (64-1024000)</b>	This field allows the input of the data rate that will be the limit for the selected port. The user may choose a rate between 64 and 1024000 Kbits per second.
<b>Effective RX</b>	If a RADIUS server has assigned the RX bandwidth, then it will be the effective RX bandwidth. The authentication with the RADIUS sever can be per port or per user. For per user authentication, there may be multiple RX bandwidths assigned if there are multiple users attached to this specific port. The final RX bandwidth will be the largest one among these multiple RX bandwidths.
<b>Effective TX</b>	If a RADIUS server has assigned the TX bandwidth, then it will be the effective TX bandwidth. The authentication with the RADIUS sever can be per port or per user. For per user authentication, there may be multiple TX bandwidths assigned if there are multiple users attached to this specific port. The final TX bandwidth will be the largest one among these multiple TX bandwidths.

Click **Apply** to set the bandwidth control for the selected ports. Results of configured Bandwidth Settings are displayed in the Bandwidth Control Table at the bottom of the window.

## Queue Bandwidth Control Settings

This window is used to configure queue bandwidth control settings.

To view the following window, click **QoS > Queue Bandwidth Control Settings**:

Queue Bandwidth Control Settings

From Port: 01 To Port: 01 From Queue: 0 To Queue: 0 Max Rate (64-1024000):  No Limit

Apply

Queue Bandwidth Control Table On Port 1

Queue	Max Rate (Kbit/sec)
0	No Limit
1	No Limit
2	No Limit
3	No Limit
4	No Limit
5	No Limit
6	No Limit
7	No Limit

Queue Bandwidth Control Table On Port 2

Queue	Max Rate (Kbit/sec)
0	No Limit
1	No Limit
2	No Limit
3	No Limit
4	No Limit
5	No Limit
6	No Limit
7	No Limit

Queue Bandwidth Control Table On Port 3

Queue	Max Rate (Kbit/sec)
0	No Limit
1	No Limit
2	No Limit
3	No Limit
4	No Limit
5	No Limit
6	No Limit
7	No Limit

Queue Bandwidth Control Table On Port 4

Queue	Max Rate (Kbit/sec)
0	No Limit
1	No Limit
2	No Limit
3	No Limit
4	No Limit
5	No Limit
6	No Limit
7	No Limit

Figure 5 - 3. Bandwidth Control window

The following parameters can be set or are displayed:

Parameter	Description
<b>From Port / To Port</b>	Use the drop-down menus to select a range of ports to be configured.
<b>From Queue / To Queue</b>	Use the drop-down menu to select the queue range to use for this configuration.
<b>Max Rate (64-1024000)</b>	Enter the maximum rate for the queue. For no limit select the <b>No Limit</b> option.

Click **Apply** to implement the changes.

## Traffic Control

On a computer network, packets such as Multicast packets and Broadcast packets continually flood the network as normal procedure. At times, this traffic may increase do to a malicious endstation on the network or a malfunctioning device, such as a faulty network card. Thus, switch throughput problems will arise and consequently affect the overall performance of the switch network. To help rectify this packet storm, the Switch will monitor and control the situation.

Packet storms are monitored to determine if too many packets are flooding the network based on threshold levels provided by the user. Once a packet storm has been detected, the Switch will drop packets coming into the Switch until the storm has subsided. This method can be utilized by selecting the *Drop* option of the Action parameter in the window below.

The Switch will also scan and monitor packets coming into the Switch by monitoring the Switch's chip counter. This method is only viable for Broadcast and Multicast storms because the chip only has counters for these two types of packets. Once a storm has been detected (that is, once the packet threshold set below has been exceeded), the Switch will shut down the port to all incoming traffic, with the exception of STP BPDU packets, for a time period specified using the Count Down parameter.



If a Time Interval parameter times-out for a port configured for traffic control and a packet storm continues, that port will be placed in Shutdown Forever mode, which will cause a warning message to be sent to the Trap Receiver. To utilize this method of Storm Control, choose the *Shutdown* option of the Action parameter in the window below.

Use this window to enable or disable storm control and adjust the threshold for multicast and broadcast storms.

To view the following window, click **QoS > Traffic Control**:

Port	Traffic Control Type	Action	Threshold	Countdown	Time Interval	Shutdown Forever
1	None	Drop	512	0	5	
2	None	Drop	512	0	5	
3	None	Drop	512	0	5	
4	None	Drop	512	0	5	
5	None	Drop	512	0	5	
6	None	Drop	512	0	5	
7	None	Drop	512	0	5	
8	None	Drop	512	0	5	
9	None	Drop	512	0	5	
10	None	Drop	512	0	5	
11	None	Drop	512	0	5	
12	None	Drop	512	0	5	
13	None	Drop	512	0	5	
14	None	Drop	512	0	5	
15	None	Drop	512	0	5	
16	None	Drop	512	0	5	
17	None	Drop	512	0	5	
18	None	Drop	512	0	5	
19	None	Drop	512	0	5	

Figure 5 - 4. Traffic Control window

To configure Traffic Control, set the parameters described in the table below:

Parameter	Description
<b>From Port / To Port</b>	Use the drop-down menus to select a range of ports to be configured.
<b>Action</b>	Select the method of traffic control from the drop-down menu. The choices are: <i>Drop</i> – Utilizes the hardware Traffic Control mechanism, which means the Switch’s hardware will determine the Packet Storm based on the Threshold value stated and drop packets until the issue is resolved. <i>Shutdown</i> – Utilizes the Switch’s software Traffic Control mechanism to determine the Packet Storm occurring. Once detected, the port will deny all incoming traffic to the port except STP BPDU packets, which are essential in keeping the Spanning Tree operational on the Switch. If the Count Down timer has expired and yet the Packet Storm continues, the port will be placed in Shutdown Forever mode and is no longer operational until the user manually resets the port using the <b>Port Settings</b> window ( <b>Configuration &gt; Port Configuration &gt; Port Settings</b> ). Choosing this option obligates the user to configure the Time Interval setting as well, which will provide packet count samplings from the Switch’s chip to determine if a Packet Storm is occurring.
<b>Count Down (0 or 5-30)</b>	The Count Down timer is set to determine the amount of time, in minutes, that the Switch will wait before shutting down the port that is experiencing a traffic storm. This parameter is only useful for ports configured as <i>Shutdown</i> in their Action field and therefore will not operate for hardware-based Traffic Control implementations. The possible time settings for this field are 0 and 5 to 30

	minutes. Tick the <b>Disabled</b> check box to disable the countdown timer. When the <b>Action</b> is <i>Shutdown</i> , <b>Countdown</b> is disabled, and the Switch detects a storm, it directly shuts down the port. The default is 0.
<b>Time Interval (5-30)</b>	The Time Interval will set the time between Multicast and Broadcast packet counts sent from the Switch's chip to the Traffic Control function. These packet counts are the determining factor in deciding when incoming packets exceed the Threshold value. The Time Interval may be set between 5 and 30 seconds, with a default setting of 5 seconds.
<b>Threshold (512-1024000)</b>	Specifies the maximum number of kbit per second that will trigger the Traffic Control function to commence. The configurable threshold range is from 512 to 1024000, with a default setting of 512 Kbps.
<b>Storm Control Type</b>	Specifies the desired Storm Control Type: <i>None, Broadcast, Multicast, Unknown Unicast, Broadcast + Multicast, Broadcast + Unknown Unicast, Multicast + Unknown Unicast, and Broadcast + Multicast + Unknown Unicast.</i>
<b>Traffic Trap Settings</b>	<p>Enable sending of Storm Trap messages when the type of action taken by the Traffic Control function in handling a Traffic Storm is one of the following:</p> <ul style="list-style-type: none"> <li>• <i>None</i> – Will not send any Storm trap warning messages, regardless of the action taken by the Traffic Control mechanism.</li> <li>• <i>Storm Occurred</i> – Will send Storm Trap warning messages upon the occurrence of a Traffic Storm only.</li> <li>• <i>Storm Cleared</i> – Will send Storm Trap messages when a Traffic Storm has been cleared by the Switch only.</li> <li>• <i>Both</i> – Will send Storm Trap messages when a Traffic Storm has been both detected and cleared by the Switch.</li> </ul> <p>This function cannot be implemented in the hardware mode. (When <i>Drop</i> is chosen for the Action parameter.</p>
<b>Traffic Log Settings</b>	Use the drop-down menu to enable or disable the function. If enabled, the traffic control states are logged when a storm occurs and when a storm is cleared. If the log state is disabled, the traffic control events are not logged.
<b>Traffic Auto Recover Time (0-65535)</b>	Enter the time allowed for auto recovery from shutdown for a port. The default value is 0, which means there is no auto recovery and the port remains in shutdown forever mode. This requires manual entry of the CLI command <b>config ports [ &lt;portlist&gt;   all ] state enable</b> to return the port to a forwarding state.

Click **Apply** to implement the settings of each field.



**NOTE:** Traffic Control cannot be implemented on ports that are set for Link Aggregation (Port Trunking).



**NOTE:** Ports that are in the Shutdown Forever mode will be seen as Discarding in Spanning Tree windows and implementations though these ports will still be forwarding BPDUs to the Switch's CPU.



**NOTE:** Ports that are in Shutdown Forever mode will be seen as link down in all windows and screens until the user recovers these ports.

## 802.1p Default Priority

The Switch allows the assignment of a default 802.1p priority to each port on the Switch.

To view the following window, click **QoS > 802.1p Default Priority**:

Port	Priority	Effective Priority
1	0	0
2	0	0
3	0	0
4	0	0
5	0	0
6	0	0
7	0	0
8	0	0
9	0	0
10	0	0
11	0	0
12	0	0
13	0	0
14	0	0
15	0	0
16	0	0
17	0	0
18	0	0
19	0	0
20	0	0
21	0	0
22	0	0
23	0	0
24	0	0

Figure 5 - 5. 802.1p Default Priority window

This page allows the user to assign a default 802.1p priority to any given port on the Switch. The priority and effective priority tags are numbered from 0, the lowest priority, to 7, the highest priority. The effective priority indicates the actual priority assigned by RADIUS. If the RADIUS assigned value exceeds the specified limit, the value will be set at the default priority. For example, if the RADIUS assigns a limit of 8 and the default priority is 0, the effective priority will be 0. To implement a new default priority, first choose a port range by using the From Port and To Port drop-down menus and then use the Priority drop-down menu to select a value from 0 to 7. Click **Apply** to implement the settings.

## 802.1p User Priority

The Switch allows the assignment of a class of service to each of the 802.1p priorities.

To view the following window, click **QoS > 802.1p User Priority**:

Priority	Class ID
0	Class-2
1	Class-0
2	Class-1
3	Class-3
4	Class-4
5	Class-5
6	Class-6
7	Class-7

Figure 5 - 6. 802.1p User Priority window

Once a priority has been assigned to the port groups on the Switch, then a Class may be assigned to each of the eight levels of 802.1p priorities using the drop-down menus on this window. Click **Apply** to set the changes.

## QoS Scheduling Mechanism

The Scheduling Mechanism drop-down menu allows a selection between a *Weight Fair* and a *Strict* mechanism for emptying the priority classes.

To view the following window, click **QoS > QoS Scheduling Mechanism**:

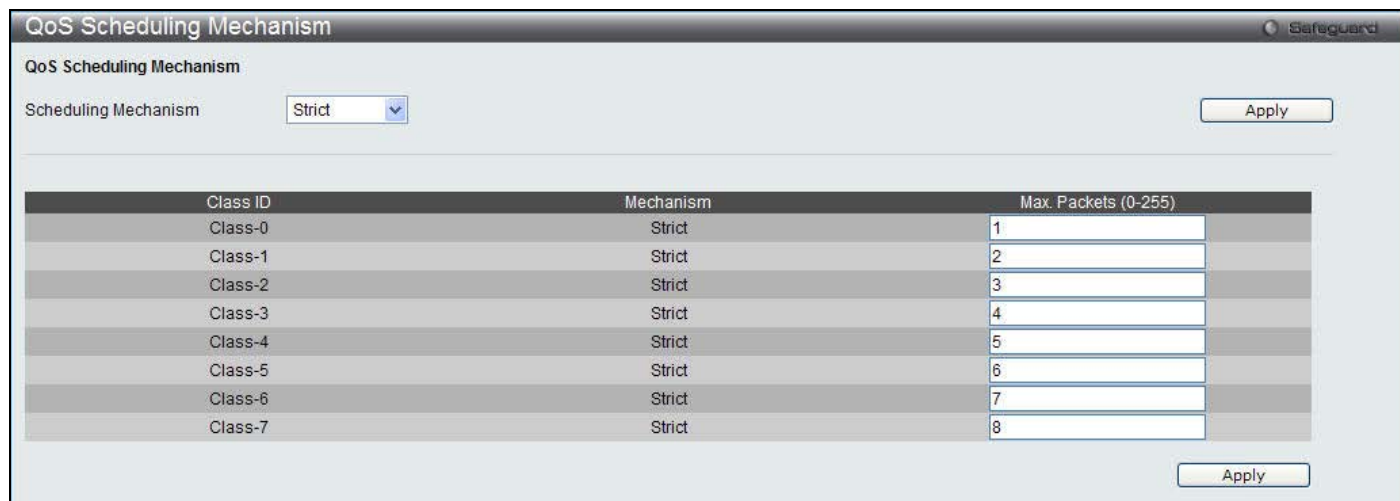

**Figure 5 - 7. QoS Scheduling Mechanism window**

The QoS Scheduling Mechanism window has the following parameters.

Parameter	Description
<b>Scheduling Mechanism</b>	Use the drop-down menu to select one of the following options: <i>Strict</i> - The highest class of service is the first to process traffic. That is, the highest class of service will finish before other queues empty. <i>Weight Fair</i> - Use the weighted round-robin ( <i>WRR</i> ) algorithm to handle packets in an even distribution in priority classes of service.
<b>Max. Packets (0-255)</b>	Specifies the maximum number of packets the above specified hardware priority class of service will be allowed to transmit before allowing the next lowest priority queue to transmit its packets. A value between 0 and 255 can be specified.

Click **Apply** to implement the changes.

# Security

*RADIUS*

*IP-MAC-Port Binding (IMPB)*

*Port Security*

*DHCP Server Screening*

*802.1X*

*SSL*

*SSH*

*Access Authentication Control*

*MAC-based Access Control (MAC)*

*Web-based Access Control (WAC)*

*Japanese Web-based Access Control (JWAC)*

*Compound Authentication*

*IGMP Access Control Settings*

*ARP Spoofing Prevention Settings*

*BPDU Attack Protection*

*Loopback Detection Settings*

*Traffic Segmentation*

*Safeguard Engine Settings*

*Trusted Host Settings*

## RADIUS

### Authentication RADIUS Server Settings

The RADIUS feature of the Switch allows the user to facilitate centralized user administration as well as providing protection against a sniffing, active hacker. The Web manager offers three windows.

To view the following window, click **Security > RADIUS > Authentication RADIUS Server Settings**:

Figure 6 - 1. Authentication RADIUS Server Settings window

The following parameters can be configured:

Parameter	Description
<b>Index</b>	Choose the desired RADIUS server to configure: 1, 2 or 3 and select either IPv4 Address or IPv6 Address.
<b>IPv4 Address</b>	Click the radio button and set the RADIUS server IPv4 address.
<b>IPv6 Address</b>	Click the radio button and set the RADIUS server IPv6 address.
<b>Authentication Port (1-65535)</b>	Set the RADIUS authentic server(s) UDP port which is used to transmit RADIUS data between the Switch and the RADIUS server. The default port is 1812.
<b>Accounting Port (1-65535)</b>	Set the RADIUS account server(s) UDP port which is used to transmit RADIUS accounting statistics between the Switch and the RADIUS server. The default port is 1813.
<b>Timeout (1-255)</b>	Set the RADIUS server age-out, in seconds.
<b>Retransmit (1-20)</b>	Set the RADIUS server retransmit time, in seconds.
<b>Key (Max. length 32 bytes)</b>	Set the key the same as that of the RADIUS server.
<b>Confirm Key</b>	Re-type the key which is the same as the above.

Click **Apply** to implement the changes.

## RADIUS Accounting Settings

This window is used to configure the state of the specified RADIUS accounting service.

To view the following window, click **Security > RADIUS > RADIUS Accounting Settings**:

**Figure 6 - 2. RADIUS Accounting Settings window**

The following parameters can be configured:

Parameter	Description
<b>Network</b>	When enabled, the Switch will send informational packets to a remote RADIUS server when 802.1X and WAC port access control events occur on the Switch.
<b>Shell</b>	When enabled, the Switch will send informational packets to a remote RADIUS server when a user either logs in, logs out or times out on the Switch, using the console, Telnet, or SSH.
<b>System</b>	When enabled, the Switch will send informational packets to a remote RADIUS server when system events occur on the Switch, such as a system reset or system boot.

Click **Apply** to implement the changes.

## RADIUS Authentication

This window is used to display information concerning the activity of the RADIUS authentication client on the client side of the RADIUS authentication protocol.

To view the following window, click **Security > RADIUS > RADIUS Authentication**:

ServerIndex	InvalidServerAddr	Identifier	AuthServerAddr	ServerPortNumber	RoundTripTime	AccessRequests	AccessResponses
1	0			0	0	0	0
2	0			0	0	0	0
3	0			0	0	0	0

**Figure 6 - 3. RADIUS Authentication window**

The user may also select the desired time interval to update the statistics, between *1s* and *60s*, where “s” stands for seconds. The default value is one second. To clear the current statistics shown, click the *Clear* button in the top left hand corner.

The following information is displayed:

Parameter	Description
<b>ServerIndex</b>	The identification number assigned to each RADIUS Authentication server that the client shares a secret with.
<b>InvalidServerAddr</b>	The number of RADIUS Access-Response packets received from unknown addresses.
<b>Identifier</b>	The NAS-Identifier of the RADIUS authentication client. (This is not necessarily the same as sysName in MIB II.)
<b>AuthServerAddr</b>	The (conceptual) table listing the RADIUS authentication servers with which the client shares a secret.
<b>ServerPortNumber</b>	The UDP port the client is using to send requests to this server.
<b>RoundTripTime</b>	The time interval (in hundredths of a second) between the most recent Access-Reply/Access-Challenge and the Access-Request that matched it from this RADIUS authentication server.
<b>AccessRequests</b>	The number of RADIUS Access-Request packets sent to this server. This does not

	include retransmissions.
<b>AccessRetrans</b>	The number of RADIUS Access-Request packets retransmitted to this RADIUS authentication server.
<b>AccessAccepts</b>	The number of RADIUS Access-Accept packets (valid or invalid) received from this server.
<b>AccessRejects</b>	The number of RADIUS Access-Reject packets (valid or invalid) received from this server.
<b>AccessChallenges</b>	The number of RADIUS Access-Challenge packets (valid or invalid) received from this server.
<b>AccessResponses</b>	The number of malformed RADIUS Access-Response packets received from this server. Malformed packets include packets with an invalid length. Bad authenticators or Signature attributes or known types are not included as malformed access responses.
<b>BadAuthenticators</b>	The number of RADIUS Access-Response packets containing invalid authenticators or Signature attributes received from this server.
<b>PendingRequests</b>	The number of RADIUS Access-Request packets destined for this server that have not yet timed out or received a response. This variable is incremented when an Access-Request is sent and decremented due to receipt of an Access-Accept, Access-Reject or Access-Challenge, a timeout or retransmission.
<b>Timeouts</b>	The number of authentication timeouts to this server. After a timeout the client may retry to the same server, send to a different server, or give up. A retry to the same server is counted as a retransmit as well as a timeout. A send to a different server is counted as a Request as well as a timeout.
<b>UnknownTypes</b>	The number of RADIUS packets of unknown type which were received from this server on the authentication port
<b>PacketsDropped</b>	The number of RADIUS packets of which were received from this server on the authentication port and dropped for some other reason.

## RADIUS Account Client

This window is used to display managed objects used for managing RADIUS accounting clients, and the current statistics associated with them.

To view the following window, click **Security > RADIUS > RADIUS Account Client**:

ServerIndex	InvalidServerAddr	Identifier	ServerAddr
1	0		
2	0		
3	0		

**Figure 6 - 4. RADIUS Account Client window**

The user may also select the desired time interval to update the statistics, between 1s and 60s, where “s” stands for seconds. The default value is one second. To clear the current statistics shown, click the *Clear* button in the top left hand corner.

The following information is displayed:



Parameter	Description
<b>ServerIndex</b>	The identification number assigned to each RADIUS Accounting server that the client shares a secret with.
<b>InvalidServerAddr</b>	The number of RADIUS Accounting-Response packets received from unknown addresses.
<b>Identifier</b>	The NAS-Identifier of the RADIUS accounting client. (This is not necessarily the same as sysName in MIB II.)
<b>ServerAddr</b>	The (conceptual) table listing the RADIUS accounting servers with which the client shares a secret.
<b>ServerPortNumber</b>	The UDP port the client is using to send requests to this server.
<b>RoundTripTime</b>	The time interval between the most recent Accounting-Response and the Accounting-Request that matched it from this RADIUS accounting server.
<b>Requests</b>	The number of RADIUS Accounting-Request packets sent. This does not include retransmissions.
<b>Retransmissions</b>	The number of RADIUS Accounting-Request packets retransmitted to this RADIUS accounting server. Retransmissions include retries where the Identifier and Acct-Delay have been updated, as well as those in which they remain the same.
<b>Responses</b>	The number of RADIUS packets received on the accounting port from this server.
<b>MalformedResponses</b>	The number of malformed RADIUS Accounting-Response packets received from this server. Malformed packets include packets with an invalid length. Bad authenticators and unknown types are not included as malformed accounting responses.
<b>BadAuthenticators</b>	The number of RADIUS Accounting-Response packets, which contained invalid authenticators, received from this server.
<b>PendingRequests</b>	The number of RADIUS Accounting-Request packets sent to this server that have not yet timed out or received a response. This variable is incremented when an Accounting-Request is sent and decremented due to receipt of an Accounting-Response, a timeout or a retransmission.
<b>Timeouts</b>	The number of accounting timeouts to this server. After a timeout the client may retry to the same server, send to a different server, or give up. A retry to the same server is counted as a retransmit as well as a timeout. A send to a different server is counted as an Accounting-Request as well as a timeout.
<b>UnknownTypes</b>	The number of RADIUS packets of unknown type which were received from this server on the accounting port.
<b>PacketsDropped</b>	The number of RADIUS packets, which were received from this server on the accounting port and dropped for some other reason.

## IP-MAC-Port Binding (IMPB)

### General Overview

The DGS-3200 Series switches offer IP-MAC-Port Binding (IMPB), a D-Link security application used most often on edge switches directly connected to network hosts. IMPB is also an integral part of D-Link's End-to-End Security Solution (E2ES). The primary purpose of IP-MAC-Port Binding is to restrict client access to a switch by enabling administrators to configure pairs of client MAC and IP addresses that are allowed to access networks through a switch. Specifically, IMPB binds together the four-byte IP address and the six-byte Ethernet link layer MAC address to allow the transmission of data between the layers.

The IMPB function is port-based, meaning that a user can enable or disable the function on any individual port. Once IMPB is enabled on a switch port, the switch will restrict or allow client access by checking the pair of IP-MAC addresses with the pre-configured database, also known as the "IMPB white list". If an unauthorized user tries to access an IMPB-enabled port, the system will block access by dropping its packet. The creation of authorized users can be manually configured by CLI or Web.

## Common IP Management Security Issues

Currently, certain limitations and issues in IP management structures can lead to serious security problems. Auditing mechanisms, such as syslog, application log, firewall log, etc, are mainly based on client IP information. However, such log information is meaningless if the client IP address can be easily changed. IP conflict, the most common problem in today's networks, is another major security concern. Without IMPB, any user can change an IP address manually and cause conflict with other resources, such as other PCs, core switches, routers or servers. Not only does this duplicate IP create an auditing issue, it also poses potential risk to the entire network.

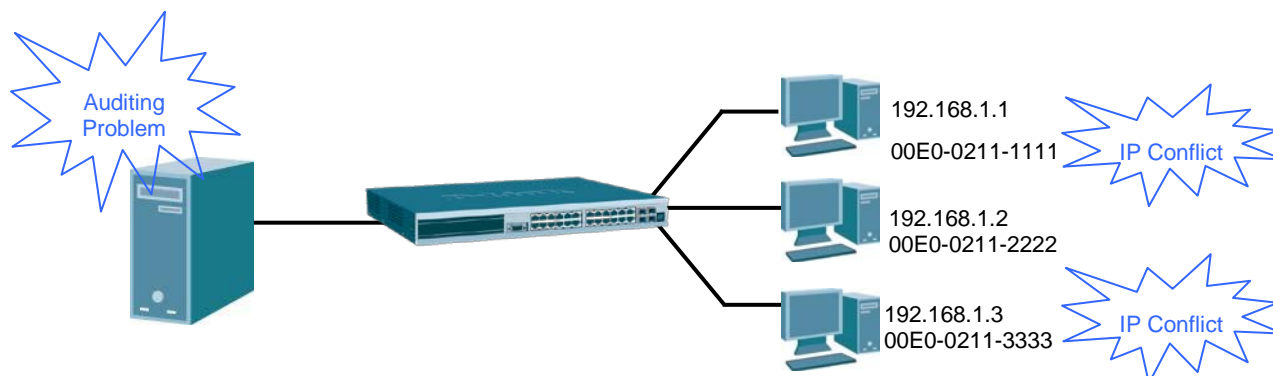

**Figure 5 - 8. Illustration of Common IP Security Problems**

ARP spoofing attacks in which malicious users intercept traffic or interrupt connections by manipulating ARP packets are another serious challenge in securing today's network. Further information on how ARP spoofing attacks work can be found in the Appendix, "Mitigating ARP Spoofing Attack via Packet Content ACL," located in the back of this manual.

## Solutions to Improve IP Management Security

DGS-3200 Series switches have introduced IMPB technology to protect networks from attacks. By using IP-MAC-Port Binding, all packets are dropped by a switch when the MAC address, IP address, and connected port are not in the IMPB white list. IMPB allows the user to choose either ARP or ACL mode. In addition, an IMPB white list can be dynamically created with the DHCP snooping option. DHCP snooping is a global setting and can be enabled on top of ACL or ARP mode. Each option has its advantages and disadvantages.

### ARP Mode

In ARP Mode, a switch performs ARP Packet Inspection in which it checks the IP-MAC pairs in ARP packets and denies unauthorized ones. An advantage of ARP mode is that it does not consume any ACL rules on the switch. Nonetheless, since the switch only checks ARP packets, it cannot block unauthorized clients who do not send out ARP packets.

### ACL Mode

In ACL Mode, a switch performs IP Packet Inspection in addition to ARP Packet Inspection. Essentially, ACL rules will be used to permit statically configured IMPB entries and deny other IP packets with the incorrect IP-MAC pairs. The distinct advantage of ACL Mode is that it ensures better security by checking both ARP Packets and IP Packets. However, doing so requires the use of ACL rules. ACL Mode can be viewed as an enhanced version of ARP Mode because ARP Mode is enabled by default when ACL Mode is selected.

### Strict and Loose State

Other than ACL and ARP mode, users can also configure the state on a port for granular control. There are two states, Strict and Loose, and only one state can be selected per port. If a port is set to Strict state, all packets sent to the port are denied (dropped) by default. The switch will continuously compare all IP and ARP packets it receives on that port with its IMPB entries. If the IP-MAC pair in the packet matches the IMPB entry, the MAC address will be unblocked and subsequent packets sent from this client will be forwarded. On the other hand, if a port is set to Loose state, all packets sent to the port are permitted (forwarded) by default. The switch will continuously compare all ARP packets it receives on that port with its IMPB entries. If the IP-MAC pair in the ARP packet does not match the IMPB white list, the MAC address will be blocked and subsequent packets sent from this client will be dropped.

## DHCP Snooping Option

If DHCP snooping is enabled, the switch learns IP-MAC pairs by snooping DHCP packets automatically and then saving them to the IP-MAC-Port Binding white list. This enables a hassle-free configuration because the administrator does not need to manually enter each IMPB entry. A prerequisite for this is that the valid DHCP server's IP-MAC pair must be on the switch's IMPB list; otherwise the DHCP server packets will be dropped. DHCP snooping is generally considered to be more secure because it enforces all clients to acquire IP through the DHCP server.

An example of DHCP snooping in which PC-A and PC-B get their IP addresses from a DHCP server is depicted below. The switch snoops the DHCP conversation between PC-A, PC-B, and the DHCP server. The IP address, MAC address, and connecting ports of both PC-A and PC-B are learned and stored in the switch's IMPB white list. Therefore, these PCs will be able to connect to the network. Then there is PC-C, whose IP address is manually configured by the user. Since this PC's IP-MAC pair does not match the one on Switch's IMPB white list, traffic from PC-C will be blocked.

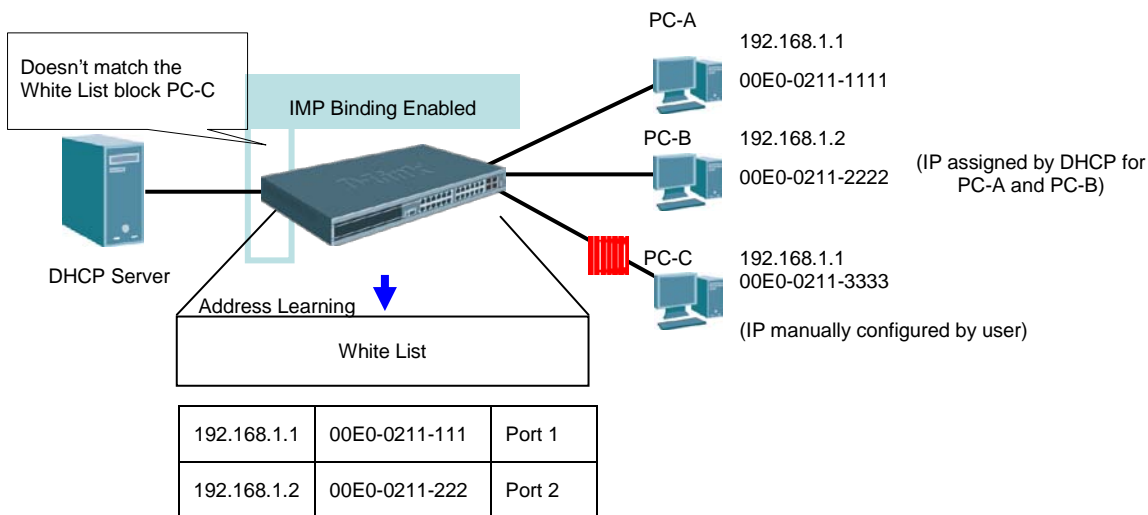

Figure 6 - 5. Example of DHCP Snooping

The **IP-MAC-Port Binding (IMPB)** folder contains five windows: **IMPB Global Settings**, **IMPB Port Settings**, **IMPB Entry Settings**, **DHCP Snooping Entries**, and **MAC Blocked List**.

## IMPB Global Settings

Users can enable or disable the global IMPB settings: Trap Log State and DHCP Snoop state, on the Switch.

The Trap/Log field will enable and disable the sending of trap log messages for IP-MAC binding. When enabled, the Switch will send a trap message to the SNMP agent and the Switch log when an ARP packet is received that doesn't match the IP-MAC binding configuration set on the Switch.

The DHCP Snoop State field will enable and disable the DHCP Snooping option.

To view the following window, click **Security > IP-MAC-Port Binding (IMPB) > IMPB Global Settings**:



Figure 6 - 6. IMPB Global Settings window

The following parameters can be set:

Parameter	Description
<b>Trap / Log</b>	Click the radio buttons to enable or disable the sending of trap/log messages for IP-MAC-port binding. When <i>Enabled</i> , the Switch will send a trap message to the SNMP agent and the Switch log when an ARP/IP packet is received that doesn't match the IP-MAC-port binding configuration set on the Switch. The default is <i>Disabled</i> .
<b>DHCP Snooping (IPv4)</b>	Click the radio buttons to enable or disable DHCP snooping (IPv4) for IP-MAC-port binding. The default is <i>Disabled</i> .
<b>DHCP Snooping (IPv6)</b>	Click the radio buttons to enable or disable DHCP snooping (IPv6) for IP-MAC-port binding. The default is <i>Disabled</i> .
<b>ND Snooping</b>	Click the radio buttons to enable or disable enable ND snooping on the Switch. The default is <i>Disabled</i> .
<b>Recover Learning Ports</b>	Enter the port numbers used to recover the learning port state. Tick the <b>All</b> check box to apply to all ports.

Click **Apply** to implement the changes.

## IMPB Port Settings

Users can configure IMPB settings on a port basis.

Select a port or a range of ports with the From Port and To Port fields. Enable or disable the port with Strict or Loose State, enable or disable Allow Zero IP and Forward DHCP Packet fields, and configure the port's Max IMPB entry.

To view this window, click **Security > IP-MAC-Port Binding (IMPB) > IMPB Port Settings**, as shown below:

The screenshot shows the 'IMPB Port Settings' window with the following configuration:

- From Port: 01
- To Port: 01
- IPv4 State: Disabled
- IPv6 State: Disabled
- Zero IP: Disabled
- DHCP Packet: Enabled
- Mode: ARP
- Stop Learning Threshold: (0-500)

The table below represents the data shown in the screenshot:

Port	IPv4 State	IPv6 State	Mode	Zero IP	DHCP Packet	Stop Learning Threshold/Mode
1	Disabled	Disabled	ARP	Not Allow	Forward	500/Normal
2	Disabled	Disabled	ARP	Not Allow	Forward	500/Normal
3	Disabled	Disabled	ARP	Not Allow	Forward	500/Normal
4	Disabled	Disabled	ARP	Not Allow	Forward	500/Normal
5	Disabled	Disabled	ARP	Not Allow	Forward	500/Normal
6	Disabled	Disabled	ARP	Not Allow	Forward	500/Normal
7	Disabled	Disabled	ARP	Not Allow	Forward	500/Normal
8	Disabled	Disabled	ARP	Not Allow	Forward	500/Normal
9	Disabled	Disabled	ARP	Not Allow	Forward	500/Normal
10	Disabled	Disabled	ARP	Not Allow	Forward	500/Normal
11	Disabled	Disabled	ARP	Not Allow	Forward	500/Normal
12	Disabled	Disabled	ARP	Not Allow	Forward	500/Normal
13	Disabled	Disabled	ARP	Not Allow	Forward	500/Normal
14	Disabled	Disabled	ARP	Not Allow	Forward	500/Normal
15	Disabled	Disabled	ARP	Not Allow	Forward	500/Normal
16	Disabled	Disabled	ARP	Not Allow	Forward	500/Normal
17	Disabled	Disabled	ARP	Not Allow	Forward	500/Normal
18	Disabled	Disabled	ARP	Not Allow	Forward	500/Normal
19	Disabled	Disabled	ARP	Not Allow	Forward	500/Normal
20	Disabled	Disabled	ARP	Not Allow	Forward	500/Normal
21	Disabled	Disabled	ARP	Not Allow	Forward	500/Normal
22	Disabled	Disabled	ARP	Not Allow	Forward	500/Normal
23	Disabled	Disabled	ARP	Not Allow	Forward	500/Normal
24	Disabled	Disabled	ARP	Not Allow	Forward	500/Normal

Figure 6 - 7. IMPB Port Settings window

The following fields can be configured:

Parameter	Description
<b>From Port/To Port</b>	Select a range of ports to set for IP-MAC-port binding.
<b>IPv4 State / IPv6 State</b>	<p>Use the drop-down menu to enable or disable these ports for IP-MAC Binding.</p> <p><i>Enabled (Strict)</i> – This state provides a stricter method of control. If the user selects this mode, all packets are blocked by the Switch by default. The Switch will compare all incoming ARP and IP Packets and attempt to match them against the IMPB white list. If the IP-MAC pair matches the white list entry, the packets from that MAC address are unblocked. If not, the MAC address will stay blocked. While the Strict state uses more CPU resources from checking every incoming ARP and IP packet, it enforces better security and is thus the recommended setting.</p> <p><i>Enabled (Loose)</i> – This mode provides a looser way of control. If the user selects loose mode, the Switch will forward all packets by default. However, it will still inspect incoming ARP packets and compare them with the Switch’s IMPB white list entries. If the IP-MAC pair of a packet is not found in the white list, the Switch will block the MAC address. A major benefit of Loose state is that it uses less CPU resources because the Switch only checks incoming ARP packets. However, it also means that Loose state cannot block users who send only unicast IP packets. An example of this is that a malicious user can perform DoS attacks by statically configuring the ARP table on their PC. In this case, the Switch cannot block such attacks because the PC will not send out ARP packets.</p>
<b>Zero IP</b>	<p>Use the drop-down menu to enable or disable this feature. Once <i>Enabled</i>, the Switch will allow ARP packets with a Source IP of 0.0.0.0 to pass through.</p> <p>This is useful in some scenarios when a client (for example, a wireless Access Point,) sends out an ARP request packet before accepting the IP address from a DHCP server. In this case, the ARP request packet sent out from the client will contain a Source IP of 0.0.0.0. The Switch will need to allow such packets to pass, or else the client cannot know if there is another duplicate IP address in the network.</p>
<b>DHCP Packet</b>	By default, the Switch will forward all DHCP packets. However, if the port state is set to Strict, all DHCP packets will be dropped. In that case, select <i>Enabled</i> so that the port will forward DHCP packets even under Strict state. Enabling this feature also ensures that DHCP snooping works properly.
<b>Mode</b>	<p>Use the drop-down menu to select <i>ARP</i> or <i>ACL</i> mode.</p> <p><i>ARP</i> – When selecting this mode, the Switch will perform ARP Packet Inspection only and no ACL rules will be used.</p> <p><i>ACL</i> – When selecting this mode, the Switch will perform IP Packet Inspection in addition to ARP Packet Inspection. ACL rules will be used under this mode.</p>
<b>Stop Learning Threshold</b>	<p>Whenever a MAC address is blocked by the Switch, it will be recorded in the Switch’s L2 Forwarding Database (FDB) and each entry associated with a particular port. To prevent the Switch FDB from overloading in case of an ARP DoS attack, the administrator can configure the threshold when a port should stop learning illegal MAC addresses.</p> <p>Enter a stop learning threshold between 0 and 500. Entering 500 means the port will enter the Stop Learning state after 500 illegal MAC entries and will not allow additional MAC entries, neither legal nor illegal, to be learned on this port. In the Stop Learning state, the port will also automatically purge all blocked MAC entries on this port. Traffic from legal MAC entries is still forwarded.</p> <p>Entering 0 means no limit has been set and the port will keep learning illegal MAC addresses.</p>

Click **Apply** to implement the changes made.

## IMPB Entry Settings

This window is used to create static IP-MAC-binding port entries and view all IMPB entries on the Switch.

To view this window, click **Security > IP-MAC-Port Binding (IMPB) > IMPB Entry Settings** as shown below:

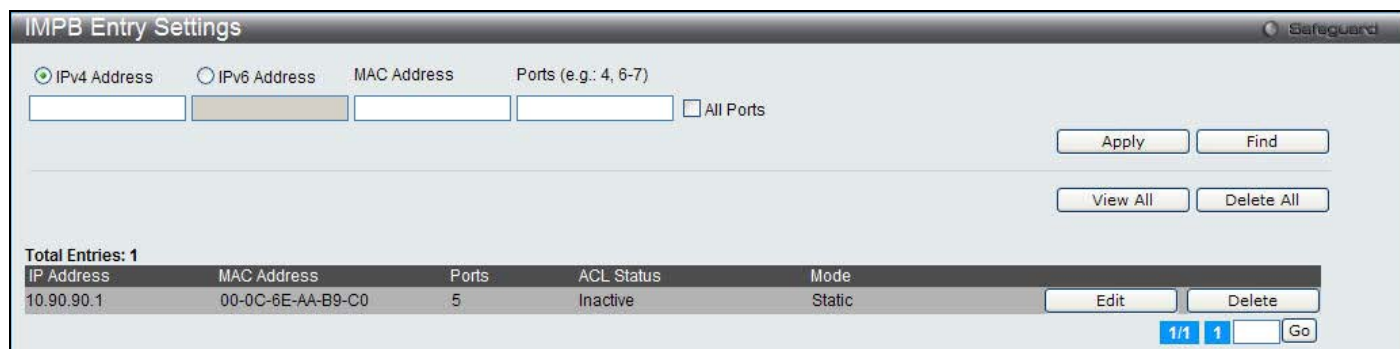

**Figure 6 - 8. IMPB Entry Settings window**

The following fields can be set or modified:

Parameter	Description
<b>IPv4 Address</b>	Click the radio button and enter the IPv4 address to bind to the MAC address set below.
<b>IPv6 Address</b>	Click the radio button and enter the IPv6 address to bind to the MAC address set below.
<b>MAC Address</b>	Enter the MAC address to bind to the IP Address set above.
<b>Ports</b>	Specify the switch ports for which to configure this IP-MAC binding entry (IP Address + MAC Address). Click the All check box to configure this entry for all ports on the Switch.

Click **Apply** to implement changes. Click **Find** to search for an entry. Click **View All** for the table to display all entries or **Delete All** to remove all the static entries. Click the **Edit** button to configure the specified entry. Click the **Delete** button to remove the specified entry.

## MAC Block List

This window is used to view unauthorized devices that have been blocked by IP-MAC binding restrictions.

To view this window, click **Security > IP-MAC-Port Binding (IMPB) > MAC Block List**, as shown below:



**Figure 6 - 9. MAC Block List window**

The following fields can be configured:

Parameter	Description
<b>VLAN Name</b>	Enter the name of the VLAN you want to find or delete.
<b>MAC Address</b>	Enter the MAC address of the MAC Address you want to find or delete.

To find an unauthorized device MAC address that has been blocked by the IP-MAC binding restrictions, enter the VID and MAC Address in the appropriate fields and click **Find**. To view all entries, click the **View All** button. To delete an entry, click the **Delete** button next to the entry's port. To delete all the entries in this window, click the **Delete All** button.

## DHCP Snooping

### DHCP Snooping Maximum Entry Settings

This window is used to configure the maximum DHCP snooping entry for ports on this page.

To view the following window, click **Security > IP-MAC-Port Binding (IMPB) > DHCP Snooping > DHCP Snooping Maximum Entry Settings**:

Port	Maximum Entry	Maximum IPv6 Entry
1	No Limit	No Limit
2	No Limit	No Limit
3	No Limit	No Limit
4	No Limit	No Limit
5	No Limit	No Limit
6	No Limit	No Limit
7	No Limit	No Limit
8	No Limit	No Limit
9	No Limit	No Limit
10	No Limit	No Limit
11	No Limit	No Limit
12	No Limit	No Limit
13	No Limit	No Limit
14	No Limit	No Limit
15	No Limit	No Limit
16	No Limit	No Limit
17	No Limit	No Limit
18	No Limit	No Limit
19	No Limit	No Limit
20	No Limit	No Limit
21	No Limit	No Limit
22	No Limit	No Limit
23	No Limit	No Limit
24	No Limit	No Limit

Figure 6 - 10. DHCP Snooping Maximum Entry Settings window

The following fields can be configured:

Parameter	Description
<b>From Port / To Port</b>	Use the drop-down menus to select a range of ports to use.
<b>Maximum Entry (1-50)</b>	Enter the maximum entry value. Tick the <b>No Limit</b> check box to have unlimited maximum number of the learned entries.
<b>Maximum IPv6 Entry (1-50)</b>	Enter the maximum entry value for IPv6 DHCP Snooping. Tick the <b>No Limit</b> check box to have unlimited maximum number of the learned entries.

Click the **Apply** button to accept the changes made.

### DHCP Snooping Entry

This window is used to view DHCP snooping entries on specific ports.

To view the following window, click **Security > IP-MAC-Port Binding (IMPB) > DHCP Snooping > DHCP Snooping Entry**:

Figure 6 - 11. DHCP Snooping Entry window

The following fields can be configured:

Parameter	Description
Port	Use the drop-down menu to select the desired port.
Ports (e.g.: 1, 7-12)	Specify the ports for DHCP snooping entries. Tick the <b>All Ports</b> check box to select all entries for all ports. Tick the <b>IPv4</b> check box to select IPv4 DHCP snooping learned entries. Tick the <b>IPv6</b> check box to select IPv6 DHCP snooping learned entries.

To view particular port settings, select the port number and click **Find**. To delete an entry, click **Clear**. To view all entries click **View All**.

## ND Snoop

### ND Snoop Maximum Entry Settings

This window is used to configure the maximum ND Snooping entry for ports on this page.

To view the following window, click **Security > IP-MAC-Port Binding (IMPB) > ND Snoop > ND Snoop Maximum Entry Settings**:

Port	Maximum Entry
1	No Limit
2	No Limit
3	No Limit
4	No Limit
5	No Limit
6	No Limit
7	No Limit
8	No Limit
9	No Limit
10	No Limit
11	No Limit
12	No Limit
13	No Limit
14	No Limit
15	No Limit
16	No Limit
17	No Limit
18	No Limit
19	No Limit
20	No Limit
21	No Limit
22	No Limit
23	No Limit
24	No Limit

Figure 6 - 12. ND Snooping Maximum Entry Settings window



The following fields can be configured:

Parameter	Description
<b>From Port / To Port</b>	Use the drop-down menus to select a range of ports to use.
<b>Maximum Entry (1-10)</b>	Enter the maximum entry value. Tick the <b>No Limit</b> check box to have unlimited maximum number of the learned entries.

Click the **Apply** button to accept the changes made.

## ND Snoop Entry

This window is used to view dynamic entries on specific ports.

To view the following window, click **Security > IP-MAC-Port Binding (IMPB) > ND Snoop > ND Snoop Entry**:



**Figure 6 - 13. ND Snooping Entry window**

The following fields can be configured:

Parameter	Description
<b>Port</b>	Use the drop-down menu to select the desired port.
<b>Ports (e.g.: 1, 7-12)</b>	Specify the ports for which to view DHCP snooping entries. Tick the <b>All Ports</b> check box to view all ND snooping ports on the Switch.

To view particular port settings, select the port number and click **Find**. To delete an entry, click **Clear**. To view all entries click **View All**.

## Port Security

The **Port Security** folder contains two windows: **Port Security Settings** and **Port Lock Entries**.

### Port Security Settings

A given port's (or a range of ports') dynamic MAC address learning can be locked such that the current source MAC addresses entered into the MAC address forwarding table can not be changed once the port lock is enabled. The port can be locked by changing the Admin State drop-down menu to *Enabled* and clicking **Apply**.

Port Security is a security feature that prevents unauthorized computers (with source MAC addresses) unknown to the Switch prior to locking the port (or ports) from connecting to the Switch's locked ports and gaining access to the network.

To view the following window, click **Security > Port Security > Port Security Settings**:

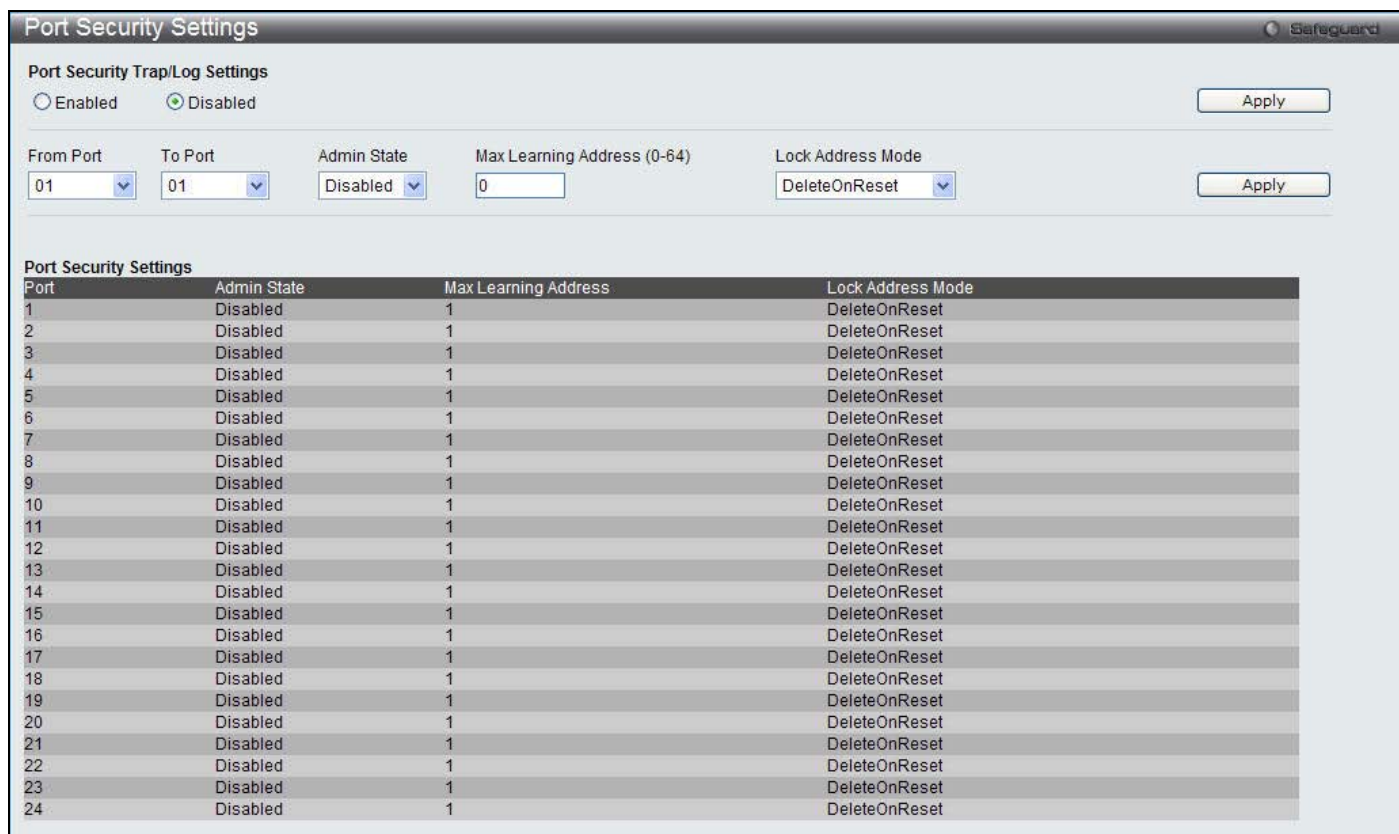

Figure 6 - 14. Port Security Settings window

The following parameters can be set:

Parameter	Description
<b>Port Security Trap/Log Settings</b>	Use the radio button to enable or disable Port Security Traps and Log Settings on the Switch.
<b>From Port / To Port</b>	Use the drop-down menu to select a range of ports to be configured.
<b>Admin State</b>	This drop-down menu allows the user to enable or disable Port Security (locked MAC address table for the selected ports).
<b>Max Learning Address (0-64)</b>	The number of MAC addresses that will be in the MAC address forwarding table for the selected switch and group of ports.
<b>Lock Address Mode</b>	This drop-down menu allows the option of how the MAC address table locking will be implemented on the Switch, for the selected group of ports. The options are: <i>Permanent</i> – Unless users manually delete these secured addresses from the switch, the locked addresses will never be aged out, even when the Switch is restarted. <i>DeleteOnTimeout</i> – The locked addresses will age out after the aging timer expires. <i>DeleteOnReset</i> – The locked addresses will not age out until the Switch has been reset or rebooted.

Click **Apply** to implement changes made.

## Port Lock Entries

Users can remove an entry from the port security entries learned by the Switch and entered into the forwarding database. This function is only operable if the Mode in the **Port Security Settings** window is selected as *Permanent* or *DeleteOnReset*, or in other words, only addresses that are statically learned by the Switch can be deleted.

To view the following window, click **Security > Port Security > Port Lock Entries**:

Figure 6 - 15. Port Lock Entries window

This window displays the following information:

Parameter	Description
<b>VID</b>	The VLAN ID of the entry in the forwarding database table that has been permanently learned by the Switch.
<b>VLAN Name</b>	The VLAN Name of the entry in the forwarding database table that has been permanently learned by the Switch.
<b>MAC Address</b>	The MAC address of the entry in the forwarding database table that has been permanently learned by the Switch.
<b>Port</b>	The ID number of the port that has permanently learned the MAC address.
<b>Lock Address Mode</b>	The lock address mode in the forwarding database table. Only entries marked Permanent or Delete on Reset can be deleted.

Click **Clear** to remove the entry.

## DHCP Server Screening

### DHCP Screening Port Settings

The Switch supports DHCP Server Screening, a feature that denies access to rogue DHCP servers. When the DHCP server filter function is enabled, all DHCP server packets will be filtered from a specific port.

To view the following window, click **Security > DHCP Server Screening > DHCP Screening Port Settings**:

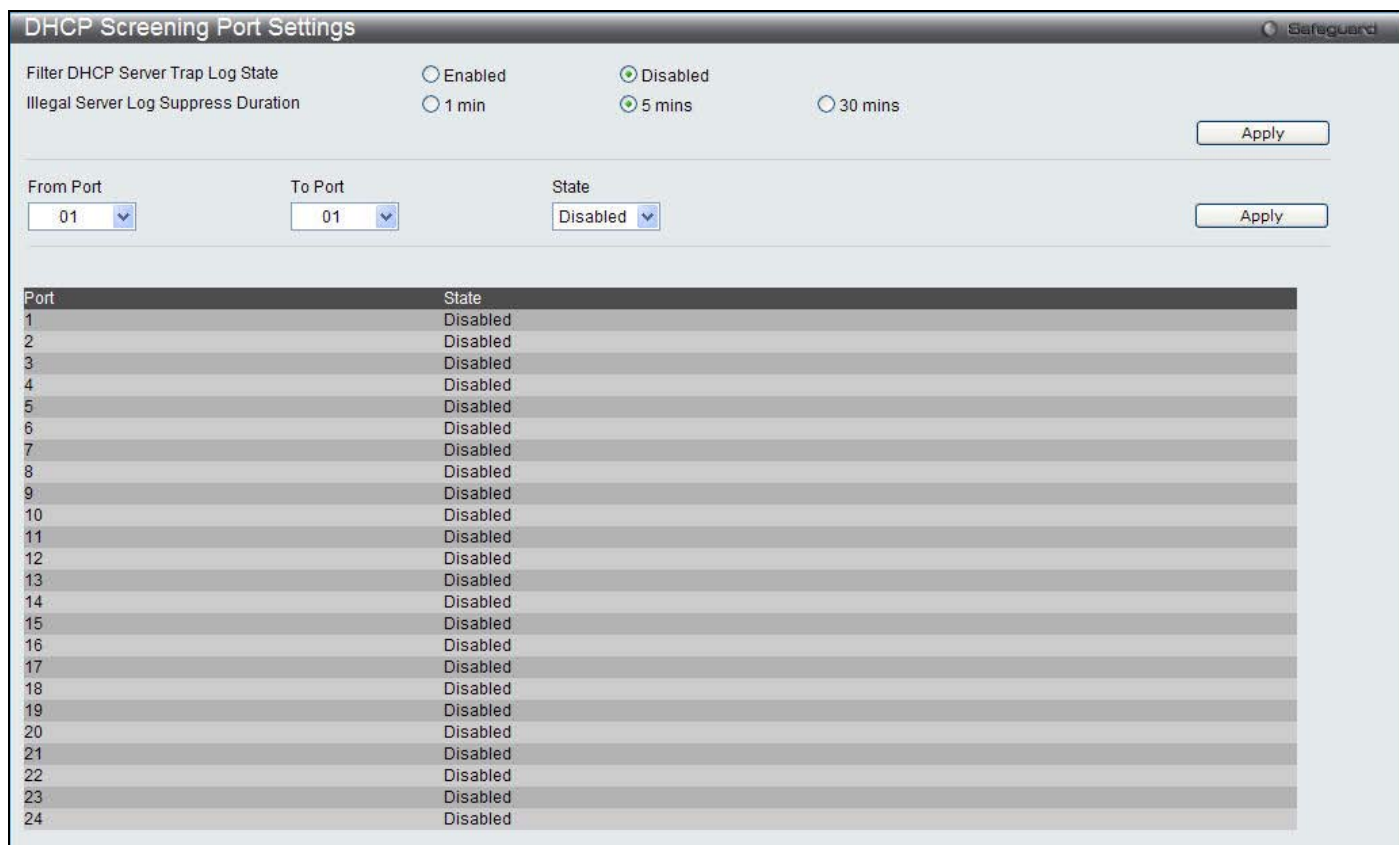

Figure 6 - 16. DHCP Screening Port Settings window

The user may set the following parameters:

Parameter	Description
<b>From DHCP Server Trap Log State</b>	Enable or disable this feature.
<b>Illegal Server Log Suppress Duration</b>	Choose an illegal server log suppress duration of 1 minute, 5 minutes, or 30 minutes.
<b>From Port / To Port</b>	Use the drop-down menu to select a range of ports.
<b>State</b>	Choose <i>Enabled</i> to enable the DHCP server screening or <i>Disabled</i> to disable it. The default is <i>Disabled</i> .

After setting the previous parameters, click **Apply** to allow your changes to be implemented.

## DHCP Offer Filtering

This function allows the user to not only restrict all DHCP Server packets but also to receive any specified DHCP server packet by any specified DHCP client, it is useful when one or more DHCP servers are present on the network and both provide DHCP services to different distinct groups of clients. The first time the DHCP filter is enabled it will create both an access profile entry and an access rule per port entry, it will also create other access rules. These rules are used to block all DHCP server packets. In addition to a permit DHCP entry, it will also create one access profile and one access rule entry the first time the DHCP client MAC address is used as the client MAC address. The Source IP address is the same as the DHCP server's IP address (UDP source port number 67). These rules are used to permit the DHCP server packets with specific fields, which the user has configured.

To view the following window, click **Security > DHCP Server Screening > DHCP Offer Filtering**:



Figure 6 - 17. DHCP Offer Filtering window

The user may set the following parameters:

Parameter	Description
<b>Server IP Address</b>	The IP address of the DHCP server to be filtered.
<b>Client's MAC Address</b>	The MAC address of the DHCP client. Only multiple legal DHCP servers on the network need to be entered in this field. If there is only one legal DHCP server on the network, no input to this field is allowed.
<b>Ports</b>	The port numbers of the filter DHCP server. Tick <b>All ports</b> to select all.

After setting the previous parameters, click **Apply** to allow your changes to be implemented. Click **Delete** to remove the specific entry.

## 802.1X (Port-based and Host-based Access Control)

The IEEE 802.1X standard is a security measure for authorizing and authenticating users to gain access to various wired or wireless devices on a specified Local Area Network by using a Client and Server based access control model. This is accomplished by using a RADIUS server to authenticate users trying to access a network by relaying Extensible Authentication Protocol over LAN (EAPOL) packets between the Client and the Server. The following figure represents a basic EAPOL packet:

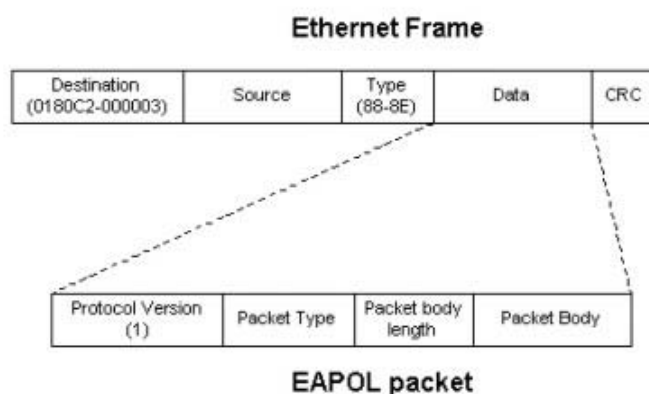

Figure 6 - 18. EAPOL Packet

Utilizing this method, unauthorized devices are restricted from connecting to a LAN through a port to which the user is connected. EAPOL packets are the only traffic that can be transmitted through the specific port until authorization is granted. The 802.1X Access Control method has three roles, each of which are vital to creating and up keeping a stable and working Access Control security method.

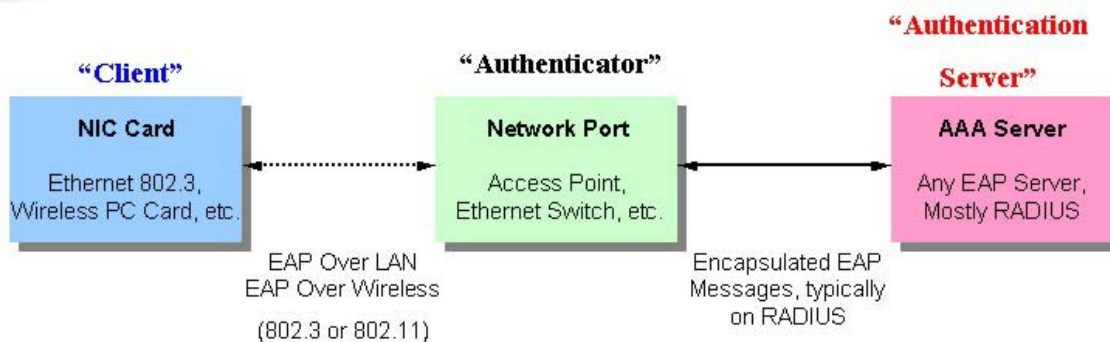

Figure 6 - 19. Three Roles of 802.1X

The following section will explain the three roles of Client, Authenticator and Authentication Server in greater detail.

## Authentication Server

The Authentication Server is a remote device that is connected to the same network as the Client and Authenticator, must be running a RADIUS Server program and must be configured properly on the Authenticator (Switch). Clients connected to a port on the Switch must be authenticated by the Authentication Server (RADIUS) before attaining any services offered by the Switch on the LAN. The role of the Authentication Server is to certify the identity of the Client attempting to access the network by exchanging secure information between the RADIUS server and the Client through EAPOL packets and, in turn, informs the Switch whether or not the Client is granted access to the LAN and/or switches services.

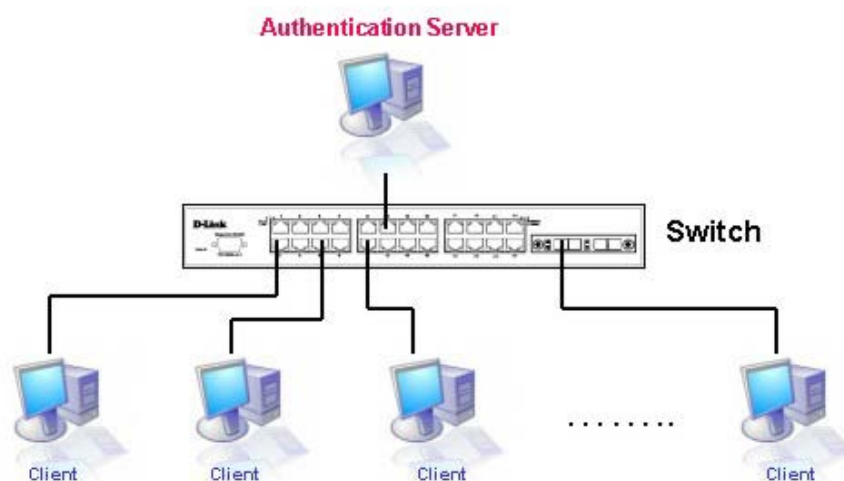

Figure 6 - 20. Authentication Server

## Authenticator

The Authenticator (the Switch) is an intermediary between the Authentication Server and the Client. The Authenticator serves two purposes when utilizing the 802.1X function. The first purpose is to request certification information from the Client through EAPOL packets, which is the only information allowed to pass through the Authenticator before access is granted to the Client. The second purpose of the Authenticator is to verify the information gathered from the Client with the Authentication Server, and to then relay that information back to the Client.

Three steps must be implemented on the Switch to properly configure the Authenticator.

1. The 802.1X State must be *Enabled*. (**Security / 802.1X / 802.1X Settings**)
2. The 802.1X settings must be implemented by port (**Security / 802.1X / 802.1X Settings**)
3. A RADIUS server must be configured on the Switch. (**Security / 802.1X / Authentic RADIUS Server**)

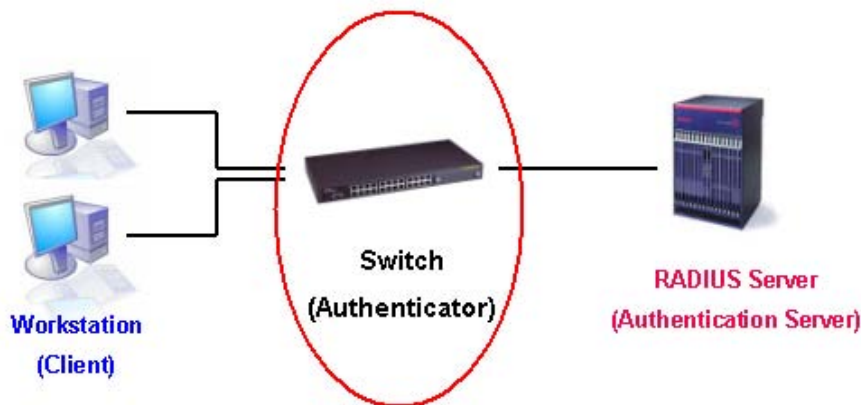

Figure 6 - 21. Authenticator

## Client

The Client is simply the endstation that wishes to gain access to the LAN or switch services. All end stations must be running software that is compliant with the 802.1X protocol. For users running Windows XP and Windows Vista, that software is included within the operating system. All other users are required to attain 802.1X client software from an outside source. The Client will request access to the LAN and or Switch through EAPOL packets and, in turn will respond to requests from the Switch.

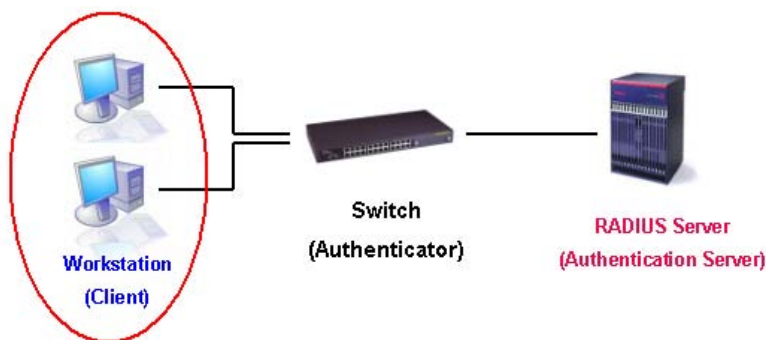

Figure 6 - 22. Client

## Authentication Process

Utilizing the three roles stated above, the 802.1X protocol provides a stable and secure way of authorizing and authenticating users attempting to access the network. Only EAPOL traffic is allowed to pass through the specified port before a successful authentication is made. This port is “locked” until the point when a Client with the correct username and password (and MAC address if 802.1X is enabled by MAC address) is granted access and therefore successfully “unlocks” the port. Once unlocked, normal traffic is allowed to pass through the port. The following figure displays a more detailed explanation of how the authentication process is completed between the three roles stated above.

## 802.1X Authentication process

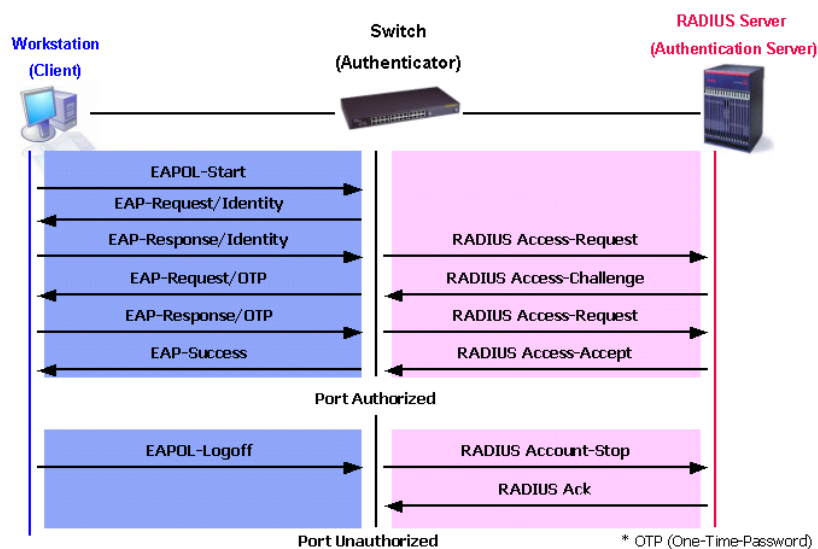

Figure 6 - 23. 802.1X Authentication Process

The D-Link implementation of 802.1X allows network administrators to choose between two types of Access Control used on the Switch, which are:

1. Port-based Access Control – This method requires only one user to be authenticated per port by a remote RADIUS server to allow the remaining users on the same port access to the network.
2. Host-based Access Control – Using this method, the Switch will automatically learn up to sixteen MAC addresses by port and set them in a list. Each MAC address must be authenticated by the Switch using a remote RADIUS server before being allowed access to the Network.

## Understanding 802.1X Port-based and Host-based Network Access Control

The original intent behind the development of 802.1X was to leverage the characteristics of point-to-point in LANs. As any single LAN segment in such infrastructures has no more than two devices attached to it, one of which is a Bridge Port. The Bridge Port detects events that indicate the attachment of an active device at the remote end of the link, or an active device becoming inactive. These events can be used to control the authorization state of the Port and initiate the process of authenticating the attached device if the Port is unauthorized. This is the Port-Based Network Access Control.



## Port-based Network Access Control

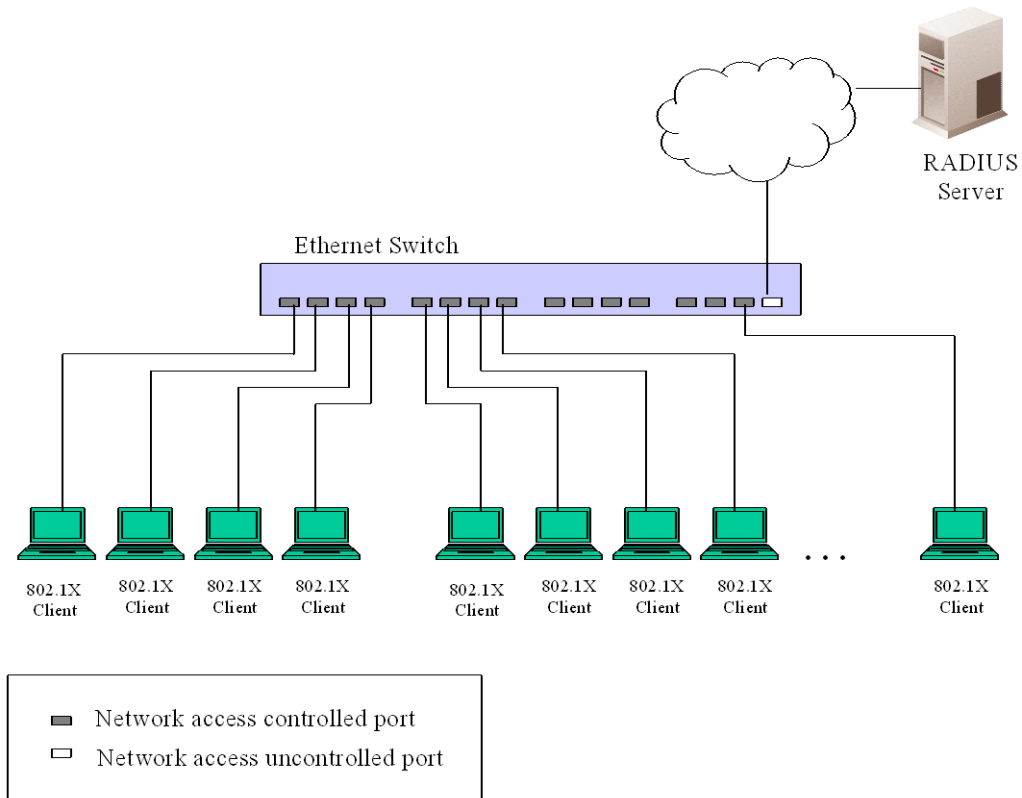

**Figure 6 - 24. Example of Typical Port-based Configuration**

Once the connected device has successfully been authenticated, the Port then becomes Authorized, and all subsequent traffic on the Port is not subject to access control restriction until an event occurs that causes the Port to become Unauthorized. Hence, if the Port is actually connected to a shared media LAN segment with more than one attached device, successfully authenticating one of the attached devices effectively provides access to the LAN for all devices on the shared segment. Clearly, the security offered in this situation is open to attack.

## Host-based Network Access Control

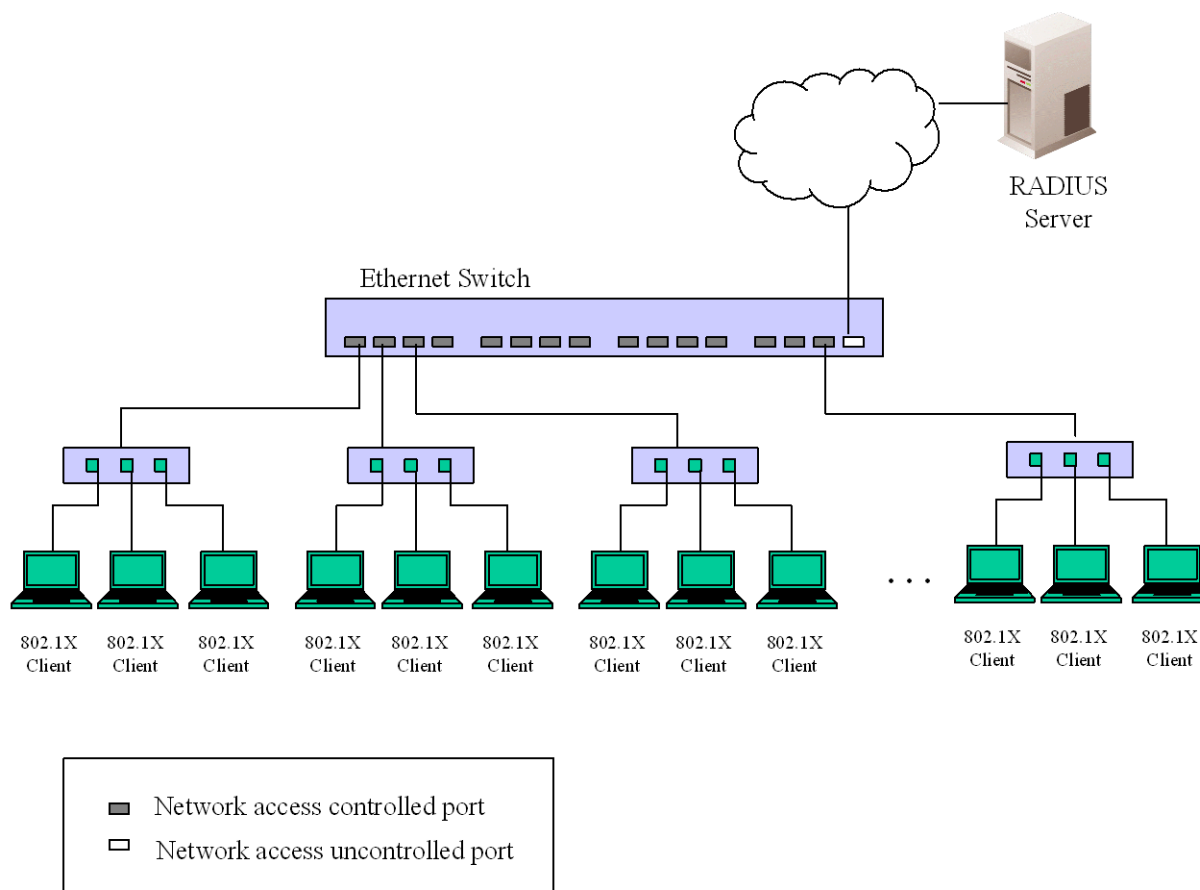

Figure 6 - 25. Example of Typical Host-based Configuration

In order to successfully make use of 802.1X in a shared media LAN segment, it would be necessary to create “logical” Ports, one for each attached device that required access to the LAN. The Switch would regard the single physical Port connecting it to the shared media segment as consisting of a number of distinct logical Ports, each logical Port being independently controlled from the point of view of EAPOL exchanges and authorization state. The Switch learns each attached devices’ individual MAC addresses, and effectively creates a logical Port that the attached device can then use to communicate with the LAN via the Switch.

The **802.1X** folder contains seven windows (depending on the current 802.1X) settings: **802.1X Settings**, **802.1X User**, **Initialize Port(s)** (Port-based and MAC-based), **Reauthenticate Port(s)** (Port-based and MAC-based), and **Authentic RADIUS Server**.

## 802.1X Global Settings

Users can configure 802.1X authenticator settings.

To view the following window, click **Security > 802.1X > 802.1X Global Settings**:



Figure 6 - 26. 802.1X Global Settings window

The following parameters can be configured:

Parameter	Description
<b>Authentication State</b>	Use the drop-down menu to enable or disable the 802.1X function.
<b>Authentication Protocol</b>	Choose the authenticator protocol, <i>Local</i> or <i>RADIUS EAP</i> .
<b>Forward EAPOL PDU</b>	This is a global setting to control the forwarding of EAPOL PDU. When 802.1X functionality is disabled globally or for a port, and if 802.1X forward PDU is enabled both globally and for the port, a received EAPOL packet on the port will be flooded in the same VLAN to those ports for which 802.1X forward PDU is enabled and 802.1X is disabled (globally or just for the port). The default state is disabled.
<b>Max User (1-448)</b>	Specifies the maximum number of users. The limit on the maximum users is 448 users. This the <b>No Limit</b> check box to have unlimited users.
<b>RADIUS Authorization</b>	This option is used to enable or disable acceptance of authorized configuration. When the authorization is enabled for 802.1X's RADIUS, the authorized data assigned by the RADIUS server will be accepted if the global authorization network is enabled.

Click **Apply** to implement configuration changes.

## 802.1X Port Settings

This window is used to configure the 802.1X authenticator port settings.

To view the following window, click **Security > 802.1X > 802.1X Port Settings**:

The screenshot shows the '802.1X Port Settings' window with the following configuration fields:

- From Port: 01
- To Port: 01
- QuietPeriod (0-65535): 60 sec
- SuppTimeout (1-65535): 30 sec
- ServerTimeout (1-65535): 30 sec
- MaxReq (1-10): 2 times
- TX Period (1-65535): 30 sec
- ReAuthPeriod (1-65535): 3600 sec
- ReAuthentication: Disabled
- Port Control: Auto
- Capability: None
- Direction: Both
- Forward EAPOL PDU: Disabled
- Max User (1-448): 16  No Limit

Buttons: Refresh, Apply

Port	AdmDir	OpenCtrlDir	Port Control	TX Period	Quiet Period	Supp-Timeout	Server-Timeout	MaxReq	ReAuth Period	ReAuth	Capability	Forward EAPOL PDU	Max User
1	Both	Both	Auto	30	60	30	30	2	3600	Disabled	None	Disabled	16
2	Both	Both	Auto	30	60	30	30	2	3600	Disabled	None	Disabled	16
3	Both	Both	Auto	30	60	30	30	2	3600	Disabled	None	Disabled	16
4	Both	Both	Auto	30	60	30	30	2	3600	Disabled	None	Disabled	16
5	Both	Both	Auto	30	60	30	30	2	3600	Disabled	None	Disabled	16
6	Both	Both	Auto	30	60	30	30	2	3600	Disabled	None	Disabled	16
7	Both	Both	Auto	30	60	30	30	2	3600	Disabled	None	Disabled	16
8	Both	Both	Auto	30	60	30	30	2	3600	Disabled	None	Disabled	16
9	Both	Both	Auto	30	60	30	30	2	3600	Disabled	None	Disabled	16
10	Both	Both	Auto	30	60	30	30	2	3600	Disabled	None	Disabled	16
11	Both	Both	Auto	30	60	30	30	2	3600	Disabled	None	Disabled	16
12	Both	Both	Auto	30	60	30	30	2	3600	Disabled	None	Disabled	16
13	Both	Both	Auto	30	60	30	30	2	3600	Disabled	None	Disabled	16
14	Both	Both	Auto	30	60	30	30	2	3600	Disabled	None	Disabled	16
15	Both	Both	Auto	30	60	30	30	2	3600	Disabled	None	Disabled	16
16	Both	Both	Auto	30	60	30	30	2	3600	Disabled	None	Disabled	16
17	Both	Both	Auto	30	60	30	30	2	3600	Disabled	None	Disabled	16
18	Both	Both	Auto	30	60	30	30	2	3600	Disabled	None	Disabled	16
19	Both	Both	Auto	30	60	30	30	2	3600	Disabled	None	Disabled	16

Figure 6 - 27. 802.1X Port Settings window

The following parameters can be configured:

Parameter	Description
-----------	-------------

<b>From Port / To Port</b>	Select a range of ports you wish to configure.
<b>QuietPeriod (0-65535)</b>	This allows the user to set the number of seconds that the Switch remains in the quiet state following a failed authentication exchange with the client. The default setting is 60 seconds.
<b>SuppTimeout (1-65535)</b>	This value determines timeout conditions in the exchanges between the Authenticator and the client. The default setting is 30 seconds. It is defined in SuppTimeout, IEEE-802.1X-2001, page 47. The initialization value is used for the awhile timer when timing out the Supplicant. Its default value is 30 seconds; however, if the type of challenge involved in the current exchange demands a different value of timeout (for example, if the challenge requires an action on the part of the user), then the timeout value is adjusted accordingly. It can be set by management to any value in the range from 1 to 65535 seconds.
<b>ServerTimeout (1-65535)</b>	This value determines timeout conditions in the exchanges between the Authenticator and the authentication server. The default setting is 30 seconds.
<b>MaxReq (1-10)</b>	The maximum number of times that the Switch will retransmit an EAP Request to the client before it times out of the authentication sessions. The default setting is 2. It is defined in MaxReq, IEEE-802.1X-2001 page 47. The maximum number of times that the state machine will retransmit an EAP Request packet to the Supplicant before it times out the authentication session. Its default value is 2; it can be set by management to any value in the range from 1 to 10.
<b>TxPeriod (1-65535)</b>	This sets the TxPeriod of time for the authenticator PAE state machine. This value determines the period of an EAP Request/Identity packet transmitted to the client. The default setting is 30 seconds.
<b>ReAuthPeriod (1-65535)</b>	A constant that defines a nonzero number of seconds between periodic re-authentication of the client. The default setting is 3600 seconds.
<b>ReAuthentication</b>	Determines whether regular re-authentication will take place on this port. The default setting is <i>Disabled</i> .
<b>Port Control</b>	<p>This allows the user to control the port authorization state.</p> <p>Select <i>ForceAuthorized</i> to disable 802.1X and cause the port to transition to the authorized state without any authentication exchange required. This means the port transmits and receives normal traffic without 802.1X-based authentication of the client.</p> <p>If <i>ForceUnauthorized</i> is selected, the port will remain in the unauthorized state, ignoring all attempts by the client to authenticate. The Switch cannot provide authentication services to the client through the interface.</p> <p>If <i>Auto</i> is selected, it will enable 802.1X and cause the port to begin in the unauthorized state, allowing only EAPOL frames to be sent and received through the port. The authentication process begins when the link state of the port transitions from down to up, or when an EAPOL-start frame is received. The Switch then requests the identity of the client and begins relaying authentication messages between the client and the authentication server.</p> <p>The default setting is <i>Auto</i>.</p>
<b>Capability</b>	This allows the 802.1X Authenticator settings to be applied on a per-port basis. Select <i>Authenticator</i> to apply the settings to the port. When the setting is activated, a user must pass the authentication process to gain access to the network. Select <i>None</i> to disable 802.1X functions on the port.
<b>Direction</b>	Sets the administrative-controlled direction to <i>Both</i> . Control is exerted over both incoming and outgoing traffic through the controlled port selected in the first field.
<b>Forward EAPOL PDU</b>	This is a port-based setting to control the forwarding of EAPOL PDU. When 802.1X functionality is disabled globally or for a port, and if 802.1X forward PDU is enabled both globally and for the port, a received EAPOL packet on the port will be flooded in the same VLAN to those ports for which 802.1X forward PDU is enabled and 802.1X is disabled (globally or just for the port). The default state is disabled.
<b>Max Users (1-448)</b>	Specifies the maximum number of users. The maximum user limit is 448 users. The default is 16. Tick <b>No Limit</b> to have unlimited users.

Click the **Refresh** button to refresh the display table so that new entries will appear. Click **Apply** to implement configuration changes.

## 802.1X User Settings

Users can set different local users on the Switch.

To view the following window, click **Security** > **802.1X** > **802.1X User Settings**:



Figure 6 - 28. 802.1X User Settings window

Enter an 802.1X user name, password, and confirmation of that password. Properly configured local users will be displayed in the 802.1X User Table at the bottom of the window. Click **Apply** to implement configuration changes. Click **Delete** to remove the specific entry.

## Guest VLAN Settings

On 802.1X security-enabled networks, there is a need for non-802.1X supported devices to gain limited access to the network, due to lack of the proper 802.1X software or incompatible devices, such as computers running Windows 98 or older operating systems, or the need for guests to gain access to the network without full authorization or local authentication on the Switch. To supplement these circumstances, this switch now implements 802.1X Guest VLANs. These VLANs should have limited access rights and features separate from other VLANs on the network.

To implement 802.1X Guest VLANs, the user must first create a VLAN on the network with limited rights and then enable it as an 802.1X guest VLAN. Then the administrator must configure the guest accounts accessing the Switch to be placed in a Guest VLAN when trying to access the Switch. Upon initial entry to the Switch, the client wishing services on the Switch will need to be authenticated by a remote RADIUS Server or local authentication on the Switch to be placed in a fully operational VLAN. If authenticated and the authenticator possesses the VLAN placement information, that client will be accepted into the fully operational target VLAN and normal switch functions will be open to the client. If the authenticator does not have target VLAN placement information, the client will be returned to its originating VLAN. Yet, if the client is denied authentication by the authenticator, it will be placed in the Guest VLAN where it has limited rights and access. The adjacent figure should give the user a better understanding of the Guest VLAN process.

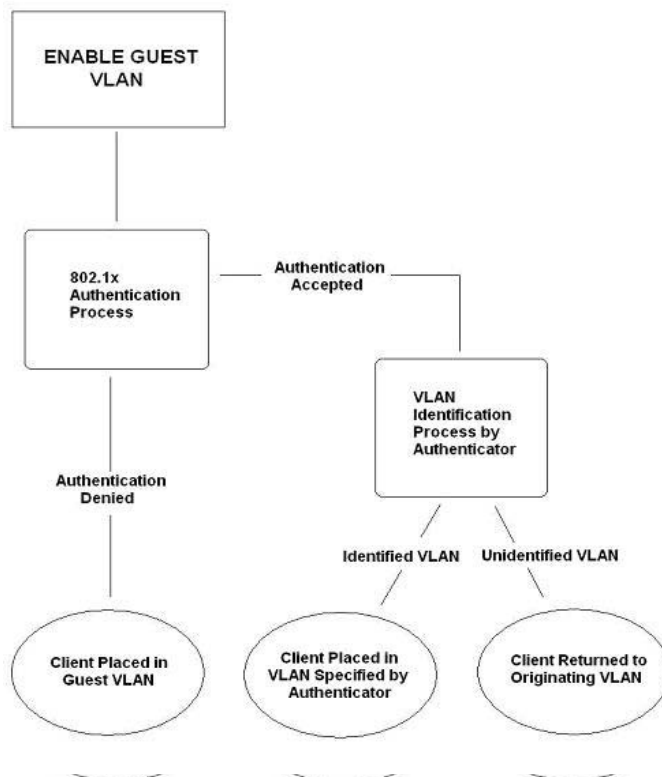

Figure 6 - 29. Guest VLAN Authentication Process

### Limitations Using the Guest VLAN

1. Ports supporting Guest VLANs cannot be GVRP enabled and vice versa.
2. A port cannot be a member of a Guest VLAN and a static VLAN simultaneously.
3. Once a client has been accepted into the target VLAN, it can no longer access the Guest VLAN.
4. If a port is a member of multiple VLANs, it cannot become a member of the Guest VLAN.

Remember, to set an 802.1X guest VLAN, the user must first configure a normal VLAN, which can be enabled here for guest VLAN status.

To view the following window, click **Security > 802.1X > Guest VLAN Settings**:

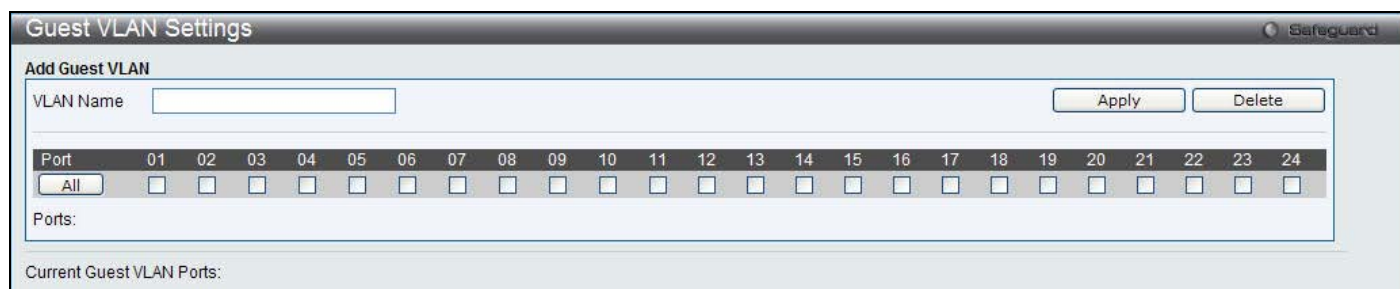

**Figure 6 - 30. Guest VLAN Settings window**

The following fields may be modified to enable the 802.1X guest VLAN:

Parameter	Description
<b>VLAN Name</b>	Enter the pre-configured VLAN name to create as an 802.1X guest VLAN.
<b>Port</b>	Set the ports to be enabled for the 802.1X guest VLAN. Click <b>All</b> to select all ports.

Click **Apply** to implement the guest VLAN settings entered. Only one VLAN may be assigned as the 802.1X guest VLAN.

## Authenticator State

This window is used to display the authenticator state. This window appears when the **Authentication State** is enabled in 802.1X Global Settings window.

To view the following window, click **Security > 802.1X > Authenticator State**:

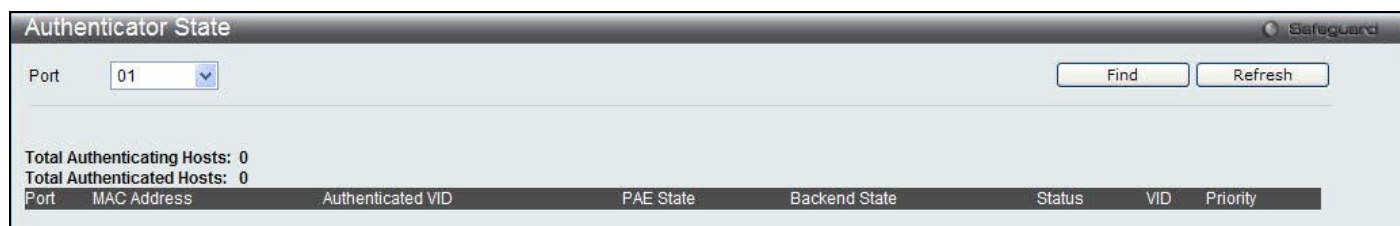

**Figure 6 - 31. Authenticator State window**

The following parameter can be configured:

Parameter	Description
<b>Port</b>	Use the drop-down menu to select a port.

Click the **Find** button to locate a specific entry based on the information entered. Click the **Refresh** button to refresh the display table so that new entries will appear.

## Authenticator Statistics

This window is used to display the authenticator statistics information. This window appears when the **Authentication State** is enabled in 802.1X Global Settings window.

To view the following window, click **Security > 802.1X > Authenticator Statistics**:

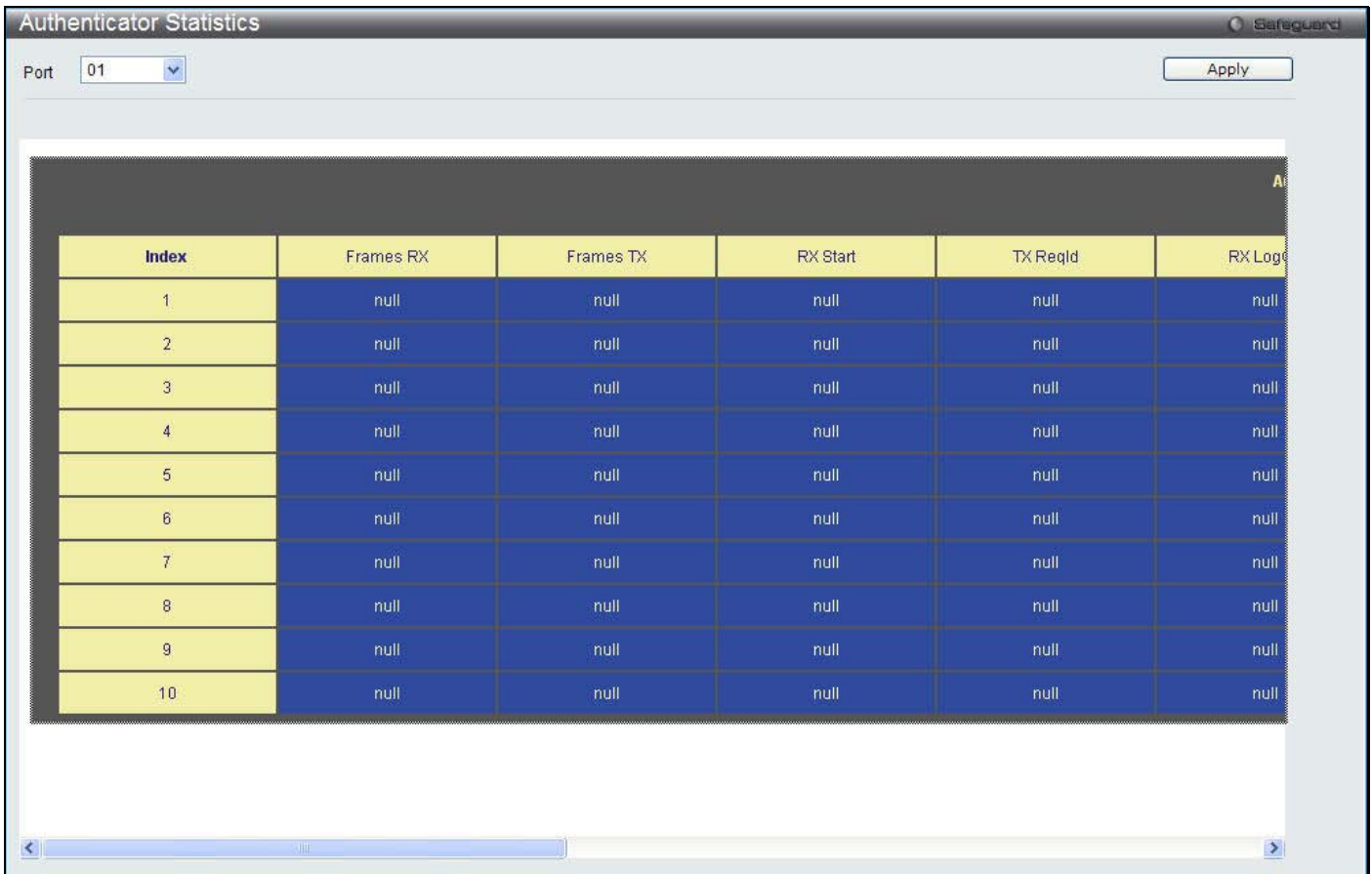

**Figure 6 - 32. Authenticator Statistics window**

The following parameter can be configured:

Parameter	Description
Port	Use the drop-down menu to select a port.

Click the **Apply** button to accept the changes made.

## Authenticator Session Statistics

This window is used to display the authenticator session statistics information. This window appears when the **Authentication State** is enabled in 802.1X Global Settings window.

To view the following window, click **Security > 802.1X > Authenticator Session Statistics**:

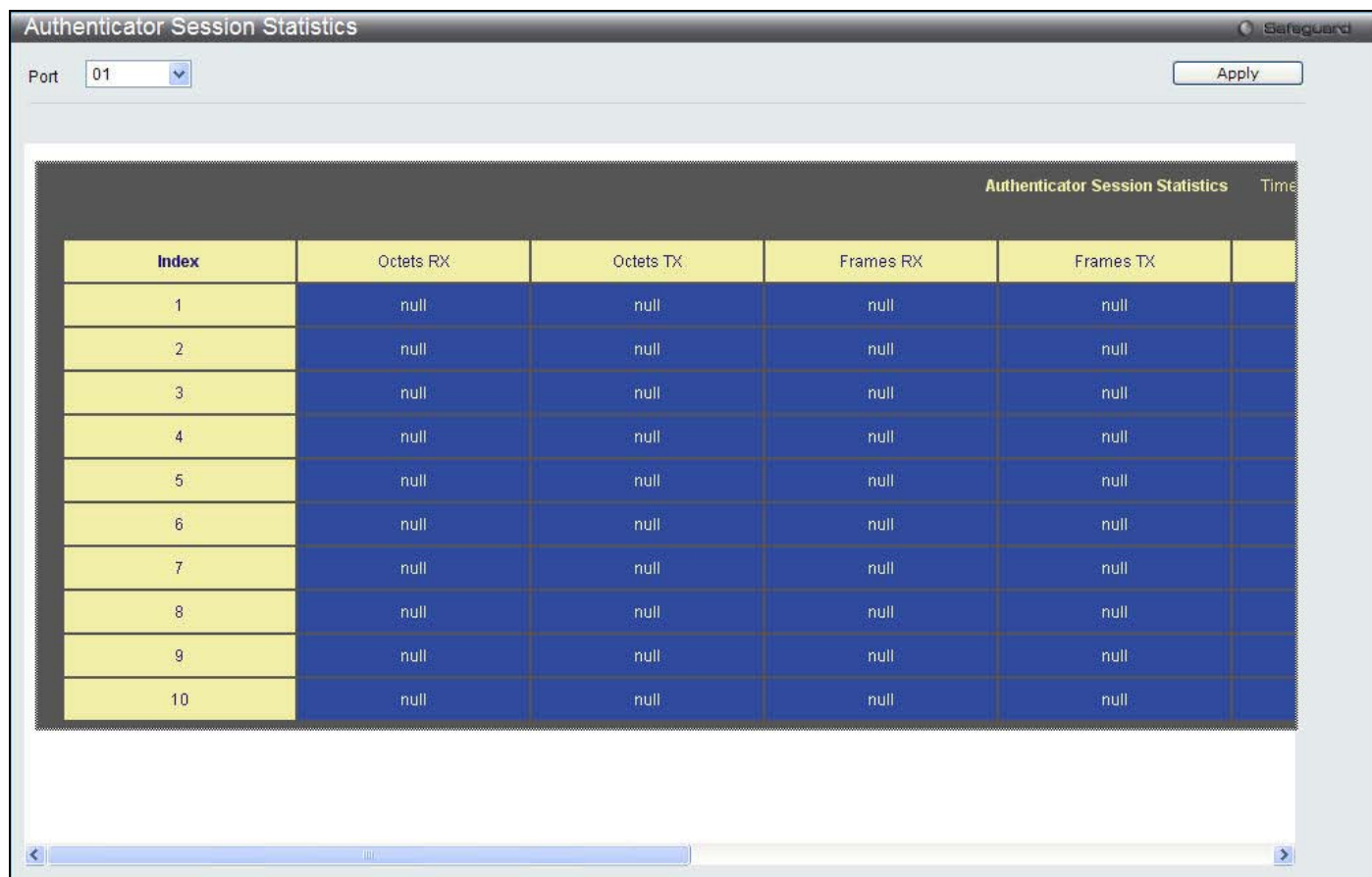

Figure 6 - 33. Authenticator Session Statistics window

The following parameter can be configured:

Parameter	Description
Port	Use the drop-down menu to select a port.

Click the **Apply** button to accept the changes made.

## Authenticator Diagnostics

This window is used to display the authenticator diagnostics information. This window appears when the **Authentication State** is enabled in 802.1X Global Settings window.

To view the following window, click **Security > 802.1X > Authenticator Diagnostics**:



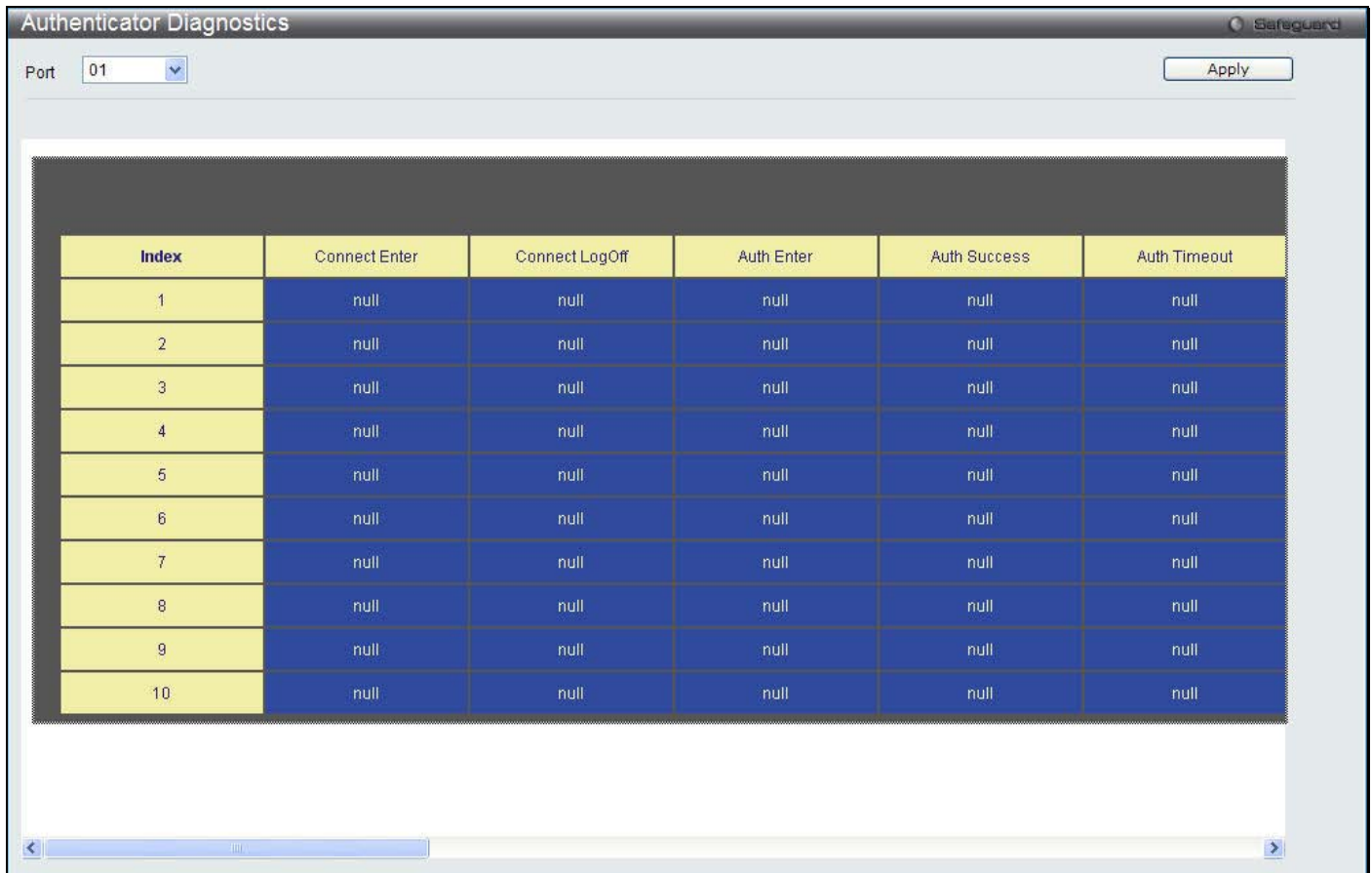

Figure 6 - 34. Authenticator Diagnostics window

The following parameter can be configured:

Parameter	Description
Port	Use the drop-down menu to select a port.

Click the **Apply** button to accept the changes made.

## Initialize Port-based Port(s)

This window displays the current initialized port-based ports. This window appears when the **Authentication State** is enabled in 802.1X Global Settings window.

To view the following window, click **Security > 802.1X > Initialize Port-based Port(s)**:



Figure 6 - 35. Initialize Port-based Port(s) window

The following parameter can be configured:

Parameter	Description
From Port / To Port	Use the drop-down menus to select a range of ports.

Click the **Apply** button to accept the changes made.

## Initialize Host-based Port(s)

This window displays the current initialized host-based ports. This window appears when the **Authentication State** is enabled in 802.1X Global Settings window.

To view the following window, click **Security > 802.1X > Initialize Host-based Port(s)**:

Figure 6 - 36. Initialize Host-based Port(s) window

The following parameter can be configured:

Parameter	Description
<b>From Port / To Port</b>	Use the drop-down menus to select a range of ports.
<b>MAC Address</b>	Tick the check box and enter the authenticated MAC address of the client connected to the corresponding port.

Click the **Apply** button to accept the changes made.

## Reauthenticate Port-based Port(s)

This window is used to display the current status of the re-authenticated port-based port(s). This window appears when the **Authentication State** is enabled in 802.1X Global Settings window.

To view the following window, click **Security > 802.1X > Reauthenticate Port-based Port(s)**:

Figure 6 - 37. Reauthenticate Port-based Port(s) window

The following parameter can be configured:

Parameter	Description
<b>From Port / To Port</b>	Use the drop-down menus to select a range of ports.

Click the **Apply** button to accept the changes made.

## Reauthenticate Host-based Port(s)

This window is used to display the current status of the re-authenticated host-based port(s). This window appears when the **Authentication State** is enabled in 802.1X Global Settings window.

To view the following window, click **Security > 802.1X > Reauthenticate Host-based Port(s)**:

**Figure 6 - 38. Reauthenticate Host-based Port(s) window**

The following parameter can be configured:

Parameter	Description
From Port / To Port	Use the drop-down menus to select a range of ports.
MAC Address	The authenticated MAC address of the client connected to the corresponding port, if any.

Click the **Apply** button to accept the changes made.

## SSL

### SSL Settings

Secure Sockets Layer, or SSL, is a security feature that will provide a secure communication path between a host and client through the use of authentication, digital signatures and encryption. These security functions are implemented through the use of a cyphersuite, which is a security string that determines the exact cryptographic parameters, specific encryption algorithms and key sizes to be used for an authentication session and consists of three levels:

1. **Key Exchange:** The first part of the cyphersuite string specifies the public key algorithm to be used. This switch utilizes the Rivest Shamir Adleman (RSA) public key algorithm and the Digital Signature Algorithm (DSA), specified here as the *DHE DSS* Diffie-Hellman (DHE) public key algorithm. This is the first authentication process between client and host as they “exchange keys” in looking for a match and therefore authentication to be accepted to negotiate encryptions on the following level.
2. **Encryption:** The second part of the ciphersuite that includes the encryption used for encrypting the messages sent between client and host. The Switch supports two types of cryptology algorithms:

Stream Ciphers – There are two types of stream ciphers on the Switch, *RC4 with 40-bit keys* and *RC4 with 128-bit keys*. These keys are used to encrypt messages and need to be consistent between client and host for optimal use.

CBC Block Ciphers – CBC refers to Cipher Block Chaining, which means that a portion of the previously encrypted block of encrypted text is used in the encryption of the current block. The Switch supports the *3DES EDE* encryption code defined by the Data Encryption Standard (DES) to create the encrypted text.

3. **Hash Algorithm:** This part of the ciphersuite allows the user to choose a message digest function which will determine a Message Authentication Code. This Message Authentication Code will be encrypted with a sent message to provide integrity and prevent against replay attacks. The Switch supports two hash algorithms, *MD5* (Message Digest 5) and *SHA* (Secure Hash Algorithm).

These three parameters are uniquely assembled in four choices on the Switch to create a three-layered encryption code for secure communication between the server and the host. The user may implement any one or combination of the ciphersuites available, yet different ciphersuites will affect the security level and the performance of the secured connection. The information included in the ciphersuites is not included with the Switch and requires downloading from a third source in a file form called a *certificate*. This function of the Switch cannot be executed without the presence and implementation of the certificate file and can be downloaded to the Switch by utilizing a TFTP server. The Switch supports SSLv3. Other versions of SSL may not be compatible with this Switch and may cause problems upon authentication and transfer of messages from client to host.

The **SSL Settings** window located on the next page will allow the user to enable SSL on the Switch and implement any one or combination of listed ciphersuites on the Switch. A ciphersuite is a security string that determines the exact cryptographic parameters, specific encryption algorithms and key sizes to be used for an authentication session. The Switch possesses four possible ciphersuites for the SSL function, which are all enabled by default. To utilize a particular ciphersuite, disable the unwanted ciphersuites, leaving the desired one for authentication.

When the SSL function has been enabled, the web will become disabled. To manage the Switch through the web based management while utilizing the SSL function, the web browser must support SSL encryption and the header of the URL must begin with `https://`. (Ex. `https://xx.xx.xx.xx`) Any other method will result in an error and no access can be authorized for the web-based management.

Users can download a certificate file for the SSL function on the Switch from a TFTP server. The certificate file is a data record used for authenticating devices on the network. It contains information on the owner, keys for authentication and digital signatures. Both the server and the client must have consistent certificate files for optimal use of the SSL function. The Switch only supports certificate files with `.der` file extensions. Currently, the Switch comes with a certificate pre-loaded though the user may need to download more, depending on user circumstances.

To view the following window, click **Security > SSL > SSL Settings**:

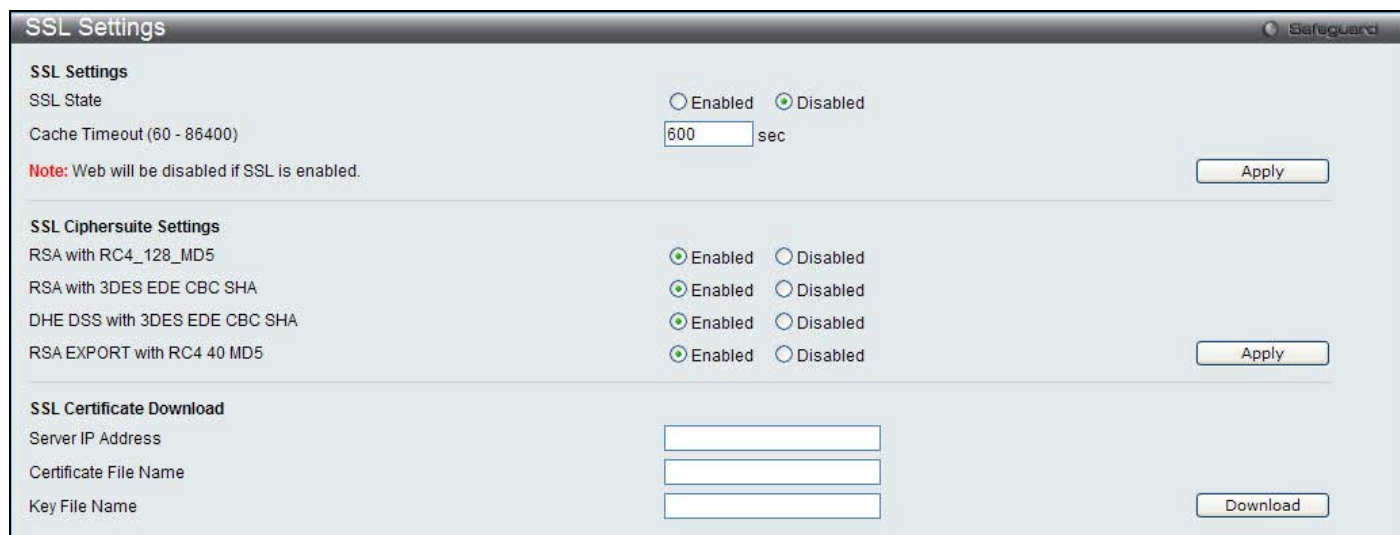

**Figure 6 - 39. SSL Settings window**

To set up the SSL function on the Switch, configure the parameters in the SSL Settings section described below and click **Apply**.

To set up the SSL ciphersuite function on the Switch, configure the parameters in the SSL Ciphersuite Settings section described below and click **Apply**.

To download SSL certificates, configure the parameters in the SSL Certificate Download section described below and click **Download**.

Parameter	Description
<b>SSL Settings</b>	
<b>SSL State</b>	Use the radio buttons to enable or disable the SSL status on the Switch. The default is Disabled.
<b>Cache Timeout (60-86400)</b>	This field will set the time between a new key exchange between a client and a host using the SSL function. A new SSL session is established every time the client and host go through a key exchange. Specifying a longer timeout will allow the SSL session to reuse the master key on future connections with that particular host, therefore speeding up the negotiation process. The default setting is 600 seconds.
<b>SSL Ciphersuite Settings</b>	
<b>RSA with RC4_128_MD5</b>	This ciphersuite combines the RSA key exchange, stream cipher RC4 encryption with 128-bit keys and the MD5 Hash Algorithm. Use the radio buttons to enable or disable this ciphersuite. This field is Enabled by default.
<b>RSA with 3DES EDE CBC SHA</b>	This ciphersuite combines the RSA key exchange, CBC Block Cipher 3DES_EDE encryption and the SHA Hash Algorithm. Use the radio buttons to enable or disable this ciphersuite. This field is Enabled by default.
<b>DHE DSS with 3DES EDE CBC SHA</b>	This ciphersuite combines the DSA Diffie Hellman key exchange, CBC Block Cipher 3DES_EDE encryption and SHA Hash Algorithm. Use the radio buttons to enable or disable this ciphersuite. This field is Enabled by default.
<b>RSA EXPORT with RC4 40 MD5</b>	This ciphersuite combines the RSA Export key exchange and stream cipher RC4 encryption with 40-bit keys. Use the radio buttons to enable or disable this ciphersuite. This field is Enabled by default.
<b>SSL Certificate Download</b>	
<b>Server IP Address</b>	Enter the IPv4 address of the TFTP server where the certificate files are located.
<b>Certificate File Name</b>	Enter the path and the filename of the certificate file to download. This file must have a .der extension. (Ex. c:/cert.der)
<b>Key File Name</b>	Enter the path and the filename of the key file to download. This file must have a .der extension (Ex. c:/pkey.der)

Click **Apply** to implement changes made.



**NOTE:** Certain implementations concerning the function and configuration of SSL are not available on the web-based management of this Switch and need to be configured using the command line interface.



**NOTE:** Enabling the SSL command will disable the web-based switch management. To log on to the Switch again, the header of the URL must begin with https://. Entering anything else into the address field of the web browser will result in an error and no authentication will be granted.

## SSL Certification Settings

This window is used to display SSL certification settings

To view the following window, click **Security > SSL > SSL Certification Settings**:

Figure 6 - 40. SSL Certification Settings window

The following parameter can be configured:

Parameter	Description
<b>SSL Certificate File Name</b>	Specify the SSL certificate file name.
<b>SSL CA Chain Configuration</b>	Click the <b>Default</b> radio button to use the build-in certification on the Switch, or click the radio button below to specify chain of certifications on the Switch.

Click the **Apply** button to accept the changes made. Click **Delete** to remove the specified entry.

## SSH

SSH is an abbreviation of Secure Shell, which is a program allowing secure remote login and secure network services over an insecure network. It allows a secure login to remote host computers, a safe method of executing commands on a remote end node, and will provide secure encrypted and authenticated communication between two non-trusted hosts. SSH, with its array of

unmatched security features is an essential tool in today’s networking environment. It is a powerful guardian against numerous existing security hazards that now threaten network communications.

The steps required to use the SSH protocol for secure communication between a remote PC (the SSH client) and the Switch (the SSH server) are as follows:

1. Create a user account with admin-level access using the **User Accounts** window (**Configuration > Port Configuration > User Accounts**). This is identical to creating any other admin-level User Account on the Switch, including specifying a password. This password is used to logon to the Switch, once a secure communication path has been established using the SSH protocol.
2. Configure the User Account to use a specified authorization method to identify users that are allowed to establish SSH connections with the Switch using the **SSH User Authentication Mode** window. There are three choices as to the method SSH will use to authorize the user, which are Host Based, Password, and Public Key.
3. Configure the encryption algorithm that SSH will use to encrypt and decrypt messages sent between the SSH client and the SSH server, using the **SSH Authmode and Algorithm Settings** window.
4. Finally, enable SSH on the Switch using the **SSH Configuration** window.

After completing the preceding steps, a SSH Client on a remote PC can be configured to manage the Switch using a secure, in band connection.

## SSH Settings

Users can configure and view settings for the SSH server.

To view the following window, click **Security > SSH > SSH Settings**:



**Figure 6 - 41. SSH Settings window**

To configure the SSH server on the Switch, modify the following parameters and click **Apply**:

Parameter	Description
<b>SSH Server State</b>	Use the radio buttons to enable or disable SSH on the Switch. The default is Disabled.
<b>Max Session (1-8)</b>	Enter a value between 1 and 8 to set the number of users that may simultaneously access the Switch. The default setting is 8.
<b>Connection Timeout (120-600 sec)</b>	Allows the user to set the connection timeout. The user may set a time between 120 and 600 seconds. The default setting is 120 seconds.
<b>Authfail Attempts (2-20)</b>	Allows the Administrator to set the maximum number of attempts that a user may try to log on to the SSH Server utilizing the SSH authentication. After the maximum number of attempts has been exceeded, the Switch will be disconnected and the user must reconnect to the Switch to attempt another login. The number of maximum attempts may be set between 2 and 20. The default setting is 2.
<b>Rekey Timeout</b>	This field is used to set the time period that the Switch will change the security shell encryptions by using the drop-down menu. The available options are <i>Never</i> , <i>10 min</i> , <i>30 min</i> , and <i>60 min</i> . The default setting is <i>Never</i> .
<b>TCP Port Number (1-65535)</b>	Enter the TCP Port Number used for SSH. The default value is 22.

Click **Apply** to implement the changes.

## SSH Authentication Method and Algorithm Settings

Users can configure the desired types of SSH algorithms used for authentication encryption. There are three categories of algorithms listed and specific algorithms of each may be enabled or disabled by ticking their corresponding check boxes. All algorithms are enabled by default.

To view the following window, click **Security > SSH > SSH Authentication Method and Algorithm Settings**:

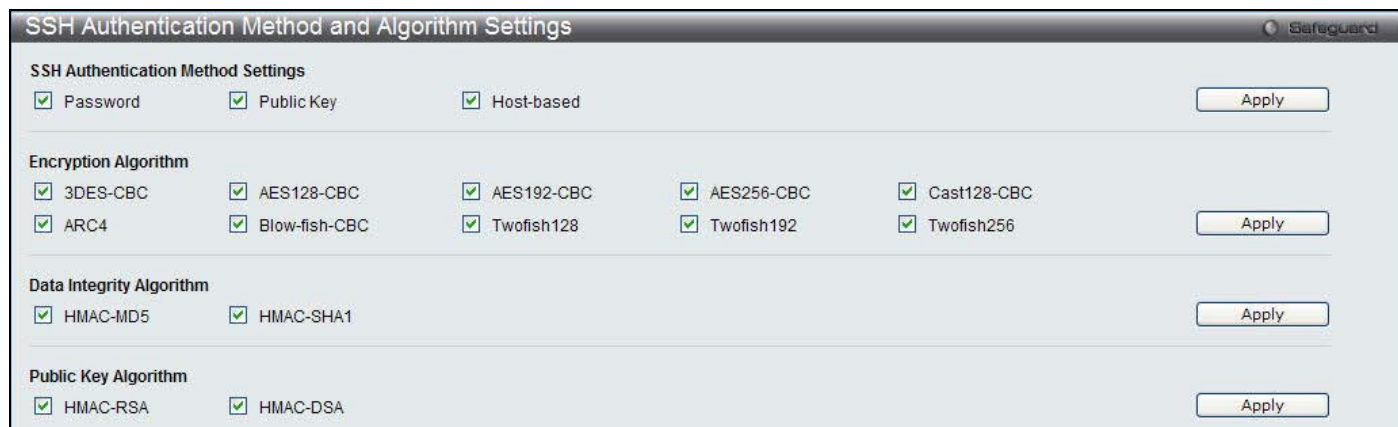

**Figure 6 - 42. SSH Authentication method and Algorithm Settings window**

The following algorithms may be set:

Parameter	Description
<b>SSH Authentication Mode Settings</b>	
<b>Password</b>	This may be enabled or disabled to choose if the administrator wishes to use a locally configured password for authentication on the Switch. This parameter is enabled by default.
<b>Public Key</b>	This may be enabled or disabled to choose if the administrator wishes to use a public key configuration set on a SSH server, for authentication. This parameter is enabled by default.
<b>Host-based</b>	This may be enabled or disabled to choose if the administrator wishes to use a host computer for authentication. This parameter is intended for Linux users requiring SSH authentication techniques and the host computer is running the Linux operating system with a SSH program previously installed. This parameter is enabled by default.
<b>Encryption Algorithm</b>	
<b>3DES-CBC</b>	Use the check box to enable or disable the Triple Data Encryption Standard encryption algorithm with Cipher Block Chaining. The default is enabled.
<b>AES128-CBC</b>	Use the check box to enable or disable the Advanced Encryption Standard AES128 encryption algorithm with Cipher Block Chaining. The default is enabled.
<b>AES192-CBC</b>	Use the check box to enable or disable the Advanced Encryption Standard AES192 encryption algorithm with Cipher Block Chaining. The default is enabled.
<b>AES256-CBC</b>	Use the check box to enable or disable the Advanced Encryption Standard AES-256 encryption algorithm with Cipher Block Chaining. The default is enabled.
<b>Cast128-CBC</b>	Use the check box to enable or disable the Cast128 encryption algorithm with Cipher Block Chaining. The default is enabled.
<b>ARC4</b>	Use the check box to enable or disable the Arcfour encryption algorithm with Cipher Block Chaining. The default is enabled.
<b>Blow-fish CBC</b>	Use the check box to enable or disable the Blowfish encryption algorithm with Cipher

	Block Chaining. The default is enabled.
<b>Twofish128</b>	Use the check box to enable or disable the twofish128 encryption algorithm. The default is enabled.
<b>Twofish192</b>	Use the check box to enable or disable the twofish192 encryption algorithm. The default is enabled.
<b>Twofish256</b>	Use the check box to enable or disable the twofish256 encryption algorithm. The default is enabled.
<b>Data Integrity Algorithm</b>	
<b>HMAC-MD5</b>	Use the check box to enable or disable the HMAC (Hash for Message Authentication Code) mechanism utilizing the MD5 Message Digest encryption algorithm. The default is enabled.
<b>HMAC-SHA1</b>	Use the check box to enable or disable the HMAC (Hash for Message Authentication Code) mechanism utilizing the Secure Hash algorithm. The default is enabled.
<b>Public Key Algorithm</b>	
<b>HMAC-RSA</b>	Use the check box to enable or disable the HMAC (Hash for Message Authentication Code) mechanism utilizing the RSA encryption algorithm. The default is enabled.
<b>HMAC-DSA</b>	Use the check box to enable or disable the HMAC (Hash for Message Authentication Code) mechanism utilizing the Digital Signature Algorithm (DSA) encryption. The default is enabled.

Click **Apply** to implement changes made.

## SSH User Authentication List

Users can configure parameters for users attempting to access the Switch through SSH. In the window above, the User Account “username” has been previously set using the **User Accounts** window in the **Configuration** folder. A User Account **MUST** be set in order to set the parameters for the SSH user.

To view the following window, click **Security > SSH > SSH User Authentication List**:



**Figure 6 - 43. SSH User Authentication List window**

The user may view or set the following parameters:

Parameter	Description
<b>User Name</b>	A name of no more than 15 characters to identify the SSH user. This User Name must be a previously configured user account on the Switch.
<b>Authentication Method</b>	<p>The administrator may choose one of the following to set the authorization for users attempting to access the Switch.</p> <p><i>Host Based</i> – This parameter should be chosen if the administrator wishes to use a remote SSH server for authentication purposes. Choosing this parameter requires the user to input the following information to identify the SSH user.</p> <ul style="list-style-type: none"> <li>• <i>Host Name</i> – Enter an alphanumeric string of no more than 32 characters to identify the remote SSH user.</li> <li>• <i>Host IP</i> – Enter the corresponding IP address of the SSH user.</li> </ul> <p><i>Password</i> – This parameter should be chosen if the administrator wishes to use an administrator-defined password for authentication. Upon entry of this parameter, the Switch will prompt the administrator for a password, and then to re-type the password for confirmation.</p>



	<i>Public Key</i> – This parameter should be chosen if the administrator wishes to use the public key on an SSH server for authentication.
<b>Host Name</b>	Enter an alphanumeric string of no more than 32 characters to identify the remote SSH user. This parameter is only used in conjunction with the <i>Host Based</i> choice in the Auth. Mode field.
<b>Host IP</b>	Enter the corresponding IP address of the SSH user. This parameter is only used in conjunction with the <i>Host Based</i> choice in the Auth. Mode field.

Click **Apply** to implement changes made.



**NOTE:** To set the SSH User Authentication Mode parameters on the Switch, a User Account must be previously configured.

## Access Authentication Control

The TACACS / XTACACS / TACACS+ / RADIUS commands allow users to secure access to the Switch using the TACACS / XTACACS / TACACS+ / RADIUS protocols. When a user logs in to the Switch or tries to access the administrator level privilege, he or she is prompted for a password. If TACACS / XTACACS / TACACS+ / RADIUS authentication is enabled on the Switch, it will contact a TACACS / XTACACS / TACACS+ / RADIUS server to verify the user. If the user is verified, he or she is granted access to the Switch.

There are currently three versions of the TACACS security protocol, each a separate entity. The Switch's software supports the following versions of TACACS:

- **TACACS** (Terminal Access Controller Access Control System) - Provides password checking and authentication, and notification of user actions for security purposes utilizing via one or more centralized TACACS servers, utilizing the UDP protocol for packet transmission.
- **Extended TACACS (XTACACS)** - An extension of the TACACS protocol with the ability to provide more types of authentication requests and more types of response codes than TACACS. This protocol also uses UDP to transmit packets.
- **TACACS+ (Terminal Access Controller Access Control System plus)** - Provides detailed access control for authentication for network devices. TACACS+ is facilitated through Authentication commands via one or more centralized servers. The TACACS+ protocol encrypts all traffic between the Switch and the TACACS+ daemon, using the TCP protocol to ensure reliable delivery

In order for the TACACS / XTACACS / TACACS+ / RADIUS security function to work properly, a TACACS / XTACACS / TACACS+ / RADIUS server must be configured on a device other than the Switch, called an Authentication Server Host and it must include usernames and passwords for authentication. When the user is prompted by the Switch to enter usernames and passwords for authentication, the Switch contacts the TACACS / XTACACS / TACACS+ / RADIUS server to verify, and the server will respond with one of three messages:

The server verifies the username and password, and the user is granted normal user privileges on the Switch.

The server will not accept the username and password and the user is denied access to the Switch.

The server doesn't respond to the verification query. At this point, the Switch receives the timeout from the server and then moves to the next method of verification configured in the method list.

The Switch has four built-in Authentication Server Groups, one for each of the TACACS, XTACACS, TACACS+ and RADIUS protocols. These built-in Authentication Server Groups are used to authenticate users trying to access the Switch. The users will set Authentication Server Hosts in a preferable order in the built-in Authentication Server Groups and when a user tries to gain access to the Switch, the Switch will ask the first Authentication Server Hosts for authentication. If no authentication is made, the second server host in the list will be queried, and so on. The built-in Authentication Server Groups can only have hosts that are running the specified protocol. For example, the TACACS Authentication Server Groups can only have TACACS Authentication Server Hosts.

The administrator for the Switch may set up six different authentication techniques per user-defined method list (TACACS / XTACACS / TACACS+ / RADIUS / local / none) for authentication. These techniques will be listed in an order preferable, and defined by the user for normal user authentication on the Switch, and may contain up to eight authentication techniques. When a user attempts to access the Switch, the Switch will select the first technique listed for authentication. If the first technique goes

through its Authentication Server Hosts and no authentication is returned, the Switch will then go to the next technique listed in the server group for authentication, until the authentication has been verified or denied, or the list is exhausted.

Please note that users granted access to the Switch will be granted normal user privileges on the Switch. To gain access to administrator level privileges, the user must access the **Enable Admin** window and then enter a password, which was previously configured by the administrator of the Switch.



**NOTE:** TACACS, XTACACS and TACACS+ are separate entities and are not compatible. The Switch and the server must be configured exactly the same, using the same protocol. (For example, if the Switch is set up for TACACS authentication, so must be the host server.)

## Enable Admin

Users who have logged on to the Switch on the normal user level and wish to be promoted to the administrator level can use this window. After logging on to the Switch, users will have only user level privileges. To gain access to administrator level privileges, the user will open this window and will have to enter an authentication password. Possible authentication methods for this function include TACACS/XTACACS/TACACS+/RADIUS, user defined server groups, local enable (local account on the Switch), or no authentication (none). Because XTACACS and TACACS do not support the enable function, the user must create a special account on the server host, which has the username "enable", and a password configured by the administrator that will support the "enable" function. This function becomes inoperable when the authentication policy is disabled.

To view the following window, click **Security > Access Authentication Control > Enable Admin**:



Figure 6 - 44. Enable Admin window

When this window appears, click the **Enable Admin** button revealing a window for the user to enter authentication (password, username), as seen below. A successful entry will promote the user to Administrator level privileges on the Switch.

## Authentication Policy Settings

Users can enable an administrator-defined authentication policy for users trying to access the Switch. When enabled, the device will check the Login Method List and choose a technique for user authentication upon login.

To view the following window, click **Security > Access Authentication Control > Authentication Policy Settings**:

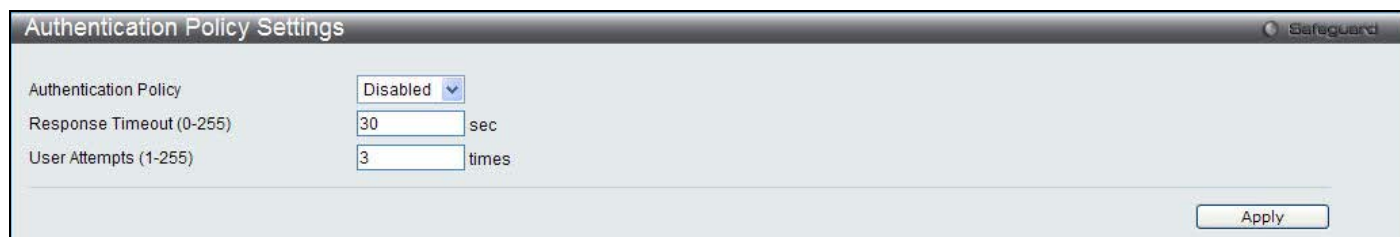

Figure 6 - 45. Authentication Policy Settings window

The following parameters can be set:

Parameter	Description
Authentication Policy	Use the drop-down menu to enable or disable the Authentication Policy on the Switch.

<b>Response Timeout (0-255)</b>	This field will set the time the Switch will wait for a response of authentication from the user. The user may set a time between 0 and 255 seconds. The default setting is 30 seconds.
<b>User Attempts (1-255)</b>	This command will configure the maximum number of times the Switch will accept authentication attempts. Users failing to be authenticated after the set amount of attempts will be denied access to the Switch and will be locked out of further authentication attempts. Command line interface users will have to wait 60 seconds before another authentication attempt. Telnet and web users will be disconnected from the Switch. The user may set the number of attempts from 1 to 255. The default setting is 3.

Click **Apply** to implement changes made.

## Application Authentication Settings

Users can configure Switch configuration applications (console, Telnet, SSH, web) for login at the user level and at the administration level (Enable Admin) utilizing a previously configured method list.

To view the following window, click **Security > Access Authentication Control > Application Authentication Settings**:



**Figure 6 - 46. Application Authentication Settings window**

The following parameters can be set:

Parameter	Description
<b>Application</b>	Lists the configuration applications on the Switch. The user may configure the Login Method List and Enable Method List for authentication for users utilizing the Console (Command Line Interface) application, the Telnet application, SSH, and the Web (HTTP) application.
<b>Login Method List</b>	Using the drop-down menu, configure an application for normal login on the user level, utilizing a previously configured method list. The user may use the default Method List or other Method List configured by the user. See the <b>Login Method Lists</b> window, in this section, for more information.
<b>Enable Method List</b>	Using the drop-down menu, configure an application for normal login on the user level, utilizing a previously configured method list. The user may use the default Method List or other Method List configured by the user. See the <b>Enable Method Lists</b> window, in this section, for more information.

Click **Apply** to implement changes made.

## Authentication Server Group

Users can set up Authentication Server Groups on the Switch. A server group is a technique used to group TACACS/XTACACS/TACACS+/RADIUS server hosts into user-defined categories for authentication using method lists. The user may define the type of server group by protocol or by previously defined server group. The Switch has three built-in Authentication Server Groups that cannot be removed but can be modified. Up to eight authentication server hosts may be added to any particular group.

To view the following window, click **Security > Access Authentication Control > Authentication Server Group**:

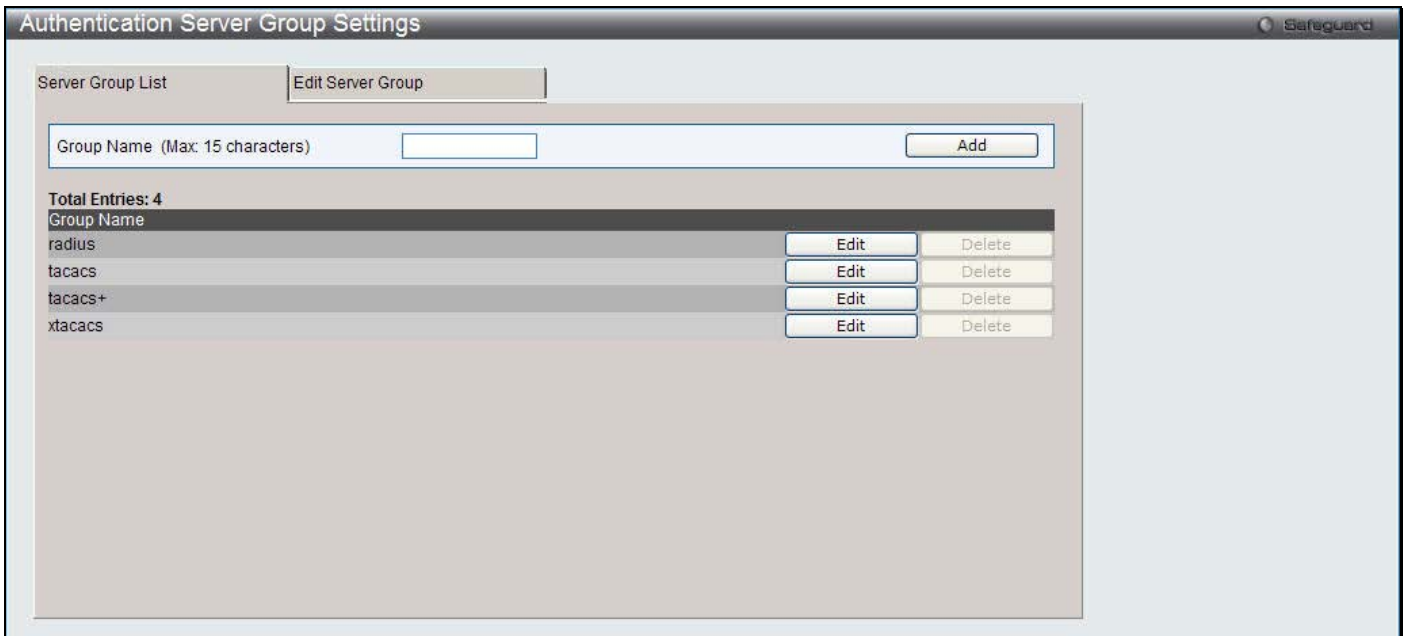

Figure 6 - 47. Authentication Server Group Settings window

This window displays the Authentication Server Groups on the Switch. The Switch has four built-in Authentication Server Groups that cannot be removed but can be modified. To add a new Server Group, enter a name in the Group Name field and then click the **Add** button. To modify a particular group, click the **Edit** button (or the **Edit Server Group** tab), which will then display the following **Edit Server Group** tab:

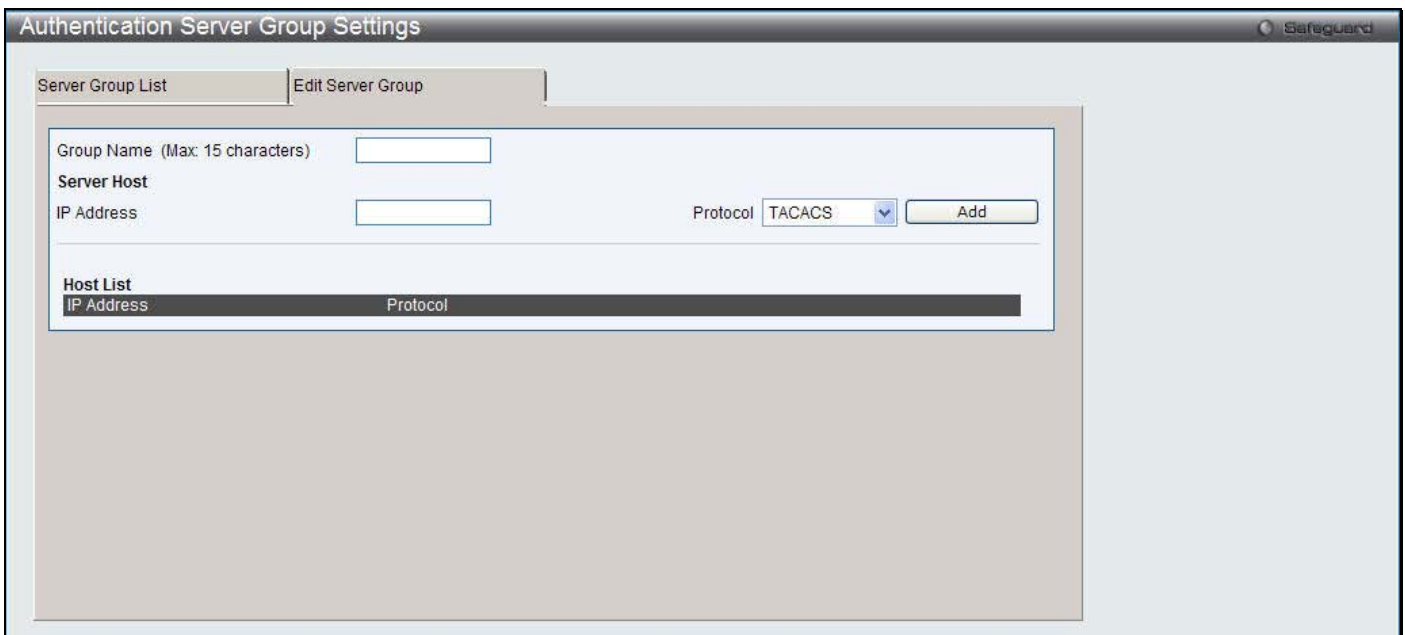

Figure 6 - 48. Edit Server Group tab of the Authentication Server Group window

To add an Authentication Server Host to the list, enter its name in the Group Name field, IP address in the IP Address field, use the drop-down menu to choose the Protocol associated with the IP address of the Authentication Server Host, and then click **Add** to add this Authentication Server Host to the group. The entry should appear in the Host List at the bottom of this tab.

To add a server group other than the ones listed, enter a name of up to 15 characters in the Group Name field, an IP address in the IP Address field, use the drop-down menu to choose the Protocol associated with the IP address, and then click **Apply**. The entry should appear in the **Server Group List** tab.



**NOTE:** The user must configure Authentication Server Hosts using the Authentication Server Hosts window before adding hosts to the list. Authentication Server Hosts must be configured for their specific protocol on a remote centralized server before this function can work properly.



**NOTE:** The three built-in server groups can only have server hosts running the same TACACS daemon. TACACS/XTACACS/TACACS+ protocols are separate entities and are not compatible with each other.

## Authentication Server Settings

User-defined Authentication Server Hosts for the TACACS / XTACACS / TACACS+ / RADIUS security protocols can be set on the Switch. When a user attempts to access the Switch with Authentication Policy enabled, the Switch will send authentication packets to a remote TACACS / XTACACS / TACACS+ / RADIUS server host on a remote host. The TACACS / XTACACS / TACACS+ / RADIUS server host will then verify or deny the request and return the appropriate message to the Switch. More than one authentication protocol can be run on the same physical server host but, remember that TACACS / XTACACS / TACACS+ / RADIUS are separate entities and are not compatible with each other. The maximum supported number of server hosts is 16.

To view the following window, click **Security > Access Authentication Control > Authentication Server Settings**:

**Figure 6 - 49. Authentication Server Settings window**

Configure the following parameters to add an Authentication Server Host:

Parameter	Description
<b>IP Address</b>	The IP address of the remote server host to add.
<b>Protocol</b>	The protocol used by the server host. The user may choose one of the following: <i>TACACS</i> - Enter this parameter if the server host utilizes the TACACS protocol. <i>XTACACS</i> - Enter this parameter if the server host utilizes the XTACACS protocol. <i>TACACS+</i> - Enter this parameter if the server host utilizes the TACACS+ protocol. <i>RADIUS</i> - Enter this parameter if the server host utilizes the RADIUS protocol.
<b>Key</b>	Authentication key to be shared with a configured TACACS+ or RADIUS servers only. Specify an alphanumeric string up to 254 characters.
<b>Port (1-65535)</b>	Enter a number between 1 and 65535 to define the virtual port number of the authentication protocol on a server host. The default port number is 49 for TACACS/XTACACS/TACACS+ servers and 1813 for RADIUS servers but the user may set a unique port number for higher security.
<b>Timeout (1-255)</b>	Enter the time in seconds the Switch will wait for the server host to reply to an authentication request. The default value is 5 seconds.
<b>Retransmit (1-20)</b>	Enter the value in the retransmit field to change how many times the device will resend an authentication request when the TACACS server does not respond.

Click **Apply** to add the server host.



**NOTE:** More than one authentication protocol can be run on the same physical server host but, remember that TACACS/XTACACS/TACACS+ are separate entities and are not compatible with each other.

## Login Method Lists Settings

User-defined or default Login Method List of authentication techniques can be configured for users logging on to the Switch. The sequence of techniques implemented in this command will affect the authentication result. For example, if a user enters a sequence of techniques, for example TACACS - XTACACS- local, the Switch will send an authentication request to the first TACACS host in the server group. If no response comes from the server host, the Switch will send an authentication request to the second TACACS host in the server group and so on, until the list is exhausted. At that point, the Switch will restart the same sequence with the following protocol listed, XTACACS. If no authentication takes place using the XTACACS list, the local account database set in the Switch is used to authenticate the user. When the local method is used, the privilege level will be dependant on the local account privilege configured on the Switch.

Successful login using any of these techniques will give the user a "User" privilege only. If the user wishes to upgrade his or her status to the administrator level, the user must use the **Enable Admin** window, in which the user must enter a previously configured password, set by the administrator.

To view the following window, click **Security > Access Authentication Control > Login Method Lists**:

**Figure 6 - 50. Login Method List Settings window**

The following parameters can be configured:

Parameter	Description
<b>Method List Name</b>	Enter a method list name defined by the user of up to 15 characters.
<b>Priority 1, 2, 3, 4</b>	<p>The user may add one, or a combination of up to four of the following authentication methods to this method list:</p> <p><i>tacacs</i> - Adding this parameter will require the user to be authenticated using the TACACS protocol from a remote TACACS server.</p> <p><i>xtacacs</i> - Adding this parameter will require the user to be authenticated using the XTACACS protocol from a remote XTACACS server.</p> <p><i>tacacs+</i> - Adding this parameter will require the user to be authenticated using the TACACS+ protocol from a remote TACACS+ server.</p> <p><i>radius</i> - Adding this parameter will require the user to be authenticated using the RADIUS protocol from a remote RADIUS server.</p> <p><i>local</i> - Adding this parameter will require the user to be authenticated using the local user account database on the Switch.</p> <p><i>none</i> - Adding this parameter will require no authentication to access the Switch.</p>

Click **Apply** to implement the changes. The Switch contains one Method List that is set and cannot be removed, yet can be modified. To delete a Login Method List defined by the user, click the **Delete** button corresponding to the entry desired to be deleted. To modify a Login Method List, click on its corresponding **Edit** button.

## Enable Method Lists Settings

Users can set up Method Lists to promote users with user level privileges to Administrator (Admin) level privileges using authentication methods on the Switch. Once a user acquires normal user level privileges on the Switch, he or she must be authenticated by a method on the Switch to gain administrator privileges on the Switch, which is defined by the Administrator. A maximum of eight Enable Method Lists can be implemented on the Switch, one of which is a default Enable Method List. This default Enable Method List cannot be deleted but can be configured.

The sequence of methods implemented in this command will affect the authentication result. For example, if a user enters a sequence of methods like TACACS - XTACACS - Local Enable, the Switch will send an authentication request to the first TACACS host in the server group. If no verification is found, the Switch will send an authentication request to the second TACACS host in the server group and so on, until the list is exhausted. At that point, the Switch will restart the same sequence with the following protocol listed, XTACACS. If no authentication takes place using the XTACACS list, the Local Enable password set in the Switch is used to authenticate the user.

Successful authentication using any of these methods will give the user an "Admin" privilege.



**NOTE:** To set the Local Enable Password, see the next section, entitled Local Enable Password.

To view the following window, click **Security > Access Authentication Control > Enable Method Lists Settings**:

**Figure 6 - 51. Enable Method List Settings window**

The following parameters can be configured:

Parameter	Description
<b>Method List Name</b>	Enter a method list name defined by the user of up to 15 characters.
<b>Priority 1, 2, 3, 4</b>	<p>The user may add one, or a combination of up to four of the following authentication methods to this method list:</p> <p><i>local_enable</i> - Adding this parameter will require the user to be authenticated using the local enable password database on the Switch. The local enable password must be set by the user in the next section entitled Local Enable Password.</p> <p><i>none</i> - Adding this parameter will require no authentication to access the Switch.</p> <p><i>radius</i> - Adding this parameter will require the user to be authenticated using the RADIUS protocol from a remote RADIUS server.</p> <p><i>tacacs</i> - Adding this parameter will require the user to be authenticated using the TACACS protocol from a remote TACACS server.</p> <p><i>xtacacs</i> - Adding this parameter will require the user to be authenticated using the XTACACS protocol from a remote XTACACS server.</p> <p><i>tacacs+</i> - Adding this parameter will require the user to be authenticated using the TACACS protocol from a remote TACACS server.</p>

Click **Apply** to implement the changes. To delete an Enable Method List defined by the user, click the **Delete** button corresponding to the entry desired to be deleted. To modify an Enable Method List, click on its corresponding **Edit** button.

## Local Enable Password Settings

Users can configure the locally enabled password for Enable Admin. When a user chooses the "local\_enable" method to promote user level privileges to administrator privileges, he or she will be prompted to enter the password configured here that is locally set on the Switch.

To view the following window, click **Security > Access Authentication Control > Local Enable Password Settings**:

**Figure 6 - 52. Local Enable Password Settings window**

The following parameters can be configured:

Parameter	Description
<b>Encryption</b>	Use the drop-down menu to select the encryption type.
<b>Old Local Enable Password</b>	If a password was previously configured for this entry, enter it here in order to change it to a new password
<b>New Local Enable Password</b>	Enter the new password that you wish to set on the Switch to authenticate users attempting to access Administrator Level privileges on the Switch. The user may set a password of up to 15 characters.
<b>Confirm Local Enable Password</b>	Confirm the new password entered above. Entering a different password here from the one set in the New Local Enabled field will result in a fail message.
<b>Local Enable Password</b>	Specify the password in plain text or SHA-1 encrypted form.

Click **Apply** to implement changes made.

## MAC-based Access Control (MAC)

MAC-based Access Control is a method to authenticate and authorize access using either a port or host. For port-based MAC, the method decides port access rights, while for host-based MAC, the method determines the MAC access rights.

A MAC user must be authenticated before being granted access to a network. Both local authentication and remote RADIUS server authentication methods are supported. In MAC-based Access Control, MAC user information in a local database or a RADIUS server database is searched for authentication. Following the authentication result, users achieve different levels of authorization.

### Notes about MAC-based Access Control

There are certain limitations and regulations regarding MAC-based Access Control:

1. Once this feature is enabled for a port, the Switch will clear the FDB of that port.
2. If a port is granted clearance for a MAC address in a VLAN that is not a Guest VLAN, other MAC addresses on that port must be authenticated for access and otherwise will be blocked by the Switch.
3. A port accepts a maximum of two hundred authenticated MAC addresses per physical port of a VLAN that is not a Guest VLAN. Other MAC addresses attempting authentication on a port with the maximum number of authenticated MAC addresses will be blocked.



- Ports that have been enabled for Link Aggregation, Port Security, or GVRP authentication cannot be enabled for MAC-based Authentication.

## MAC-based Access Control Settings

This window is used to configure the MAC Settings for the MAC-based Access Control function on the Switch. The user can set the running state, method of authentication, RADIUS password, view the Guest VLAN configuration to be associated with the MAC-based Access Control function of the Switch, and configure ports to be enabled or disabled for the MAC-based Access Control feature of the Switch. Please remember, ports enabled for certain other features, listed previously, can not be enabled for MAC-based Access Control.

To view the following window, click **Security > MAC-based Access Control (MAC) > MAC-based Access Control Settings**:

**MAC-based Access Control Global Settings**

MAC-based Access Control State:  Enabled  Disabled Apply

Method: Local Password Type: Manual String  
 Trap State: Enabled Password: default  
 Log State: Enabled Max User (1-4096):   No Limit  
 RADIUS Authorization: Enabled Local Authorization: Enabled Apply

**Guest VLAN Settings**

VLAN Name:  VID (1-4094):   
 Member Ports (e.g.: 1-5, 9):  Add Delete

**Port Settings**

From Port: 01 To Port: 01 State: Disabled Aging Time (1-1440): 1440 min  Infinite Block Time (0-300): 300 sec Max User (1-4096): 200  No Limit Apply

Port	State	Aging Time (min)	Block Time (sec)	Max User
1	Disabled	1440	300	200
2	Disabled	1440	300	200
3	Disabled	1440	300	200
4	Disabled	1440	300	200
5	Disabled	1440	300	200
6	Disabled	1440	300	200
7	Disabled	1440	300	200
8	Disabled	1440	300	200
9	Disabled	1440	300	200
10	Disabled	1440	300	200
11	Disabled	1440	300	200

Figure 6 - 53. MAC-based Access Control Settings window

The MAC Settings window is divided into four main sections. The top section configures the MAC Global State, the second section is used to specify and configure the method used for authentication, the third section is used to configure the Guest VLAN settings, and the fourth section is used to configure the ports that require MAC Settings configuration.

### Configuring the MAC Global State:

Configure the parameter as described below:

Parameter	Description
MAC Global State	Toggle to globally enable or disable the MAC-based Access Control function on the Switch.

Click the **Apply** button in the top section to implement the configuration changes.

### Configuring the MAC Authentication Method:

Configure the parameters as described below:

Parameter	Description
<b>Method</b>	Use this drop-down menu to choose the type of authentication to be used when authentication MAC addresses on a given port. The user may choose between the following methods:  <i>Local</i> – Use this method to utilize the locally set MAC address database as the authenticator for MAC-based Access Control. This MAC address list can be configured in the MAC Local Settings window.  <i>RADIUS</i> – Use this method to utilize a remote RADIUS server as the authenticator for MAC-based Access Control. Remember, the MAC list must be previously set on the RADIUS server and the settings for the server must be first configured on the Switch.
<b>Trap State</b>	Use the drop-down menu to enable or disable sending out the trap for MAC-based Access Control.
<b>Log State</b>	Use the drop-down menu to enable or disable log state.
<b>RADIUS Authorization</b>	Use the drop-down menu to enable or disable the use of RADIUS Authorization.
<b>Password Type</b>	Use the drop-down menu to select the password type. Available options are <i>Manual String</i> and <i>Client MAC Address</i> .
<b>Password</b>	Enter the password for the RADIUS server, which is to be used for packets being sent requesting authentication. The default password is “default”.
<b>Max User (1-4096)</b>	Enter the maximum amount of users of the Switch. Tick the <b>No Limit</b> check box to have unlimited users.
<b>Local Authorization</b>	Use the drop-down menu to enable or disable the use of Local Authorization.

Click the **Apply** button in the second section to implement the configuration changes.

#### Configuring the Guest VLAN Settings:

Parameter	Description
<b>VLAN Name</b>	Enter the name of the previously configured Guest VLAN being used for this function.
<b>VID (1-4904)</b>	Click the button and enter a Guest VLAN ID.
<b>Member Ports (e.g.: 1-5, 9)</b>	Enter the list of ports that have been configured for the Guest VLAN.

Click the **Add** button to create a new entry.

Click the **Delete** button in the third section to delete the Guest VLAN configuration.

#### Configuring MAC Settings Configuration on Ports:

Parameter	Description
<b>From Port / To Port</b>	Use the drop-down menus to select a range of ports.
<b>State</b>	Use this drop-down menu to enable or disable MAC-based Access Control on the port or range of ports selected in the Port Settings section of this window.
<b>Aging Time (1-1440)</b>	Enter a value between 1 and 1440 minutes. The default is 1440. Tick the adjacent <b>Infinite</b> checkbox to disable aging.
<b>Block Time (0-300)</b>	Enter a value between 0 and 300 seconds. The default is 300.
<b>Max User (1-4096)</b>	Enter the maximum amount of users of the Switch. Tick the <b>No Limit</b> check box to have unlimited users. The default is 200.

Click the **Apply** button in the fourth section to implement the configuration changes.

## MAC-based Access Control Local Settings

Users can set a list of MAC addresses, along with their corresponding target VLAN, which will be authenticated for the Switch. Once a queried MAC address is matched in this window, it will be placed in the VLAN associated with it here. The Switch administrator may enter up to 128 MAC addresses to be authenticated using the local method configured here.

To view the following window, click **Security > MAC-based Access Control (MAC) > MAC-based Access Control Local Settings**:

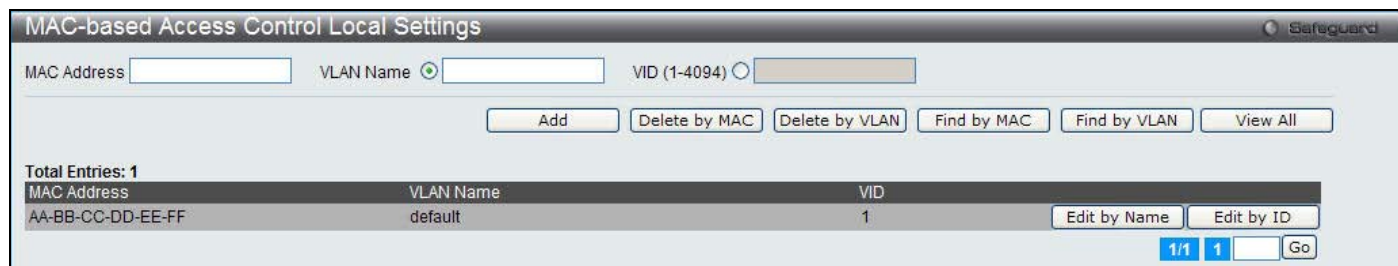

Figure 6 - 54. MAC-based Access Control Local Settings window

The following parameters can be configured:

Parameter	Description
<b>MAC Address</b>	Enter the MAC address that will be added to the local authentication list.
<b>VLAN Name</b>	Enter the VLAN name of the corresponding MAC address.
<b>VID (1-4094)</b>	Enter the VLAN ID of the corresponding MAC address.

Click the **Delete by MAC** button to remove the specific entry based on the MAC address entered. Click the **Delete by VLAN** button to remove the specific entry based on the VLAN name or ID entered. Click the **Find by MAC** button to locate a specific entry based on the MAC address entered. Click the **Find by VLAN** button to locate a specific entry based on the VLAN name or ID entered. Click the **View All** button to display all the existing entries. Click the **Edit by Name** button to change the specific MAC address' VLAN name. Click the **Edit by ID** button to change the specific MAC address' VLAN ID. Enter a page number and click the **Go** button to navigate to a specific page when multiple pages exist.

## MAC-based Access Control Authentication State

Users can use the MAC Authentication State window to display the MAC-based Access Control authentication MAC addresses.

To view the following window, click **Security > MAC-based Access Control (MAC) > MAC-based Access Control Authentication State**:



Figure 6 - 55. MAC-based Access Control Authentication State window

The following parameters can be configured:

Parameter	Description
-----------	-------------

<b>Port List (e.g.: 1, 5-10)</b>	Enter a list of ports.
----------------------------------	------------------------

Click the **Find** button to locate a specific entry based on the information entered. Click the **Clear by Port** button to clear all the information linked to the port number entered. Click the **View All Hosts** button to display all the existing hosts. Click the **Clear All hosts** button to clear out all the existing hosts.

## Web-based Access Control (WAC)

Web-based Authentication Login is a feature designed to authenticate a user when the user is trying to access the Internet via the Switch. The authentication process uses the HTTP protocol. The Switch enters the authenticating stage when users attempt to browse Web pages (e.g., <http://www.dlink.com>) through a Web browser. When the Switch detects HTTP packets and this port is un-authenticated, the Switch will launch a pop-up user name and password window to query users. Users are not able to access the Internet until the authentication process is passed.

The Switch can be the authentication server itself and do the authentication based on a local database, or be a RADIUS client and perform the authentication process via the RADIUS protocol with a remote RADIUS server. The client user initiates the authentication process of WAC by attempting to gain Web access.

D-Link's implementation of WAC uses a virtual IP that is exclusively used by the WAC function and is not known by any other modules of the Switch. In fact, to avoid affecting a Switch's other features, WAC will only use a virtual IP address to communicate with hosts. Thus, all authentication requests must be sent to a virtual IP address but not to the IP address of the Switch's physical interface.

Virtual IP works like this, when a host PC communicates with the WAC Switch through a virtual IP, the virtual IP is transformed into the physical IPIF (IP interface) address of the Switch to make the communication possible. The host PC and other servers' IP configurations do not depend on the virtual IP of WAC. The virtual IP does not respond to any ICMP packets or ARP requests, which means it is not allowed to configure a virtual IP on the same subnet as the Switch's IPIF (IP interface) or the same subnet as the host PCs' subnet.

As all packets to a virtual IP from authenticated and authenticating hosts will be trapped to the Switch's CPU, if the virtual IP is the same as other servers or PCs, the hosts on the WAC-enabled ports cannot communicate with the server or PC which really own the IP address. If the hosts need to access the server or PC, the virtual IP cannot be the same as the one of the server or PC. If a host PC uses a proxy to access the Web, to make the authentication work properly the user of the PC should add the virtual IP to the exception of the proxy configuration. Whether or not a virtual IP is specified, users can access the WAC pages through the Switch's system IP. When a virtual IP is not specified, the authenticating Web request will be redirected to the Switch's system IP.

The Switch's implementation of WAC features a user-defined port number that allows the configuration of the TCP port for either the HTTP or HTTPS protocols. This TCP port for HTTP or HTTPS is used to identify the HTTP or HTTPS packets that will be trapped to the CPU for authentication processing, or to access the login page. If not specified, the default port number for HTTP is 80 and the default port number for HTTPS is 443. If no protocol is specified, the default protocol is HTTP.

The following diagram illustrates the basic six steps all parties go through in a successful Web Authentication process:

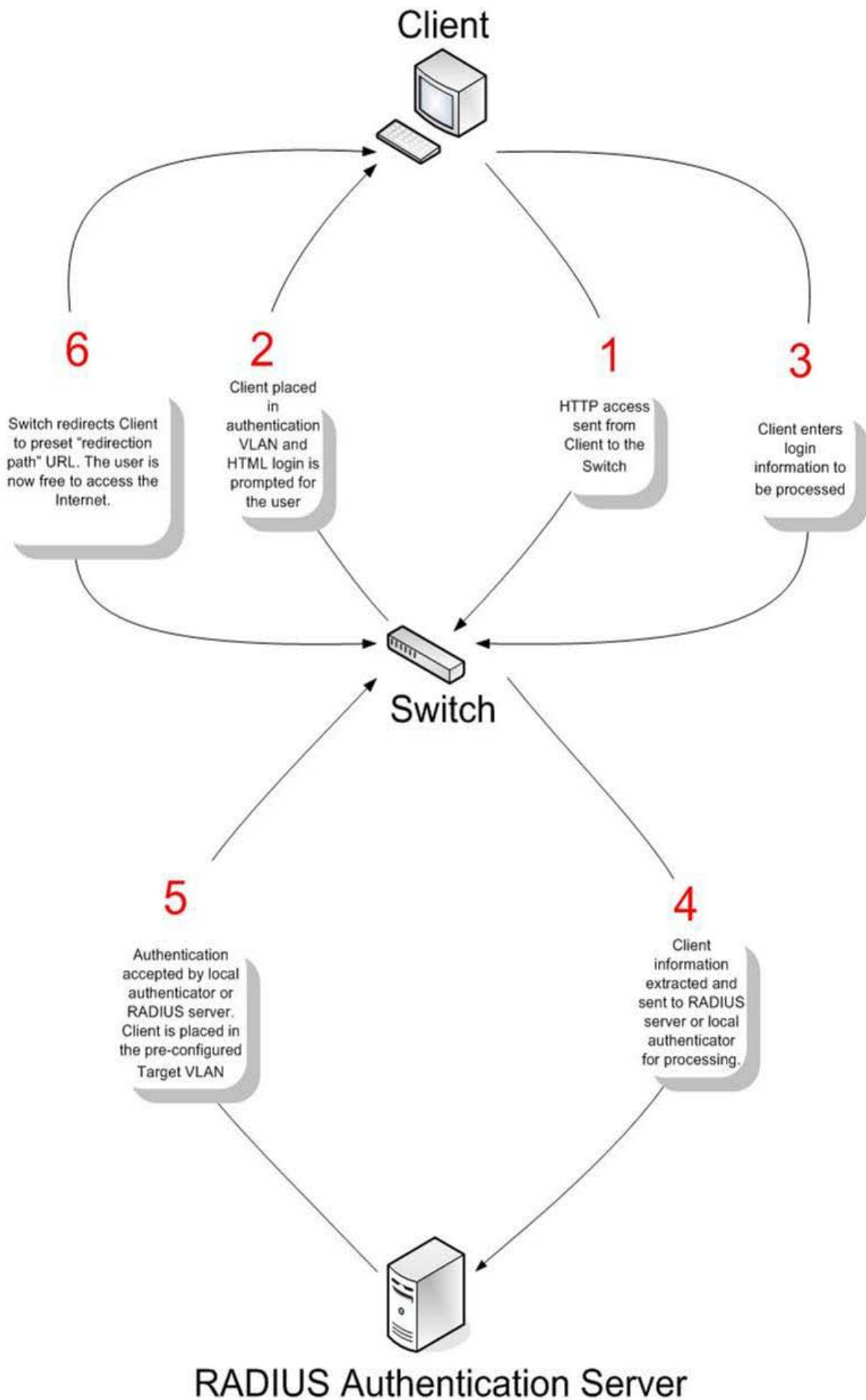

### RADIUS Authentication Server

Figure 6 - 56. Six Basic Steps in a Successful Web Authentication Process

## Conditions and Limitations

1. If the client is utilizing DHCP to attain an IP address, the authentication VLAN must provide a DHCP server or a DHCP relay function so that client may obtain an IP address.
2. Certain functions exist on the Switch that will filter HTTP packets, such as the Access Profile function. The user needs to be very careful when setting filter functions for the target VLAN, so that these HTTP packets are not denied by the Switch.
3. If a RADIUS server is to be used for authentication, the user must first establish a RADIUS Server with the appropriate parameters, including the target VLAN, before enabling Web Authentication on the Switch.

## WAC Global Settings

Users can configure the Switch for Web authentication.

To view the following window, click **Security > Web-based Access Control (WAC) > WAC Global Settings**:

Figure 6 - 57. WAC Global Settings window

To set the Web Authentication for the Switch, complete the following fields:

Parameter	Description
<b>WAC Global State</b>	Use this selection menu to either enable or disable the Web Authentication on the Switch.
<b>Virtual IP</b>	Enter a virtual IP address. This address is only used by WAC and is not known by any other modules of the Switch.
<b>Redirection Path</b>	Enter the URL of the website that authenticated users placed in the VLAN are directed to once authenticated.
<b>RADIUS Authorization</b>	The user can enable or disable this option to enable RADIUS Authorization or not.
<b>HTTP(s) Port (1-65535)</b>	Enter a HTTP port number. Port 80 is the default. <i>HTTP</i> – Specifies that the TCP port will run the WAC HTTP protocol. The default value is 80. HTTP port cannot run at TCP port 443. <i>HTTPS</i> – Specifies that the TCP port will run the WAC HTTPS protocol. The default value is 443. HTTPS cannot run at TCP port 80.
<b>Method</b>	Use this drop-down menu to choose the authenticator for Web-based Access Control. The user may choose:  <i>Local</i> – Choose this parameter to use the local authentication method of the Switch as the authenticating method for users trying to access the network via the switch. This is, in fact, the username and password to access the Switch configured using the <b>WAC User Settings</b> window ( <b>Security &gt; Web-based Access Control (WAC) &gt; WAC User Settings</b> ) seen below.  <i>RADIUS</i> – Choose this parameter to use a remote RADIUS server as the authenticating method for users trying to access the network via the switch. This RADIUS server must have already been pre-assigned by the administrator using the <b>Authentic RADIUS Server</b>

	window ( <b>Security &gt; 802.1X &gt; Authentic RADIUS Server</b> ).
<b>Clear Redirection Path</b>	The user can enable or disable this option to clear the redirection path.
<b>Local Authorizations</b>	he user can enable or disable this option to enable Local Authorization or not.

Click **Apply** to implement changes made.



**NOTE:** To enable the Web Authentication function, the redirection path field must have the URL of the website that users will be directed to once they enter the limited resource, pre-configured VLAN. Users that attempt to apply settings without the Redirection Page field set will be prompted with an error message and Web Authentication will not be enabled. The URL should follow the form http(s)://www.dlink.com



**NOTE:** The subnet of the IP address of the authentication VLAN must be the same as that of the client, or the client will always be denied authentication.



**NOTE:** A successful authentication should direct the client to the stated web page. If the client does not reach this web page, yet does not receive a **Fail!** Message, the client will already be authenticated and therefore should refresh the current browser window or attempt to open a different web page.

## WAC User Settings

Users can view and set user accounts for Web authentication.

To view the following window, click **Security > Web-based Access Control (WAC) > WAC User Settings**:

**Figure 6 - 58. WAC User Settings window**

To set the User Account settings for the Web authentication by the Switch, complete the following fields:

Parameter	Description
<b>User Name</b>	Enter the user name of up to 15 alphanumeric characters of the guest wishing to access the Web through this process. This field is for administrators who have selected <i>Local</i> as their Web-based authenticator.
<b>VLAN Name</b>	Click the button and enter a VLAN Name in this field.

<b>VID (1-4094)</b>	Click the button and enter a VID in this field.
<b>Password</b>	Enter the password the administrator has chosen for the selected user. This field is case-sensitive and must be a complete alphanumeric string. This field is for administrators who have selected <i>Local</i> as their Web-based authenticator.
<b>Old Password</b>	Enter the original password.
<b>New Password</b>	Enter the new password
<b>Confirm Password</b>	Retype the password entered in the previous field.

Click the **Apply** button to accept the changes made. Click the **Delete All** button to remove all the entries listed. Click the **Edit VLAN Name** button to re-configure the specific entry's VLAN Name. Click the **Edit VID** button to re-configure the specific entry's VLAN ID. Click the **Clear VLAN** button to remove the VLAN information from the specific entry. Click the **Delete** button to remove the specific entry.

## WAC Port Settings

Users can view and set port configurations for Web authentication.

To view the following window, click **Security > Web-based Access Control (WAC) > WAC Port Settings**:

The screenshot shows the 'WAC Port Settings' window with the following configuration fields:

- From Port:** 01
- To Port:** 01
- Aging Time (1-1440):** 1440 min,  Infinite
- Idle Time (1-1440):** [empty] min,  Infinite
- State:** Disabled
- Block Time (0-300):** 60 sec

An **Apply** button is located at the bottom right of the configuration area.

Port	State	Aging Time	Idle Time	Block Time
1	Disabled	1440	Infinite	60
2	Disabled	1440	Infinite	60
3	Disabled	1440	Infinite	60
4	Disabled	1440	Infinite	60
5	Disabled	1440	Infinite	60
6	Disabled	1440	Infinite	60
7	Disabled	1440	Infinite	60
8	Disabled	1440	Infinite	60
9	Disabled	1440	Infinite	60
10	Disabled	1440	Infinite	60
11	Disabled	1440	Infinite	60
12	Disabled	1440	Infinite	60
13	Disabled	1440	Infinite	60
14	Disabled	1440	Infinite	60
15	Disabled	1440	Infinite	60
16	Disabled	1440	Infinite	60
17	Disabled	1440	Infinite	60
18	Disabled	1440	Infinite	60
19	Disabled	1440	Infinite	60
20	Disabled	1440	Infinite	60
21	Disabled	1440	Infinite	60
22	Disabled	1440	Infinite	60
23	Disabled	1440	Infinite	60
24	Disabled	1440	Infinite	60

Figure 6 - 59. WAC Port Settings window

To set the WAC on individual ports for the Switch, complete the following fields:

Parameter	Description
<b>From Port / To Port</b>	Use this drop-down menus to select a range of ports to be enabled as WAC ports.
<b>Aging Time (1-1440)</b>	This parameter specifies the time period during which an authenticated host will remain in the



	authenticated state. Enter a value between 0 and 1440 minutes. A value of 0 indicates the authenticated host will never age out on the port. The default value is 1440 minutes (24 hours). Tick the adjacent <b>Infinite</b> textbox to disable aging. The default value is <i>infinite</i> .
<b>State</b>	Use this drop-down menu to enable the configured ports as WAC ports.
<b>Idle Time (1-1440)</b>	If there is no traffic during the Idle Time parameter, the host will be moved back to the unauthenticated state. Enter a value between 0 and 1440 minutes. A value of 0 indicates the Idle state of the authenticated host on the port will never be checked. Tick the adjacent <b>Infinite</b> textbox to disable the idle time. The default value is <i>infinite</i> .
<b>Block Time (0-300)</b>	This parameter is the period of time a host will be blocked if it fails to pass authentication. Enter a value between 0 and 300 seconds. The default value is 30 seconds.

Click **Apply** to implement changes made.

## WAC Authenticating State

Users can display the current WAC authentication state and delete WAC authentication state settings.

To view the following window, click **Security > Web-based Access Control (WAC) > WAC Authenticating State**:

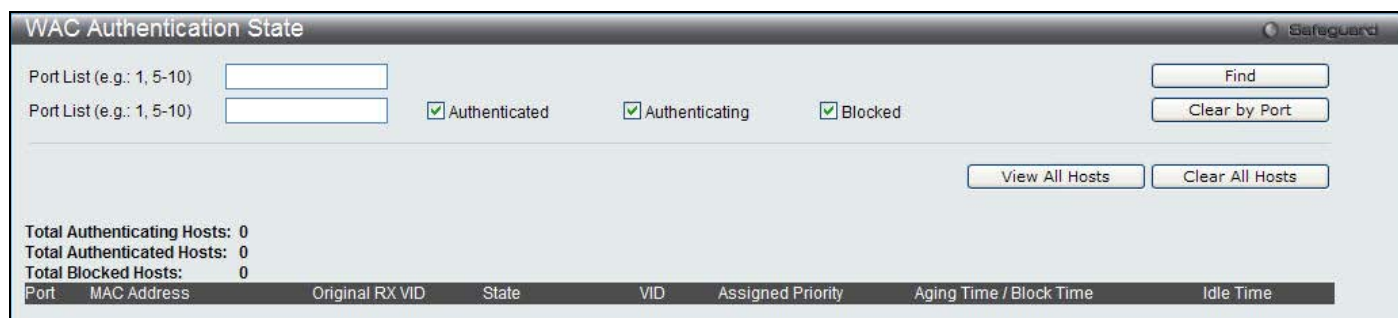

Figure 6 - 60. WAC Authentication State window

The following fields and settings can be viewed:

Parameter	Description
<b>Port List (e.g.: 1, 5-10)</b>	Enter a port or range of ports, and tick the appropriate check box(s), Authenticated, Authenticating, and Blocked.
<b>Authenticated</b>	Tick this check box to display all authenticated users for a port.
<b>Authenticating</b>	Tick this check box to display all authenticating users for a port.
<b>Blocked</b>	Tick this check box to display all blocked users for a port.

Click the **Find** button to locate a specific entry based on the information entered. Click the **Clear by Port** button to remove entry based on the port list entered. Click the **View All Hosts** button to display all the existing entries. Click the **Clear All Hosts** button to remove all the entries listed.

## WAC Customize Page

This window is used to customize the authenticate page elements.

To view the following window, click **Security > Web-based Access Control (WAC) > WAC Customize Page**:

**Note:** Name should be less than 128 characters.

**Current Status:** Un-Authenticated

Authentication Login

User Name

Password

Logout From The Network

**Notification**

Figure 6 - 61. WAC Customize Page window

Complete the WAC authentication information on this window to set the WAC page settings. Click the **Apply** button to implement the changes made. Click the **Set to default** button to go back to the default settings of all elements. Click the **Edit** button to re-configure the elements.

## Japanese Web-based Access Control (JWAC)

### JWAC Global Settings

Users can enable and configure Japanese Web-based Access Control on the Switch. Please note that JWAC and Web Authentication are mutually exclusive functions. That is, they cannot be enabled at the same time. To use the JWAC feature, computer users need to pass through two stages of authentication. The first stage is to do the authentication with the quarantine server and the second stage is the authentication with the Switch. For the second stage, the authentication is similar to Web Authentication, except that there is no port VLAN membership change by JWAC after a host passes authentication. The RADIUS server will share the server configuration defined by the 802.1X command set.

To view the following window, click **Security > Japanese Web-based Access Control (JWAC) > JWAC Global Settings:**

Figure 6 - 62. JWAC Global Settings window

To set the Web authentication for the Switch, complete the following fields:

Parameter	Description
<b>JWAC State</b>	Use this drop-down menu to either enable or disable JWAC on the Switch.
<b>Virtual IP</b>	Enter the JWAC Virtual IP address that is used to accept authentication requests from an unauthenticated host. The Virtual IP address of JWAC is used to accept authentication requests from an unauthenticated host. Only requests sent to this IP will get a correct response. <b>NOTE:</b> This IP does not respond to ARP requests or ICMP packets.
<b>Virtual URL</b>	Enter the Virtual URL used.
<b>UDP Filtering</b>	This parameter enables or disables JWAC UDP Filtering. When UDP Filtering is <i>Enabled</i> , all UDP and ICMP packets except DHCP and DNS packets from unauthenticated hosts will be dropped.
<b>Port Number (1-65535)</b>	Enter the TCP port that the JWAC Switch listens to and uses to finish the authenticating process.
<b>Forcible Logout</b>	This parameter enables or disables JWAC Forcible Logout. When Forcible Logout is <i>Enabled</i> , a Ping packet from an authenticated host to the JWAC Switch with TTL=1 will be regarded as a logout request, and the host will move back to the unauthenticated state.
<b>Authentication Protocol</b>	This parameter specifies the RADIUS protocol used by JWAC to complete a RADIUS authentication. The options include <i>Local</i> , <i>EAP MD5</i> , <i>PAP</i> , <i>CHAP</i> , <i>MS CHAP</i> , and <i>MS CHAPv2</i> .
<b>Redirect State</b>	This parameter enables or disables JWAC Redirect. When the redirect quarantine server is enabled, the unauthenticated host will be redirected to the quarantine server when it tries to access a random URL. When the redirect JWAC login page is enabled, the unauthenticated host will be redirected to the JWAV login page in the Switch to finish authentication. When redirect is disabled, only access to the quarantine server and the JWAC login page from the unauthenticated host are allowed, all other web access will be denied. <b>NOTE:</b> When enabling redirect to the quarantine server, a quarantine server must be configured first.
<b>Redirect Destination</b>	This parameter specifies the destination before an unauthenticated host is redirected to either the <i>Quarantine Server</i> or the <i>JWAC Login Page</i> .
<b>Redirect Delay Time</b>	This parameter specifies the Delay Time before an unauthenticated host is redirected to the

<b>(0-10)</b>	Quarantine Server or JWAC Login Page. Enter a value between 0 and 10 seconds. A value of 0 indicates no delay in the redirect.
<b>RADIUS Authorization</b>	Use the drop-down menu to enable or disable RADIUS Authorization.
<b>Local Authorization</b>	Use the drop-down menu to enable or disable Local Authorization.
<b>Error Timeout (5-300)</b>	This parameter is used to set the Quarantine Server Error Timeout. When the Quarantine Server Monitor is enabled, the JWAC Switch will periodically check if the Quarantine works okay. If the Switch does not receive any response from the Quarantine Server during the configured Error Timeout, the Switch then regards it as not working properly. Enter a value between 5 and 300 seconds.
<b>Monitor</b>	This parameter enables or disables the JWAC Quarantine Server Monitor. When <i>Enabled</i> , the JWAC Switch will monitor the Quarantine Server to ensure the server is okay. If the Switch detects no Quarantine Server, it will redirect all unauthenticated HTTP access attempts to the JWAC Login Page forcibly if the Redirect is enabled and the Redirect Destination is configured to be a Quarantine Server.
<b>URL</b>	This parameter specifies the JWAC Quarantine Server URL. If the Redirect is enabled and the Redirect Destination is the Quarantine Server, when an unauthenticated host sends the HTTP request packets to a random Web server, the Switch will handle this HTTP packet and send back a message to the host to allow it access to the Quarantine Server with the configured URL. When a computer is connected to the specified URL, the quarantine server will request the computer user to input the user name and password to complete the authentication process.
<b>Update Server IP</b>	This parameter specifies the Update Server IP address.
<b>Mask</b>	This parameter specifies the Server IP net mask.
<b>Port</b>	Enter the port number used by the Update Server.

Click **Apply** to implement changes made.

## JWAC Port Settings

Users can configure JWAC port settings for the Switch.

To view the following window, click **Security > Japanese Web-based Access Control (JWAC) > JWAC Port Settings**:

The screenshot shows the JWAC Port Settings window with the following configuration:

- From Port: 01
- To Port: 01
- State: Disabled
- Max Authenticating Host (0-10): 10
- Aging Time (1-1440): 1440 min,  Infinite
- Block Time (0-300): 60 sec
- Idle Time (1-1440):  min,  Infinite

Port	State	Aging Time	Idle Time	Block Time	Max Host
1	Disabled	1440	Infinite	60	10
2	Disabled	1440	Infinite	60	10
3	Disabled	1440	Infinite	60	10
4	Disabled	1440	Infinite	60	10
5	Disabled	1440	Infinite	60	10
6	Disabled	1440	Infinite	60	10
7	Disabled	1440	Infinite	60	10
8	Disabled	1440	Infinite	60	10
9	Disabled	1440	Infinite	60	10
10	Disabled	1440	Infinite	60	10
11	Disabled	1440	Infinite	60	10
12	Disabled	1440	Infinite	60	10
13	Disabled	1440	Infinite	60	10
14	Disabled	1440	Infinite	60	10
15	Disabled	1440	Infinite	60	10
16	Disabled	1440	Infinite	60	10
17	Disabled	1440	Infinite	60	10
18	Disabled	1440	Infinite	60	10
19	Disabled	1440	Infinite	60	10
20	Disabled	1440	Infinite	60	10
21	Disabled	1440	Infinite	60	10
22	Disabled	1440	Infinite	60	10
23	Disabled	1440	Infinite	60	10
24	Disabled	1440	Infinite	60	10

Figure 6 - 63. JWAC Port Settings window

The following parameters can be configured:

Parameter	Description
<b>From Port / To Port</b>	Use this drop-down menu to select a range of ports to be enabled as JWAC ports.
<b>State</b>	Use this drop-down menu to enable the configured ports as JWAC ports.
<b>Max Authenticating Host (1-10)</b>	This parameter specifies the maximum number of host process authentication attempts allowed on each port at the same time. The default value is 10. Enter a value between 1 and 10 attempts.
<b>Aging Time (1-1440)</b>	This parameter specifies the time period during which an authenticated host will remain in the authenticated state. Enter a value between 0 and 1440 minutes or tick the <b>Infinite</b> check box. The default value is 1440. A value of 0 indicates the authenticated host will never age out on the port.
<b>Block Time (0-300)</b>	This parameter is the period of time a host will be blocked if it fails to pass authentication. Enter a value between 0 and 300 seconds. The default value is 0.
<b>Idle Time (1-1440)</b>	If there is no traffic during the Idle Time parameter, the host will be moved back to the unauthenticated state. The default value is infinite. To change this value, first untick the <b>Infinite</b> check box and then enter a value between 0 and 1440 minutes. A value of 0 indicates the Idle state of the authenticated host on the port will never be checked.

Click **Apply** to implement changes made.

## JWAC User Settings

Users can configure JWAC user settings for the Switch.

To view the following window, click **Security > Japanese Web-based Access Control (JWAC) > JWAC User Settings**:

Figure 6 - 64. JWAC User Settings window

To set the User Account settings for the JWAC by the Switch, complete the following fields and then click the **Add** button. To clear the current JWAC user settings in the table at the bottom of the window, click the **Delete All** button.

Parameter	Description
<b>User Name</b>	Enter a username of up to 15 alphanumeric characters.
<b>Password</b>	Enter the password the administrator has chosen for the selected user. This field is case-sensitive and must be a complete alphanumeric string.
<b>Confirm Password</b>	Retype the password entered in the previous field.
<b>VID (1-4094)</b>	Enter a VLAN ID number between 1 and 4094.

Click the **Add** button to add a new entry based on the information entered. Click the **Delete All** button to remove all the entries listed. Click the **Edit** button to re-configure the specific entry. Click the **Delete** button to remove the specific entry.

## JWAC Authentication State

Users can display Japanese Web-based Access Control Host Table information.

To view the following window, click **Security > Japanese Web-based Access Control (JWAC) > JWAC Authentication State**:

Figure 6 - 65. JWAC Authentication State window

The following fields and settings can be viewed:

Parameter	Description
<b>Port List</b>	Enter a port or range of ports.
<b>Authenticated</b>	Tick this check box to only show authenticated client hosts.
<b>Authenticating</b>	Tick this check box to only show client hosts in the authenticating process.
<b>Blocked</b>	Tick this check box to only show client hosts being temporarily blocked because of the failure of authentication.

Click the **Find** button to locate a specific entry based on the information entered. Click the **Clear** button to remove entry based on the port list entered. Click the **View All Hosts** button to display all the existing entries. Click the **Clear All Hosts** button to remove all the entries listed.

## JWAC Customize Page Language

Users can configure JWAC page and language settings for the Switch. The current firmware supports either English or Japanese.

To view the following window, click **Security > Japanese Web-based Access Control (JWAC) > JWAC Customize Page Language**:

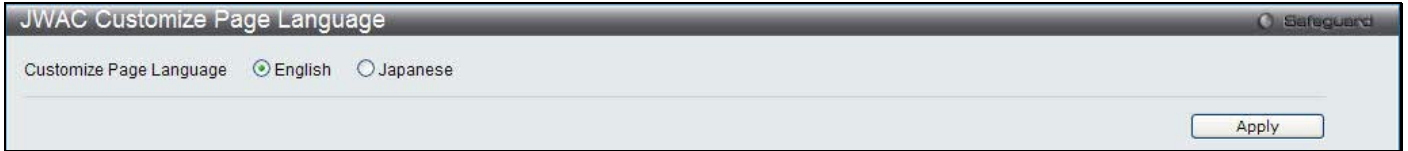

Figure 6 - 66. JWAC Customize Page Language window

To set the language used on the JWAC page, click the radio button for either English or Japanese. Click the **Apply** button.

## JWAC Customize Page

Users can configure JWAC page settings for the Switch.

To view the following window, click **Security > Japanese Web-based Access Control (JWAC) > JWAC Customize Page**:

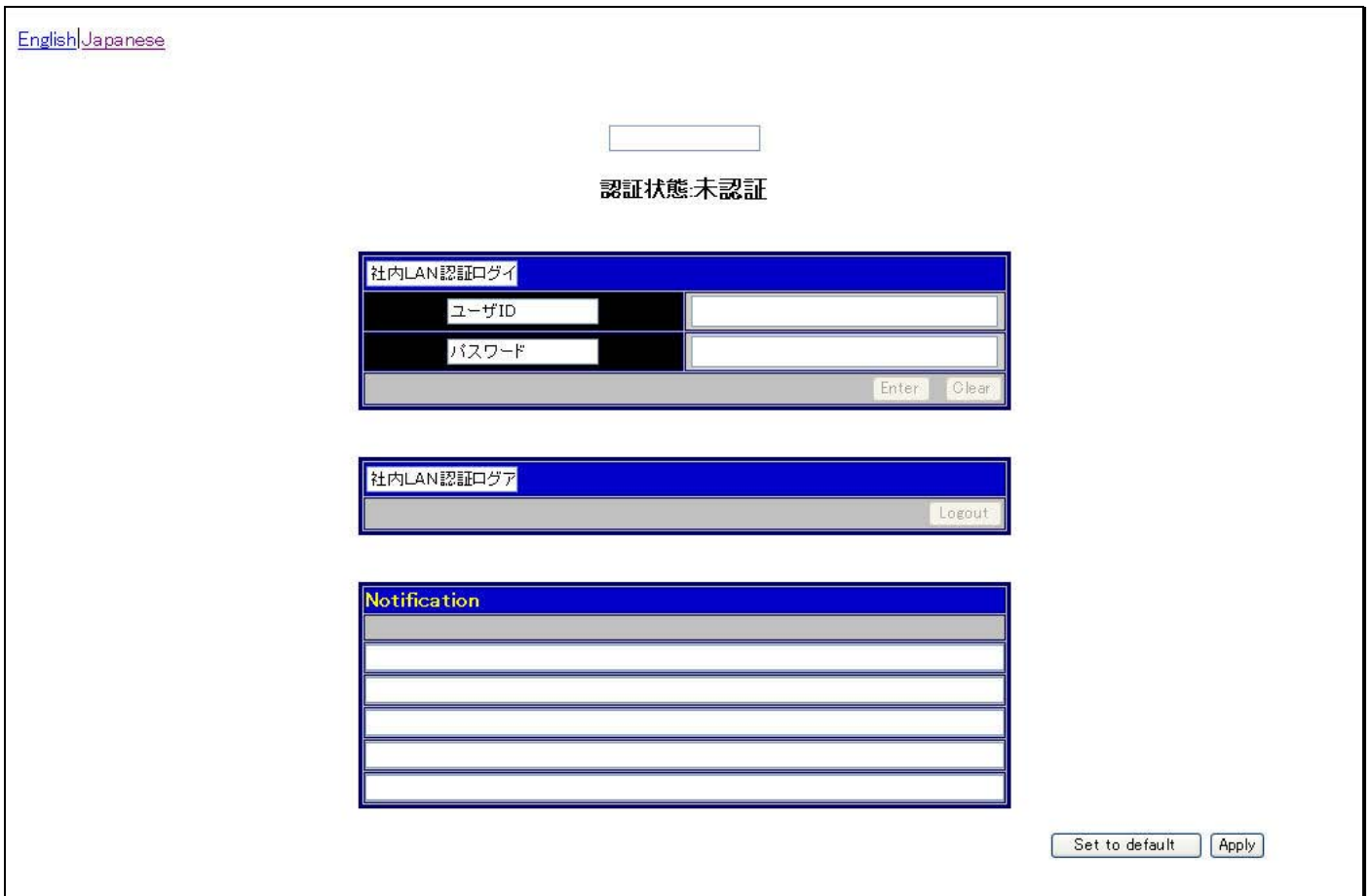

Figure 6 - 67. JWAC Customize Page window

Complete the JWAC authentication information on this window to set the JWAC page settings. Enter a name for the Authentication in the first field and then click the **Apply** button. Next, enter a User Name and a Password and then click the **Enter** button.

## Compound Authentication

Modern networks employ many authentication methods. The Compound Authentication methods supported by this Switch include 802.1X, MAC-based Access Control (MAC), Web-based Access Control (WAC), Japan Web-based Access Control (JWAC), and IP-MAC-Port Binding (IMPB). The Compound Authentication feature allows clients running different authentication methods to connect to the network using the same switch port.

The Compound Authentication feature can be implemented using one of the following modes:

### Any (MAC, 802.1X or WAC) Mode

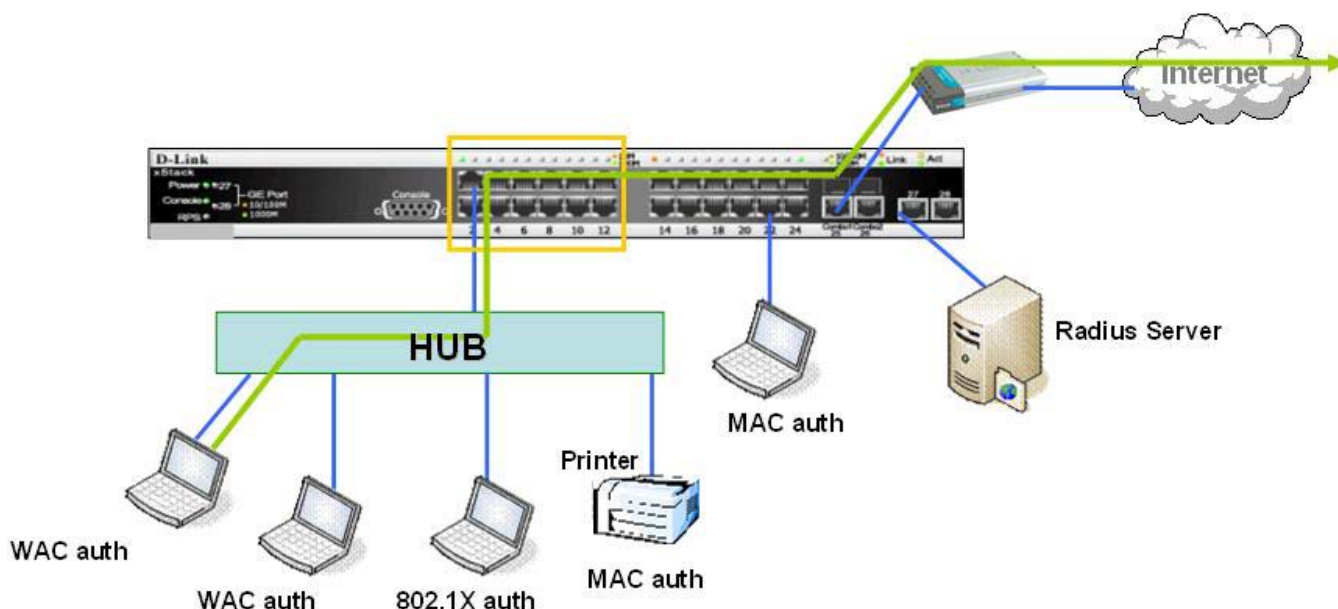

Figure 6 - 68. Any (MAC, 802.1X or WAC) Mode

In the diagram above the Switch port has been configured to allow clients to authenticate using 802.1X, MAC, or WAC. When a client tries to connect to the network, the Switch will try to authenticate the client using one of these methods and if the client passes they will be granted access to the network.



## Any (MAC, 802.1X or JWAC) Mode

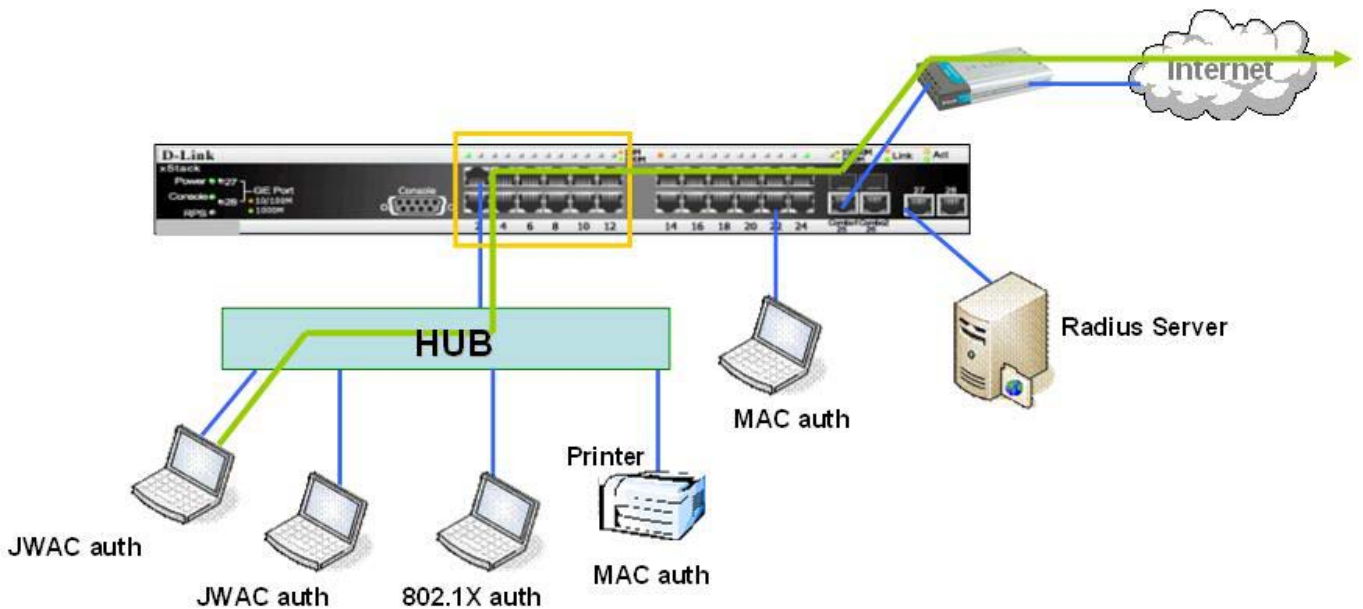

Figure 6 - 69. Any (MAC, 802.1X or JWAC) Mode

In the diagram above the Switch port has been configured to allow clients to authenticate using 802.1X, MAC, or JWAC. When a client tries to connect to the network, the Switch will try to authenticate the client using one of these methods and if the client passes they will be granted access to the network.

## 802.1X & IMPB Mode

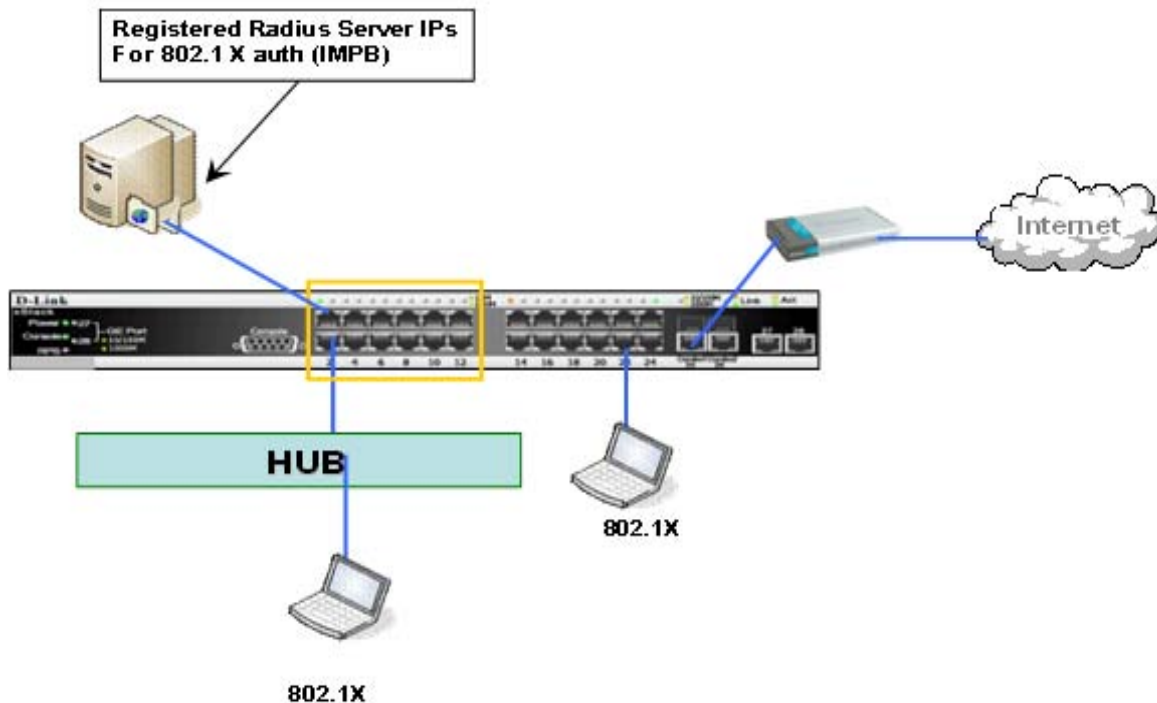
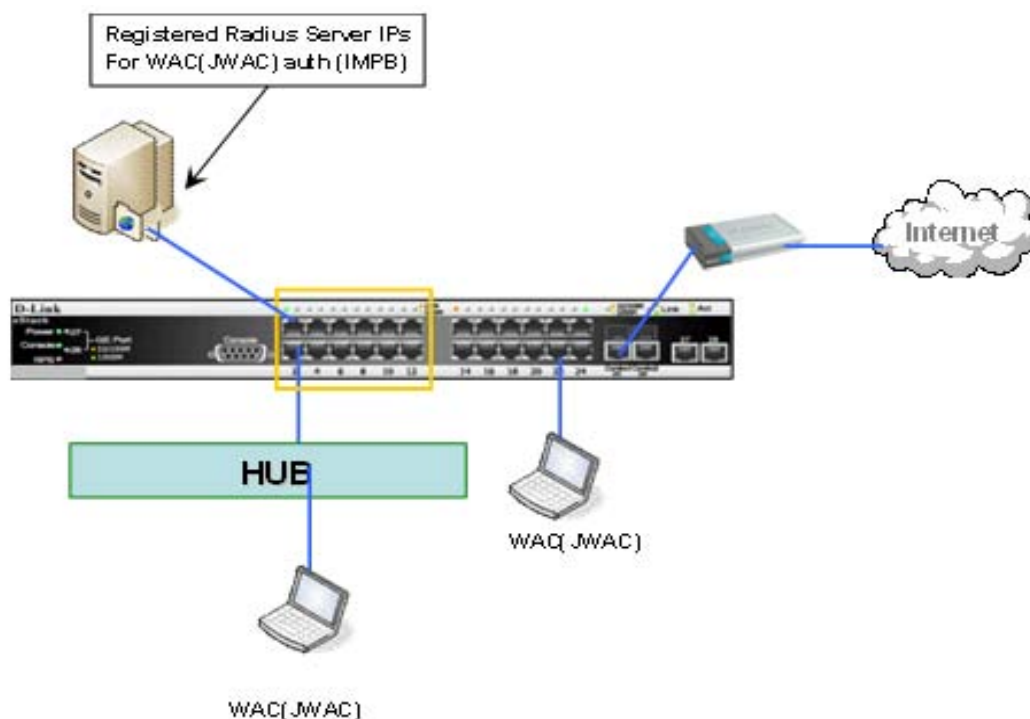

Figure 6 - 70. 802.1X & IMPB Mode

This mode adds an extra layer of security by checking the IP MAC-Binding Port Binding (IMPB) table before trying one of the supported authentication methods. The IMPB Table is used to create a 'white list' that checks if the IP streams being sent by authorized hosts have been granted or not. In the above diagram the Switch port has been configured to allow clients to authenticate using 802.1X. If the client is in the IMPB table and tries to connect to the network using this authentication method and the client is listed in the white list for legal IP/MAC/port checking, access will be granted. If a client fails one of the authentication methods, access will be denied.

## IMPB & WAC/JWAC Mode



**Figure 6 - 71. IMPB & WAC/JWAC Mode**

This mode adds an extra layer of security by checking the IP MAC-Binding Port Binding (IMPB) table before trying one of the supported authentication methods. The IMPB Table is used to create a 'white-list' that checks if the IP streams being sent by authorized hosts have been granted or not. In the above diagram, the Switch port has been configured to allow clients to authenticate using either WAC or JWAC. If the client is in the IMPB table and tries to connect to the network using either of these supported authentication methods and the client is listed in the white list for legal IP/MAC/port checking, access will be granted. If a client fails one of the authentication methods, access will be denied.

## MAC & IMPB Mode

This mode adds an extra layer of security by checking the IP MAC-Binding Port Binding (IMPB) table before trying one of the supported authentication methods. The IMPB Table is used to create a 'white-list' that checks if the IP streams being sent by authorized hosts have been granted or not. In the above diagram, the Switch port has been configured to allow clients to authenticate by using MAC. If the client is in the IMPB table and tries to connect to the network by using MAC and the client is listed in the white list for legal IP/MAC/port checking, access will be granted. If a client fails one of the authentication methods, access will be denied.

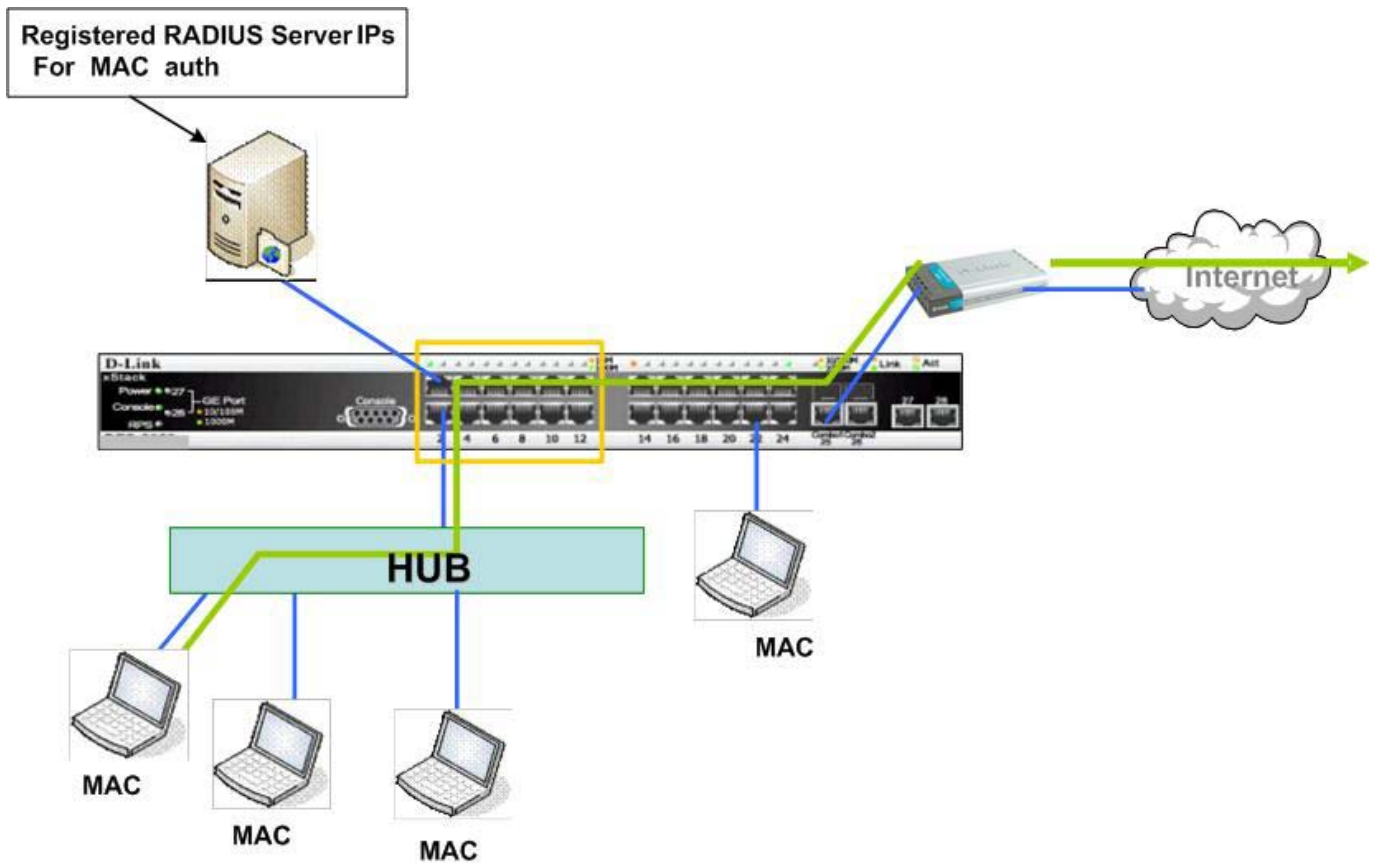

Figure 6 - 72. MAC & IMPB Mode

## Compound Authentication Settings

Users can configure Authorization Network State Settings for the Switch.

To view the following window, click **Security > Compound Authentication > Compound Authentication Settings**:

Port	Authentication Methods	Authorized Mode
1	None	Host-based
2	None	Host-based
3	None	Host-based
4	None	Host-based
5	None	Host-based
6	None	Host-based
7	None	Host-based
8	None	Host-based
9	None	Host-based
10	None	Host-based
11	None	Host-based
12	None	Host-based
13	None	Host-based
14	None	Host-based
15	None	Host-based
16	None	Host-based
17	None	Host-based
18	None	Host-based
19	None	Host-based
20	None	Host-based
21	None	Host-based
22	None	Host-based
23	None	Host-based
24	None	Host-based

Figure 6 - 73. Compound Authentication Settings window

The following fields and settings can be viewed:

Parameter	Description
<b>Authorization Attributes State</b>	Click the radio buttons to enable or disable the Authorization Attributes State.
<b>Authentication Server Failover</b>	Click the radio buttons to configure the authentication server failover function. <b>Block</b> (default setting) - The client is always regarded as un-authenticated. <b>Local</b> - The switch will resort to using the local database to authenticate the client. If the client fails on local authentication, the client is regarded as un-authenticated, otherwise, it is authenticated. <b>Permit</b> - The client is always regarded as authenticated. If guest VLAN is enabled, clients will stay on the guest VLAN, otherwise, they will stay on the original VLAN.
<b>From Port / To Port</b>	Use the drop-down menus to select a range of ports.
<b>Authentication Methods</b>	The compound authentication method options include: <i>None</i> , <i>Any (MAC, 802.1X or WAC/JWAC)</i> , <i>802.1X+IMPB</i> , <i>IMPB+JWAC</i> , and <i>IMPB+WAC</i> . <ul style="list-style-type: none"> <li><i>None</i> means all compound authentication methods are disabled.</li> <li><i>Any (MAC, 802.1X, JWAC or WAC)</i> means if any of the authentication methods pass, then access will be granted. In this mode, MAC, 802.1X and WAC/JWAC can be enabled on a port at the same time. In <i>Any (MAC, 802.1X or WAC/JWAC)</i> mode, whether an individual security module is active on a port depends on its system state. As system states of WAC and JWAC are mutually exclusive, only one of them will be active on a port at the same time.</li> <li><i>802.1X+IMPB</i> means 802.1X will be verified first, and then IMPB will be verified. Both authentication methods need to be passed.</li> <li><i>IMPB+JWAC</i> means JWAC will be verified first, and then IMPB will be verified.</li> </ul>

	<p>Both authentication methods need to be passed.</p> <ul style="list-style-type: none"> <li>• <i>IMPB+WAC</i> means WAC will be verified first, and then IMPB will be verified. Both authentication methods need to be passed.</li> <li>• <i>MAC+IMPB</i> means MAC will be verified first, and then IMPB will be verified. Both authentication methods need to be passed.</li> </ul>
<b>Authorized Mode</b>	<p>Toggle between <i>Host-based</i> and <i>Port-based</i>. When <i>Port-based</i> is selected, if one of the attached hosts passes the authentication, all hosts on the same port will be granted access to the network. If the user fails the authorization, this port will keep trying the next authentication method. When <i>Host-based</i> is selected, users are authenticated individually.</p>

Click **Apply** to implement the changes made.

## Compound Authentication Guest VLAN Settings

Users can assign ports to or remove ports from a guest VLAN.

To view the following window, click **Security > Compound Authentication > Compound Authentication Guest VLAN Settings**:

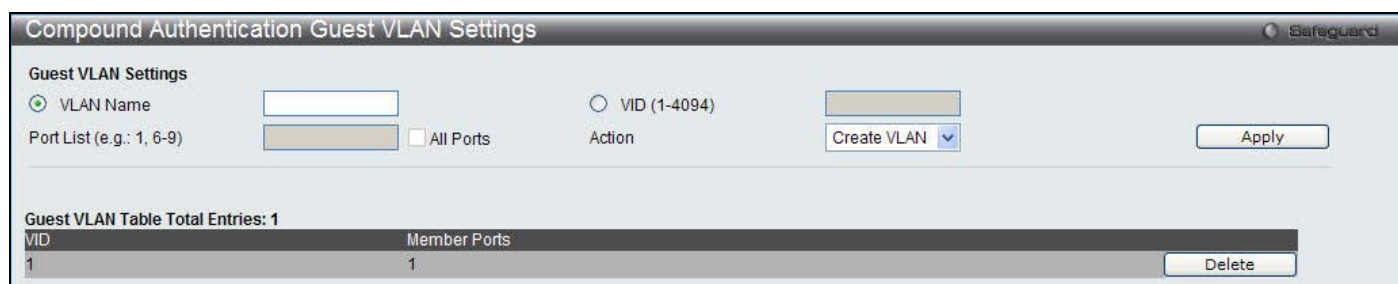

**Figure 6 - 74. Compound Authentication Auest VLAN Settings window**

The following fields may be modified to configure Guest VLANs:

Parameter	Description
<b>VLAN Name</b>	Click the button and assign a VLAN as a Guest VLAN. The VLAN must be an existing static VLAN.
<b>VID (1-4094)</b>	Click the button and assign a VLAN ID for a Guest VLAN. The VLAN must be an existing static VLAN before this VID can be configured.
<b>Port List (e.g.:1, 6-9)</b>	The list of ports to be configured. Alternatively, tick the All check box to set every port at once.
<b>Action</b>	Use the drop-down menu to choose the desired operation: <i>Create VLAN</i> , <i>Add Ports</i> , or <i>Delete Ports</i> .

Click the **Apply** button to accept the changes made. Click the **Delete** button to remove the specific entry.

## Compound Authentication MAC Format Settings

This window is used to set the MAC address format that will be used for authentication username via the RADIUS server.

To view the following window, click **Security > Compound Authentication > Compound Authentication MAC Format Settings**:

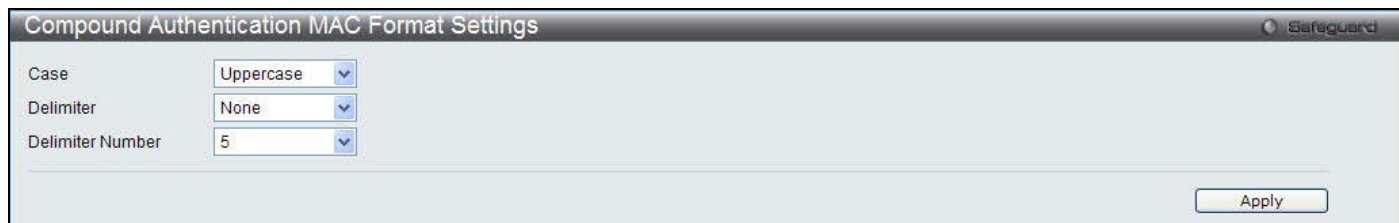

Figure 6 - 75. Compound Authentication MAC Format Settings window

The following fields may be modified to configure Guest VLANs:

Parameter	Description
<b>Case</b>	Use the drop-down menu to select the format for the RADIUS authentication username. <i>Lowerercase</i> - Use lowercase format, the RADIUS authentication username will be formatted as: aa-bb-cc-dd-ee-ff. <i>Uppercase</i> - Use uppercase format, the RADIUS authentication username will be formatted as: AA-BB-CC-DD-EE-FF.
<b>Delimiter</b>	Use the drop-down menu to select the delimiter format. <i>Hyphen</i> - Use "-" as delimiter, the format is: AA-BB-CC-DD-EE-FF. <i>Colon</i> - Use ":" as delimiter, the format is: AA:BB:CC:DD:EE:FF. <i>Dot</i> - Use "." as delimiter, the format is: AA.BB.CC.DD.EE.FF. <i>None</i> – Do not use any delimiter, the format is: AABBCCDDEEFF.
<b>Delimiter Number</b>	Use the drop-down menu to select the delimiter number. 1 - Single delimiter, the format is: AABBCC.DDEEFF. 2 - Double delimiter, the format is: AABB.CCDD.EEFF. 5 - Multiple delimiter, the format is: AA.BB.CC.DD.EE.FF.

Click the **Apply** button to accept the changes made.

## IGMP Access Control Settings

Users can set IGMP authentication, otherwise known as IGMP access control, on individual ports on the Switch. When the Authentication State is *Enabled*, and the Switch receives an IGMP join request, the Switch will send the access request to the RADIUS server to do the authentication.

IGMP authentication processes IGMP reports as follows: When a host sends a join message for the interested multicast group, the Switch has to do authentication before learning the multicast group/port. The Switch sends an Access-Request to an authentication server and the information including host MAC, switch port number, switch IP, and multicast group IP. When the Access-Accept is answered from the authentication server, the Switch learns the multicast group/port. When the Access-Reject is answered from the authentication server, the Switch won't learn the multicast group/port and won't process the packet further. The entry (host MAC, switch port number, and multicast group IP) is put in the "authentication failed list." When there is no answer from the authentication server after T1 time, the Switch resends the Access-Request to the server. If the Switch doesn't receive a response after N1 times, the result is denied and the entry (host MAC, switch port number, multicast group IP) is put in the "authentication failed list." In general case, when the multicast group/port is already learned by the switch, it won't do the authentication again. It only processes the packet as standard.

IGMP authentication processes IGMP leaves as follows: When the host sends leave message for the specific multicast group, the Switch follows the standard procedure for leaving a group and then sends an Accounting-Request to the accounting server for notification. If there is no answer from the accounting server after T2 time, the Switch resends the Accounting-Request to the server. The maximum number of retry times is N2.

To view the following window, click **Security > IGMP Access Control Settings**:

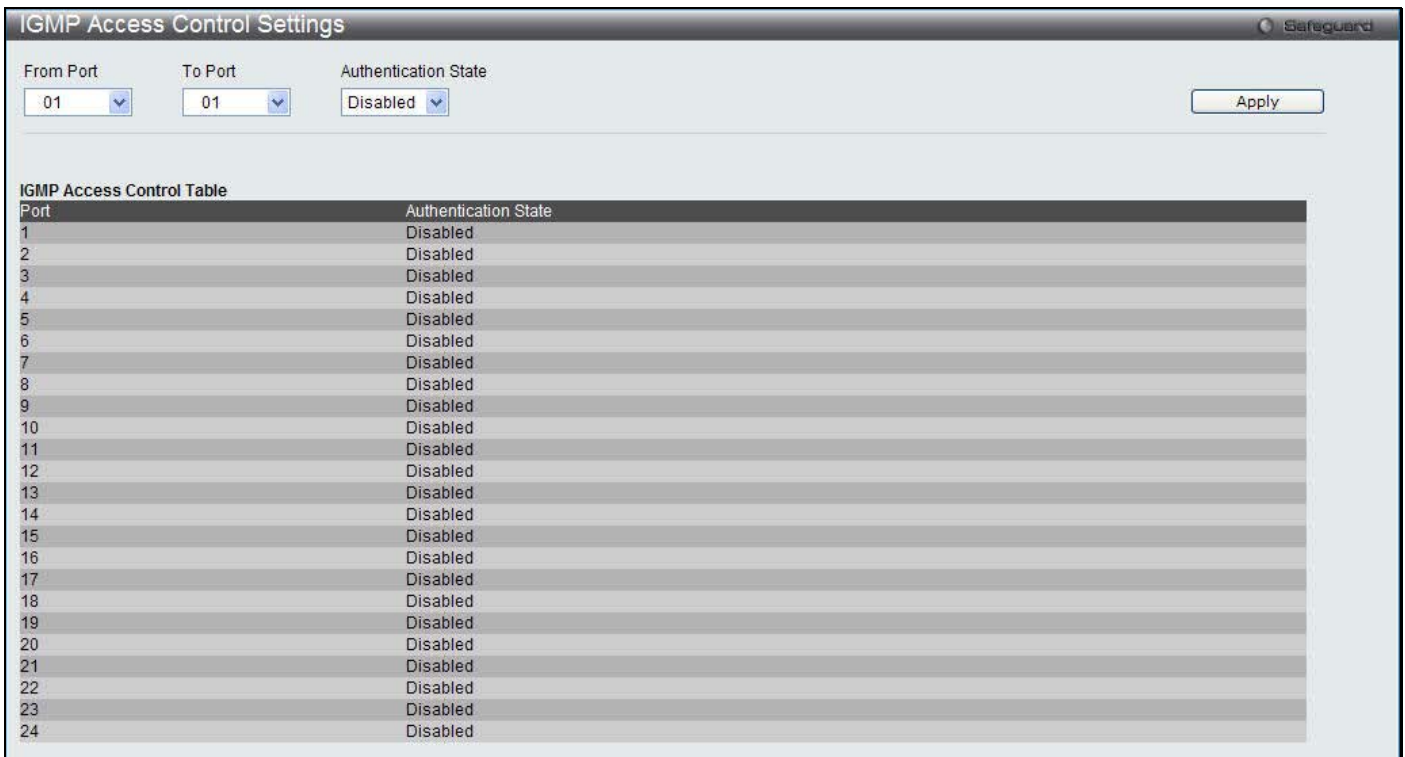

Figure 6 - 76. IGMP Access Control Settings window

To set up IGMP access control on individual ports for the Switch, complete the following fields:

Parameter	Description
<b>From Port / To Port</b>	Use the drop-down menus to select a range of ports to be enabled/disabled as IGMP access control ports.
<b>Authentication State</b>	Toggle to enable and disable the RADIUS authentication function on the specified ports.

Click **Apply** to implement the changes made.

## ARP Spoofing Prevention Settings

Users can try to prevent ARP spoofing by hackers and other unauthorized parties trying to access the Switch by using the following security feature.

To view the following window, click **Security > ARP Spoofing Prevention Settings**:



Figure 6 - 77. ARP Spoofing Prevention Settings window

Enter a Gateway IP address, Gateway MAC address, and a Port List and then click the **Apply** button.



**NOTE:** See Appendix A for more information on how to prevent ARP Spoofing attacks.

## BPDU Attack Protection

This window is used to configure the BPDU protection function for the ports on the switch. In generally, there are two states in BPDU protection function. One is normal state, and another is under attack state. The under attack state have three modes: drop, block, and shutdown. A BPDU protection enabled port will enter an under attack state when it receives one STP BPDU packet. And it will take action based on the configuration. Thus, BPDU protection can only be enabled on the STP-disabled port.

BPDU protection has a higher priority than the FBPDU setting configured by configure STP command in the determination of BPDU handling. That is, when FBPDU is configured to forward STP BPDU but BPDU protection is enabled, then the port will not forward STP BPDU.

BPDU protection also has a higher priority than the BPDU tunnel port setting in determination of BPDU handling. That is, when a port is configured as BPDU tunnel port for STP, it will forward STP BPDU. But if the port is BPDU protection enabled. Then the port will not forward STP BPDU.

To view the following window, click **Security > BPDU Attack Protection**:

Port	State	Mode	Status
1	Disabled	Shutdown	Normal
2	Disabled	Shutdown	Normal
3	Disabled	Shutdown	Normal
4	Disabled	Shutdown	Normal
5	Disabled	Shutdown	Normal
6	Disabled	Shutdown	Normal
7	Disabled	Shutdown	Normal
8	Disabled	Shutdown	Normal
9	Disabled	Shutdown	Normal
10	Disabled	Shutdown	Normal
11	Disabled	Shutdown	Normal
12	Disabled	Shutdown	Normal
13	Disabled	Shutdown	Normal
14	Disabled	Shutdown	Normal
15	Disabled	Shutdown	Normal
16	Disabled	Shutdown	Normal
17	Disabled	Shutdown	Normal
18	Disabled	Shutdown	Normal
19	Disabled	Shutdown	Normal
20	Disabled	Shutdown	Normal
21	Disabled	Shutdown	Normal

**Figure 6 - 78. BPDU Attack Protection window**

The following parameters can be configured:

Parameter	Description
<b>BPDU Attack Protection State</b>	Click the radio buttons to enable or disable the BPDU Attack Protection state.
<b>Trap State</b>	Specify when a trap will be sent. Options to choose from are <i>None</i> , <i>Attack Detected</i> , <i>Attack Cleared</i> or <i>Both</i> .



<b>Log State</b>	Specify when a log entry will be sent. Options to choose from are <i>None</i> , <i>Attack Detected</i> , <i>Attack Cleared</i> or <i>Both</i> .
<b>Recover Time (60-1000000)</b>	Enter the BPDU protection Auto-Recovery timer. The default value of the recovery timer is 60. Tick the <b>Infinite</b> check box for not auto recovering.
<b>From Port / To Port</b>	Use the drop-down menus to select a range of ports.
<b>State</b>	Use the drop-down menu to enable or disable the protection mode for a specific port.
<b>Mode</b>	Specify the BPDU protection mode. The default mode is shutdown. <i>Drop</i> – Drop all received BPDU packets when the port enters under attack state. <i>Block</i> – Drop all packets (include BPDU and normal packets) when the port enters under attack state. <i>Shutdown</i> – Shut down the port when the port enters under attack state.

Click **Apply** to implement the changes made.

## Loopback Detection Settings

The Loopback Detection function is used to detect the loop created by a specific port. This feature is used to temporarily shutdown a port on the Switch when a CTP (Configuration Testing Protocol) packet has been looped back to the Switch. When the Switch detects CTP packets received from a port or a VLAN, this signifies a loop on the network. The Switch will automatically block the port or the VLAN and send an alert to the administrator. The Loopback Detection port will restart (change to discarding state) when the Loopback Detection Recover Time times out. The Loopback Detection function can be implemented on a range of ports at a time. The user may enable or disable this function using the drop-down menu.

To view the following window, click **Security > Loopback Detection Settings**:

Port	Loopback Detection State	Loop Status
1	Disabled	Normal
2	Disabled	Normal
3	Disabled	Normal
4	Disabled	Normal
5	Disabled	Normal
6	Disabled	Normal
7	Disabled	Normal
8	Disabled	Normal
9	Disabled	Normal
10	Disabled	Normal
11	Disabled	Normal
12	Disabled	Normal
13	Disabled	Normal
14	Disabled	Normal
15	Disabled	Normal
16	Disabled	Normal
17	Disabled	Normal
18	Disabled	Normal
19	Disabled	Normal
20	Disabled	Normal
21	Disabled	Normal
22	Disabled	Normal
23	Disabled	Normal
24	Disabled	Normal

Figure 6 - 79. Loopback Detection Settings window

The following parameters may be viewed or modified:

Parameter	Description
<b>LBD State</b>	Use the drop-down menu to enable or disable loopback detection. The default is Disabled.
<b>Mode</b>	Use the drop-down menu to toggle between <i>Port-based</i> and <i>VLAN-based</i> .
<b>Trap Status</b>	Set the desired trap status: <i>None</i> , <i>Loop Detected</i> , <i>Loop Cleared</i> , or <i>Both</i> .
<b>Interval (1-32767)</b>	The time interval (in seconds) that the device will transmit all the CTP (Configuration Test Protocol) packets to detect a loop-back event. The valid range is from 1 to 32767 seconds. The default setting is 10 seconds.
<b>Recover Time (0 or 60-1000000)</b>	Time allowed (in seconds) for recovery when a Loopback is detected. The Loopdetect Recover Time can be set at 0 seconds, or 60 to 1000000 seconds. Entering 0 will disable the Loopdetect Recover Time. The default is 60 seconds.
<b>From Port / To Port</b>	Use the drop-down menus to select a range of ports to be configured.
<b>State</b>	Use the drop-down menu to toggle between <i>Enabled</i> and <i>Disabled</i> .

Click **Apply** to let the changes take effect.

## Traffic Segmentation

Traffic segmentation is used to limit traffic flow from a single or group of ports, to a group of ports. This method of segmenting the flow of traffic is similar to using VLANs to limit traffic, but is more restrictive. It provides a method of directing traffic that does not increase the overhead of the Master switch CPU.

To view the following window, click **Security > Traffic Segmentation**:

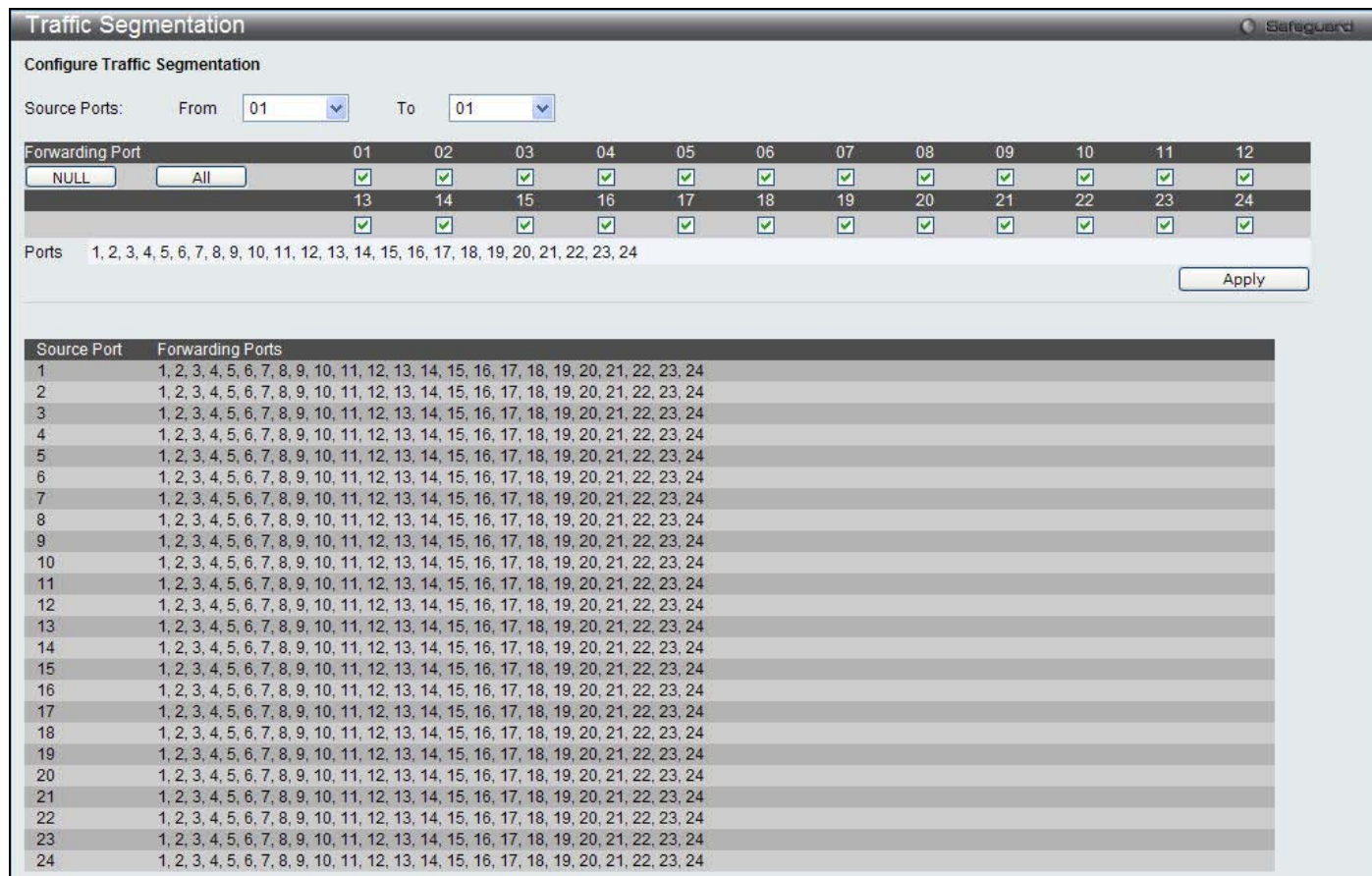

Figure 6 - 80. Traffic Segmentation window

To configure traffic segmentation on the Switch, first specify the Source Ports using the From and To drop-down menus at the top of the window. Next, specify which ports on the Switch are able to receive packets from the port(s) specified in the first step.

Clicking the **Apply** button will enter the combination of transmitting port(s) and allowed receiving ports into the Switch's Traffic Segmentation table.

## Safeguard Engine Settings

Periodically, malicious hosts on the network will attack the Switch by utilizing packet flooding (ARP Storm) or other methods. These attacks may increase the switch load beyond its capability. To alleviate this problem, the Safeguard Engine function was added to the Switch's software.

The Safeguard Engine can help the overall operability of the Switch by minimizing the workload of the Switch while the attack is ongoing, thus making it capable to forward essential packets over its network in a limited bandwidth. The Safeguard Engine has two operating modes that can be configured by the user, *Strict* and *Fuzzy*. In *Strict* mode, when the Switch either (a) receives too many packets to process or (b) exerts too much memory, it will enter the Exhausted mode. When in this mode, the Switch will drop all ARP and IP broadcast packets and packets from untrusted IP addresses for a calculated time interval. Every five seconds, the Safeguard Engine will check to see if there are too many packets flooding the Switch. If the threshold has been crossed, the Switch will initially stop all ingress ARP and IP broadcast packets and packets from untrusted IP addresses for five seconds. After another five-second checking interval arrives, the Switch will again check the ingress flow of packets. If the flooding has stopped, the Switch will again begin accepting all packets. Yet, if the checking shows that there continues to be too many packets flooding the Switch, it will stop accepting all ARP and IP broadcast packets and packets from untrusted IP addresses for double the time of the previous stop period. This doubling of time for stopping these packets will continue until the maximum time has been reached, which is 320 seconds and every stop from this point until a return to normal ingress flow would be 320 seconds. For a better understanding, please examine the following example of the Safeguard Engine.

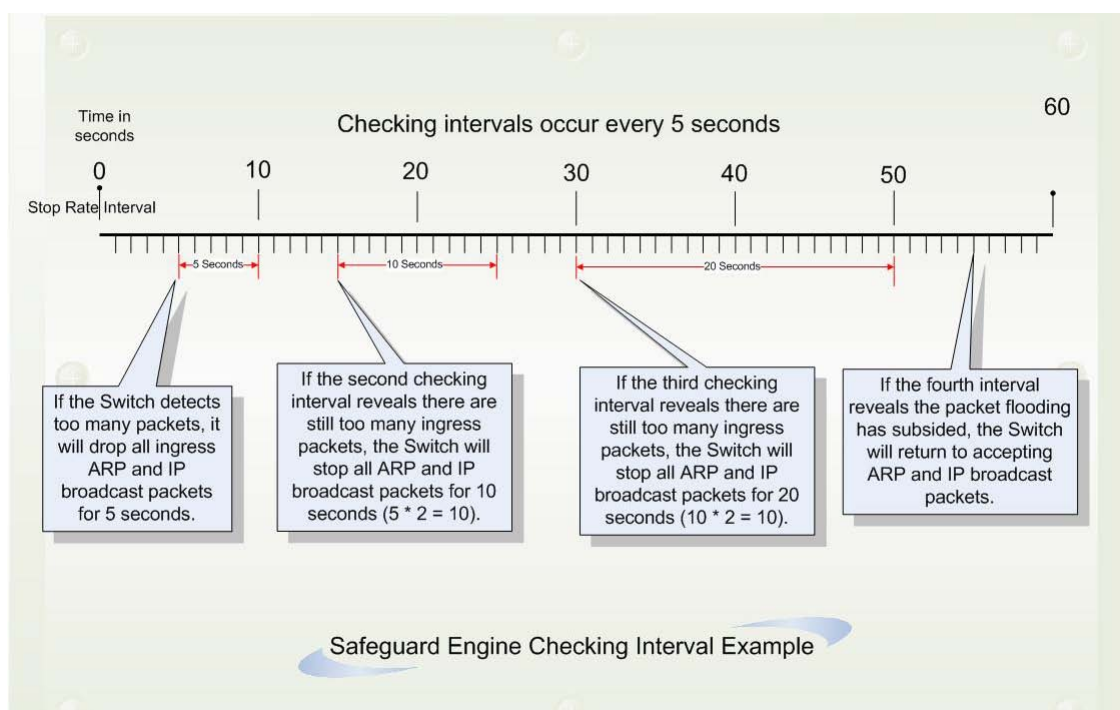

Figure 6 - 81. Safeguard Engine example

For every consecutive checking interval that reveals a packet flooding issue, the Switch will double the time it will discard ingress ARP and IP broadcast packets and packets from untrusted IP addresses. In the example above, the Switch doubled the time for dropping ARP and IP broadcast packets when consecutive flooding issues were detected at 5-second intervals. (First stop = 5 seconds, second stop = 10 seconds, third stop = 20 seconds) Once the flooding is no longer detected, the wait period for dropping ARP and IP broadcast packets will return to 5 seconds and the process will resume.

In *Fuzzy* mode, once the Safeguard Engine has entered the Exhausted mode, the Safeguard Engine will decrease the packet flow by half. After returning to Normal mode, the packet flow will be increased by 25%. The switch will then return to its interval checking and dynamically adjust the packet flow to avoid overload of the Switch.



**NOTICE:** When Safeguard Engine is enabled, the Switch will allot bandwidth to various traffic flows (ARP, IP) using the FFP (Fast Filter Processor) metering table to control the CPU utilization and limit traffic. This may limit the speed of routing traffic over the network.

Users can enable the Safeguard Engine or configure advanced Safeguard Engine settings for the Switch.

To view the following window, click **Security > Safeguard Engine Settings**:

**Figure 6 - 82. Safeguard Engine Settings window**

The following parameters can be configured:

Parameter	Description
<b>Safeguard Engine State</b>	Use the radio button to globally enable or disable Safeguard Engine settings for the Switch.
<b>Rising Threshold (20% - 100%)</b>	Used to configure the acceptable level of CPU utilization before the Safeguard Engine mechanism is enabled. Once the CPU utilization reaches this percentage level, the Switch will move into Exhausted mode, based on the parameters provided in this window.
<b>Falling Threshold (20% - 100%)</b>	Used to configure the acceptable level of CPU utilization as a percentage, where the Switch leaves the Safeguard Engine state and returns to normal mode.
<b>Trap / Log</b>	Use the drop-down menu to enable or disable the sending of messages to the device's SNMP agent and switch log once the Safeguard Engine has been activated by a high CPU utilization rate.
<b>Mode</b>	Used to select the type of Safeguard Engine to be activated by the Switch when the CPU utilization reaches a high rate. The user may select:  <i>Fuzzy</i> – If selected, this function will instruct the Switch to minimize the IP and ARP traffic flow to the CPU by dynamically allotting an even bandwidth to all traffic flows.  <i>Strict</i> – If selected, this function will stop accepting all ARP packets not intended for the Switch, and will stop receiving all unnecessary broadcast IP packets, until the storm has subsided.  The default setting is <i>Fuzzy</i> mode.

Click **Apply** to implement the changes.

## Trusted Host Settings

Up to ten trusted host secure IP addresses may be configured and used for remote Switch management. It should be noted that if one or more trusted hosts are enabled, the Switch will immediately accept remote instructions from only the specified IP address or addresses. If you enable this feature, be sure to first enter the IP address of the station you are currently using.

To view the following window, click **Security > Trusted Host Settings**:

**Trusted Host**
Safeguard

IP Address

IPv6 Address

Net Mask  (e.g. :255.255.255.254 or 1-32)

Net Mask  (1-128)

Access Interface  SNMP  Telnet  SSH  HTTP  HTTPS  Ping  All

**Total Entries: 0**

IP Address	Access Interface

**Note:** Create a list of IPv4/IPv6 addresses that can access the switch. Your local host IPv4/IPv6 address must be one of the IPv4/IPv6 addresses to avoid disconnection.

**Figure 6 - 83. Trusted Host window**

To configure secure IP addresses for trusted host management of the Switch, type the IP address and the net mask of the station you are currently using in the two fields, as well as up to nine additional IP addresses of trusted hosts, one by one. Click the **Apply** button to assign trusted host status to the IP addresses. This goes into effect immediately.

**Section 7**

# ACL

**ACL Configuration Wizard**

**Access Profile List**

**CPU Access Profile List**

**Time Range Settings**

## ACL Configuration Wizard

In order to make access profile and rule creation significantly easier to use, an ACL wizard has been introduced in the current firmware release. Of course, advanced users can still manually configure access profiles and rules in the Access Profile List in the next section.

To view the following window, click **ACL > ACL Configuration Wizard**:

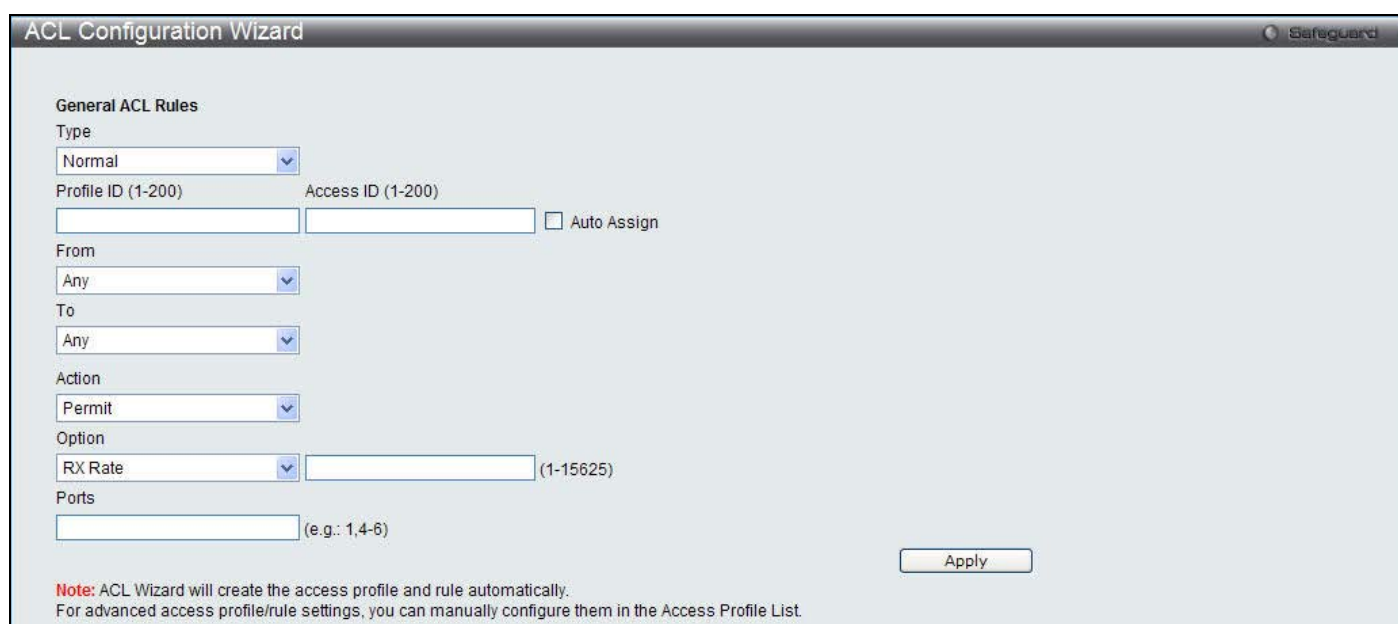

**Figure 7 - 1. ACL Configuration Wizard window**

The following parameters can be configured:

Parameter	Description
<b>Type</b>	Use the drop-down menu to select the general ACL Rule types: <i>Normal</i> – Selecting this option will create a Normal ACL Rule. <i>CPU</i> – Selecting this option will create a CPU ACL Rule.
<b>Profile ID (1-200)</b>	Enter the Profile ID for the new rule.
<b>Access ID (1-200)</b>	Enter the Access ID for the new rule. Selecting the <b>Auto Assign</b> option will allow the switch to automatically assign an unused access ID to this rule.
<b>From / To</b>	This rule can be created to apply to four different categories: <i>Any</i> – Selecting this option will include any starting category to this rule. <i>MAC Address</i> – Selecting this option will allow the user to enter a range of MAC addresses for this rule. <i>IPv4 Address</i> – Selecting this option will allow the user to enter a range of IPv4 addresses for

	<p>this rule.</p> <p><i>IPv6</i> – Selecting this option will allow the user to enter a range of IPv6 addresses for this rule.</p>
<b>Action</b>	<p>Select <i>Permit</i> to specify that the packets that match the access profile are forwarded by the Switch, according to any additional rule added (see below).</p> <p>Select <i>Deny</i> to specify that the packets that match the access profile are not forwarded by the Switch and will be filtered.</p> <p>Select <i>Mirror</i> to specify that packets that match the access profile are mirrored to a port defined in the mirror port section. Port Mirroring must be enabled and a target port must be set.</p>
<b>Option</b>	<p>After selecting the <b>Permit</b> action, the user can select one of the following options:</p> <p><i>RX Rate</i> – Enter the RX rate value.</p> <p><i>Replace DSCP</i> – Enter the DSCP value.</p> <p><i>Replace ToS Precedence</i> – Enter the ToS Precedence value.</p>
<b>Ports</b>	Enter a port or range of ports.

Click **Apply** to implement the changes made.

For more information about each of the parameters used in the ACL wizard, please see the detailed descriptions for each type of ACL rule in the rest of this chapter.

## Access Profile List

Access profiles allow you to establish criteria to determine whether the Switch will forward packets based on the information contained in each packet's header.

The Switch supports four Profile Types, Ethernet ACL, IPv4 ACL, IPv6 ACL, and Packet Content ACL.

Creating an access profile is divided into two basic parts. The first is to specify which part or parts of a frame the Switch will examine, such as the MAC source address or the IP destination address. The second part is entering the criteria the Switch will use to determine what to do with the frame. The entire process is described below in two parts.

Users can display the currently configured Access Profiles on the Switch.

To view the following window, click **ACL > Access Profile List** (one access profile of each type has been created for explanatory purposes):

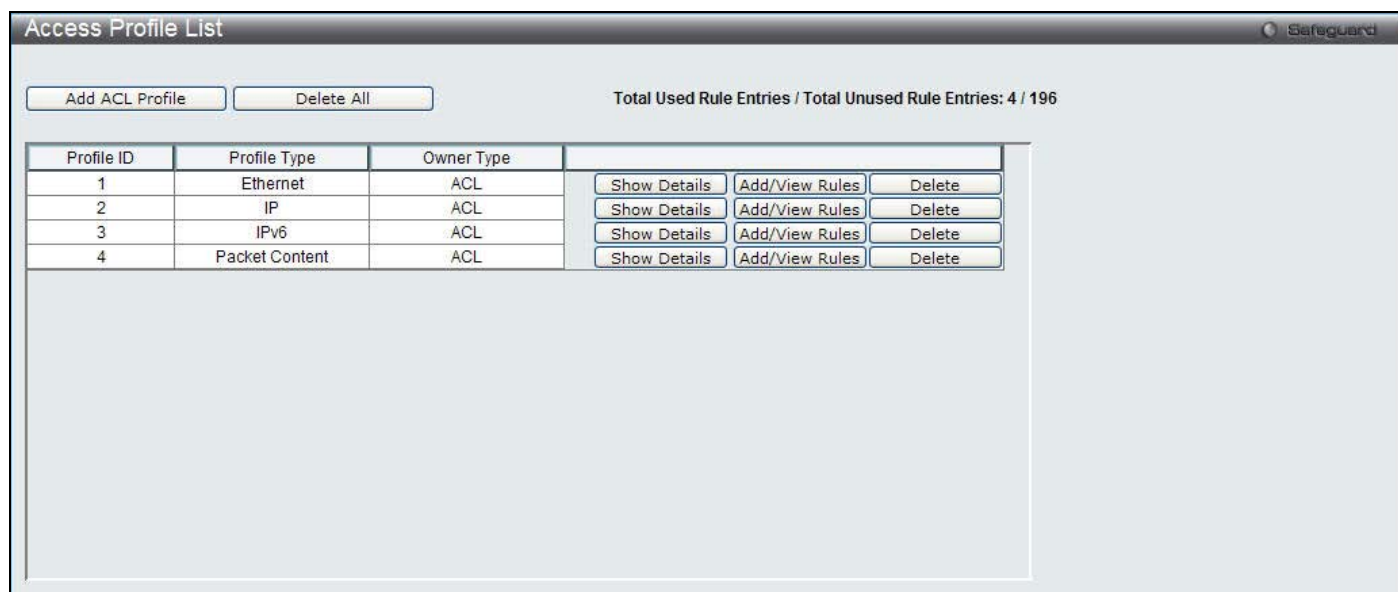
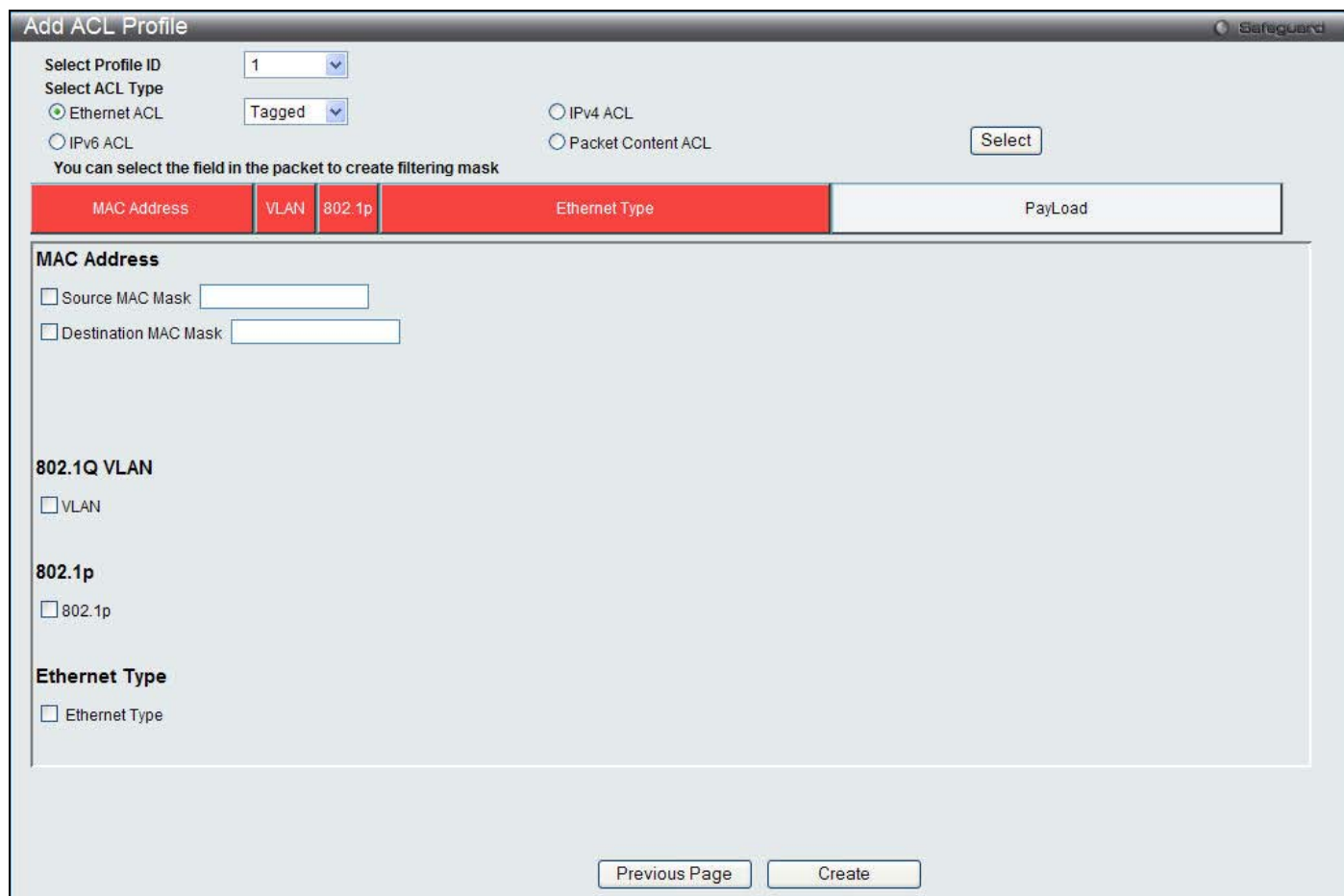

Figure 7 - 2. Access Profile List window

To add an entry to the **Access Profile List** window, click the **Add ACL Profile** button. To remove all access profiles from this table, click **Delete All**.

There are four **Add Access Profile** windows; one for Ethernet (or MAC address-based) profile configuration, one for IPv6 address-based profile configuration, one for IPv4 address-based profile configuration, and one for packet content profile configuration.

The window shown below is the **Add ACL Profile** window for Ethernet:



**Figure 7 - 3. Add ACL Profile window for Ethernet ACL**

The following parameters can be set for the Ethernet ACL type:

Parameter	Description
<b>Select Profile ID</b>	Use the drop-down menu to select a unique identifier number for this profile set. This value can be set from 1 to 200.
<b>Select ACL Type</b>	Select profile based on Ethernet (MAC Address), IPv4 address, IPv6 address, or packet content. This will change the window according to the requirements for the type of profile. Select Ethernet ACL to instruct the Switch to examine the layer 2 part of each packet header. Select IPv4 ACL to instruct the Switch to examine the IPv4 address in each frame's header. Select IPv6 ACL to instruct the Switch to examine the IPv6 address in each frame's header. Select Packet Content to instruct the Switch to examine the packet content in each frame's header.
<b>Source MAC Mask</b>	Enter a MAC address mask for the source MAC address.
<b>Destination MAC Mask</b>	Enter a MAC address mask for the destination MAC address.
<b>802.1Q VLAN</b>	Selecting this option instructs the Switch to examine the 802.1Q VLAN identifier of each packet header and use this as the full or partial criterion for forwarding.
<b>802.1p</b>	Selecting this option instructs the Switch to examine the 802.1p priority value of each packet header and use this as the, or part of the criterion for forwarding.



<b>Ethernet Type</b>	Selecting this option instructs the Switch to examine the Ethernet type value in each frame's header.
----------------------	---

Click **Create** to create the new ACL Profile.

To view the setting details for a created profile, click the **Show Details** button for the corresponding entry on the **Access Profile List** window, revealing the following window:



**Figure 7 - 4. Access Profile Detail Information window for Ethernet**

The window shown below is the **Add ACL Profile** window for IPv4:

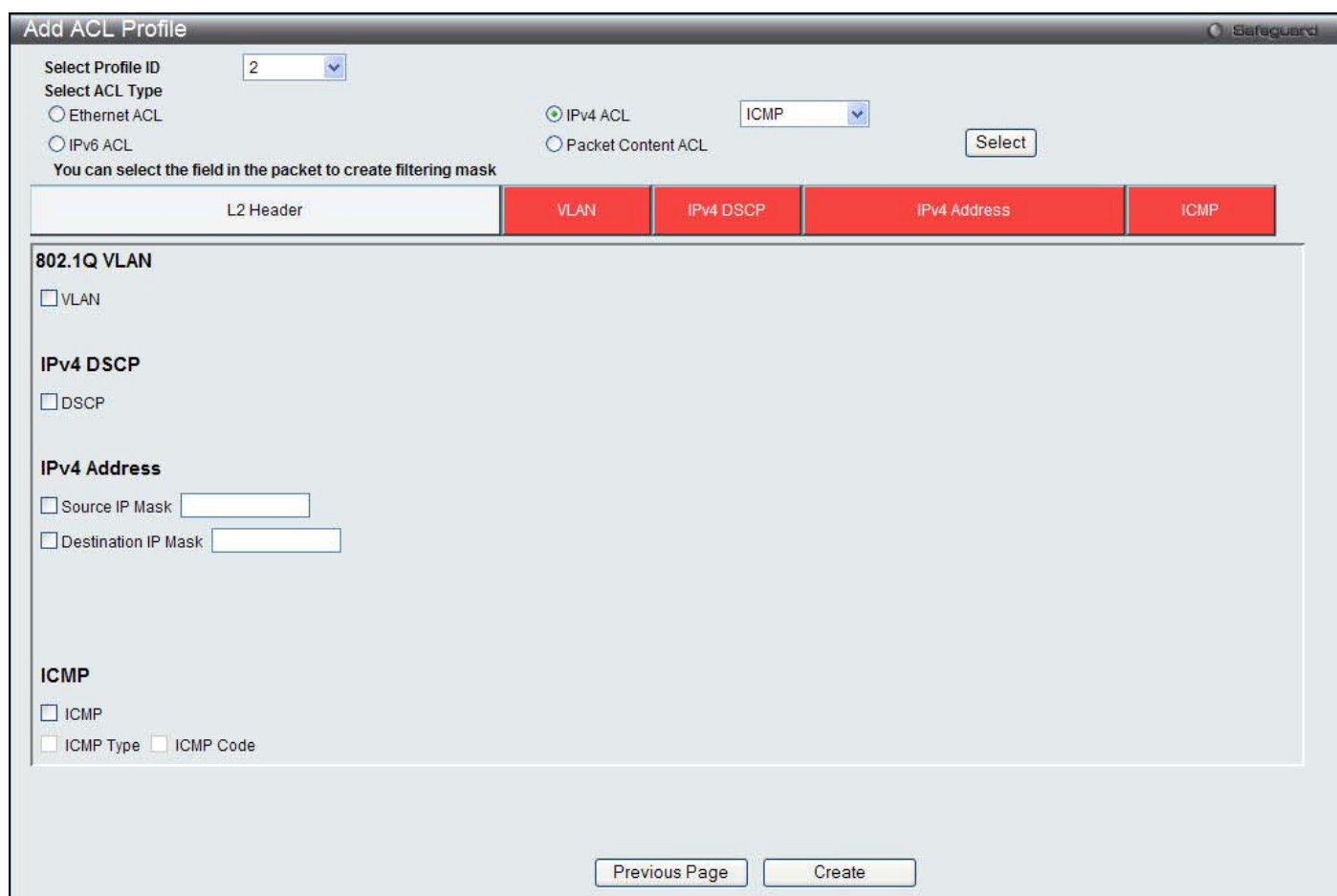

**Figure 7 - 5. Add ACL Profile window for IPv4 ACL**

The following parameters can be set for the IPv4 ACL type:

Parameter	Description
<b>Select Profile ID</b>	Use the drop-down menu to select a unique identifier number for this profile set. This value can be set from 1 to 200.
<b>Select ACL Type</b>	Select profile based on Ethernet (MAC Address), IPv4 address, IPv6 address, or packet

	<p>content. This will change the window according to the requirements for the type of profile.</p> <p>Select Ethernet ACL to instruct the Switch to examine the layer 2 part of each packet header.</p> <p>Select IPv4 ACL to instruct the Switch to examine the IPv4 address in each frame's header.</p> <p>Select IPv6 ACL to instruct the Switch to examine the IPv6 address in each frame's header.</p> <p>Select Packet Content to instruct the Switch to examine the packet content in each frame's header.</p>
<b>802.1Q VLAN</b>	Selecting this option instructs the Switch to examine the 802.1Q VLAN identifier of each packet header and use this as the full or partial criterion for forwarding.
<b>IPv4 DSCP</b>	Selecting this option instructs the Switch to examine the DiffServ Code part of each packet header and use this as the, or part of the criterion for forwarding.
<b>IPv4 Source IP Mask</b>	Enter an IP address mask for the source IP address.
<b>IPv4 Destination IP Mask</b>	Enter an IP address mask for the destination IP address.
<b>Protocol</b>	<p>Selecting this option instructs the Switch to examine the protocol type value in each frame's header. Then the user must specify what protocol(s) to include according to the following guidelines:</p> <p>Select <i>ICMP</i> to instruct the Switch to examine the Internet Control Message Protocol (ICMP) field in each frame's header.</p> <ul style="list-style-type: none"> <li>Select <i>Type</i> to further specify that the access profile will apply an ICMP type value, or specify <i>Code</i> to further specify that the access profile will apply an ICMP code value.</li> </ul> <p>Select <i>IGMP</i> to instruct the Switch to examine the Internet Group Management Protocol (IGMP) field in each frame's header.</p> <ul style="list-style-type: none"> <li>Select <i>Type</i> to further specify that the access profile will apply an IGMP type value.</li> </ul> <p>Select <i>TCP</i> to use the TCP port number contained in an incoming packet as the forwarding criterion. Selecting TCP requires that you specify a source port mask and/or a destination port mask.</p> <ul style="list-style-type: none"> <li><i>src port mask</i> - Specify a TCP port mask for the source port in hex form (hex 0x0-0xffff), which you wish to match.</li> <li><i>dst port mask</i> - Specify a TCP port mask for the destination port in hex form (hex 0x0-0xffff) which you wish to match.</li> <li><i>flag bit</i> - The user may also identify which flag bits to match. Flag bits are parts of a packet that determine what to do with the packet. The user may filter packets by filtering certain flag bits within the packets, by checking the boxes corresponding to the flag bits of the TCP field. The user may choose among the <i>urg (urgent)</i>, <i>ack (acknowledgement)</i>, <i>psh (push)</i>, <i>rst (reset)</i>, <i>syn (synchronize)</i>, and <i>fin (finish)</i> options.</li> <li>Select <i>UDP</i> to use the UDP port number contained in an incoming packet as the forwarding criterion. Selecting UDP requires that you specify a source port mask and/or a destination port mask.</li> <li><i>src port mask</i> - Specify a UDP port mask for the source port in hex form (hex 0x0-0xffff).</li> <li><i>dst port mask</i> - Specify a UDP port mask for the destination port in hex form (hex 0x0-0xffff).</li> </ul> <p><i>Protocol ID</i> - Enter a value defining the protocol ID in the packet header to mask. Specify the protocol ID mask in hex form (hex 0x0-0xff).</p>

Click **Create** to implement changes made.

To view the setting details for a created profile, click the **Show Details** button for the corresponding entry on the **Access Profile List** window, revealing the following window:

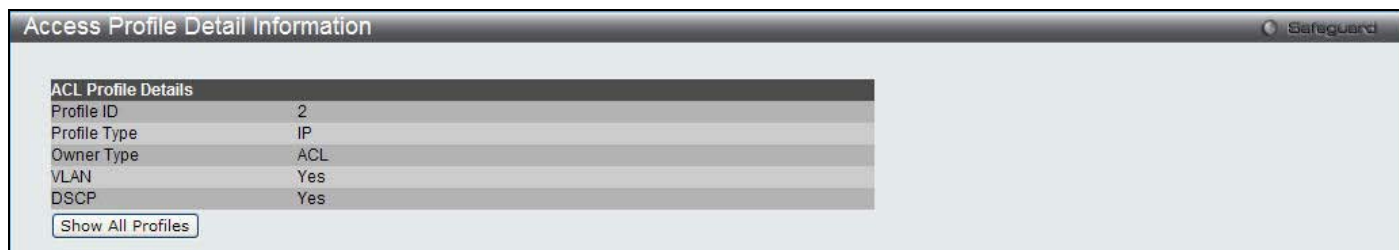

Figure 7 - 6. Access Profile Detail Information window for IPv4

The window shown below is the **Add ACL Profile** window for IPv6:

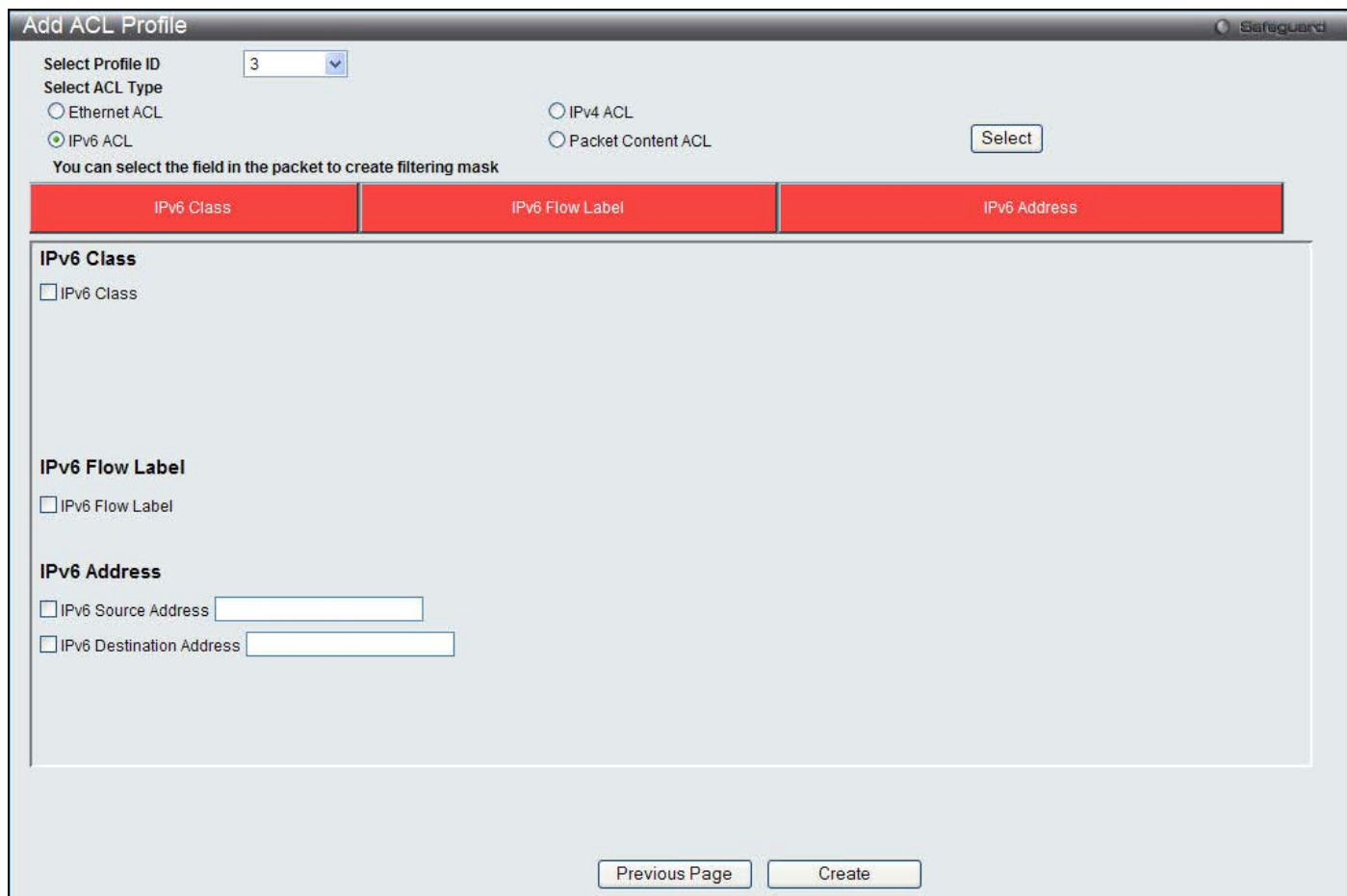

Figure 7 - 7. Add ACL Profile window for IPv6

The following parameters can be set for the IPv6 ACL type:

Parameter	Description
<b>Select Profile ID</b>	Use the drop-down menu to select a unique identifier number for this profile set. This value can be set from 1 to 200.
<b>Select ACL Type</b>	Select profile based on Ethernet (MAC Address), IPv4 address, IPv6 address, or packet content. This will change the window according to the requirements for the type of profile. Select Ethernet ACL to instruct the Switch to examine the layer 2 part of each packet header. Select IPv4 ACL to instruct the Switch to examine the IPv4 address in each frame's header. Select IPv6 ACL to instruct the Switch to examine the IPv6 address in each frame's header. Select Packet Content to instruct the Switch to examine the packet content in each frame's header.
<b>IPv6 Class</b>	Ticking this check box will instruct the Switch to examine the <i>class</i> field of the IPv6 header. This class field is a part of the packet header that is similar to the Type of Service (ToS) or Precedence bits field in IPv4.

<b>IPv6 Flow Label</b>	Ticking this check box will instruct the Switch to examine the <i>flow label</i> field of the IPv6 header. This flow label field is used by a source to label sequences of packets such as non-default quality of service or real time service packets.
<b>IPv6 Source Address</b>	The user may specify an IP address mask for the source IPv6 address by ticking the corresponding check box and entering the IP address mask.
<b>IPv6 Destination Address</b>	The user may specify an IP address mask for the destination IPv6 address by ticking the corresponding check box and entering the IP address mask.

Click **Create** to implement changes made.

To view the setting details for a created profile, click the **Show Details** button for the corresponding entry on the **Access Profile List** window, revealing the following window:

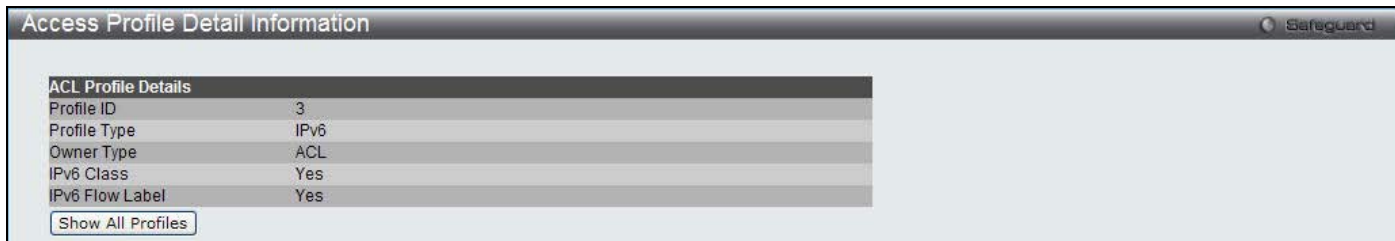

Figure 7 - 8. Access Profile Detail Information window for IPv6

The window shown below is the **Add ACL Profile** window for Packet Content:

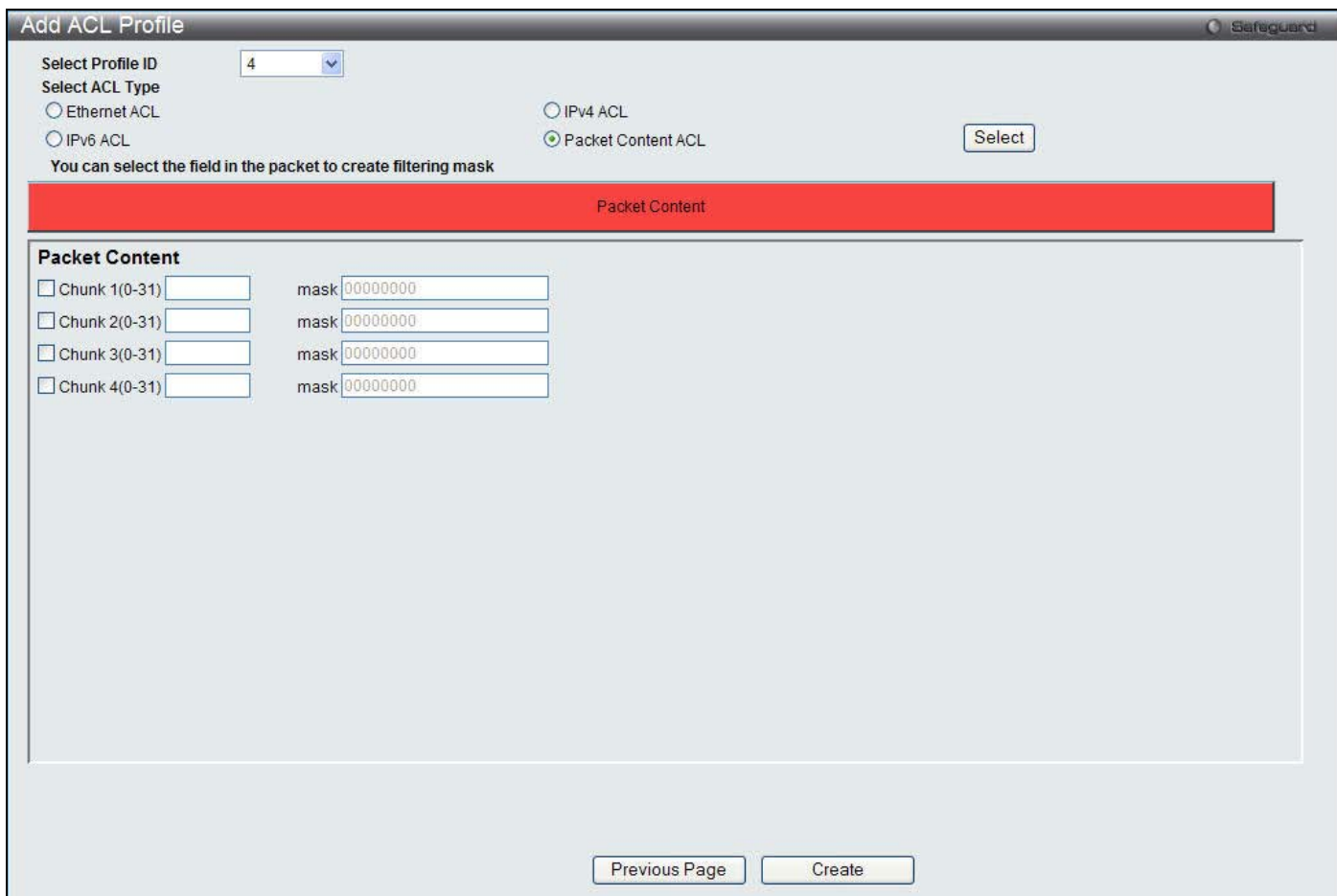

Figure 7 - 9. Add ACL Profile window for Packet Content

The following parameters can be set for the Packet Content type:

Parameter	Description														
Select Profile ID	Use the drop-down menu to select a unique identifier number for this profile set. This value can be set from 1 to 200.														
Select ACL Type	Select profile based on Ethernet (MAC Address), IPv4 address, IPv6 address, or packet content. This will change the window according to the requirements for the type of profile. Select Ethernet ACL to instruct the Switch to examine the layer 2 part of each packet header. Select IPv4 ACL to instruct the Switch to examine the IPv4 address in each frame's header. Select IPv6 ACL to instruct the Switch to examine the IPv6 address in each frame's header. Select Packet Content to instruct the Switch to examine the packet content in each frame's header.														
Packet Content	Allows users to examine up to four specified offset chunks within a packet, one at a time. A chunk mask presents four bytes. Four offset chunks can be selected from a possible 32 predefined offset chunks as described below: offset_chunk_1, offset_chunk_2, offset_chunk_3, offset_chunk_4. <table border="1" data-bbox="399 817 1252 1041"> <thead> <tr> <th>chunk0</th> <th>chunk1</th> <th>chunk2</th> <th>.....</th> <th>chunk29</th> <th>chunk30</th> <th>chunk31</th> </tr> </thead> <tbody> <tr> <td>B126, B127, B0, B1</td> <td>B2, B3, B4, B5</td> <td>B6, B7, B8, B9</td> <td>.....</td> <td>B114, B115, B116, B117</td> <td>B118, B119, B120, B121</td> <td>B122, B123, B124, B125</td> </tr> </tbody> </table> Example: offset_chunk_1 0 0xffffffff will match packet byte offset 126, 127, 0, 1 offset_chunk_1 0 0x0000ffff will match packet byte offset, 0,1 <b>NOTE:</b> Only one packet content mask profile can be created at a time. Use of the D-Link xStack switch family's advanced Packet Content Mask (also known as Packet Content Access Control List – ACL) feature can effectively mitigate common network attacks such as ARP Spoofing. The Switch's implementation of Packet Content ACL enables inspection of any packet's specified content regardless of the protocol layer.	chunk0	chunk1	chunk2	.....	chunk29	chunk30	chunk31	B126, B127, B0, B1	B2, B3, B4, B5	B6, B7, B8, B9	.....	B114, B115, B116, B117	B118, B119, B120, B121	B122, B123, B124, B125
chunk0	chunk1	chunk2	.....	chunk29	chunk30	chunk31									
B126, B127, B0, B1	B2, B3, B4, B5	B6, B7, B8, B9	.....	B114, B115, B116, B117	B118, B119, B120, B121	B122, B123, B124, B125									

Click **Create** to implement changes made.

To view the setting details for a created profile, click the **Show Details** button for the corresponding entry on the **Access Profile List** window, revealing the following window:



**Figure 7 - 10. Access Profile Detail Information window for Packet Content**



**NOTE:** Address Resolution Protocol (ARP) is the standard for finding a host's hardware address (MAC address). However, ARP is vulnerable as it can be easily spoofed and utilized to attack a LAN (i.e. an ARP spoofing attack). For a more detailed explanation on how ARP protocol works and how to employ D-Link's unique Packet Content ACL to prevent ARP spoofing attack, please see Appendix E at the end of this manual.

**To establish the rule for a previously created Access Profile:**

To configure the Access Rules for Ethernet, open the **Access Profile List** window and click **Add/View Rules** for an Ethernet entry. This will open the following window:



**Figure 7 - 11. Access Rule List window for Ethernet**

To remove a previously created rule, click the corresponding **Delete Rules** button. To add a new Access Rule, click the **Add Rule** button:

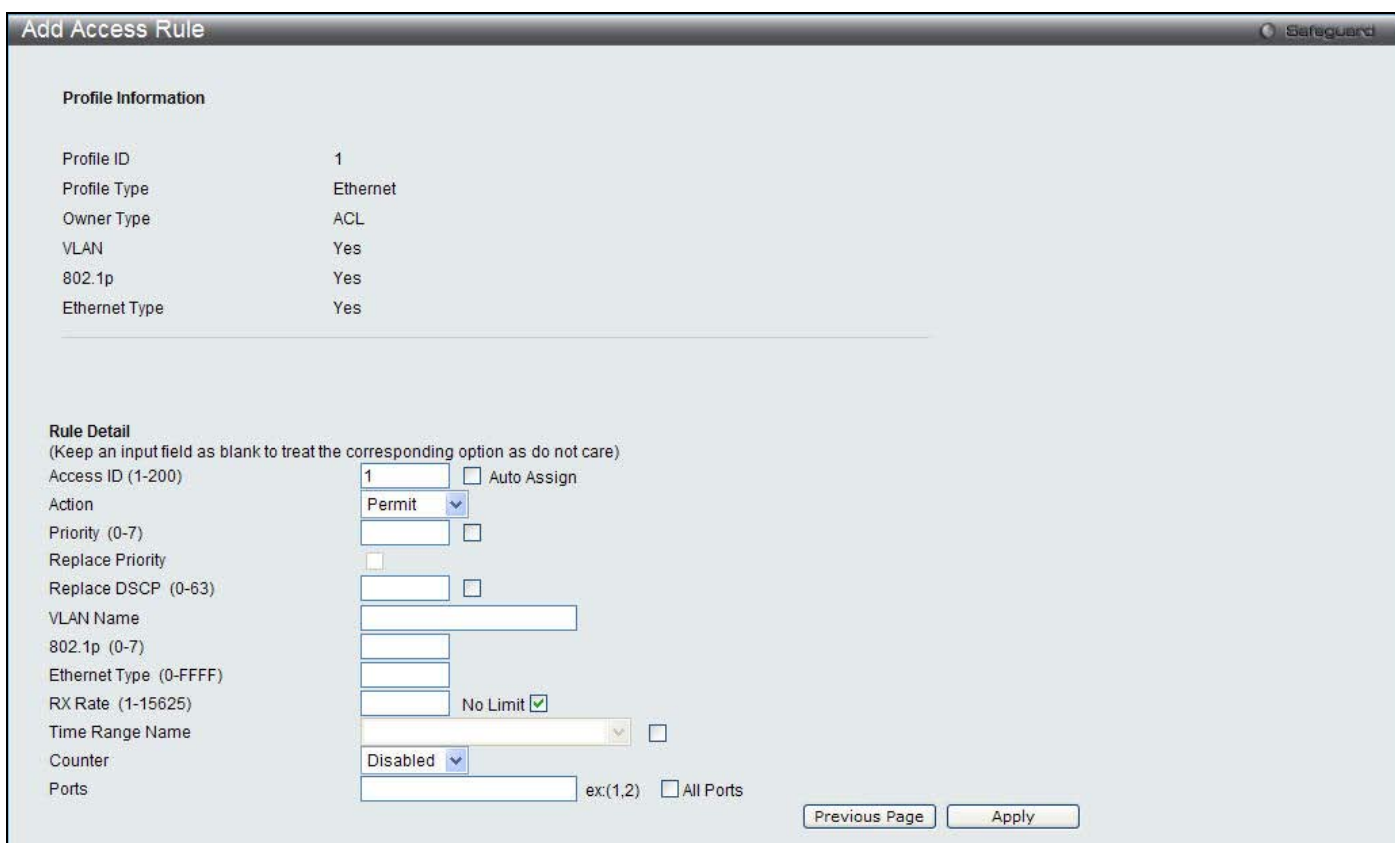

**Figure 7 - 12. Add Access Rule window for Ethernet**

The following parameters can be configured:

Parameter	Description
<b>Access ID (1-200)</b>	Type in a unique identifier number for this access. This value can be set from 1 to 200. Auto Assign – Ticking this check box will instruct the Switch to automatically assign an Access ID for the rule being created.
<b>Action</b>	Select <i>Permit</i> to specify that the packets that match the access rule are forwarded by the Switch, according to any additional rule added (see below). Select <i>Deny</i> to specify that packets that match the access rule are not forwarded by the Switch and will be filtered. Select <i>Mirror</i> to specify that packets that match the access rule are mirrored to a port defined in the config mirror port command. Port Mirroring must be enabled and a target port must be set.
<b>Priority (0-7)</b>	Tick the corresponding check box if you want to re-write the 802.1p default priority of a packet to

	the value entered in the Priority field, which meets the criteria specified previously in this command, before forwarding it on to the specified CoS queue. Otherwise, a packet will have its incoming 802.1p user priority re-written to its original value before being forwarded by the Switch. For more information on priority queues, CoS queues and mapping for 802.1p, see the QoS section of this manual.
<b>Replace Priority</b>	Tick this check box to replace the Priority value in the adjacent field.
<b>Replace DSCP (0-63)</b>	Select this option to instruct the Switch to replace the DSCP value (in a packet that meets the selected criteria) with the value entered in the adjacent field. Note: When an ACL rule is added to change both the priority and DSCP of an IPv4 packet, only one of them can be modified due to a chip limitation. Currently the priority is changed when both the priority and DSCP are set to be modified.
<b>VLAN Name</b>	Allows the entry of a name for a previously configured VLAN.
<b>802.1p (0-7)</b>	Enter a value from 0 to 7 to specify that the access profile will apply only to packets with this 802.1p priority value.
<b>RX Rate (1-15625)</b>	Use this to limit RX bandwidth for the profile being configured. This rate is implemented using the following equation: 1 value = 64kbit/sec. (ex. If the user selects an RX rate of 10 then the ingress rate is 640kbit/sec.) The user may select a value between 1 and 15625 or tick the <b>No Limit</b> check box. The default setting is <i>No Limit</i> .
<b>Time Range Name</b>	Tick the check box and enter the name of the Time Range settings that has been previously configured in the <b>Time Range Settings</b> window. This will set specific times when this access rule will be implemented on the Switch.
<b>Counter</b>	Use the drop-down menu to specify if the Counter feature should be <i>Enabled</i> or <i>Disabled</i> . The Counter feature is used to keep a record of the number of packets that have matched the Access Rule. For example if you create an Ethernet ACL that permits the source MAC address of 00-00-00-00-00-01 access to the Switch and a 1000 packets with the source MAC address of 00-00-00-00-00-01 is received by the Switch, the counter values will be 1000, to indicate that the ACL has matched 1000 packets.
<b>Ports</b>	When a range of ports is to be configured, the Auto Assign check box MUST be ticked in the Access ID field of this window. If not, the user will be presented with an error message and the access rule will not be configured. Ticking the All Ports check box will denote all ports on the Switch.

Click **Apply** to implement the changes.

To view the settings of a previously correctly configured rule, click the corresponding **Show Details** button on the **Access Rule List** window to view the following window:



**Figure 7 - 13. Access Rule Detail Information window for Ethernet**

**To establish the rule for a previously created Access Profile:**

To configure the Access Rules for IPv4, open the **Access Profile List** window and click **Add/View Rules** for an IPv4 entry. This will open the following window:



Figure 7 - 14. Access Rule List window for IPv4

To remove a previously created rule, click the corresponding **Delete Rules** button. To add a new Access Rule, click the **Add Rule** button:

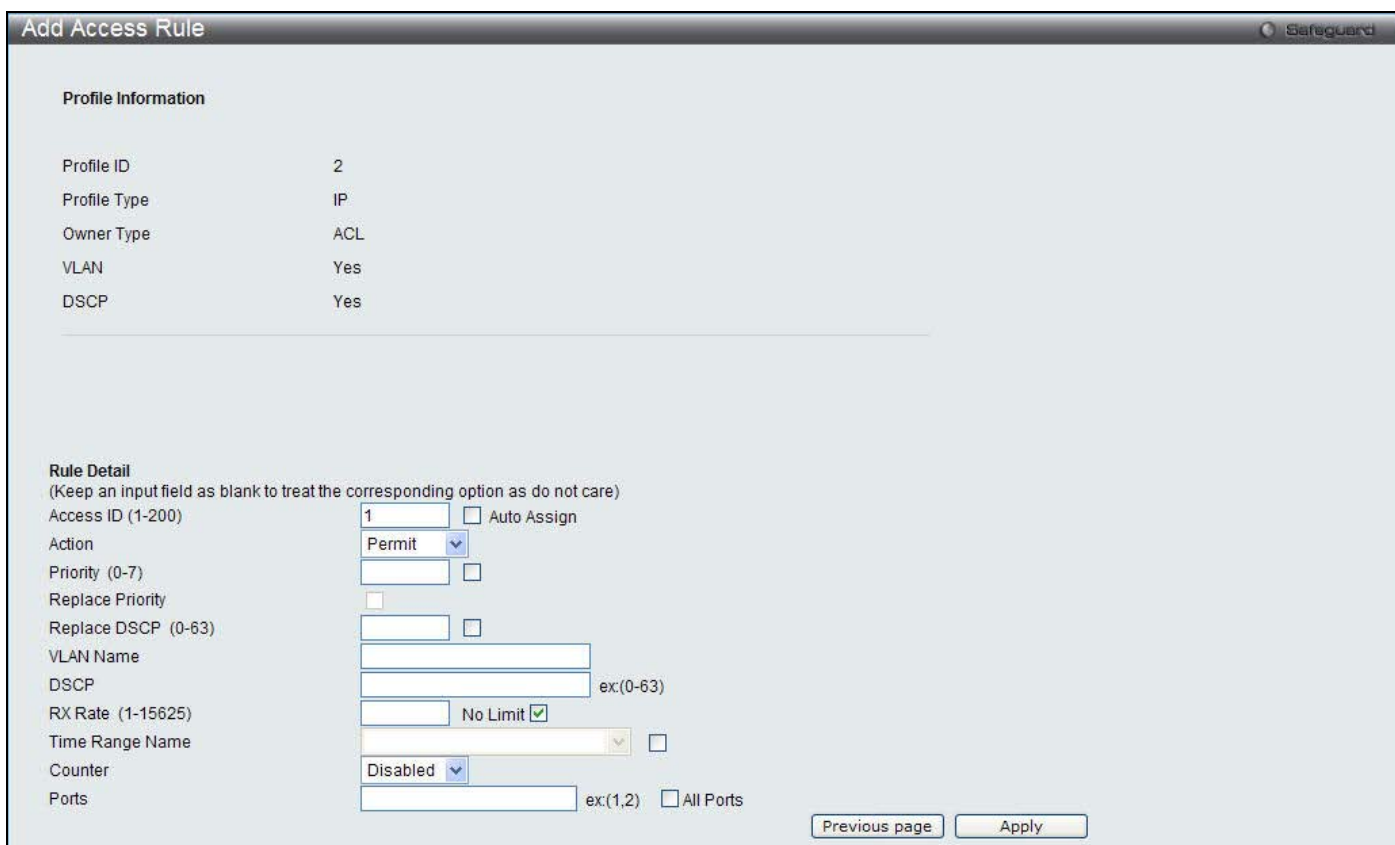

Figure 7 - 15. Add Access Rule window for IPv4

The following parameters can be configured:

Parameter	Description
<b>Access ID (1-200)</b>	Type in a unique identifier number for this access. This value can be set from 1 to 200. Auto Assign – Ticking this check box will instruct the Switch to automatically assign an Access ID for the rule being created.
<b>Action</b>	Select <i>Permit</i> to specify that the packets that match the access rule are forwarded by the Switch, according to any additional rule added (see below). Select <i>Deny</i> to specify that packets that match the access rule are not forwarded by the Switch and will be filtered. Select <i>Mirror</i> to specify that packets that match the access rule are mirrored to a port defined in the config mirror port command. Port Mirroring must be enabled and a target port must be set.
<b>Priority (0-7)</b>	Tick the corresponding check box if you want to re-write the 802.1p default priority of a packet to the value entered in the Priority field, which meets the criteria specified previously in this command, before forwarding it on to the specified CoS queue. Otherwise, a packet will have its incoming 802.1p user priority re-written to its original value before being forwarded by the Switch. For more information on priority queues, CoS queues and mapping for 802.1p, see the QoS section of this manual.



<b>Replace Priority</b>	Tick this check box to replace the Priority value in the adjacent field.
<b>Replace DSCP (0-63)</b>	Select this option to instruct the Switch to replace the DSCP value (in a packet that meets the selected criteria) with the value entered in the adjacent field. Note: When an ACL rule is added to change both the priority and DSCP of an IPv4 packet, only one of them can be modified due to a chip limitation. Currently the priority is changed when both the priority and DSCP are set to be modified.
<b>VLAN Name</b>	This field allows the user to enter a VLAN Name in the space provided, which will instruct the Switch to examine the VLAN identifier of each packet header.
<b>DSCP</b>	This field allows the user to enter a DSCP value in the space provided, which will instruct the Switch to examine the DiffServ Code part of each packet header and use this as the, or part of the criterion for forwarding. The user may choose a value between 0 and 63.
<b>RX Rate (1-15625)</b>	Use this to limit RX bandwidth for the profile being configured. This rate is implemented using the following equation: 1 value = 64kbit/sec. (ex. If the user selects an RX rate of 10 then the ingress rate is 640kbit/sec.) The user may select a value between 1 and 15625 or tick the <b>No Limit</b> check box. The default setting is <i>No Limit</i> .
<b>Time Range Name</b>	Tick the check box and enter the name of the Time Range settings that has been previously configured in the <b>Time Range Settings</b> window. This will set specific times when this access rule will be implemented on the Switch.
<b>Counter</b>	Use the drop-down menu to specify if the Counter feature should be <i>Enabled</i> or <i>Disabled</i> .
<b>Ports</b>	When a range of ports is to be configured, the Auto Assign check box <b>MUST</b> be ticked in the Access ID field of this window. If not, the user will be presented with an error message and the access rule will not be configured. Ticking the All Ports check box will denote all ports on the Switch.

Click **Apply** to implement the changes.

To view the settings of a previously correctly configured rule, click the corresponding **Show Details** button on the **Access Rule List** window to view the following window:

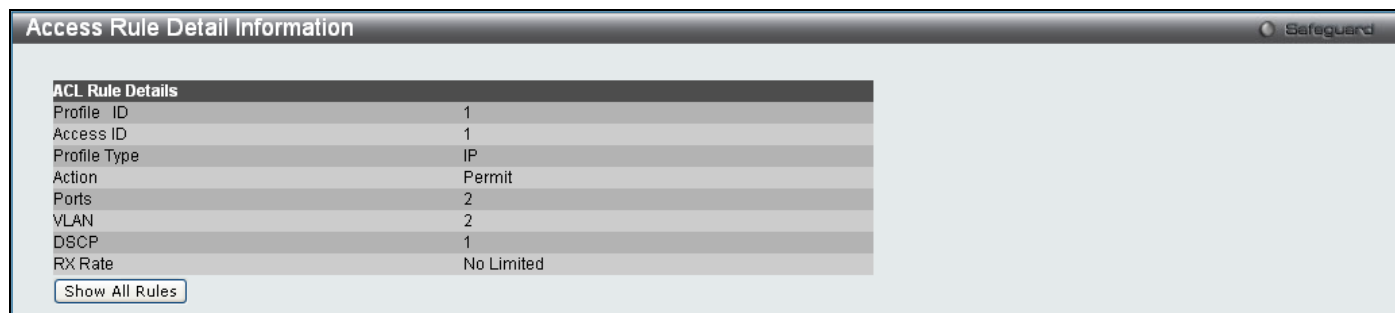

**Figure 7 - 16. Access Rule Detail Information window for IPv4**

*To establish the rule for a previously created Access Profile:*

To configure the Access Rules for IPv6, open the **Access Profile List** window and click **Add/View Rules** for an IPv6 entry. This will open the following window:



**Figure 7 - 17. Access Rule List window for IPv6**

To remove a previously created rule, click the corresponding **Delete Rules** button. To add a new Access Rule, click the **Add Rule** button:

Figure 7 - 18. Add Access Rule window for IPv6

The following parameters can be configured:

Parameter	Description
<b>Access ID (1-200)</b>	Type in a unique identifier number for this access. This value can be set from 1 to 200. Auto Assign – Ticking this check box will instruct the Switch to automatically assign an Access ID for the rule being created.
<b>Action</b>	Select <i>Permit</i> to specify that the packets that match the access rule are forwarded by the Switch, according to any additional rule added (see below). Select <i>Deny</i> to specify that packets that match the access rule are not forwarded by the Switch and will be filtered. Select <i>Mirror</i> to specify that packets that match the access rule are mirrored to a port defined in the config mirror port command. Port Mirroring must be enabled and a target port must be set.
<b>Priority (0-7)</b>	Tick the corresponding check box to re-write the 802.1p default priority of a packet to the value entered in the Priority field, which meets the criteria specified previously in this command, before forwarding it on to the specified CoS queue. Otherwise, a packet will have its incoming 802.1p user priority re-written to its original value before being forwarded by the Switch. For more information on priority queues, CoS queues and mapping for 802.1p, see the QoS section of this manual.
<b>Replace Priority</b>	Tick this check box to replace the Priority value in the adjacent field.
<b>Replace DSCP (0-63)</b>	Select this option to instruct the Switch to replace the DSCP value (in a packet that meets the selected criteria) with the value entered in the adjacent field. Note: When an ACL rule is added to change both the priority and DSCP of an IPv6 packet, only one of them can be modified due to a chip limitation. Currently the priority is changed when both the priority and DSCP are set to be modified.
<b>Class</b>	Use this option to specify the IPv6 class mask.
<b>RX Rate (1-15625)</b>	Use this to limit RX bandwidth for the profile being configured. This rate is implemented using the following equation: 1 value = 64kbit/sec. (ex. If the user selects an RX rate of 10 then the ingress rate is 640kbit/sec.) The user may select a value between 1 and 15625 or tick the <b>No Limit</b> check box. The default setting is No Limit.

<b>Time Range Name</b>	Tick the check box and enter the name of the Time Range settings that has been previously configured in the <b>Time Range Settings</b> window. This will set specific times when this access rule will be implemented on the Switch.
<b>Counter</b>	Use the drop-down menu to specify if the Counter feature should be <i>Enabled</i> or <i>Disabled</i> .
<b>Ports</b>	When a range of ports is to be configured, the Auto Assign check box <b>MUST</b> be ticked in the Access ID field of this window. If not, the user will be presented with an error message and the access rule will not be configured. Ticking the All Ports check box will denote all ports on the Switch.

Click **Apply** to implement the changes.

To view the settings of a previously correctly configured rule, click the corresponding **Show Details** button on the **Access Rule List** window to view the following window:

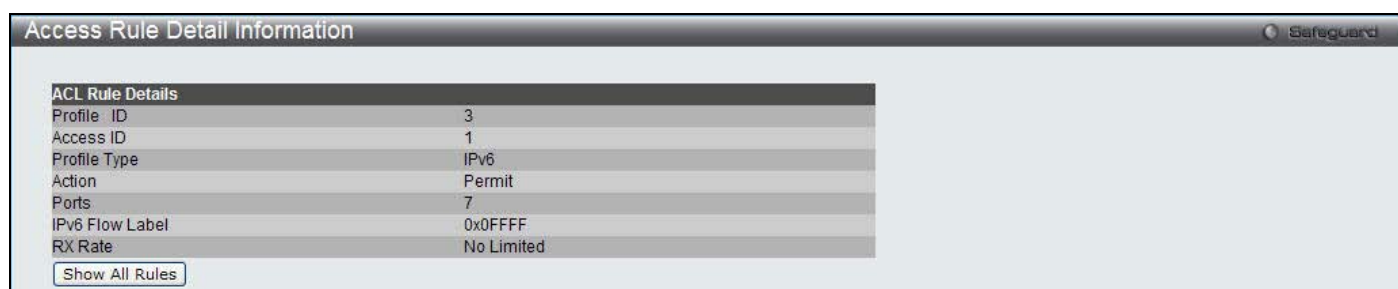

**Figure 7 - 19. Access Rule Detail Information window for IPv6**

*To establish the rule for a previously created Access Profile:*

To configure the Access Rules for Packet Content, open the **Access Profile List** window and click **Add/View Rules** for a Packet Content entry. This will open the following window:



**Figure 7 - 20. Access Rule List window for Packet Content**

To remove a previously created rule, click the corresponding **Delete Rules** button. To add a new Access Rule, click the **Add Rule** button:

**Add Access Rule** Safeguard

**Profile Information**

Profile ID: 4  
 Profile Type: Packet Content  
 Owner Type: ACL  
 Chunk 1: 10, Value: 0x00000000

---

**Rule Detail**  
 (Keep an input field as blank to treat the corresponding option as do not care)

Access ID (1-200):   Auto Assign  
 Action:    
 Priority (0-7):    
 Replace Priority:   
 Replace DSCP (0-63):    
 Chunk 1:    
 Chunk 2:    
 Chunk 3:    
 Chunk 4:    
 RX Rate (1-15625):    
 Time Range Name:    
 Counter:    
 Ports:   All Ports

**Figure 7 - 21. Add Access Rule window for Packet Content**

The following parameters can be configured:

Parameter	Description
<b>Access ID (1-200)</b>	Type in a unique identifier number for this access. This value can be set from 1 to 200. Auto Assign – Ticking this check box will instruct the Switch to automatically assign an Access ID for the rule being created.
<b>Action</b>	Select <i>Permit</i> to specify that the packets that match the access rule are forwarded by the Switch, according to any additional rule added (see below). Select <i>Deny</i> to specify that packets that match the access rule are not forwarded by the Switch and will be filtered. Select <i>Mirror</i> to specify that packets that match the access rule are mirrored to a port defined in the config mirror port command. Port Mirroring must be enabled and a target port must be set.
<b>Priority (0-7)</b>	Tick the corresponding check box if you want to re-write the 802.1p default priority of a packet to the value entered in the Priority field, which meets the criteria specified previously in this command, before forwarding it on to the specified CoS queue. Otherwise, a packet will have its incoming 802.1p user priority re-written to its original value before being forwarded by the Switch. For more information on priority queues, CoS queues and mapping for 802.1p, see the QoS section of this manual.
<b>Replace Priority</b>	Tick this check box to replace the Priority value in the adjacent field.
<b>Replace DSCP (0-63)</b>	Select this option to instruct the Switch to replace the DSCP value (in a packet that meets the selected criteria) with the value entered in the adjacent field. Note: When an ACL rule is added to change both the priority and DSCP of an IPv4 packet, only one of them can be modified due to a chip limitation. Currently the priority is changed when both the priority and DSCP are set to be modified.
<b>Chunk</b>	This field will instruct the Switch to mask the packet header beginning with the offset value specified.
<b>RX Rate (1-15625)</b>	Use this to limit RX bandwidth for the profile being configured. This rate is implemented using the following equation: 1 value = 64kbit/sec. (ex. If the user selects an RX rate of 10 then the ingress

	rate is 640kbit/sec.) The user may select a value between 1 and 15625 or tick the <b>No Limit</b> check box. The default setting is No Limit.
<b>Time Range Name</b>	Tick the check box and enter the name of the Time Range settings that has been previously configured in the <b>Time Range Settings</b> window. This will set specific times when this access rule will be implemented on the Switch.
<b>Counter</b>	Use the drop-down menu to specify if the Counter feature should be <i>Enabled</i> or <i>Disabled</i> .
<b>Ports</b>	When a range of ports is to be configured, the Auto Assign check box <b>MUST</b> be ticked in the Access ID field of this window. If not, the user will be presented with an error message and the access rule will not be configured. Ticking the All Ports check box will denote all ports on the Switch.

Click **Apply** to implement the changes.

To view the settings of a previously correctly configured rule, click the corresponding **Show Details** button on the **Access Rule List** window to view the following window:



Figure 7 - 22. Access Rule Detail Information window for Packet Content

## CPU Access Profile List

Due to a chipset limitation and needed extra switch security, the Switch incorporates CPU Interface filtering. This added feature increases the running security of the Switch by enabling the user to create a list of access rules for packets destined for the Switch's CPU interface. Employed similarly to the Access Profile feature previously mentioned, CPU interface filtering examines Ethernet, IP and Packet Content Mask packet headers destined for the CPU and will either forward them or filter them, based on the user's implementation. As an added feature for the CPU Filtering, the Switch allows the CPU filtering mechanism to be enabled or disabled globally, permitting the user to create various lists of rules without immediately enabling them.

Creating an access profile for the CPU is divided into two basic parts. The first is to specify which part or parts of a frame the Switch will examine, such as the MAC source address or the IP destination address. The second part is entering the criteria the Switch will use to determine what to do with the frame. The entire process is described below.

Users may globally enable or disable the CPU Interface Filtering State mechanism by using the radio buttons to change the running state. Choose Enabled to enable CPU packets to be scrutinized by the Switch and Disabled to disallow this scrutiny.

To view the following window, click **ACL > CPU Access Profile List**:

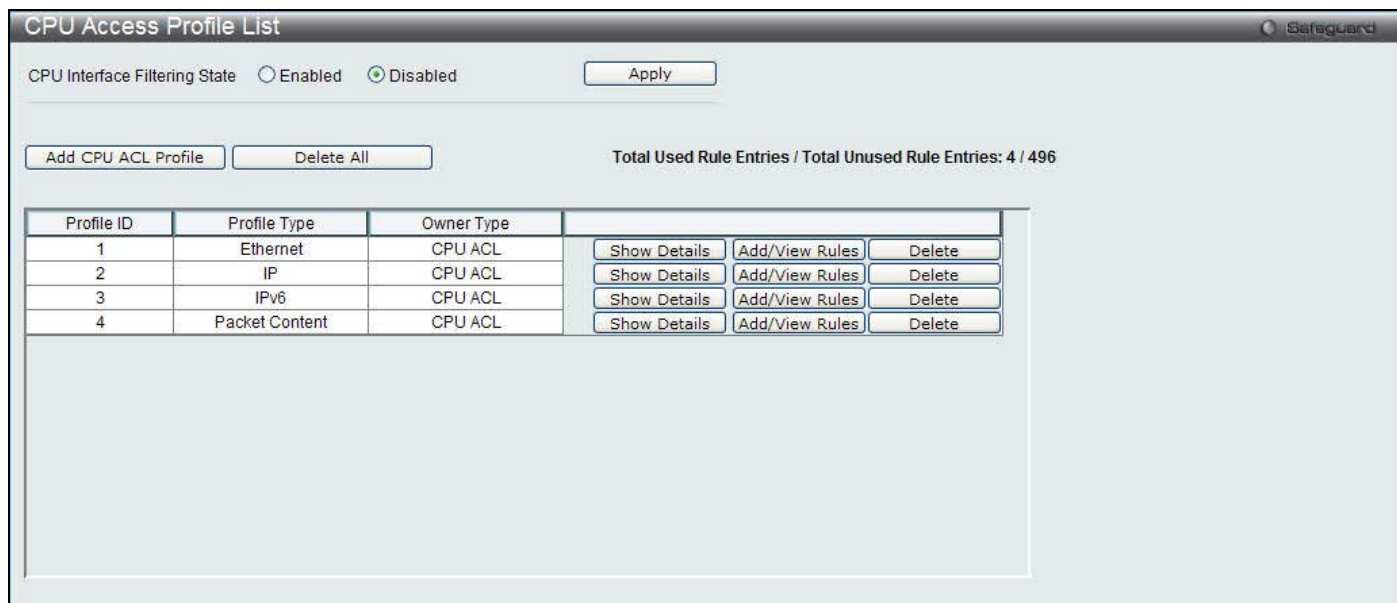

**Figure 7 - 23. CPU Access Profile List window**

This window displays the CPU Access Profile List entries created on the Switch (one CPU access profile of each type has been created for explanatory purposes). To view the configurations for an entry, click the corresponding **Show Details** button.

To add an entry to the CPU Access Profile List, click the **Add CPU ACL Profile** button. This will open the **Add CPU ACL Profile** window, as shown below. To remove all CPU Access Profile List entries, click the **Delete All** button.

The Switch supports four CPU Access Profile types: Ethernet (or MAC address-based) profile configuration, IP (IPv4) address-based profile configuration, IPv6 address-based profile configuration, and Packet Content Mask.

The window shown below is the **Add CPU ACL Profile** window for Ethernet.

Figure 7 - 24. Add CPU ACL Profile window for Ethernet

The following parameters can be configured:

Parameter	Description
<b>Select Profile ID (1-5)</b>	Use the drop-down menu to select a unique identifier number for this profile set. This value can be set from 1 to 5.
<b>Select ACL Type</b>	Select profile based on Ethernet (MAC Address), IPv4 address, IPv6 address, or packet content mask. This will change the window according to the requirements for the type of profile. Select Ethernet to instruct the Switch to examine the layer 2 part of each packet header. Select IPv4 to instruct the Switch to examine the IPv4 address in each frame's header. Select IPv6 to instruct the Switch to examine the IPv6 address in each frame's header. Select Packet Content Mask to specify a mask to examine the content of the packet header.
<b>Source MAC Mask</b>	Enter a MAC address mask for the source MAC address.
<b>Destination MAC Mask</b>	Enter a MAC address mask for the destination MAC address.
<b>802.1Q VLAN</b>	Selecting this option instructs the Switch to examine the VLAN identifier of each packet header and use this as the full or partial criterion for forwarding.
<b>802.1p</b>	Selecting this option instructs the Switch to specify that the access profile will apply only to packets with this 802.1p priority value.
<b>Ethernet Type</b>	Selecting this option instructs the Switch to examine the Ethernet type value in each frame's header.

Click **Create** to implement the changes.

To view the settings of a previously correctly created profile, click the corresponding **Show Details** button on the **CPU Access Profile List** window to view the following window:

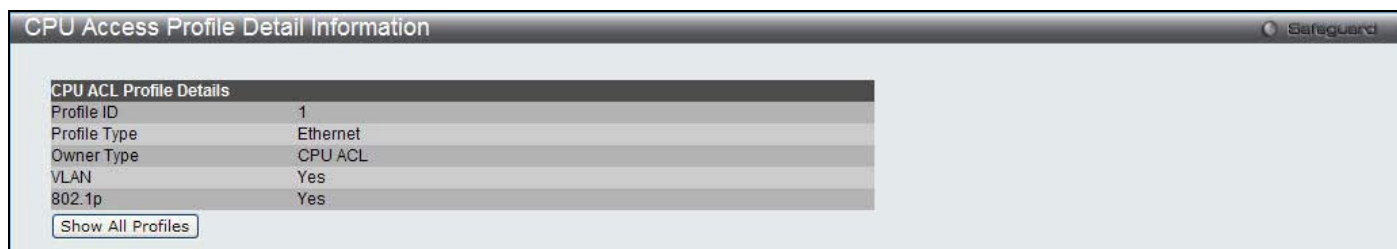

**Figure 7 - 25. CPU Access Profile Detail Information window for Ethernet**

The window shown below is the **Add CPU ACL Profile** window for IPv4.

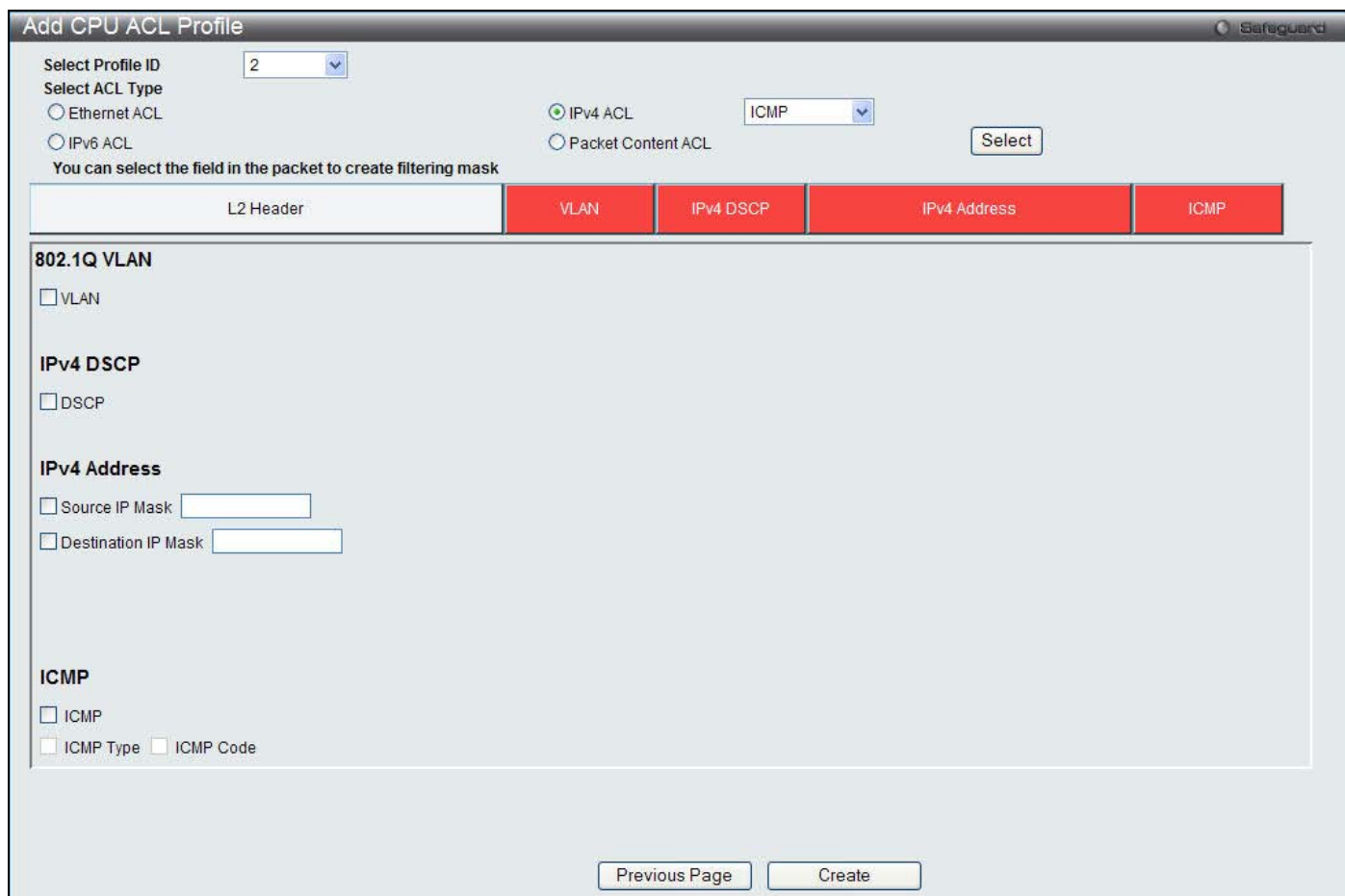

**Figure 7 - 26. Add CPU ACL Profile window for IPv4**

The following parameters can be configured:

Parameter	Description
<b>Select Profile ID</b>	Use the drop-down menu to select a unique identifier number for this profile set. This value can be set from 1 to 5.
<b>Select ACL Type</b>	Select profile based on Ethernet (MAC Address), IPv4 address, IPv6 address, or packet content mask. This will change the menu according to the requirements for the type of profile. Select Ethernet to instruct the Switch to examine the layer 2 part of each packet header. Select IPv4 to instruct the Switch to examine the IPv4 address in each frame's header. Select IPv6 to instruct the Switch to examine the IPv6 address in each frame's header. Select Packet Content Mask to specify a mask to examine the content of the packet header.



<b>802.1Q VLAN</b>	Selecting this option instructs the Switch to examine the VLAN part of each packet header and use this as the, or part of the criterion for forwarding.
<b>IPv4 DSCP</b>	Selecting this option instructs the Switch to examine the DiffServ Code part of each packet header and use this as the, or part of the criterion for forwarding.
<b>Source IP Mask</b>	Enter an IP address mask for the source IP address.
<b>Destination IP Mask</b>	Enter an IP address mask for the destination IP address.
<b>Protocol</b>	<p>Selecting this option instructs the Switch to examine the protocol type value in each frame's header. You must then specify what protocol(s) to include according to the following guidelines:</p> <p>Select <i>ICMP</i> to instruct the Switch to examine the Internet Control Message Protocol (ICMP) field in each frame's header.</p> <ul style="list-style-type: none"> <li>Select <i>Type</i> to further specify that the access profile will apply an ICMP type value, or specify <i>Code</i> to further specify that the access profile will apply an ICMP code value.</li> </ul> <p>Select <i>IGMP</i> to instruct the Switch to examine the Internet Group Management Protocol (IGMP) field in each frame's header.</p> <ul style="list-style-type: none"> <li>Select <i>Type</i> to further specify that the access profile will apply an IGMP type value.</li> </ul> <p>Select <i>TCP</i> to use the TCP port number contained in an incoming packet as the forwarding criterion. Selecting TCP requires a source port mask and/or a destination port mask is to be specified. The user may also identify which flag bits to filter. Flag bits are parts of a packet that determine what to do with the packet. The user may filter packets by filtering certain flag bits within the packets, by checking the boxes corresponding to the flag bits of the TCP field. The user may choose between urg (urgent), ack (acknowledgement), psh (push), rst (reset), syn (synchronize), fin (finish).</p> <ul style="list-style-type: none"> <li><i>src port mask</i> - Specify a TCP port mask for the source port in hex form (hex 0x0-0xffff), which you wish to filter.</li> <li><i>dst port mask</i> - Specify a TCP port mask for the destination port in hex form (hex 0x0-0xffff) which you wish to filter.</li> </ul> <p>Select <i>UDP</i> to use the UDP port number contained in an incoming packet as the forwarding criterion. Selecting UDP requires that you specify a source port mask and/or a destination port mask.</p> <ul style="list-style-type: none"> <li><i>src port mask</i> - Specify a UDP port mask for the source port in hex form (hex 0x0-0xffff).</li> <li><i>dst port mask</i> - Specify a UDP port mask for the destination port in hex form (hex 0x0-0xffff).</li> </ul> <p><i>Protocol ID</i> - Enter a value defining the protocol ID in the packet header to mask. Specify the protocol ID mask in hex form (hex 0x0-0xff).</p>

Click **Create** to implement the changes.

To view the settings of a previously correctly created profile, click the corresponding **Show Details** button on the **CPU Access Profile List** window to view the following window:

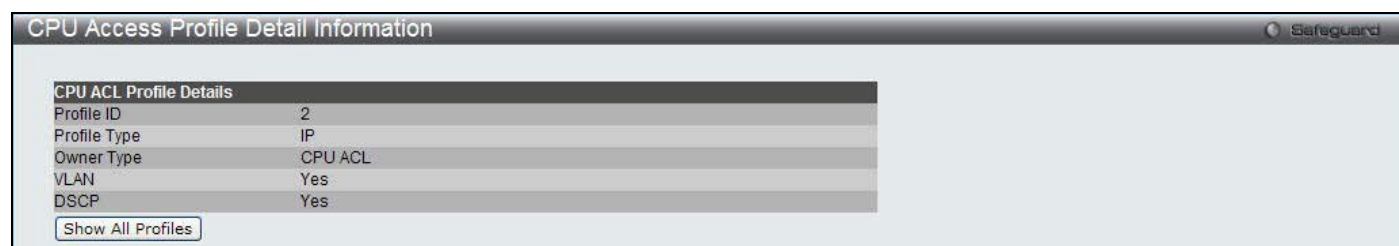

**Figure 7 - 27. CPU Access Profile Detail Information window for IPv4**

The window shown below is the **Add CPU ACL Profile** window for IPv6.

Figure 7 - 28. Add CPU ACL Profile window for IPv6

The following parameters can be configured:

Parameter	Description
<b>Select Profile ID</b>	Use the drop-down menu to select a unique identifier number for this profile set. This value can be set from 1 to 5.
<b>Select ACL Type</b>	Select profile based on Ethernet (MAC Address), IPv4 address, IPv6 address, or packet content mask. This will change the menu according to the requirements for the type of profile. Select Ethernet to instruct the Switch to examine the layer 2 part of each packet header. Select IPv4 to instruct the Switch to examine the IPv4 address in each frame's header. Select IPv6 to instruct the Switch to examine the IPv6 address in each frame's header. Select Packet Content Mask to specify a mask to examine the content of the packet header.
<b>IPv6 Class</b>	Checking this field will instruct the Switch to examine the <i>class</i> field of the IPv6 header. This class field is a part of the packet header that is similar to the Type of Service (ToS) or Precedence bits field in IPv4.
<b>IPv6 Flow Label</b>	Checking this field will instruct the Switch to examine the <i>flow label</i> field of the IPv6 header. This flow label field is used by a source to label sequences of packets such as non-default quality of service or real time service packets.
<b>IPv6 Source Address</b>	The user may specify an IP address mask for the source IPv6 address by checking the corresponding box and entering the IP address mask.
<b>IPv6 Destination Address</b>	The user may specify an IP address mask for the destination IPv6 address by checking the corresponding box and entering the IP address mask.

Click **Create** to implement the changes.

To view the settings of a previously correctly created profile, click the corresponding **Show Details** button on the **CPU Access Profile List** window to view the following window:

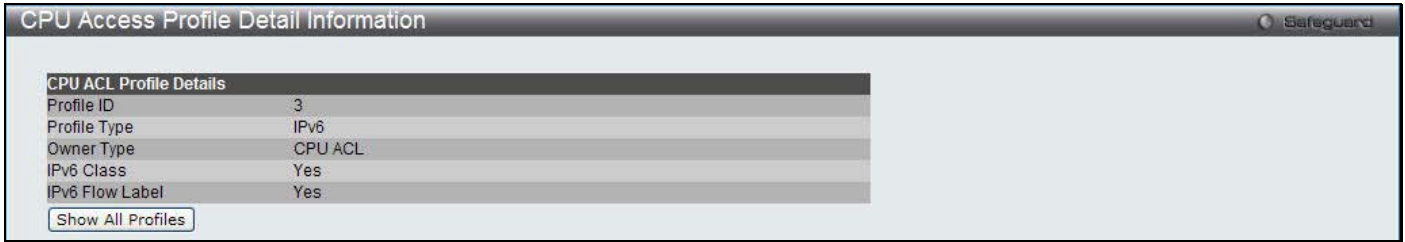

**Figure 7 - 29. CPU Access Profile Detail Information window for IPv6**

The window shown below is the **Add CPU ACL Profile** window for Packet Content.

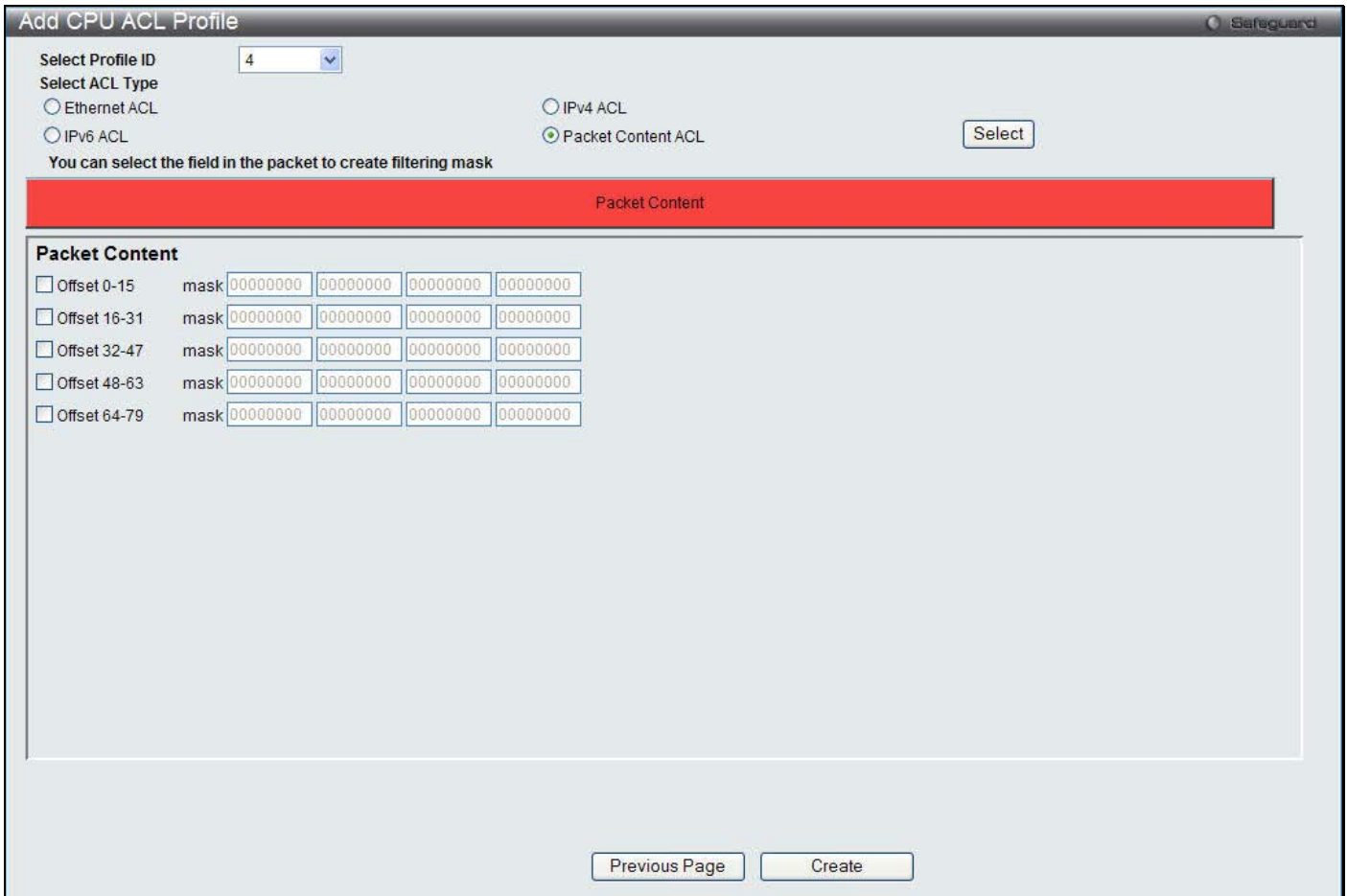

**Figure 7 - 30. Add CPU ACL Profile window for Packet Content**

The following parameters can be configured:

Parameter	Description
<b>Select Profile ID</b>	Use the drop-down menu to select a unique identifier number for this profile set. This value can be set from 1 to 5.
<b>Select ACL Type</b>	Select profile based on Ethernet (MAC Address), IPv4 address, IPv6 address, or packet content mask. This will change the menu according to the requirements for the type of profile. Select Ethernet to instruct the Switch to examine the layer 2 part of each packet header. Select IPv4 to instruct the Switch to examine the IPv4 address in each frame's header. Select IPv6 to instruct the Switch to examine the IPv6 address in each frame's header. Select Packet Content Mask to specify a mask to examine the content of the packet header.

<b>Offset</b>	<p>This field will instruct the Switch to mask the packet header beginning with the offset value specified:</p> <ul style="list-style-type: none"> <li>• 0-15 - Enter a value in hex form to mask the packet from the beginning of the packet to the 15th byte.</li> <li>• 16-31 – Enter a value in hex form to mask the packet from byte 16 to byte 31.</li> <li>• 32-47 – Enter a value in hex form to mask the packet from byte 32 to byte 47.</li> <li>• 48-63 – Enter a value in hex form to mask the packet from byte 48 to byte 63.</li> <li>• 64-79 – Enter a value in hex form to mask the packet from byte 64 to byte 79.</li> </ul>
---------------	--

Click **Create** to implement the changes.

To view the settings of a previously correctly created profile, click the corresponding **Show Details** button on the **CPU Access Profile List** window to view the following window:



**Figure 7 - 31. CPU Access Profile Detail Information window for Packet Content**

*To establish the rule for a previously created CPU Access Profile:*

To configure the Access Rules for Ethernet, open the **CPU Access Profile List** window and click **Add/View Rules** for an Ethernet entry. This will open the following window.



**Figure 7 - 32. CPU Access Rule List window for Ethernet**

To remove a previously created rule, click the corresponding **Delete Rules** button. To add a new Access Rule, click the **Add Rule** button:

Figure 7 - 33. Add Access Rule window for Ethernet

The following parameters can be configured:

Parameter	Description
<b>Access ID (1-100)</b>	Type in a unique identifier number for this access. This value can be set from 1 to 100.
<b>Action</b>	Select <i>Permit</i> to specify that the packets that match the access rule are forwarded by the Switch, according to any additional rule added (see below). Select <i>Deny</i> to specify that packets that match the access rule are not forwarded by the Switch and will be filtered.
<b>Ethernet Type (0-FFFF)</b>	Enter the appropriate Ethernet Type information.
<b>Time Range Name</b>	Tick the check box and enter the name of the Time Range settings that has been previously configured in the <b>Time Range Settings</b> window. This will set specific times when this access rule will be implemented on the Switch.
<b>Ports</b>	Ticking the <b>All Ports</b> check box will denote all ports on the Switch.

Click **Apply** to implement the changes.

To view the settings of a previously correctly configured rule, click the corresponding **Show Details** button on the **CPU Access Rule List** window to view the following window:



Figure 7 - 34. CPU Access Rule Detail Information window for Ethernet

To establish the rule for a previously created CPU Access Profile:

To configure the Access Rules for IP, open the **CPU Access Profile List** window and click **Add/View Rules** for an IPv4 entry. This will open the following window.



Figure 7 - 35. CPU Access Rule List window for IPv4

To remove a previously created rule, click the corresponding **Delete Rules** button. To add a new Access Rule, click the **Add Rule** button:

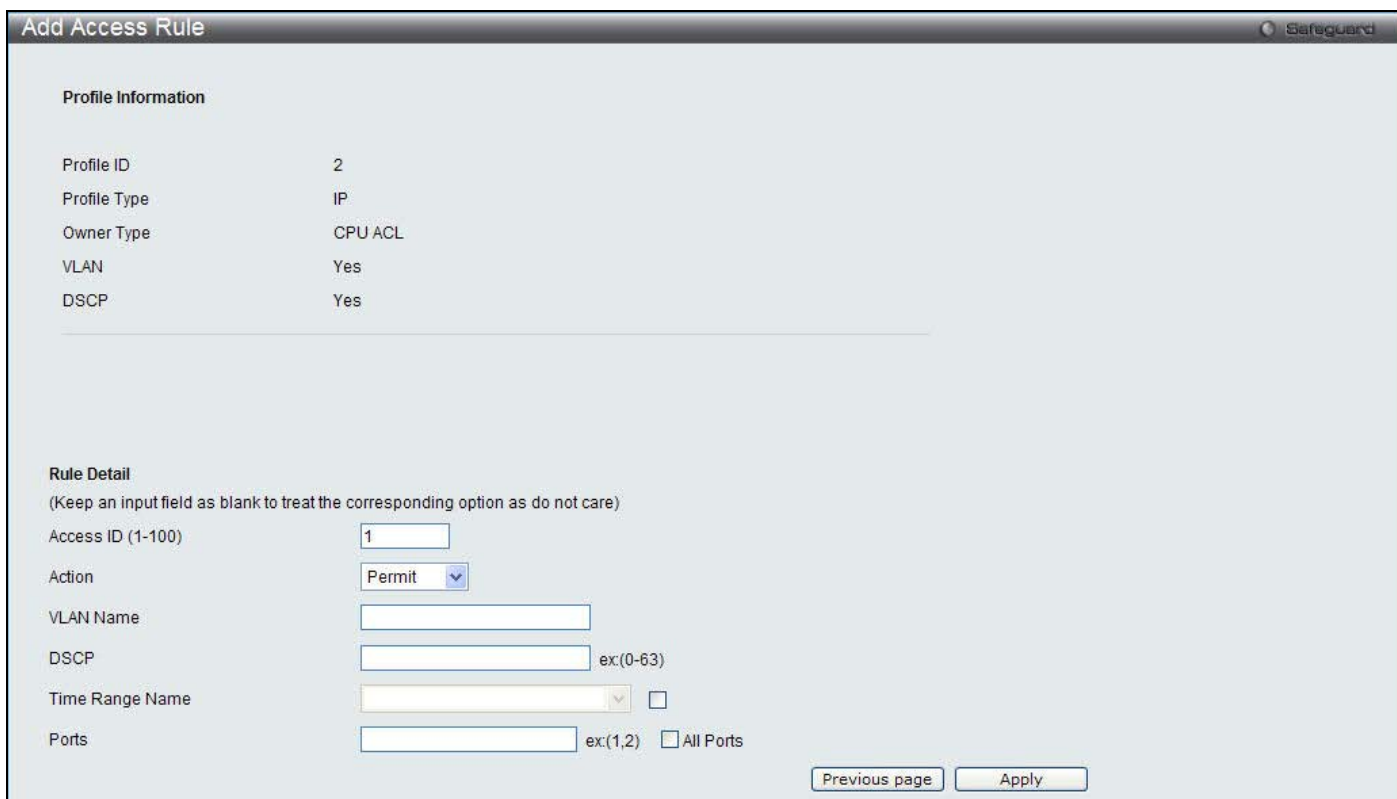

Figure 7 - 36. Add Access Rule window for IPv4

The following parameters can be configured:

Parameter	Description
<b>Access ID (1-100)</b>	Type in a unique identifier number for this access. This value can be set from 1 to 100.
<b>Action</b>	Select <i>Permit</i> to specify that the packets that match the access rule are forwarded by the Switch, according to any additional rule added (see below). Select <i>Deny</i> to specify that packets that match the access rule are not forwarded by the Switch and will be filtered.
<b>VLAN Name</b>	Allows the entry of a name for a previously configured VLAN.
<b>Time Range Name</b>	Tick the check box and enter the name of the Time Range settings that has been previously configured in the <b>Time Range Settings</b> window. This will set specific times when this access rule will be implemented on the Switch.
<b>Ports</b>	Ticking the All Ports check box will denote all ports on the Switch.

Click **Apply** to implement the changes.

To view the settings of a previously correctly configured rule, click the corresponding **Show Details** button on the **CPU Access Rule List** window to view the following window:

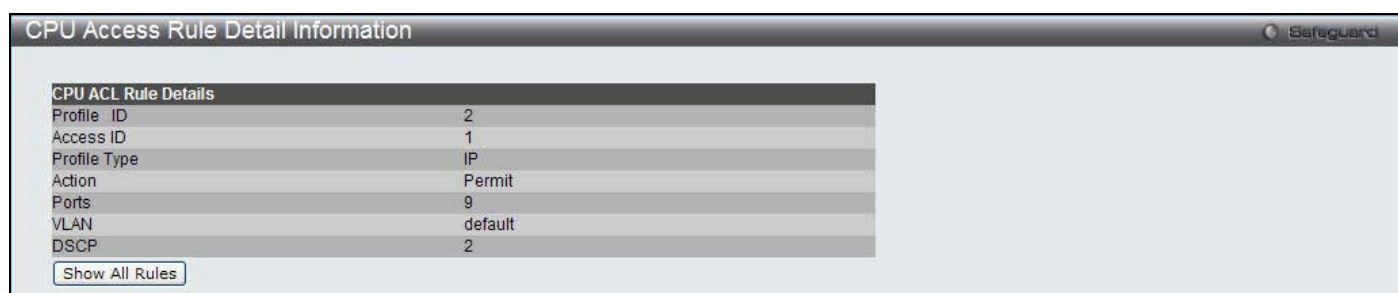

Figure 7 - 37. CPU Access Rule Detail Information window for IPv4

*To establish the rule for a previously created CPU Access Profile:*

To configure the Access Rules for IP, open the **CPU Access Profile List** window and click **Add/View Rules** for an IPv6 entry. This will open the following window.



Figure 7 - 38. CPU Access Rule List window for IPv6

To remove a previously created rule, click the corresponding **Delete Rules** button. To add a new Access Rule, click the **Add Rule** button:

Figure 7 - 39. Add Access Rule window for IPv6

The following parameters can be configured:

Parameter	Description
<b>Access ID (1-100)</b>	Type in a unique identifier number for this access. This value can be set from 1 to 100.
<b>Action</b>	Select <i>Permit</i> to specify that the packets that match the access rule are forwarded by the Switch, according to any additional rule added (see below). Select <i>Deny</i> to specify that packets that match the access rule are not forwarded by the Switch and will be filtered.
<b>Flow Label</b>	Configuring this field, in hex form, will instruct the Switch to examine the flow label field of the IPv6 header. This flow label field is used by a source to label sequences of packets such as non-default quality of service or real time service packets.
<b>Time Range Name</b>	Tick the check box and enter the name of the Time Range settings that has been previously configured in the <b>Time Range Settings</b> window. This will set specific times when this access rule will be implemented on the Switch.
<b>Ports</b>	Ticking the All Ports check box will denote all ports on the Switch.

Click **Apply** to implement the changes.

To view the settings of a previously correctly configured rule, click the corresponding **Show Details** button on the **CPU Access Rule List** window to view the following window:

Figure 7 - 40. CPU Access Rule Detail Information window for IPv6



To establish the rule for a previously created CPU Access Profile:

To configure the Access Rules for IP, open the **CPU Access Profile List** window and click **Add/View Rules** for a Packet Content entry. This will open the following window.



Figure 7 - 41. CPU Access Rule List window for Packet Content

To remove a previously created rule, click the corresponding **Delete Rules** button. To add a new Access Rule, click the **Add Rule** button:

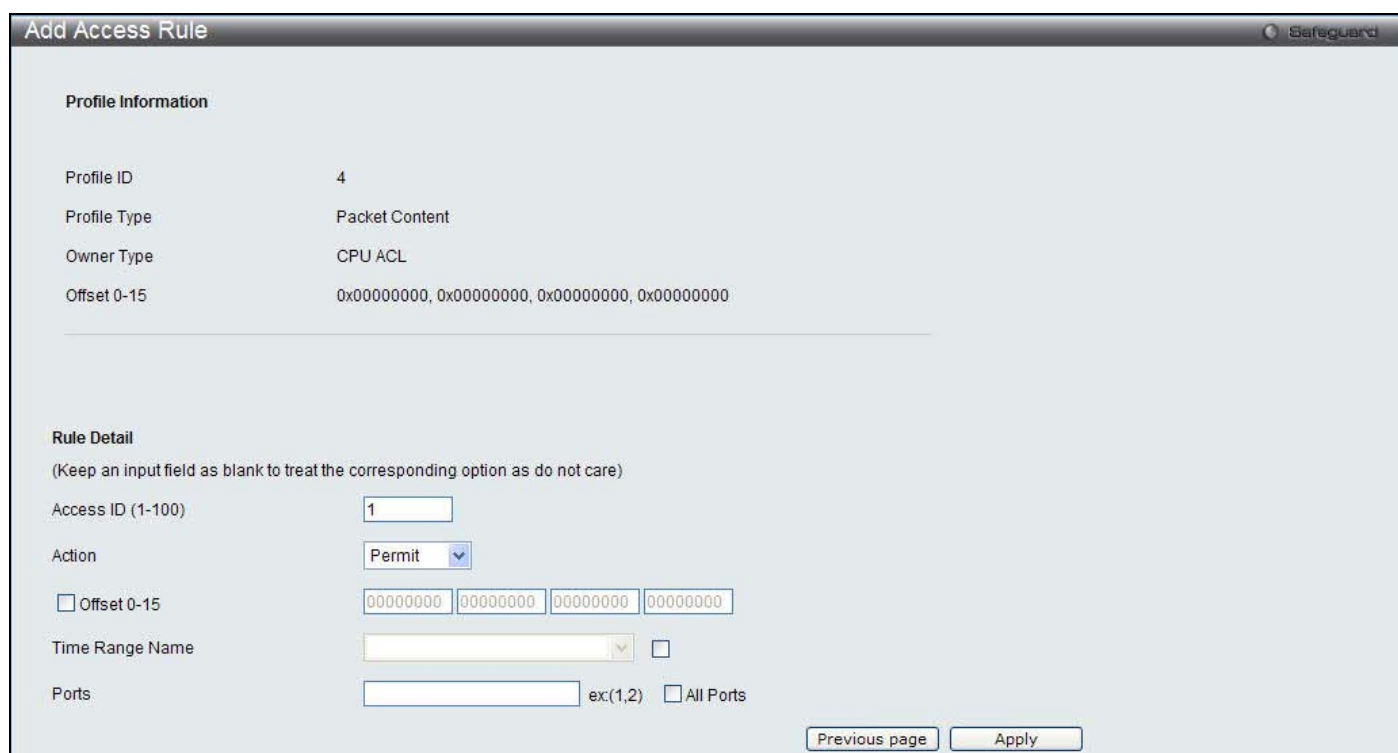

Figure 7 - 42. Add Access Rule window for Packet Content

The following parameters can be configured:

Parameter	Description
<b>Access ID (1-100)</b>	Type in a unique identifier number for this access. This value can be set from 1 to 100.
<b>Action</b>	Select <i>Permit</i> to specify that the packets that match the access rule are forwarded by the Switch, according to any additional rule added (see below). Select <i>Deny</i> to specify that packets that match the access rule are not forwarded by the Switch and will be filtered.
<b>Offset</b>	This field will instruct the Switch to mask the packet header beginning with the offset value specified: Offset 0-15 - Enter a value in hex form to mask the packet from the beginning of the packet to the 15th byte. Offset 16-31 - Enter a value in hex form to mask the packet from byte 16 to byte 31. Offset 32-47 - Enter a value in hex form to mask the packet from byte 32 to byte 47.

	Offset 48-63 - Enter a value in hex form to mask the packet from byte 48 to byte 63. Offset 64-79 - Enter a value in hex form to mask the packet from byte 64 to byte 79.
<b>Time Range Name</b>	Tick the check box and enter the name of the Time Range settings that has been previously configured in the <b>Time Range Settings</b> window. This will set specific times when this access rule will be implemented on the Switch.
<b>Ports</b>	Ticking the All Ports check box will denote all ports on the Switch.

Click **Apply** to implement the changes.

To view the settings of a previously correctly configured rule, click the corresponding **Show Details** button on the **CPU Access Rule List** window to view the following window:

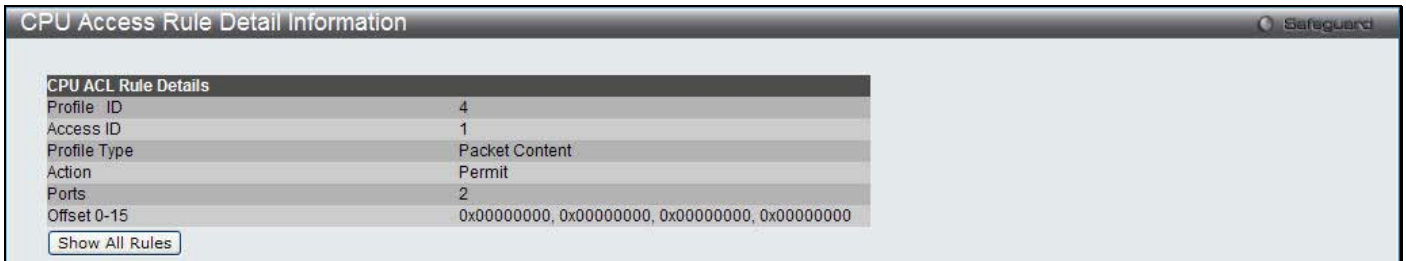

Figure 7 - 43. CPU Access Rule Detail Information window for Packet Content

## Time Range Settings

In conjunction with the Access Profile feature, the time range settings determine a starting point and an ending point, based on days of the week, when an Access Profile configuration will be enabled on the Switch. Once configured here, the time range settings are to be applied to an access profile rule using the Access Profile table. The user may enter up to 64 time range entries on the Switch.

To view the following window, click **ACL > Time Range Settings**:



Figure 7 - 44. Time Range Settings window

The user may adjust the following parameters to configure a time range on the Switch:

Parameter	Description
<b>Range Name</b>	Enter a name of no more than 32 alphanumeric characters that will be used to identify this time range on the Switch. This range name will be used in the Access Profile table to identify the access profile and associated rule to be enabled during this time range.
<b>Hours</b>	This parameter is used to set the time in the day that this time range is to be enabled using the following parameters: <ul style="list-style-type: none"> <li><i>Start Time</i> - Use this parameter to identify the starting time of the time range, in hours, minutes and seconds, based on the 24-hour time system.</li> <li><i>End Time</i> - Use this parameter to identify the ending time of the time range, in hours,</li> </ul>

	minutes and seconds, based on the 24-hour time system.
<b>Weekdays</b>	Use the check boxes to select the corresponding days of the week that this time range is to be enabled. Tick the Select All Days check box to configure this time range for every day of the week.

Click **Apply** to implement changes made. Currently configured entries will be displayed in the **Time Range Information** table in the bottom half of the window shown above.

# Network Application

- DHCP/BOOTP Relay**
- DHCPv6 Relay**
- DHCP Server**
- DHCP Local Relay Settings**
- DHCP Auto Configuration Settings**
- DHCP Option 12 Settings**
- DNS Resolver**
- PPPoE Circuit ID Insertions Settings**
- SMTP Settings**
- SNTP Settings**
- Ping Test**

## DHCP/BOOTP Relay

The **DHCP/BOOTP Relay** folder contains two windows: **DHCP/BOOTP Relay Global Settings** and **DHCP/BOOTP Relay Interface Settings**.

### DHCP/BOOTP Relay Global Settings

Users can enable and configure DHCP/BOOTP Relay Global Settings. The relay hops count limit allows the maximum number of hops (routers) that the DHCP/BOOTP messages can be relayed through to be set. If a packet’s hop count is more than the hop count limit, the packet is dropped. The range is between 1 and 16 hops, with a default value of 4. The relay time threshold sets the minimum time (in seconds) that the Switch will wait before forwarding a BOOTREQUEST packet. If the value in the seconds field of the packet is less than the relay time threshold, the packet will be dropped. The range is between 0 and 65,535 seconds, with a default value of 0 seconds.

To view the following window, click **Network Application > DHCP/BOOTP Relay > DHCP/BOOTP Relay Global Settings**:

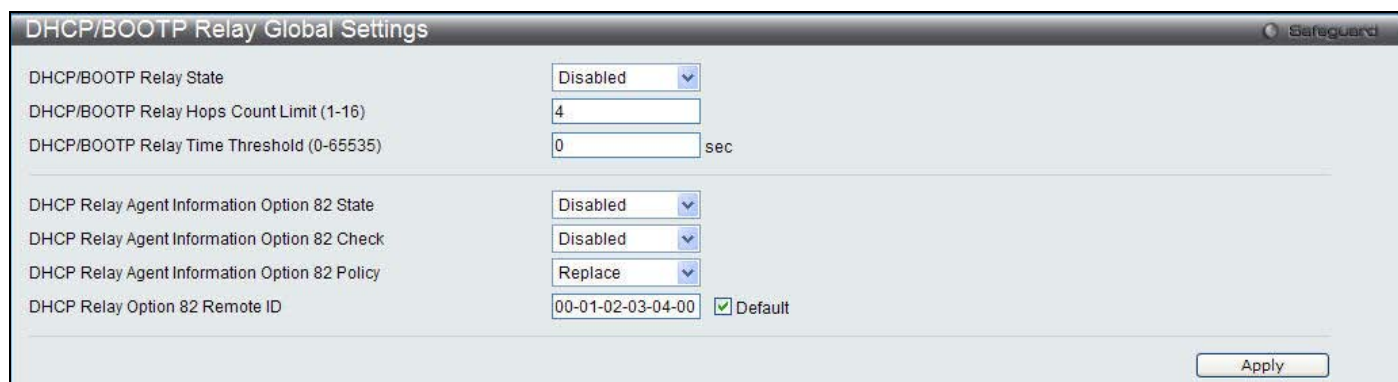

Figure 8 - 1. DHCP/BOOTP Relay Global Settings window

The following parameters may be configured:

Parameter	Description
<b>DHCP/BOOTP Relay State</b>	This field can be toggled between <i>Enabled</i> and <i>Disabled</i> using the drop-down menu. It is used to enable or disable the DHCP/BOOTP Relay service on the Switch. The default is <i>Disabled</i> .

<b>DHCP/BOOTP Relay Hops Count Limit (1-16)</b>	This field allows an entry between 1 and 16 to define the maximum number of router hops DHCP/BOOTP messages can be forwarded. The default hop count is 4.
<b>DHCP/BOOTP Relay Time Threshold (0-65535)</b>	Allows an entry between 0 and 65535 seconds, and defines the maximum time limit for routing a DHCP/BOOTP packet. If a value of 0 is entered, the Switch will not process the value in the seconds field of the BOOTP or DHCP packet. If a non-zero value is entered, the Switch will use that value, along with the hop count to determine whether to forward a given BOOTP or DHCP packet.
<b>DHCP Relay Agent Information Option 82 State</b>	<p>This field can be toggled between <i>Enabled</i> and <i>Disabled</i> using the drop-down menu. It is used to enable or disable the DHCP Relay Agent Information Option 82 on the Switch. The default is <i>Disabled</i>.</p> <p><i>Enabled</i> –When this field is toggled to <i>Enabled</i>, the relay agent will insert and remove DHCP relay information (option 82 field) in messages between DHCP servers and clients. When the relay agent receives the DHCP request, it adds the option 82 information, and the IP address of the relay agent (if the relay agent is configured), to the packet. Once the option 82 information has been added to the packet it is sent on to the DHCP server. When the DHCP server receives the packet, if the server is capable of option 82, it can implement policies like restricting the number of IP addresses that can be assigned to a single remote ID or circuit ID. Then the DHCP server echoes the option 82 field in the DHCP reply. The DHCP server unicasts the reply back to the relay agent if the request was relayed to the server by the relay agent. The switch verifies that it originally inserted the option 82 data. Finally, the relay agent removes the option 82 field and forwards the packet to the switch port that connects to the DHCP client that sent the DHCP request.</p> <p><i>Disabled</i>- When the field is toggled to <i>Disabled</i>, the relay agent will not insert and remove DHCP relay information (option 82 field) in messages between DHCP servers and clients, and the check and policy settings will have no effect.</p>
<b>DHCP Relay Agent Information Option 82 Check</b>	<p>This field can be toggled between <i>Enabled</i> and <i>Disabled</i> using the drop-down menu. It is used to enable or disable the Switches ability to check the validity of the packet's option 82 field.</p> <p><i>Enabled</i> – When the field is toggled to <i>Enabled</i>, the relay agent will check the validity of the packet's option 82 field. If the switch receives a packet that contains the option 82 field from a DHCP client, the switch drops the packet because it is invalid. In packets received from DHCP servers, the relay agent will drop invalid messages.</p> <p><i>Disabled</i> – When the field is toggled to <i>Disabled</i>, the relay agent will not check the validity of the packet's option 82 field.</p>
<b>DHCP Relay Agent Information Option 82 Policy</b>	<p>This field can be toggled between <i>Replace</i>, <i>Drop</i>, and <i>Keep</i> by using the drop-down menu. It is used to set the Switches policy for handling packets when the DHCP Relay Agent Information Option 82 Check is set to <i>Disabled</i>. The default is <i>Replace</i>.</p> <p><i>Replace</i> – The option 82 field will be replaced if the option 82 field already exists in the packet received from the DHCP client.</p> <p><i>Drop</i> – The packet will be dropped if the option 82 field already exists in the packet received from the DHCP client.</p> <p><i>Keep</i> – The option 82 field will be retained if the option 82 field already exists in the packet received from the DHCP client.</p>
<b>DHCP Relay Option 82 Remote ID</b>	Enter the DHCP Relay Agent Information Option 82 Remote ID.

Click **Apply** to implement any changes that have been made.



**NOTE:** If the Switch receives a packet that contains the option 82 field from a DHCP client and the information-checking feature is enabled, the Switch drops the packet because it is invalid. However, in some instances, users may configure a client with the option 82 field. In this situation, disable the information check feature so that the Switch does not remove the option 82 field from the packet. Users may configure the action that the Switch takes when it receives a packet with existing option 82 information by configuring the DHCP Agent Information Option 82 Policy.

## Implementation of DHCP Relay Agent Information Option 82

The `config dhcp_relay option_82` command configures the DHCP relay agent information option 82 setting of the Switch. The formats for the circuit ID sub-option and the remote ID sub-option are as follows:



**NOTE:** For the circuit ID sub-option of a standalone switch, the module field is always zero.

### Circuit ID sub-option format:

1.	2.	3.	4.	5.	6.	7.
1	6	0	4	VLAN	Module	Port
1 byte	1 byte	1 byte	1 byte	2 bytes	1 byte	1 byte

1. Sub-option type
2. Length
3. Circuit ID type
4. Length
5. VLAN: the incoming VLAN ID of DHCP client packet.
6. Module: For a standalone switch, the Module is always 0; for a stackable switch, the Module is the Unit ID.
7. Port: The incoming port number of the DHCP client packet, the port number starts from 1.

### Remote ID sub-option format:

1.	2.	3.	4.	5.
2	8	0	6	MAC address
1 byte	1 byte	1 byte	1 byte	6 bytes

1. Sub-option type
2. Length
3. Remote ID type
4. Length
5. MAC address: The Switch's system MAC address.

**Figure 8 - 2. Circuit ID and Remote ID Sub-option Format**

## DHCP/BOOTP Relay Interface Settings

Users can set up a server, by IP address, for relaying DHCP/BOOTP information to the Switch. The user may enter a previously configured IP interface on the Switch that will be connected directly to the DHCP/BOOTP server using this window. Properly configured settings will be displayed in the DHCP/BOOTP Relay Interface Table at the bottom of the window, once the user clicks the **Apply** button. The user may add up to four server IPs per IP interface on the Switch. Entries may be deleted by clicking the corresponding **Delete** button.

To view the following window, click **Network Application > DHCP/BOOTP Relay > DHCP/BOOTP Relay Interface Settings**:

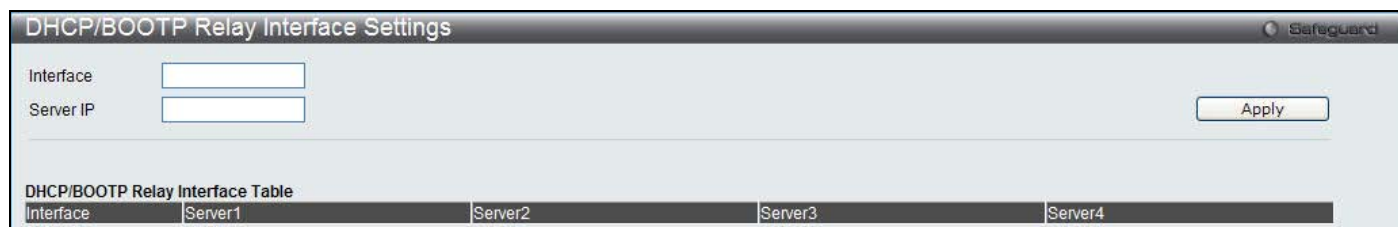

Figure 8 - 3. DHCP/BOOTP Relay Interface Settings window

The following parameters may be configured:

Parameter	Description
<b>Interface</b>	The IP interface on the Switch that will be connected directly to the Server.
<b>Server IP</b>	Enter the IP address of the DHCP/BOOTP server. Up to four server IPs can be configured per IP Interface.

Click **Apply** to include this Server IP.

## DHCPv6 Relay

### DHCPv6 Relay Global Settings

This window is used to configure the DHCPv6 relay function on the Switch.

To view the following window, click **Network Application > DHCPv6 Relay > DHCPv6 Relay Global Settings**:

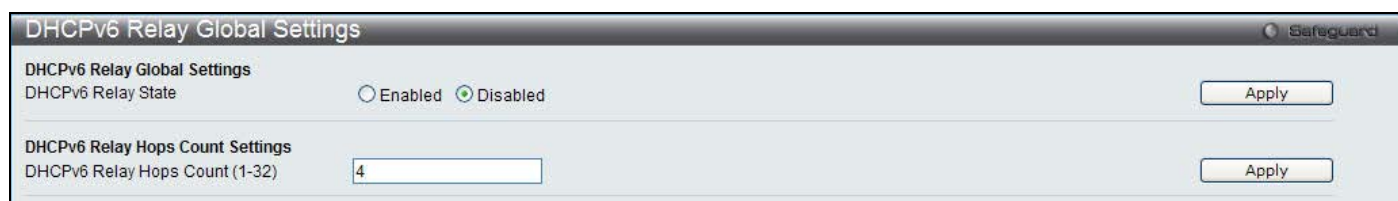

Figure 8 - 4. DHCPv6 Relay Global Settings window

The following parameters may be configured:

Parameter	Description
<b>DHCPv6 Relay State</b>	Click the radio buttons to enable or disable the DHCPv6 relay function.
<b>DHCPv6 Relay Hops Count (1-32)</b>	Enter the number of relay agents that have to be relayed in this message. The default value is 4.

Click the **Apply** button to accept the changes made for each individual section.

## DHCPv6 Relay Settings

This window is used to configure the DHCPv6 relay state of one or all of the specified interfaces, and add or display a destination IPv6 address to or from the switch's DHCPv6 relay table.

To view the following window, click **Network Application > DHCPv6 Relay > DHCPv6 Relay Settings**:

**Figure 8 - 5. DHCPv6 Relay Settings window**

The following parameters may be configured:

Parameter	Description
<b>Interface Name</b>	Enter the name of the IPv6 interface. Tick the <b>All</b> check box to select all IPv6 interfaces.
<b>DHCPv6 Relay State</b>	Use the drop-down menu to enable or disable the DHCPv6 relay state of the interface.
<b>DHCPv6 Server Address</b>	Enter the DHCPv6 server IPv6 address.

Click the **Apply** button to accept the changes made. Click the **Add** button to add a new entry based on the information entered. Click the **Find** button to locate a specific entry based on the information entered. Click the **View All** button to display all the existing entries.

## DHCP Server

DHCP, or Dynamic Host Configuration Protocol, allows the switch to delegate IP addresses, subnet masks, default gateways and other IP parameters to devices that request this information. This occurs when a DHCP enabled device is booted on or attached to the locally attached network. This device is known as the DHCP client and when enabled, it will emit query messages on the network before any IP parameters are set. When the DHCP server receives this request, it returns a response to the client, containing the previously mentioned IP information that the DHCP client then utilizes and sets on its local configurations.

The user can configure many DHCP related parameters that it will utilize on its locally attached network, to control and limit the IP settings of clients desiring an automatic IP configuration, such as the lease time of the allotted IP address, the range of IP addresses that will be allowed in its DHCP pool, the ability to exclude various IP addresses within the pool so as not to make identical entries on its network, or to assign the IP address of an important device (such as a DNS server or the IP address of the default route) to another device on the network.

Users also have the ability to bind IP addresses within the DHCP pool to specific MAC addresses in order to keep consistent the IP addresses of devices that may be important to the upkeep of the network that require a static IP address.



## DHCP Server Global Settings

This window is used to configure the DHCP server global parameters.

To view the following window, click **Network Application > DHCP Server > DHCP Server Global Settings**:

Figure 8 - 6. DHCP Server Global Settings window

The following parameters may be configured:

Parameter	Description
<b>DHCP Server State</b>	Click the radio buttons to enable or disable the DHCP Server State.
<b>Ping Packets (0-10)</b>	Enter the numbers of ping packet that the Switch will send out on the network containing the IP address to be allotted. If the ping request is not returned, the IP address is considered unique to the local network and then allotted to the requesting client. 0 means there is no ping test. The default value is 2.
<b>Ping Timeout (10-2000)</b>	Enter the amount of time the DHCP server must waits before timing out a ping packet. The default value is 100.

Click the **Apply** button to accept the changes made for each individual section.

## DHCP Server Exclude Address Settings

The DHCP server assumes that all IP addresses in a DHCP pool subnet are available for assigning to DHCP clients. You must use this page to specify the IP address that the DHCP server should not assign to clients. This command can be used multiple times in order to define multiple groups of excluded addresses.

To view the following window, click **Network Application > DHCP Server > DHCP Server Exclude Address Settings**:

Figure 8 - 7. DHCP Server Exclude Address Settings window

The following parameters may be configured:

Parameter	Description
<b>Begin Address</b>	Enter the starting IP Address.
<b>End Address</b>	Enter the ending IP Address.

Click the **Add** button to add a new entry based on the information entered. Click the **Delete All** button to remove all the entries listed. Click the **Delete** button to remove the specific entry.

## DHCP Server Pool Settings

This window is used to add and delete the DHCP server pool.

To view the following window, click **Network Application > DHCP Server > DHCP Server Pool Settings**:

Figure 8 - 8. DHCP Server Pool Settings window

The following parameters may be configured:

Parameter	Description
Pool Name	Enter the DHCP Server Pool name.

Click the **Add** button to add a new entry based on the information entered. Click the **Delete All** button to remove all the entries listed. Click the **Edit** button to re-configure the specific entry. Click the **Delete** button to remove the specific entry.

Click the **Edit** button to see the following window:

Figure 8 - 9. DHCP Server Pool Settings – Edit window

The following parameters may be configured:

Parameter	Description
IP Address	Enter the network address of the pool.
Netmask	Enter the Netmask for the network address.
NetBIOS Node Type	NetBIOS node type for a Microsoft DHCP client.
Domain Name	Domain name of client. The domain name configured here will be used as the default domain name by the client.
Boot File	File name of boot image. The boot file is used to store the boot image for the client. The boot image is generally the operating system the client uses to load. If this option is input twice for

	the same pool, the second command will overwrite the first command. If the boot file is not specified, the boot file information will not be provided to the client.
<b>Next Server</b>	Enter the next server IP address.
<b>DNS Server Address</b>	IP address of DNS server. Specifies the IP address of a DNS server that is available to a DHCP client. Up to three IP addresses can be specified in one command line.
<b>NetBIOS Name Server</b>	IP address of WINS server. Windows Internet Naming Service (WINS) is a name resolution service that Microsoft DHCP clients use to correlate host names to IP addresses within a general grouping of networks. Up to three IP addresses can be specified in one command line.
<b>Default Router</b>	IP address of default router. Specifies the IP address of the default router for a DHCP client. Up to three IP addresses can be specified in one command line.
<b>Pool Lease</b>	By default, each IP address assigned by a DHCP server comes with a one-day lease, which is the amount of time that the address is valid. Tick the <b>Infinite</b> check box to have infinite lease. <i>Days</i> – Days of lease. <i>Hours</i> – Hours of lease. <i>Minutes</i> – Minutes of lease

Click the **Apply** button to accept the changes made. Click the <<**Back** button to discard the changes made and return to the previous page.

## DHCP Server Manual Binding

An address binding is a mapping between the IP address and MAC address of a client. The IP address of a client can be assigned manually by an administrator or assigned automatically from a pool by a DHCP server. The dynamic binding entry will be created when an IP address is assigned to the client from the pool network's address.

To view the following window, click **Network Application > DHCP Server > DHCP Server Manual Binding**:

**Figure 8 - 10. DHCP Server Manual Binding window**

The following parameters may be configured:

Parameter	Description
<b>Pool Name</b>	Enter the DHCP Server Pool name.
<b>IP Address</b>	IP address which will be assigned to specified client.
<b>Hardware Address</b>	Enter the hardware address.
<b>Type</b>	Either Ethernet or IEEE802 can be specified.

Click the **Add** button to add a new entry based on the information entered. Click the **Delete All** button to remove all the entries listed. Click the **Delete** button to remove the specific entry.

## DHCP Server Dynamic Binding

This window is used to delete the DHCP server dynamic binding table.

To view the following window, click **Network Application > DHCP Server > DHCP Server Dynamic Binding**:



Figure 8 - 11. DHCP Server Dynamic Binding window

The following parameters may be configured:

Parameter	Description
Pool Name	Enter the DHCP Server Pool name.

Click the **Clear** button to clear all the information entered in the fields. Click the **Clear All** button to remove all the entries listed in the table.

## DHCP Conflict IP

The DHCP server will use PING packet to determine whether an IP address is conflict with other host before binding this IP. The IP address which has been identified conflict will be moved to the conflict IP database. The system will not attempt to bind the IP address in the conflict IP database unless the user clears it from the conflict IP database.

To view the following window, click **Network Application > DHCP Server > DHCP conflict IP**:



Figure 8 - 12. DHCP Conflict IP window

Click the **Clear All** button to remove all the entries listed in the table.

## DHCP Local Relay Settings

The DHCP local relay settings allows the user to add option 82 into DHCP request packets when the DHCP client gets an IP address from the same VLAN. If the DHCP local relay settings are not configured, the Switch will flood the packets to the VLAN. In order to add option 82 into the DHCP request packets, the DHCP local relay settings and the state of the Global VLAN need to be enabled.

To view the following window, click **Network Application > DHCP Local Relay Settings**:



Figure 8 - 13. DHCP Local Relay Settings window

The following parameters may be configured or viewed:

Parameter	Description
<b>DHCP Local Relay Global State</b>	Enable or disable the DHCP Local Relay Global State. The default is Disabled.
<b>VLAN Name</b>	This is the VLAN Name that identifies the VLAN the user wishes to apply the DHCP Local Relay operation.
<b>State</b>	Enable or disable the Config DHCP Local Relay for VLAN state.
<b>DHCP/BOOTP Local Relay VID List</b>	This is a list of VLAN IDs the user wishes to apply the DHCP/BOOTP Local Relay operations.

Click **Apply** to implement the new DHCP Local Relay Settings.

## DHCP Auto Configuration Settings

This window is used to enable the DHCP auto configuration feature on the Switch. When enabled, the Switch is instructed to receive a configuration file from a TFTP server, which will set the Switch to become a DHCP client automatically on boot-up. To employ this method, the DHCP server must be set up to deliver the TFTP server IP address and configuration file name information in the DHCP reply packet. The TFTP server must be up and running and hold the necessary configuration file stored in its base directory when the request is received from the Switch. For more information about loading a configuration file for use by a client, see the DHCP server and/or TFTP server software instructions. The user may also consult the **Upload Log File** window description located in the **Tools** section of this manual.

If the Switch is unable to complete the DHCP auto configuration, the previously saved configuration file present in the Switch's memory will be used.

To view the following window, click **Network Application > DHCP Auto Configuration Settings**:

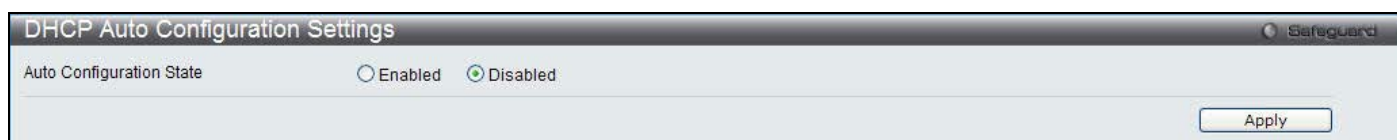

Figure 8 - 14. DHCP Auto Configuration Settings window

The following parameter may be configured or viewed:

Parameter	Description
<b>Auto Configuration State</b>	Enable or disable the Switch's DHCP auto configuration feature. When enabled, the Switch is instructed to receive a configuration file from a TFTP server, which will set the Switch to become a DHCP client automatically on boot-up. To employ this method, the DHCP server must be set up to deliver the TFTP server IP address and configuration file name information in the DHCP reply packet. The TFTP server must be up and running and hold the necessary configuration file

stored in its base directory when the request is received from the Switch.

Click **Apply** to set the DHCP Auto Configuration State.

## DHCP Option 12 Settings

This window is used to configure DHCP Option 12 settings.

To view the following window, click **Network Application > DHCP Option 12 Settings**:

Figure 8 - 15. DHCP Option 12 Settings window

The following parameter may be configured:

Parameter	Description
<b>DHCP Option 12 State</b>	Click the radio buttons to enable or disable the DHCP Option 12 state.
<b>DHCP Option 12 Host Name</b>	Specify the host name to be inserted in the DHCPDISCOVER and DHCPREQUEST message. The specified host name must start with a letter, end with a letter or digit, and have only letters, digits, and hyphen as interior characters; the maximum length is 63.

Click **Apply** to implement the changes. Click **Clear Host Name** to clear the hostname setting.

## DNS Resolver

### DNS Resolver Global Settings

This window is used to configure the DNS Resolver global state of the Switch.

To view the following window, click **Network Application > DNS Resolver > DNS Resolver Global Settings**:

Figure 8 - 16. DNS Resolver Global Settings window

The following parameter may be configured:

Parameter	Description
<b>DNS Resolver State</b>	Click the radio buttons to enable or disable the DNS resolver state.
<b>Name Server Timeout (1-60)</b>	The maximum time waiting for a response from a specified name server.

Click **Apply** to implement the changes.

## DNS Resolver Static Name Server Settings

The window is used to create the DNS Resolver name server of the Switch.

To view the following window, click **Network Application > DNS Resolver > DNS Resolver Static Name Server Settings**:



Figure 8 - 17. DNS Resolver Static Name Server Settings window

The following parameter may be configured:

Parameter	Description
Server IP Address	Enter a DNS Resolver name server. Tick the <b>Primary</b> check box to set the name server as a primary name server.

Click the **Add** button to add a new entry based on the information entered. Click the **Delete** button to remove the specific entry.

## DNS Resolver Dynamic Name Server Table

This window displays the current DNS Resolver name servers.

To view the following window, click **Network Application > DNS Resolver > DNS Resolver Dynamic Name Server Table**:



Figure 8 - 18. DNS Resolver Dynamic Name Server Table window

## DNS Resolver Static Host Name Settings

The window is used to create the static host name entry of the switch.

To view the following window, click **Network Application > DNS Resolver > DNS Resolver Static Host Name Settings**:



Figure 8 - 19. DNS Resolver Static Host Name Settings window

The following parameter may be configured:

Parameter	Description
Host Name	Enter the name of the host.
IP Address	Enter the IP address of the host.

Click the **Add** button to add a new entry based on the information entered. Click the **Delete** button to remove the specific entry.

## DNS Resolver Dynamic Host Name Table

This window displays the current host name entries.

To view the following window, click **Network Application > DNS Resolver > DNS Resolver Dynamic Host Name Table**:

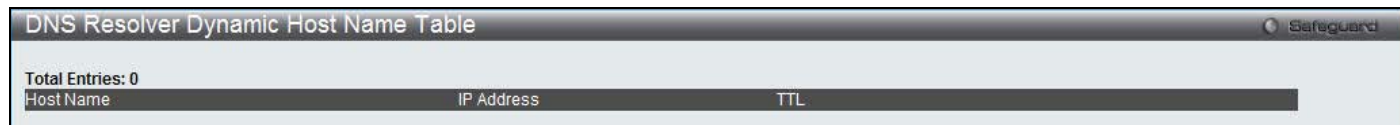

Figure 8 - 20. DNS Resolver Dynamic Host Name Table window

## PPPoE Circuit ID Insertions Settings

This window is used to configure the PPPoE circuit ID insertion function.

To view the following window, click **Network Application > PPPoE Circuit ID Insertions Settings**:

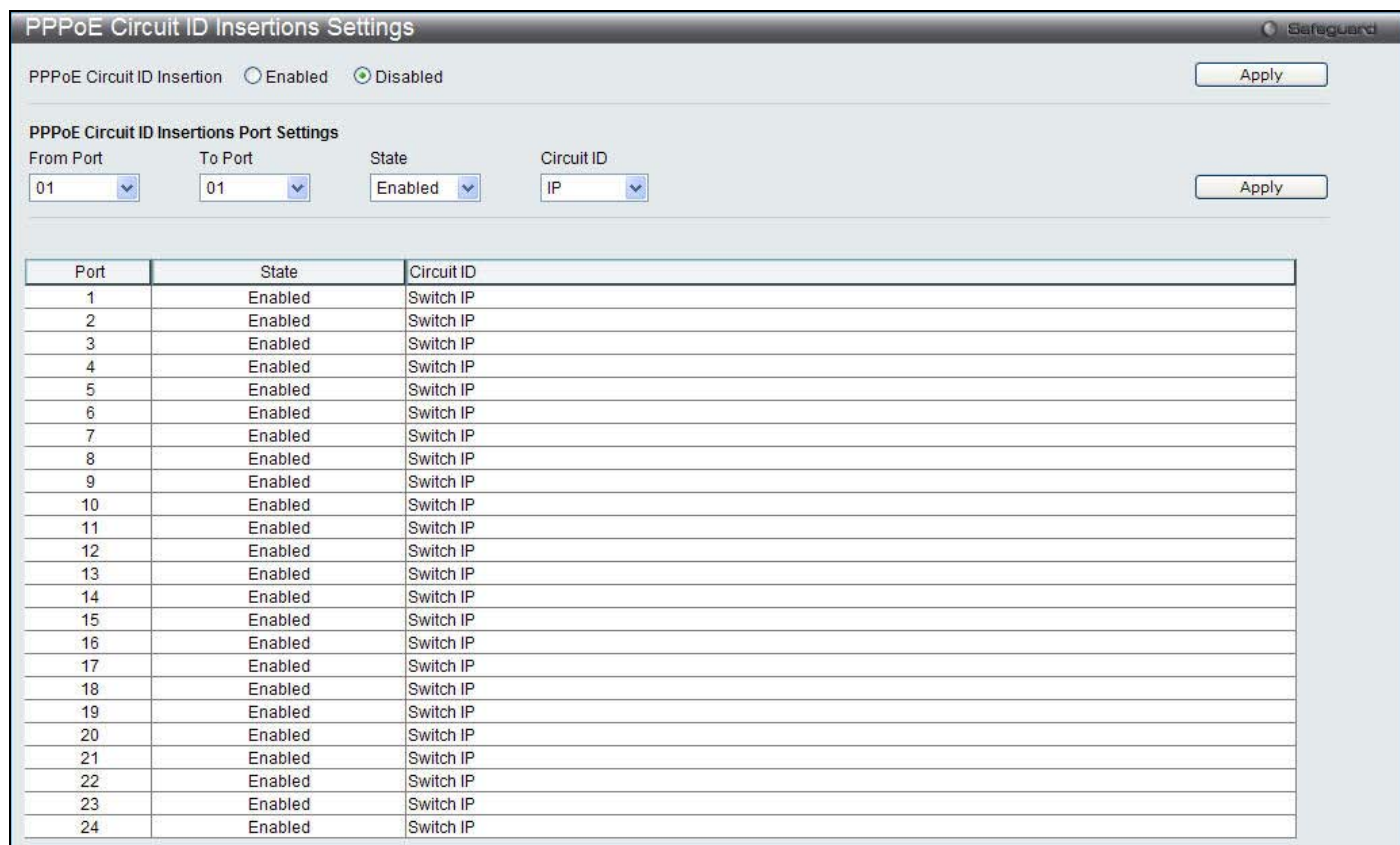

Figure 8 - 21. PPPoE circuit ID Insertions Settings window

The following parameter may be configured:

Parameter	Description
<b>PPPoE circuit ID Insertion</b>	Click the radio buttons to enable or disable the PPPoE circuit ID insertion on the Switch.
<b>From Port / To Port</b>	Use the drop-down menus to select a range of ports to be configured.
<b>State</b>	Use the drop-down menu to enable or disable port's PPPoE circuit ID insertion function.
<b>Circuit ID</b>	Use the drop-down menu to select the device ID part for encoding of the circuit ID option.



*MAC* - The MAC address of the Switch will be used to encode the circuit ID option.  
*IP* - The Switch's IP address will be used to encode the circuit ID option. This is the default.  
*UDF* - A user specified string to be used to encode the circuit ID option. The maximum length is 32.

Click the **Apply** button to accept the changes made for each individual section.

## SMTP Settings

SMTP or Simple Mail Transfer Protocol is a function of the Switch that will send switch events to mail recipients based on e-mail addresses entered in the window below. The Switch is to be configured as a client of SMTP while the server is a remote device that will receive messages from the Switch, place the appropriate information into an e-mail and deliver it to recipients configured on the Switch. This can benefit the Switch administrator by simplifying the management of small workgroups or wiring closets, increasing the speed of handling emergency Switch events, and enhancing security by recording questionable events occurring on the Switch.

Users can set up the SMTP server for the Switch, along with setting e-mail addresses to which switch log files can be sent when a problem arises on the Switch.

To view the following window, click **Network Application > SMTP Settings**:

**Figure 8 - 22. SMTP Settings window**

The following parameters may be configured or viewed:

Parameter	Description
<b>SMTP State</b>	Use the radio button to enable or disable the SMTP service on this device.
<b>SMTP Server Address</b>	Enter the IP address of the SMTP server on a remote device. This will be the device that sends out the mail for you.
<b>SMTP Server Port (1-65535)</b>	Enter the virtual port number that the Switch will connect with on the SMTP server. The common port number for SMTP is 25, yet a value between 1 and 65535 can be chosen.
<b>Self Mail Address</b>	Enter the e-mail address from which mail messages will be sent. This address will be the “from” address on the e-mail message sent to a recipient. Only one self-mail address can be configured for this Switch. This string can be no more that 64 alphanumeric characters.
<b>Add A Mail Receiver</b>	Enter an e-mail address and click the <b>Add</b> button. Up to eight e-mail addresses can be added per Switch. To delete these addresses from the Switch, click the corresponding <b>Delete</b> button in the SMTP Mail Receiver Address table at the bottom of the window.

Click **Apply** to implement the changes.

## SNTP Settings

SNTP or Simple Network Time Protocol is used by the Switch to synchronize the clock of the computer.

## Time Settings

Users can configure the time settings for the Switch.

To view the following window, click **Network Application > SNTP Settings > Time Settings**:

Figure 8 - 23. Time Settings window

The following parameters can be set or are displayed:

Parameter	Description
<b>Status</b>	
<b>SNTP State</b>	Use this radio button to enable or disable SNTP.
<b>Current Time</b>	Displays the Current Time.
<b>Time Source</b>	Displays the time source for the system.
<b>SNTP Settings</b>	
<b>SNTP First Server</b>	The IP address of the primary server from which the SNTP information will be taken.
<b>SNTP Second Server</b>	The IP address of the secondary server from which the SNTP information will be taken.
<b>SNTP Poll Interval In Seconds (30-99999)</b>	The interval, in seconds, between requests for updated SNTP information.
<b>Set Current Time</b>	
<b>Date (DD/MM/YYYY)</b>	Enter the current day, month, and year to update the system clock.
<b>Time (HH:MM:SS)</b>	Enter the current time in hours, minutes, and seconds.

Click **Apply** to implement your changes.

## Time Zone Settings

Users can configure time zones and Daylight Savings Time settings for SNTP.

To view the following window, click **Network Application > SNTP Settings > Time Zone Settings**:

**Time Zone Settings** Safeguard

Daylight Saving Time State: Disabled

Daylight Saving Time Offset In Minutes: 60

Time Zone Offset from GMT In +/-HH:MM: + 00 00

---

**DST Repeating Settings**

From: Which Week Of The Month: First

From: Day Of Week: Sun

From: Month: Apr

From: Time In HH MM: 00 00

To: Which Week Of The Month: Last

To: Day Of Week: Sun

To: Month: Oct

To: Time In HH MM: 00 00

---

**DST Annual Settings**

From: Month: Apr

From: Day: 29

From: Time In HH MM: 00 00

To: Month: Oct

To: Day: 12

To: Time In HH MM: 00 00

**Figure 8 - 24. Time Zone Settings window**

The following parameters can be set:

Parameter	Description
<b>Daylight Saving Time State</b>	Use this drop-down menu to enable or disable the DST Settings.
<b>Daylight Saving Time Offset In Minutes</b>	Use this drop-down menu to specify the amount of time that will constitute your local DST offset. The available options are 30, 60, 90, or 120 minutes.
<b>Time Zone Offset From GMT In +/- HH:MM</b>	Use these drop-down menus to specify your local time zone's offset from Greenwich Mean Time (GMT.)

<b>DST Repeating Settings</b> – Using repeating mode will enable DST seasonal time adjustment. Repeating mode requires that the DST beginning and ending date be specified using a formula. For example, specify to begin DST on Saturday during the second week of April and end DST on Sunday during the last week of October.	
<b>From: Which Week Of The Month</b>	Enter the week of the month that DST will start.
<b>From: Day Of Week</b>	Enter the day of the week that DST will start on.
<b>From: Month</b>	Enter the month DST will start on.
<b>From: Time In HH:MM</b>	Enter the time of day that DST will start on.
<b>To: Which Week Of The Month</b>	Enter the week of the month the DST will end.
<b>To: Day Of Week</b>	Enter the day of the week that DST will end.
<b>To: Month</b>	Enter the month that DST will end.
<b>To: Time In HH:MM</b>	Enter the time DST will end.

<b>DST Annual Settings</b> – Using annual mode will enable DST seasonal time adjustment. Annual mode requires that the DST beginning and ending date be specified concisely. For example, specify to begin DST on April 3 and end DST on October 14.	
<b>From: Month</b>	Enter the month DST will start on, each year.
<b>From: Day</b>	Enter the day of the month DST will start on, each year.
<b>From: Time In HH:MM</b>	Enter the time of day DST will start on, each year.
<b>To: Month</b>	Enter the month DST will end on, each year.
<b>To: Day</b>	Enter the day of the month DST will end on, each year.
<b>To: Time In HH:MM</b>	Enter the time of day that DST will end on, each year.

Click **Apply** to implement changes made to this window.

## Ping Test

Users can Ping either an IPv4 address or an IPv6 address. Ping is a small program that sends ICMP Echo packets to the IP address you specify. The destination node then responds to or “echoes” the packets sent from the Switch. This is very useful to verify connectivity between the Switch and other nodes on the network.

To view the following window, click **Network Application > Ping Test**:

**Figure 2 - 66. Ping Test window**

The user may click the Infinite times radio button, in the Repeat Pinging for field, which will tell the ping program to keep sending ICMP Echo packets to the specified IP address until the program is stopped. The user may opt to choose a specific number of times to ping the Target IP Address by clicking its radio button and entering a number between 1 and 255. Click **Start** to initiate the Ping program.

The following parameters may be configured or viewed:

Parameter	Description
<b>Target IP Address</b>	Enter an IP address to be Pinged.
<b>Interface Name</b>	For IPv6 only, enter the name of the interface to be Pinged.
<b>Repeat Pinging for</b>	Enter the number of times desired to attempt to Ping either the IPv4 address or the IPv6 address configured in this window. Users may enter a number of times between 1 and 255.

<b>Size</b>	For IPv6 only, enter a value between <i>1</i> and <i>6000</i> . The default is <i>100</i> .
<b>Timeout</b>	For IPv4, select a timeout period between <i>1</i> and <i>99</i> seconds for this Ping message to reach its destination. For IPv6, select a timeout period between <i>1</i> and <i>10</i> seconds for this Ping message to reach its destination. In either case, if the packet fails to find the IP address in this specified time, the Ping packet will be dropped.

Click **Start** to initialize the Ping program.

# OAM

*Ethernet OAM*

*DULD Settings*

*Cable Diagnostics*

## Ethernet OAM

### Ethernet OAM Settings

This window is used to configure the Ethernet OAM settings.

To view the following window, click **OAM > Ethernet OAM > Ethernet OAM Settings**:

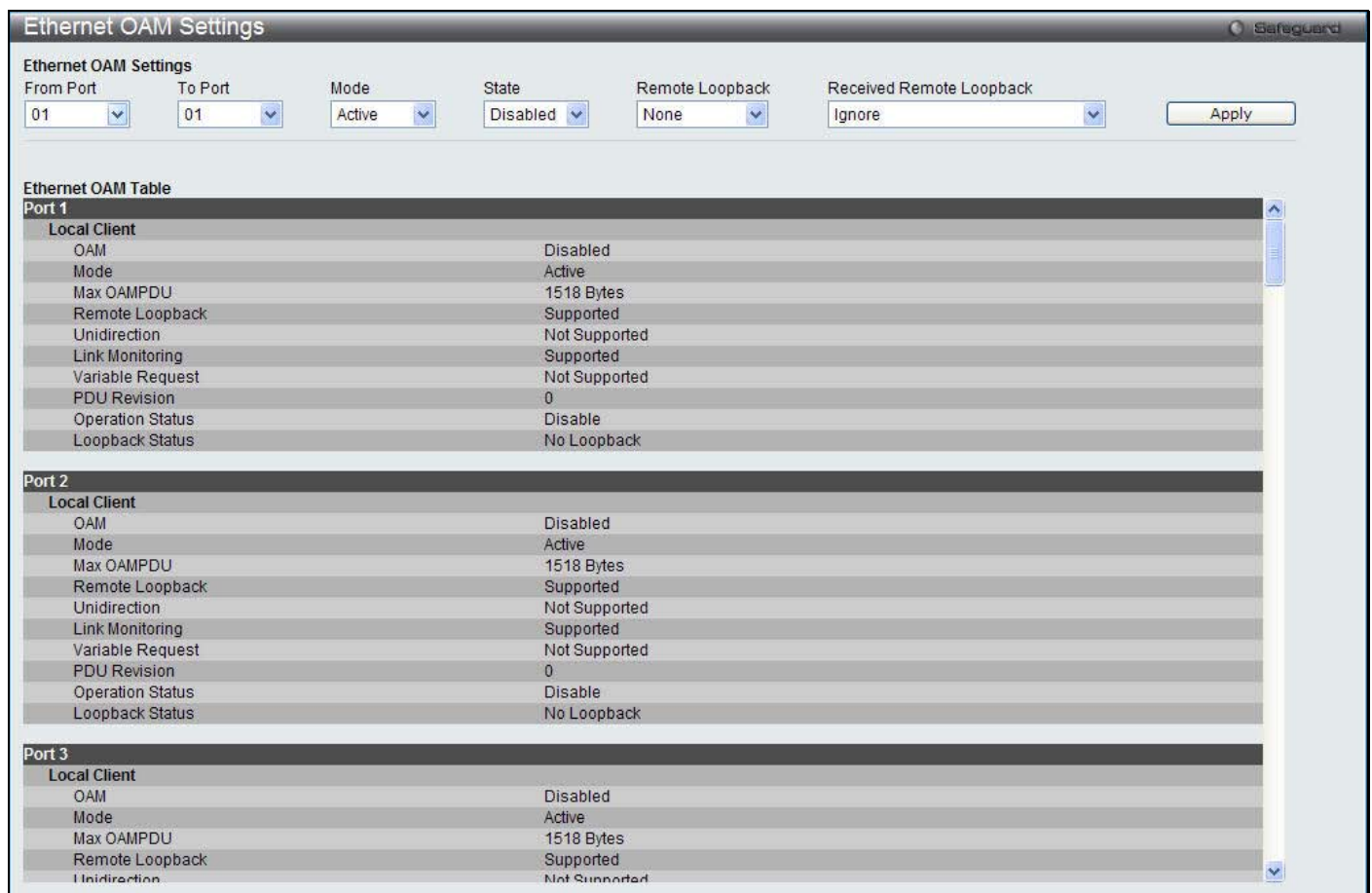

**Figure 9 - 1. Ethernet OAM Settings window**

The following parameters can be configured:

Parameter	Description
<b>From Port / To Port</b>	Select a range of ports you wish to configure.
<b>Mode</b>	Use the drop-down menu to select to operate in either <i>Active</i> or <i>Passive</i> . The default mode is <i>Active</i> .
<b>State</b>	Use the drop-down menu to enable or disable the OAM function.

<b>Remote Loopback</b>	Use the drop-down menu to select Ethernet OAM remote loopback. <i>None</i> – Select to disable the remote loopback. <i>Start</i> – Select to request the peer to change to the remote loopback mode. <i>Stop</i> – Select to request the peer to change to the normal operation mode.
<b>Received Remote Loopback</b>	Use the drop-down menu to configure the client to process or to ignore the received Ethernet OAM remote loopback command. <i>Process</i> – Select to process the received Ethernet OAM remote loopback command. <i>Ignore</i> – Select to ignore the received Ethernet OAM remote loopback command.

Click **Apply** to implement the changes.

## Ethernet OAM Configuration Settings

This window is used to configure Ethernet OAM configuration settings.

To view the following window, click **OAM > Ethernet OAM > Ethernet OAM Configuration Settings**:

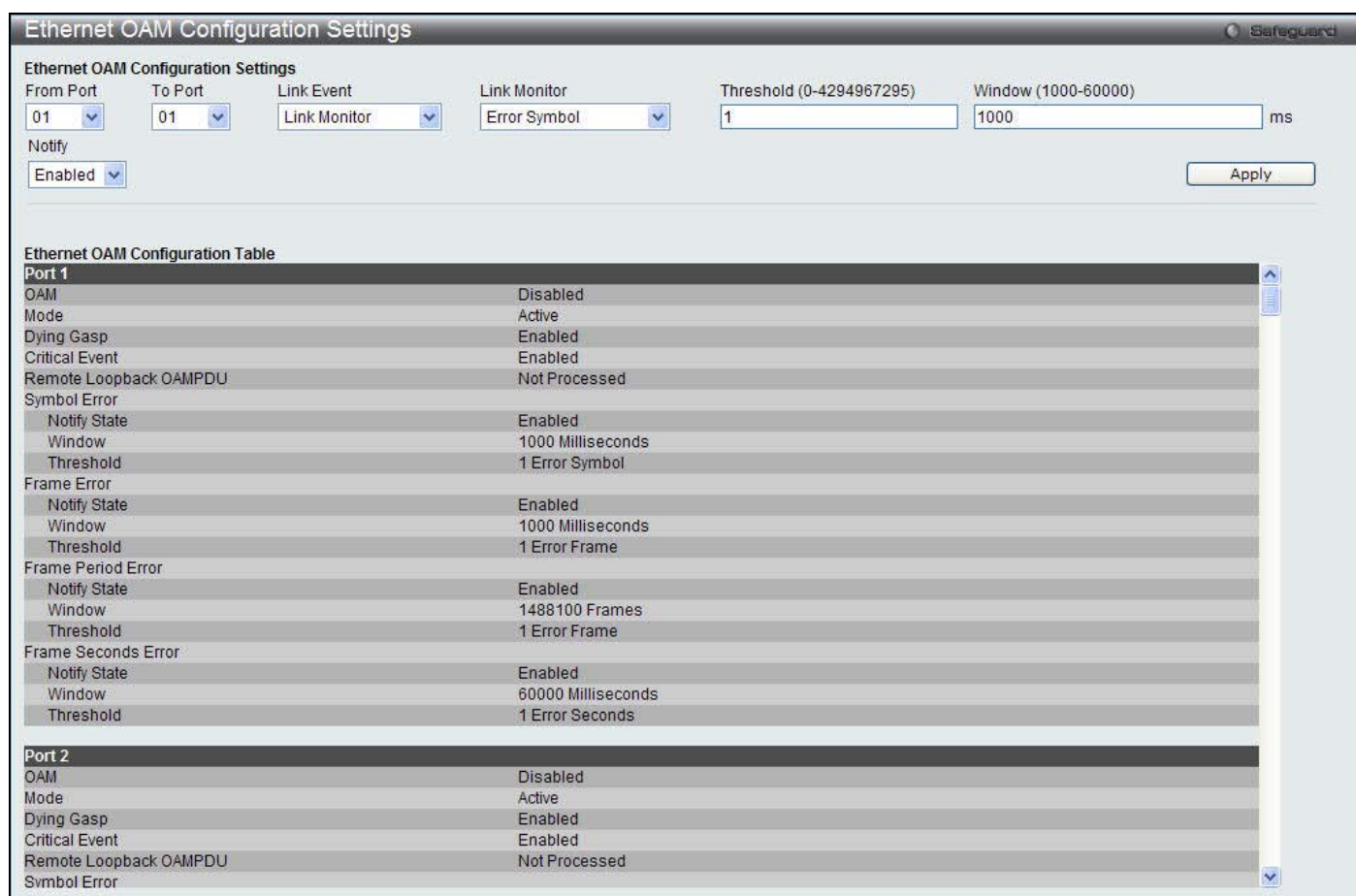

**Figure 9 - 2. Ethernet OAM Configuration Settings window**

The following parameters can be configured:

Parameter	Description
<b>From Port / To Port</b>	Select a range of ports you wish to configure.
<b>Link Event</b>	Use the drop-down menu to select the link events, <i>Link Monitor</i> or <i>Critical Link Event</i> .
<b>Link Monitor</b>	Use the drop-down menu to select link monitor. Available options are <i>Error Symbol</i> , <i>Error Frame</i> , <i>Error Frame Period</i> , and <i>Error Frame Seconds</i> .

<b>Critical Link Event</b>	Use the drop-down menu to select between <i>Dying Gasp</i> and <i>Critical Event</i> .
<b>Threshold (0-4294967295)</b>	Enter the number of error frame or symbol in the period is required to be equal to or greater than in order for the event to be generated.
<b>Window (1000-60000)</b>	Enter the period of error frame or symbol in milliseconds summary event.

Click **Apply** to implement the changes.

## Ethernet OAM Event Log

The window is used to show ports Ethernet OAM event log information.

To view the following window, click **OAM > Ethernet OAM > Ethernet OAM Event Log**:

Figure 9 - 3. Ethernet OAM Event Log window

The following parameters can be configured:

Parameter	Description
<b>Port</b>	Use the drop-down menu to select the unit ID and the port number to view.
<b>Port List (e.g.: 1, 4-6)</b>	Enter a list of ports. Tick the <b>All Ports</b> check box to select all ports.

Click the **Find** button to locate a specific entry based on the information entered. Click the **Clear** button to clear all the information entered in the fields.

## Ethernet OAM Statistics

The window is used to show ports Ethernet OAM statistics information.

To view the following window, click **OAM > Ethernet OAM > Ethernet OAM Statistics**:



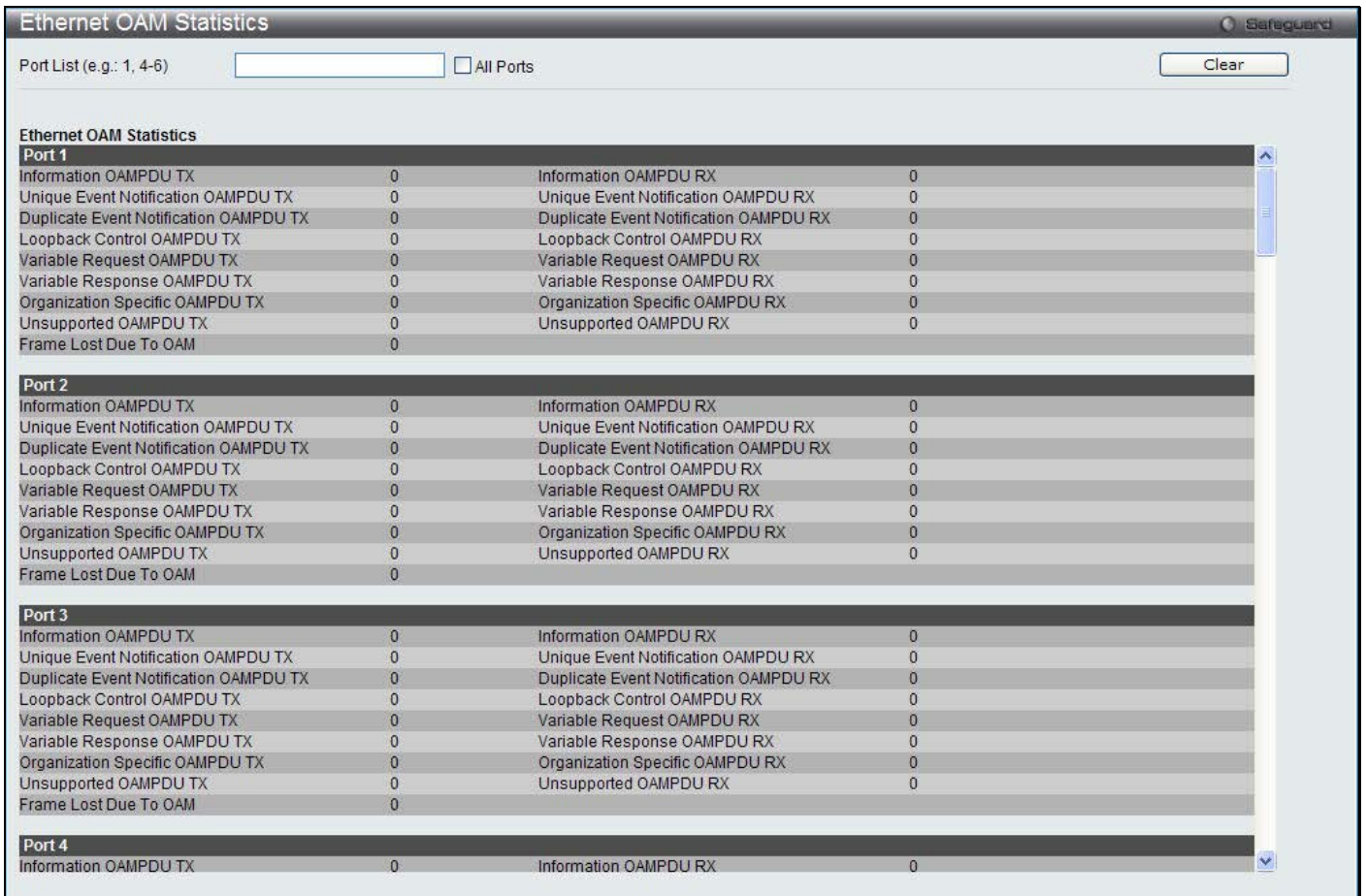

Figure 9 - 4. Ethernet OAM Statistics window

The following parameters can be configured:

Parameter	Description
<b>Port List (e.g.: 1, 4-6)</b>	Enter a list of ports. Tick the <b>All Ports</b> check box to select all ports.

Click the **Clear** button to clear all the information entered in the fields.

## DULD Settings

This window is used to configure and display D-LINK Unidirectional Link Detection (DULD) on port. It provides a mechanism that can be used to detect unidirectional link for Ethernet switches which PHYs don't support unidirectional OAM operation. As this function is established based on OAM, OAM should be enabled before starting detection.

To view the following window, click **OAM > DULD Settings**:

Port	Admin State	Oper Status	Mode	Link Status	Discovery Time (sec)
1	Disabled	Disabled	Normal	Unknown	5
2	Disabled	Disabled	Normal	Unknown	5
3	Disabled	Disabled	Normal	Unknown	5
4	Disabled	Disabled	Normal	Unknown	5
5	Disabled	Disabled	Normal	Unknown	5
6	Disabled	Disabled	Normal	Unknown	5
7	Disabled	Disabled	Normal	Unknown	5
8	Disabled	Disabled	Normal	Unknown	5
9	Disabled	Disabled	Normal	Unknown	5
10	Disabled	Disabled	Normal	Unknown	5
11	Disabled	Disabled	Normal	Unknown	5
12	Disabled	Disabled	Normal	Unknown	5
13	Disabled	Disabled	Normal	Unknown	5
14	Disabled	Disabled	Normal	Unknown	5
15	Disabled	Disabled	Normal	Unknown	5
16	Disabled	Disabled	Normal	Unknown	5
17	Disabled	Disabled	Normal	Unknown	5
18	Disabled	Disabled	Normal	Unknown	5
19	Disabled	Disabled	Normal	Unknown	5
20	Disabled	Disabled	Normal	Unknown	5
21	Disabled	Disabled	Normal	Unknown	5
22	Disabled	Disabled	Normal	Unknown	5
23	Disabled	Disabled	Normal	Unknown	5
24	Disabled	Disabled	Normal	Unknown	5

Figure 9 - 5. DULD Settings window

The following parameters can be configured:

Parameter	Description
<b>From Port / To Port</b>	Select a range of ports you wish to configure.
<b>State</b>	Use the drop-down menu to enable or disable the selected ports unidirectional link detection status.
<b>Mode</b>	Use the drop-down menu to select Mode between <i>Shutdown</i> and <i>Normal</i> . <i>Shutdown</i> – If any unidirectional link is detected, disable the port and log an event. <i>Normal</i> - Only log an event when a unidirectional link is detected.
<b>Discover Time (5-65535)</b>	Enter these ports neighbor discovery time. If the discovery is timeout, the unidirectional link detection will start.

Click the **Apply** button to implement the changes.

## Cable Diagnostics

The cable diagnostics feature is designed primarily for administrators or customer service representatives to verify and test copper cables; it can rapidly determine the quality of the cables and the types of error.

To view the following window, click **OAM > Cable Diagnostics**:

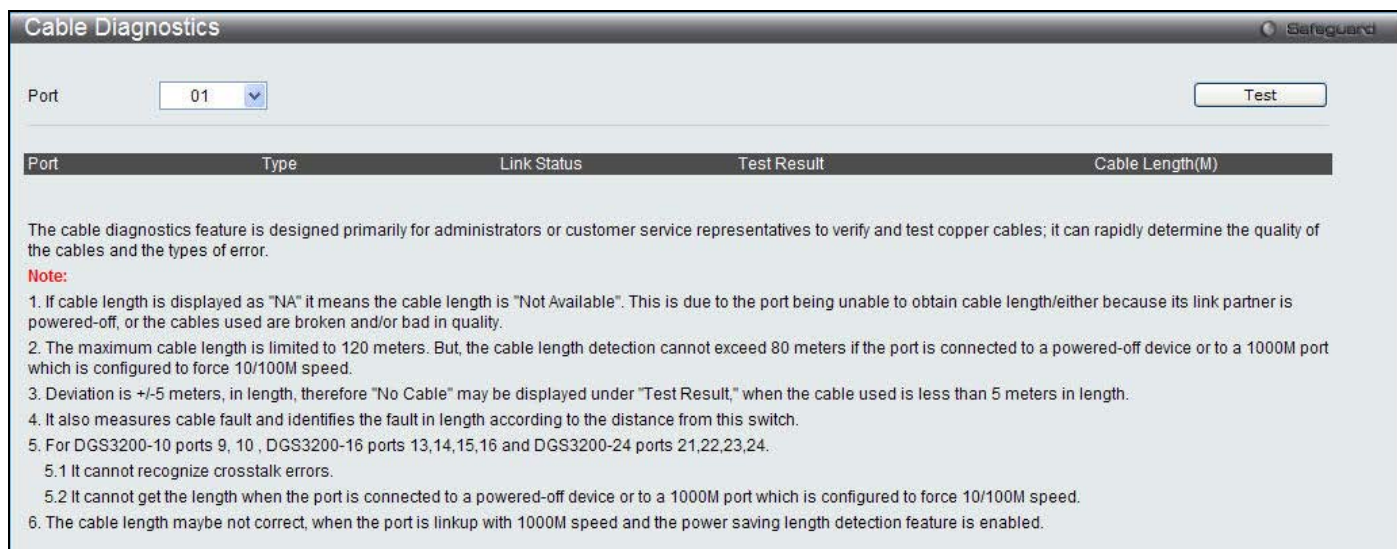

**Figure 9 - 6. Cable Diagnostics window**

To view the cable diagnostics for a particular port, use the drop-down menu to choose the port and click **Test**. The information will be displayed in this window.

### Cable Diagnostics Notes

1. The following two conditions apply for ports 9 and 10 on the DGS-3200-10, for ports 13, 14, 15, and 16 on the DGS-3200-16, and ports 25, 26, 27, and 28 on the DGS-3200-24: crosstalk errors cannot be recognized and the length cannot be obtained when the port is connected to a 1000Mbytes port which is either forced to 10/100Mbytes or powered down.
2. If cable length is displayed as “NA,” this means the cable length is “Not Available”.
3. The cable length cannot exceed 80 meters if the port is connected to a powered-off device or to a port which is configured to force 10/100Mbytes speed.
4. Accurate measurement cannot be obtained when the cable is shorter than 1 meter.
5. The error deviation is +/-5 meters in length.
6. Cable fault is measured and the fault length is identified according to the distance from the switch.

**Section 10**

# Monitoring

*Device Environment (DGS-3200-16 and DGS-3200-24 only)*

*CPU Utilization*

*DRAM & Flash Utilization*

*Port Utilization*

*Packet Size*

*Packets*

*Errors*

*Browse ARP Table*

*Browse Router Port*

*Browse MLD Router Port*

*Browse Session Table*

*IGMP Snooping Group*

*MLD Snooping Group*

*MAC Address Table*

*System Log*

## Device Environment

The device environment feature displays the Switch internal temperature status (DGS-3200-16 and DGS-3200-24 only).

To view the following window, click **Monitoring > Device Environment**:

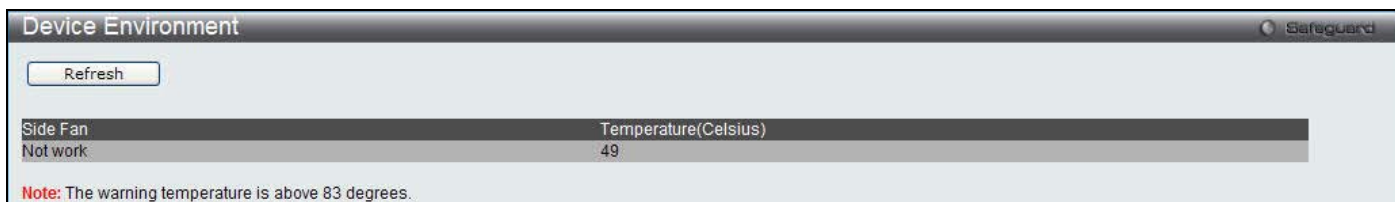

**Figure 10 - 1. Device Environment window (DGS-3200-16)**



**Figure 10 - 2. Device Environment window (DGS-3200-24)**

Click **Refresh** to update the information displayed in these windows.

## CPU Utilization

This window is used to display the percentage of the CPU being used, expressed as an integer percentage and calculated as a simple average by time interval.

To view the following window, click **Monitoring > CPU Utilization**:



**Figure 10 - 3. CPU Utilization window**

To view the CPU utilization by port, use the real-time graphic of the Switch and/or switch stack at the top of the web page by simply clicking a port. Click **Apply** to implement the configured settings. The window will automatically refresh with new updated statistics.

The following parameters can be configured:

Parameter	Description
<b>Time Interval</b>	Select the desired setting between 1s and 60s, where "s" stands for seconds. The default value is one second.
<b>Record Number</b>	Select number of times the Switch will be polled between 20 and 200. The default value is 200.
<b>Show/Hide</b>	Check whether or not to display Five Secs, One Min, and Five Mins.

Click **Apply** to implement the changes.

## DRAM & Flash Utilization

This window is used to display information regarding the DRAM and Flash utilization.

To view the following window, click **Monitoring > DRAM & Flash Utilization**:

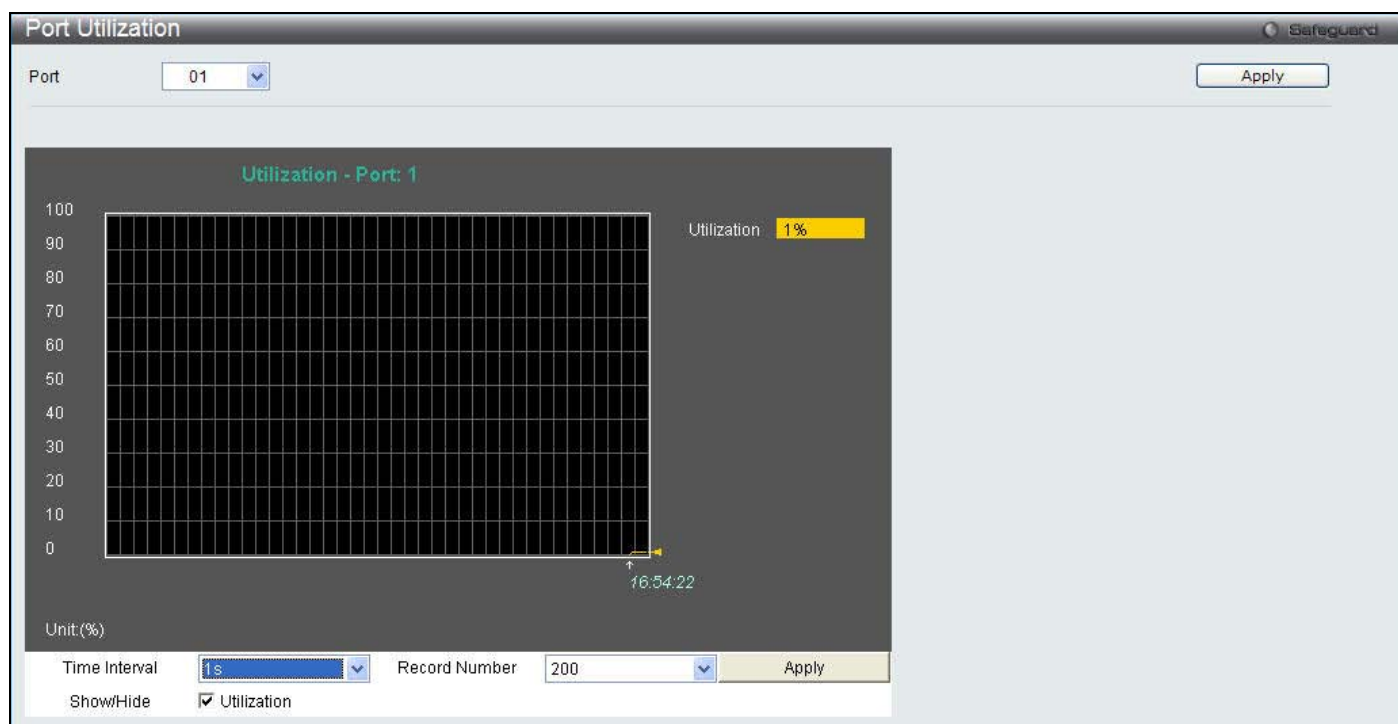

**Figure 10 - 4. DRAM & Flash Utilization window**

## Port Utilization

Users can display the percentage of the total available bandwidth being used on the port.

To view the following window, click **Monitoring > Port Utilization**:



**Figure 10 - 5. Port Utilization window**

To select a port to view these statistics for, select the port by using the Port drop-down menu. The user may also use the real-time graphic of the Switch at the top of the web page by simply clicking on a port.

The following parameters can be configured:

Parameter	Description
<b>Port</b>	Use the drop-down menu to choose the port that will display statistics.
<b>Time Interval</b>	Select the desired setting between 1s and 60s, where "s" stands for seconds. The default value is one second.
<b>Record Number</b>	Select number of times the Switch will be polled between 20 and 200. The default value is 200.
<b>Show/Hide</b>	Check whether or not to display Port Util.

Click **Apply** to implement the changes.

## Packet Size

Users can display packets received by the Switch, arranged in six groups and classed by size, as either a line graph or a table. Two windows are offered. To select a port to view these statistics for, select the port by using the **Port** drop-down menu. The user may also use the real-time graphic of the Switch at the top of the web page by simply clicking on a port.

To view the following windows, click **Monitoring > Packet Size**:

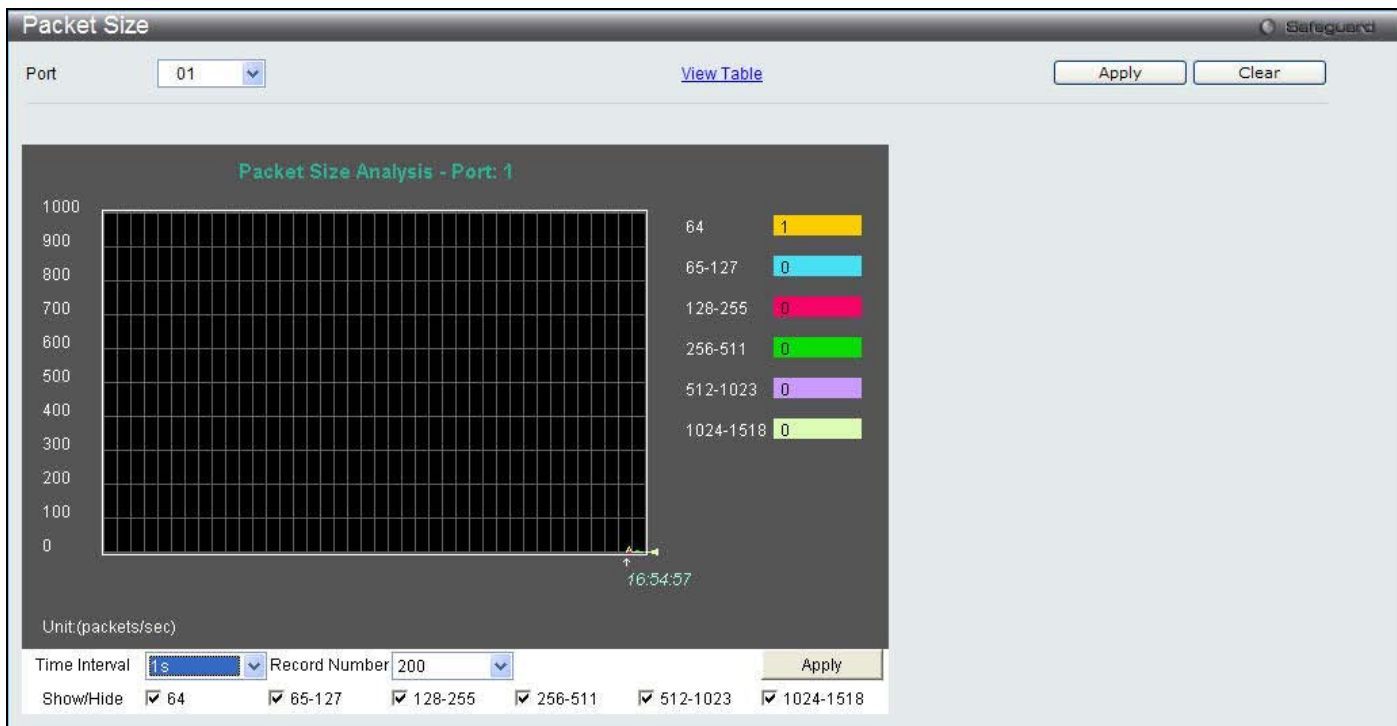

Figure 10 - 6. Packet Size window

To view the **Packet Size Table** window, click the link [View Table](#), which will show the following table:



Figure 10 - 7. Packet Size Table window

The following fields can be set or viewed:

Parameter	Description
<b>Port</b>	Use the drop-down menu to choose the port that will display statistics.
<b>Time Interval</b>	Select the desired setting between 1s and 60s, where "s" stands for seconds. The default value is one second.
<b>Record Number</b>	Select number of times the Switch will be polled between 20 and 200. The default value is 200.

<b>64</b>	The total number of packets (including bad packets) received that were 64 octets in length (excluding framing bits but including FCS octets).
<b>65-127</b>	The total number of packets (including bad packets) received that were between 65 and 127 octets in length inclusive (excluding framing bits but including FCS octets).
<b>128-255</b>	The total number of packets (including bad packets) received that were between 128 and 255 octets in length inclusive (excluding framing bits but including FCS octets).
<b>256-511</b>	The total number of packets (including bad packets) received that were between 256 and 511 octets in length inclusive (excluding framing bits but including FCS octets).
<b>512-1023</b>	The total number of packets (including bad packets) received that were between 512 and 1023 octets in length inclusive (excluding framing bits but including FCS octets).
<b>1024-1518</b>	The total number of packets (including bad packets) received that were between 1024 and 1518 octets in length inclusive (excluding framing bits but including FCS octets).
<b>Show/Hide</b>	Check whether or not to display 64, 65-127, 128-255, 256-511, 512-1023, and 1024-1518 packets received.
<b>Clear</b>	Clicking this button clears all statistics counters on this window.
<a href="#">View Table</a>	Clicking this button instructs the Switch to display a table rather than a line graph.
<a href="#">View Graphic</a>	Clicking this button instructs the Switch to display a line graph rather than a table.

## Packets

The Web manager allows various packet statistics to be viewed as either a line graph or a table.

### Received (RX)

To select a port to view these statistics for, select the port by using the **Port** drop-down menu. The user may also use the real-time graphic of the Switch at the top of the web page by simply clicking on a port.

To view the following windows, click **Monitoring > Packets > Received (RX)**:



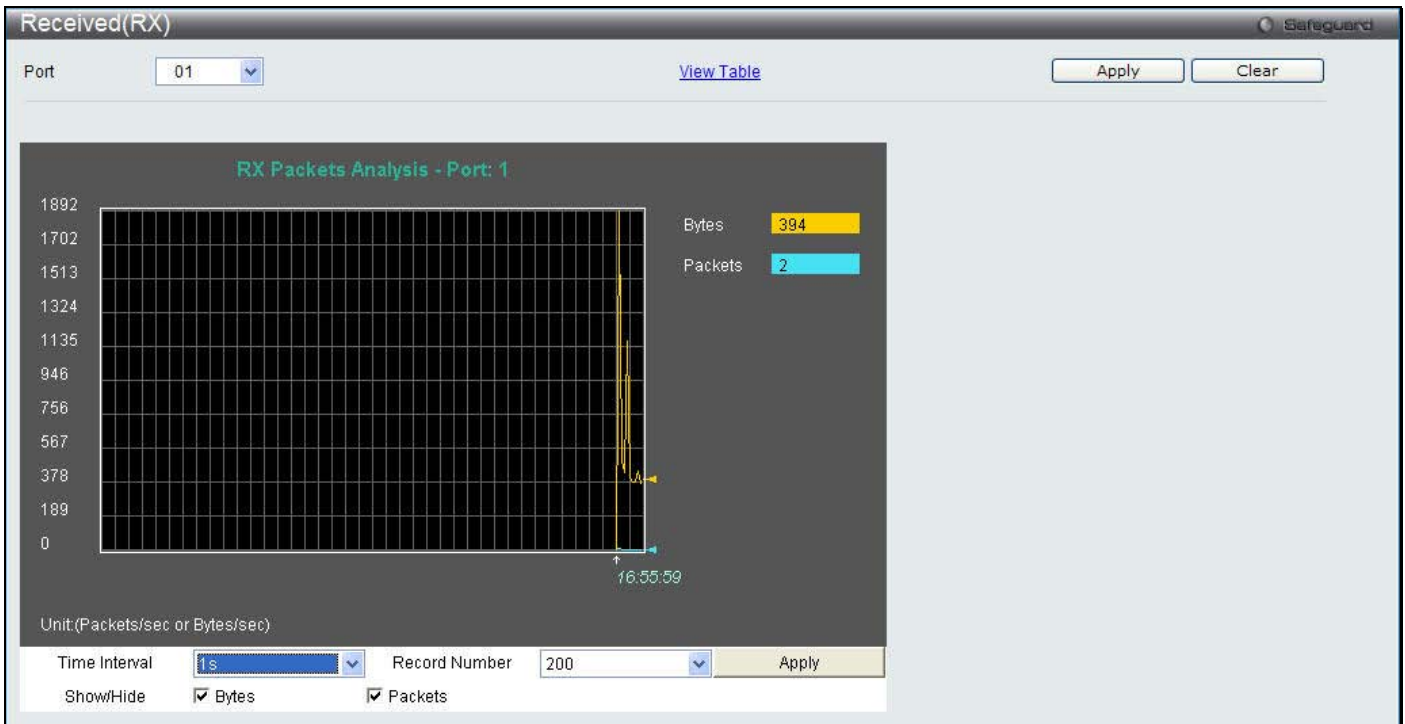

Figure 10 - 8. Received (RX) window (for Bytes and Packets)

To view the **Received (RX) Table** window, click [View Table](#).

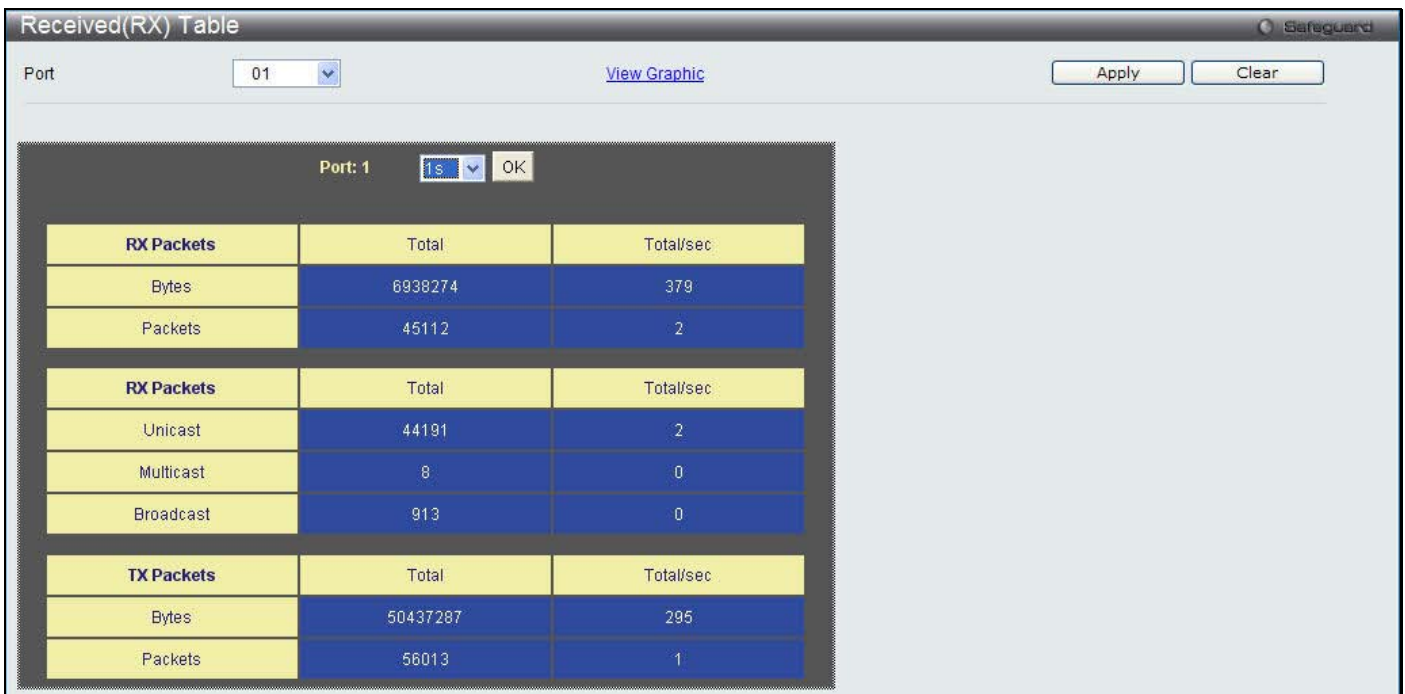

Figure 10 - 9. Received (RX) Table window (for Bytes and Packets)

The following fields may be set or viewed:

Parameter	Description
<b>Port</b>	Use the drop-down menu to choose the port that will display statistics.
<b>Time Interval</b>	Select the desired setting between 1s and 60s, where "s" stands for seconds. The default value is one second.

<b>Record Number</b>	Select number of times the Switch will be polled between 20 and 200. The default value is 200.
<b>Bytes</b>	Counts the number of bytes received on the port.
<b>Packets</b>	Counts the number of packets received on the port.
<b>Unicast</b>	Counts the total number of good packets that were received by a unicast address.
<b>Multicast</b>	Counts the total number of good packets that were received by a multicast address.
<b>Broadcast</b>	Counts the total number of good packets that were received by a broadcast address.
<b>Show/Hide</b>	Check whether to display Bytes and Packets.

Click the **Apply** button to accept the changes made. Click the **Clear** button to clear all statistics counters on this window. Click the [View Table](#) link to display the information in a table rather than a line graph. Click the [View Graphic](#) link to display the information in a line graph rather than a table.

## UMB\_Cast (RX)

To select a port to view these statistics for, select the port by using the **Port** drop-down menu. The user may also use the real-time graphic of the Switch at the top of the web page by simply clicking on a port.

To view the following windows, click **Monitoring > Packets > UMB\_Cast (RX)**:

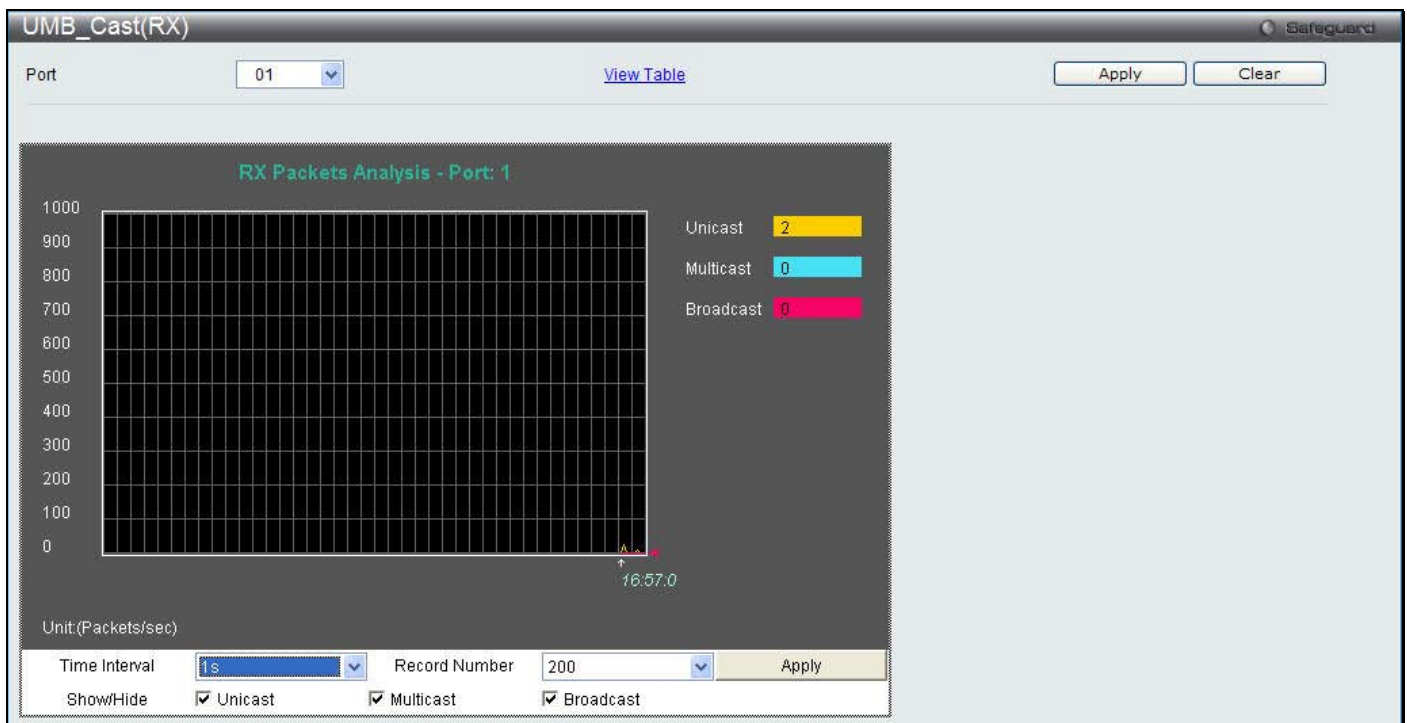

Figure 10 - 10. UMB\_Cast (RX) window (for Unicast, Multicast, and Broadcast Packets)

To view the **UMB\_Cast (RX) Table** window, click the [View Table](#) link.

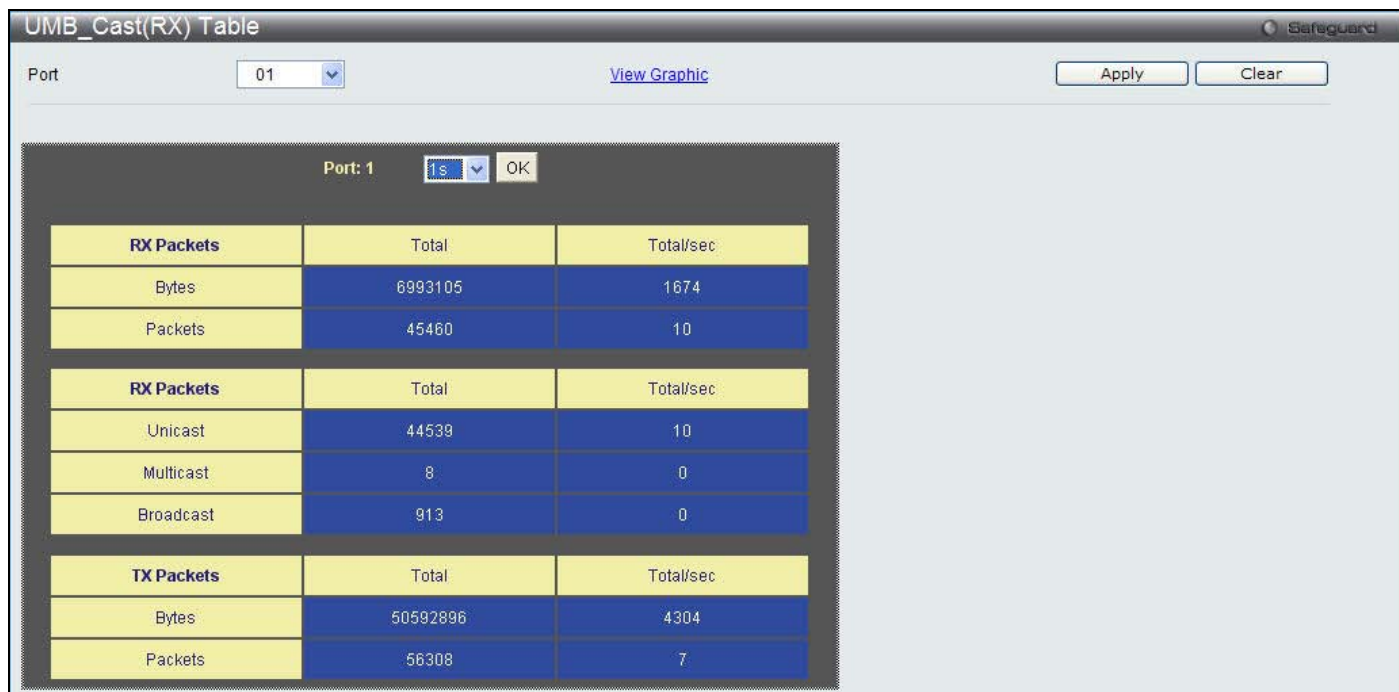

Figure 10 - 11. UMB\_Cast (RX) Table window (for Unicast, Multicast, and Broadcast Packets)

The following fields may be set or viewed:

Parameter	Description
<b>Port</b>	Use the drop-down menu to choose the port that will display statistics.
<b>Time Interval</b>	Select the desired setting between 1s and 60s, where "s" stands for seconds. The default value is one second.
<b>Record Number</b>	Select number of times the Switch will be polled between 20 and 200. The default value is 200.
<b>Unicast</b>	Counts the total number of good packets that were received by a unicast address.
<b>Multicast</b>	Counts the total number of good packets that were received by a multicast address.
<b>Broadcast</b>	Counts the total number of good packets that were received by a broadcast address.
<b>Show/Hide</b>	Check whether or not to display Multicast, Broadcast, and Unicast Packets.

Click the **Apply** button to accept the changes made. Click the **Clear** button to clear all statistics counters on this window. Click the [View Table](#) link to display the information in a table rather than a line graph. Click the [View Graphic](#) link to display the information in a line graph rather than a table.

## Transmitted (TX)

To select a port to view these statistics for, select the port by using the **Port** drop-down menu. The user may also use the real-time graphic of the Switch at the top of the web page by simply clicking on a port.

To view the following windows, click **Monitoring > Packets > Transmitted (TX)**:

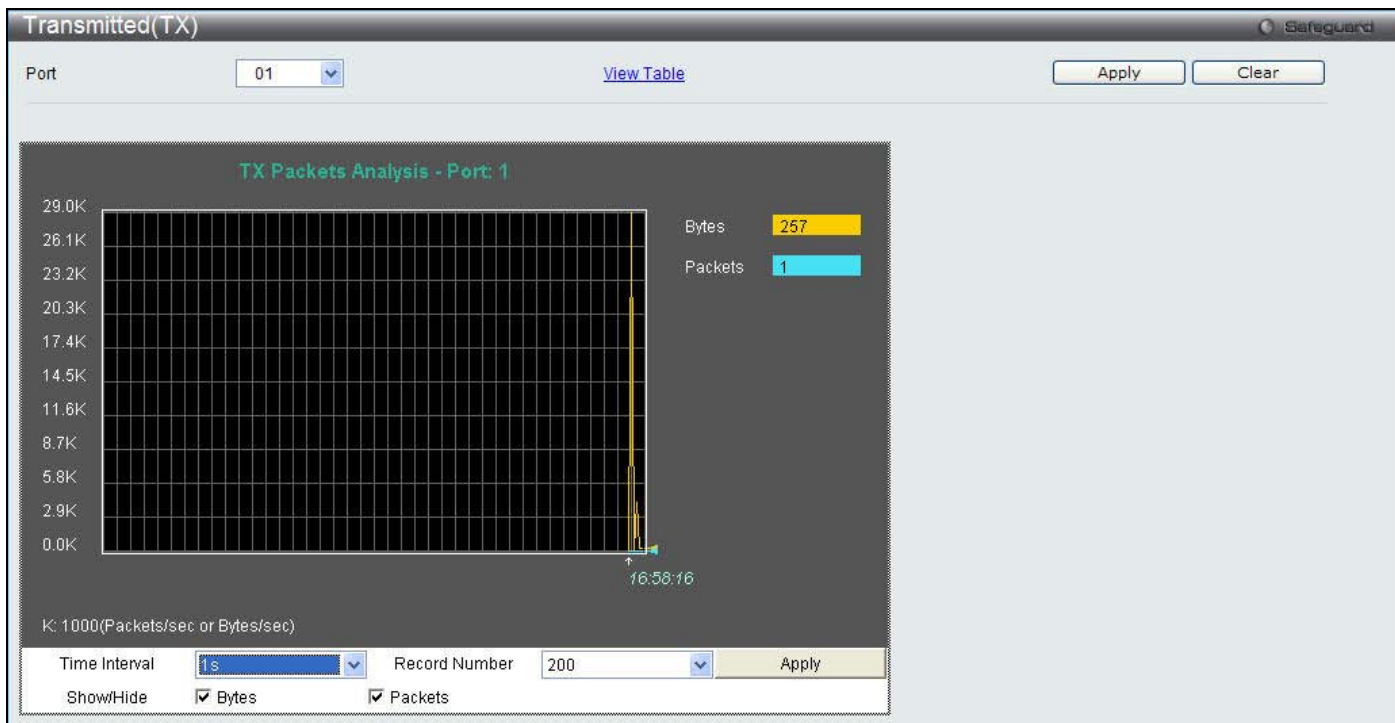

Figure 10 - 12. Transmitted (TX) window (for Bytes and Packets)

To view the **Transmitted (TX) Table** window, click the link [View Table](#).



Figure 10 - 13. Transmitted (TX) Table window (for Bytes and Packets)

The following fields may be set or viewed:

Parameter	Description
<b>Port</b>	Use the drop-down menu to choose the port that will display statistics.
<b>Time Interval</b>	Select the desired setting between 1s and 60s, where "s" stands for seconds. The default value is one second.

<b>Record Number</b>	Select number of times the Switch will be polled between 20 and 200. The default value is 200.
<b>Bytes</b>	Counts the number of bytes successfully sent on the port.
<b>Packets</b>	Counts the number of packets successfully sent on the port.
<b>Unicast</b>	Counts the total number of good packets that were transmitted by a unicast address.
<b>Multicast</b>	Counts the total number of good packets that were transmitted by a multicast address.
<b>Broadcast</b>	Counts the total number of good packets that were transmitted by a broadcast address.
<b>Show/Hide</b>	Check whether or not to display Bytes and Packets.

Click the **Apply** button to accept the changes made. Click the **Clear** button to clear all statistics counters on this window. Click the [View Table](#) link to display the information in a table rather than a line graph. Click the [View Graphic](#) link to display the information in a line graph rather than a table.

## Errors

The Web manager allows port error statistics compiled by the Switch's management agent to be viewed as either a line graph or a table. Four windows are offered.

### Received (RX)

To select a port to view these statistics for, select the port by using the Port drop-down menu. The user may also use the real-time graphic of the Switch at the top of the web page by simply clicking on a port.

To view the following windows, click **Monitoring > Errors > Received (RX)**:

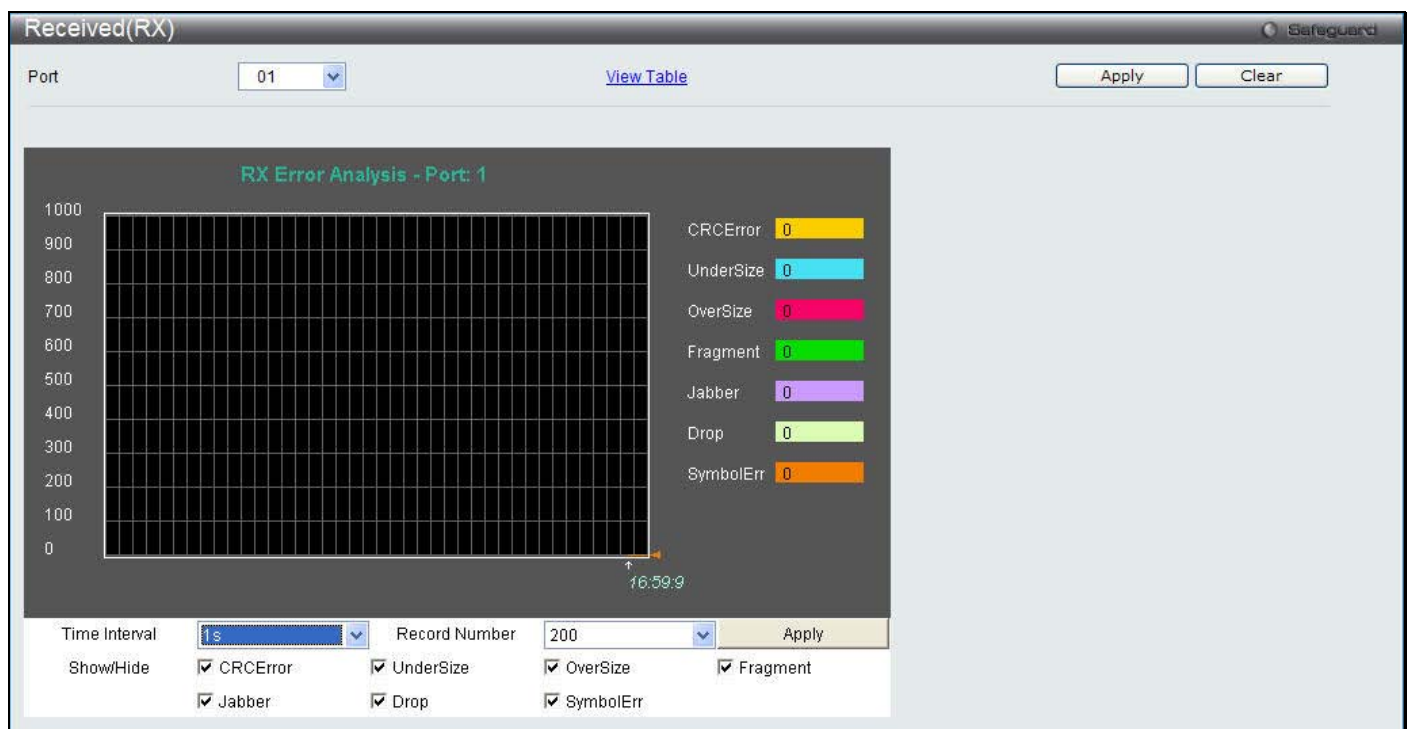

Figure 10 - 14. Received (RX) window (for errors)

To view the **Received (RX) Table** window for errors, click the link [View Table](#), which will show the following table:



Figure 10 - 15. Received (RX) Table window (for errors)

The following fields can be set:

Parameter	Description
<b>Port</b>	Use the drop-down menu to choose the port that will display statistics.
<b>Time Interval</b>	Select the desired setting between 1s and 60s, where "s" stands for seconds. The default value is one second.
<b>Record Number</b>	Select number of times the Switch will be polled between 20 and 200. The default value is 200.
<b>CRCErrror</b>	Counts otherwise valid packets that did not end on a byte (octet) boundary.
<b>UnderSize</b>	The number of packets detected that are less than the minimum permitted packets size of 64 bytes and have a good CRC. Undersize packets usually indicate collision fragments, a normal network occurrence.
<b>OverSize</b>	Counts valid packets received that were longer than 1518 octets and less than the MAX_PKT_LEN. Internally, MAX_PKT_LEN is equal to 1536.
<b>Fragment</b>	The number of packets less than 64 bytes with either bad framing or an invalid CRC. These are normally the result of collisions.
<b>Jabber</b>	Counts invalid packets received that were longer than 1518 octets and less than the MAX_PKT_LEN. Internally, MAX_PKT_LEN is equal to 1536.
<b>Drop</b>	The number of packets that are dropped by this port since the last Switch reboot.
<b>Symbol</b>	Counts the number of packets received that have errors received in the symbol on the physical labor.

Click the **Apply** button to accept the changes made. Click the **Clear** button to clear all statistics counters on this window. Click the [View Table](#) link to display the information in a table rather than a line graph. Click the [View Graphic](#) link to display the information in a line graph rather than a table.

## Transmitted (TX)

To select a port to view these statistics for, select the port by using the Port drop-down menu. The user may also use the real-time graphic of the Switch at the top of the web page by simply clicking on a port.

To view the following windows, click **Monitoring > Errors > Transmitted (TX)**:

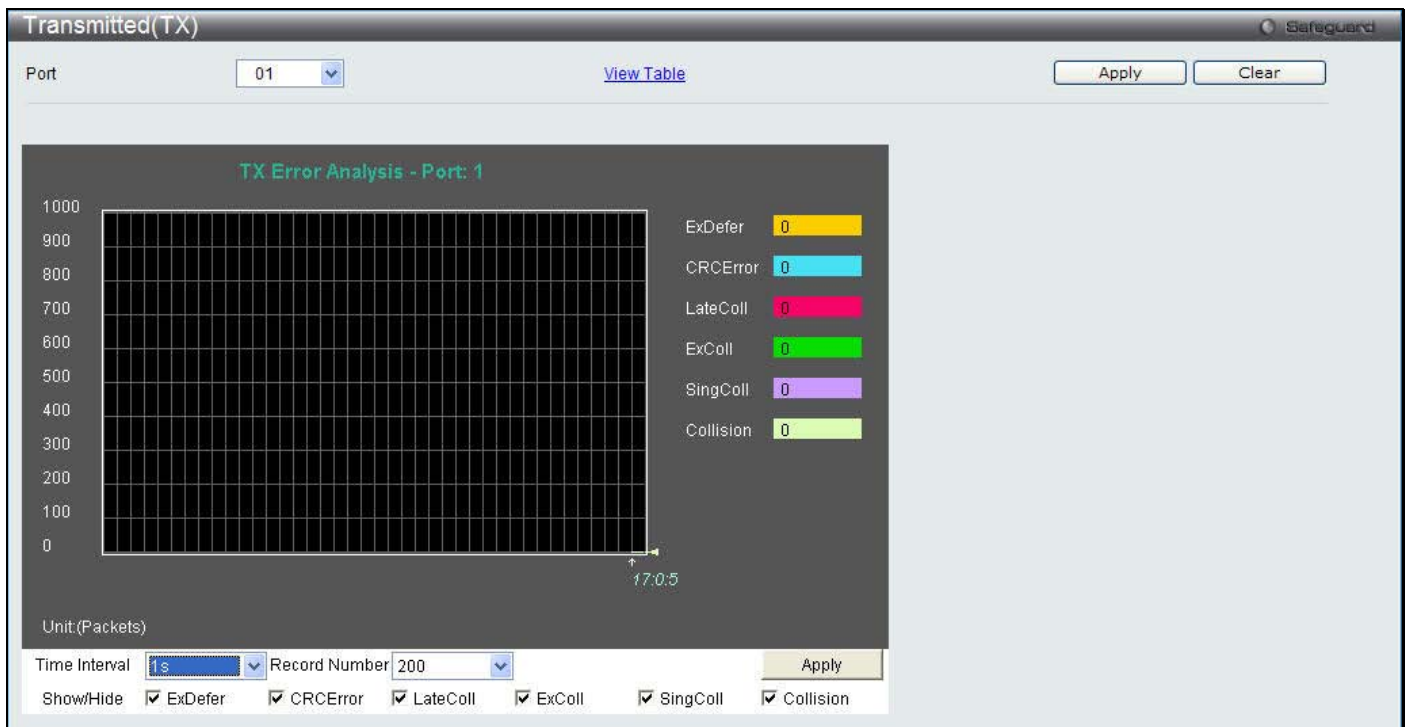

Figure 10 - 16. Transmitted (TX) window (for errors)

To view the **Transmitted (TX) Table** window, click the link [View Table](#), which will show the following table:

The screenshot shows the 'Transmitted(TX) Table' window. At the top, there is a 'Port' dropdown menu set to '01' and a 'View Graphic' link. Below the table, there are 'Apply' and 'Clear' buttons. The table is titled 'Port: 1' and has a 'Time Interval' dropdown set to '1s' and an 'OK' button. The table has two columns: 'TX Error' and 'TX Frames'. The data is as follows:

TX Error	TX Frames
ExDefer	0
CRC Error	0
LateColl	0
ExColl	0
SingColl	0
Collision	0

Figure 10 - 17. Transmitted (TX) Table window (for errors)

The following fields may be set or viewed:

Parameter	Description
Port	Use the drop-down menu to choose the port that will display statistics.

<b>Time Interval</b>	Select the desired setting between 1s and 60s, where "s" stands for seconds. The default value is one second.
<b>Record Number</b>	Select number of times the Switch will be polled between 20 and 200. The default value is 200.
<b>ExDefer</b>	Counts the number of packets for which the first transmission attempt on a particular interface was delayed because the medium was busy.
<b>CRC Error</b>	Counts otherwise valid packets that did not end on a byte (octet) boundary.
<b>LateColl</b>	Counts the number of times that a collision is detected later than 512 bit-times into the transmission of a packet.
<b>ExColl</b>	Excessive Collisions. The number of packets for which transmission failed due to excessive collisions.
<b>SingColl</b>	Single Collision Frames. The number of successfully transmitted packets for which transmission is inhibited by more than one collision.
<b>Collision</b>	An estimate of the total number of collisions on this network segment.
<b>Show/Hide</b>	Check whether or not to display ExDefer, CRCError, LateColl, ExColl, SingColl, and Collision errors.

Click the **Apply** button to accept the changes made. Click the **Clear** button to clear all statistics counters on this window. Click the [View Table](#) link to display the information in a table rather than a line graph. Click the [View Graphic](#) link to display the information in a line graph rather than a table.

## Browse ARP Table

This window is used to display current ARP entries on the Switch.

To view the following window, click **Monitoring > Browse ARP Table**:

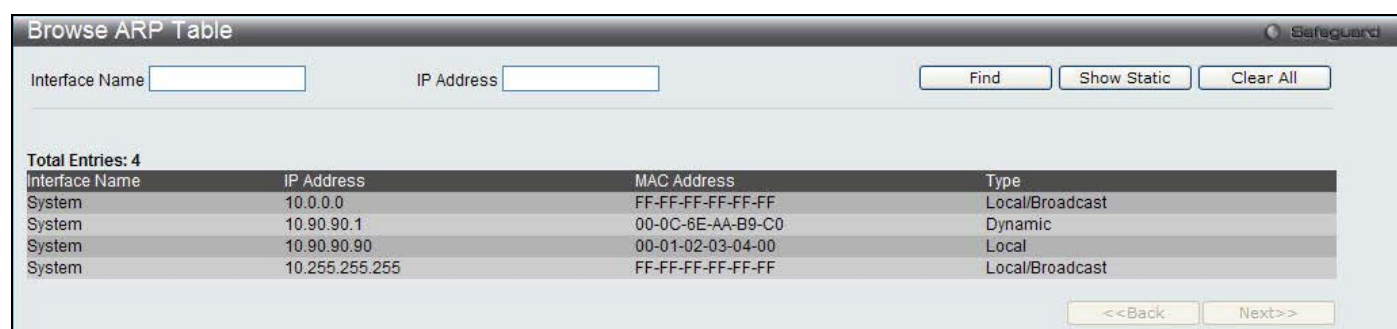

Figure 10 - 18. Browse ARP Table window

To search a specific ARP entry, enter an Interface Name or an IP Address at the top of the window and click **Find**. Click the **Show Static** button to display static ARP table entries. To clear the ARP Table, click **Clear All**.

## Browse Router Port

Users can display which of the Switch's ports are currently configured as router ports. A router port configured by a user (using the console or Web-based management interfaces) is displayed as a static router port, designated by S. A router port that is dynamically configured by the Switch is designated by D, while a Forbidden port is designated by F.

To view the following window, click **Monitoring > Browse Router Port**:





Figure 10 - 19. Browse Router Port window

Enter a VID (VLAN ID) in the field at the top of the window and click the **Find** button.

## Browse MLD Router Port

Users can display which of the Switch’s ports are currently configured as router ports in IPv6. A router port configured by a user (using the console or Web-based management interfaces) is displayed as a static router port, designated by S. A router port that is dynamically configured by the Switch is designated by D, while a Forbidden port is designated by F.

To view the following window, click **Monitoring > Browse MLD Router Port**:



Figure 10 - 20. Browse MLD Router Port window

Enter a VID (VLAN ID) in the field at the top of the window and click the **Find** button.

## Browse Session Table

Users can display the management sessions since the Switch was last rebooted.

To view the following window, click **Monitoring > Browse Session Table**:

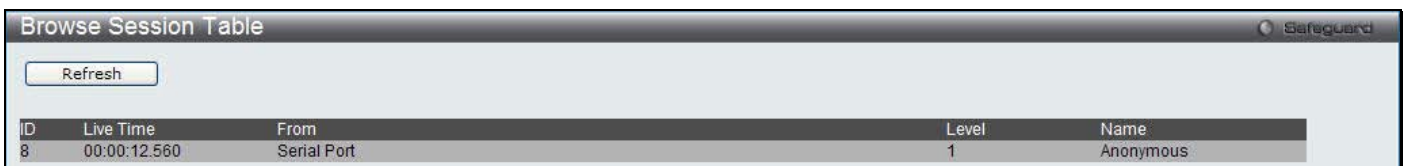

Figure 7 - 1. Browse Session Table window

Click **Refresh** to update the information.

## IGMP Snooping Group

Users can view the Switch's IGMP Snooping Group Table. IGMP Snooping allows the Switch to read the Multicast Group IP address and the corresponding MAC address from IGMP packets that pass through the Switch.

To view the following window, click **Monitoring > IGMP Snooping Group**:

**Figure 10 - 21. IGMP Snooping Group window**

The following parameters can be configured:

Parameter	Description
<b>VLAN Name</b>	The VLAN Name of the multicast group.
<b>VID List (e.g.: 1, 4-6)</b>	The VLAN ID list of the multicast group.
<b>Port List (e.g.: 1, 3-5)</b>	Specify the port number(s) used to find a multicast group.
<b>Group IPv4 Address</b>	Enter the IPv4 address.

Click the **Find** button to locate a specific entry based on the information entered. Click the **View All** button to display all the existing entries.



**NOTE:** To configure IGMP snooping for the Switch, go to the **L2 Features** folder and select **IGMP Snooping > IGMP Snooping Settings**.

## MLD Snooping Group

Users can view MLD Snooping Groups present on the Switch. MLD Snooping is an IPv6 function comparable to IGMP Snooping for IPv4.

To view the following window, click **Monitoring > MLD Snooping Group**:

**Figure 10 - 22. MLD Snooping Group window**

The following parameters can be configured:

Parameter	Description
<b>VLAN Name</b>	The VLAN Name of the multicast group.
<b>VID List (e.g.: 1, 4-6)</b>	The VLAN ID list of the multicast group.
<b>Port List (e.g.: 1, 3-5)</b>	Specify the port number(s) used to find a multicast group.
<b>Group IPv4 Address</b>	Enter the IPv4 address.

Click the **Find** button to locate a specific entry based on the information entered. Click the **View All** button to display all the existing entries.



**NOTE:** To configure MLD snooping for the Switch, go to the **L2 Features** folder and select **MLD Snooping > MLD Snooping Settings**.

## MAC Address Table

This allows the Switch's dynamic MAC address forwarding table to be viewed. When the Switch learns an association between a MAC address and a port number, it makes an entry into its forwarding table. These entries are then used to forward packets through the Switch.

To view the following window, click **Monitoring > MAC Address Table**:

**Figure 10 - 23. MAC Address Table window**

The following parameters can be configured:

Parameter	Description
<b>Port</b>	The port to which the MAC address below corresponds.
<b>VLAN Name</b>	Enter a VLAN Name for the forwarding table to be browsed by.
<b>VID List</b>	Enter a list of VLAN for the forwarding table to be browsed by.
<b>MAC Address</b>	Enter a MAC address for the forwarding table to be browsed by.
<b>Security</b>	Tick the check box to diapsly the FDB entries that are created by the security module.

Click the **Find** button to locate a specific entry based on the information entered. Click the **Clear Dynamic Entries** button to delete all dynamic entries of the address table. Click the **View All Entries** button to display all the existing entries. Click the **Clear All Entries** button to remove all the entries listed in the table. Click the **Add to Static MAC table** button to add the

specific entry to the Static MAC table. Enter a page number and click the **Go** button to navigate to a specific page when multiple pages exist.

## System Log

Users can view the history log as compiled by the Switch's management agent.

To view the following window, click **Monitoring > System Log**:

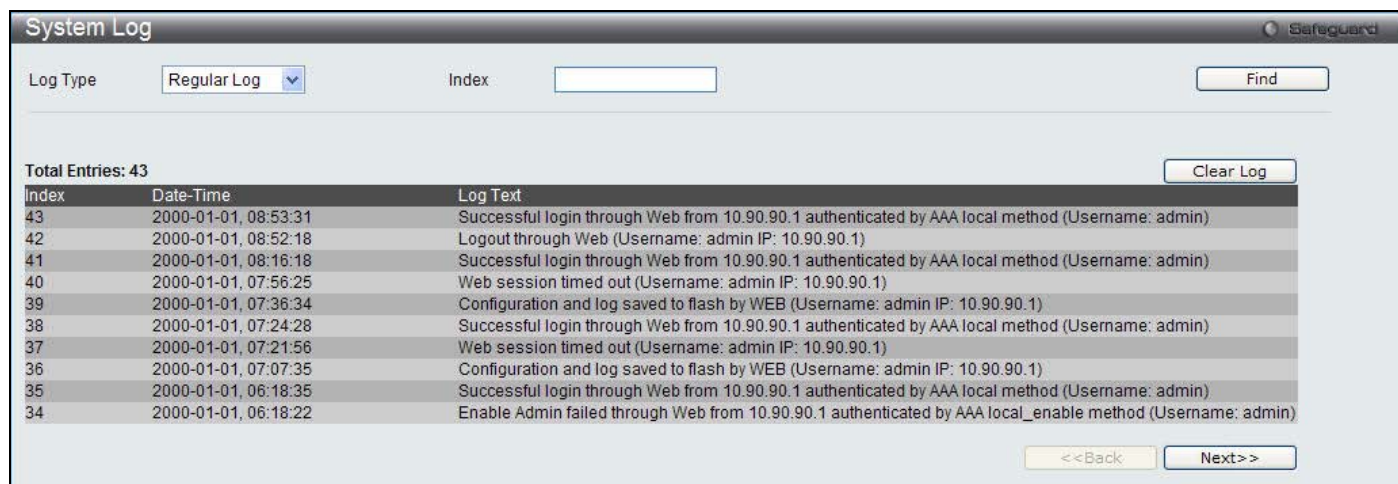

Figure 10 - 24. System Log window

The Switch can record event information in its own logs, to designated SNMP trap receiving stations, and to the PC connected to the console manager. Clicking **Clear Log** will allow the user to delete all the present entries in the Switch History Log.

The following parameters can be configured or displayed:

Parameter	Description
<b>Log Type</b>	Choose the type of log to view. There are two choices: <i>Regular Log</i> – Choose this option to view regular switch log entries, such as logins or firmware transfers. <i>Attack Log</i> – Choose this option to view attack log entries, such as spoofing attacks.
<b>Index</b>	To view a specific log entry, enter the Index number in the field at the top of the window and then click the <b>Find</b> button. The index is a counter incremented whenever an entry to the Switch's history log is made. Unless a specific index is entered in this field, the table on this window will display a series of entries, starting with the last entry (highest sequence number) first. Click the <b>Next&gt;&gt;</b> or <b>&lt;&lt;Previous</b> buttons to navigate around the logs for the Switch.
<b>Date-Time</b>	Displays the time, in days, hours, minutes, and seconds, when the event was triggered.
<b>Log Text</b>	Displays text describing the event that triggered the history log entry.

# Save and Tools

## **Save Configuration**

### **Save Log**

### **Save All**

### **Download Configuration File/Download Configuration File to NV-RAM (DGS-3200-24 only)**

### **Download Configuration File to SD Card (DGS-3200-24 only)**

### **Download Firmware/Download Firmware to NV-RAM (DGS-3200-24 only)**

### **Download Firmware to SD Card (DGS-3200-24 only)**

### **Upload Configuration File/Upload Configuration File to TFTP**

### **Upload Log File/Upload Log File to TFTP**

### **Reset**

### **Reboot System**

The three main **Save** windows include: **Save Configuration**, **Save Log**, and **Save All**.

The options include:

- **Save Configuration** to save the configuration file indexed as *Active*, ID 1 or 2 (or *SD Card* for the DGS-3200-24 only).
- **Save Log** to save the current log to *NV-RAM* (or *SD Card* for the DGS-3200-24 only).
- **Save All** to immediately save the current configuration file and the current log.

The eight main **Tools** windows include: **Download Configuration File/Download Configuration File to NV-RAM**, **Download Configuration File to SD Card**, **Download Firmware/Download Firmware to NV-RAM**, **Download Firmware to SD Card**, **Upload Configuration File/Upload Configuration File to TFTP**, **Upload Log File/Upload Log File to TFTP**, **Reset**, and **Reboot System**

The options include:

- **Download Configuration File/Download Configuration File to NV-RAM** to download a configuration file from a TFTP server indexed as ID 1, 2, or *Active* to NV-RAM.
- **Download Configuration File to SD Card** to download a configuration file from a TFTP server indexed as ID 1, 2, or *Active* to an SD Card.
- **Download Firmware/Download Firmware to NV-RAM** to download a firmware file from a TFTP server indexed as ID 1, 2, or *Active* to NV-RAM.
- **Download Firmware to SD Card** to download a firmware file from a TFTP server indexed as ID 1, 2, or *Active* to an SD Card
- **Upload Configuration File/Upload Configuration File to TFTP** to upload a configuration file to a TFTP server indexed as ID 1, 2, or *Active*.
- **Upload Log File/Upload Log File to TFTP** to upload a log file to a TFTP server.
- **Reset** to reset the system with the exception of the IP address, log, user account, and banner; to reset configuration to the factory default values; or to reset the system to the factory default values and reboot the Switch.
- **Reboot System** to restart the Switch and save the settings from the current session or not.

## Save Configuration

Open the **Save** drop-down menu on the left-hand side of the menu bar at the top of the Web manager and click **Save Configuration** to open the following window:

Figure 11 - 1. Save Configuration window (DGS-3200-10 and DGS-3200-16)

Use the drop-down menu to choose a configuration file indexed as ID *1* or *2* and then click **Apply**.

Figure 11 - 2. Save Configuration window (DGS-3200-24)

Use the drop-down menu to choose a configuration file indexed as ID *1*, *2*, or *Active*, select a Storage Media as a destination (*SD Card* or *NV-RAM*), enter a File Path, and then click **Apply**.

## Save Log

Open the **Save** drop-down menu on the left-hand side of the menu bar at the top of the Web manager and click **Save Log** to open the following window:

Figure 11 - 3. Save Log window (DGS-3200-10 and DGS-3200-16)

To save the current log to *NV-RAM*, click **Apply**.

Figure 11 - 4. Save Log window (DGS-3200-24)

To save the current log, select a Storage Media as a destination (*SD Card* or *NV-RAM*), enter a File Path, and then click **Apply**.

## Save All

Open the **Save** drop-down menu on the left-hand side of the menu bar at the top of the Web manager and click **Save All** to immediately save the current configuration file and current log. The following window will open:

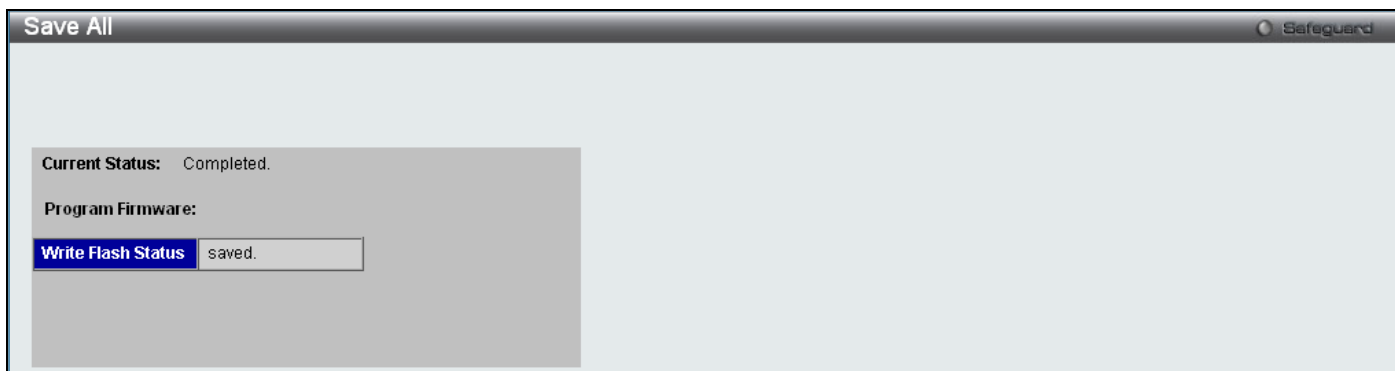

Figure 11 - 5. Save All window

## Download Configuration File/Download Configuration File to NV-RAM

The Switch can store dual configuration files. The configuration files are indexed as *Active*, *1*, or *2*.

Open the **Tools** drop-down menu on the left-hand side of the menu bar at the top of the Web manager and click **Download Configuration File** to open the following window:

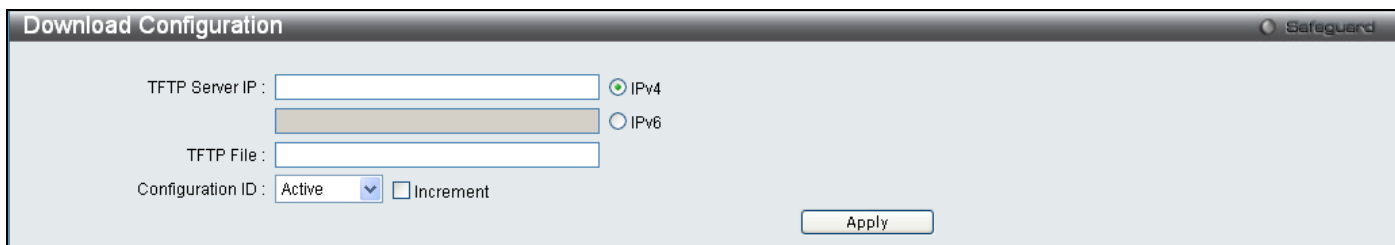

Figure 11 - 6. Download Configuration window (DGS-3200-10 and DGS-3200-16)

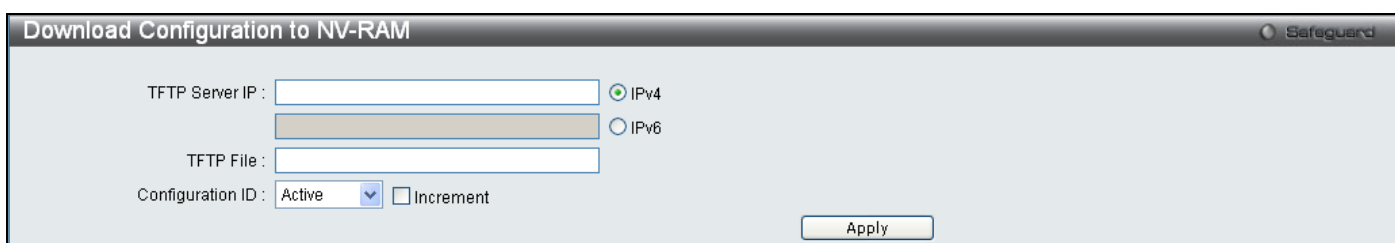

Figure 11 - 7. Download Configuration to NV-RAM window (DGS-3200-24)

Use the radio button to select either IPv4 or IPv6. Enter the TFTP Server IP address for the type of IP selected. Specify the path/file name of the TFTP File. Select the desired Configuration ID, *Active*, *1* or *2*. Tick the **Increment** checkbox to allow the download of a partial switch configuration file. This allows a file to be downloaded that will change only the switch parameters explicitly stated in the configuration file. All other switch parameters will remain unchanged.

Click **Apply** to initiate the file transfer.

## Download Configuration File to SD Card

Figure 11 - 8. Download Configuration File to SD Card window (DGS-3200-24)

Use the radio button to select either IPv4 or IPv6. Enter the TFTP Server IP address for the type of IP selected. Specify the path/file name of the TFTP File. Specify the SD Card File name. Click **Download** to initiate the file transfer.

## Download Firmware/Download Firmware to NV-RAM

The Switch supports dual image storage for firmware file backup and restoration. The firmware images are indexed as *Active*, *1*, or *2*.

Open the **Tools** drop-down menu on the left-hand side of the menu bar at the top of the Web manager and click **Download Firmware** to open the following window:

Figure 11 - 9. Download Firmware window (DGS-3200-10 and DGS-3200-16)

Figure 11 - 10. Download Firmware to NV-RAM window (DGS-3200-24)

Use the radio button to select either IPv4 or IPv6. Enter the TFTP Server IP address for the type of IP selected. Specify the path/file name of the TFTP File. Select the desired Image ID, *Active*, *1* or *2*. Click **Download** to initiate the file transfer.

## Download Firmware to SD Card



**Figure 11 - 11. Download Firmware to SD Card window (DGS-3200-24)**

Use the radio button to select either IPv4 or IPv6. Enter the TFTP Server IP address for the type of IP selected. Specify the path/file name of the TFTP File. Specify the SD Card File name. Click **Download** to initiate the file transfer.

## Upload Configuration File/Upload Configuration File to TFTP

The Switch can store dual configuration files. The configuration files are indexed as *Active*, *1*, or *2*.

Open the **Tools** drop-down menu on the left-hand side of the menu bar at the top of the Web manager and click **Upload Configuration File** to open the following window:

**Figure 11 - 12. Upload Configuration File window (DGS-3200-10 and DGS-3200-16)**

**Figure 11 - 13. Upload Configuration File to TFTP window (DGS-3200-24)**

Use the radio button to select either IPv4 or IPv6. Enter the TFTP Server IP address for the type of IP selected. Specify the path/file name of the TFTP File. Select the desired Configuration ID, *Active*, *1* or *2*. Click **Apply** to initiate the file transfer.

## Upload Log File/Upload Log File to TFTP

A history and attack log can be uploaded from the Switch to a TFTP server.

Open the **Tools** drop-down menu on the left-hand side of the menu bar at the top of the Web manager and click **Upload Log File** to open the following window:

**Figure 11 - 14. Upload Log File window (DGS-3200-10 and DGS-3200-16)**

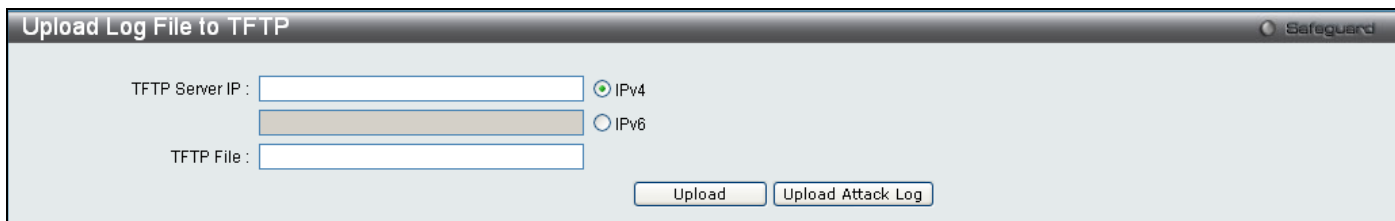

Figure 11 - 15. Upload Log File to TFTP window (DGS-3200-24)

To upload a log file, enter a TFTP Server IP address and TFTP File/path name. Select either IPv4 or IPv6 and then click **Upload** or **Upload Attack Log**.

## Reset

The Reset function has several options when resetting the Switch. Some of the current configuration parameters can be retained while resetting all other configuration parameters to their factory defaults. Reset gives the option of retaining the Switch's User Accounts and History Log, while resetting all other configuration parameters to their factory defaults. If the Switch is reset using this window, and neither **Save Configuration** nor **Save All** is executed, the Switch will return to the last saved configuration when rebooted.

Open the **Tools** drop-down menu on the left-hand side of the menu bar at the top of the Web manager and click **Reset** to open the following window:

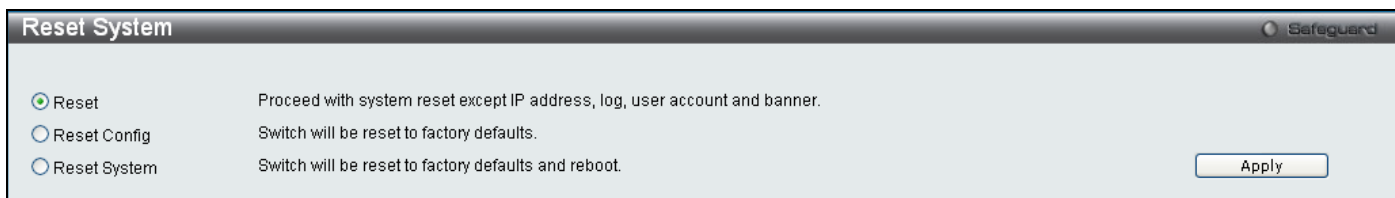

Figure 11 - 16. Reset System window



**NOTE:** Only the Reset System option will enter the factory default parameters into the Switch's non-volatile RAM, and then restart the Switch. All other options enter the factory default values into the current configuration, but do not save this configuration. Reset System will return the Switch's configuration to the state it was when it left the factory.

## Reboot System

The following window is used to restart the Switch.

Open the **Tools** drop-down menu on the left-hand side of the menu bar at the top of the Web manager and click **Reboot System** to open the following window:

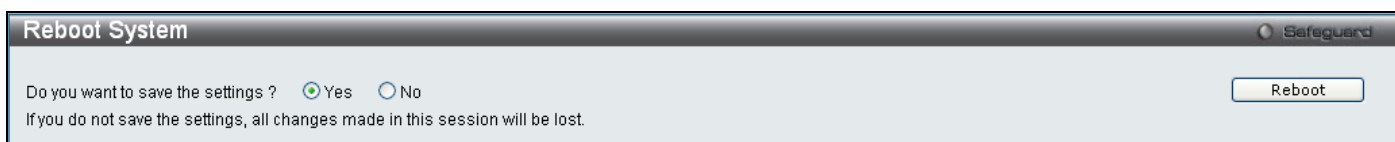

Figure 11 - 17. Reboot System window

Click the **Yes** radio button will instruct the Switch to save the current configuration to non-volatile RAM before restarting the Switch. Click the **No** radio button instructs the Switch not to save the current configuration before restarting the Switch. All of the configuration information entered from the last time either **Save Configuration** or **Save All** was executed will be lost.

Click the **Reboot** button to restart the Switch.

# Appendix A – Mitigating ARP Spoofing Attacks Using Packet Content ACL

## How Address Resolution Protocol works

Address Resolution Protocol (ARP) is the standard method for finding a host’s hardware address (MAC address) when only its IP address is known. However, this protocol is vulnerable because hackers can spoof the IP and MAC information in the ARP packets to attack a LAN (known as ARP spoofing). This document is intended to introduce the ARP protocol, ARP spoofing attacks, and the countermeasures brought by D-Link’s switches to thwart ARP spoofing attacks.

In the process of ARP, PC A will first issue an ARP request to query PC B’s MAC address. The network structure is shown in Figure 1.

Figure 1

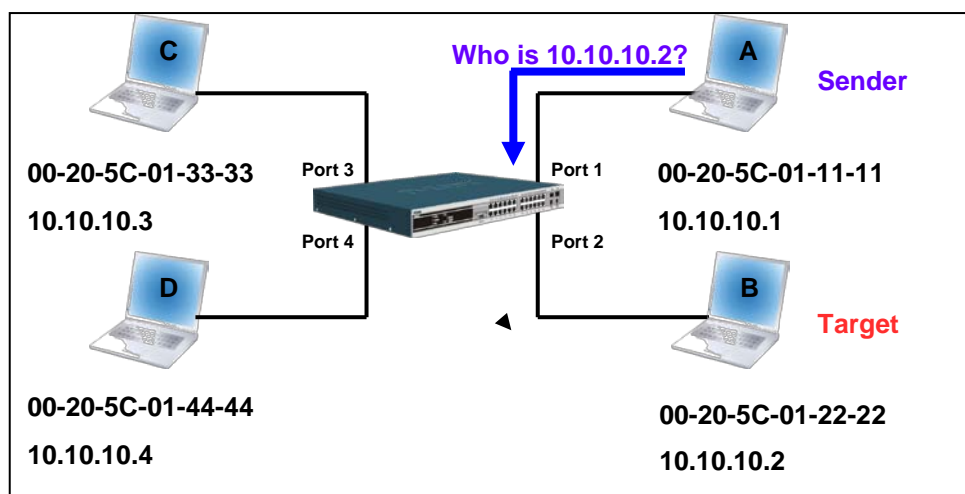

In the meantime, PC A’s MAC address will be written into the “Sender H/W Address” and its IP address will be written into the “Sender Protocol Address” in the ARP payload. As PC B’s MAC address is unknown, the “Target H/W Address” will be “00-00-00-00-00-00,” while PC B’s IP address will be written into the “Target Protocol Address,” shown in Table 1.

Table 1. ARP Payload

H/W Type	Protocol Type	H/W Address Length	Protocol Address Length	Operation	Sender H/W Address	Sender Protocol Address	Target H/W Address	Target Protocol Address
				ARP request	00-20-5C-01-11-11	10.10.10.1	00-00-00-00-00-00	10.10.10.2

The ARP request will be encapsulated into an Ethernet frame and sent out. As can be seen in Table 2, the “Source Address” in the Ethernet frame will be PC A’s MAC address. Since an ARP request is sent via broadcast, the “Destination address” is in a format of Ethernet broadcast (FF-FF-FF-FF-FF-FF).

Table 2. Ethernet Frame Format

Destination Address	Source Address	Ether-Type	ARP	FCS
FF-FF-FF-FF-FF-FF	00-20-5C-01-11-11			

When the switch receives the frame, it will check the “Source Address” in the Ethernet frame’s header. If the address is not in its Forwarding Table, the switch will learn PC A’s MAC and the associated port into its Forwarding Table.



In addition, when the switch receives the broadcasted ARP request, it will flood the frame to all ports except the source port, port 1 (see Figure 2).

Figure 2

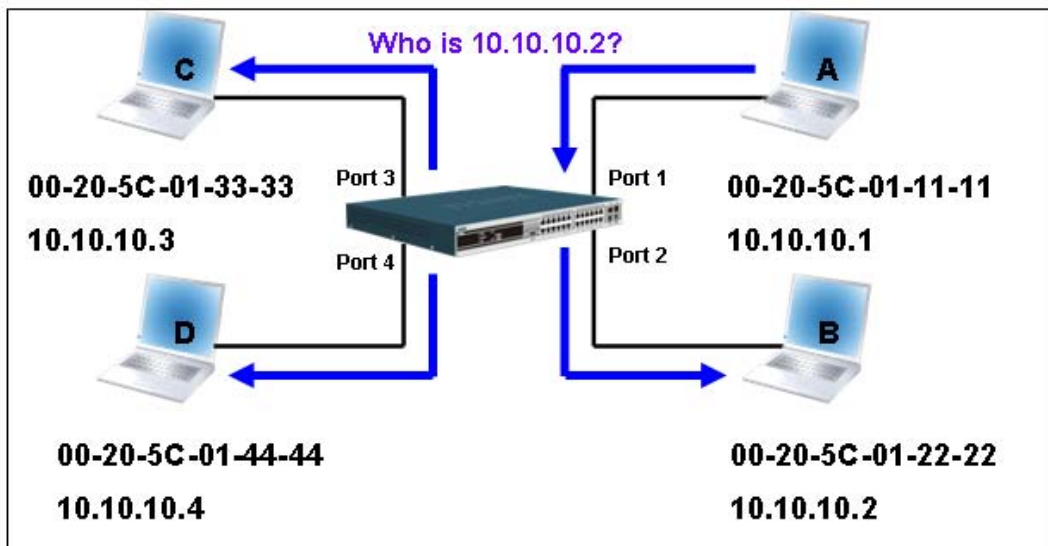

When the switch floods the frame of ARP request to the network, all PCs will receive and examine the frame but only PC B will reply the query as the destination IP matched (see Figure 3).

Figure 3

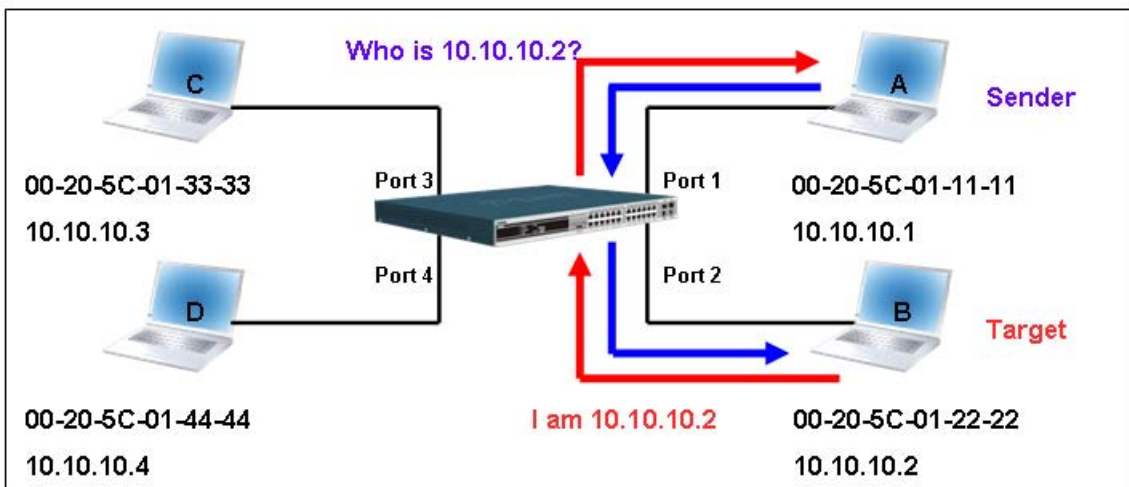

When PC B replies to the ARP request, its MAC address will be written into “Target H/W Address” in the ARP payload shown in Table 3. The ARP reply will be then encapsulated into an Ethernet frame again and sent back to the sender. The ARP reply is in a form of Unicast communication.

Table 3. ARP Payload

H/W Type	Protocol Type	H/W Address Length	Protocol Address Length	Operation	Sender H/W Address	Sender Protocol Address	Target H/W Address	Target Protocol Address
				ARP reply	00-20-5C-01-11-11	10.10.10.1	00-20-5C-01-22-22	10.10.10.2

When PC B replies to the query, the “Destination Address” in the Ethernet frame will be changed to PC A’s MAC address. The “Source Address” will be changed to PC B’s MAC address (see Table 4).

Table 4. Ethernet Frame Format

Destination Address	Source Address	Ether-Type	ARP	FCS
00-20-5C-01-11-11	00-20-5C-01-22-22			

The switch will also examine the “Source Address” of the Ethernet frame and find that the address is not in the Forwarding Table. The switch will learn PC B’s MAC and update its Forwarding Table.

**Forwarding Table**

**Port1** 00-20-5C-01-11-11

**Port2** 00-20-5C-01-22-22

## How ARP Spoofing Attacks a Network

ARP spoofing, also known as ARP poisoning, is a method to attack an Ethernet network which may allow an attacker to sniff data frames on a LAN, modify the traffic, or stop the traffic altogether (known as a Denial of Service – DoS attack). The principle of ARP spoofing is to send the fake or spoofed ARP messages to an Ethernet network. Generally, the aim is to associate the attacker's or random MAC address with the IP address of another node (such as the default gateway). Any traffic meant for that IP address would be mistakenly re-directed to the node specified by the attacker.

IP spoofing attack is caused by Gratuitous ARP that occurs when a host sends an ARP request to resolve its own IP address. Figure-4 shows a hacker within a LAN to initiate ARP spoofing attack.

Figure 4

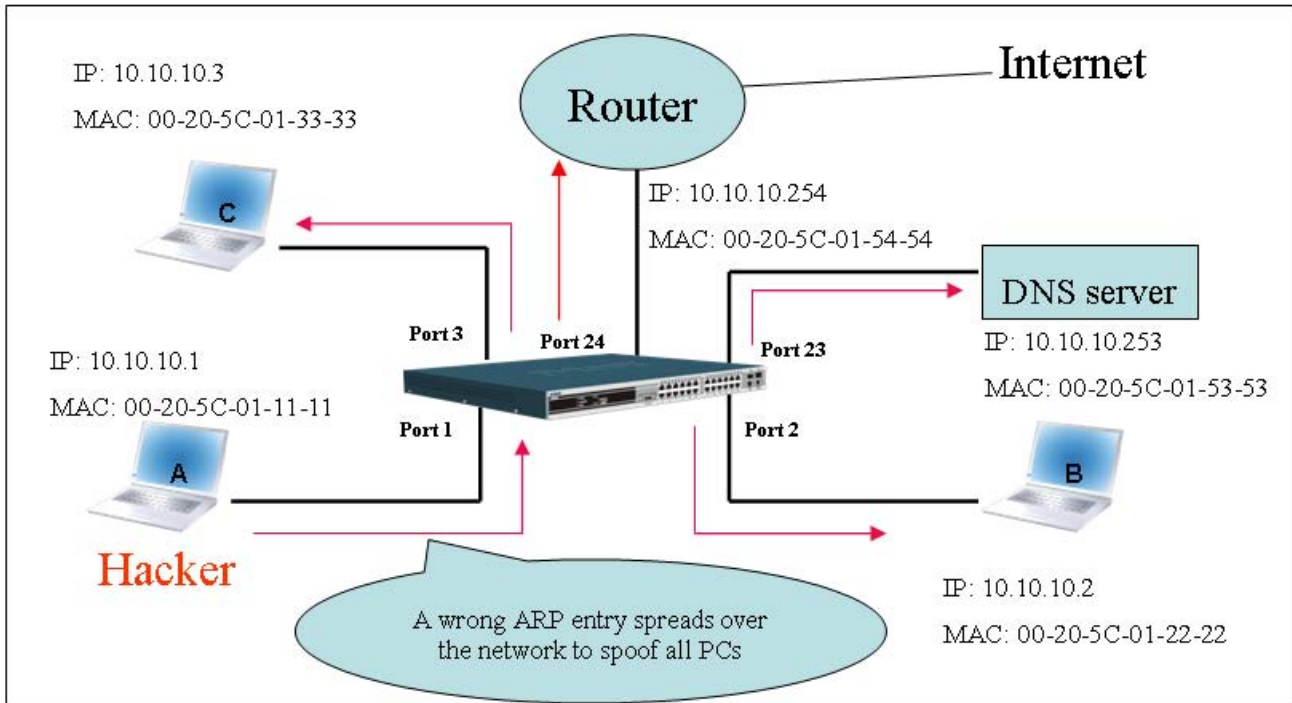

In the Gratuitous ARP packet, the “Sender protocol address” and “Target protocol address” are filled with the same source IP address itself. The “Sender H/W Address” and “Target H/W address” are filled with the same source MAC address itself. The destination MAC address is the Ethernet broadcast address (FF-FF-FF-FF-FF-FF). All nodes within the network will immediately update their own ARP table in accordance with the sender’s MAC and IP address. The format of Gratuitous ARP is shown in the following table.

Table 5

Ethernet Header			Gratuitous ARP									
Destination Address	Source Address	Ethernet Type	H/W Type	Protocol Type	H/W Address Length	Protocol Address Length	Operation	Sender H/W Address	Sender Protocol Address	Target H/W Address	Target Protocol Address	
(6-byte)	(6-byte)	(2-byte)	(2-byte)	(2-byte)	(1-byte)	(1-byte)	(2-byte)	(6-byte)	(4-byte)	(6-byte)	(4-byte)	
FF-FF-FF-FF-FF-FF	00-20-5C-01-11-11	0806					ARP relay	00-20-5C-01-11-11	10.10.10.254	00-20-5C-01-11-11	10.10.10.254	

A common DoS attack today can be done by associating a nonexistent or any specified MAC address to the IP address of the network’s default gateway. The malicious attacker only needs to broadcast one Gratuitous ARP to the network claiming it is the gateway so that the whole network operation will be turned down as all packets to the Internet will be directed to the wrong node.

Likewise, the attacker can either choose to forward the traffic to the actual default gateway (passive sniffing) or modify the data before forwarding it (man-in-the-middle attack). The hacker cheats the victim PC that it is a router and cheats the router that it is the victim. As can be seen in Figure 5 all traffic will be then sniffed by the hacker but the users will not discover.

Figure 5

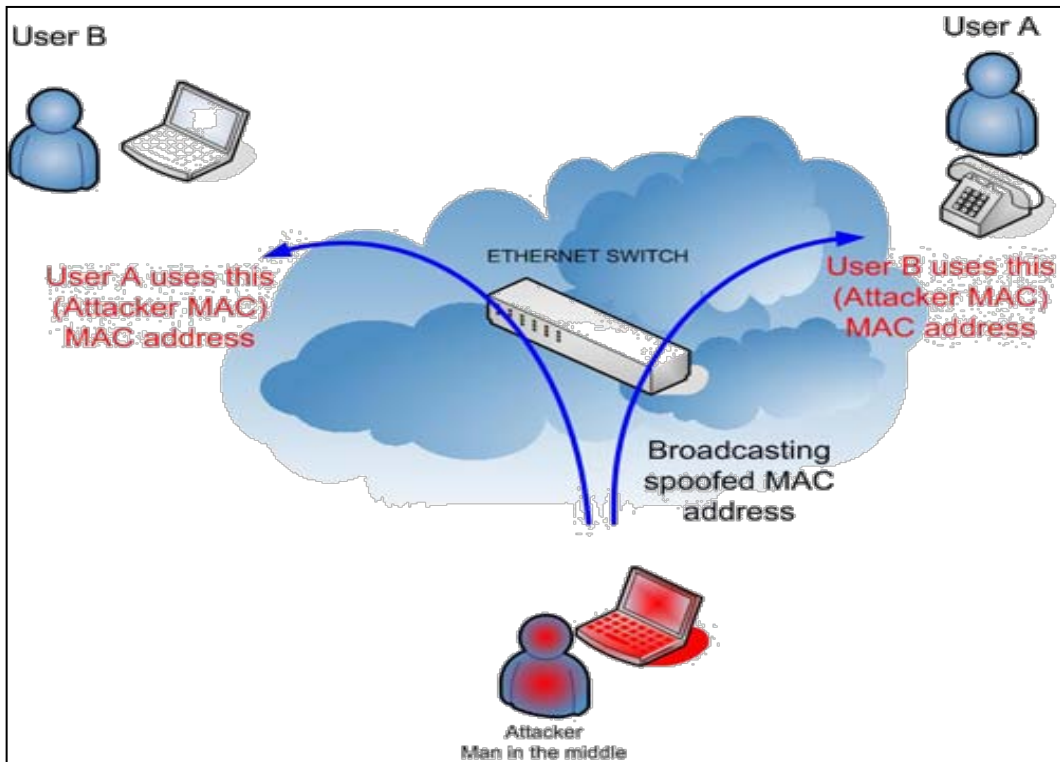

## Prevent ARP Spoofing via Packet Content ACL

D-Link managed switches can effectively mitigate common DoS attacks caused by ARP spoofing via a unique Package Content ACL.

For the reason that basic ACL can only filter ARP packets based on packet type, VLAN ID, Source, and Destination MAC information, there is a need for further inspections of ARP packets. To prevent ARP spoofing attack, we will demonstrate here via using Packet Content ACL on the Switch to block the invalid ARP packets which contain faked gateway's MAC and IP binding.

### Example topology

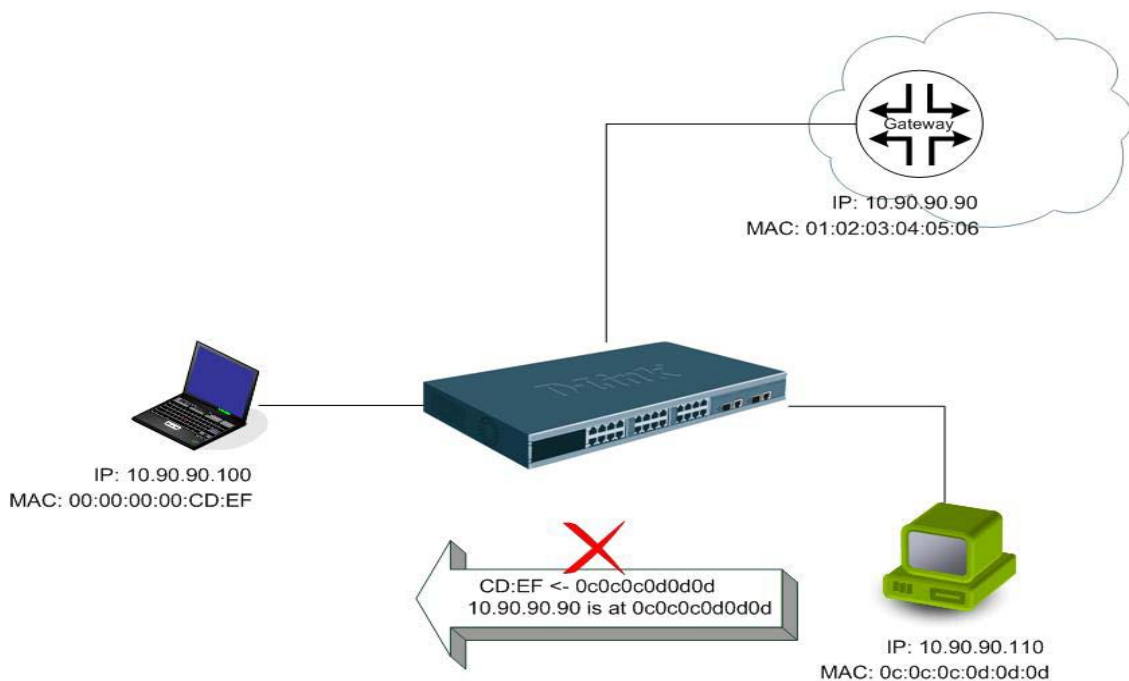

## Configuration

The configuration logic is as follows:

1. Only if the ARP matches Source MAC address in Ethernet, Sender MAC address and Sender IP address in ARP protocol can pass through the switch. (In this example, it is the gateway's ARP.)
2. The switch will deny all other ARP packets which claim they are from the gateway's IP.

The design of Packet Content ACL on the Switch enables users to inspect any offset chunk. An offset chunk is a 4-byte block in a HEX format, which is utilized to match the individual field in an Ethernet frame. Each profile is allowed to contain up to a maximum of four offset chunks. Furthermore, only one single profile of Packet Content ACL can be supported per switch. In other words, up to 16 bytes of total offset chunks can be applied to each profile and a switch. Therefore, a careful consideration is needed for planning and configuration of the valuable offset chunks.

In Table 6, you will notice that the Offset\_Chunk0 starts from the 127<sup>th</sup> byte and ends at the 128<sup>th</sup> byte. It also can be found that the offset chunk is scratched from 1 but not zero.

**Table 6. Chunk and Packet Offset**

Offset Chunk	Offset Chunk0	Offset Chunk1	Offset Chunk2	Offset Chunk3	Offset Chunk4	Offset Chunk5	Offset Chunk6	Offset Chunk7	Offset Chunk8	Offset Chunk9	Offset Chunk10	Offset Chunk11	Offset Chunk12	Offset Chunk13	Offset Chunk14	Offset Chunk15
Byte	127	3	7	11	15	19	23	27	31	35	39	43	47	51	55	59
Byte	128	4	8	12	16	20	24	28	32	36	40	44	48	52	56	60
Byte	1	5	9	13	17	21	25	29	33	37	41	45	49	53	57	61
Byte	2	6	10	14	18	22	26	30	34	38	42	46	50	54	58	62

Offset Chunk	Offset Chunk16	Offset Chunk17	Offset Chunk18	Offset Chunk19	Offset Chunk20	Offset Chunk21	Offset Chunk22	Offset Chunk23	Offset Chunk24	Offset Chunk25	Offset Chunk26	Offset Chunk27	Offset Chunk28	Offset Chunk29	Offset Chunk30	Offset Chunk31
Byte	63	67	71	75	79	83	87	91	95	99	103	107	111	115	119	123
Byte	64	68	72	76	80	84	88	92	96	100	104	108	112	116	120	124
Byte	65	69	73	77	81	85	89	93	97	101	105	109	113	117	121	125
Byte	66	70	74	78	82	86	90	94	98	102	106	110	114	118	122	126

The following table indicates a completed ARP packet contained in Ethernet frame which is the pattern for the calculation of packet offset.

**Table 7. A Completed ARP Packet Contained in an Ethernet Frame**

Ethernet Header				ARP							
Destination Address	Source Address	Ethernet Type	H/W Type	Protocol Type	H/W Address Length	Protocol Address Length	Operation	Sender H/W Address	Sender Protocol Address	Target H/W Address	Target Protocol Address
(6-byte)	(6-byte)	(2-byte)	(2-byte)	(2-byte)	(1-byte)	(1-byte)	(2-byte)	(6-byte)	(4-byte)	(6-byte)	(4-byte)
	01 02 03 04 05 06	0806							0a5a5a5a		(10.90.90.90)



	Command	Description
<b>Step1</b>	create access_profile profile_id 1 profile_name 1 ethernet source_mac FF-FF-FF-FF-FF-FF ethernet_type	- Create access profile 1 To match <b>Ethernet Type</b> and <b>Source MAC</b> address.
<b>Step2</b>	config access_profile profile_id 1 add access_id 1 ethernet source_mac 01-02-03-04-05-06 ethernet_type 0x806 port 1-12 permit	- Configure access profile 1 - Only if the gateway's ARP packet that contains the correct <b>Source MAC</b> in the Ethernet frame can pass through the switch.
<b>Step3</b>	create access_profile profile_id 2 profile_name 2 packet_content_mask  offset_chunk_1 3 0x0000FFFF Ethernet Type (2-byte)  offset_chunk_2 7 0x0000FFFF SdrIP (First 2-byte)  offset_chunk_3 8 0xFFFF0000 SdrIP (Last 2-byte)	- Create access profile 2 - The first Chunk starts from Chunk 3: mask for <b>Ethernet Type</b> (Blue in Table-6:13 <sup>th</sup> & 14 <sup>th</sup> bytes) - The second Chunk starts from Chunk 7: mask for <b>Sender IP (First 2-byte)</b> in ARP packet (Green in Table-6: 29 <sup>th</sup> & 30 <sup>th</sup> bytes) - The third Chunk starts from Chunk 8: mask for <b>Sender IP (Last 2-byte)</b> in ARP packet (Brown in Table-6: 31 <sup>st</sup> & 32 <sup>nd</sup> bytes)
<b>Step4</b>	config access_profile profile_id 2 add access_id 1 packet_content offset_chunk_1 0x00000806 Ethernet Type (2-byte):ARP offset_chunk_2 0x00000A5A SdrIP (First 2-byte): 10.90 offset_chunk_3 0x5A5A0000 SdrIP(Last 2-byte): 90.90 port 1-12 deny	- Configure access profile 2 - The rest of the ARP packets whose <b>Sender IP</b> claim they are the gateway's IP will be dropped.
<b>Step5</b>	Save	- Save config

# Appendix B – Password Recovery Procedure

This document describes the procedure for resetting passwords on D-Link Switches.

Authenticating any user who tries to access networks is necessary and important. The basic authentication method used to accept qualified users is through a local login, utilizing a Username and Password. Sometimes, passwords get forgotten or destroyed, so network administrators need to reset these passwords. This document will explain how the Password Recovery feature can help network administrators reach this goal.

The following steps explain how to use the Password Recovery feature on D-Link devices to easily recover passwords.

**Complete these steps to reset the password:**

1. For security reasons, the Password Recovery feature requires the user to physically access the device. Therefore this feature is only applicable when there is a direct connection to the console port of the device. It is necessary for the user needs to attach a terminal or PC with terminal emulation to the console port of the switch.
2. Power on the Switch. After the runtime image is loaded to 100%, the Switch will allow 2 seconds for the user to press the hotkey [^] (Shift + 6) to enter the “Password Recovery Mode.” Once the Switch enters the “Password Recovery Mode,” all ports on the Switch will be disabled.

```

Boot Procedure V1.00.B008
-----
Power On Self Test ..... 100%

MAC Address   : 00-21-91-92-E3-5E
H/W Version   : A2

Please Wait, Loading V1.50.B017 Runtime Image..... 100%
    
```

```

Password Recovery Mode
>
    
```

3. In the “Password Recovery Mode” only the following commands can be used.

Command	Parameters
<b>reset config</b> {force_agree}	This command resets the whole configuration back to the default values.
<b>reboot</b> {force_agree}	This command exits the Reset Password Recovery Mode and restarts the switch. A confirmation message will be displayed to allow the user to save the current settings.
<b>reset account</b>	The <b>reset account</b> command deletes all the previously created accounts.
<b>reset password</b> {<username>}	The <b>reset password</b> command resets the password of the specified user. If a username is not specified, the passwords of all users will be reset.
<b>show account</b>	The <b>show account</b> command displays all previously created accounts.

## Appendix C – System Log Entries

The following table lists all possible entries and their corresponding meanings that will appear in the System Log of this Switch.

Category	Event Description	Log Information	Severity	Remark
<b>System</b>	System started up	System started up	Critical	
	Configuration saved to flash	Configuration saved to flash by console (Username: <username>)	Informational	"by console" and "IP": <ipaddr>, MAC: <macaddr>" are XOR shown in log string, which means if user login by console, there will no IP and MAC information for logging.
	System log saved to flash	System log saved to flash by console (Username: <username>, IP: <ipaddr>, MAC: <macaddr>)	Informational	"by console" and "IP": <ipaddr>, MAC: <macaddr>" are XOR shown in log string, which means if user login by console, there will no IP and MAC information for logging.
	Configuration and log saved to flash	Configuration and log saved to flash by console (Username: <username>, IP: <ipaddr>, MAC: <macaddr>)	Informational	"by console" and "IP": <ipaddr>, MAC: <macaddr>" are XOR shown in log string, which means if user login by console, there will no IP and MAC information for logging.
	Left side fan failed	Left side fan <fanID> failed	Critical	For DGS3200-16 and DGS3200-24 only
	Left side fan recovered	Left side fan <fanID> recovered	Critical	For DGS3200-16 and DGS3200-24 only
	Internal Power failed	Internal Power failed	Critical	For DGS3200-24 only
	Internal Power is recovered	Internal Power is recovered	Critical	For DGS3200-24 only
	Redundant Power failed	Redundant Power failed	Critical	For DGS3200-24 only
	Redundant Power is working	Redundant Power is working	Critical	For DGS3200-24 only
<b>Up/Down-load</b>	Firmware upgraded successfully by console	Firmware upgraded successfully by console (Username: <username>, IP: <ipaddr>)	Informational	"by console" and "IP": <ipaddr>, MAC: <macaddr>" are XOR shown in log string, which means if user login by console, will no IP and MAC information for logging
	Firmware upgrade was unsuccessful by console	Firmware upgrade was unsuccessful by console! (Username: <username>, IP: <ipaddr>)	Warning	"by console" and "IP": <ipaddr>, MAC: <macaddr>" are XOR shown in log string, which means if user login by console, will no IP and MAC information for logging
	Configuration successfully downloaded by	Configuration successfully downloaded by console	Informational	"by console" and "IP": <ipaddr>, MAC: <macaddr>" are XOR shown in log string, which means

	console	(Username: <username>, IP: <ipaddr>)		if user login by console, will no IP and MAC information for logging
	Configuration download was unsuccessful by console	Configuration download was unsuccessful by console! (Username: <username>, IP: <ipaddr>)	Warning	"by console" and "IP": <ipaddr>, MAC: <macaddr>" are XOR shown in log string, which means if user login by console, will no IP and MAC information for logging
	Configuration successfully uploaded by console	Configuration successfully uploaded by console (Username: <username>, IP: <ipaddr>, MAC: <macaddr>)	Informational	"by console" and "IP": <ipaddr>, MAC: <macaddr>" are XOR shown in log string, which means if user login by console, will no IP and MAC information for logging
	Configuration upload was unsuccessful by console	Configuration upload was unsuccessful by console! (Username: <username>, IP: <ipaddr>, MAC: <macaddr>)	Warning	"by console" and "IP": <ipaddr>, MAC: <macaddr>" are XOR shown in log string, which means if user login by console, will no IP and MAC information for logging
	Log message successfully uploaded by console	Log message successfully uploaded by console (Username: <username>, IP: <ipaddr>)	Informational	"by console" and "IP": <ipaddr>, MAC: <macaddr>" are XOR shown in log string, which means if user login by console, will no IP and MAC information for logging
	Log message upload was unsuccessful by console	Log message upload by console was unsuccessful! (Username: <username>, IP: <ipaddr>)	Warning	"by console" and "IP": <ipaddr>, MAC: <macaddr>" are XOR shown in log string, which means if user login by console, will no IP and MAC information for logging
	Firmware upgraded successfully by web	Firmware upgraded successfully by Web (Username: <username>, IP: <ipaddr>)	Informational	"by console" and "IP": <ipaddr>, MAC: <macaddr>" are XOR shown in log string, which means if user login by console, will no IP and MAC information for logging
	Firmware upgrade was unsuccessful by web	Firmware upgrade was unsuccessful by Web! (Username: <username>, IP: <ipaddr>)	Warning	"by console" and "IP": <ipaddr>, MAC: <macaddr>" are XOR shown in log string, which means if user login by console, will no IP and MAC information for logging
	Configuration successfully downloaded by web	Configuration successfully downloaded by Web (Username: <username>, IP: <ipaddr>)	Informational	"by console" and "IP": <ipaddr>, MAC: <macaddr>" are XOR shown in log string, which means if user login by console, will no IP and MAC information for logging
	Configuration download was unsuccessful by web	Configuration download by Web was unsuccessful by Web! (Username: <username>, IP: <ipaddr>)	Warning	"by console" and "IP": <ipaddr>, MAC: <macaddr>" are XOR shown in log string, which means if user login by console, will no IP and MAC information for logging

	Configuration successfully uploaded by web	Configuration successfully uploaded by web (Username: <username>, IP: <ipaddr>, MAC: <macaddr>)	Informational	"by console" and "IP": <ipaddr>, MAC: <macaddr>" are XOR shown in log string, which means if user login by console, will no IP and MAC information for logging
	Configuration upload was unsuccessful by web	Configuration upload was unsuccessful by Web! (Username: <username>, IP: <ipaddr>, MAC: <macaddr>)	Warning	"by console" and "IP": <ipaddr>, MAC: <macaddr>" are XOR shown in log string, which means if user login by console, will no IP and MAC information for logging
	Log message successfully uploaded by web	Log message successfully uploaded by web (Username: <username>, IP: <ipaddr>)	Informational	"by console" and "IP": <ipaddr>, MAC: <macaddr>" are XOR shown in log string, which means if user login by console, will no IP and MAC information for logging
	Log message upload was unsuccessful by web	Log message upload was unsuccessful by Web! (Username: <username>, IP: <ipaddr>)	Warning	"by console" and "IP": <ipaddr>, MAC: <macaddr>" are XOR shown in log string, which means if user login by console, will no IP and MAC information for logging
	Firmware upgraded successfully by telnet	Firmware upgraded successfully Telnet (Username: <username>, IP: <ipaddr>)	Informational	"by console" and "IP": <ipaddr>, MAC: <macaddr>" are XOR shown in log string, which means if user login by console, will no IP and MAC information for logging
	Firmware upgrade was unsuccessful by telnet	Firmware upgrade was unsuccessful by Telnet ! (Username: <username>, IP: <ipaddr>)	Warning	"by console" and "IP": <ipaddr>, MAC: <macaddr>" are XOR shown in log string, which means if user login by console, will no IP and MAC information for logging
	Configuration successfully downloaded by telnet	Configuration successfully downloaded by Telnet (Username: <username>, IP: <ipaddr>)	Informational	"by console" and "IP": <ipaddr>, MAC: <macaddr>" are XOR shown in log string, which means if user login by console, will no IP and MAC information for logging
	Configuration download was unsuccessful by telnet	Configuration download was unsuccessful by Telnet! (Username: <username>, IP: <ipaddr>)	Warning	"by console" and "IP": <ipaddr>, MAC: <macaddr>" are XOR shown in log string, which means if user login by console, will no IP and MAC information for logging
	Configuration successfully uploaded by telnet	Configuration successfully uploaded by Telnet (Username: <username>, IP: <ipaddr>, MAC: <macaddr>)	Informational	"by console" and "IP": <ipaddr>, MAC: <macaddr>" are XOR shown in log string, which means if user login by console, will no IP and MAC information for logging
	Configuration upload was unsuccessful by telnet	Configuration upload was unsuccessful by Telnet! (Username: <username>, IP: <ipaddr>, MAC: <macaddr>)	Warning	"by console" and "IP": <ipaddr>, MAC: <macaddr>" are XOR shown in log string, which means if user login by console, will no IP and MAC information for logging

		<macaddr>)		and MAC information for logging
	Log message successfully uploaded by telnet	Log message successfully uploaded by Telnet (Username: <username>, IP: <ipaddr>)	Informational	"by console" and "IP": <ipaddr>, MAC: <macaddr>" are XOR shown in log string, which means if user login by console, will no IP and MAC information for logging
	Log message upload was unsuccessful by telnet	Log message upload was unsuccessful by Telnet! (Username: <username>, IP: <ipaddr>)	Warning	"by console" and "IP": <ipaddr>, MAC: <macaddr>" are XOR shown in log string, which means if user login by console, will no IP and MAC information for logging
	Firmware upgraded successfully by snmp	Firmware upgraded successfully SNMP (Username: <username>, IP: <ipaddr>)	Informational	"by console" and "IP": <ipaddr>, MAC: <macaddr>" are XOR shown in log string, which means if user login by console, will no IP and MAC information for logging
	Firmware upgrade was unsuccessful by snmp	Firmware upgrade was unsuccessful by SNMP ! (Username: <username>, IP: <ipaddr>)	Warning	"by console" and "IP": <ipaddr>, MAC: <macaddr>" are XOR shown in log string, which means if user login by console, will no IP and MAC information for logging
	Configuration successfully downloaded by snmp	Configuration successfully downloaded by SNMP (Username: <username>, IP: <ipaddr>)	Informational	"by console" and "IP": <ipaddr>, MAC: <macaddr>" are XOR shown in log string, which means if user login by console, will no IP and MAC information for logging
	Configuration download was unsuccessful by snmp	Configuration download was unsuccessful by SNMP! (Username: <username>, IP: <ipaddr>)	Warning	"by console" and "IP": <ipaddr>, MAC: <macaddr>" are XOR shown in log string, which means if user login by console, will no IP and MAC information for logging
	Configuration successfully uploaded by snmp	Configuration successfully uploaded by SNMP (Username: <username>, IP: <ipaddr>, MAC: <macaddr>)	Informational	"by console" and "IP": <ipaddr>, MAC: <macaddr>" are XOR shown in log string, which means if user login by console, will no IP and MAC information for logging
	Configuration upload was unsuccessful by snmp	Configuration upload was unsuccessful by SNMP! (Username: <username>, IP: <ipaddr>, MAC: <macaddr>)	Warning	"by console" and "IP": <ipaddr>, MAC: <macaddr>" are XOR shown in log string, which means if user login by console, will no IP and MAC information for logging
	Log message successfully uploaded by snmp	Log message successfully uploaded by SNMP (Username: <username>, IP: <ipaddr>)	Informational	"by console" and "IP": <ipaddr>, MAC: <macaddr>" are XOR shown in log string, which means if user login by console, will no IP and MAC information for logging
	Log message upload was unsuccessful by snmp	Log message upload was unsuccessful by SNMP! (Username: <username>, IP: <ipaddr>)	Warning	"by console" and "IP": <ipaddr>, MAC: <macaddr>" are XOR shown in log string, which means if user login by console, will no IP and MAC information for logging

		<ipaddr>		and MAC information for logging
<b>Interface</b>	Port link up	Port <portNum> link up, <link state>	Informational	link state, for ex: , 100Mbps FULL duplex
	Port link down	Port <portNum> link down	Informational	
	Link aggregation Group linkUp/linkDown	Link aggregation Group %d (Interface: %d) link up/Link aggregation Group %d (Interface: %d) link down	Information	
<b>Console</b>	Successful login through Console	Successful login through Console (Username: <username>)	Informational	There are no IP and MAC if login by console.
	Login failed through Console	Login failed through Console (Username: <username>)	Warning	There are no IP and MAC if login by console.
	Logout through Console	Logout through Console (Username: <username>)	Informational	There are no IP and MAC if login by console.
	Console session timed out	Console session timed out (Username: <username>)	Informational	There are no IP and MAC if login by console.
<b>Web</b>	Successful login through Web	Successful login through Web (Username: <username>, IP: <ipaddr>)	Informational	
	Login failed through Web	Login failed through Web (Username: <username>, IP: <ipaddr>)	Warning	
	Logout through Web	Logout through Web (Username: <username>, IP: <ipaddr>)	Informational	
	Successful login through Web (SSL)	Successful login through Web (SSL) (Username: <username>, IP: <ipaddr>)	Informational	
	Login failed through Web (SSL)	Login failed through Web (SSL) (Username: <username>, IP: <ipaddr>)	Warning	
	Logout through Web (SSL)	Logout through Web (SSL) (Username: <username>, IP: <ipaddr>)	Informational	
	Web (SSL) session timed out	Web (SSL) session timed out (Username:	Informational	

		<username>, IP: <ipaddr>		
<b>Telnet</b>	Successful login through Telnet	Successful login through Telnet (Username: <username>, IP: <ipaddr>)	Informational	
	Login failed through Telnet	Login failed through Telnet (Username: <username>, IP: <ipaddr>)	Warning	
	Logout through Telnet	Logout through Telnet (Username: <username>, IP: <ipaddr>)	Informational	
	Telnet session timed out	Telnet session timed out (Username: <username>, IP: <ipaddr>)	Informational	
<b>SNMP</b>	SNMP request received with invalid community string	SNMP request received from <ipAddress> with invalid community string!	Informational	
<b>STP</b>	Topology changed	Topology changed (Instance: <InstanceID> port:<portNum>)]	Informational	Detected Topology changed port
	New Root selected	[CIST   MIST Regional] New root selected [( [Instance: <InstanceID>] Root bridge MAC: <macaddr> Priority :<value>)]	Informational	root bridge MAC address and priority at the instance
	Spanning Tree Protocol is enabled	Spanning Tree Protocol is enabled	Informational	
	Spanning Tree Protocol is disabled	Spanning Tree Protocol is disabled	Informational	
<b>DoS</b>	Spoofing attack	Possible spoofing attack from <macAddress> port <portNum>	Critical	
	Spoofing attack enhance	Possible spoofing attack from IP: <ipAddress> MAC: <macAddress> port: <portNum>	Critical	
<b>SSH</b>	Successful login through SSH	Successful login through SSH (Username: <username>, IP: <ipaddr>)	Informational	
	Login failed through SSH	Login failed through SSH (Username: <username>, IP: <ipaddr>)	Warning	



		<ipaddr>		
	Logout through SSH	Logout through SSH (Username: <username>, IP: <ipaddr>)	Informational	
	SSH session timed out	SSH session timed out (Username: <username>, IP: <ipaddr>)	Informational	
	SSH server is enabled	SSH server is enabled	Informational	
	SSH server is disabled	SSH server is disabled	Informational	
<b>AAA</b>	Authentication Policy is enabled	Authentication Policy is enabled (Module: AAA)	Informational	
	Authentication Policy is disabled	Authentication Policy is disabled (Module: AAA)	Informational	
	Successful login through Console authenticated by AAA local method	Successful login through Console authenticated by AAA local method (Username: <username>)	Informational	
	Login failed through Console authenticated by AAA local method	Login failed through Console authenticated by AAA local method (Username: <username>)	Warning	
	Successful login through Web authenticated by AAA local method	Successful login through Web from <userIP> authenticated by AAA local method (Username: <username>)	Informational	
	Login failed through Web authenticated by AAA local method	Login failed through Web from <userIP> authenticated by AAA local method (Username: <username>)	Warning	
	Successful login through Web (SSL) authenticated by AAA local method	Successful login through Web (SSL) from <userIP> authenticated by AAA local method (Username: <username>)	Informational	
	Login failed through Web (SSL) authenticated by AAA local method	Login failed through Web (SSL) from <userIP> authenticated by AAA local method (Username: <username>)	Warning	

	Successful login through Telnet authenticated by AAA local method	Successful login through Telnet from <userIP> authenticated by AAA local method (Username: <username>)	Informational	
	Login failed through Telnet authenticated by AAA local method	Login failed through Telnet from <userIP> authenticated by AAA local method (Username: <username>)	Warning	
	Successful login through SSH authenticated by AAA local method	Successful login through SSH from <userIP> authenticated by AAA local method (Username: <username>)	Informational	
	Login failed through SSH authenticated by AAA local method	Login failed through SSH from <userIP> authenticated by AAA local method (Username: <username>)	Warning	
	Successful login through Console authenticated by AAA none method	Successful login through Console authenticated by AAA none method (Username: <username>)	Informational	
	Successful login through Web authenticated by AAA none method	Successful login through Web from <userIP> authenticated by AAA none method (Username: <username>)	Informational	
	Successful login through Web (SSL) authenticated by AAA none method	Successful login through Web (SSL) from <userIP> authenticated by AAA none method (Username: <username>)	Informational	
	Successful login through Telnet authenticated by AAA none method	Successful login through Telnet from <userIP> authenticated by AAA none method (Username: <username>)	Informational	
	Successful login through SSH authenticated by AAA none method	Successful login through SSH from <userIP> authenticated by AAA none method (Username: <username>)	Informational	

	Successful login through Console authenticated by AAA server	Successful login through Console authenticated by AAA server <serverIP> (Username: <username>)	Informational	There are no IP and MAC if login by console.
	Login failed through Console authenticated by AAA server	Login failed through Console authenticated by AAA server <serverIP> (Username: <username>)	Warning	There are no IP and MAC if login by console.
	Login failed through Console due to AAA server timeout or improper configuration	Login failed through Console due to AAA server timeout or improper configuration (Username: <username>)	Warning	
	Successful login through Web authenticated by AAA server	Successful login through Web from <userIP> authenticated by AAA server <serverIP> (Username: <username>)	Informational	
	Login failed through Web authenticated by AAA server	Login failed through Web from <userIP> authenticated by AAA server <serverIP> (Username: <username>)	Warning	
	Login failed through Web due to AAA server timeout or improper configuration	Login failed through Web from <userIP> due to AAA server timeout or improper configuration (Username: <username>)	Warning	
	Successful login through Web (SSL) authenticated by AAA server	Successful login through Web(SSL) from <userIP> authenticated by AAA server <serverIP> (Username: <username>)	Informational	
	Login failed through Web (SSL) authenticated by AAA server	Login failed through Web (SSL) from <userIP> authenticated by AAA server <serverIP> (Username: <username>)	Warning	
	Login failed through Web (SSL) due to AAA server timeout or improper configuration	Login failed through Web (SSL) from <userIP> due to AAA server timeout or improper configuration (Username: <username>)	Warning	

	Successful login through Telnet authenticated by AAA server	Successful login through Telnet from <userIP> authenticated by AAA server <serverIP> (Username: <username>)	Informational	
	Login failed through Telnet authenticated by AAA server	Login failed through Telnet from <userIP> authenticated by AAA server <serverIP> (Username: <username>)	Warning	
	Successful login through SSH authenticated by AAA server	Successful login through SSH from <userIP> authenticated by AAA server <serverIP> (Username: <username>)	Informational	
	Successful Enable Admin through Console authenticated by AAA local_enable method	Successful Enable Admin through Console authenticated by AAA local_enable method (Username: <username>)	Informational	
	Enable Admin failed through Console authenticated by AAA local_enable method	Enable Admin failed through Console authenticated by AAA local_enable method (Username: <username>)	Warning	
	Successful Enable Admin through Web authenticated by AAA local_enable method	Successful Enable Admin through Web from <userIP> authenticated by AAA local_enable method (Username: <username>)	Informational	
	Enable Admin failed through Web authenticated by AAA local_enable method	Enable Admin failed through Web from <userIP> authenticated by AAA local_enable method (Username: <username>)	Warning	
	Successful Enable Admin through Telnet authenticated by AAA local_enable method	Successful Enable Admin through Telnet from <userIP> authenticated by AAA local_enable method (Username: <username>)	Informational	
	Successful Enable Admin through SSH authenticated by AAA local_enable method	Successful Enable Admin through SSH from <userIP> authenticated by AAA local_enable method	Informational	

		(Username: <username>)		
	Enable Admin failed through SSH authenticated by AAA local_enable method	Enable Admin failed through SSH from <userIP> authenticated by AAA local_enable method (Username: <username>)	Warning	
	Successful Enable Admin through Console authenticated by AAA none method	Successful Enable Admin through Console authenticated by AAA none method (Username: <username>)	Informational	
	Successful Enable Admin through Web authenticated by AAA none method	Successful Enable Admin through Web from <userIP> authenticated by AAA none method (Username: <username>)	Informational	
	Successful Enable Admin through Web (SSL) authenticated by AAA none method	Successful Enable Admin through Web (SSL) from <userIP> authenticated by AAA none method (Username: <username>)	Informational	
	Successful Enable Admin through Telnet authenticated by AAA none method	Successful Enable Admin through Telnet from <userIP> authenticated by AAA none method (Username: <username>)	Informational	
	Successful Enable Admin through SSH authenticated by AAA none method	Successful Enable Admin through SSH from <userIP> authenticated by AAA none method (Username: <username>)	Informational	
	Successful Enable Admin through Console authenticated by AAA server	Successful Enable Admin through Console authenticated by AAA server <serverIP> (Username: <username>)	Informational	
	Enable Admin failed through Console authenticated by AAA server	Enable Admin failed through Console authenticated by AAA server <serverIP> (Username: <username>)	Warning	

	Enable Admin failed through Console due to AAA server timeout or improper configuration	Enable Admin failed through Console due to AAA server timeout or improper configuration (Username: <username>)	Warning	
	Successful Enable Admin through Web authenticated by AAA server	Successful Enable Admin through Web from <userIP> authenticated by AAA server <serverIP> (Username: <username>)	Informational	
	Enable Admin failed through Web authenticated by AAA server	Enable Admin failed through Web from <userIP> authenticated by AAA server <serverIP> (Username: <username>)	Warning	
	Enable Admin failed through Web due to AAA server timeout or improper configuration	Enable Admin failed through Web from <userIP> due to AAA server timeout or improper configuration (Username: <username>)	Warning	
	Successful Enable Admin through Web (SSL) authenticated by AAA server	Successful Enable Admin through Web (SSL) from <userIP> authenticated by AAA server <serverIP> (Username: <username>)	Informational	
	Enable Admin failed through Web (SSL) authenticated by AAA server	Enable Admin failed through Web (SSL) from <userIP> authenticated by AAA server <serverIP> (Username: <username>)	Warning	
	Enable Admin failed through Web (SSL) due to AAA server timeout or improper configuration	Enable Admin failed through Web (SSL) from <userIP> due to AAA server timeout or improper configuration (Username: <username>)	Warning	
	Successful Enable Admin through Telnet authenticated by AAA server	Successful Enable Admin through Telnet from <userIP> authenticated by AAA server <serverIP> (Username: <username>)	Informational	

	Enable Admin failed through Telnet authenticated by AAA server	Enable Admin failed through Telnet from <userIP> authenticated by AAA server <serverIP> (Username: <username>)	Warning	
	Enable Admin failed through Telnet due to AAA server timeout or improper configuration	Enable Admin failed through Telnet from <userIP> due to AAA server timeout or improper configuration (Username: <username>)	Warning	
	Successful Enable Admin through SSH authenticated by AAA server	Successful Enable Admin through SSH from <userIP> authenticated by AAA server <serverIP> (Username: <username>)	Informational	
	Enable Admin failed through SSH authenticated by AAA server	Enable Admin failed through SSH from <userIP> authenticated by AAA server <serverIP> (Username: <username>)	Warning	
	Enable Admin failed through SSH due to AAA server timeout or improper configuration	Enable Admin failed through SSH from <userIP> due to AAA server timeout or improper configuration (Username: <username>)	Warning	
	AAA server timed out	AAA server <serverIP> (Protocol: <protocol>) connection failed	Warning	<protocol> is one of TACACS, XTACACS, TACACS+, RADIUS
	AAA server ACK error	AAA server <serverIP> (Protocol: <protocol>) response is wrong	Warning	<protocol> is one of TACACS, XTACACS, TACACS+, RADIUS
	AAA does not support this functionality	AAA doesn't support this functionality	Informational	
<b>IP-MAC-PORT Binding</b>	Unauthenticated IP address and discard by IP MAC port binding	Unauthenticated IP-MAC address and discarded by IP MAC port binding (IP: < ipaddr >   < ipv6addr >, MAC: <macaddr>, Port <portNum>)	Warning	
	Dynamic IMPB entry is conflict with static FDB	Dynamic IMPB entry is conflict with static FDB (IP: < ipaddr >   < ipv6addr >, MAC: <macaddr>, Port	Warning	

		<portNum>)		
	Dynamic IMPB entry is conflict with static ARP	Dynamic IMPB entry is conflict with static ARP (IP: <ipaddr>, MAC: <macaddr>, Port <portNum>)	Warning	
	Dynamic IMPB entry is conflict with static IMPB	Dynamic IMPB entry is conflict with static IMPB (IP: <ipaddr >   <ipv6addr >, MAC: <macaddr>, Port <portNum>)	Warning	
	Creating IMPB entry Failed due to no ACL rule available	Creating IMPB entry Failed due to no ACL rule available (IP: <ipaddr >   <ipv6addr >, MAC: <macaddr>, Port <portNum>)	Warning	
	Port enter IMPB block state	Port <portNum> enter IMPB block state	Warning	
	Port recover from IMPB block state	Port <portNum> recover from IMPB block state	Warning	
	Dynamic IMPB entry is conflict with static NDP	Dynamic IMPB entry is conflict with static NDP (IP: <ipv6addr>, MAC: <macaddr>, Port <portNum>)	Warning	
<b>IP and Password Changed</b>	IP Address change activity	Management IP address was changed by (Username: <username>, IP: <ipaddr >, MAC: <macaddr>)	Informational	
	Password change activity	Password was changed by (Username: <username>, IP: <ipaddr >, MAC: <macaddr>)	Informational	
<b>Dual Configuration</b>	Excution error encountered druring system boot-up	Configuration had <int> syntax error and <int> execute error	Warning	
<b>Safeguard Engine</b>	Safeguard Engine is in normal mode	Safeguard Engine enters NORMAL mode	Informational	
	Safeguard Engine is in filtering packet mode	Safeguard Engine enters EXHAUSTED mode	Warning	
<b>Packet Storm</b>	Broadcast strom occurrence	Port <portNum> Broadcast storm is occurring	Warning	
	Broadcast storm	Port <portNum> Broadcast storm has	Informational	



	cleared	cleared		
	Multicast storm occurrence	Port <portNum> Multicast storm is occurring	Warning	
	Multicast storm cleared	Port <portNum> Multicast storm has cleared	Informational	
	Port shut down due to a packet storm	Port <portNum> is currently shut down due to a packet storm	Warning	
<b>JWAC</b>	When a client host authenticated successful	JWAC authenticated user (Username: <string>, IP: <ipaddr>, MAC: <macaddr>, Port: <portNum>)	Informational	
	When a client host fails to authenticate	JWAC unauthenticated user (User Name: <string>, IP: <ipaddr>, MAC: <macaddr>, Port: <portNum>)	Warning	
<b>WAC</b>	When a client host authenticated successful	WAC authenticated user (Username: <string>, IP: <ipaddr>, MAC: <macaddr>, Port: <portNum>)	Informational	
	When a client host fails to authenticate	WAC unauthenticated user (User Name: <string>, IP: <ipaddr>, MAC: <macaddr>, Port: <portNum>)	Warning	
<b>Loopback Detection</b>	Port loop occurred	Port <portNum> LBD loop occurred. Port blocked.	Critical	
	Port loop detection restarted after interval time	Port <portNum> LBD port recovered. Loop detection restarted.	Informational	
	Port with VID loop occurred	Port <portNum> VID <vlanID> LBD loop occurred. Packet discard begun.	Critical	
	Port with VID Loop detection restarted after interval time	Port <portNum> VID <vlanID> LBD recovered. Loop detection restarted.	Informational	
<b>RADIUS</b>	VID assigned from RADIUS server after RADIUS client is authenticated by RADIUS server successfully .This VID will be assigned	RADIUS server <ipaddr> assigned VID :<vlanID> to port <portNum> (account :<username> )	Informational	Parameters description: ipaddr: The IP address of the RADIUS server. vlanID: The VID of RADIUS assigned VLAN. unitID: The unit ID. portNum: The port number.

	to the port and this port will be the VLAN untagged port member.			Username: The user that is being authenticated.
	Ingress bandwidth assigned from RADIUS server after RADIUS client is authenticated by RADIUS server successfully .This Ingress bandwidth will be assigned to the port.	RADIUS server <ipaddr> assigned ingress bandwidth :<ingressBandwidth> to port <portNum> (account : <username>)	Informational	Parameters description: ipaddr: The IP address of the RADIUS server. ingressBandwidth: The ingress bandwidth of RADIUS assign. unitID: The unit ID. portNum: The port number. Username: The user that is being authenticated.
	Egress bandwidth assigned from RADIUS server after RADIUS client is authenticated by RADIUS server successfully .This egress bandwidth will be assigned to the port.	RADIUS server <ipaddr> assigned egress bandwidth :<egressBandwidth> to port <portNum> (account: <username>)	Informational	ipaddr: The IP address of the RADIUS server. egressBandwidth: The egress bandwidth of RADIUS assign. unitID: The unit ID. portNum: The port number. Username: The user that is being authenticated.
	802.1p default priority assigned from RADIUS server after RADIUS client is authenticated by RADIUS server successfully. This 802.1p default priority will be assigned to the port.	RADIUS server <ipaddr> assigned 802.1p default priority:<priority> to port <portNum> (account : <username>)	Informational	Parameters description: ipaddr: The IP address of the RADIUS server. priority: Priority of RADIUS assign. unitID: The unit ID. portNum: The port number. Username: The user that is being authenticated.
	Failed to assign ACL profiles/rules from RADIUS server.	RADIUS server <ipaddr> assigns <username> ACL failure at port <portNum> (<string>)	Informational	Parameters description: ipaddr: The IP address of the RADIUS server. unitID: The unit ID. portNum: The port number. Username: The user that is being authenticated. string: The failed RADIUS ACL command string.
<b>802.1x</b>	802.1x Authentication failure	802.1x Authentication failure [for <reason> ] from (Username: <username>, Port: <portNum>, MAC: <macaddr> )	Warning	stand-alone device port <portNum> stackable device Port: <unitID:portNum>
	802.1x Authentication success	802.1x Authentication success from (Username: <username>, Port: <portNum>, MAC: <macaddr>)	Informational	stand-alone device port <portNum> stackable device Port: <unitID:portNum>
<b>DHCP</b>	Detect untrusted	Detected untrusted	Informational	

	DHCP server IP address	DHCP server(IP: <ipaddr>, Port: <portNum>)		
<b>MAC-based Access Control</b>	Login OK	MAC-AC login successful (MAC: <macaddr>, port: <portNum>, VID: <vlanID>)	Informational	
	Login Fail	MAC-AC login rejected (MAC: <macaddr>, port: <portNum>, VID: <vlanID>)	Warning	
	Aged out	MAC-AC host aged out (MAC: <macaddr>, port: <portNum>, VID: <vlanID>)	Informational	
<b>Voice VLAN</b>	When a new voice device is detected in the port	New voice device detected (Port <portNum>, MAC <macaddr>)	Informational	
	When a port which is in auto Voice VLAN mode joins the Voice VLAN	Port < portNum > add into Voice VLAN <vid >	Informational	
	When a port leaves the Voice VLAN and at the same time, no voice device is detected in the aging interval for that port, the log message will be sent	Port < portNum > remove from Voice VLAN <vid >	Informational	
<b>DULD</b>	The port is unidirectional	Port:<portNumver> is unidirection	Information	
<b>Gratuitous ARP</b>	ip conflict occur	conflict ip,mac,port,interface	information	
<b>LLDP</b>	LLDP-MED Topology change detected	LLDP-MED Topology change detected (on port %d. chassis id: %d, %s, port id: %d, %s, device class: %d)	notice	
	Conflict LLDP-MED device type detected	Conflict LLDP-MED device type detected (on port %d. chassis id: %d, %s, port id: %d, %s, device class: %d)	notice	
	Incompatible LLDP-MED TLV set detected	Incompatible LLDP-MED TLV set detected (on port %d. chassis id: %d, %s, port id: %d, %s, device class: %d)	notice	

<b>PortSecurity</b>	Address full on a port	Port security violation mac address %s on locking address full port %s	Warning	
<b>BPDU-Protection</b>	BPDU attack happened.	Port <port> enter BPDU under protection state (mode: drop / block / shutdown)	Informational	
	BPDU attack automatically recover.	Port <port> recover from BPDU under protection state automatically	Informational	
	BPDU attack manually recover.	Port <port> recover from BPDU under protection state manually	Informational	
<b>DHCPV6RELA Y</b>	Interface relay state change	DHCPv6 relay on interface %s changed state to %s	Informational	
<b>DNSResolver</b>	Create a host name entry which already exist in dynamic host name table	Duplicate Domain name case name: %s, static IP: %s, dynamic IP: %s	Informational	
<b>DHCPV6Client</b>	DHCPv6 client interface administrator state changed.	DHCPv6 client on interface <intf-name> changed state to <enabled   disabled>	Informational	
	DHCPv6 client obtains an ipv6 address from a DHCPv6 server	DHCPv6 client obtains an ipv6 address < ipv6address > on interface <intf-name>	Informational	
	The IPv6 address obtained from a DHCPv6 server starts renewing.	The IPv6 address < ipv6address > on interface <intf-name> starts renewing.	Informational	
	The IPv6 address obtained from a DHCPv6 server renews success.	The IPv6 address < ipv6address > on interface <intf-name> renews success.	Informational	
	The IPv6 address obtained from a DHCPv6 server starts rebinding.	The IPv6 address < ipv6address > on interface <intf-name> starts rebinding.	Informational	
	The IPv6 address obtained from a DHCPv6 server rebinds success.	The IPv6 address < ipv6address > on interface <intf-name> rebinds success.	Informational	
	The IPv6 address from a DHCPv6	The IPv6 address < ipv6address > on interface <intf-name>	Informational	

	server was deleted.	was deleted.		
<b>SD Card Managemnet</b>	Backup failure	Backup <type>:<filename> at time <time-range> failure.	Warning	
	Backupsuccess	Backup <type>:<filename> success at time <time- range>.	Informational	
	Execute configuration failure	Error when execute configuration <filename> line:<lineno> at time < time-range>.	Warning	Only the first error line of configuration will be logged. If <lineno> is 0, means maybe read configuration file fail (not existed or file system error or system busy).
	Execute configuration success	Execute configuration <filename> success at time < time-range>.	Informational	

## Appendix D – Trap Logs

This table lists the trap logs found on the DGS-3200 Series Switches.

Log Entry	Description	ID
<b>FirmwareUpgrade</b>	<i>This trap is sent when the process of upgrading the firmware via SNMP has finished.</i>	1.3.6.1.4.1.171.12.1.7.2.0.7
<b>CfgOperCompleteTrap</b>	<i>The trap is sent when the configuration is completely saved, uploaded or downloaded.</i>	1.3.6.1.4.1.171.12.1.7.2.0.9
<b>MACNotificationTrap</b>	<i>This trap indicates the MAC address variations in the address table.</i>	1.3.6.1.4.1.171.11.101.1.2.100.1.2.0.1 1.3.6.1.4.1.171.11.101.2.2.100.1.2.0.1 1.3.6.1.4.1.171.11.101.3.2.100.1.2.0.1 (DGS-3200-10/16/24)
<b>PortSecurityViolationTrap</b>	<i>When the port security trap is enabled, new MAC addresses that violate the pre-defined port security configuration will trigger trap messages to be sent out.</i>	1.3.6.1.4.1.171.11.101.1.2.100.1.2.0.2 1.3.6.1.4.1.171.11.101.2.2.100.1.2.0.2 1.3.6.1.4.1.171.11.101.3.2.100.1.2.0.2
<b>PortLoopOccurredTrap</b>	<i>This trap is sent when a Port loop occurs.</i>	1.3.6.1.4.1.171.11.101.1.2.100.1.2.0.3 1.3.6.1.4.1.171.11.101.2.2.100.1.2.0.3 1.3.6.1.4.1.171.11.101.3.2.100.1.2.0.3
<b>PortLoopRestart</b>	<i>This trap is sent when a Port loop restarts after the interval time.</i>	1.3.6.1.4.1.171.11.101.1.2.100.1.2.0.4 1.3.6.1.4.1.171.11.101.2.2.100.1.2.0.4 1.3.6.1.4.1.171.11.101.3.2.100.1.2.0.4
<b>VlanLoopOccurred</b>	<i>This trap is sent when a Port with a VID loop occurs.</i>	1.3.6.1.4.1.171.11.101.1.2.100.1.2.0.5 1.3.6.1.4.1.171.11.101.2.2.100.1.2.0.5 1.3.6.1.4.1.171.11.101.3.2.100.1.2.0.5
<b>VlanLoopRestart</b>	<i>This trap is sent when a Port with a VID loop restarts after the interval time.</i>	1.3.6.1.4.1.171.11.101.1.2.100.1.2.0.6 1.3.6.1.4.1.171.11.101.2.2.100.1.2.0.6 1.3.6.1.4.1.171.11.101.3.2.100.1.2.0.6
<b>SafeGuardChgToExhausted</b>	<i>This trap indicates System change operation mode from normal to exhausted.</i>	1.3.6.1.4.1.171.12.19.4.1.0.1
<b>SafeGuardChgToNormal</b>	<i>This trap indicates System change operation mode from exhausted to normal.</i>	1.3.6.1.4.1.171.12.19.4.1.0.2
<b>PktStormOccurred</b>	<i>This trap is sent when a packet storm is detected by the packet storm mechanism and takes shutdown as an action.</i>	1.3.6.1.4.1.171.12.25.5.0.1
<b>PktStormCleared</b>	<i>This trap is sent when the packet storm is cleared by the packet storm mechanism.</i>	1.3.6.1.4.1.171.12.25.5.0.2

<b>swPktStormDisablePort</b>	<i>The trap is sent when the port is disabled by the packet storm mechanism.</i>	<i>1.3.6.1.4.1.171.12.25.5.0.3</i>
<b>swIpMacBindingViolationTrap</b>	<i>When the IP-MAC Binding trap is enabled, if there's a new MAC that violates the pre-defined port security configuration, a trap will be sent out.</i>	<i>1.3.6.1.4.1.171.12.23.5.0.1</i>
<b>swIpMacBindingIPv6ViolationTrap</b>	<i>When the IP-MAC Binding trap is enabled, if there's a new MAC that violates the pre-defined IPv6 IP-MAC Binding configuration, a trap will be sent out.</i>	<i>1.3.6.1.4.1.171.12.23.5.0.4</i>
<b>MacBasedAuthLoggedSuccess</b>	<i>This trap is sent when a MAC-based access control host is successfully logged in.</i>	<i>1.3.6.1.4.1.171.12.35.11.1.0.1</i>
<b>MacBasedAuthLoggedFail</b>	<i>This trap is sent when a MAC-based access control host login fails.</i>	<i>1.3.6.1.4.1.171.12.35.11.1.0.2</i>
<b>MacBasedAuthAgesOut</b>	<i>This trap is sent when a MAC-based access control host ages out.</i>	<i>1.3.6.1.4.1.171.12.35.11.1.0.3</i>
<b>FilterDetectedTrap</b>	<i>This trap is sent when an illegal DHCP server is detected. The same illegal DHCP server IP address detected is just sent once to the trap receivers within the log ceasing unauthorized duration.</i>	<i>1.3.6.1.4.1.171.12.37.100.0.1</i>
<b>SingleIPMSColdStart</b>	<i>The commander switch will send swSingleIPMSColdStart notification to the indicated</i>	<i>1.3.6.1.4.1.171.12.8.6.0.11</i>
<b>SingleIPMSWarmStart</b>	<i>The commander switch will send swSingleIPMSWarmStart notification to the indicated host when its member generates a warm start notification.</i>	<i>1.3.6.1.4.1.171.12.8.6.0.12</i>
<b>SingleIPMSLinkDown</b>	<i>The commander switch will send swSingleIPMSLinkDown notification to the indicated host when its member generates a link down notification.</i>	<i>1.3.6.1.4.1.171.12.8.6.0.13</i>
<b>SingleIPMSLinkUp</b>	<i>The commander switch will send swSingleIPMSLinkUp notification to the indicated host when its member generates a link up notification.</i>	<i>1.3.6.1.4.1.171.12.8.6.0.14</i>
<b>SingleIPMSAuthFail</b>	<i>The commander switch will send swSingleIPMSAuthFail notification to the indicated host when its member generates an authentication failure notification</i>	<i>1.3.6.1.4.1.171.12.8.6.0.15</i>
<b>SingleIPMSNewRoot</b>	<i>The commander switch will send swSingleIPMSNewRoot notification to the indicated host when its member generates a new root notification.</i>	<i>1.3.6.1.4.1.171.12.8.6.0.16</i>
<b>SingleIPMSTopologyChange</b>	<i>The commander switch will send</i>	<i>1.3.6.1.4.1.171.12.8.6.0.17</i>

	<i>swSingleIPMSTopologyChange</i> notification to the indicated host when its member generates a topology change notification.	
<b><i>coldStart</i></b>	A <i>coldStart</i> trap signifies that the sending protocol entity is reinitializing itself such that the agent's configuration or the protocol entity implementation may be altered.	1.3.6.1.6.3.1.1.5.1
<b><i>warmStart</i></b>	A <i>warmStart</i> trap signifies that the sending protocol entity is reinitializing itself such that neither the agent configuration nor the protocol entity implementation is altered.	1.3.6.1.6.3.1.1.5.2
<b><i>linkDown</i></b>	A <i>linkDown</i> trap signifies that the sending protocol entity recognizes a failure in one of the communication links represented in the agent's configuration.	1.3.6.1.6.3.1.1.5.3
<b><i>linkUp</i></b>	A <i>linkUp</i> trap signifies that the sending protocol entity recognizes that one of the communication links represented in the agent's configuration has come up.	1.3.6.1.6.3.1.1.5.4
<b><i>authenticationFailure</i></b>	An <i>authenticationFailure</i> trap signifies that the sending protocol entity is the address of a protocol message that is not properly authenticated. While implementations of the SNMP must be capable of generating this trap, they must also be capable of suppressing the emission of such traps via an implementation-specific mechanism.	1.3.6.1.6.3.1.1.5.5
<b><i>newRoot</i></b>	The <i>newRoot</i> trap indicates that the sending agent has become the new root of the Spanning Tree; the trap is sent by a bridge soon after its election as the new root, e.g., upon action of the Topology Change Timer immediately subsequent to its election. Implementation of this trap is optional.	1.3.6.1.2.1.17.0.1
<b><i>topologyChange</i></b>	A <i>topologyChange</i> trap is sent by a bridge when any of its configured ports transitions from the Learning state to the Forwarding state, or from the Forwarding state to the Blocking state. The trap is not sent if a <i>newRoot</i> trap is sent for the same transition. Implementation of this trap is optional.	1.3.6.1.2.1.17.0.2
<b><i>PowerFailure</i></b>	The <i>PowerFailure</i> trap indicates that at least one power supply has failed.	1.3.6.1.4.1.171.12.11.2.2.2.0.2 (only DGS-3200-24)
<b><i>PowerRecover</i></b>	The <i>PowerRecover</i> trap indicates that the failed power is recovered.	1.3.6.1.4.1.171.12.11.2.2.2.0.3 (only DGS-3200-24)
<b><i>FanFailure</i></b>	The <i>FanFailure</i> trap indicates that any	1.3.6.1.4.1.171.12.11.2.2.3.0.1



	<i>fan fails</i>	<i>(DGS-3200-16/24)</i>
<b>FanRecover</b>	<i>The FanRecover trap indicates that the failed fan is recovered.</i>	<i>1.3.6.1.4.1.171.12.11.2.2.3.0.2 (DGS-3200-16/24)</i>
<b>agentGratuitousARPTrap</b>	<i>This trap is sent when there is an IP address conflict.</i>	<i>1.3.6.1.4.1.171.12.1.7.2.0.5</i>
<b>ifMauJabberTrap</b>	<i>This trap is sent whenever a managed interface MAU enters the jabber state. The agent MUST throttle the generation of consecutive ifMauJabberTraps so that there is at least a five-second gap between them.</i>	<i>1.3.6.1.2.1.26.0.2</i>
<b>lldpRemTablesChange</b>	<i>This trap is initiated when a LLDP entry is added to or deleted from remote DB.</i>	<i>1.0.8802.1.1.2.0.0.1</i>
<b>lldpXMedTopologyChangeDetected</b>	<i>A notification generated by the local device sensing a change in the topology that indicates that a new remote device attached to a local port, or a remote device disconnected or moved from one port to another.</i>	<i>1.0.8802.1.1.2.1.5.4795.0.1</i>
<b>swBpduProtectionUnderAttackingTrap</b>	<i>The Bpdu protection under attacking trap indicates that BPDU attack happened, enter drop / block / shutdown mode.</i>	<i>1.3.6.1.4.1.171.12.76.4.0.1</i>
<b>swBpduProtectionRecoveryTrap</b>	<i>The Bpdu protection recovery trap indicates that BPDU attack automatically recover.</i>	<i>1.3.6.1.4.1.171.12.76.4.0.2</i>