

USER MANUAL

DVS-310-1

VERSION 1.0



D-Link[®]

surveillance

Table of Contents

Product Overview	4	Event Setup	29
Package Contents	4	Application	30
System Requirements	4	Add Server.....	31
Introduction.....	5	Add Media.....	32
Features	5	Add Event	35
Hardware Overview	6	Add Recording.....	37
Front	6	SD Card.....	38
Rear.....	7	Advanced	39
Hardware Installation.....	8	Digital Input/Output.....	39
Initial Configuration	11	RS-485	40
Setup Wizard	11	HTTPS.....	41
Connect to Your Video Encoder.....	13	Access List	42
Web-based Configuration Utility	14	Maintenance	43
Live Video	16	Admin	43
Setup	17	Backup and Restore	44
Wizard	17	Firmware Upgrade.....	45
Internet Connection Setup Wizard.....	17	Status	46
Motion Detection Setup Wizard	20	Device Info.....	46
Network Setup	22	Logs	47
Dynamic DNS	24	Help	48
Image Setup	25	Using & Configuring the DVS-310-1	49
Audio and Video	26	Router Set-Up and Installation	52
Motion Detection.....	27	Troubleshooting	55
Time and Date	28		

Example DI/DO Schematic.....56

Networking Basics57

 Check your IP address57

 Statically Assign an IP address58

Technical Specifications.....59

Package Contents



DVS-310-1 Video Encoder



Manual and Software on CD

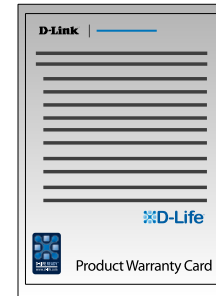

Warranty and GPL Licence

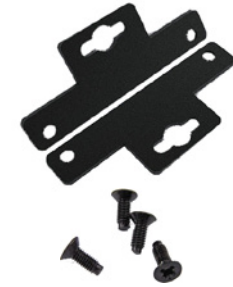

Mounting Bracket and Screws



CAT5 Ethernet Cable



12V 1.25A Power Adapter



Quick Installation Guide

Note: Using a power supply with a different voltage will cause damage and void the warranty for this product.

If any of the above items are missing, please contact your reseller.

System Requirements

- Pentium 4 - 2.4GHz or higher with 512MB RAM
- Windows Vista / Windows XP with SP2 or higher / Windows 2000 with SP4 or higher
- Microsoft IE 6.0 or higher

Introduction

Congratulations on your purchase of the **DVS-310-1 Video Encoder**. The DVS-310-1 is a versatile solution that allows you to make the most of your existing analog surveillance infrastructure. The DVS-310-1 is a standalone system with a built-in video encoder that converts an analog camera into a full-featured IP-based system. The DVS-310-1 can be remotely accessed and controlled using a Web browser over an Intranet or the Internet.

Features

Digitally Transform Existing Hardware

The DVS-310-1 Video Encoder makes it possible to integrate a pre-existing analog surveillance infrastructure into a fully-functional IP surveillance system. The DVS-310-1 is an ideal choice for banks, airports, factories, government buildings, prisons, and traffic surveillance applications - any location where surveillance equipment is already installed and functioning.

Manage, Record, and View Video with Ease

The hardware encoder supports H.264 / MPEG-4 / MJPEG video with frame rates of up to 30fps at D1 resolution. E-mail notifications help to keep you up to date whenever a video event occurs. Event recordings can be stored directly to an SD card, or saved to an FTP server.

Simplify Surveillance with Advanced Alarms and Events

Alarm handling features provide alerts in the event of loss of video or loss of network connection. Motion alarms with configurable detection areas allow for effective surveillance and help to mitigate the need for constant human supervision. A buffer system allows the server to capture images to the built-in SD card slot before and after an event occurs.

Hardware Overview

Front

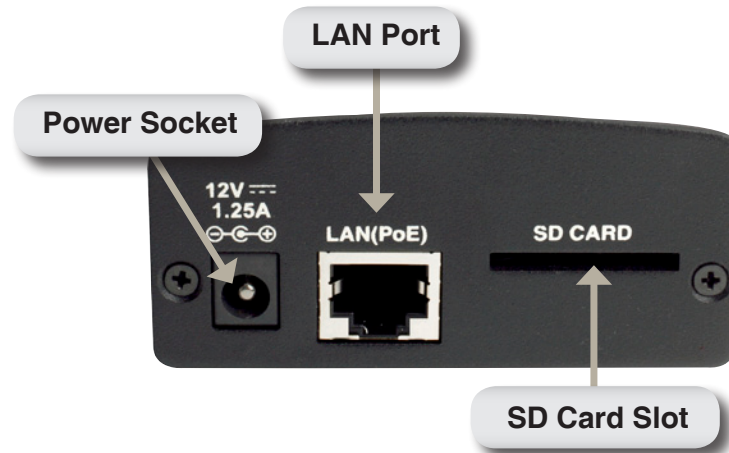

Power Socket:

Connect the supplied DC adapter here to power the device.

LAN Port:

The 10/100 Ethernet LAN port connects the Video Encoder to networking equipment such as a router or switch.

SD Card Slot:

This slot supports SD cards (standard and SDHC) for removable storage of video and still images.

Rear

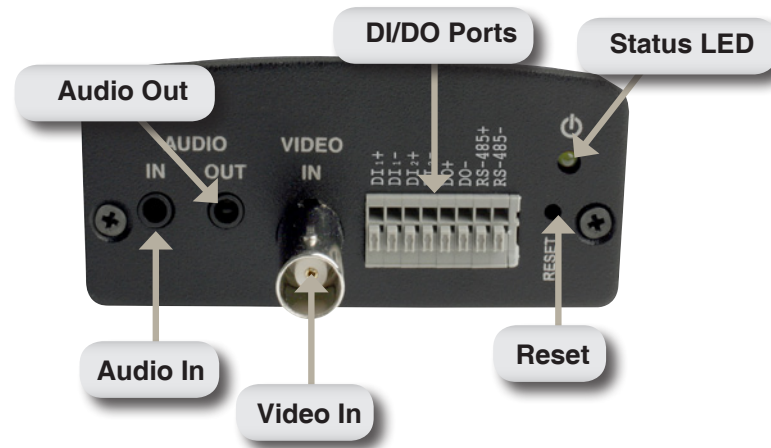

Audio In:

This standard 3.5mm stereo jack accepts a connection from a microphone or any suitable analog audio input source.

Audio Out:

This standard 3.5mm stereo jack accepts a connection from a speaker or any suitable analog audio output device.

Video In:

This standard BNC analog video connector accepts a connection from any suitable analog video device. An adapter may be required when using some types of video cables.

DI/DO Ports:

This pin block includes two sets of digital input connector pairs, one digital output pair, and one RS-485 pair for PTZ control.

Reset Button:

This button can be used to restore the factory default settings. To reset the device to factory defaults, use an unfolded paperclip to press and hold the button for at least 15 seconds until the power LED stops blinking. The device will reboot automatically after it has been reset.

Status LED:

When solidly lit, this LED indicates that the the device is initializing. When blinking, this LED indicates that the device has acquired an IP address.

Hardware Installation

Note: The following installation instructions assume that an analog video camera is installed and providing a signal. If necessary, please consult your camera manufacturer's user manual for information on how to set up your analog camera.

Connect the Video Cable

Connect the video cable from the camera to the VIDEO IN port of the Video Encoder.

Once the cable has been connected, rotate the BNC connector clockwise so that the cable locks into place.



Connect the Power Supply

Attach the external power supply to the DC power socket (labeled 12V 1.25A) and plug the two-pronged adapter into an AC power outlet. Alternatively, the DVS-310-1 may be powered via PoE Ethernet cable. In this case, the supplied power adapter should not be connected.

When the DVS-310-1 is receiving power, the green power LED will be lit.



Connect the Ethernet Cable

Connect a CAT5 Ethernet cable to the LAN port of the Video Encoder. Connect the opposite end of the CAT5 cable to an active network device such as a hub, switch, or router.



Insert an SD Card (Optional)

Insert an SD card with the gold contacts of the card facing upwards. Push the card into the slot until you feel it click into place.



Connect Additional Peripheral Devices (Optional)

If desired, you may also connect audio equipment such as a microphone or speaker to the AUDIO IN and AUDIO OUT ports respectively. DI/DO devices and PTZ controls may also be connected.

Mounting Bracket Installation (Optional)

Remove the four rubber feet from the bottom of the device, then affix the mounting brackets as shown below. Secure both of the brackets into place using the supplied screws.

The brackets may now be used to mount the device on a wall or another flat surface using bolts or screws.

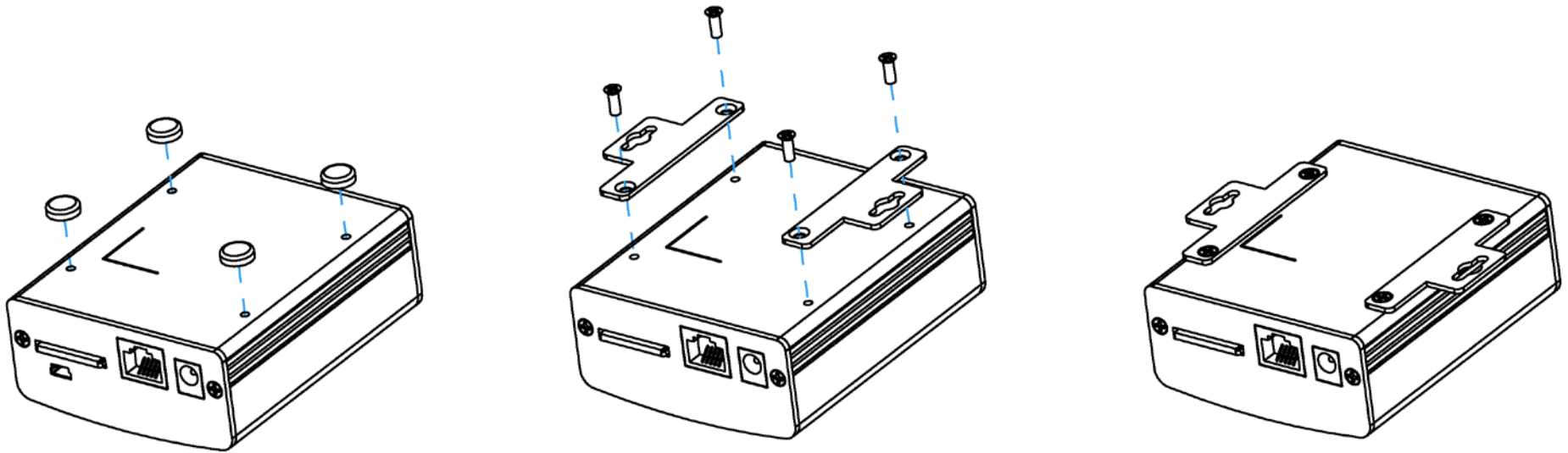

Initial Configuration

This section will show you how to configure your new DVS-310-1 Video Encoder using the D-Link Setup Wizard SE.

Setup Wizard

After loading the Setup Wizard, your Video Encoder's IP Address will be displayed along with its corresponding MAC Address here.

Your Video Encoder's IP Address will be displayed here along with its corresponding MAC Address.

Click **Wizard**

D-Link Building Networks for People

SECURICAM Network

MAC Address	Current IP Address	Device Name
00.f.11.11.66.88	192.168.1.169	DVS-310-1

Enter the **Admin ID** and **Password**.

Note: The default Admin ID is **admin** with the password left blank.

Click **Next**

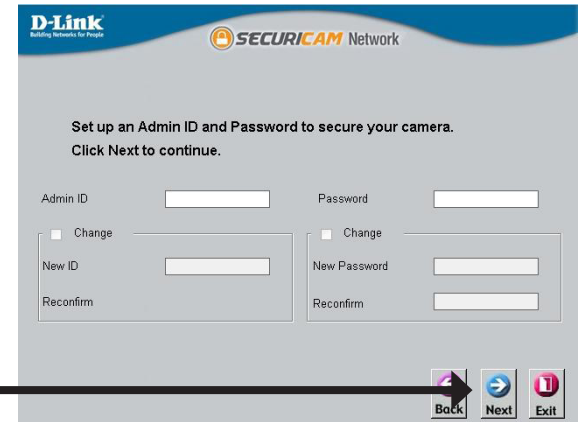

Select **DHCP** if you want to obtain a new IP address every time the Video Encoder boots up, or select **Static IP** to use the same IP address at each boot up.

Click **Next**

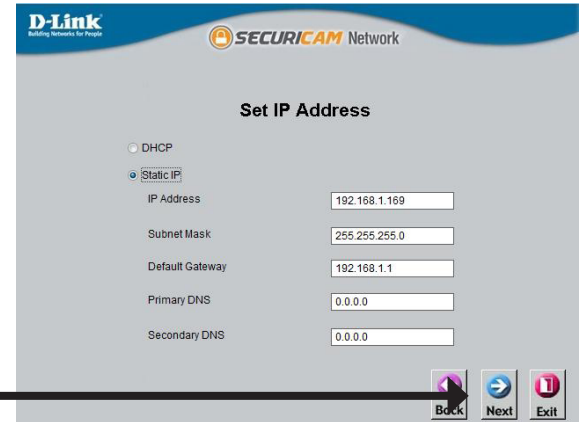

Connect to Your Video Encoder

Setup is now complete.

Click **Link** to launch the web page of your Video Encoder, to view live video from your Video Encoder.



The Setup Wizard will automatically open your web browser to the IP address of the DVS-310-1. In this example it is: `http://192.168.1.169`. Your DVS-310-1 may have a different IP Address.

Enter **admin** as the default **User name** and leave the **Password** blank. Click **OK** to continue.

You may also use the Internet Explorer web browser to access your Video Encoder's Home screen by typing "`http://address`" in the address box, where **address** is the IP address that you have assigned to your Video Encoder in the previous section.

When you connect to the home page of your Video Encoder for the first time, you will be prompted to download ActiveX. Please follow the prompts to install the ActiveX controls.

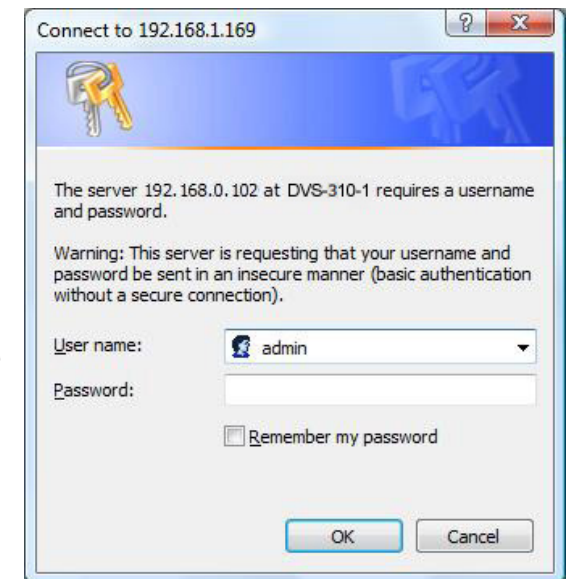

Web-based Configuration Utility

This section explains how to configure your new D-Link Video Encoder using the Web-based Configuration Utility.

Click on the **D-Link Setup Wizard SE** icon that was created in your Windows Start menu.

Start > D-Link > Setup Wizard SE

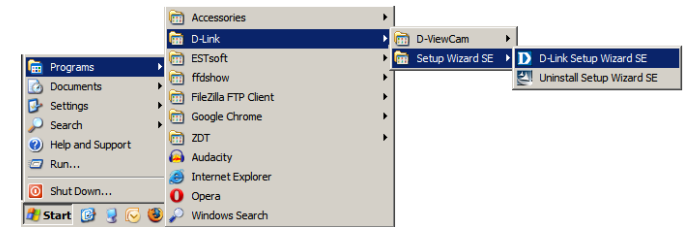

Select the Video Encoder and click the button labeled **"Link"** to access the web configuration.

The Setup Wizard will automatically open your web browser to the IP address of the Video Encoder.



Alternatively, you may manually open a browser and enter the IP address of the Video Encoder: **192.168.0.20**

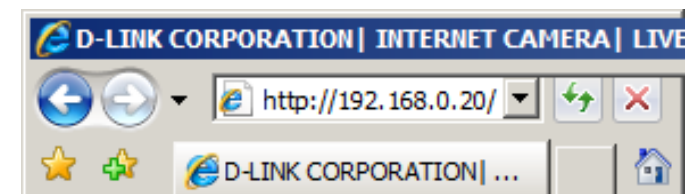

Enter **admin** as the default username and leave the password blank. Click **OK** to continue.

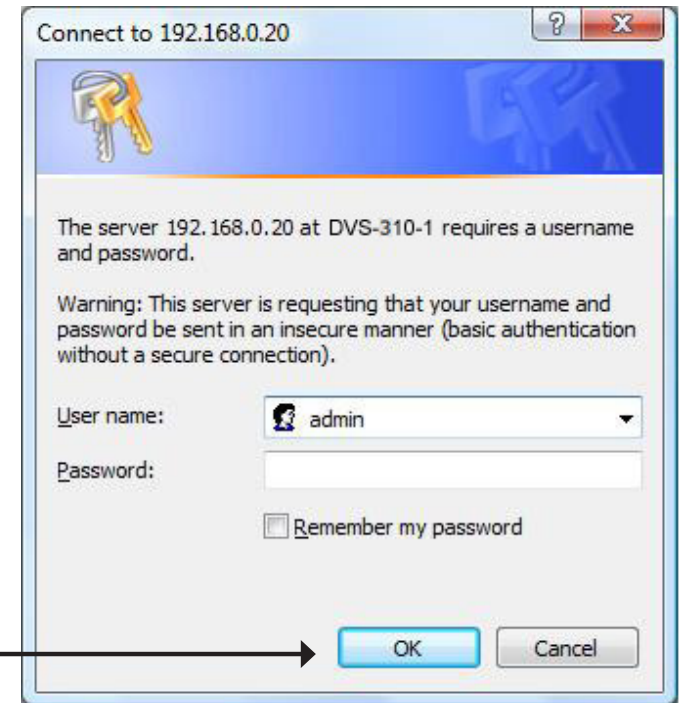

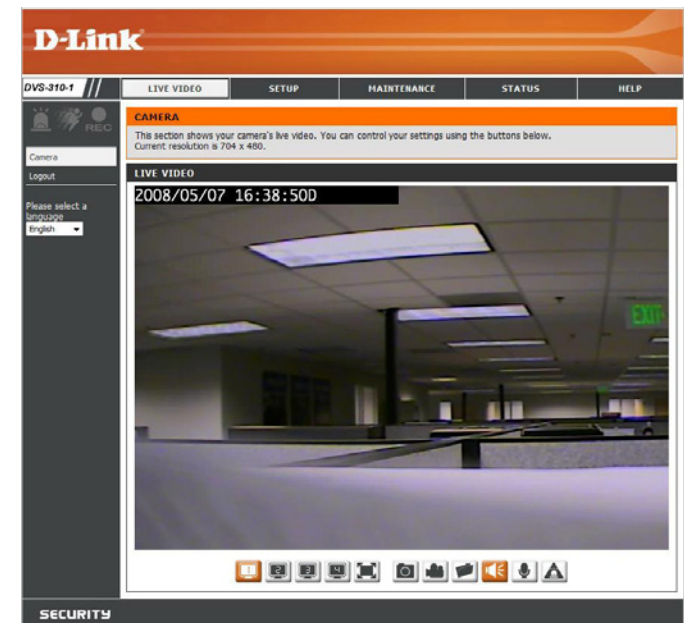

This section shows your Video Encoder's live video. You can select your video profile and view or operate the Video Encoder. For additional information about web configuration, please refer to the user manual included on the CD-ROM or the D-Link website.













Live Video

This section shows your camera's live video. You may select any of the available icons listed below to operate the camera. You may also select your language using the drop-down menu on the left side of the screen.

You can zoom in and out on the live video image using your mouse. Right-click to zoom out or left-click to zoom in on the image.

	Digital Input Indicator	This indicator will change color when a digital input signal is detected.
	Motion Trigger Indicator	This indicator will change color when a trigger event occurs. Note: The video motion feature must be enabled.
	Recording Indicator	When a recording is in progress, this indicator will change color.

-  Video Profile 1
-  Video Profile 2
-  Video Profile 3
-  Full screen mode
-  Taking a Snapshot
-  Recording a Video Clip
-  Set a Storage Folder
-  Listen/Stop Listening
-  Zoom
-  Talk/Stop Talking
-  Start/Stop Digital Output

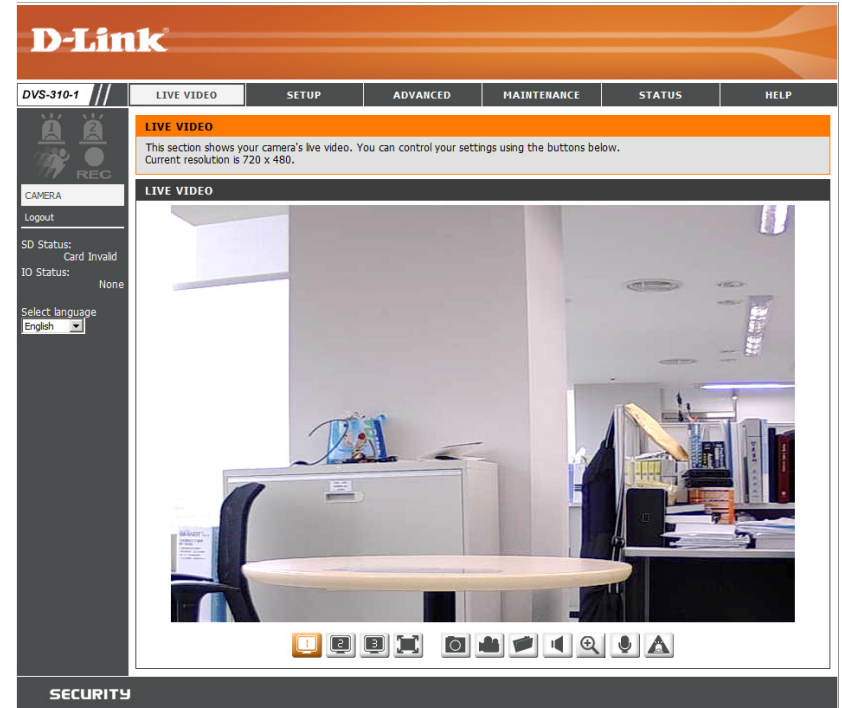

Setup Wizard

To configure your Video Encoder, click **Internet Connection Setup Wizard**. Alternatively, you may click **Manual Internet Connection Setup** to manually configure your Video Encoder and skip to page 22.

To quickly configure your Video Encoder's motion detection settings, click **Motion Detection Setup Wizard**. If you want to enter your settings without running the wizard, click **Manual Motion Detection Setup** and skip to page 27.

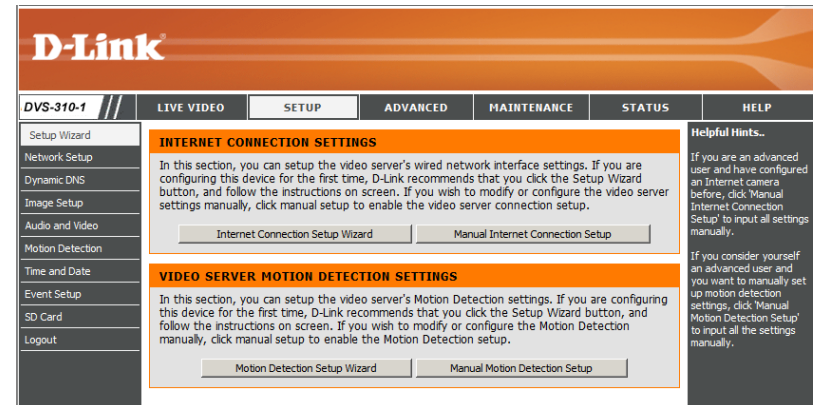

Internet Connection Setup Wizard

This wizard will guide you through a step-by-step process to configure your new D-Link Video Encoder and connect the camera to the internet. Click **Next** to continue.

Note: Select DHCP if you are unsure of which settings to choose.

Click **Next** to continue.

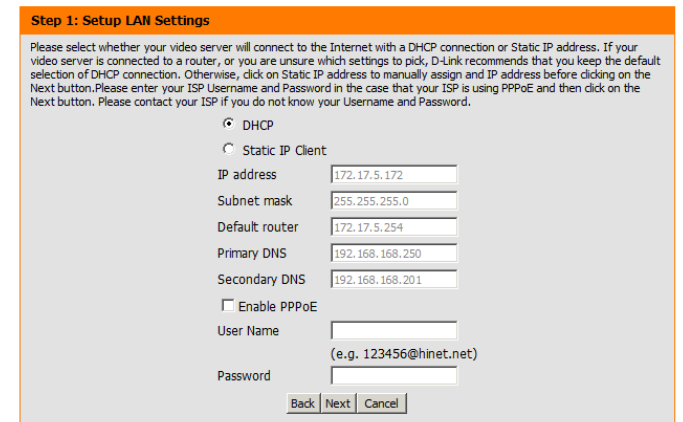
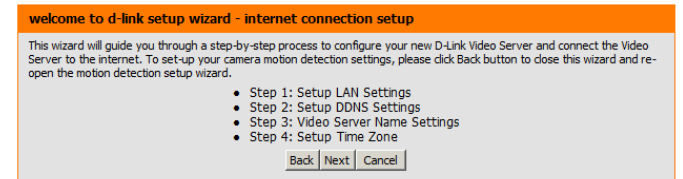

Select Static IP if your Internet Service Provider has provided you with connection settings, or if you wish to set a static address within your home network. Enter the correct configuration information and click **Next** to continue.

If you are using PPPoE, select **Enable PPPoE** and enter your user name and password, otherwise click **Next** to continue.

If you have a Dynamic DNS account and would like the Video Encoder to update your IP address automatically, Select **Enable DDNS** and enter your host information. Click **Next** to continue.

Enter a name for your Video Encoder and click **Next** to continue.

Step 1: Setup LAN Settings

Please select whether your video server will connect to the Internet with a DHCP connection or Static IP address. If your video server is connected to a router, or you are unsure which settings to pick, D-Link recommends that you keep the default selection of DHCP connection. Otherwise, click on Static IP address to manually assign an IP address before clicking on the Next button. Please enter your ISP Username and Password in the case that your ISP is using PPPoE and then click on the Next button. Please contact your ISP if you do not know your Username and Password.

DHCP
 Static IP Client

IP address
Subnet mask
Default router
Primary DNS
Secondary DNS

Enable PPPoE
User Name
(e.g. 123456@hinet.net)
Password

Step 2: Setup DDNS Settings

If you have a Dynamic DNS account and would like the video server to update your IP address automatically, enable DDNS and enter in your host information below. Please click on the Next button to continue.

Enable DDNS

Server Address <<

Host Name
User Name
Password
Verify Password
Timeout (hours)

Step 3: Video Server Name Settings

D-Link recommends that you rename your Video Server for easy accessibility. You can then identify and connect to your Video Server via this name. Please assign a name of your choice before clicking on the Next button.

Video Server Name

Configure the correct time to ensure that all events will be triggered as scheduled. Click **Next** to continue.

If you have selected DHCP, you will see a summary of your settings, including the Video Encoder's IP address. Please write down all of this information as you will need it in order to access your Video Encoder.

Click **Apply** to save your settings.

Step 4: Setup Time Zone

Please configure the correct time to ensure that all events are triggered, captured and scheduled at the correct time and day and then click on the Next button.

Time Zone

Enable Daylight Saving

Step 5: Setup complete

Below is a summary of your Video Server settings. Click on the Back button to review or modify settings or click on the Apply button if all settings are correct. It is recommended to note down these settings in order to access your Video Server on the network or via your web browser.

IP Address	DHCP
Video Server Name	DVS: 310-1 A1
Time Zone	(GMT+08:00) Taipei
DDNS	Disable
PPPoE	Disable

Motion Detection Setup Wizard

This wizard will guide you through a step-by-step process to configure your Video Encoder's motion detection functions.

Click **Next** to continue.

Step 1

This step will allow you to enable or disable motion detection, specify the detection sensitivity, and adjust the Video Encoder's ability to detect movement.

You may specify whether the camera should capture a snapshot or a video clip when motion is detected.

Please see the **Motion Detection** section on page 27 for information about how to configure motion detection.

Step 2

This step allows you to enable motion detection based on a customized schedule. Specify the day and hours. You may also choose to always record motion.

welcome to d-link setup wizard - motion detection

This wizard will guide you through a step-by-step process to configure your camera's motion detection functions. To setup the camera LAN or Internet settings, please click on the Back button to close this wizard and re-open the Camera Setup wizard. Otherwise click on the Next button to begin.

- Step 1: Specify Motion Detection Area Settings
- Step 2: Alerts and Notifications

Back Next Cancel

Step 1: Specify Motion Detection Area Settings

This section will allow you to enable or disable motion detection as well as control the sensitivity of your camera's ability to detect movement.

Enable Video Motion Snapshot Video Clip

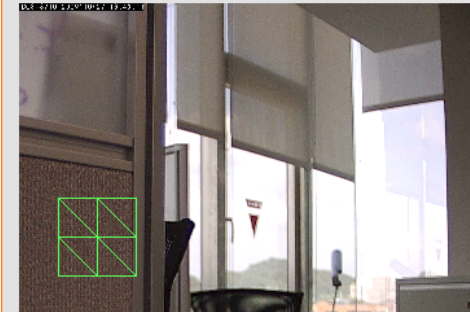

Back Next Cancel

step 2: Motion Detection Schedule

This section allows you to specify the time and dates that your camera records motion. Please note that recorded camera footage will take up space on your hard drive. It is therefore recommended that you have sufficient disk space for Always function.

Sun Mon Tue Wed Thu Fri Sat

Time

Always

From 00 00 To 23 59

Back Next Cancel

Step 3

This step allows you to specify how you will receive event notifications from your Video Encoder. You may choose not to receive notifications, or to receive notifications via e-mail or FTP.

Please enter the relevant information for your e-mail or FTP account.

Click **Next** to continue.

Step 3: Alerts and Notification

This final step allows you to specify how you receive notification of camera events. Choose between an email notification or alternatively you can setup an FTP Notification. You will need your email account settings or FTP details. If you are unsure of this information, please contact your ISP. Once you have entered this information, please click on the Next button.

Do not notify me

Email

Sender email address

Recipient email address

Server address

User name

Password

Port

FTP

Server address

Port

User name

Password

Remote folder name

Step 4

You have completed the Motion Detection Wizard.

Please verify your settings and click **Apply** to save them.

Step 4: Setup Complete

You have completed your camera setup. Please click the Back button if you want to review or modify your settings or click on the Apply button to save and apply your settings.

Motion Detection : Enable

EVENT : Video Clip

Schedule Day : Sun , Mon , Tue , Wed , Thu , Fri , Sat ,

Schedule Time : Always

Alerts and Notification : Email

Please wait a few moments while the Video Encoder saves your settings and restarts.

Step 5: Setup complete

Below is a summary of your Video Server settings. Click on the Back button to review or modify settings or click on the Apply button if all settings are correct. It is recommended to note down these settings in order to access your Video Server on the network or via your web browser.

Changes saved. Video Server's network is restarting, please wait for 5 seconds ...

Network Setup

Use this section to configure the network connections for your Video Encoder. All relevant information must be entered accurately.

LAN Settings: Settings for your local area network.

DHCP: Select this connection if you have a DHCP server running on your network and would like your Video Encoder to obtain an IP address automatically.

Static IP Address: You may obtain a static or fixed IP address and other network information from your network administrator for your Video Encoder. A static IP address may simplify access to your Video Encoder in the future.

IP Address: Enter the fixed IP address in this field.

Subnet Mask: This number is used to determine if the destination is in the same subnet. The default value is 255.255.255.0.

Default Gateway: The gateway used to forward frames to destinations in a different subnet. Invalid gateway settings may cause the failure of transmissions to a different subnet.

Primary DNS: The primary domain name server translates names to IP addresses.

Secondary DNS: The secondary DNS acts as a backup to the primary DNS.

Enable UPnP: Enabling this setting allows your Video Encoder to be configured as a UPnP device on your network.

Enable UPnP Port Forwarding: Enabling this setting allows the Video Encoder to add port forwarding entries into the router automatically on a UPnP capable network.

The screenshot shows the 'NETWORK SETUP' page of the D-Link DVS-310-1 web interface. The page is divided into several sections for configuring network settings:

- LAN SETTINGS:** Includes options for DHCP (selected) or Static IP Client. Fields for IP address (172.17.5.122), Subnet mask (255.255.255.0), Default router (172.17.5.254), Primary DNS (192.168.0.1), and Secondary DNS (192.168.168.201) are visible. There are checkboxes for 'Enable UPnP presentation' and 'Enable UPnP port forwarding'.
- PPPOE SETTINGS:** Includes options to 'Enable' or 'Disable' PPPOE. Fields for User Name, Password, and Confirm password are present.
- HTTP:** Fields for HTTP port (80) and three access names for streams (video1.mjpg, video2.mjpg, video3.mjpg).
- HTTPS:** Field for HTTPS port (443).
- RTSP:** Fields for RTSP port (554) and three access names for streams (live1.sdp, live2.sdp, live3.sdp).
- TRAFFIC:** Fields for Maximum Upload Bandwidth and Maximum Download Bandwidth, both in Kilo Bytes Per Second.

Buttons for 'Save Settings' and 'Don't Save Settings' are located at the bottom of each section. A 'SECURITY' section is partially visible at the bottom of the page.

Enable PPPoE: Enable this setting if your network uses PPPoE.

User Name: The unique name of your account. You may obtain this information from your ISP.

Password: The password to your account. You may obtain this information from your ISP.

HTTP Port: The default port number is 80.

Access Name for Stream 1~3: The default name is video#.mjpg, where # is the number of the stream.

HTTPS Port: You may use a PC with a secure browser to connect to the HTTPS port of the Video Encoder. The default port number is 443.

RTSP Port: The port number that you use for RTSP streaming to mobile devices, such as mobile phones or PDAs. The default port number is 554. You may specify the address of a particular stream. For instance, live1.sdp can be accessed at rtsp://x.x.x.x/video1.sdp where the x.x.x.x represents the ip address of your Video Encoder.

Maximum Upload/Download Bandwidth: Specifying the maximum download/upload bandwidth for each socket can be useful when connecting your device to a busy or heavily loaded network. Entering a value of '0' indicates that the Video Encoder should not monitor bandwidth. Specifying other values will limit the Video Encoder's transfer speed to the specified number of Kilobytes per second.

D-Link

DVS-310-1 // LIVE VIDEO SETUP ADVANCED MAINTENANCE STATUS HELP

Setup Wizard
Network Setup
Dynamic DNS
Image Setup
Audio and Video
Motion Detection
Time and Date
Event Setup
SD Card
Logout

NETWORK SETUP
You can configure your LAN and Internet settings here.
Save Settings Don't Save Settings

LAN SETTINGS
DHCP
Static IP Client
IP address: 172.17.5.172
Subnet mask: 255.255.255.0
Default router: 172.17.5.254
Primary DNS: 192.168.0.1
Secondary DNS: 192.168.168.201
Enable UPnP presentation
Enable UPnP port forwarding
Forwarding Port: 1024 link
Forwarding Status: UPnP forwarding is inactive

PPPoE SETTINGS
Enable Disable
User Name:
Password:
Confirm password:
PPPoE Status:

HTTP
HTTP port: 80
Access name for stream1: video1.mjpg
Access name for stream2: video2.mjpg
Access name for stream3: video3.mjpg

HTTPS
HTTPS port: 443

RTSP
RTSP port: 554
Access name for stream1: live1.sdp
Access name for stream2: live2.sdp
Access name for stream3: live3.sdp

TRAFFIC
Maximum Upload Bandwidth: 0 Kilo Bytes Per Second
Maximum Download Bandwidth: 0 Kilo Bytes Per Second
Save Settings Don't Save Settings

SECURITY

Helpful Hints...
Select DHCP Connection: If you are running a DHCP server on your network and would like an IP address assigned to your video server automatically.
- Enabling UPnP settings will allow you to configure your video server as an UPnP device in the network.
- Enabling UPnP settings will allow you to connect directly to the Internet, you will need to enter the username and password, which were given to you when you set up your account with your Internet Service Provider. If the camera is behind a router or a gateway, you do not need to configure this setting.
- HTTP Port is the port you allocate in order to connect to the video server via a standard web browser.
- HTTPS Port is a video server connects it with a PC via a secure web browser.
- RTSP Port is the port you allocate in order to connect to a video server by using streaming mobile device(s), such as a mobile phone or PDA.
- Traffic - Specifying the maximum download/upload bandwidth for each socket is useful when connecting your device to a busy or heavily loaded network.
* The value '0' means it will not monitor any traffic.

Dynamic DNS

DDNS (Dynamic Domain Name Server) will hold a DNS host name and synchronize the public IP address of the modem when it has been modified. A user name and password are required when using the DDNS service.

Enable DDNS: Select this checkbox to enable the DDNS function.

Server Address: Select your Dynamic DNS provider from the pull down menu or enter the server address manually.

Host Name: Enter the host name of the DDNS server.

User Name: Enter your user name or e-mail used to connect to the DDNS.

Password: Enter your password used to connect to the DDNS server.

Timeout: Enter DNS Timeout values.

Status: Indicates the connection status, which is automatically determined by the system.

The screenshot shows the D-Link web interface for the DVS-310-1 device. The main navigation bar includes 'LIVE VIDEO', 'SETUP', 'ADVANCED', 'MAINTENANCE', 'STATUS', and 'HELP'. The 'SETUP' menu is expanded, showing options like 'Setup Wizard', 'Network Setup', 'Dynamic DNS', 'Image Setup', 'Audio and Video', 'Motion Detection', 'Time and Date', 'Event Setup', 'SD Card', and 'Logout'. The 'Dynamic DNS' section is active, displaying a 'DYNAMIC DNS' header and a 'DYNAMIC DNS SETTING' form. The form includes a checkbox for 'Enable DDNS', a 'Server Address' field with a dropdown menu (currently showing 'www.dlinkdns.com'), 'Host Name', 'User Name', 'Password', 'Verify Password', 'Timeout' (set to 24 hours), and 'Status' (set to none). There are 'Save Settings' and 'Don't Save Settings' buttons at the bottom of the form. A 'Helpful Hints...' sidebar is visible on the right.

Image Setup

In this section, you may configure the video image settings for your Video Encoder. A preview of the image will be shown in Live Video.

Enable Privacy Mask: The Privacy Mask setting allows you to specify up to 3 rectangular areas on the camera's image to be blocked/excluded from recordings and snapshots.

You may click and drag the mouse cursor over the camera image to draw a mask area.

Right clicking on the camera image brings up the following menu options:

Disable All: Disables all mask areas

Enable All: Enables all mask areas

Reset All: Clears all mask areas.

Mirror: Mirrors the images.

Flip: Rotates the image 180 degrees.

Brightness: This setting is used to compensate for backlit scenes. You may choose a value between 0 and 255.

Contrast: This setting may help to improve the image in some low light conditions. You may choose a value between 0 and 255.

Saturation: This setting controls the strength of color. You may choose a value between 0 and 255.

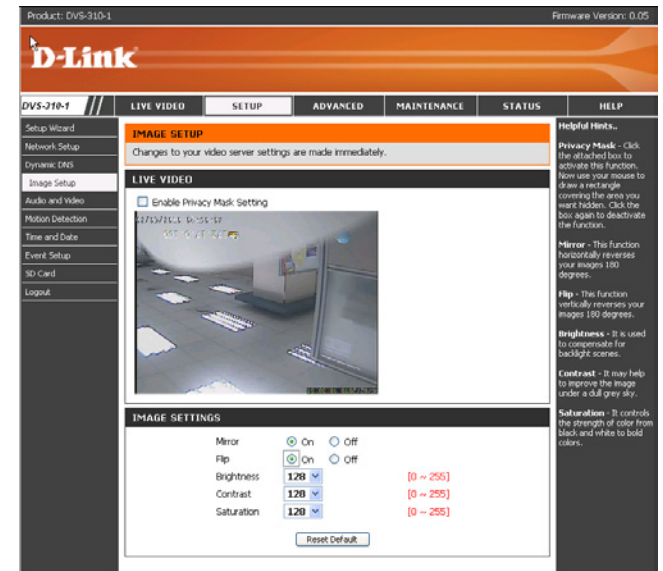

Audio and Video

You may configure 3 video profiles with different settings for your camera. Hence, you may set up different profiles for your computer and mobile display. In addition, you may also configure the two-way audio settings for your camera.

Mode: You may select H.264, MPEG4 or MJPEG encoding.

Frame Size: This option allows the user to choose the video resolution of the camera. The options include NTSC: D1 (720x480), CIF (352x240), QCIF (176x120) and PAL: D1 (720x576), CIF (352x288), QCIF (176x144).

Maximum Frame Rate: A higher frame rate provides smoother motion for video. Lower frame rates will result in stuttering.

Video Quality: Select the number of frames to be captured per second. 30fps is the highest video quality for this device.

Constant Bit Rate: This limits the maximal refresh frame rate, which can be combined with the “Fixed quality” to optimize the bandwidth utilization and video quality. To set the bandwidth utilization regardless of the video quality, choose “Constant bit rate” and select the desired bandwidth.

Fixed Quality: Select the image quality level of the video. You may choose **Standard**, **Good**, or **Excellent**.

Audio In Off: Select this option to disable Audio In.

Audio In Gain Level: Select 0 dB for no gain or 20 dB to make the audio louder.

Audio Out Off: Select this option to disable Audio Out.

Audio Out Volume Level: Choose a level between 1 and 10.

The screenshot shows the D-Link DVS-310-1 web interface. The main navigation bar includes 'LIVE VIDEO', 'SETUP', 'ADVANCED', 'MAINTENANCE', 'STATUS', and 'HELP'. The 'SETUP' tab is active, and the 'AUDIO AND VIDEO' sub-tab is selected. The interface is divided into several sections:

- VIDEO PROFILE 1:** Mode: MPEG4, Frame size: 720x576, Maximum frame rate: 30, Video quality: Excellent (Fixed quality selected).
- VIDEO PROFILE 2:** Mode: JPEG, Frame size: 720x576, Maximum frame rate: 15, Video quality: Excellent (Fixed quality selected).
- VIDEO PROFILE 3:** Mode: MPEG4, Frame size: 720x576, Maximum frame rate: 15, Video quality: Excellent (Fixed quality selected).
- AUDIO SETTINGS:** Audio in off (unchecked), Audio in gain level: 0 dB, Audio out off (unchecked), Audio out volume level: 10.

Helpful Hints on the right side provide additional information: Higher frame size, frame rate and bit rate rate gives better video quality. For best viewing results on a mobile phone, we suggest setting the Frame Rate to 15 and the Bit Rate to 20 kbps. Mode can be either JPEG or MPEG4. In JPEG mode, the video frames are independent. However, MPEG4 consumes much less network bandwidth than JPEG. Frame Sizes: 2 options exist for the sizes of the video display. It is recommended using 352x240 for mobile viewing and 640x480 for computer viewing. Max frame rate: The maximum number of frames that is displayed in 1 second. 30fps is the highest video quality for the camera. In general, any frame rate above 15 fps is imperceptible to the human eye. Video Quality: This limits the maximal refresh frame rate, which can be combined with the "Fixed quality" to optimize the bandwidth utilization and video quality. If the user wants to fix the bandwidth utilization regardless of the video quality, choose "Constant bit rate" and select the desired bandwidth. Audio Settings: You can use the option to switch the external microphone on/off or adjust the volume.

Motion Detection

Enabling Video Motion will turn on the motion detection feature. You may draw a finite motion area that will be used for monitoring.

Enable Video

Motion: Select this box to enable the motion detection feature.

Sensitivity: Specifies the measurable difference between two sequential images that would indicate motion. Please enter a value between 0 and 100.

Percentage: Specifies the amount of motion in the window being monitored that is required to initiate an alert. If this is set to 100%, motion is detected within the whole window will trigger a snapshot.

Draw Motion Area: Draw the motion detection area by dragging your mouse in the window (indicated by the red square).

Erase Motion Area: To erase a motion detection area, simply click on the red square that you wish to remove.

Right clicking on the camera image brings up the following menu options:

Select All: Draws a motion detection area over the entire screen.

Clear All: Clears any motion detection areas that have been drawn.

Restore: Restores the previously specified motion detection areas.

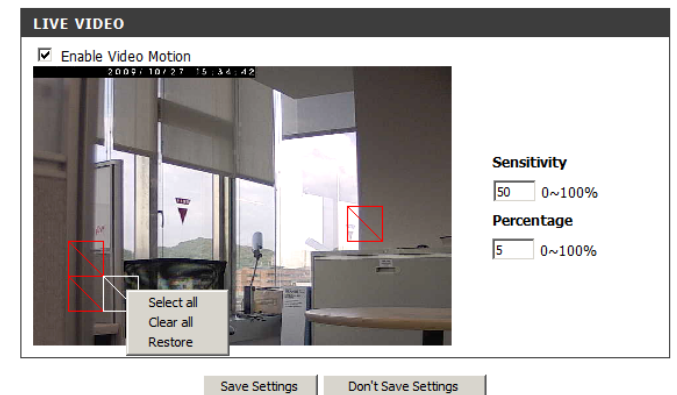
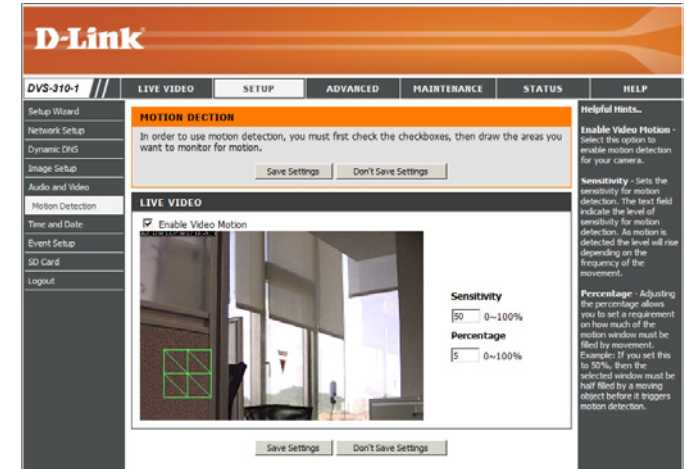

Time and Date

This section allows you to automatically or manually configure, update, and maintain the internal system clock for your Video Encoder.

Time Zone: Select your time zone from the drop-down menu.

Enable Daylight Saving: Select this to enable Daylight Saving Time.

Auto Daylight Saving: Select this option to allow your Video Encoder to configure the Daylight Saving settings automatically.

Set Date and Time Manually: Selecting this option allows you to configure the Daylight Saving date and time manually.

Offset: Sets the amount of time to be added or removed when Daylight Saving is enabled.

Synchronize with NTP Server: Enable this feature to obtain time automatically from an NTP server.

NTP Server: Network Time Protocol (NTP) synchronizes the DVS-310-1 with an Internet time server. Choose the one that is closest to your location.

Set the Date and Time Manually: This option allows you to set the time and date manually.

Copy Your Computer's Time Settings: This will synchronize the time information from your PC.

TIME AND DATE
You can set the current time for the video server.
Save Settings Don't Save Settings

TIME CONFIGURATION
Time Zone | (GMT+08:00) Taipei
 Enable Daylight Saving
 Auto Daylight Saving
 Set date and time manually
Offset: +2:00
Start time: 1:00 Sunday
End time: 1:00 Sunday

AUTOMATIC TIME CONFIGURATION
 Synchronize with NTP Server
NTP Server: ntp.dlink.com.tw << Select NTP Server

SET DATE AND TIME MANUALLY
 Set date and time manually
Year: 2009 Month: 12 Day: 2
Hour: 21 Minute: 45 Second: 55
Copy Your Computer's Time Settings

Save Settings Don't Save Settings

Helpful Hints...
Good timekeeping is important for accurate logs and scheduled traversal rules.
Time Zone: Select your time zone from the drop-down menu.
Enable Daylight Saving: Select this to enable the daylight saving time.
Auto Daylight Saving: When you select it, the clock is automatically adjusted according to the daylight saving time of the selected time zone.
Offset: Select the time offset, if your location observes daylight saving time.
Synchronize with NTP Server: With the option selected, the camera will synchronize the time settings with the NTP server over the Internet whenever the camera starts up. If the timeserver cannot be reached, no time settings will be applied.
NTP Server: Network Time Protocol (NTP) synchronizes the video server with an Internet time server. Choose the one that is closest to your location.
Copy Your Computer's Time Settings: This will synchronize the time information from your PC.

Event Setup

The Event Setup page includes 4 different sections.

- Event
- Server
- Media
- Recording

1. To add a new item - "event, server or media," click **Add**. A screen will appear and allow you to update the fields accordingly.

2. To delete the selected item from the pull-down menu of event, server or media, click **Delete**.

3. Click on the item name to pop up a window for modifying.

Note: You can add up to four events, five servers, and five media fields.

D-Link

DVS-310-1 // LIVE VIDEO SETUP ADVANCED MAINTENANCE STATUS HELP

Setup Wizard
Network Setup
Dynamic DNS
Image Setup
Audio and Video
Motion Detection
Time and Date
Event Setup
SD Card
Logout

EVENT SETUP

There are four sections in Event Setup page. They are event, server, media and recording. Click Add to pop a window to add a new item of event, server, media or recording. Click Delete to delete the selected item from event, server, media or recording. Click on the item name to pop a window to edit it. There can be at most three events and two recording. There can be at most five server and five media configurations.

SERVER

Name	Type	Address/Location
uu	ns	\\my_nas\disk\folder
SD	sd card	

Add | [uu](#) | Delete

MEDIA

Media freespace: 6700KB

Name	Type
aaa	snapshot

Add | [aaa](#) | Delete

EVENT

Name	Status	Sun	Mon	Tue	Wed	Thu	Fri	Sat	Time	Trigger
tt	ON	V	V	V	V	V	V	V	00:00~23:59	network lost

Add | [tt](#) | Delete

RECORDING

Name	Status	Sun	Mon	Tue	Wed	Thu	Fri	Sat	Time	Source	Destination
------	--------	-----	-----	-----	-----	-----	-----	-----	------	--------	-------------

Add | | Delete

Helpful Hints...

Suggest setting server and media first before setting event. The servers and media which selected in event list are not be able to modify or delete. Please remove them first from the event if you want to delete or modify them. Recommend using different media in different event to make use all media be produced and received correctly. If using the same media in different events and the events trigger almost simultaneously, the servers in the second triggered event will not receive any media; there would be only notifications.

Application

In a typical application, when motion is detected, the DVS-310-1 Video Encoder sends images to a FTP server or via e-mail as notifications. As shown in the illustration below, an event can be triggered by many sources, such as motion detection or external digital input devices. When an event is triggered, a specified action will be performed. You can configure the Video Encoder to send snapshots or videos to your e-mail address or FTP site.

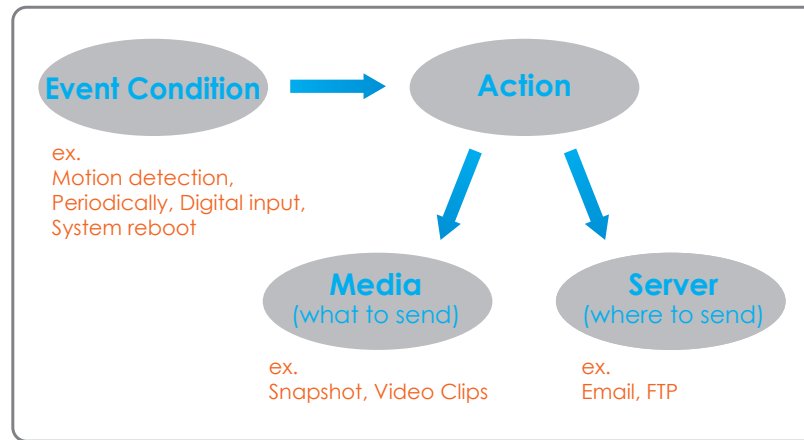

To start plotting an event, it is suggested to configure server and media columns first so that the Video Encoder will know what action shall be performed when a trigger is activated.

Add Server

Configure up to 5 servers to store media.

Server Name: Enter the unique name of your server.

E-mail: Enter the configuration for the target e-mail server account.

FTP: Enter the configuration for the target FTP server account.

Network Storage: Specify a network storage device. Only one network storage device is supported.

SD Card: Use the Video Encoder's onboard SD card storage.

D-Link

DVS-310-1 // LIVE VIDEO SETUP ADVANCED MAINTENANCE STATUS HELP

SERVER

You can set at most 5 different servers here for different event.

Test Save Settings Don't Save Settings

SERVER TYPE

Server Name: Server1

Email

Sender email address

Recipient email address

Server address

User name

Password

Port

FTP

Server address

Port

User name

Password

Remote folder name

Passive mode

Network storage

Network storage location
(for example: \\my_nas\disk\folder)

Workgroup

User name

Password

Primary WINS server

SD Card

Helpful Hints.

"Server name" The unique name for server. There are four kinds of servers supported. They are email server, FTP server, HTTP server and network storage.

Email server: "Sender email address" The email address of the sender. "Recipient email address" The email address of the recipient.

FTP server: "Remote folder name" Granted folder on the external FTP server. The string must conform to that of the external FTP server. Some FTP servers cannot accept preceding slash symbol before the path without virtual path mapping. Refer to the instructions for the external FTP server for details. The folder privilege must be open for upload. "Passive Mode" Check it to enable passive mode in transmission.

Network storage: Only one network storage is supported. "Network storage location" The path to upload the media. "Workgroup" The workgroup for network storage.

SD card: Use the SD card for recording media.

Add Media

There are three types of media, **Snapshot**, **Video Clip** and **System Log**.

Media Name: Enter an unique name for media.

Snapshot: Select this option to enable snapshots.

Source: The stream source: **Profile 1**, **Profile 2** or **Profile 3**.

Send pre-event image(s) [0~4]: The number of pre-event images.

Send post-event image(s) [0~7]: The number of post-event images.

File name prefix: The prefix name will be added on the file name.

Add date and time suffix to file name: Check it to add timing information as file name suffix.

Video clip: Select this option to enable video clips.

Source: The source of the profile: **profile1**, **profile2**, or **profile3**.

Pre-event recording: The interval of pre-event recording in seconds.

Maximum duration: The maximal recording file duration in seconds.

Maximum file size: The maximal file size would be generated.

File name prefix: The prefix name will be added on the file name of the video clip.

System log: Select this option to save events to the system log.

D-Link

DVS-310-1 // LIVE VIDEO SETUP ADVANCED MAINTENANCE STATUS HELP

Setup Wizard
Network Setup
Dynamic DNS
Image Setup
Audio and Video
Motion Detection
Time and Date
Event Setup
SD Card
Logout

MEDIA

You can set at most 5 different media here for different event.

Save Settings Don't Save Settings

MEDIA TYPE

Media name: Media1

Snapshot

Source: Profile 1

Send 1 pre-event image(s) [0~4]

Send 1 post-event image(s) [0~7]

File Name Prefix:

Add date and time suffix to file name

Video clip

Source: Profile 1

Pre-event recording: 0 Second(s) [0~4]

Maximum duration: 5 Second(s) [1~100]

Maximum file size: 500 Kbytes [100~800]

File Name Prefix:

System log

Save Settings Don't Save Settings

Helpful Hints.

"Media name" The unique name for media. There are three kinds of media. They are snapshot, video clip and system log.

"Source" The source of stream, stream1 or stream2.

"Send Pre-event images" The number of pre-event images.

"Send Post-event images" The number of post-event images.

"File name prefix" The prefix name will be added on the file name of the snapshot images.

"Add date and time suffix to file name" Check it to add timing information as file name suffix.

"Video clip" "Source" The source of stream, stream1 or stream2.

"Pre-event recording" The interval of pre-event recording in seconds There are two limitations for video clip file.

"Maximum duration" The maximal recording file duration in seconds.

"Maximum file size" The maximal file size would be generated.

Send post-event image (s) [0~7]

Specify to capture the number of images after a trigger is activated. A maximum of seven images can be generated.

For example:

If both the Send pre-event images and Send post-event images are set to four, a total of 9 images are generated after a trigger is activated.

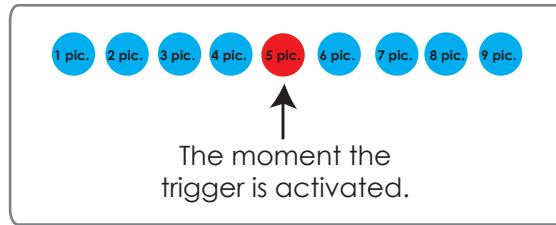

Add a date and time suffix to the file name

Select this option to add a date and time to the file name suffix.

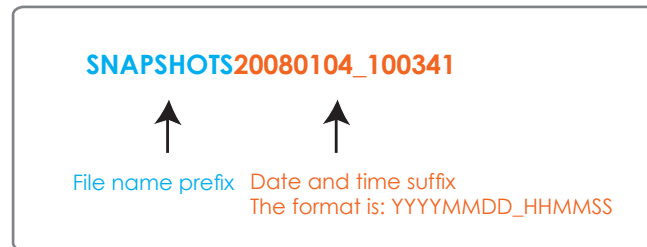

Maximum duration

Specify the maximal recording duration in seconds. You can set up to ten seconds.

For example:

If the Pre-event recording is set to five seconds and the Maximum duration is set to ten seconds, the Video Encoder continues to record

for another four seconds after a trigger is activated.

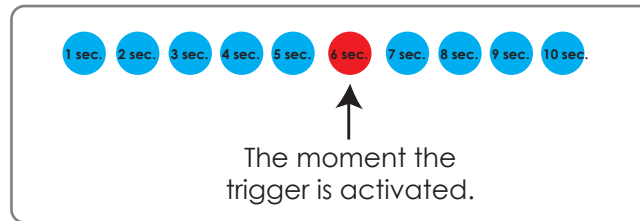

File name prefix

Enter the text that will be added at the beginning of the file name.

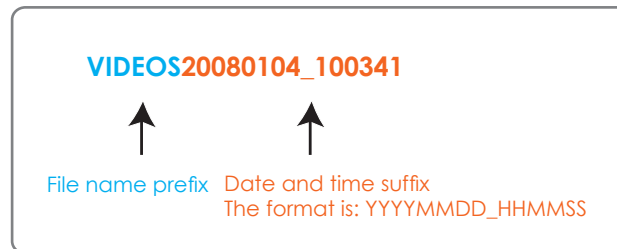

Add Event

Create and schedule up to 3 events with their own settings here.

Event name: Enter a name for the event.

Enable this event: Select this box to activate this event.

Priority: Set the priority for this event. The event with higher priority will be executed first.

Delay: Select the delay time before checking the next event. It is being used for both events of motion detection and digital input trigger.

Trigger: Specify the input type that triggers the event.

Video Motion Detection: Motion is detected during live video monitoring. Select the windows that need to be monitored.

Periodic: The event is triggered in specified intervals. The trigger interval unit is in minutes.

Digital Input: Triggers an event from a digital input device.

System Boot: Triggers an event when the system boots up.

Network Lost: Triggers an event when the network connect is lost.

Video Lost: Triggers an event when the video feed is lost.

Time: Select **Always** or specify the time interval.

The screenshot shows the 'Add Event' configuration page in the D-Link DVS-310-1 web interface. The page is titled 'D-Link' and 'DVS-310-1' with 'Firmware Version: 0.04'. The navigation menu includes 'LIVE VIDEO', 'SETUP', 'ADVANCED', 'MAINTENANCE', 'STATUS', and 'HELP'. The 'SETUP' menu is expanded, showing options like 'Setup Wizard', 'Network Setup', 'Dynamic DNS', 'Image Setup', 'Audio and Video', 'Motion Detection', 'Time and Date', 'Event Setup', 'SD Card', and 'Logout'. The 'Event Setup' page is active, displaying the following sections:

- EVENT**: A message states 'You can set at most 3 events like motion detection or digital input trigger here and arrange the detection schedule at the same time.' Below this are 'Save Settings' and 'Don't Save Settings' buttons.
- EVENT**: A form with 'Event name:' (text input), 'Enable this event' (checkbox), 'Priority:' (dropdown menu set to 'normal'), and 'Delay for' (input field with '00' and 'seconds before detecting next event [For motion detection and digital input]').
- TRIGGER**: Radio buttons for 'Video motion detection' (selected), 'Periodic' (with 'Trigger every' and 'minutes' input), 'Digital input', 'System boot', 'Network lost', and 'Video lost'.
- EVENT SCHEDULE**: 'Sun ~ Sat' (all days checked), 'Time' (radio buttons for 'Always' (selected) and 'From' (with '00' and '00' input) 'To' (with '23' and '59' input)).
- ACTION**: 'Trigger D/O for' (input field with '0' and 'seconds'), 'uu' (checkbox), 'Attached media:' (dropdown menu with 'aaa'), 'SD' (checkbox), and 'Attached media:' (dropdown menu with 'aaa').

On the right side, there is a 'Helpful Hints...' section with text explaining priority, delay, video motion detection, periodic triggers, digital input, system boot, network lost, video lost, and action options. At the bottom of the form are 'Save Settings' and 'Don't Save Settings' buttons.

Trigger D/O: Select this option to trigger the digital output for a specific number of seconds when an event occurs.

Server: Specify the location where the event information should be saved to. This option will not be available for the **Network Lost** trigger.

SD: Select this option to record to an SD card that has been inserted into the device.

Add Recording

Here you can configure and schedule the recording settings.

Recording entry name: The unique name of the entry.

Enable this recording: Select this to enable the recording function.

Priority: Set the priority for this entry. The entry with a higher priority value will be executed first.

Source: The source of the stream.

Recording schedule: Scheduling the recording entry.

Recording settings: Configuring the setting for the recording.

Destination: Select the folder where the recording file will be stored.

Total cycling recording size: Please input a HDD volume between 1MB and 200GB for recording space. The recording data will replace the oldest record when the total recording size exceeds this value. For example, if each recording file is 6MB, and the total cyclic recording size is 600MB, then the Video Encoder will record 100 files in the specified location (folder) and then will delete the oldest file and create new file for cyclic recording.

Please note that if the free HDD space is not enough, the recording will stop. Before you set up this option please make sure your HDD has enough space, and it is better to not save other files in the same folder as recording files.

Size of each file for recording: File size for each recording file. You may input the value in the range of 200-5000.

File Name Prefix: The prefix name will be added on the file name of the recording file(s).

The screenshot displays the D-Link DVS-310-1 web interface. The top navigation bar includes 'LIVE VIDEO', 'SETUP', 'ADVANCED', 'MAINTENANCE', 'STATUS', and 'HELP'. The 'SETUP' tab is active, and the 'RECORDING' section is highlighted in orange. The interface is divided into several sections:

- RECORDING:** Contains a text input for 'Recording entry name', a checkbox for 'Enable this recording', a 'Priority' dropdown menu (set to 'normal'), and a 'Source' dropdown menu (set to 'Profile 1').
- RECORDING SCHEDULE:** Features a weekly schedule grid with checkboxes for Sun, Mon, Tue, Wed, Thu, Fri, and Sat. Below the grid, there are radio buttons for 'Always' and 'From' (with time range inputs: From [00] To [23] [59]).
- RECORDING SETTINGS:** Includes a 'Destination' dropdown menu (set to 'Server 1'), a 'Total cycling recording size' input (1000 Kbytes), a 'Size of each file for recording' input (200 Kbytes), and a 'File Name Prefix' input.

On the right side, there is a 'Helpful Hints...' section with detailed instructions on recording, scheduling, and cycling. At the bottom of the main content area, there are 'Save Settings' and 'Don't Save Settings' buttons.

SD Card

Here you may browse and manage the recorded files which are stored on the SD card.

Format SD Card: Click this icon to automatically format the SD card and create "picture" & "video" folders.

View Recorded Picture: If the picture files are stored on the SD card, click on the picture folder and choose the picture file you would like to view.

Playback Recorded Video: If video files are stored on the SD card, click on the video folder and choose the video file you would like to view.

Refresh: Reloads the file and folder information from the SD card.



Advanced

Digital Input/Output

This screen allows you to control the behavior of digital input and digital output devices. The I/O connector provides the physical interface for digital output (DO) and digital input (DI) that is used for connecting a diversity of external alarm devices such as IR-Sensors and alarm relays. The digital input is used for connecting external alarm devices and once triggered images will be taken and e-mailed.

Select D/I or D/O Mode: The Video Encoder will send a signal when an event is triggered, depending upon the type of device connected to the DI circuit.

N.C. stands for **Normally Closed**. This means that the normal state of the circuit is closed. Therefore events are triggered when the device status changes to "Open."

N.O. stands for **Normally Open**. This means that the normal state of the circuit is open. Therefore events are triggered when the device status changes to "Closed."

LED: You may specify whether or not to illuminate the LED on the side of the Video Encoder.

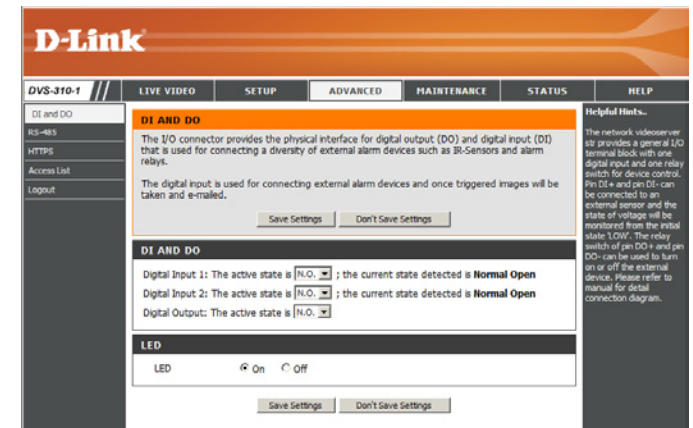

D/I and D/O
Pin Block

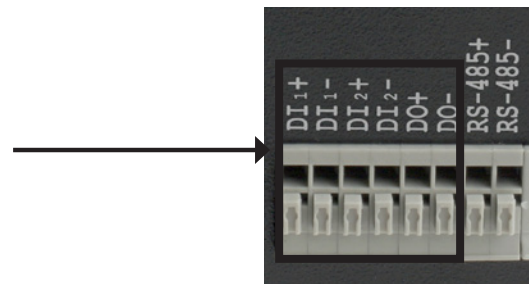

RS-485

You may configure the RS-485 settings or communication specifications (baud rate, data bit, stop bit, and parity bit) for your Video Encoder. RS-485 is a serial communication method for computers and devices. RS-485 is used to control a PAN/TILT apparatus, such as an external camera enclosure.

Support PAN-TILT: When **Support PAN-TILT** is enabled, a control panel will be displayed on the Live Video page allowing control through RS-485 for an external camera enclosure.

Protocol: Select one protocol type from the pull-down menu.

ID: This ID is the identifier for RS-485 devices. IDs range from 1 to 255.

Baud Rate: Baud Rate is a speed measurement for communication between a transmitter and receiver which indicates the number of bit transfers per second. A higher baud rate will reduce the distance of the two devices (transmitter and receiver). Values range from 2400 (default) to 19200 bps.

Data Bit: This value is the number of data bits in a transmission. The data bit can be 7 or 8 (default).

Parity Bit: Parity is a form of error checking used in serial communication. For even and odd parities, the serial port sets the parity bit (the last bit after the data bits) to a value to ensure that the transmission has an even or odd number of logic-high bits. For example, if the data is 011, for even parity, the parity bit is 0 to keep the number of logic-high bits even. If the parity is odd, the parity bit is 1, resulting in 3 logic-high bits. Parity can be set to **No** (none), **Even**, and **Odd**.

Stop Bit: The stop bit is used to signal the end of communication for a single packet. The more bits used for stop bits, the greater the lenience in synchronizing the different clocks but the slower the data transmission rate. The stop bit can be set to 1 or 2. The default value is 1.

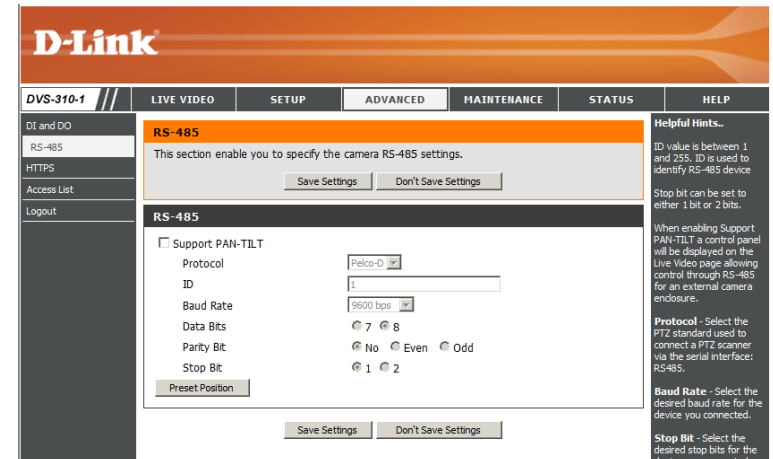

**RS-485
Pin Block**

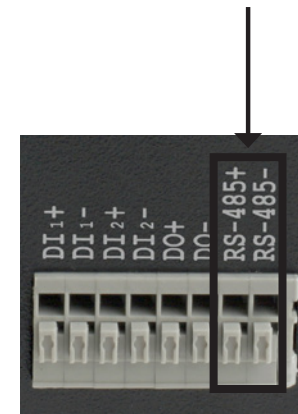

HTTPS

This page allows you to install and activate an HTTPS certificate for secure access to your Video Encoder.

Enable HTTPS Secure Connection:

Connection: Enable the HTTPS service.

Create Certificate Method: Choose the way the certificate should be created. Three options are available:

- Create a self-signed certificate automatically
- Create a self-signed certificate manually
- Create a certificate request and install

Status: Displays the status of the certificate.

Note: The certificate cannot be removed while the HTTPS is still enabled. To remove the certificate you must first uncheck **Enable HTTPS secure connection**.

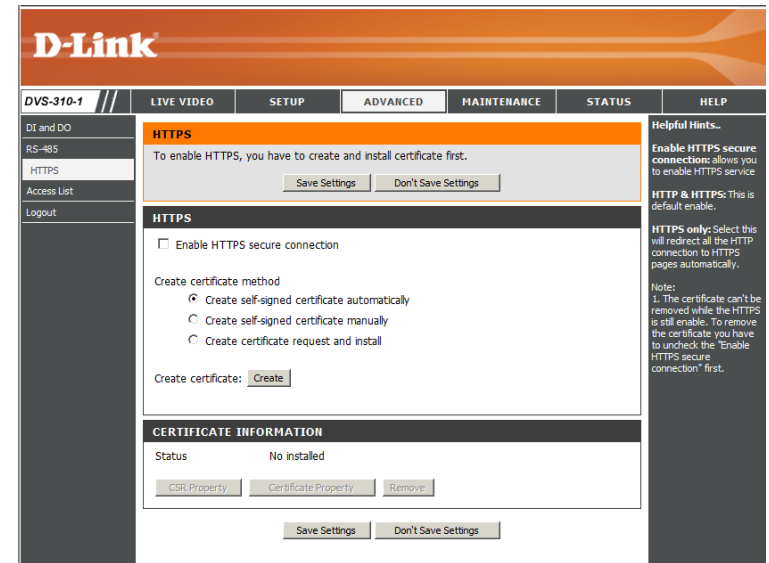

Access List

Here you can set access permissions for users to view your DVS-310-1.

Allow list: The list of IP addresses that have the access right to the Video Encoder.

Start IP address: The starting IP Address of the devices (such as a computer) that have permission to access the video of the camera. Click Add to save the changes made.

Note: A total of seven lists can be configured for both columns.

End IP address: The ending IP Address of the devices (such as a computer) that have permission to access the video of the camera.

Delete allow list: Remove the customized setting from the Allow List.

Deny list: The list of IP addresses that have no access right to the Video Encoder.

Delete deny list: Remove the customized setting from the Delete List.

For example:

When the range of the Allowed List is set from 1.1.1.0 to 192.255.255.255 and the range of the Denied List is set from 1.1.1.0 to 170.255.255.255. Only users with IPs located between 171.0.0.0 and 192.255.255.255 can access the Video Encoder.

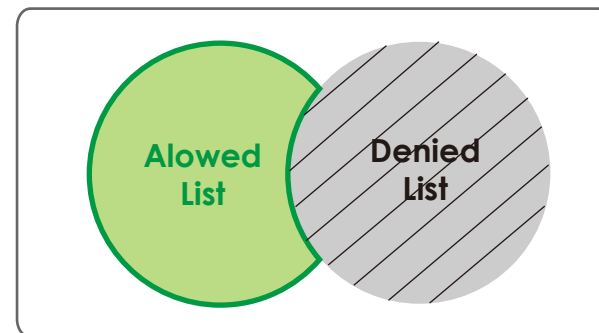
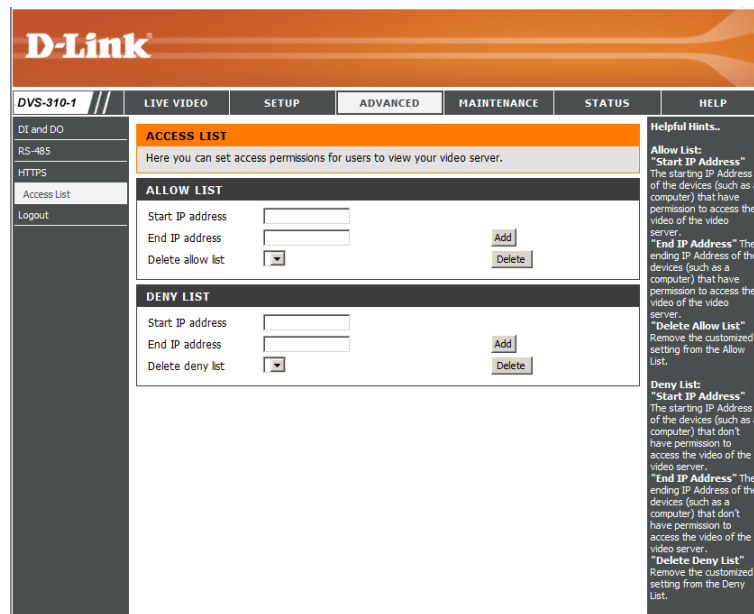

Maintenance

Admin

You may modify the name and administrator's password of your Video Encoder, as well as add and manage the user accounts for accessing the Video Encoder. You may also use this section to create the unique name and configure the OSD settings.

Admin Password

Setting: Set a new password for the administrator's account.

Add User

Account: Add new user account.

User Name: The user name for the new account.

Password: The password for the new account.

User List: All the existing user accounts will be displayed here. You may delete accounts included in the list, but please reserve at least one as guest.

Video Encoder Name: Create a unique name for your Video Encoder that will be added to the file name prefix when creating a snapshot or a video clip.

Enable OSD: Select this option to enable the On-Screen Display feature for your video feed.

Label: Enter a label for the Video Encoder. This label will appear on the video feed.

Show Time: Select this option to enable the time-stamp display on the video feed.

D-Link

DVS-310-1 // LIVE VIDEO SETUP ADVANCED MAINTENANCE STATUS HELP

Admin
System
Firmware Upgrade
Logout

ADMIN

Here you can change the administrator's password for your Video Server as well as add and/or delete user account(s). You can configure the information, such as Video Server's name and time via this page. You can also enable the OSD (On-Screen Display) feature in order to display the Video Server name and time stamp for your video recordings.

ADMIN PASSWORD SETTING

New Password 8 characters maximum
Retype Password Save

ADD USER ACCOUNT

User Name 20 users maximum
New Password 8 characters maximum
Retype Password
Add

USER LIST

User Name -- User list -- Delete

DEVICE SETTING

Video Server Name DVS-310-1A1 30 characters maximum
 Enable OSD
Label DVS-310-1A1
Show time
Save

Helpful Hints...
Enabling OSD, the Video Server name and time will be displayed on the video screen for the User.
For security purposes, it is recommended that you change the password for your administrator account. Be sure to write down the new password to avoid having to reset the Video Server in the event that it is forgotten.

Backup and Restore

In this section, you may backup, restore and reset the Video Encoder configuration, or reboot the device.

Save To Local Hard Drive: You may save and document your current settings into your computer.

Local From Local Hard Drive: Locate a pre-saved configuration by clicking **Browse** and then restore the pre-defined settings to your Video Encoder by clicking **Load Configuration**.

Restore to Factory Default: You may reset your Video Encoder and restore the factory settings by clicking **Restore Factory Defaults**.

Reboot Device: This will restart your Video Encoder.

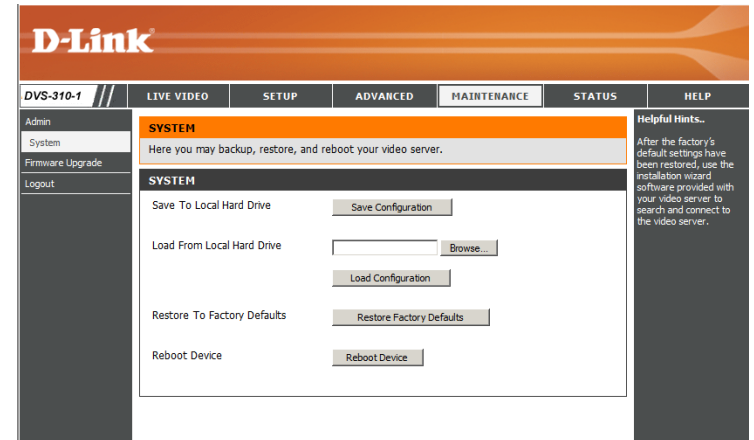

Firmware Upgrade

The Video Encoder's current firmware version will be displayed on this screen. You may visit the D-Link Support Website to check for the latest available firmware version.

To upgrade the firmware on your DVS-310-1, please download and save the latest firmware version from the D-Link Support Page to your local hard drive. Locate the file on your local hard drive by clicking the **Browse** button. Select the file and click the **Upload** button to start upgrading the firmware.

Current Firmware

Version: Displays the detected firmware version.

Current Product

Name: Displays the Video Encoder model name.

File Path: Locate the file (upgraded firmware) on your hard drive by clicking **Browse**.

Upload: Uploads the new firmware to your Video Encoder.

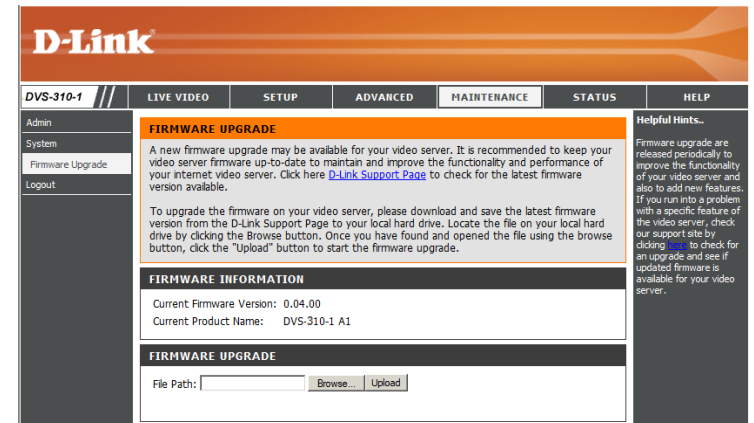

The screenshot shows the D-Link web interface for the DVS-310-1. The top navigation bar includes 'DVS-310-1', 'LIVE VIDEO', 'SETUP', 'ADVANCED', 'MAINTENANCE', 'STATUS', and 'HELP'. The left sidebar contains 'Admin', 'System', 'Firmware Upgrade', and 'Logout'. The main content area is titled 'FIRMWARE UPGRADE' and contains the following text:

A new firmware upgrade may be available for your video server. It is recommended to keep your video server firmware up-to-date to maintain and improve the functionality and performance of your internet video server. Click here [D-Link Support Page](#) to check for the latest firmware version available.

To upgrade the firmware on your video server, please download and save the latest firmware version from the D-Link Support Page to your local hard drive. Locate the file on your local hard drive by clicking the Browse button. Once you have found and opened the file using the browse button, click the "Upload" button to start the firmware upgrade.

FIRMWARE INFORMATION

Current Firmware Version: 0.04.00
Current Product Name: DVS-310-1 A1

FIRMWARE UPGRADE

File Path:

Helpful Hints..

Firmware upgrade are released periodically to improve the functionality of your video server and also to add new features. If you run into a problem with a specific feature of the video server, check our support site by clicking [here](#) to check for an upgrade and see if updated firmware is available for your video server.

Status

Device Info

This page displays detailed information about your device and network connection.

The screenshot shows the D-Link web interface for the DVS-310-1 device. The top navigation bar includes the D-Link logo and tabs for LIVE VIDEO, SETUP, ADVANCED, MAINTENANCE, STATUS, and HELP. The main content area is divided into three sections: a left sidebar with 'Device Info', 'Log', and 'Logout'; a central 'DEVICE INFO' section with a summary and a table of system information; and a right sidebar with 'Helpful Hints..'. The 'DEVICE INFO' section contains the following information:

INFORMATION	
Video Server Name	DVS-310-1 A1
Time & Date	Wed Dec 2 21:46:38 2009
Firmware Version	0.04.00
MAC Address	00:0C:0C:0C:12:43
IP Address	172.17.5.172
IP Subnet Mask	255.255.255.0
Default Gateway	172.17.5.254
Primary DNS	192.168.0.1
Secondary DNS	192.168.168.201
PPPoE	Disable
DDNS	Disable

Logs

This page displays the log information of your Video Encoder. You may download the information by clicking **Download**. You may also click **Clear** to delete the saved log information.

The screenshot shows the D-Link web interface for the DVS-310-1 device. The top navigation bar includes tabs for LIVE VIDEO, SETUP, ADVANCED, MAINTENANCE, STATUS, and HELP. The left sidebar contains links for Device Info, Log, and Logout. The main content area is titled 'SYSTEM LOG' and contains a description: 'The system log records video server events that have occurred.' Below this is a 'CURRENT LOG' section with a list of 20 log entries. At the bottom of the log list are buttons for 'First Page', 'Previous 20', 'Next 20', 'Clear', and 'Download'. A 'Helpful Hints..' section on the right explains that users can save the log to their local hard drive by clicking 'Download' and clear the log by clicking 'Clear'.

D-Link

DVS-310-1 // LIVE VIDEO SETUP ADVANCED MAINTENANCE STATUS HELP

Device Info
Log
Logout

SYSTEM LOG
The system log records video server events that have occurred.

CURRENT LOG

1. 2009-12-02 21:45:19 admin FROM 172.17.5.146 SET GATEWAY 172.17.5.254
2. 2009-12-02 21:45:19 admin FROM 172.17.5.146 SET DDNS TYPE 0
3. 2009-12-02 20:58:13 admin LOGIN OK FROM 172.17.5.146
4. 2009-12-02 07:27:21 admin LOGIN OK FROM 172.17.5.168
5. 2009-12-02 05:38:00 admin LOGIN OK FROM 172.17.5.146
6. 2009-12-02 05:31:36 admin LOGOUT FROM 172.17.5.146
7. 2009-12-02 05:30:41 admin LOGIN OK FROM 172.17.5.146
8. 2009-12-02 05:20:17 admin LOGIN OK FROM 172.17.5.146
9. 2009-12-02 05:19:36 admin LOGIN OK FROM 172.17.5.168
10. 2009-12-02 05:19:02 SYSTEM BOOTING
11. 2009-12-02 04:32:58 MOTION OCCURRED
12. 2009-12-02 04:30:28 MOTION OCCURRED
13. 2009-12-02 04:27:06 MOTION OCCURRED
14. 2009-12-02 04:26:52 MOTION OCCURRED
15. 2009-12-02 04:20:27 MOTION OCCURRED
16. 2009-12-02 04:08:44 MOTION OCCURRED
17. 2009-12-02 03:54:50 MOTION OCCURRED
18. 2009-12-02 03:54:40 MOTION OCCURRED
19. 2009-12-02 03:44:58 MOTION OCCURRED
20. 2009-12-02 03:44:01 MOTION OCCURRED

First Page Previous 20 Next 20
Clear Download

Helpful Hints..
You can save the log to your local hard video server by clicking the Download button, and you can clear the log by clicking on the Clear button.

Help

This page provides helpful information regarding Video Encoder operation.

The screenshot shows the D-Link web interface for the DVS-310-1. At the top is the D-Link logo. Below it is a navigation bar with tabs for LIVE VIDEO, SETUP, ADVANCED, MAINTENANCE, STATUS, and HELP. The HELP tab is selected. On the left is a sidebar with 'Help Menu' and 'Logout' links. The main content area is titled 'HELP MENU' and contains a list of links for each section: LIVE VIDEO (Camera), SETUP (Setup Wizard, Network Setup, Dynamic DNS, Image Setup, Audio and Video, Motion Detection, Time and Date, Event Setup, SD Card), ADVANCED (DI and DO, RS-485, HTTPS, Access List), MAINTENANCE (Admin, System, Firmware Upgrade), and STATUS (Device Info).

DVS-310-1	LIVE VIDEO	SETUP	ADVANCED	MAINTENANCE	STATUS	HELP
Help Menu Logout	HELP MENU <ul style="list-style-type: none">LIVE VIDEOSETUPMAINTENANCEADVANCEDSTATUS	LIVE VIDEO <ul style="list-style-type: none">Camera	SETUP <ul style="list-style-type: none">Setup WizardNetwork SetupDynamic DNSImage SetupAudio and VideoMotion DetectionTime and DateEvent SetupSD Card	ADVANCED <ul style="list-style-type: none">DI and DORS-485HTTPSAccess List	MAINTENANCE <ul style="list-style-type: none">AdminSystemFirmware Upgrade	STATUS <ul style="list-style-type: none">Device Info

Using & Configuring the DVS-310-1

D-Link's DVS-310-1 is a versatile and cost-effective Video Encoder offering both video and audio monitoring. It can also serve as a powerful surveillance system for security applications. This section explains how to view the Video Encoder from either the Internet or from inside your internal network.

Materials Needed:

- 1 DVS-310-1 Video Encoder
- 1 Ethernet Cable
- A Wired or Wireless Router
- Ethernet based PC for system configuration

Setting Up the DVS-310-1 For Use Behind a Router

Installing a DVS-310-1 Video Encoder on your network is an easy 4-step procedure:

1. Assign a Local IP Address to Your Video Encoder
2. View the Video Encoder Using Your Internet Explorer Web Browser
3. Access the Router with Your Web Browser
4. Open Virtual Server Ports to Enable Remote Image Viewing

This section is designed to walk you through the setup process of installing your Video Encoder behind a router and enabling remote video viewing. For the basic setup of the DVS-310-1, follow the steps outlined in the Quick Installation Guide.

After you have completed the setup of the DVS-310-1 outlined in the Quick Installation Guide you will have an operating Video Encoder that has an assigned IP Address. When you use a router to share the Internet with one or more PCs, the IP Address assigned to the Video Encoder will be a local IP Address. This allows viewing within your Local Area Network (LAN). Later, the router can eventually be configured to allow remote viewing of video over the Internet.

1. Assign a Local IP Address to Your Video Encoder

Run the Setup Wizard program from the CD included with the DVS-310-1. Follow the steps in the Quick Installation Guide to configure the DVS-310-1. The Video Encoder will be assigned a local IP Address that allows it to be recognized by the router. Write down this IP Address for future reference.

This is the IP Address assigned to your Video Encoder (192.168.0.120 is only an example). You will probably have a different IP Address.



The screenshot shows the D-Link Securicam Network interface. On the left side, there is a vertical menu with five buttons: Wizard, Search, Link, About, and Exit. The main area displays a table with three columns: MAC Address, Current IP Address, and Device Name. The first row of the table is highlighted in blue and contains the following information:

MAC Address	Current IP Address	Device Name
00 ff 11 11 66 88	192.168.1.169	DVS-310-1

2. View the Video Encoder Using Your Internet Explorer Web Browser

Run your Internet Explorer Web browser. In the address bar, type in the IP Address that was assigned to the Video Encoder by the Installation Wizard program. The DVS-310-1 Home Page appears with a window displaying live video from the Video Encoder. You are able to view this screen from any PC running Internet Explorer on your LAN.

Click on the Configuration button on the left side of the display. Scroll to the bottom of the Network Configuration page to display the ports used by HTTP and Streaming audio and video.

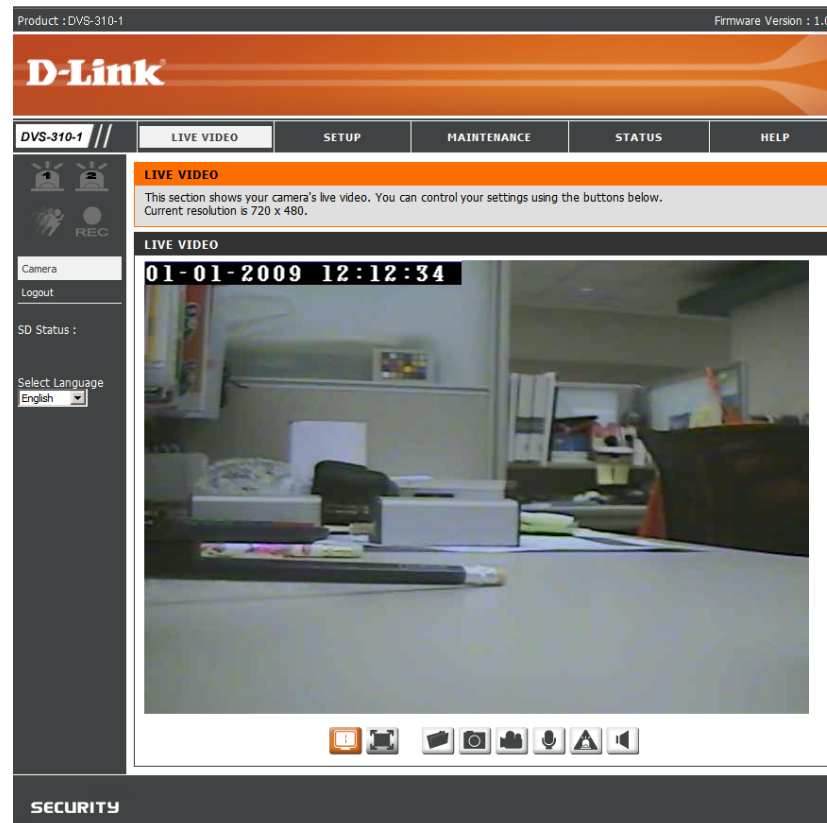

Router Set-Up and Installation

3. Access the Router with Your Web Browser

The following steps generally apply to any router that you have on your network. A D-Link Router is used as an example to clarify the configuration process. Configure the initial settings of the router by following the steps outlined in your own router's installation guide.

If you have cable or DSL Internet service, you will most likely have a dynamically assigned WAN IP Address. 'Dynamic' means that your router's WAN IP address can change from time to time depending on your ISP. A dynamic WAN IP Address identifies your router on the public network and allows it to access the Internet. To find out what your router's WAN IP Address is, go to the Status menu on your router and locate the WAN information for your router (as shown in the screenshot on the right). The WAN IP Address will be listed. This will be the address that you will need to type in your Web browser to view your video feed over the Internet.

Your WAN IP Address will be listed on the router's **Status > Device Info** page.

The screenshot shows the D-Link DIR-301 web interface. The top navigation bar includes 'DIR-301', 'SETUP', 'ADVANCED', 'TOOLS', 'STATUS', and 'SUPPORT'. The 'STATUS' menu is selected, and the 'DEVICE INFO' page is displayed. The page content is as follows:

D-Link	
DIR-301	<p>SETUP ADVANCED TOOLS STATUS SUPPORT</p>
<p>DEVICE INFO</p> <p>LOG</p> <p>STATS</p> <p>WIRELESS</p>	<p>DEVICE INFORMATION :</p> <p>All of your Internet and network connection details are displayed on this page. The firmware version is also displayed here.</p> <p>Firmware Version: 1.00 , Nov 17, 2006</p> <p>LAN :</p> <p>MAC Address : 00-17-9a-4d-8c-e5 IP Address : 192.168.0.1 Subnet Mask : 255.255.255.0 DHCP Server : Enabled</p> <p>WAN:</p> <p>MAC Address : 00-17-9a-4d-8c-e6 Connection : DHCP Client Disconnected <input type="button" value="DHCP Release"/> <input type="button" value="DHCP Renew"/> IP Address : 0.0.0.0 Subnet Mask : 0.0.0.0 Default Gateway : 0.0.0.0 DNS :</p> <p>WIRELESS 802.11G :</p> <p>SSID : dlink Channel : 13 Encryption : Disabled</p>

Note: Because a dynamic WAN IP can change from time to time depending on your ISP, you may want to obtain a Static IP address from your ISP. A Static IP address is a fixed IP address that will not change over time and will be more convenient for you to use to access your Video Encoder from a remote location. The Static IP Address will also allow you to access your Video Encoder attached to your router over the Internet.

4. Open Server Ports to Enable Remote Image Viewing

The firewall security features built into the router prevent users from accessing the video from the DVS-310-1 over the Internet. The router connects to the Internet over a series of numbered ports. The ports normally used by the DVS-310-1 are blocked from access over the Internet. Therefore, these ports need to be made accessible over the Internet. This is accomplished using the Port Forwarding function on the router. The ports used by the Video Encoder must be opened through the router for remote access to your Video Encoder. Port Forwarding is accessed by clicking on the Advanced tab of the router screen.

Follow these steps to configure your router's Port Forwarding settings:

1. Click on one of the empty checkboxes.
2. Enter a unique name for the new entry.
3. Enter your Video Encoder's local IP Address (e.g., 192.168.1.169) in the *IP Address* field.
4. If you are using the default port settings, enter 80 into the *Start* and *End* field. Click *Save Settings*.
5. Select *both* TCP and UDP for the traffic type.
6. For some routers, *Scheduling* should be set to *Always* so that the camera images can be accessed at any time.

D-Link

DIR-301 // SETUP ADVANCED TOOLS STATUS SUPPORT

PORT FORWARDING

PORT FORWARDING RULES :

The Port Forwarding option is used to open a single port or a range of ports through your firewall and redirect data through those ports to a single PC on your network.

Save Settings Don't Save Settings

10- PORT FORWARDING RULES

	Name	IP Address	Start	End	Traffic Type
<input type="checkbox"/>	<input type="text"/> << Application Name >>	<input type="text"/> << Computer Name >>	<input type="text"/> 0	<input type="text"/> 0	Any
<input type="checkbox"/>	<input type="text"/> << Application Name >>	<input type="text"/> << Computer Name >>	<input type="text"/> 0	<input type="text"/> 0	Any
<input type="checkbox"/>	<input type="text"/> << Application Name >>	<input type="text"/> << Computer Name >>	<input type="text"/> 0	<input type="text"/> 0	Any
<input type="checkbox"/>	<input type="text"/> << Application Name >>	<input type="text"/> << Computer Name >>	<input type="text"/> 0	<input type="text"/> 0	Any
<input type="checkbox"/>	<input type="text"/> << Application Name >>	<input type="text"/> << Computer Name >>	<input type="text"/> 0	<input type="text"/> 0	Any

Helpful Hints...

Application Names: Check the Application Name drop down menu for a list of pre-defined applications that you can select from. If you select one of the pre-defined applications, click the arrow button next to the drop down menu to fill out the appropriate fields.

Computer Names: You can select your computer from the list of DHCP clients in the Computer Name drop down menu, or enter the IP address manually of the computer you would like to open the specified port to.

Port Ranges: This feature allows you to open a range of ports to a computer on your network. To do so, enter the first port in the range you would like to open in the Start field and last port of the range in the End field.

Single Ports: To open a single port using this feature, simply enter the same number in both the Start and End fields.

Please make sure to check the box next to the camera name on the Port Forwarding List to enable your settings.

Important: Some ISPs block access to port 80 and other commonly used Internet ports to conserve bandwidth. Check with your ISP so that you can open the appropriate ports accordingly. If your ISP does not pass traffic on port 80, you will need to change the port from 80 to something else, such as 800. Not all routers are the same, so refer to your user manual for specific instructions on how to open ports.

Troubleshooting

1. Why is the Power LED not lighting up?

The power supply used might be at fault. Confirm that you are using the provided power supply, which is DC 12V, for the Video Encoder. Also verify that the power supply is securely connected. If the device is functioning but the LED is not illuminated, the LED may be disabled. Open the firewall configuration page and click **MAINTENANCE**. At the bottom of the page, there will be an option to turn on or turn off the LED.

2. Why does the Video Encoder work locally but not remotely?

This might be caused by firewall protection. Check with your system administrator to see if you are behind a firewall. The firewall may need to have some settings changed in order for the Video Encoder to be accessible outside your LAN.

Make sure that the Video Encoder is not conflicting with any Web server you may have running on your network.

The default router setting might be another possible reason. Check that the configuration of your router's settings allow the Video Encoder to be accessed outside your local LAN.

3. Why are no images available through the Web browser?

ActiveX controls might be disabled within Internet Explorer. Check that ActiveX has been enabled in the **Internet Options** menu. You may also need to change the security settings on your browser to allow the ActiveX plug-in to be installed. If you are using a version of Internet Explorer before version 6.0, you will need to upgrade Internet Explorer in order to view the streaming video transmitted by the Video Encoder.

Example DI/DO Schematic

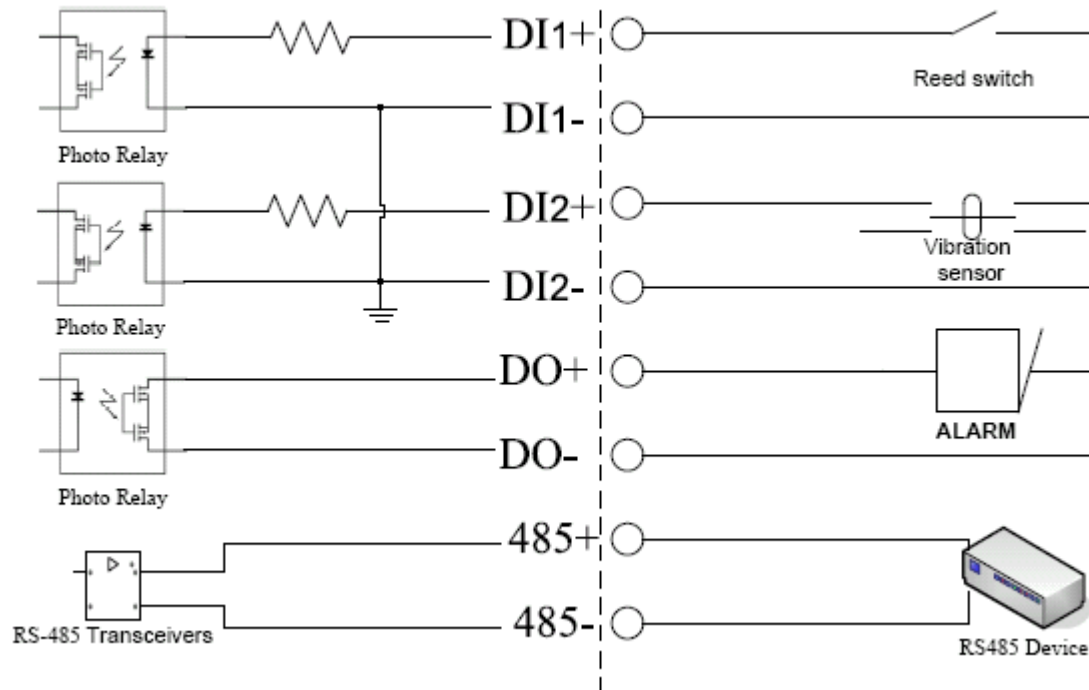

DI	Receives signals from a reed switch, vibration sensor, or any other external security device.
DO	Connects to an alarm or buzzer.
485+/485-	Connects to an RS-485 interface for controlling auxiliary equipment such as an external camera enclosure for pan, tilt, and zoom functionality.

Networking Basics

Check your IP address

After you install your new D-Link adapter, by default, the TCP/IP settings should be set to obtain an IP address from a DHCP server (i.e. wireless router) automatically. To verify your IP address, please follow the steps below.

Click on **Start > Run**. In the run box type **cmd** and click **OK**.

At the prompt, type **ipconfig** and press **Enter**.

This will display the IP address, subnet mask, and the default gateway of your adapter.

If the address is 0.0.0.0, check your adapter installation, security settings, and the settings on your router. Some firewall software programs may block a DHCP request on newly installed adapters.

If you are connecting to a wireless network at a hotspot (e.g. hotel, coffee shop, airport), please contact an employee or administrator to verify their wireless network settings.

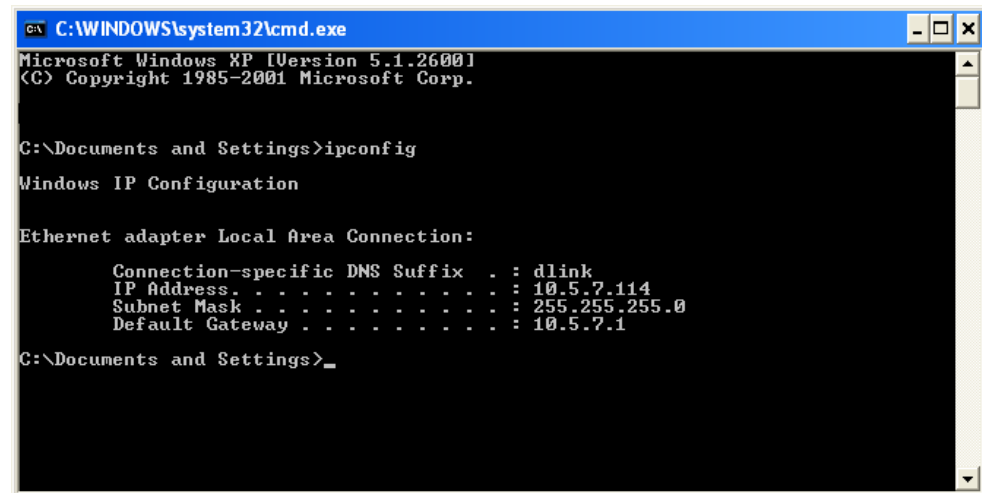

```
C:\WINDOWS\system32\cmd.exe
Microsoft Windows XP [Version 5.1.2600]
(C) Copyright 1985-2001 Microsoft Corp.

C:\Documents and Settings>ipconfig

Windows IP Configuration

Ethernet adapter Local Area Connection:

    Connection-specific DNS Suffix  . : dlink
    IP Address. . . . .               : 10.5.7.114
    Subnet Mask . . . . .             : 255.255.255.0
    Default Gateway . . . . .         : 10.5.7.1

C:\Documents and Settings>_
```

Statically Assign an IP address

If you are not using a DHCP capable gateway/router, or you need to assign a static IP address, please follow the steps below:

Step 1

Windows® Vista - Click on **Start > Control Panel > Network and Internet > Network and Sharing Center > Manage Network Connections.**

Windows XP - Click on **Start > Control Panel > Network Connections.**

Step 2

Right-click on the **Local Area Connection** which represents your D-Link network adapter and select **Properties.**

Step 3

Highlight **Internet Protocol (TCP/IP)** and click **Properties.**

Step 4

Click **Use the following IP address** and enter an IP address that is on the same subnet as your network or the LAN IP address on your router.

Example: If the router's LAN IP address is 192.168.0.1, make your IP address 192.168.0.X where X is a number between 2 and 99. Make sure that the number you choose is not in use on the network. Set Default Gateway the same as the LAN IP address of your router (192.168.0.1).

Set Primary DNS the same as the LAN IP address of your router (192.168.0.1). The Secondary DNS is not needed or you may enter a DNS server from your ISP.

Step 5

Click OK twice to save your settings.

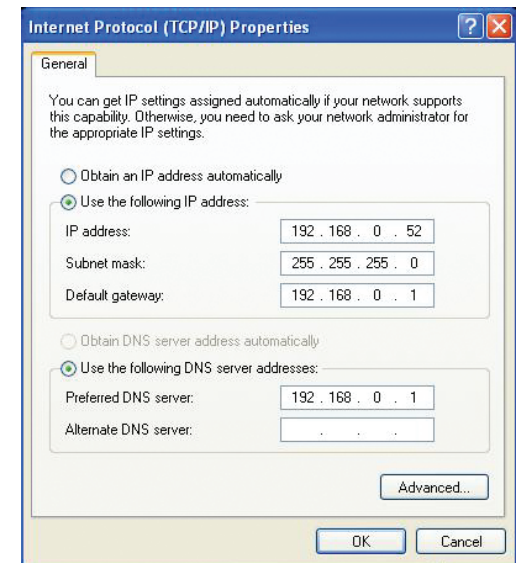

Technical Specifications

Hardware Specifications

- Power Supply: DC 12V / 1.25A
- Removable Storage: SD Card Slot (SDHC compliant)

Video Specifications

Codec

- Simultaneous multi profile support (H.264, MPEG4 and MJPEG)
- Support 3GPP for mobile phone
- JPEG compression for still images

Resolution

- NTSC: D1 (720x480), CIF (352x240), QCIF (176x120)
- PAL: D1 (720x576), CIF (352x288), QCIF (176x144)

Input

- 1CH, NTSC/PAL, BNC connector
- 1.0Vp-p with 75 Ω loading,

Audio Specifications

- Two-way audio
- External audio in
- External audio out
- G.726 codec

Networking Specifications

- Ethernet: RJ45 - 10/100 Base-TX
- Supported Protocols: IPv4, DHCP, ARP, DNS, TCP/IP, DDNS (D-Link), HTTP, HTTPS, UPnP™ Port Forwarding, Samba, SMTP, PPPoE, NTP (D-Link), FTP, RTP, RTSP, UDP, RTCP, ICMP, 3GPP

PTZ Specifications

- Baud rates: 2400, 4800, 9600, 19200
- Connector: RS-485 for PTZ control

Minimum System Requirements

- CPU: Pentium 4, 2.4GHz and above
- Hard Disk: 40 GB or higher
- Memory: 512 MB or higher
- Operating System: Windows 7 / Vista / Windows XP with SP2 or higher / Windows 2000 with SP4 or higher
- Video Resolution: 1024x768 (SVGA/XGA)
- Software: DirectX 9.0c or higher
- Browser: Microsoft IE 6.0 or higher

Power Input

- 802.3af (PoE)
- 100 ~240VAC, 50/60Hz, 12V DC 1.25A

Dimensions

- 105.1(L) x 78.3 (W) x 35.7 (H) mm

Operating Temperature

- 0° to 40°C (32° to 104°F)

Operating Humidity

- 20% to 80% non-condensing

Certifications

- CE (Class A)
- C-Tick (Class A)
- FCC (Class A)