

D-Link™ DES-6500

Modular Layer 3 Chassis-based Ethernet Switch

Firmware Release 2.5

Manual

Information in this document is subject to change without notice.

© 2005 D-Link Computer Corporation. All rights reserved.

Reproduction in any manner whatsoever without the written permission of D-Link Computer Corporation is strictly forbidden.

Trademarks used in this text: D-Link and the D-LINK logo are trademarks of D-Link Computer Corporation; Microsoft and Windows are registered trademarks of Microsoft Corporation.

Other trademarks and trade names may be used in this document to refer to either the entities claiming the marks and names or their products. D-Link Computer Corporation disclaims any proprietary interest in trademarks and trade names other than its own.

September 2005 P/N 6DES6500..06

Table of Contents

Preface	10
Intended Readers	11
Typographical Conventions.....	11
Notes, Notices, and Cautions.....	11
Safety Instructions.....	12
Safety Cautions.....	12
General Precautions for Rack-Mountable Products	13
Protecting Against Electrostatic Discharge.....	14
Introduction	15
Switch Description	15
Features.....	15
DES-6500 chassis contains 9 slots to install the following available modules.....	17
DES-6504 12 port 100BASE-FX (SFF) Fast Ethernet Switch module	17
DES-6505 8-port 1000BASE-SX (SC) Gigabit Ethernet Switch module.....	17
DES-6507 12-port 10BASE-T/100BASE-TX/1000BASE-T Switch module	17
DES-6509 12-port Mini GBIC(SFP) switch module.....	17
DES-6508 16-port 10BASE-T/100BASE-TX Fast Ethernet Switch module	18
DES-6506 Patch Panel	18
DES-6511 Power Supply Modules.....	18
DES-6512 2-port 10 GE XFP Switch Module.....	18
Ethernet Technology	19
Fast Ethernet.....	19
Gigabit Ethernet Technology.....	19
Switching Technology	19
Front-Panel Components and LED Indicators	20
Installation	21
Package Contents.....	21
Before You Connect to the Network.....	21
Installing the Switch without the Rack	22
Installing the Switch in a Rack	22
Mounting the Switch in a Standard 19" Rack.....	23
Power On.....	23
Power Failure	23
External Redundant Power System	23
Connecting the Switch	24
Switch to End Node.....	24
Switch to Hub or Switch.....	25
Using the DES-6500 as a Network Backbone	26

Introduction to Switch Management.....	27
Management Options	27
Web-based Management Interface.....	27
SNMP-Based Management.....	27
Command Line Console Interface through the Serial Port	27
Connecting the Console Port (RS-232 DCE).....	27
First Time Connecting to the Switch	29
Password Protection.....	30
SNMP Settings	31
Traps.....	32
MIBs.....	32
IP Address Assignment.....	32
Connecting Devices to the Switch	34
Introduction to Web-based Switch Configuration.....	35
Introduction	35
Logging on to the Web Manager	35
Web-based User Interface.....	36
Areas of the User Interface.....	36
Web Pages	37
Configuring the Switch.....	38
Switch Information.....	39
Switch IP Settings	39
Setting the Switch's IP Address using the Console Interface.....	41
Advanced Settings	42
Port Configuration	44
Port Mirroring Configuration	46
Link Aggregation	47
Understanding Port Trunk Groups.....	47
LACP Port Settings	50
IGMP Snooping.....	51
Static Router Ports.....	52
Spanning Tree	54
802.1s MSTP	54
802.1w Rapid Spanning Tree	54
Port Transition States	54
Edge Port.....	55
P2P Port.....	55
802.1d / 802.1w / 802.1s Compatibility.....	55
STP Bridge Global Settings.....	56
MST Configuration Identification	58
MSTP Port Information	60

STP Instance Settings	62
STP Port Settings	65
Forwarding & Filtering	67
Unicast Forwarding	67
Static Multicast Forwarding.....	67
VLANs	69
Understanding IEEE 802.1p Priority	69
VLAN Description.....	69
Notes about VLANs in the DES-6500.....	69
IEEE 802.1Q VLANs	70
802.1Q VLAN Tags	71
Port VLAN ID.....	72
Tagging and Untagging	72
Ingress Filtering.....	72
Default VLANs	73
Port-based VLANs	73
VLAN Segmentation	73
VLAN and Trunk Groups.....	74
Protocol VLANs.....	74
VLAN Entry	75
GVRP Settings.....	78
Traffic Control.....	80
Port Security	81
Port Lock Entries.....	82
QoS.....	84
The Advantages of QoS.....	84
Understanding QoS.....	85
Bandwidth Control.....	86
QoS Scheduling Mechanism.....	87
QoS Output Scheduling	88
Configuring the Combination Queue.....	88
802.1p Default Priority	89
802.1p User Priority.....	90
Traffic Segmentation	90
System Log Server	92
System Severity Log	93
SNTP Settings	95
Time Settings.....	95
Time Zone and DST	96
Access Profile Table.....	98
Configuring the Access Profile Table.....	98
CPU Interface Filtering	110

CPU Interface Filtering State Settings	110
CPU Interface Filtering Table.....	110
Port Access Entity (802.1X).....	121
802.1x Port-Based and MAC-Based Access Control.....	121
Authentication Server.....	121
Authenticator.....	122
Client.....	123
Authentication Process.....	124
Understanding 802.1x Port-based and MAC-based Network Access Control.....	125
Port-Based Network Access Control.....	125
MAC-Based Network Access Control.....	126
802.1x Auth Mode Settings.....	127
802.1X Authenticator Settings.....	127
Local Users.....	129
PAE System Control.....	130
Port Capability.....	130
Initializing Ports for Port Based 802.1x.....	131
Initializing Ports for MAC Based 802.1x.....	132
Reauthenticate Port(s) for Port Based 802.1x.....	133
Reauthenticate Port(s) for MAC-based 802.1x.....	134
RADIUS Server.....	135
Layer 3 IP Networking.....	136
Layer 3 Global Advanced Settings.....	136
IP Multinetting.....	137
IP Interface Setup.....	137
MD5 Key Configuration.....	140
Route Redistribution Settings.....	141
Static/Default Route Settings.....	143
Static ARP Table.....	145
RIP.....	146
RIP Global Configuration.....	147
RIP Settings.....	148
OSPF.....	150
OSPF General Settings.....	166
OSPF Area ID Settings.....	167
OSPF Interface Settings.....	168
OSPF Virtual Interface Settings.....	170
OSPF Area Aggregation Settings.....	171
OSPF Host Route Settings.....	173
IP Multicast Routing Protocol.....	174
IGMP.....	174
IGMP Versions 1 and 2.....	174

IGMP Interface Configuration.....	176
DVMRP Interface Configuration.....	177
DVMRP Configuration	177
DVMRP Interface Settings.....	178
PIM-DM Interface Configuration.....	179
PIM-DM Configuration.....	179
DNS Relay.....	181
DNS Relay Information.....	181
DNS Relay Static Settings.....	182
DHCP / BOOTP Relay	183
DHCP Auto Configuration Settings	183
DHCP / BOOTP Relay Information	183
DHCP/BOOTP Relay Settings	184
VRRP.....	185
VRRP Global Settings	185
VRRP Virtual Router Settings.....	186
VRRP Authentication Settings	189
Security Management.....	191
Security IP.....	191
User Account Management	191
Admin and User Privileges.....	192
Secure Shell (SSH).....	194
SSH Configuration.....	194
SSH Algorithm	196
SSH User Authentication Mode.....	198
Access Authentication Control.....	200
Authentication Policy & Parameters.....	201
Application's Authentication Settings.....	202
Authentication Server Group	203
Authentication Server Host.....	205
Login Method Lists.....	207
Enable Method Lists	209
Local Enable Password.....	211
Enable Admin	212
Secure Socket Layer (SSL)	213
Download Certificate.....	213
Configuration.....	214
SNMP Manager.....	216
SNMP Settings	216
SNMP Trap Settings	217
SNMP User Table.....	217
SNMP View Table.....	220

SNMP Group Table	221
SNMP Community Table	223
SNMP Host Table.....	224
SNMP Engine ID.....	225
Monitoring	226
CPU Utilization	226
Port Utilization	228
Packets.....	229
Received (RX).....	229
UMB Cast (RX).....	231
Transmitted (TX).....	233
Errors.....	235
Received (RX).....	235
Transmitted (TX).....	237
Size.....	239
Stacking Information.....	241
Device Status.....	242
MAC Address.....	243
Switch History Log	245
IGMP Snooping Group	246
IGMP Snooping Forwarding.....	247
Browse Router Port	248
Port Access Control.....	249
Authenticator State	249
Authenticator Diagnostics.....	251
Authenticator Session Statistics.....	254
Authenticator Statistics	256
RADIUS Accounting.....	258
RADIUS Authentication.....	260
Layer 3 Feature.....	262
Browse IP Address Table	262
Browse Routing Table	263
Browse ARP Table	263
Browse IP Multicast Forwarding Table	264
Browse IGMP Group Table.....	264
OSPF Monitoring	265
Browse OSPF LSDB Table	265
Browse OSPF Neighbor Table	266
OSPF Virtual Neighbor	267
DVMRP Monitoring.....	268
Browse DVMRP Routing Table.....	268

Browse DVMRP Neighbor Table.....	269
Browse DVMRP Routing Next Hop Table	269
PIM Monitoring.....	270
PIM Neighbor Address Table.....	270
Switch Maintenance	271
TFTP Services	271
Download Firmware	271
Download Configuration	272
Upload Configuration	272
Upload History Log	272
Ping Test.....	273
Traceroute.....	273
Save Configuration.....	274
Reset	274
Reboot Device	276
Logout	276
D-Link Single IP Management	277
Single IP Management (SIM) Overview	277
SIM Using the Web Interface.....	278
Topology	280
Tool Tips	282
Right Click.....	283
Group Icon.....	283
Commander Switch Icon	284
Member Switch Icon	285
Candidate Switch Icon.....	285
Menu Bar	287
Group.....	287
Device	287
View	287
Firmware Upgrade.....	288
Configuration File Backup/Restore	288
Appendix A	289
Appendix B	291
Upgrading Instructions for Release 2.5 Firmware (R2.50-B12)	291
Line Card Firmware Compatibility	291
Precautions for Adding New Line Cards to the Chassis	291
Upgrading to R2.50-B12	292
Adding Runtime R1.01 DES-6505/DES-6507/DES-6509 Line Cards to the Runtime R1.30/1.4/2.0/2.5 Chassis.....	298
Firmware Downgrade Procedure.....	302
Appendix C	308

Cables and Connectors	308
Appendix D	309
Cable Lengths	309
Glossary.....	310
Warranties and Registration	312
International Offices	349

Preface

The *DES-6500 Manual* is divided into sections that describe the system installation and operating instructions with examples.

Section 1, Introduction - Describes the Switch and its features.

Section 2, Installation- Helps you get started with the basic installation of the Switch and also describes the front panel, rear panel, side panels, and LED indicators of the Switch.

Section 3, Connecting the Switch - Tells how you can connect the Switch to your Ethernet network.

Section 4, Introduction to Switch Management - Introduces basic Switch management features, including password protection, SNMP settings, IP address assignment and connecting devices to the Switch.

Section 5, Introduction to Web-based Switch Management - Talks about connecting to and using the Web-based switch management feature on the Switch.

Section 6, Configuring the Switch - A detailed discussion about configuring some of the basic functions of the Switch, including accessing the Switch information, using the Switch's utilities and setting up network configurations, such as Quality of Service, The Access Profile Table, port mirroring and configuring the Spanning Tree.

Section 7, Management - A discussion of the security features of the Switch, including Security IP, User Accounts, and Access Authentication Control.

Section 8, SNMP Manager – A detailed discussion regarding the Simple Network Monitoring Protocol including description of features and a brief introduction to SNMP.

Section 9, Monitoring - Features graphs and screens used in monitoring features and packets on the Switch.

Section 10, Maintenance - Features information on Switch utility functions, including TFTP Services, Switch History, Ping Test Save Changes and Rebooting Services.

Section 11, Single IP Management - Discussion on the Single IP Management function of the Switch, including functions and features of the Java based user interface and the utilities of the SIM function.

Appendix A, Technical Specifications - The technical specifications of the DES-6500.

Appendix B Upgrading Instructions for Release 2 Firmware (R2.00-B20) A detailed explanation about the latest firmware release and downloading instruction for the DES-6500.

Appendix C, Cables and Connectors - Describes the RJ-45 receptacle/connector, straight-through and crossover cables and standard pin assignments.

Appendix D, Cable Lengths - Information on cable types and maximum distances.

Glossary - Lists definitions for terms and acronyms used in this document.

Intended Readers

The *DES-6500 Manual* contains information for setup and management of the Switch. This manual is intended for network managers familiar with network management concepts and terminology.

Typographical Conventions

Convention	Description
[]	In a command line, square brackets indicate an optional entry. For example: [copy filename] means that optionally you can type copy followed by the name of the file. Do not type the brackets.
Bold font	Indicates a button, a toolbar icon, menu, or menu item. For example: Open the File menu and choose Cancel . Used for emphasis. May also indicate system messages or prompts appearing on your screen. For example: You have mail. Bold font is also used to represent filenames, program names and commands. For example: use the copy command.
Boldface Typewriter Font	Indicates commands and responses to prompts that must be typed exactly as printed in the manual.
Initial capital letter	Indicates a window name. Names of keys on the keyboard have initial capitals. For example: Click Enter.
<i>Italics</i>	Indicates a window name or a field. Also can indicate a variables or parameter that is replaced with an appropriate word or string. For example: type <i>filename</i> means that you should type the actual filename instead of the word shown in italic.
Menu Name > Menu Option	Menu Name > Menu Option Indicates the menu structure. Device > Port > Port Properties means the Port Properties menu option under the Port menu option that is located under the Device menu.

Notes, Notices, and Cautions



A **NOTE** indicates important information that helps you make better use of your device.



A **NOTICE** indicates either potential damage to hardware or loss of data and tells you how to avoid the problem.



A **CAUTION** indicates a potential for property damage, personal injury, or death.

Safety Instructions

Use the following safety guidelines to ensure your own personal safety and to help protect your system from potential damage. Throughout this safety section, the caution icon () is used to indicate cautions and precautions that you need to review and follow.



Safety Cautions

To reduce the risk of bodily injury, electrical shock, fire, and damage to the equipment, observe the following precautions.

- Observe and follow service markings.
 - Do not service any product except as explained in your system documentation.
 - Opening or removing covers that are marked with the triangular symbol with a lightning bolt may expose you to electrical shock.
 - Only a trained service technician should service components inside these compartments.
- If any of the following conditions occur, unplug the product from the electrical outlet and replace the part or contact your trained service provider:
 - The power cable, extension cable, or plug is damaged.
 - An object has fallen into the product.
 - The product has been exposed to water.
 - The product has been dropped or damaged.
 - The product does not operate correctly when you follow the operating instructions.
- Keep your system away from radiators and heat sources. Also, do not block cooling vents.
- Do not spill food or liquids on your system components, and never operate the product in a wet environment. If the system gets wet, see the appropriate section in your troubleshooting guide or contact your trained service provider.
- Do not push any objects into the openings of your system. Doing so can cause fire or electric shock by shorting out interior components.
- Use the product only with approved equipment.
- Allow the product to cool before removing covers or touching internal components.
- Operate the product only from the type of external power source indicated on the electrical ratings label. If you are not sure of the type of power source required, consult your service provider or local power company.
- To help avoid damaging your system, be sure the voltage selection switch (if provided) on the power supply is set to match the power available at your location:
 - 115 volts (V)/60 hertz (Hz) in most of North and South America and some Far Eastern countries such as South Korea and Taiwan
 - 100 V/50 Hz in eastern Japan and 100 V/60 Hz in western Japan
 - 230 V/50 Hz in most of Europe, the Middle East, and the Far East
- Also, be sure that attached devices are electrically rated to operate with the power available in your location.
- Use only approved power cable(s). If you have not been provided with a power cable for your system or for any AC-powered option intended for your system, purchase a power cable that is approved for use in your country. The power cable must be rated for the product and for the voltage and current marked on the product's electrical ratings label. The voltage and current rating of the cable should be greater than the ratings marked on the product.

- To help prevent electric shock, plug the system and peripheral power cables into properly grounded electrical outlets. These cables are equipped with three-prong plugs to help ensure proper grounding. Do not use adapter plugs or remove the grounding prong from a cable. If you must use an extension cable, use a 3-wire cable with properly grounded plugs.
- Observe extension cable and power strip ratings. Make sure that the total ampere rating of all products plugged into the extension cable or power strip does not exceed 80 percent of the ampere ratings limit for the extension cable or power strip.
- To help protect your system from sudden, transient increases and decreases in electrical power, use a surge suppressor, line conditioner, or uninterruptible power supply (UPS).
- Position system cables and power cables carefully; route cables so that they cannot be stepped on or tripped over. Be sure that nothing rests on any cables.
- Do not modify power cables or plugs. Consult a licensed electrician or your power company for site modifications. Always follow your local/national wiring rules.
- When connecting or disconnecting power to hot-pluggable power supplies, if offered with your system, observe the following guidelines:
 - Install the power supply before connecting the power cable to the power supply.
 - Unplug the power cable before removing the power supply.
 - If the system has multiple sources of power, disconnect power from the system by unplugging all power cables from the power supplies.
- Move products with care; ensure that all casters and/or stabilizers are firmly connected to the system. Avoid sudden stops and uneven surfaces.



General Precautions for Rack-Mountable Products

Observe the following precautions for rack stability and safety. Also, refer to the rack installation documentation accompanying the system and the rack for specific caution statements and procedures.

- Systems are considered to be components in a rack. Thus, "component" refers to any system as well as to various peripherals or supporting hardware.



CAUTION: Installing systems in a rack without the front and side stabilizers installed could cause the rack to tip over, potentially resulting in bodily injury under certain circumstances. Therefore, always install the stabilizers before installing components in the rack. After installing system/components in a rack, never pull more than one component out of the rack on its slide assemblies at one time. The weight of more than one extended component could cause the rack to tip over and may result in serious injury.

- Before working on the rack, make sure that the stabilizers are secured to the rack, extended to the floor, and that the full weight of the rack rests on the floor. Install front and side stabilizers on a single rack or front stabilizers for joined multiple racks before working on the rack.
- Always load the rack from the bottom up, and load the heaviest item in the rack first.
- Make sure that the rack is level and stable before extending a component from the rack.
- Use caution when pressing the component rail release latches and sliding a component into or out of a rack; the slide rails can pinch your fingers.
- After a component is inserted into the rack, carefully extend the rail into a locking position, and then slide the component into the rack.

- Do not overload the AC supply branch circuit that provides power to the rack. The total rack load should not exceed 80 percent of the branch circuit rating.
- Ensure that proper airflow is provided to components in the rack.
- Do not step on or stand on any component when servicing other components in a rack.



NOTE: A qualified electrician must perform all connections to DC power and to safety grounds. All electrical wiring must comply with applicable local or national codes and practices.



CAUTION: Never defeat the ground conductor or operate the equipment in the absence of a suitably installed ground conductor. Contact the appropriate electrical inspection authority or an electrician if you are uncertain that suitable grounding is available.



CAUTION: The system chassis must be positively grounded to the rack cabinet frame. Do not attempt to connect power to the system until grounding cables are connected. Completed power and safety ground wiring must be inspected by a qualified electrical inspector. An energy hazard will exist if the safety ground cable is omitted or disconnected.

Protecting Against Electrostatic Discharge

Static electricity can harm delicate components inside your system. To prevent static damage, discharge static electricity from your body before you touch any of the electronic components, such as the microprocessor. You can do so by periodically touching an unpainted metal surface on the chassis.

You can also take the following steps to prevent damage from electrostatic discharge (ESD):

1. When unpacking a static-sensitive component from its shipping carton, do not remove the component from the antistatic packing material until you are ready to install the component in your system. Just before unwrapping the antistatic packaging, be sure to discharge static electricity from your body.
2. When transporting a sensitive component, first place it in an antistatic container or packaging.
3. Handle all sensitive components in a static-safe area. If possible, use antistatic floor pads, workbench pads and an antistatic grounding strap.

<h1>Section 1</h1>

Introduction

Ethernet Technology

Switch Description

Features

Ports

Front-Panel Components

Side Panel Description

Rear Panel Description

Gigabit Combo Ports

Ethernet Technology

Fast Ethernet Technology

Switch Description

The DES-6500 is a modular, chassis-based Ethernet backbone switch designed for adaptability and scalability. This switch provides a management platform with a backplane switch capacity of 160 Gbps. The chassis contains slots for the DES-6502 CPU management module and up to eight modules that can provide up to 192 10/100 Mbps Fast Ethernet ports or up to 96 1000 Mbps Gigabit Ethernet ports. These modules can be hot-swapped, and the DES-6500 chassis allows the installation of a redundant power supply, for maximum flexibility and reliability. The DES-6511 redundant power supplies operate in a current-sharing mode with automatic fail-over to ensure constant operation of the Switch.

Features

- IEEE 802.3z compliant
- IEEE 802.3x Flow Control in full-duplex compliant
- IEEE 802.3u compliant
- IEEE 802.3ab compliant
- IEEE 802.1p Priority Queues
- IEEE 802.3ad Link Aggregation Control Protocol support.
- IEEE 802.1x Port-based and MAC-based Access Control
- IEEE 802.1Q VLAN
- IEEE 802.1D Spanning Tree, IEEE 802.1W Rapid Spanning Tree and IEEE 802.1s Multiple Spanning Tree support
- Access Control List (ACL) support
- IP Multinetting support
- Protocol VLAN support
- Single IP Management support
- Access Authentication Control utilizing TACACS, XTACACS, TACACS+ and RADIUS protocols
- Simple Network Time Protocol support
- System and Port Utilization support

- System Log Support
- High performance switching engine performs forwarding and filtering at full wire speed up to 160Gbps.
- Full- and half-duplex for all gigabit ports. Full duplex allows the switch port to simultaneously transmit and receive data. It only works with connections to full-duplex-capable end stations and switches. Connections to a hub must take place at half-duplex.
- Non-blocking store and forward switching scheme capability to support rate adaptation and protocol conversion
- Supports by-port Egress/Ingress rate control
- Efficient self-learning and address recognition mechanism enables forwarding rate at wire speed
- Support port-based enable and disable
- Address table: Supports up to 16K MAC addresses per device
- Supports Port-based VLAN Groups
- Port Trunking with flexible load distribution and fail-over function
- IGMP Snooping support
- Layer 3 support including DVMRP, OSPF and RIP
- SNMP support
- Secure Sockets Layer (SSL) and Secure Shell (SSH) support
- System Severity control
- Port Mirroring support
- MIB support for:
 - RFC1213 MIB II
 - RFC1493 Bridge
 - RFC1757 RMON
 - RFC1643 Ether-like MIB
 - RFC2233 Interface MIB
 - IF MIB
 - Private MIB
 - RFC2674 for 802.1p
 - IEEE 802.1x MIB
- RS-232 DCE console port for Switch management
- Provides parallel LED display for port status such as link/act, speed, etc.

DES-6500 chassis contains 9 slots to install the following available modules

- DES-6501 Backplane chassis
- DES-6502 Management Module
- DES-6506 Patch Panel for 24 port RJ45
- DES-6507 12-port 10BASE-T/100BASE-TX/1000BASE-T + Combo 2 SFP
- DES-6508 16-port 10/100M Base-T module
- DES-6509 12-port mini GBIC Fiber Module
- DES-6510 24-port 10/100M RJ21 Module
- DES-6504 12-port 100BASE-FX (SFF) Fast Ethernet Switch module
- DES-6505 8-port 1000Base-SX SC Fiber Module
- DES-6511 Power Supply Module
- DES-6512 2-port 10 GE XFP switch module

DES-6504 12 port 100BASE-FX (SFF) Fast Ethernet Switch module

- 12 100BASE-FX (SFF) Fast Ethernet ports
- Fully compliant with IEEE802.3u 100BASE-FX
- IEEE 802.3x compliant Flow Control support for Full-duplex

DES-6505 8-port 1000BASE-SX (SC) Gigabit Ethernet Switch module

- 8 1000BASE-SX (SC) Gigabit Ethernet ports
- Fully compliant with IEEE802.3z
- Support Full Duplex operations
- IEEE 802.3x compliant Flow Control support for full-duplex

DES-6507 12-port 10BASE-T/100BASE-TX/1000BASE-T Switch module

- 12 10BASE-T/100BASE-TX/1000BASE-T ports + Combo 2 SFP
- Fully compliant with IEEE802.3, IEEE802.3a, IEEE802.3u, IEEE802.3z
- All of 10/100/1000Mbps ports support auto-negotiation
- Back pressure Flow Control support for Half-duplex mode
- IEEE 802.3x compliant Flow Control support for Full-duplex

DES-6509 12-port Mini GBIC(SFP) switch module

- 12 Mini GBIC Gigabit Ethernet ports
- Support 1000BASE-SX/LX SFP module
- Fully compliant with IEEE802.3z
- Support Full Duplex operations
- IEEE 802.3x compliant Flow Control support for full-duplex

DES-6510 RJ21 connectors provide 24-port 10BASE-T/100BASE-TX Fast Ethernet Switch module

- 2 RJ21, each support 12-port 10BASE-T/100BASE-TX ports
- Fully compliant with IEEE802.3 10BASE-T, IEEE802.3u 100BASE-TX
- All of 10/100Mbps ports support auto-negotiation
- Back pressure Flow Control support for Half-duplex mode
- IEEE 802.3x compliant Flow Control support for Full-duplex

DES-6508 16-port 10BASE-T/100BASE-TX Fast Ethernet Switch module

- 16 10BASE-T/100BASE-TX ports
- Fully compliant with IEEE802.3 10BASE-T, IEEE802.3u 100BASE-TX
- All of 10/100Mbps ports support auto-negotiation
- Back pressure Flow Control support for Half-duplex mode
- IEEE 802.3x compliant Flow Control support for Full-duplex

DES-6506 Patch Panel

- A patch panel supporting 24 port RJ45 10/100M base-T Interfaces

DES-6511 Power Supply Modules

- Dual power modules design with current sharing design
- Full redundant feature design to ensure continuous operation
- If one power module failed, the other will take over all current supply automatically.
- Hot-swappable/Hot-pluggable capability
- Power management functions
- Input: 90 ~ 264 VAC, 47 ~ 63Hz
- Output: 3.3V: 4A ~ 80A
- 12V: 0.1A ~ 2A

DES-6512 2-port 10 GE XFP Switch Module

- Two 10G XFP Ethernet Ports
- Support XFP MSA compliant transceivers
- Fully compliant with IEEE 802.3ae
- Support Full Duplex Transmissions
- IEEE 802.3x compliant flow control support for full-duplex

Ethernet Technology

Fast Ethernet

The growing importance of LANs and the increasing complexity of desktop computing applications are fueling the need for high performance networks. A number of high-speed LAN technologies are proposed to provide greater bandwidth and improve client/server response times. Among them, Fast Ethernet, or 100BASE-T, provides a non-disruptive, smooth evolution from 10BASE-T technology.

100Mbps Fast Ethernet is a standard specified by the IEEE 802.3 LAN committee. It is an extension of the 10Mbps Ethernet standard with the ability to transmit and receive data at 100Mbps, while maintaining the Carrier Sense Multiple Access with Collision Detection (CSMA/CD) Ethernet protocol.

Gigabit Ethernet Technology

Gigabit Ethernet is an extension of IEEE 802.3 Ethernet utilizing the same packet structure, format, and support for CSMA/CD protocol, full duplex, flow control, and management objects, but with a tenfold increase in theoretical throughput over 100Mbps Fast Ethernet and a one hundred-fold increase over 10Mbps Ethernet. Since it is compatible with all 10Mbps and 100Mbps Ethernet environments, Gigabit Ethernet provides a straightforward upgrade without wasting a company's existing investment in hardware, software, and trained personnel.

The increased speed and extra bandwidth offered by Gigabit Ethernet are essential to coping with the network bottlenecks that frequently develop as computers and their buses get faster and more users use applications that generate more traffic. Upgrading key components, such as your backbone and servers to Gigabit Ethernet can greatly improve network response times as well as significantly speed up the traffic between your subnetworks.

Gigabit Ethernet enables fast optical-fiber connections to support video conferencing, complex imaging, and similar data-intensive applications. Likewise, since data transfers occur 10 times faster than Fast Ethernet, servers outfitted with Gigabit Ethernet NIC's are able to perform 10 times the number of operations in the same amount of time.

In addition, the phenomenal bandwidth delivered by Gigabit Ethernet is the most cost-effective method to take advantage of today's and tomorrow's rapidly improving switching and routing internetworking technologies.

Switching Technology

Another key development pushing the limits of Ethernet technology is in the field of switching technology. A switch bridges Ethernet packets at the MAC address level of the Ethernet protocol transmitting among connected Ethernet or Fast Ethernet LAN segments.

Switching is a cost-effective way of increasing the total network capacity available to users on a local area network. A switch increases capacity and decreases network loading by making it possible for a local area network to be divided into different segments, which are not competing with each other for network transmission capacity, and therefore decreasing the load on each segment.

The Switch acts as a high-speed selective bridge between the individual segments. Traffic that needs to go from one segment to another (from one port to another) is automatically forwarded by the Switch, without interfering with any other segments (ports). This allows the total network capacity to be multiplied, while still maintaining the same network cabling and adapter cards.

For Fast Ethernet or Gigabit Ethernet networks, a switch is an effective way of eliminating problems of chaining hubs beyond the "two-repeater limit." A switch can be used to split parts of the network into different collision domains, for example, making it possible to expand your Fast Ethernet network beyond the 205-meter network diameter limit for 100BASE-TX networks. Switches supporting both traditional 10Mbps Ethernet and 100Mbps Fast Ethernet are also ideal for bridging between existing 10Mbps networks and new 100Mbps networks.

Switching LAN technology is a marked improvement over the previous generation of network bridges, which were characterized by higher latencies. Routers have also been used to segment local area networks, but the cost of a router and the setup and maintenance required make routers relatively impractical. Today's switches are an ideal solution to most kinds of local area network congestion problems.



NOTE: For customers interested in D-View, D-Link Corporation's proprietary SNMP management software, go to the D-Link Website (www.dlink.com.cn) and download the software and manual.

Front-Panel Components and LED Indicators

The front panel of the Switch consists of LED indicators for Power, System, Reset and Alarm Off. Also on the front panel, there is a RS-232 communication port.



Figure 1- 1. DES-6500 Front Panel

Comprehensive LED indicators display the status of the Switch and the network.

LED or Button	Description
Power	This LED will light green after the Switch is powered on to indicate the normal operation of the Switch's power supplies. An amber LED will appear to indicate abnormal operation of one or more of the Switch's power supplies. The indicator is dark when the Switch is powered off.
System	This LED will light solid green to indicate normal operation. An amber LED will appear if the Switch begins acting abnormally. (Usually indicating a fatal error).
Reset	Press the button to reset the Switch.
Alarm Off	Press this button to deactivate the Switch's internal alarm. The internal alarm will sound if one of the Switch's redundant power supplies fail, or if the safe operating temperature of one or more of the line cards is exceeded.

SECTION 2

Installation

Package Contents***Before You Connect to the Network******Installing the Switch without the Rack******Rack Installation******Power On******The Optional Module******Redundant Power System***

Package Contents

Open the shipping carton of the Switch and carefully unpack its contents. The carton should contain the following items:

- One DES-6500 Chassis-based Switch
- Mounting kit (two brackets and screws)
- Four rubber feet with adhesive backing
- One AC power cord
- RS-232 console cable
- One CD Kit for User's Guide / CLI / D-View module / SNMP module
- This Manual with Registration Card.

If any item is found missing or damaged, please contact your local D-Link Reseller for replacement.

Before You Connect to the Network

The site where you install the Switch may greatly affect its performance. Please follow these guidelines for setting up the Switch.

- Install the Switch on a sturdy, level surface that can support the weight of the switch. Do not place heavy objects on the Switch.
- The power outlet should be within 1.82 meters (6 feet) of the Switch.
- Visually inspect the power cord and see that it is fully secured to the AC power port.
- Make sure that there is proper heat dissipation from and adequate ventilation around the Switch. Leave at least 10 cm (4 inches) of space at the front and rear of the Switch for ventilation.
- Install the Switch in a fairly cool and dry place for the acceptable temperature and humidity operating ranges.
- Install the Switch in a site free from strong electromagnetic field generators (such as motors), vibration, dust, and direct exposure to sunlight.
- When installing the Switch on a level surface, attach the rubber feet to the bottom of the device. The rubber feet cushion the Switch, protect the casing from scratches and prevent it from scratching other surfaces.

Installing the Switch without the Rack

When installing the Switch on a desktop or shelf, the rubber feet included with the Switch should first be attached. Attach these cushioning feet on the bottom at each corner of the device. Allow enough ventilation space between the Switch and any other objects in the vicinity.

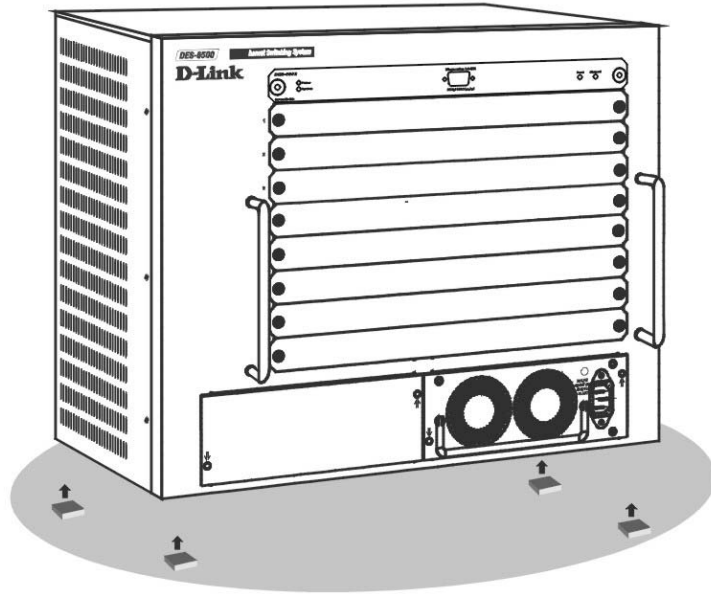

Figure 2- 1. Prepare Switch for installation on a desktop or shelf

Installing the Switch in a Rack

The Switch can be mounted in a standard 19" rack. Use the following diagrams to guide you.

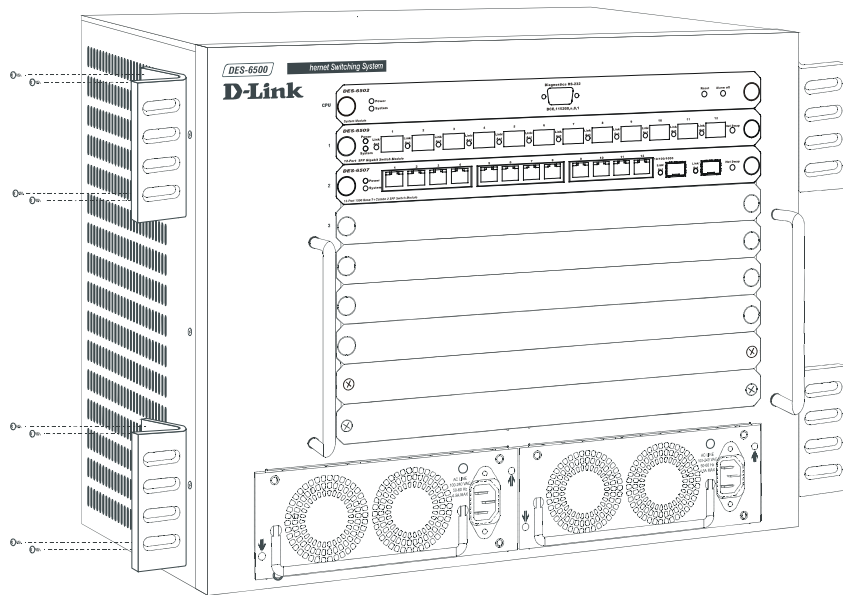

Figure 2- 2. Fasten mounting brackets to Switch

Fasten the mounting brackets to the Switch using the screws provided. With the brackets attached securely, you can mount the Switch in a standard rack as shown in Figure 2-3 on the following page.

Mounting the Switch in a Standard 19" Rack

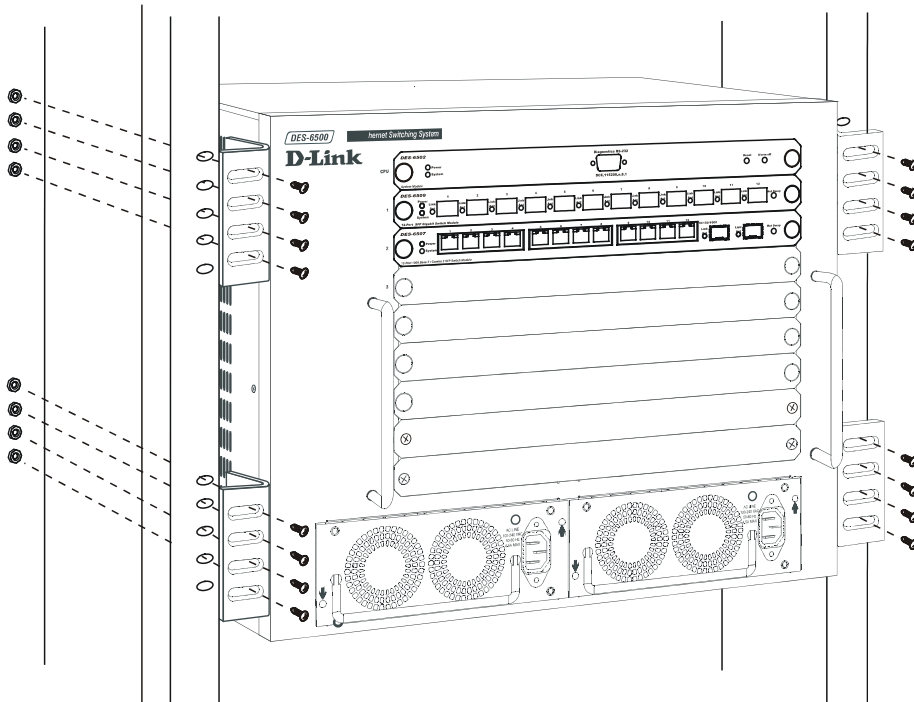

Figure 2- 3. Installing Switch in a rack

Power On

Plug one end of the AC power cord into the power connector of the Switch and the other end into the local power source outlet.

After the Switch is powered on, the LED indicators will momentarily blink. This blinking of the LED indicators represents a reset of the system.

Power Failure

As a precaution, in the event of a power failure, unplug the Switch. When power is resumed, plug the Switch back in.

External Redundant Power System

The Switch supports dual, current-sharing, redundant power supplies, located at the bottom front of the chassis.

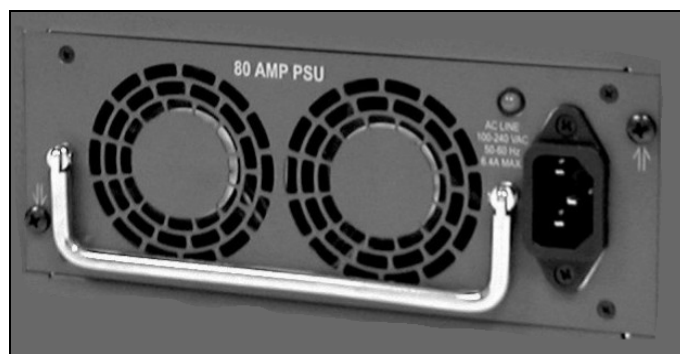

Figure 2- 4. Redundant Power Supply

Section 3

Connecting the Switch

Switch To End Node

Switch to Hub or Switch

Connecting To Network Backbone or Server



NOTE: All high-performance N-Way Ethernet ports can support both MDI-II and MDI-X connections.

Switch to End Node

End nodes include PCs outfitted with a 10, 100 or 1000 Mbps RJ 45 Ethernet Network Interface Card (NIC) and most routers.

An end node can be connected to the Switch via a twisted-pair UTP/STP cable. The end node should be connected to any of the 1000BASE-T ports of the Switch.

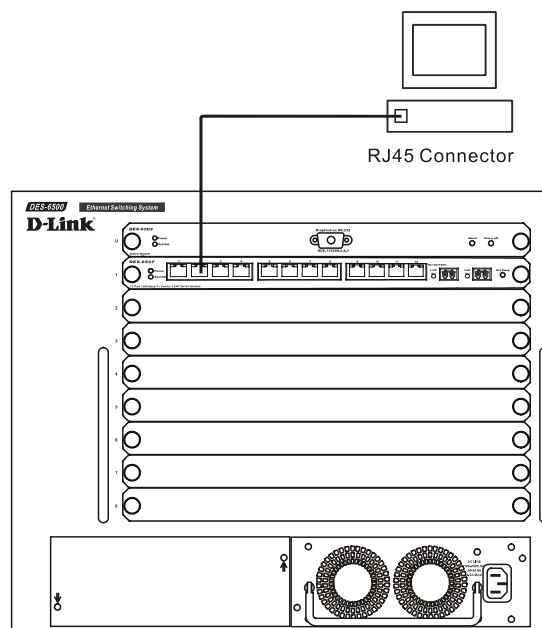

Figure 3- 1. Switch connected to an end node

The Link/Act LEDs for each UTP port will light green or amber when the link is valid. A blinking LED indicates packet activity on that port.

Switch to Hub or Switch

These connections can be accomplished in a number of ways using a normal cable.

- A 10BASE-T hub or switch can be connected to the Switch via a twisted-pair Category 3, 4 or 5 UTP/STP cable.
- A 100BASE-TX hub or switch can be connected to the Switch via a twisted-pair Category 5 UTP/STP cable.
- A 1000BASE-T switch can be connected to the Switch via a twisted pair Category 5e UTP/STP cable.
- A switch supporting a fiber-optic uplink can be connected to the Switch's SFP ports via fiber-optic cabling.

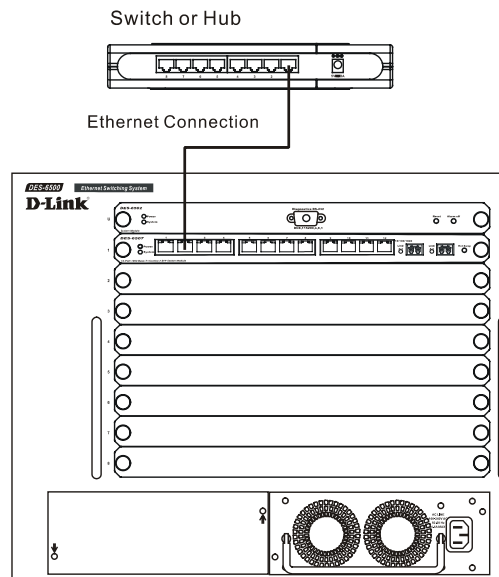

Figure 3- 2. Switch connected to a port on a hub or switch using a straight or crossover cable

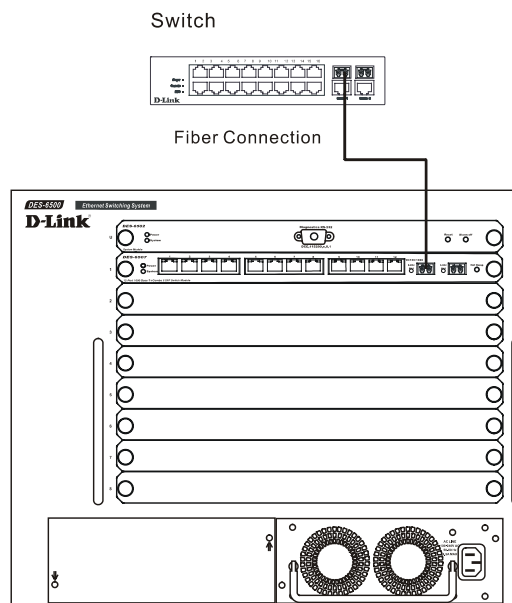

Figure 3- 3. Switch connected to switch using fiber-optic cabling

Using the DES-6500 as a Network Backbone

The DES-6500 can be employed as a network backbone for offices or buildings that require many Ethernet connections within a confined space. Once a high-speed line has been connected from the ISP, the DES-6500 can farm out up to 196 connections for various end nodes including PCs, printers, hubs, routers or other switches. The topology configurations are endless but be sure that connections coming from the DES-6500 are at a equal or slower speed than the ISP uplink to avoid bottlenecking.

The copper ports operate at a speed of 1000, 100 or 10Mbps in full or half duplex mode. The fiber-optic ports can operate at 1000Mbps in full duplex mode only.

Connections to the Gigabit Ethernet ports are made using a fiber-optic cable or Category 5e copper cable, depending on the type of port. A valid connection is indicated when the Link LED is lit.

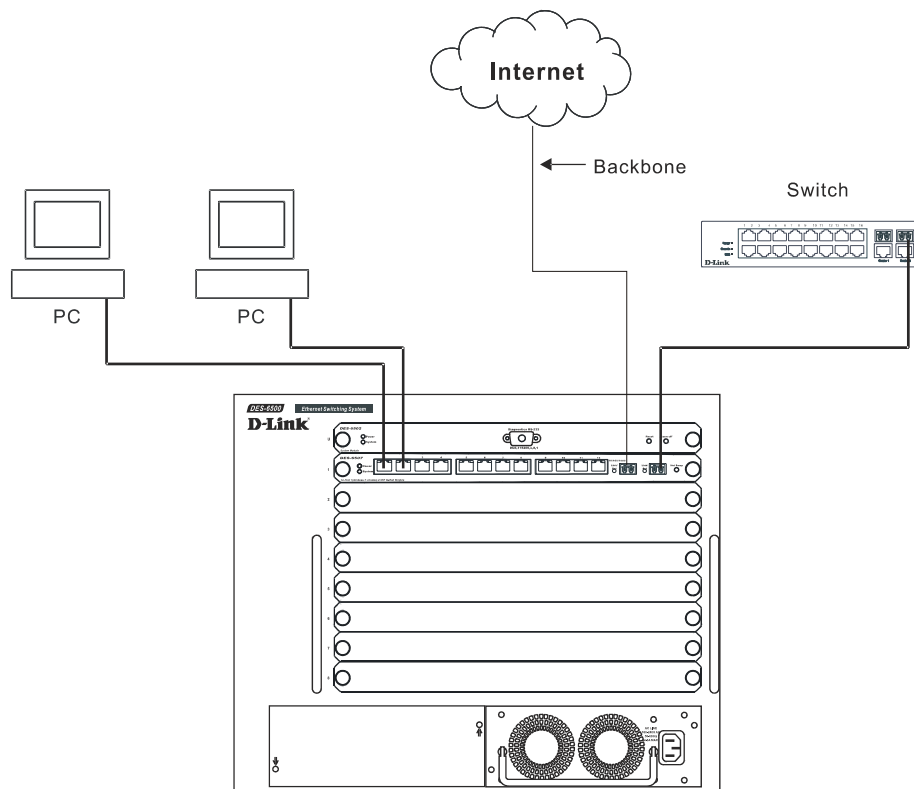

Figure 3- 4. Uplink Connection to a server, PC or switch stack.

Section 4

Introduction to Switch Management

Management Options

Web-based Management Interface

SNMP-Based Management

Managing User Accounts

Command Line Console Interface through the Serial Port

Connecting the Console Port (RS-232 DCE)

First Time Connecting to the Switch

Password Protection

SNMP Settings

IP Address Assignment

Connecting Devices to the Switch

Management Options

This system may be managed out-of-band through the console port on the front panel or in-band using Telnet. The user may also choose the web-based management, accessible through a web browser.

Web-based Management Interface

After you have successfully installed the Switch, you can configure the Switch, monitor the LED panel, and display statistics graphically using a web browser, such as Netscape Navigator (version 6.2 and higher) or Microsoft® Internet Explorer (version 5.0).

SNMP-Based Management

You can manage the Switch with an SNMP-compatible console program. The Switch supports SNMP version 1.0, version 2.0c and version 3.0. The SNMP agent decodes the incoming SNMP messages and responds to requests with MIB objects stored in the database. The SNMP agent updates the MIB objects to generate statistics and counters.

Command Line Console Interface through the Serial Port

You can also connect a computer or terminal to the serial console port to access the Switch. The command-line-driven interface provides complete access to all Switch management features.

Connecting the Console Port (RS-232 DCE)

The Switch provides an RS-232 serial port that enables a connection to a computer or terminal for monitoring and configuring the Switch. This port is a female DB-9 connector, implemented as a data terminal equipment (DTE) connection.

To use the console port, you need the following equipment:

- A terminal or a computer with both a serial port and the ability to emulate a terminal.
- A null modem or crossover RS-232 cable with a female DB-9 connector for the console port on the Switch.

To connect a terminal to the console port:

1. Connect the female connector of the RS-232 cable directly to the console port on the Switch, and tighten the captive retaining screws.
2. Connect the other end of the cable to a terminal or to the serial connector of a computer running terminal emulation software. Set the terminal emulation software as follows:
3. Select the appropriate serial port (COM port 1 or COM port 2).
4. Set the data rate to 115200 baud.
5. Set the data format to 8 data bits, 1 stop bit, and no parity.
6. Set flow control to none.
7. Under Properties, select VT100 for Emulation mode.
8. Select Terminal keys for Function, Arrow, and Ctrl keys. Ensure that you select Terminal keys (not Windows keys).



NOTE: When you use HyperTerminal with the Microsoft® Windows® 2000 operating system, ensure that you have Windows 2000 Service Pack 2 or later installed. Windows 2000 Service Pack 2 allows you to use arrow keys in HyperTerminal's VT100 emulation. See www.microsoft.com for information on Windows 2000 service packs.

9. After you have correctly set up the terminal, plug the power cable into the power receptacle on the back of the Switch. The boot sequence appears in the terminal.
10. After the boot sequence completes, the console login screen displays.
11. If you have not logged into the command line interface (CLI) program, press the Enter key at the User name and password prompts. There is no default user name and password for the Switch. User names and passwords must first be created by the administrator. If you have previously set up user accounts, log in and continue to configure the Switch.
12. Enter the commands to complete your desired tasks. Many commands require administrator-level access privileges. Read the next section for more information on setting up user accounts. See the *DES-6500 Command Line Interface Reference Manual* on the documentation CD for a list of all commands and additional information on using the CLI.
13. When you have completed your tasks, exit the session with the logout command or close the emulator program.

Make sure the terminal or PC you are using to make this connection is configured to match these settings.

If you are having problems making this connection on a PC, make sure the emulation is set to VT-100. You will be able to set the emulation by clicking on the **File** menu in your HyperTerminal window, clicking on **Properties** in the drop-down menu, and then clicking the **Settings** tab. This is where you will find the **Emulation** options. If you still do not see anything, try rebooting the Switch by disconnecting its power supply.

Once connected to the console, the screen below will appear on your console screen. This is where the user will enter commands to perform all the available management functions. The Switch will prompt the user to enter a user name and a password. Upon the initial connection, there is no user name or password and therefore just press enter twice to access the command line interface.

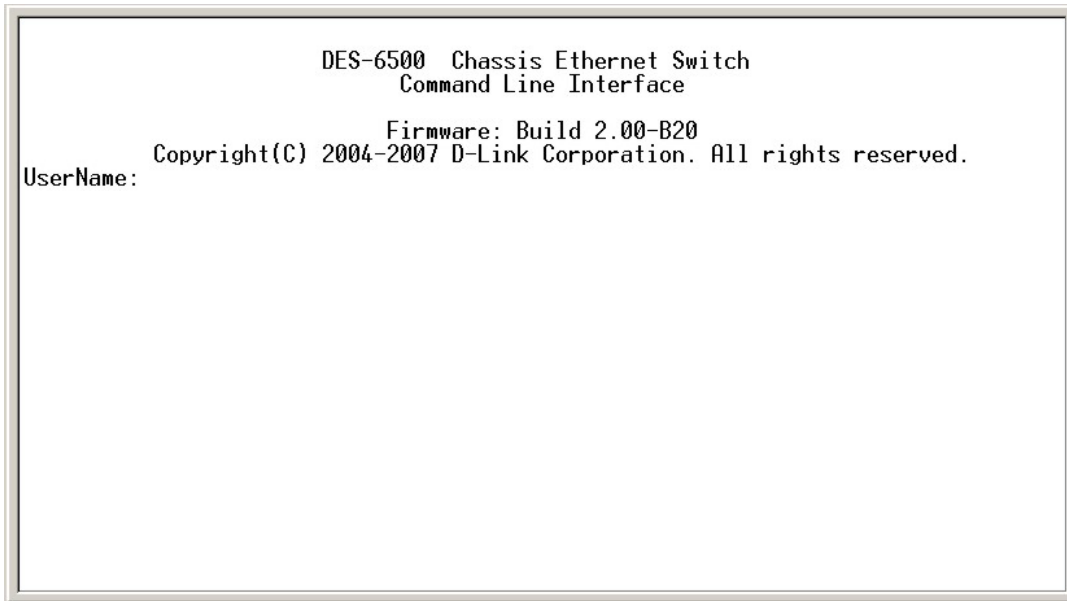

Figure 4- 1. Initial screen after first connection.

First Time Connecting to the Switch

The Switch supports user-based security that can allow you to prevent unauthorized users from accessing the Switch or changing its settings. This section tells how to log onto the Switch.



NOTE: The passwords used to access the Switch are case-sensitive; therefore, "S" is not the same as "s."

When you first connect to the Switch, you will be presented with the first login screen (shown below).



NOTE: Press Ctrl+R to refresh the screen. This command can be used at any time to force the console program in the Switch to refresh the console screen.

```
DES-6500 Chassis Ethernet Switch
Command Line Interface

Firmware: Build 2.00-B20
Copyright(C) 2004-2007 D-Link Corporation. All rights reserved.
UserName:
```

Figure 4- 2. Initial screen, first time connecting to the Switch

Press Enter in both the Username and Password fields. You will be given access to the command prompt **DES-6500:4#**, as shown below:

There is no initial username or password. Leave the **Username** and **Password** fields blank.

```
DES-6500 Chassis Ethernet Switch
Command Line Interface

Firmware: Build 2.00-B20
Copyright(C) 2004-2007 D-Link Corporation. All rights reserved.
UserName:
Password:
DES-6500:4#
```

Figure 4- 3. Command Prompt



NOTE: The first user automatically gets Administrator level privileges. It is recommended to create at least one Admin-level user account for the Switch.

Password Protection

The DES-6500 switch does not have a default user name and password. One of the first tasks when settings up the Switch is to create user accounts. If you log in using a predefined administrator-level user name, you have privileged access to the Switch's management software.

After your initial login, define new passwords for both default user names to prevent unauthorized access to the Switch, and record the passwords for future reference.

To create an administrator-level account for the Switch, do the following:

- At the CLI login prompt, enter create account admin followed by the *<user name>* and press the Enter key.
- You will be asked to provide a password. Type the *<password>* used for the administrator account being created and press the Enter key.
- You will be prompted to enter the same password again to verify it. Type the same password and press the Enter key.
- Successful creation of the new administrator account will be verified by a Success message.



NOTE: Passwords are case sensitive. User names and passwords can be up to 15 characters in length.

The sample below illustrates a successful creation of a new administrator-level account with the user name "newmanager".

```
DES-6500:4#create account admin newmanager
Command: create account admin newmanager

Enter a case-sensitive new password:*****
Enter the new password again for confirmation:*****

Success.

DES-6500:4#
```



NOTICE: CLI configuration commands only modify the running configuration file and are not saved when the Switch is rebooted. To save all your configuration changes in nonvolatile storage, you must use the **save** command to copy the running configuration file to the startup configuration.

SNMP Settings

Simple Network Management Protocol (SNMP) is an OSI Layer 7 (Application Layer) designed specifically for managing and monitoring network devices. SNMP enables network management stations to read and modify the settings of gateways, routers, switches, and other network devices. Use SNMP to configure system features for proper operation, monitor performance and detect potential problems in the Switch, switch group or network.

Managed devices that support SNMP include software (referred to as an agent), which runs locally on the device. A defined set of variables (managed objects) is maintained by the SNMP agent and used to manage the device. These objects are defined in a Management Information Base (MIB), which provides a standard presentation of the information controlled by the on-board SNMP agent. SNMP defines both the format of the MIB specifications and the protocol used to access this information over the network.

The DES-6500 switch supports SNMP versions 1, 2c, and 3. You can specify which version of SNMP you want to use to monitor and control the Switch. The three versions of SNMP vary in the level of security provided between the management station and the network device.

In SNMP v.1 and v.2c, user authentication is accomplished using 'community strings', which function like passwords. The remote user SNMP application and the Switch SNMP must use the same community string. SNMP packets from any station that has not been authenticated are ignored (dropped).

The default community strings for the Switch used for SNMP v.1 and v.2c management access are:

- public - Allows authorized management stations to retrieve MIB objects.
- private - Allows authorized management stations to retrieve and modify MIB objects.

SNMP v.3 uses a more sophisticated authentication process that is separated into two parts. The first part is to maintain a list of users and their attributes that are allowed to act as SNMP managers. The second part describes what each user on that list can do as an SNMP manager.

The Switch allows groups of users to be listed and configured with a shared set of privileges. The SNMP version may also be set for a listed group of SNMP managers. Thus, you may create a group of SNMP managers that are allowed to view read-only information or receive traps using SNMP v.1 while assigning a higher level of security to another group, granting read/write privileges using SNMP v.3.

Using SNMP v.3 individual users or groups of SNMP managers can be allowed to perform or be restricted from performing specific SNMP management functions. The functions allowed or restricted are defined using the Object Identifier (OID) associated with a specific MIB. An additional layer of security is available for SNMP v.3 in that SNMP messages may be encrypted. To read more about how to configure SNMP v.3 settings for the Switch read the section entitled Management.

Traps

Traps are messages that alert network personnel of events that occur on the Switch. The events can be as serious as a reboot (someone accidentally turned OFF the Switch), or less serious like a port status change. The Switch generates traps and sends them to the trap recipient (or network manager). Typical traps include trap messages for Authentication Failure, Topology Change and New Root.

MIBs

Management and counter information are stored by the Switch in the Management Information Base (MIB). The Switch uses the standard MIB-II Management Information Base module. Consequently, values for MIB objects can be retrieved from any SNMP-based network management software. In addition to the standard MIB-II, the Switch also supports its own proprietary enterprise MIB as an extended Management Information Base. The proprietary MIB may also be retrieved by specifying the MIB Object Identifier. MIB values can be either read-only or read-write.

IP Address Assignment

Each Switch must be assigned its own IP Address, which is used for communication with an SNMP network manager or other TCP/IP application (for example BOOTP, TFTP). The Switch's default IP address is 10.90.90.90. You can change the default Switch IP address to meet the specification of your networking address scheme.

The Switch is also assigned a unique MAC address by the factory. This MAC address cannot be changed, and can be found by entering the command "**show switch**" into the command line interface, as shown below.

```

Device Type      : DES-6500 Chassis Ethernet Switch
MAC Address      : 00-65-00-02-00-00
IP Address       : 10.53.13.65 (Manual)
VLAN Name        : default
Subnet Mask      : 255.0.0.0
Default Gateway  : 0.0.0.0
Boot PROM Version : Build 2.00-B20
Firmware Version : Build 2.00-B20
Hardware Version : 2A1
System Name      :
System Location  :
System Contact   :
Spanning Tree    : Disabled
GVRP             : Disabled
IGMP Snooping    : Disabled
802.1x          : Disabled
Jumbo Frame      : Off
Clipaging        : Enabled
Port Mirror      : Disabled
SNTP             : Disabled
Bootp Relay      : Disabled
DNSR Status      : Disabled
CTRL-C ESC  Quit  SPACE  Next Page  ENTER  Next Entry  All

```

Figure 4- 4. “show switch” command

The Switch's MAC address can also be found from the Web management program on the **Switch Information (Basic Settings)** window on the **Configuration** menu.

The IP address for the Switch must be set before it can be managed with the Web-based manager. The Switch IP address can be automatically set using BOOTP or DHCP protocols, in which case the actual address assigned to the Switch must be known.

The IP address may be set using the Command Line Interface (CLI) over the console serial port as follows:

Starting at the command line prompt, enter the commands **config ipif System ipaddress xxx.xxx.xxx.xxx/yyy.yyy.yyy.yyy**. Where the x's represent the IP address to be assigned to the IP interface named System and the y's represent the corresponding subnet mask.

Alternatively, you can enter **config ipif System ipaddress xxx.xxx.xxx.xxx/z**. Where the x's represent the IP address to be assigned to the IP interface named System and the z represents the corresponding number of subnets in CIDR notation.

The IP interface named System on the Switch can be assigned an IP address and subnet mask, which can then be used to connect a management station to the Switch's Telnet or Web-based management agent.

```

DES-6500 Chassis Ethernet Switch
Command Line Interface

Firmware: Build 2.00-B20
Copyright(C) 2004-2007 D-Link Corporation. All rights reserved.
UserName:
PassWord:

DES-6500:4#config ipif System ipaddress 10.53.13.144/255.0.0.0
Command: config ipif System ipaddress 10.53.13.144/8

Success.

DES-6500:4#

```

Figure 4- 5. Assigning the Switch an IP Address

In the above example, the Switch was assigned an IP address of 10.53.13.144 with a subnet mask of 255.0.0.0. The system message **Success** indicates that the command was executed successfully. The Switch can now be configured and managed via Telnet and the CLI or via the Web-based management.

Connecting Devices to the Switch

After you assign IP addresses to the Switch, you can connect devices to the Switch.

To connect a device to an SFP transceiver port:

- Use your cabling requirements to select an appropriate SFP transceiver type.
- Insert the SFP transceiver (sold separately) into the SFP transceiver slot.
- Use the appropriate network cabling to connect a device to the connectors on the SFP transceiver.



NOTICE: When the SFP transceiver acquires a link, the associated integrated 10/100/1000BASE-T port is disabled.

Section 5

Introduction to Web-based Switch Configuration

Introduction

Logging on to the Web Manager

Web-Based User Interface

Basic Setup

Reboot

Basic Switch Setup

Network Management

Switch Utilities

Network Monitoring

IGMP Snooping Status

Introduction

All software functions of the DES-6500 switch can be managed, configured and monitored via the embedded web-based (HTML) interface. The Switch can be managed from remote stations anywhere on the network through a standard browser such as Netscape Navigator/Communicator, Mozilla or Microsoft Internet Explorer. The browser acts as a universal access tool and can communicate directly with the Switch using the HTTP protocol.

The Web-based management module and the Console program (and Telnet) are different ways to access the same internal switching software and configure it. Thus, all settings encountered in web-based management are the same as those found in the console program.

Logging on to the Web Manager

To begin managing your Switch, simply run the browser you have installed on your computer and point it to the IP address you have defined for the device. The URL in the address bar should read something like: `http://123.123.123.123`, where the numbers 123 represent the IP address of the Switch.



NOTE: The Factory default IP address for the Switch is 10.90.90.90.

In the page that opens, click on the **Login** button:



Figure 5- 1. Login Button

This opens the management module's user authentication window, as seen below.



Figure 5- 2. Enter Network Password window

Leave both the **User Name** field and the **Password** field blank and click OK. This will open the Web-based user interface. The Switch management features available in the web-based manager are explained below.

Web-based User Interface

The user interface provides access to various Switch configuration and management screens, allows you to view performance statistics, and permits you to graphically monitor the system status.

Areas of the User Interface

The figure below shows the user interface. The user interface is divided into three distinct areas as described in the table.

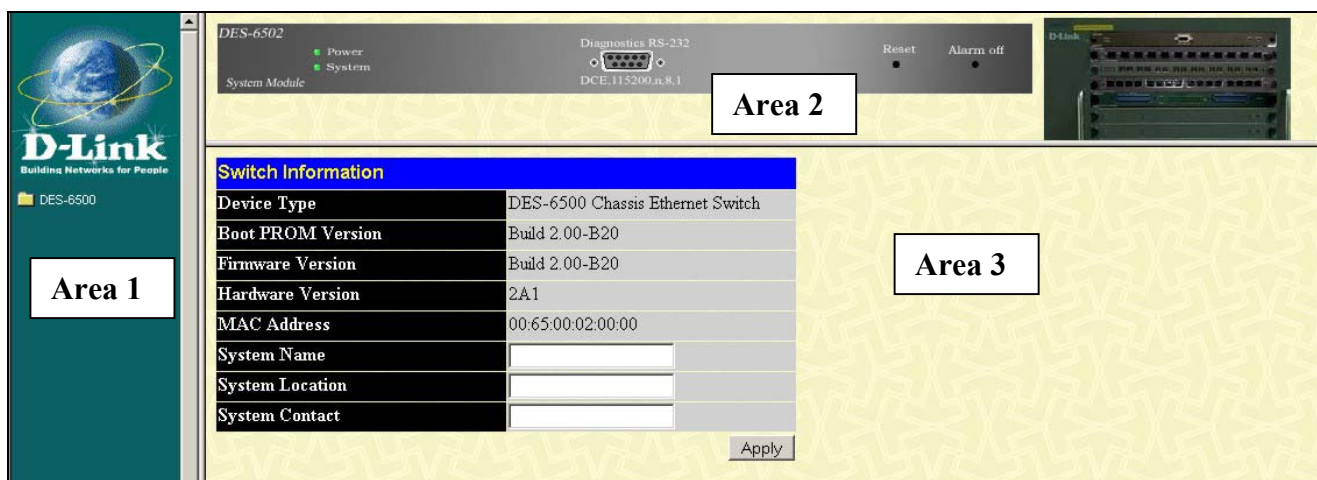

Figure 5- 3. Main Web-Manager Screen

Area	Function
Area 1	Select the menu or window to be displayed. The folder icons can be opened to display the hyperlinked menu buttons and subfolders contained within them. Click the D-Link logo to go to the D-Link website.
Area 2	<p>Presents a graphical near real-time image of the front panel of the Switch. This area displays the Switch's ports and expansion modules, showing port activity, duplex mode, or flow control, depending on the specified mode.</p> <p>Various areas of the graphic can be selected for performing management functions, including port configuration.</p>
Area 3	Presents switch information based on your selection and the entry of configuration data.



NOTICE: Any changes made to the Switch configuration during the current session must be saved in the Save Changes web menu (explained below) or by using the command line interface (CLI) command `save`.

Web Pages

When you connect to the management mode of the Switch with a web browser, a login screen is displayed. Enter a user name and password to access the Switch's management mode.

Below is a list and description of the main folders available in the web interface:

Configurations - Contains screens concerning configurations for IP Address, Switch Information, Advanced Settings, Port Configuration, Port Mirroring, IGMP, Spanning Tree, Forwarding Filtering, VLANs, Port Bandwidth, SNMP Settings, Port Security, QoS, LACP, Access Profile Table, CPU Interface Filtering, System Log Servers, PAE Access Entity, and Layer 3 IP Networking.

Security Management - Contains screens concerning configurations for Security IP, User Accounts, Access Authentication Control (TACACS), Secure Sockets Layer (SSL), and Secure Shell (SSH).

SNMP Manager – Contains screens and windows concerning the implementation and upkeep of the SNMP Manager of the Switch.

Monitoring - Contains screens concerning monitoring the Switch, pertaining to Port Utilization, CPU Utilization, Packets, Errors Size, MAC Address, IGMP Snooping Group, IGMP Snooping Forwarding, VLAN Status, Router Port, Port Access Control and Layer 3 Feature.

Maintenance - Contains screens concerning configurations and information about Switch maintenance, including TFTP Services, Switch History, Ping Test, Save Changes, Reboot Services and Logout.

Single IP Management - Contains screens concerning information on Single IP Management, including SIM Settings, Topology and Firmware/Configuration downloads.



NOTE: Be sure to configure the user name and password in the User Accounts menu before connecting the Switch to the greater network.

Section 6

Configuring the Switch

Switch Information

Switch IP Settings

Advanced Settings

Port Configuration

Port Mirroring Configuration

Link Aggregation

IGMP Snooping

Spanning Tree

Forward & Filtering

VLAN

Traffic Control

Port Security

Port Lock Entries

QoS

System Log Server

System Severity Log

SNTP Settings

Access Profile Table

CPU Interface Filtering

Port Access Entity

Layer 3 IP Networking

L3 Global Advanced Settings

IP Interface Table

MD5 Key Configuration

Route Redistribution Settings

Static Default Route

Static ARP Settings

RIP

OSPF

IP Multicast Routing Protocol

DNS Relay

DHCP/BOOTP Relay

VRRP

Switch Information

The subsections below describe how to change some of the basic settings for the Switch such as changing IP settings and assigning user names and passwords for management access privileges, as well as how to save the changes and restart the Switch.

Click the **Switch Information** link in the **Configuration** menu.

Switch Information	
Device Type	DES-6500 Chassis Ethernet Switch
Boot PROM Version	Build 2.00-B20
Firmware Version	Build 2.00-B20
Hardware Version	2A1
MAC Address	00:65:00:02:00:00
System Name	<input type="text"/>
System Location	<input type="text"/>
System Contact	<input type="text"/>
Apply	

Figure 6- 1. Switch Information - Basic Settings

The **Switch Information** window shows the Switch's **MAC Address** (assigned by the factory and unchangeable), the **Boot PROM**, **Firmware Version**, and **Hardware Version**. This information is helpful to keep track of PROM and firmware updates and to obtain the Switch's MAC address for entry into another network device's address table, if necessary. The user may also enter a **System Name**, **System Location** and **System Contact** to aid in defining the Switch, to the user's preference.



NOTE: Please check the firmware version of the CPU and line cards of the DES-6500 before upgrading to firmware release 2.50-B-09. For firmware upgrading information, cautions and procedures for release 2, please see Appendix B at the end of the manual.

Switch IP Settings

The IP Address may initially be set using the console interface prior to connecting to it through the Ethernet. If the Switch IP address has not yet been changed, read the introduction of the *DES-6500 Command Line Interface Reference Manual* or return to Section 4 of this manual for more information.

To change IP settings using the web manager you must access the IP Address menu located in the Configuration folder.

To configure the Switch's IP address:

Open the **Configuration** folder and click the **IP Address** menu link. The web manager will display the Switch's current IP settings in the IP configuration menu, as seen below.

Switch IP Settings	
Get IP From	Manual ▾
IP Address	10.53.13.65
Subnet Mask	255.0.0.0
Default Gateway	0.0.0.0
VLAN Name	default
Apply	

Figure 6- 2. IP Address Settings window

To manually assign the Switch's IP address, subnet mask, and default gateway address:

1. Select *Manual* from the **Get IP From** drop-down menu.
2. Enter the appropriate **IP Address** and **Subnet Mask**.
3. If you want to access the Switch from a different subnet from the one it is installed on, enter the IP address of the **Default Gateway**. If you will manage the Switch from the subnet on which it is installed, you can leave the default address (0.0.0.0) in this field.
4. If no VLANs have been previously configured on the Switch, you can use the *default VLAN Name*. The *default VLAN* contains all of the Switch ports as members. If VLANs have been previously configured on the Switch, you will need to enter the *VLAN ID* of the VLAN that contains the port connected to the management station that will access the Switch. The Switch will allow management access from stations with the same VID listed here.



NOTE: The Switch's factory default IP address is 10.90.90.90 with a subnet mask of 255.0.0.0 and a default gateway of 0.0.0.0.

To use the BOOTP or DHCP protocols to assign the Switch an IP address, subnet mask, and default gateway address:

Use the **Get IP From:** *<Manual>* pull-down menu to choose from *BOOTP* or *DHCP*. This selects how the Switch will be assigned an IP address on the next reboot.

The IP Address Settings options are:

Parameter	Description
BOOTP	The Switch will send out a BOOTP broadcast request when it is powered up. The BOOTP protocol allows IP addresses, network masks, and default gateways to be assigned by a central BOOTP server. If this option is set, the Switch will first look for a BOOTP server to provide it with this information before using the default or previously entered settings.
DHCP	The Switch will send out a DHCP broadcast request when it is powered up. The DHCP protocol allows IP addresses, network masks, and default gateways to be assigned by a DHCP server. If this option is set, the Switch will first look for a DHCP server to provide it with this information before using the default or previously entered settings.
Manual	Allows the entry of an IP address, Subnet Mask, and a Default Gateway for the Switch. These fields should be of the form xxx.xxx.xxx.xxx , where each xxx is a number (represented in decimal form) between 0 and 255. This address should be a unique address on the network assigned for use by the network administrator.
Subnet Mask	A Bitmask that determines the extent of the subnet that the Switch is on. Should be of the form xxx.xxx.xxx.xxx , where each xxx is a number (represented in decimal) between 0 and 255. The value should be 255.0.0.0 for a Class A network, 255.255.0.0 for a Class B network, and 255.255.255.0 for a Class C network, but custom subnet masks are allowed.

Default Gateway	IP address that determines where packets with a destination address outside the current subnet should be sent. This is usually the address of a router or a host acting as an IP gateway. If your network is not part of an intranet, or you do not want the Switch to be accessible outside your local network, you can leave this field unchanged.
VLAN Name	This allows the entry of a VLAN Name from which a management station will be allowed to manage the Switch using TCP/IP (in-band via web manager or Telnet). Management stations that are on VLANs other than the one entered here will not be able to manage the Switch in-band unless their IP addresses are entered in the Security IP Management menu. If VLANs have not yet been configured for the Switch, the default VLAN contains all of the Switch's ports. There are no entries in the Security IP Management table, by default, so any management station that can connect to the Switch can access the Switch until a management VLAN is specified or Management Station IP Addresses are assigned.

Click **Apply** to implement changes made.

Setting the Switch's IP Address using the Console Interface

Each Switch must be assigned its own IP Address, which is used for communication with an SNMP network manager or other TCP/IP application (for example BOOTP, TFTP). The Switch's default IP address is 10.90.90.90. You can change the default Switch IP address to meet the specification of your networking address scheme.

The IP address for the Switch must be set before it can be managed with the Web-based manager. The Switch IP address can be automatically set using BOOTP or DHCP protocols, in which case the actual address assigned to the Switch must be known. The IP address may be set using the Command Line Interface (CLI) over the console serial port as follows:

- Starting at the command line prompt, enter the commands **config ipif System ipaddress xxx.xxx.xxx.xxx/yyy.yyy.yyy.yyy**. Where the x's represent the IP address to be assigned to the IP interface named System and the y's represent the corresponding subnet mask.
- Alternatively, you can enter **config ipif System ipaddress xxx.xxx.xxx.xxx/z**. Where the x's represent the IP address to be assigned to the IP interface named System and the z represents the corresponding number of subnets in CIDR notation.

The IP interface named System on the Switch can be assigned an IP address and subnet mask, which can then be used to connect a management station to the Switch's Telnet or Web-based management agent.

The system message **Success** indicates that the command was executed successfully. The Switch can now be configured and managed via Telnet and the CLI or via the Web-based management agent using the above IP address to connect to the Switch.

Advanced Settings

The **Advanced Settings** window contains the main settings for all major functions for the Switch. To view the **Advanced Settings** window, click its link in the **Configuration** folder. This will enable the following window to be viewed and configured.

Advanced Settings	
Serial Port Auto Logout	Never
Serial Port Baud Rate	115200
MAC Address Aging Time (10-1000000)	300
IGMP Snooping	Disabled
Multicast Router Only	Disabled
GVRP Status	Disabled
Telnet Status	Enabled
Telnet Port Number (1-65535)	23
Web Status	Enabled
Web Port Number (1-65535)	80
RMON Status	Disabled
Link Aggregation Algorithm	IP Source
Switch 802.1x	Disabled
Auth Protocol	Radius Eap
HOL Prevention	Enabled
Jumbo Frame	Disabled
Syslog state	Disabled
Apply	

Figure 6- 3. Switch Information (Advanced Settings)

Parameter	Description
Serial Port Auto Logout Time	Select the logout time used for the console interface. This automatically logs the user out after an idle period of time, as defined. Choose from the following options: <i>2 Minutes, 5 Minutes, 10 Minutes, 15 Minutes</i> or <i>Never</i> . The default setting is <i>10 minutes</i> .
Serial Port Baud Rate	This field specifies the baud rate for the serial port on the Switch. This fields menu is set at 115200 and cannot be changed.
MAC Address Aging Time (10-1000000)	This field specifies the length of time a learned MAC Address will remain in the forwarding table without being accessed (that is, how long a learned MAC Address is allowed to remain idle). The default age-out time for the Switch is 300 seconds. To change this, type in a different value representing the MAC address age-out time in seconds. The MAC Address Aging Time can be set to any value between 10 and 1,000,000 seconds.

IGMP Snooping	To enable system-wide IGMP Snooping capability select <i>Enabled</i> . IGMP snooping is <i>Disabled</i> by default. Enabling IGMP snooping allows you to specify use of a multicast router only (see below). To configure IGMP Snooping for individual VLANs, use the IGMP Snooping page under the IGMP folder.
Multicast router Only	This field specifies that the Switch should only forward all multicast traffic to a multicast-enabled router, if enabled. Otherwise, the Switch will forward all multicast traffic to any IP router. The default is <i>Disabled</i> .
GVRP Status	Use this pull-down menu to enable or disable GVRP on the Switch.
Telnet Status	Telnet configuration is <i>Enabled</i> by default. If you do not want to allow configuration of the system through Telnet, choose <i>Disabled</i> .
Telnet TCP Port Number (1-65535)	The TCP port number. TCP ports are numbered between 1 and 65535. The "well-known" TCP port for the Web-interface protocol is 80.
Web Status	Web-based management is <i>Enabled</i> by default. If you choose to disable this by selecting <i>Disabled</i> , you will lose the ability to configure the system through the web interface as soon as these settings are applied.
RMON Status	Remote monitoring (RMON) of the Switch is <i>Enabled</i> or <i>Disabled</i> here.
Link Aggregation Algorithm	The algorithm that the Switch uses to balance the load across the ports that make up the port trunk group is defined by this definition. Choose <i>MAC Source</i> , <i>MAC Destination</i> , <i>MAC Src & Dest</i> , <i>IP Source</i> , <i>IP Destination</i> or <i>IP Src & Dest</i> (See the Link Aggregation section of this manual for more information).
Switch 802.1x	<p>The Switch's 802.1x function may be enabled by port or by MAC Address; the default is <i>Disabled</i>. This field must be enabled to view and configure certain windows for 802.1x. More information regarding 802.1x, its functions and implementation can be found later in this section, under the Port Access Entity folder.</p> <p>Port-Based 802.1x specifies that ports configured for 802.1x are initialized based on the port number only and are subject to any authorization parameters configured.</p> <p>MAC-based Authorization specifies that ports configured for 802.1x are initialized based on the port number and the MAC address of the computer being authorized and are then subject to any authorization parameters configured.</p>
Auth Protocol	The user may use the pull down menu to choose between <i>radius eap</i> and <i>radius pap</i> for the 802.1x authentication protocol on the Switch. The default setting is <i>radius eap</i> .
HOL Prevention	This field will enable or disable Head of Line Prevention on the Switch. The default is <i>Enabled</i> .
Jumbo Frame	This field will enable or disable the Jumbo Frame function on the Switch. The default is <i>Disabled</i> .
Syslog State	Enables or disables Syslog State; default is <i>Disabled</i> .

Click **Apply** to implement changes made.

Port Configuration

This section contains information for configuring various attributes and properties for individual physical ports, including port speed and address learning. Clicking on **Port Configurations** in the **Configuration** menu will display the following window for the user:

Port Configuration								
Unit	From	To	State	Speed/Duplex	Flow Control	Learning	Description	Apply
1	Port 1	Port 1	Enabled	100M/Full	Disabled	Enabled		Apply

The Port Information Table						
Port	State	Speed/Duplex	Flow Control	Connection	Learning	Description
1	Enabled	100M/Full	Disabled	Link Down	Enabled	
2	Enabled	100M/Full	Disabled	Link Down	Enabled	
3	Enabled	100M/Full	Disabled	Link Down	Enabled	
4	Enabled	100M/Full	Disabled	Link Down	Enabled	
5	Enabled	100M/Full	Disabled	Link Down	Enabled	
6	Enabled	100M/Full	Disabled	Link Down	Enabled	
7	Enabled	100M/Full	Disabled	Link Down	Enabled	
8	Enabled	100M/Full	Disabled	Link Down	Enabled	
9	Enabled	100M/Full	Disabled	Link Down	Enabled	
10	Enabled	100M/Full	Disabled	Link Down	Enabled	
11	Enabled	100M/Full	Disabled	Link Down	Enabled	
12	Enabled	100M/Full	Disabled	Link Down	Enabled	

Figure 6- 4. Port Configuration and The Port Information Table window

To configure switch ports:

1. Choose the port or sequential range of ports using the **From...To...** port pull-down menus, and the **Unit ID** of the Switch to be configured.
2. Use the remaining pull-down menus to configure the parameters described below:

Parameter	Description
State <Enabled>	Toggle the State <Enabled> field to either enable or disable a given port or group of ports.
Speed/Duplex <Auto>	<p>Toggle the Speed/Duplex field to either select the speed and duplex/half-duplex state of the port. <i>Auto</i> denotes auto-negotiation between 10 and 100 Mbps devices, in full- or half-duplex or 1000 Mbps in Full duplex only. The <i>Auto</i> setting allows the port to automatically determine the fastest settings the device the port is connected to can handle, and then to use those settings. The other options are <i>Auto</i>, <i>10M/Half</i>, <i>10M/Full</i>, <i>100M/Half</i> and <i>100M/Full</i>, <i>1000M/Full_M</i>, <i>1000M/Full_S</i> and <i>1000/Full_N</i>. There is no automatic adjustment of port settings with any option other than <i>Auto</i>.</p> <p>The Switch allows the user to configure two types of gigabit connections; <i>1000M/Full_M</i> and <i>1000M/Full_S</i>. Gigabit connections are only supported in full duplex connections and take on certain characteristics that are different from the other choices listed.</p> <p>The <i>1000M/Full_M</i> (master) and <i>1000M/Full_S</i> (slave) parameters refer to connections running a 1000BASE-T cable for connection between the Switch port and other device capable of a gigabit connection. The master setting (<i>1000M/Full_M</i>) will allow the port to advertise capabilities related to duplex,</p>

	<p>speed and physical layer type. The master setting will also determine the master and slave relationship between the two connected physical layers. This relationship is necessary for establishing the timing control between the two physical layers. The timing control is set on a master physical layer by a local source. The slave setting (<i>1000M/Full_S</i>) uses loop timing, where the timing comes from a data stream received from the master. If one connection is set for <i>1000M/Full_M</i>, the other side of the connection must be set for <i>1000M/Full_S</i>. Any other configuration will result in a link down status for both ports.</p> <p>Fiber optic ports are statically set and unchangeable at 1000Mbps in Full-Duplex. The user may configure these ports to be <i>Auto</i> or <i>1000Full_N</i>.</p>
Flow Control	<p>Displays the flow control scheme used for the various port configurations. Ports configured for full-duplex use 802.3x flow control, half-duplex ports use backpressure flow control, and <i>Auto</i> ports use an automatic selection of the two. The default is <i>Disabled</i>.</p>
Learning	<p>Enable or disable MAC address learning for the selected ports. When <i>Enabled</i>, destination and source MAC addresses are automatically listed in the forwarding table. When learning is <i>Disabled</i>, MAC addresses must be manually entered into the forwarding table. This is sometimes done for reasons of security or efficiency. See the section on Forwarding/Filtering for information on entering MAC addresses into the forwarding table. The default setting is <i>Enabled</i>.</p>
Description	<p>Enter a description of the port, if needed. This description can be no longer than 32 characters.</p>

Click **Apply** to implement the new settings on the Switch.

Port Mirroring Configuration

The Switch allows you to copy frames transmitted and received on a port and redirect the copies to another port. You can attach a monitoring device to the mirrored port, such as a sniffer or an RMON probe, to view details about the packets passing through the first port. This is useful for network monitoring and troubleshooting purposes. To view the **Port Mirroring** window, click **Port Mirroring** in the **Configuration** folder.

Port Mirroring Configuration

Target Port

Unit: Port:

Status

Source Port

Unit

Port Number	1	2	3	4	5	6	7	8	9	10	11	12	13	14	15	16	17	18	19	20	21	22	23	24
None	<input type="radio"/>	<input type="radio"/>	<input type="radio"/>	<input type="radio"/>	<input type="radio"/>	<input type="radio"/>	<input type="radio"/>	<input type="radio"/>	<input type="radio"/>	<input type="radio"/>	<input type="radio"/>	<input type="radio"/>	<input type="radio"/>	<input type="radio"/>	<input type="radio"/>	<input type="radio"/>	<input type="radio"/>	<input type="radio"/>	<input type="radio"/>	<input type="radio"/>	<input type="radio"/>	<input type="radio"/>	<input type="radio"/>	<input type="radio"/>
Ingress	<input type="radio"/>	<input type="radio"/>	<input type="radio"/>	<input type="radio"/>	<input type="radio"/>	<input type="radio"/>	<input type="radio"/>	<input type="radio"/>	<input type="radio"/>	<input type="radio"/>	<input type="radio"/>	<input type="radio"/>	<input type="radio"/>	<input type="radio"/>	<input type="radio"/>	<input type="radio"/>	<input type="radio"/>	<input type="radio"/>	<input type="radio"/>	<input type="radio"/>	<input type="radio"/>	<input type="radio"/>	<input type="radio"/>	<input type="radio"/>
Egress	<input type="radio"/>	<input type="radio"/>	<input type="radio"/>	<input type="radio"/>	<input type="radio"/>	<input type="radio"/>	<input type="radio"/>	<input type="radio"/>	<input type="radio"/>	<input type="radio"/>	<input type="radio"/>	<input type="radio"/>	<input type="radio"/>	<input type="radio"/>	<input type="radio"/>	<input type="radio"/>	<input type="radio"/>	<input type="radio"/>	<input type="radio"/>	<input type="radio"/>	<input type="radio"/>	<input type="radio"/>	<input type="radio"/>	<input type="radio"/>
Both	<input type="radio"/>	<input type="radio"/>	<input type="radio"/>	<input type="radio"/>	<input type="radio"/>	<input type="radio"/>	<input type="radio"/>	<input type="radio"/>	<input type="radio"/>	<input type="radio"/>	<input type="radio"/>	<input type="radio"/>	<input type="radio"/>	<input type="radio"/>	<input type="radio"/>	<input type="radio"/>	<input type="radio"/>	<input type="radio"/>	<input type="radio"/>	<input type="radio"/>	<input type="radio"/>	<input type="radio"/>	<input type="radio"/>	<input type="radio"/>

Note(1): The "Source Port" and "Target Port" should be different, or the setup will be invalid.

Note(2): The "Target Port" should be a non-trunked port.

Figure 6- 5. Port Mirroring window

To configure a mirror port:

- Select the **Source Port** from where you want to copy frames and the **Target Port**, which receives the copies from the source port.
- Select the **Source Direction**, **Ingress**, **Egress**, or **Both** and change the **Status** drop-down menu to *Enabled*.
- Click **Apply** to let the changes take effect.



NOTE: You cannot mirror a fast port onto a slower port. For example, if you try to mirror the traffic from a 100 Mbps port onto a 10 Mbps port, this can cause throughput problems. The port you are copying frames from should always support an equal or lower speed than the port to which you are sending the copies. Also, the target port for the mirroring cannot be a member of a trunk group. Please note a target port and a source port cannot be the same port.

Link Aggregation

Understanding Port Trunk Groups

Port trunk groups are used to combine a number of ports together to make a single high-bandwidth data pipeline.

The DES-6500 switch supports up to 32 port trunk groups with 2 to 8 ports in each group. A potential bit rate of 8000 Mbps can be achieved.

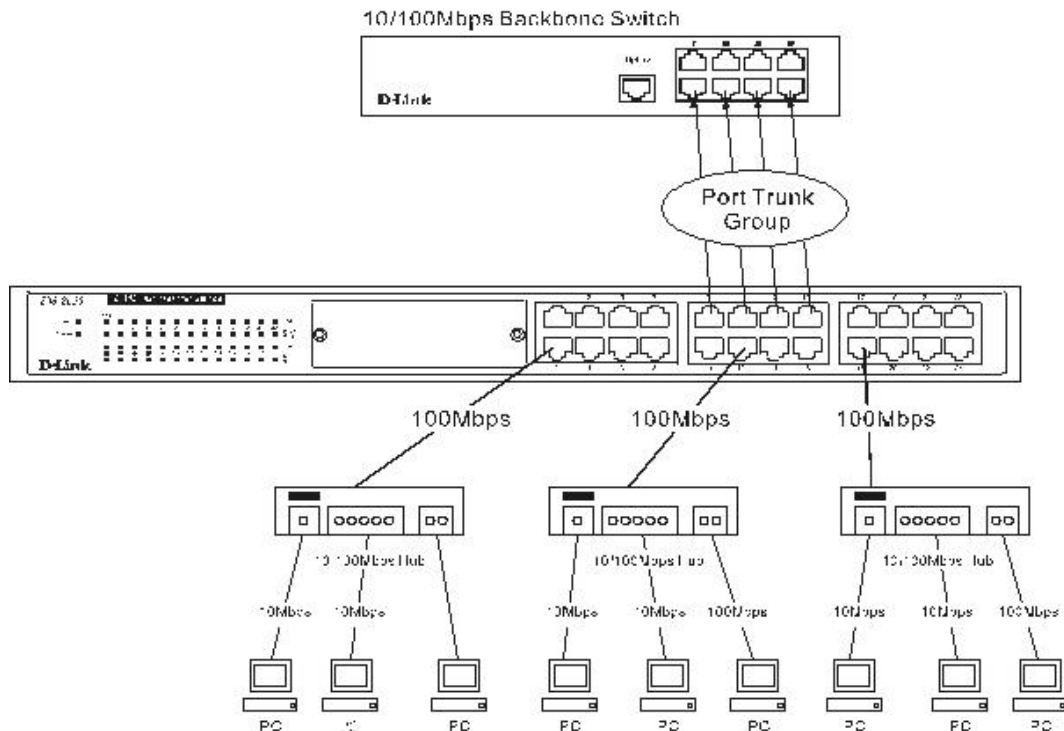

Figure 6- 6. Example of Port Trunk Group

The Switch treats all ports in a trunk group as a single port. Data transmitted to a specific host (destination address) will always be transmitted over the same port in a trunk group. This allows packets in a data stream to arrive in the same order they were sent.



NOTE: If any ports within the trunk group become disconnected, packets intended for the disconnected port will be load shared among the other uplinked ports of the link aggregation group.

Link aggregation allows several ports to be grouped together and to act as a single link. This gives a bandwidth that is a multiple of a single link's bandwidth.

Link aggregation is most commonly used to link a bandwidth intensive network device or devices, such as a server, to the backbone of a network.

The Switch allows the creation of up to 32 link aggregation groups, each group consisting of 2 to 8 links (ports). All of the ports in the group must be members of the same VLAN, and their STP status, static multicast, traffic control, traffic segmentation and 802.1p default priority configurations must be identical. Port locking, port mirroring and 802.1X must not be enabled on the trunk group. Further, the aggregated links must all be of the same speed and should be configured as full-duplex.

The Master Port of the group is to be configured by the user, and all configuration options, including the VLAN configuration that can be applied to the Master Port, are applied to the entire link aggregation group.

Load balancing is automatically applied to the ports in the aggregated group, and a link failure within the group causes the network traffic to be directed to the remaining links in the group.

The Spanning Tree Protocol will treat a link aggregation group as a single link, on the switch level. On the port level, the STP will use the port parameters of the Master Port in the calculation of port cost and in determining the state of the link aggregation group. If two redundant link aggregation groups are configured on the Switch, STP will block one entire group, in the same way STP will block a single port that has a redundant link.

To configure port trunking, open the **Link Aggregation** folder and click on the **Link Aggregation Configuration** hyperlink in the **Configuration** folder to bring up the **Link Aggregation Group Entries** table:

Current Link Aggregation Group Entries			
Group ID	State	Type	Delete
1	Enabled	LACP	<input type="checkbox"/>

Figure 6- 7. Port Link Aggregation Group Entries window

To configure port trunk groups, click the **Add** button to add a new trunk group and use the **Link Aggregation Settings** menu (see example below) to set up trunk groups. To modify a port trunk group, click the hyperlinked group number corresponding to the entry you wish to alter. To delete a port trunk group, click the corresponding under the **Delete** heading in the **Current Link Aggregation Group Entries** table.

Link Aggregation Group Configuration																									
Group ID	<input type="text"/>																								
Type	LACP ▾																								
State	Disabled ▾																								
Master Port	1 ▾ Port 1 ▾																								
Unit	1 ▾																								
Choose Member Ports	1	2	3	4	5	6	7	8	9	10	11	12	13	14	15	16	17	18	19	20	21	22	23	24	
	<input type="checkbox"/>	<input type="checkbox"/>	<input type="checkbox"/>	<input type="checkbox"/>	<input type="checkbox"/>	<input type="checkbox"/>	<input type="checkbox"/>	<input type="checkbox"/>	<input type="checkbox"/>	<input type="checkbox"/>	<input type="checkbox"/>	<input type="checkbox"/>	<input type="checkbox"/>	<input type="checkbox"/>	<input type="checkbox"/>	<input type="checkbox"/>	<input type="checkbox"/>	<input type="checkbox"/>	<input type="checkbox"/>	<input type="checkbox"/>	<input type="checkbox"/>	<input type="checkbox"/>	<input type="checkbox"/>	<input type="checkbox"/>	<input type="checkbox"/>
Active Ports																									
Flooding Port	<input checked="" type="checkbox"/>																								
<input type="button" value="Apply"/>																									
<p>Note(1): It is only valid to set up at most 8 member ports of any one trunk group and a port can be a member of only one trunk group at a time.</p> <p>Show All Link Aggregation Group Entries</p>																									

Figure 6- 8. Link Aggregation Group Configuration window – Add

Link Aggregation Group Configuration																								
Group ID	1																							
Type	LACP																							
State	Enabled																							
Master Port	1	Port 1																						
Unit	1																							
Choose Member Ports	1	2	3	4	5	6	7	8	9	10	11	12	13	14	15	16	17	18	19	20	21	22	23	24
	<input checked="" type="checkbox"/>	<input checked="" type="checkbox"/>	<input checked="" type="checkbox"/>	<input type="checkbox"/>	<input type="checkbox"/>	<input type="checkbox"/>	<input type="checkbox"/>	<input type="checkbox"/>	<input type="checkbox"/>	<input type="checkbox"/>	<input type="checkbox"/>	<input type="checkbox"/>	<input type="checkbox"/>	<input type="checkbox"/>	<input type="checkbox"/>	<input type="checkbox"/>	<input type="checkbox"/>	<input type="checkbox"/>	<input type="checkbox"/>	<input type="checkbox"/>	<input type="checkbox"/>	<input type="checkbox"/>	<input type="checkbox"/>	<input type="checkbox"/>
Active Ports																								
Flooding Port	X																							
<input type="button" value="Apply"/>																								
<p>Note(1): It is only valid to set up at most 8 member ports of any one trunk group and a port can be a member of only one trunk group at a time.</p> <p>Show All Link Aggregation Group Entries</p>																								

Figure 6- 9. Link Aggregation Group Configuration window - Modify

The user-changeable parameters are as follows:

Parameter	Description
Group ID	Select an ID number for the group, between 1 and 32.
Type	This pull-down menu allows you to select between <i>Static</i> and <i>LACP</i> (Link Aggregation Control Protocol). LACP allows for the automatic detection of links in a Port Trunking Group.
State	Trunk groups can be toggled between <i>Enabled</i> and <i>Disabled</i> . This is used to turn a port trunking group on or off. This is useful for diagnostics, to quickly isolate a bandwidth intensive network device or to have an absolute backup aggregation group that is not under automatic control.
Master Port	Choose the Master Port for the trunk group using the pull down menu.
Unit	Choose the unit of the switch in the chassis to be configured.
Choose Member Ports	Choose the members of a trunked group. 2 to 8 ports can be assigned to an individual group.
Active Port	Shows the port that is currently forwarding packets.
Flooding Port	A trunking group must designate one port to allow transmission of broadcasts and unknown unicasts.

After setting the previous parameters, click **Apply** to allow your changes to be implemented. Successfully created trunk groups will be show in the **Current Link Aggregation Group Entries**.

LACP Port Settings

The **LACP Port Settings** window is used in conjunction with the **Link Aggregation** window to create port trunking groups on the Switch. Using the following window, the user may set which ports will be active and passive in processing and sending LACP control frames.

LACP Settings				
Unit	From	To	Mode	Apply
1	Port 1	Port 1	Passive	Apply
Port LACP Table				
Port	Activity			
1	Passive			
2	Passive			
3	Passive			
4	Passive			
5	Passive			
6	Passive			
7	Passive			
8	Passive			
9	Passive			
10	Passive			
11	Passive			
12	Passive			

Figure 6- 10. LACP Port Setting and LACP Port Information window

The user may set the following parameters:

Parameter	Description
Unit	Choose the switch in the switch stack to be configured by using the pull-down menu.
From/To	A consecutive group of ports may be configured starting with the selected port.
Mode	<p><i>Active</i> - Active LACP ports are capable of processing and sending LACP control frames. This allows LACP compliant devices to negotiate the aggregated link so the group may be changed dynamically as needs require. In order to utilize the ability to change an aggregated port group, that is, to add or subtract ports from the group, at least one of the participating devices must designate LACP ports as active. Both devices must support LACP.</p> <p><i>Passive</i> - LACP ports that are designated as passive cannot initially send LACP control frames. In order to allow the linked port group to negotiate adjustments and make changes dynamically, one end of the connection must have "active" LACP ports (see above).</p>

After setting the previous parameters, click **Apply** to allow your changes to be implemented. The **LACP Port Table** shows which ports are active and/or passive.

IGMP Snooping

Internet Group Management Protocol (IGMP) snooping allows the Switch to recognize IGMP queries and reports sent between network stations or devices and an IGMP host. When enabled for IGMP snooping, the Switch can open or close a port to a specific device based on IGMP messages passing through the Switch.

In order to use IGMP Snooping it must first be enabled for the entire Switch (see **Advanced Settings**). You may then fine-tune the settings for each VLAN using the **IGMP Snooping** link in the **Configuration** folder. When enabled for IGMP snooping, the Switch can open or close a port to a specific Multicast group member based on IGMP messages sent from the device to the IGMP host or vice versa. The Switch monitors IGMP messages and discontinues forwarding multicast packets when there are no longer hosts requesting that they continue. Use the **IGMP Snooping Group Entry Table** to view IGMP Snooping status. To modify settings, click the **Modify** button for the VLAN Name entry you want to change.

Use the **IGMP Snooping Settings** window to view **IGMP Snooping** settings. To modify the settings, click the **Modify** button of the VLAN ID you want to change.

Total Entries : 1				
IGMP Snooping Settings				
VLAN ID	VLAN Name	State	Querier State	Modify
1	default	Disabled	Disabled	<input type="button" value="Modify"/>

Figure 6- 11. Current IGMP Snooping Group Entries

Clicking the **Modify** button will open the **IGMP Snooping Settings** menu, shown below:

IGMP Snooping Settings	
VLAN ID	<input type="text" value="1"/>
VLAN Name	<input type="text" value="default"/>
Query Interval (1-65535)	<input type="text" value="125"/>
Max Response Time (1-25)	<input type="text" value="10"/>
Robustness Value (1-255)	<input type="text" value="2"/>
Last Member Query Interval (1-25)	<input type="text" value="1"/>
Host Timeout (1-16711450)	<input type="text" value="260"/>
Router Timeout (1-16711450)	<input type="text" value="260"/>
Leave Timer (1-16711450)	<input type="text" value="2"/>
Querier State	<input type="text" value="Disabled"/>
Querier Router Behavior	Non-Querier
State	<input type="text" value="Disabled"/>
<input type="button" value="Apply"/>	
Show All IGMP Group Entries	

Figure 6- 12. IGMP Snooping Settings-Edit window

The following parameters may be viewed or modified:

Parameter	Description
VLAN ID	This is the VLAN ID that, along with the VLAN Name , identifies the VLAN for which to modify the IGMP Snooping Settings .
VLAN Name	This is the VLAN Name that, along with the VLAN ID , identifies the VLAN for which to modify the IGMP Snooping Settings .
Query Interval	The Query Interval field is used to set the time (in seconds) between transmitting IGMP queries. Entries between 1 and 65535 seconds are allowed. Default = 125.
Max Response Time	This determines the maximum amount of time in seconds allowed before sending an IGMP response report. The Max Response Time field allows an entry between 1 and 25 (seconds). Default = 10.
Robustness Value	Adjust this variable according to expected packet loss. If packet loss on the VLAN is expected to be high, the Robustness Variable should be increased to accommodate increased packet loss. This entry field allows an entry of 1 to 255. Default = 2.
Last Member Query Interval	This field specifies the maximum amount of time between group-specific query messages, including those sent in response to leave group messages. Default = 1.
Host Timeout	This is the maximum amount of time in seconds allowed for a host to continue membership in a multicast group without the Switch receiving a host membership report. Default = 260.
Router Timeout	This is the maximum amount of time in seconds a route is kept in the forwarding table without receiving a membership report. Default = 260.
Leave Timer	This specifies the maximum amount of time in seconds between the Switch receiving a leave group message from a host, and the Switch issuing a group membership query. If no response to the membership query is received before the Leave Timer expires, the (multicast) forwarding entry for that host is deleted.
Querier State	Choose <i>Enabled</i> to enable transmitting IGMP Query packets or <i>Disabled</i> to disable. The default is <i>Disabled</i> .
Querier Router Behavior	This read-only field describes the behavior of the router for sending query packets. <i>Querier</i> will denote that the router is sending out IGMP query packets. <i>Non-Querier</i> will denote that the router is not sending out IGMP query packets. This field will only read <i>Querier</i> when the Querier State and the State fields have been Enabled.
State	Select <i>Enabled</i> to implement IGMP Snooping. This field is <i>Disabled</i> by default.

Click **Apply** to implement the new settings. Click the [Show All IGMP Snooping Entries](#) link to return to the **Current IGMP Snooping Group Entries** window.

Static Router Ports

A static router port is a port that has a multicast router attached to it. Generally, this router would have a connection to a WAN or to the Internet. Establishing a router port will allow multicast packets coming from the router to be propagated through the network, as well as allowing multicast messages (IGMP) coming from the network to be propagated to the router.

A router port has the following behavior:

- All IGMP Report packets will be forwarded to the router port.
- IGMP queries (from the router port) will be flooded to all ports.

- All UDP multicast packets will be forwarded to the router port. Because routers do not send IGMP reports or implement IGMP snooping, a multicast router connected to the router port of a Layer 3 switch would not be able to receive UDP data streams unless the UDP multicast packets were all forwarded to the router port.

A router port will be dynamically configured when IGMP query packets, RIPv2 multicast, DVMRP multicast or PIM-DM multicast packets are detected flowing into a port.

Open the **IGMP Snooping** folder and then click on the **Static Router Ports Settings** link to open the **Current Static Router Ports Entries** page, as shown below.

Static Router Port Settings		
VLAN ID	VLAN Name	Modify
1	default	Modify
2	v2	Modify
4094	v4094	Modify

Figure 6- 13. Static Router Ports Settings window

The **Static Router Ports Settings** page (shown above) displays all of the current entries to the Switch's static router port table. To modify an entry, click the **Modify** button. This will open the **Static Router Ports Settings - Edit** page, as shown below.

Static Router Ports Settings																									
VID	1																								
VLAN Name	default																								
Unit	1																								
Port Settings	1	2	3	4	5	6	7	8	9	10	11	12	13	14	15	16	17	18	19	20	21	22	23	24	
Static	<input type="checkbox"/>	<input type="checkbox"/>	<input type="checkbox"/>	<input type="checkbox"/>	<input type="checkbox"/>	<input type="checkbox"/>	<input type="checkbox"/>	<input type="checkbox"/>	<input type="checkbox"/>	<input type="checkbox"/>	<input type="checkbox"/>	<input type="checkbox"/>	<input type="checkbox"/>	<input type="checkbox"/>	<input type="checkbox"/>	<input type="checkbox"/>	<input type="checkbox"/>	<input type="checkbox"/>	<input type="checkbox"/>	<input type="checkbox"/>	<input type="checkbox"/>	<input type="checkbox"/>	<input type="checkbox"/>	<input type="checkbox"/>	<input type="checkbox"/>
Forbidden	<input type="checkbox"/>	<input type="checkbox"/>	<input type="checkbox"/>	<input type="checkbox"/>	<input type="checkbox"/>	<input type="checkbox"/>	<input type="checkbox"/>	<input type="checkbox"/>	<input type="checkbox"/>	<input type="checkbox"/>	<input type="checkbox"/>	<input type="checkbox"/>	<input type="checkbox"/>	<input type="checkbox"/>	<input type="checkbox"/>	<input type="checkbox"/>	<input type="checkbox"/>	<input type="checkbox"/>	<input type="checkbox"/>	<input type="checkbox"/>	<input type="checkbox"/>	<input type="checkbox"/>	<input type="checkbox"/>	<input type="checkbox"/>	<input type="checkbox"/>
Apply																									
Show All Static Router Ports Entries																									

Figure 6- 14. Static Router Ports Settings - Edit window

The following parameters can be set:

Parameter	Description
VID (VLAN ID)	This is the VLAN ID that, along with the VLAN Name, identifies the VLAN where the multicast router is attached.
VLAN Name	This is the name of the VLAN where the multicast router is attached.
Unit	Choose the Switch ID number of the slot in the chassis to be modified.
Port Settings	These are the ports on the Switch that will have a multicast router attached to them. Static – Choose these ports to be connected to a multicast enabled router. Forbidden – Choose these ports to be forbidden from being connected to a multicast enabled router.

Click **Apply** to implement the new settings, Click the [Show All Static Router Port Entries](#) link to return to the **Current Static Router Port Entries** window.

Spanning Tree

This Switch supports three versions of the Spanning Tree Protocol; 802.1d STP, 802.1w Rapid STP and 802.1s MSTP. 802.1d STP will be familiar to most networking professionals. However, since 802.1w RSTP and 802.1s MSTP has been recently introduced to D-Link managed Ethernet switches, a brief introduction to the technology is provided below followed by a description of how to set up 802.1d STP, 802.1w RSTP and 802.1s MSTP.

802.1s MSTP

Multiple Spanning Tree Protocol, or MSTP, is a standard defined by the IEEE community that allows multiple VLANs to be mapped to a single spanning tree instance, which will provide multiple pathways across the network. Therefore, these MSTP configurations will balance the traffic load, preventing wide scale disruptions when a single spanning tree instance fails. This will allow for faster convergences of new topologies for the failed instance. Frames designated for these VLANs will be processed quickly and completely throughout interconnected bridges utilizing either of the three spanning tree protocols (STP, RSTP or MSTP).

This protocol will also tag BPDU packets so receiving devices can distinguish spanning tree instances, spanning tree regions and the VLANs associated with them. These instances will be classified by an MSTI ID. MSTP will connect multiple spanning trees with a Common and Internal Spanning Tree (CIST). The CIST will automatically determine each MSTP region, its maximum possible extent and will appear as one virtual bridge that runs a single spanning tree. Consequentially, frames assigned to different VLANs will follow different data routes within administratively established regions on the network, continuing to allow simple and full processing of frames, regardless of administrative errors in defining VLANs and their respective spanning trees.

Each switch utilizing the MSTP on a network will have a single MSTP configuration that will have the following three attributes:

1. A configuration name defined by an alphanumeric string of up to 32 characters (defined in the **STP Bridge Global Settings** window in the **Configuration Name** field).
2. A configuration revision number (named here as a **Revision Level** and found in the **STP Bridge Global Settings** window) and;
3. A 4096 element table (defined here as a **VID List** in the **MST Configuration Table** window) which will associate each of the possible 4096 VLANs supported by the Switch for a given instance.

To utilize the MSTP function on the Switch, three steps need to be taken:

1. The Switch must be set to the MSTP setting (found in the **STP Bridge Global Settings** window in the **STP Version** field)
2. The correct spanning tree priority for the MSTP instance must be entered (defined here as a **Priority** in the **MST Configuration Table** window when configuring an **MSTI ID** settings).
3. VLANs that will be shared must be added to the **MSTP Instance ID** (defined here as a **VID List** in the **MST Configuration Table** window when configuring an **MSTI ID** settings).

802.1w Rapid Spanning Tree

The Switch implements three versions of the Spanning Tree Protocol, the Multiple Spanning Tree Protocol (MSTP) as defined by the IEEE 802.1s, the Rapid Spanning Tree Protocol (RSTP) as defined by the IEEE 802.1w specification and a version compatible with the IEEE 802.1d STP. RSTP can operate with legacy equipment implementing IEEE 802.1d, however the advantages of using RSTP will be lost.

The IEEE 802.1w Rapid Spanning Tree Protocol (RSTP) evolved from the 802.1d STP standard. RSTP was developed in order to overcome some limitations of STP that impede the function of some recent switching innovations, in particular, certain Layer 3 functions that are increasingly handled by Ethernet switches. The basic function and much of the terminology is the same as STP. Most of the settings configured for STP are also used for RSTP. This section introduces some new Spanning Tree concepts and illustrates the main differences between the two protocols.

Port Transition States

An essential difference between the three protocols is in the way ports transition to a forwarding state and in the way this transition relates to the role of the port (forwarding or not forwarding) in the topology. MSTP and RSTP combine the transition states disabled, blocking and listening used in 802.1d and creates a single state Discarding. In either case, ports do not forward packets. In the STP port transition states disabled, blocking or listening or in the RSTP/MSTP port state

discarding, there is no functional difference, the port is not active in the network topology. Table 6-1 below compares how the three protocols differ regarding the port state transition.

All three protocols calculate a stable topology in the same way. Every segment will have a single path to the root bridge. All bridges listen for BPDU packets. However, BPDU packets are sent more frequently - with every Hello packet. BPDU packets are sent even if a BPDU packet was not received. Therefore, each link between bridges is sensitive to the status of the link. Ultimately this difference results in faster detection of failed links, and thus faster topology adjustment. A drawback of 802.1d is this absence of immediate feedback from adjacent bridges.

802.1s MSTP	802.1w RSTP	802.1d STP	Forwarding	Learning
Discarding	Discarding	Disabled	No	No
Discarding	Discarding	Blocking	No	No
Discarding	Discarding	Listening	No	No
Learning	Learning	Learning	No	Yes
Forwarding	Forwarding	Forwarding	Yes	Yes

Table 6- 1. Comparing Port States

RSTP is capable of a more rapid transition to a forwarding state - it no longer relies on timer configurations - RSTP compliant bridges are sensitive to feedback from other RSTP compliant bridge links. Ports do not need to wait for the topology to stabilize before transitioning to a forwarding state. In order to allow this rapid transition, the protocol introduces two new variables: the edge port and the point-to-point (P2P) port.

Edge Port

The edge port is a configurable designation used for a port that is directly connected to a segment where a loop cannot be created. An example would be a port connected directly to a single workstation. Ports that are designated as edge ports transition to a forwarding state immediately without going through the listening and learning states. An edge port loses its status if it receives a BPDU packet, immediately becoming a normal spanning tree port.

P2P Port

A P2P port is also capable of rapid transition. P2P ports may be used to connect to other bridges. Under RSTP/MSTP, all ports operating in full-duplex mode are considered to be P2P ports, unless manually overridden through configuration.

802.1d / 802.1w / 802.1s Compatibility

MSTP or RSTP can interoperate with legacy equipment and is capable of automatically adjusting BPDU packets to 802.1d format when necessary. However, any segment using 802.1d STP will not benefit from the rapid transition and rapid topology change detection of MSTP or RSTP. The protocol also provides for a variable used for migration in the event that legacy equipment on a segment is updated to use RSTP or MSTP.

The Spanning Tree Protocol (STP) operates on two levels:

1. On the switch level, the settings are globally implemented.
2. On the port level, the settings are implemented on a per user-defined group of ports basis.

STP Bridge Global Settings

To open the following window, open the **Spanning Tree** folder in the **Configuration** menu and click the **STP Bridge Global Settings** link.

STP Bridge Global Settings	
STP Status	Enabled ▾
STP Version	STP compatible ▾
Hello Time(1-10 Sec)	2
Max Age(6-40 Sec)	20
Forward Delay(4-30 Sec)	15
Max Hops(1-20)	20
TX Hold Count(1-10)	3
Forwarding BPDU	Enabled ▾
Apply	

Figure 6- 15. STP Bridge Global Settings – STP compatible

STP Bridge Global Settings	
STP Status	Enabled ▾
STP Version	RSTP ▾
Hello Time(1-10 Sec)	2
Max Age(6-40 Sec)	20
Forward Delay(4-30 Sec)	15
Max Hops(1-20)	20
TX Hold Count(1-10)	3
Forwarding BPDU	Enabled ▾
Apply	

Figure 6- 16. STP Bridge Global Settings - RSTP (default)

STP Bridge Global Settings	
STP Status	Enabled ▾
STP Version	MSTP ▾
Max Age(6-40 Sec)	20
Forward Delay(4-30 Sec)	15
Max Hops(1-20)	20
TX Hold Count(1-10)	3
Forwarding BPDU	Enabled ▾
Apply	

Figure 6- 17. STP Bridge Global Settings - MSTP

The following parameters can be set:

Parameter	Description
STP Status	Use the pull-down menu to enable or disable STP globally on the Switch. The default is <i>Disabled</i> .
STP Version	Use the pull-down menu to choose the desired version of STP to be implemented on the Switch. There are three choices: <i>STP</i> - Select this parameter to set the Spanning Tree Protocol(STP) globally on the switch. <i>RSTP</i> - Select this parameter to set the Rapid Spanning Tree Protocol (RSTP) globally on the Switch. <i>MSTP</i> - Select this parameter to set the Multiple Spanning Tree Protocol (MSTP) globally on the Switch.
Hello Time: (1 - 10 sec)	The Hello Time can be set from 1 to 10 seconds. This is the interval between two transmissions of BPDU packets sent by the Root Bridge to tell all other switches that it is indeed the Root Bridge. This field will only appear here when STP or RSTP is selected for the STP Version. For MSTP, the Hello Time must be set on a port per port basis. See the STP Port Settings section for further details.
Max Age: (6 - 40 sec)	The Max Age may be set to ensure that old information does not endlessly circulate through redundant paths in the network, preventing the effective propagation of the new information. Set by the Root Bridge, this value will aid in determining that the Switch has spanning tree configuration values consistent with other devices on the bridged LAN. If the value ages out and a BPDU has still not been received from the Root Bridge, the Switch will start sending its own BPDU to all other switches for permission to become the Root Bridge. If it turns out that your switch has the lowest Bridge Identifier, it will become the Root Bridge. The user may choose a time between 6 and 40 seconds. The default value is 20.
Forward Delay: (4 - 30 sec)	The Forward Delay can be from 4 to 30 seconds. Any port on the Switch spends this time in the listening state while moving from the blocking state to the forwarding state.
Max Hops (1-20)	Used to set the number of hops between devices in a spanning tree region before the BPDU (bridge protocol data unit) packet sent by the Switch will be discarded. Each switch on the hop count will reduce the hop count by one until the value reaches zero. The Switch will then discard the BPDU packet and the information held for the port will age out. The user may set a hop count from 1 to 20. The default is 20.
TX Hold Count (1-10)	Used to set the maximum number of Hello packets transmitted per interval. The count can be specified from 1 to 10. The default is 3.
Forwarding BPDU	This field can be <i>Enabled</i> or <i>Disabled</i> . When <i>Enabled</i> , it allows the forwarding of STP BPDU packets from other network devices. The default is Enabled.

Click **Apply** to implement changes made.



NOTE: The Hello Time cannot be longer than the Max. Age. Otherwise, a configuration error will occur. Observe the following formulas when setting the above parameters:

Max. Age $\leq 2 \times$ (Forward Delay - 1 second)

Max. Age $\geq 2 \times$ (Hello Time + 1 second)

MST Configuration Identification

The following screens in the **MST Configuration Table** window allow the user to configure a MSTI instance on the Switch. These settings will uniquely identify a multiple spanning tree instance set on the Switch. The Switch initially possesses one *CIST* or Common Internal Spanning Tree of which the user may modify the parameters for but cannot change the MSTI ID for, and cannot be deleted. To view the **MST Configuration Identification** window, click **Configuration > Spanning Tree > MST Configuration Identification**:

Figure 6- 18. MST Configuration Identification window

The window above contains the following information:

Parameter	Description
Configuration Name	A previously configured name set on the Switch to uniquely identify the MSTI (Multiple Spanning Tree Instance). If a configuration name is not set, this field will show the MAC address to the device running MSTP.
Revision Level	This value, along with the Configuration Name will identify the MSTP region configured on the Switch.
MSTI ID	This field shows the MSTI IDs currently set on the Switch. This field will always have the CIST MSTI, which may be configured but not deleted. Clicking the hyperlinked name will open a new window for configuring parameters associated with that particular MSTI.
VID List	This field displays the VLAN IDs associated with the specific MSTI.

To delete a previously set MSTI Instance ID, click the corresponding  under the **Delete** heading in the **MST Configuration Identification** window. Clicking the **Add** button will reveal the following window to configure:

Figure 6- 19. Instance ID Settings window- Add

The user may configure the following parameters to create a MSTI in the Switch.

Parameter	Description
MSTI ID	Enter a number between 1 and 15 to set a new MSTI on the Switch.
Type	<i>Create</i> is selected to create a new MSTI. No other choices are available for this field when creating a new MSTI.
VID List (1-4094)	This field is used to specify the VID range from configured VLANs set on the Switch. Supported VIDs on the Switch range from ID number 1 to 4094.

Click **Apply** to implement changes made.

To configure the settings for the CIST, click on its hyperlinked **MSTI ID** number in the **MST Configuration Identification** window, which will reveal the following window to configure:

Figure 6- 20. Instance ID Settings window - CIST modify

The user may configure the following parameters to configure the CIST on the Switch.

Parameter	Description
MSTI ID	The MSTI ID of the CIST is 0 and cannot be altered.
Type	This field allows the user to choose a desired method for altering the MSTI settings. The user has 2 choices. <ul style="list-style-type: none"> <i>Add VID</i> - Select this parameter to add VIDs to the MSTI ID, in conjunction with the VID List parameter. <i>Remove VID</i> - Select this parameter to remove VIDs from the MSTI ID, in conjunction with the VID List parameter.
VID List (1-4094)	This field is used to specify the VID range from configured VLANs set on the Switch. Supported VIDs on the Switch range from ID number 1 to 4094.

Click **Apply** to implement changes made.

To configure the parameters for a previously set MSTI, click on its hyperlinked **MSTI ID** number, which will reveal the following screen for configuration.

Figure 6- 21. Instance ID Settings window - Modify

The user may configure the following parameters for a MSTI on the Switch.

Parameter	Description
MSTI ID	Displays the MSTI ID previously set by the user.
Type	This field allows the user to choose a desired method for altering the MSTI settings. The user has 2 choices. <ul style="list-style-type: none"> <i>Add VID</i> - Select this parameter to add VLANs to the MSTI ID, in conjunction with the VID List parameter. <i>Remove VID</i> - Select this parameter to remove VLANs from the MSTI ID, in conjunction with the VID List parameter.
VID List (1-4094)	This field is used to specify the VID range from configured VLANs set on the Switch that the user wishes to add to this MSTI ID. Supported VLANs on the Switch range from ID number 1 to 4094. This parameter can only be utilized if the Type chosen is <i>Add</i> or <i>Remove</i> .

Click **Apply** to implement changes made.

MSTP Port Information

This window displays the current MSTI configuration settings and can be used to update the port configuration for an MSTI ID. If a loop occurs, the MSTP function will use the port priority to select an interface to put into the forwarding state. Set a higher priority value for interfaces to be selected for forwarding first. In instances where the priority value is identical, the MSTP function will implement the lowest port number into the forwarding state and other interfaces will be blocked. Remember that lower priority values mean higher priorities for forwarding packets.

To view the following window, click **Configuration > Spanning Tree > MSTI Port Information**:

Unit	Port	Apply
1	Port 1	Apply

MSTP Port Information-Port 1 of Unit 1					
Msti	Designated Bridge	Internal PathCost	Prio	Status	Role
0	N/A	200000	128	Disabled	Disabled

Figure 6- 22. MSTP Port Information window

To view the MSTI settings for a particular port, select the **Port** number, located in the top left hand corner of the screen and click **Apply**. To modify the settings for a particular **MSTI Instance**, click on its hyperlinked MSTI ID, which will reveal the following window.

MSTI Settings-Port 1 of Unit 1	
Instance ID	<input type="text" value="1"/>
Internal cost(0=Auto)	<input type="text" value="0"/>
Priority	<input type="text" value="128"/>
<input type="button" value="Apply"/>	
Show MSTP Port Information Table-Port 1 of Unit 1	

Figure 6- 23. MSTI Settings window

Parameter	Description
Instance ID	Displays the MSTI ID of the instance being configured. An entry of 0 in this field denotes the CIST (default MSTI).
Internal cost	This parameter is set to represent the relative cost of forwarding packets to specified ports when an interface is selected within a STP instance. The default setting is 0 (auto). There are two options: <ul style="list-style-type: none"> <i>0 (auto)</i> - Selecting this parameter for the <i>internalCost</i> will set quickest route automatically and optimally for an interface. The default value is derived from the media speed of the interface. <i>value 1-2000000</i> - Selecting this parameter with a value in the range of 1-2000000 will set the quickest route when a loop occurs. A lower Internal cost represents a quicker transmission.
Priority	Enter a value between 0 and 240 to set the priority for the port interface. A higher priority will designate the interface to forward packets first. A lower number denotes a higher priority. This entry must be divisible by 16. The default priority setting is 128.

Click **Apply** to implement changes made.

STP Instance Settings

The following window displays MSTIs currently set on the Switch. To view the following table, click **Configuration > Spanning Tree > STP Instance Settings**:

STP Instance Settings			
Instance Type	Instance Status	Instance Priority	Priority
CIST	Enabled	32768(bridge priority : 32768, sys ID ext : 0)	<input type="button" value="Modify"/>
MSTI(1)	Enabled	32769(bridge priority : 32768, sys ID ext : 1)	<input type="button" value="Modify"/>

Figure 6- 24. STP Instance Settings

The following information is displayed:

Parameter	Description
Instance Type	Displays the instance type(s) currently configured on the Switch. Each instance type is classified by a MSTI ID. CIST refers to the default MSTI configuration set on the Switch.
Instance Status	Displays the current status of the corresponding MSTI ID
Instance Priority	Displays the priority of the corresponding MSTI Instance Type. The lowest priority will be the root bridge.
Priority	Click the Modify button to change the priority of the MSTI. This will open the Instance ID Settings window to configure. The Type field in this window will be permanently set to <i>Set Priority Only</i> . Enter the new priority in the Priority field and click Apply to implement the new priority setting.

Click **Apply** to implement changes made.

Clicking the hyperlinked name will allow the user to view the current parameters set for the MSTI Instance.

STP Instance Operational Status	
Designated Root Bridge	4096/00-01-27-32-26-95
External Root Cost	200004
Regional Root Bridge	32768/00-53-13-1a-33-24
Internal Root Cost	0
Designated Bridge	32768/00-50-ba-71-20-d6
Root Port	1
Max Age	20
Forward Delay	15
Last Topology Change	177
Topology Changes Count	157
Show STP Instance Table	

Figure 6- 25. STP Instance Operational Status – CIST

STP Instance Operational Status	
Regional Root Bridge	32770/00-53-13-1a-33-24
Internal Root Cost	0
Designated Bridge	32770/00-53-13-1a-33-24
Root Port	None
Remaining Hops	20
Last Topology Change	288
Topology Changes Count	3
Show STP Instance Table	

Figure 6- 26. STP Instance Operational Status – Previously Configured MSTI

The following parameters may be viewed in the **STP Instance Operational Status** windows:

Parameter	Description
Designated Root Bridge	This field will show the priority and MAC address of the Root Bridge.
External Root Cost	<p>This defines a metric that indicates the relative cost of forwarding packets to the specified port list. Port cost can be set automatically or as a metric value. The default value is 0 (auto).</p> <ul style="list-style-type: none"> <i>0 (auto)</i> - Setting 0 for the external cost will automatically set the speed for forwarding packets to the specified port(s) in the list for optimal efficiency. Default port cost: 100Mbps port = 200000. Gigabit port = 20000. <i>value 1-200000000</i> - Define a value between 1 and 200000000 to determine the external cost. The lower the number, the greater the probability the port will be chosen to forward packets.
Regional Root Bridge	This field will show the priority and MAC address of the Regional (Internal) Root Bridge. This MAC address should be the MAC address of the Switch.
Internal Root Cost	<p>This parameter is set to represent the relative cost of forwarding packets to specified ports when an interface is selected within a STP instance. The default setting is 0 (auto). There are two options:</p> <ul style="list-style-type: none"> <i>0 (auto)</i> - Selecting this parameter for the <i>internalCost</i> will set quickest route automatically and optimally for an interface. The default value is derived from the media speed of the interface. <i>value 1-2000000</i> - Selecting this parameter with a value in the range of 1-2000000 will set the quickest route when a loop occurs. A lower Internal cost represents a quicker transmission.
Designated Bridge	This field will show the priority and MAC address of the Designated Bridge. The information shown in this table comes from a BPDU packet originating from this bridge.
Root Port	This is the port on the Switch that is physically connected to the Root Bridge.
Max Age	The Max Age may be set to ensure that old information does not endlessly circulate through redundant paths in the network, preventing the effective propagation of the new information. Set by the Root Bridge, this value will aid in determining that the

	Switch has spanning tree configuration values consistent with other devices on the bridged LAN. If the value ages out and a BPDU has still not been received from the Root Bridge, the Switch will start sending its own BPDU to all other switches for permission to become the Root Bridge. If it turns out that your switch has the lowest Bridge Identifier, it will become the Root Bridge. The user may choose a time between 6 and 40 seconds. The default value is 20.
Forward Delay	The Forward Delay can be from 4 to 30 seconds. Any port on the Switch spends this time in the listening state while moving from the blocking state to the forwarding state.
Last Topology Change	This field shows the time, in seconds, since the last spanning tree topology change.
Topology Changes Count	This field displays the number of times that the spanning tree topology has changed since the original initial boot up of the Switch.

STP Port Settings

STP can be set up on a port per port basis. To view the following window click **Configuration > Spanning Tree > STP Port Settings**:

STP Port Settings									
Unit	From	To	External Cost (0=Auto)	Hello Time	Migrate	Edge	P2P	State	
1	Port 1	Port 1	0		No	False	True	Enabled	
Apply									
STP Port Information Table-Unit 1									
Port	External Cost		Hello Time		Edge		P2P		Port STP
1M	AUTO/200000		2/2		No/No		Auto/Yes		Enabled
2T	AUTO/200000		2/2		No/No		Auto/Yes		Enabled
3T	AUTO/200000		2/2		No/No		Auto/Yes		Enabled
4	AUTO/200000		2/2		No/No		Auto/Yes		Enabled
5	AUTO/200000		2/2		No/No		Auto/Yes		Enabled
6	AUTO/200000		2/2		No/No		Auto/Yes		Enabled
7	AUTO/200000		2/2		No/No		Auto/Yes		Enabled
8	AUTO/200000		2/2		No/No		Auto/Yes		Enabled
9	AUTO/200000		2/2		No/No		Auto/Yes		Enabled
10	AUTO/200000		2/2		No/No		Auto/Yes		Enabled
11	AUTO/200000		2/2		No/No		Auto/Yes		Enabled
12	AUTO/200000		2/2		No/No		Auto/Yes		Enabled

Figure 6- 27. STP Port Settings and Table window

In addition to setting Spanning Tree parameters for use on the switch level, the Switch allows for the configuration of groups of ports, each port-group of which will have its own spanning tree, and will require some of its own configuration settings. An STP Group will use the switch-level parameters entered above, with the addition of **Port Priority** and **Port Cost**.

An STP Group spanning tree works in the same way as the switch-level spanning tree, but the root bridge concept is replaced with a root port concept. A root port is a port of the group that is elected based on port priority and port cost, to be the connection to the network for the group. Redundant links will be blocked, just as redundant links are blocked on the switch level.

The STP on the switch level blocks redundant links between switches (and similar network devices). The port level STP will block redundant links within an STP Group.

It is advisable to define an STP Group to correspond to a VLAN group of ports.

The following fields can be set:

Parameter	Description
Unit	Choose the Switch ID number of the Switch in the switch stack to be modified.
From/To	A consecutive group of ports may be configured starting with the selected port.

External Cost (<i>0 = Auto</i>)	<p>External Cost - This defines a metric that indicates the relative cost of forwarding packets to the specified port list. Port cost can be set automatically or as a metric value. The default value is 0 (auto).</p> <ul style="list-style-type: none"> • <i>0 (auto)</i> - Setting 0 for the external cost will automatically set the speed for forwarding packets to the specified port(s) in the list for optimal efficiency. Default port cost: 100Mbps port = 200000. Gigabit port = 20000. • <i>value 1-200000000</i> - Define a value between 1 and 200000000 to determine the external cost. The lower the number, the greater the probability the port will be chosen to forward packets.
Hello Time	The time interval between the transmission of configuration messages by the designated port, to other devices on the bridged LAN, thus stating that the Switch is still functioning. The user may choose a time between 1 and 10 seconds. The default is 2 seconds. This field is only operable when the Switch is enabled for MSTP.
Migration	Setting this parameter as "yes" will set the ports to send out BPDU packets to other bridges, requesting information on their STP setting. If the Switch is configured for RSTP, the port will be capable to migrate from 802.1d STP to 802.1w RSTP. If the Switch is configured for MSTP, the port is capable of migrating from 802.1d STP to 802.1s MSTP. RSTP and MSTP can coexist with standard STP, however the benefits of RSTP and MSTP are not realized on a port where an 802.1d network connects to an 802.1w or 802.1s enabled network. Migration should be set as yes on ports connected to network stations or segments that are capable of being upgraded to 802.1w RSTP or 802.1s MSTP on all or some portion of the segment.
Edge	Choosing the true parameter designates the port as an edge port. Edge ports cannot create loops, however an edge port can lose edge port status if a topology change creates a potential for a loop. An edge port normally should not receive BPDU packets. If a BPDU packet is received, it automatically loses edge port status. Choosing the false parameter indicates that the port does not have edge port status.
P2P	Choosing the <i>True</i> parameter indicates a point-to-point (P2P) shared link. P2P ports are similar to edge ports, however they are restricted in that a P2P port must operate in full-duplex. Like edge ports, P2P ports transition to a forwarding state rapidly thus benefiting from RSTP. A p2p value of <i>false</i> indicates that the port cannot have p2p status. <i>Auto</i> allows the port to have p2p status whenever possible and operate as if the p2p status were true. If the port cannot maintain this status, (for example if the port is forced to half-duplex operation) the p2p status changes to operate as if the p2p value were <i>False</i> . The default setting for this parameter is <i>True</i> .
State	This drop-down menu allows you to enable or disable STP for the selected group of ports. The default is <i>Enabled</i> .

Click **Apply** to implement changes made.

Forwarding & Filtering

Unicast Forwarding

Open the **Forwarding & Filtering** folder in the **Configuration** menu and click on the **Unicast Forwarding** link. This will open the **Setup Static Unicast Forwarding Table**, as shown below:

The screenshot shows two windows. The top window, titled "Setup Static Unicast Forwarding Table", has a header bar with the title. Below it is a table with four columns: "VLAN ID", "MAC Address", "Unit", and "Port". The "VLAN ID" field contains "1", "MAC Address" contains "00:00:00:00:00:00", "Unit" is a dropdown menu showing "1", and "Port" is a dropdown menu showing "Port 1". An "Add" button is located to the right of the table. Below this is a second window titled "Static Unicast Forwarding Table". It has a header bar with the title and a table with six columns: "MAC Address", "VID", "VLAN Name", "Unit", "Port", and "Delete". The "Delete" column contains a small 'X' icon. Below the table, the text "End of data!" is displayed in red.

Figure 6- 28. Setup Static Unicast Forwarding Table and Static Unicast Forwarding Table window

To add or edit an entry, define the following parameters and then click **Add**:

Parameter	Description
VLAN ID (VID)	The VLAN ID number of the VLAN on which the above Unicast MAC address resides.
MAC Address	The MAC address to which packets will be statically forwarded. This must be a unicast MAC address.
Unit	Choose the Switch ID number of the Switch in the switch stack to be modified.
Port	Allows the selection of the port number on which the MAC address entered above resides.

Click **Apply** to implement the changes made. Current entries can be found in the **Static Unicast Forwarding Table** as shown in the bottom half of the figure above. To delete an entry in the **Static Unicast Forwarding Table**, click the corresponding  under the **Delete** heading.

Static Multicast Forwarding

The following figure and table describe how to set up **Multicast Forwarding** on the Switch. Open the **Forwarding & Filtering** folder in the **Configuration** menu, and click on the **Multicast Forwarding** link to see the entry screen below:

The screenshot shows two windows. The top window, titled "Static Multicast Forwarding Settings", has a header bar with the title. Below it is a text input field containing "Add new Multicast Forwarding Settings" and an "Add" button to its right. Below this is a second window titled "Current Multicast Forwarding Entries". It has a header bar with the title and a table with five columns: "VLAN ID", "MAC Address", "Type", "Modify", and "Delete".

Figure 6- 29. Static Multicast Forwarding Settings and Current Multicast Forwarding Entries window

The **Static Multicast Forwarding Settings** page displays all of the entries made into the Switch's static multicast forwarding table. Click the **Add** button to open the **Setup Static Multicast Forwarding Table**, as shown below:

Setup Static Multicast Forwarding Table																								
Unit	VID	Multicast MAC Address																						
1		00:00:00:00:00:00																						
Port Settings	1	2	3	4	5	6	7	8	9	10	11	12	13	14	15	16	17	18	19	20	21	22	23	24
None	<input type="radio"/>	<input type="radio"/>	<input type="radio"/>	<input type="radio"/>	<input type="radio"/>	<input type="radio"/>	<input type="radio"/>	<input type="radio"/>	<input type="radio"/>	<input type="radio"/>	<input type="radio"/>	<input type="radio"/>	<input type="radio"/>	<input type="radio"/>	<input type="radio"/>	<input type="radio"/>	<input type="radio"/>	<input type="radio"/>	<input type="radio"/>	<input type="radio"/>	<input type="radio"/>	<input type="radio"/>	<input type="radio"/>	<input type="radio"/>
Egress	<input type="radio"/>	<input type="radio"/>	<input type="radio"/>	<input type="radio"/>	<input type="radio"/>	<input type="radio"/>	<input type="radio"/>	<input type="radio"/>	<input type="radio"/>	<input type="radio"/>	<input type="radio"/>	<input type="radio"/>	<input type="radio"/>	<input type="radio"/>	<input type="radio"/>	<input type="radio"/>	<input type="radio"/>	<input type="radio"/>	<input type="radio"/>	<input type="radio"/>	<input type="radio"/>	<input type="radio"/>	<input type="radio"/>	<input type="radio"/>

[Show All Multicast Forwarding Entries](#)

Figure 6- 30. Setup Static Multicast Forwarding Table

The following parameters can be set:

Parameter	Description
Unit	Choose the Switch ID number of the Switch in the switch stack to be modified.
VID	The VLAN ID of the VLAN to which the corresponding MAC address belongs.
Multicast MAC Address	The MAC address of the static source of multicast packets. This must be a multicast MAC address.
Port	Allows the selection of ports that will be members of the static multicast group. The options are: <i>None</i> - No restrictions on the port dynamically joining the multicast group. When None is chosen, the port will not be a member of the Static Multicast Group. <i>Egress</i> - The port is a static member of the multicast group.

Click **Apply** to implement the changes made. To delete an entry in the **Static Multicast Forwarding Table**, click the corresponding  under the **Delete** heading. Click the [Show All Multicast Forwarding Entries](#) link to return to the **Static Multicast Forwarding Settings** window.

VLANs

Understanding IEEE 802.1p Priority

Priority tagging is a function defined by the IEEE 802.1p standard designed to provide a means of managing traffic on a network where many different types of data may be transmitted simultaneously. It is intended to alleviate problems associated with the delivery of time critical data over congested networks. The quality of applications that are dependent on such time critical data, such as video conferencing, can be severely and adversely affected by even very small delays in transmission.

Network devices that are in compliance with the IEEE 802.1p standard have the ability to recognize the priority level of data packets. These devices can also assign a priority label or tag to packets. Compliant devices can also strip priority tags from packets. This priority tag determines the packet's degree of expeditiousness and determines the queue to which it will be assigned.

Priority tags are given values from 0 to 7 with 0 being assigned to the lowest priority data and 7 assigned to the highest. The highest priority tag 7 is generally only used for data associated with video or audio applications, which are sensitive to even slight delays, or for data from specified end users whose data transmissions warrant special consideration.

The Switch allows you to further tailor how priority tagged data packets are handled on your network. Using queues to manage priority tagged data allows you to specify its relative priority to suit the needs of your network. There may be circumstances where it would be advantageous to group two or more differently tagged packets into the same queue. Generally, however, it is recommended that the highest priority queue, Queue 1, be reserved for data packets with a priority value of 7. Packets that have not been given any priority value are placed in Queue 0 and thus given the lowest priority for delivery.

A weighted round robin system is employed on the Switch to determine the rate at which the queues are emptied of packets. The ratio used for clearing the queues is 4:1. This means that the highest priority queue, Queue 1, will clear 4 packets for every 1 packet cleared from Queue 0.

Remember, the priority queue settings on the Switch are for all ports, and all devices connected to the Switch will be affected. This priority queuing system will be especially beneficial if your network employs switches with the capability of assigning priority tags.

VLAN Description

A Virtual Local Area Network (VLAN) is a network topology configured according to a logical scheme rather than the physical layout. VLANs can be used to combine any collection of LAN segments into an autonomous user group that appears as a single LAN. VLANs also logically segment the network into different broadcast domains so that packets are forwarded only between ports within the VLAN. Typically, a VLAN corresponds to a particular subnet, although not necessarily.

VLANs can enhance performance by conserving bandwidth, and improve security by limiting traffic to specific domains.

A VLAN is a collection of end nodes grouped by logic instead of physical location. End nodes that frequently communicate with each other are assigned to the same VLAN, regardless of where they are physically on the network. Logically, a VLAN can be equated to a broadcast domain, because broadcast packets are forwarded to only members of the VLAN on which the broadcast was initiated.

Notes about VLANs in the DES-6500

No matter what basis is used to uniquely identify end nodes and assign these nodes VLAN membership, packets cannot cross VLANs without a network device performing a routing function between the VLANs.

The DES-6500 switch supports IEEE 802.1Q VLANs, Port-Based VLANs and Protocol-Based VLANs. The port untagging function can be used to remove the 802.1Q tag from packet headers to maintain compatibility with devices that are tag-unaware.

The Switch's default is to assign all ports to a single 802.1Q VLAN named "default."

The "default" VLAN has a VID = 1.

The member ports of Port-based VLANs may overlap, if desired.

IEEE 802.1Q VLANs

Some relevant terms:

Tagging - The act of putting 802.1Q VLAN information into the header of a packet.

Untagging - The act of stripping 802.1Q VLAN information out of the packet header.

Ingress port - A port on a switch where packets are flowing into the Switch and VLAN decisions must be made.

Egress port - A port on a switch where packets are flowing out of the Switch, either to another switch or to an end station, and tagging decisions must be made.

IEEE 802.1Q (tagged) VLANs are implemented on the Switch. 802.1Q VLANs require tagging, which enables them to span the entire network (assuming all switches on the network are IEEE 802.1Q-compliant).

VLANs allow a network to be segmented in order to reduce the size of broadcast domains. All packets entering a VLAN will only be forwarded to the stations (over IEEE 802.1Q enabled switches) that are members of that VLAN, and this includes broadcast, multicast and unicast packets from unknown sources.

VLANs can also provide a level of security to your network. IEEE 802.1Q VLANs will only deliver packets between stations that are members of the VLAN.

Any port can be configured as either tagging or untagging. The untagging feature of IEEE 802.1Q VLANs allows VLANs to work with legacy switches that don't recognize VLAN tags in packet headers. The tagging feature allows VLANs to span multiple 802.1Q-compliant switches through a single physical connection and allows Spanning Tree to be enabled on all ports and work normally.

The IEEE 802.1Q standard restricts the forwarding of untagged packets to the VLAN the receiving port is a member of.

The main characteristics of IEEE 802.1Q are as follows:

- Assigns packets to VLANs by filtering.
- Assumes the presence of a single global spanning tree.
- Uses an explicit tagging scheme with one-level tagging.
- 802.1Q VLAN Packet Forwarding
- Packet forwarding decisions are made based upon the following three types of rules:
 - Ingress rules - rules relevant to the classification of received frames belonging to a VLAN.
 - Forwarding rules between ports - decides whether to filter or forward the packet.
 - Egress rules - determines if the packet must be sent tagged or untagged.

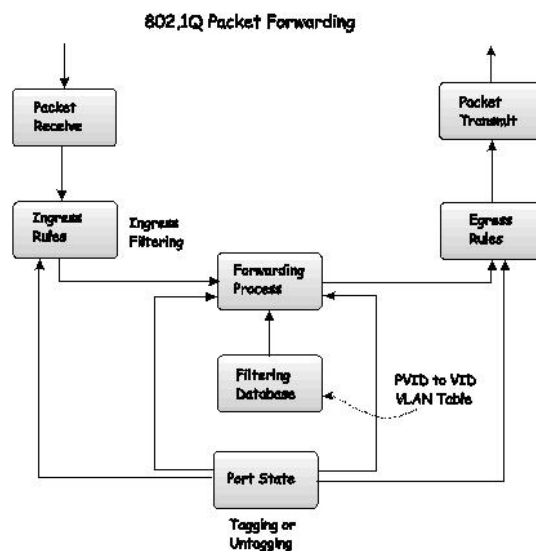

Figure 6- 31. IEEE 802.1Q Packet Forwarding

802.1Q VLAN Tags

The figure below shows the 802.1Q VLAN tag. There are four additional octets inserted after the source MAC address. Their presence is indicated by a value of 0x8100 in the EtherType field. When a packet's EtherType field is equal to 0x8100, the packet carries the IEEE 802.1Q/802.1p tag. The tag is contained in the following two octets and consists of 3 bits of user priority, 1 bit of Canonical Format Identifier (CFI - used for encapsulating Token Ring packets so they can be carried across Ethernet backbones), and 12 bits of VLAN ID (VID). The 3 bits of user priority are used by 802.1p. The VID is the VLAN identifier and is used by the 802.1Q standard. Because the VID is 12 bits long, 4094 unique VLANs can be identified.

The tag is inserted into the packet header making the entire packet longer by four octets. All of the information originally contained in the packet is retained.

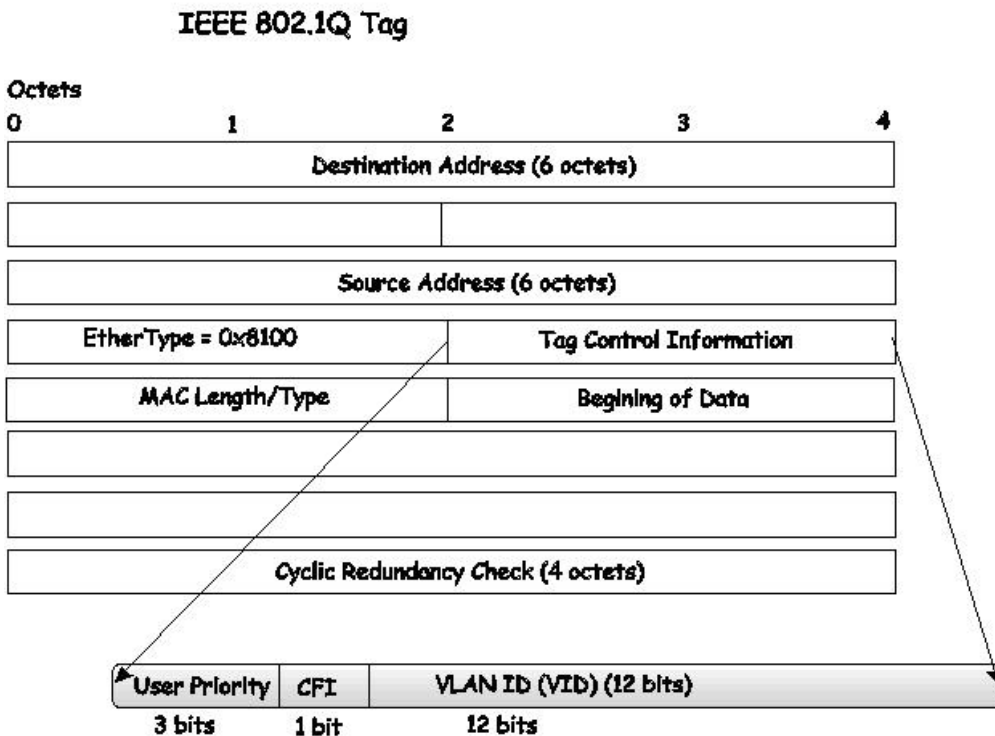

Figure 6- 32. IEEE 802.1Q Tag

The EtherType and VLAN ID are inserted after the MAC source address, but before the original EtherType/Length or Logical Link Control. Because the packet is now a bit longer than it was originally, the Cyclic Redundancy Check (CRC) must be recalculated.

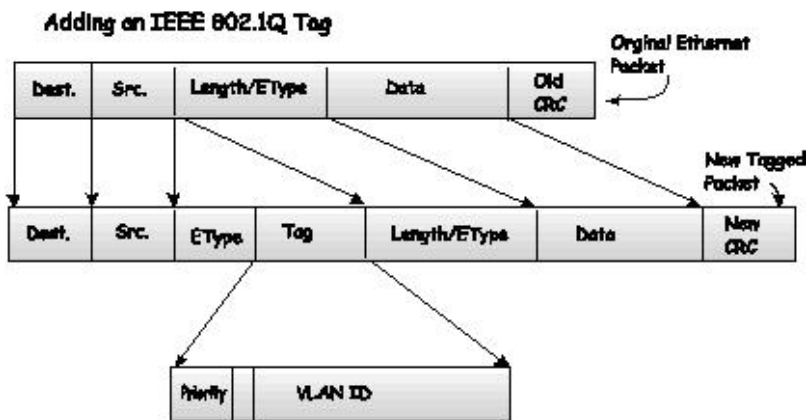

Figure 6- 33. Adding an IEEE 802.1Q Tag

Port VLAN ID

Packets that are tagged (are carrying the 802.1Q VID information) can be transmitted from one 802.1Q compliant network device to another with the VLAN information intact. This allows 802.1Q VLANs to span network devices (and indeed, the entire network, if all network devices are 802.1Q compliant).

Unfortunately, not all network devices are 802.1Q compliant. These devices are referred to as tag-unaware. 802.1Q devices are referred to as tag-aware.

Prior to the adoption of 802.1Q VLANs, port-based and MAC-based VLANs were in common use. These VLANs relied upon a Port VLAN ID (PVID) to forward packets. A packet received on a given port would be assigned that port's PVID and then be forwarded to the port that corresponded to the packet's destination address (found in the Switch's forwarding table). If the PVID of the port that received the packet is different from the PVID of the port that is to transmit the packet, the Switch will drop the packet.

Within the Switch, different PVIDs mean different VLANs (remember that two VLANs cannot communicate without an external router). So, VLAN identification based upon the PVIDs cannot create VLANs that extend outside a given switch (or switch stack).

Every physical port on a switch has a PVID. 802.1Q ports are also assigned a PVID, for use within the Switch. If no VLANs are defined on the Switch, all ports are then assigned to a default VLAN with a PVID equal to 1. Untagged packets are assigned the PVID of the port on which they were received. Forwarding decisions are based upon this PVID, in so far as VLANs are concerned. Tagged packets are forwarded according to the VID contained within the tag. Tagged packets are also assigned a PVID, but the PVID is not used to make packet-forwarding decisions, the VID is.

Tag-aware switches must keep a table to relate PVIDs within the Switch to VIDs on the network. The Switch will compare the VID of a packet to be transmitted to the VID of the port that is to transmit the packet. If the two VIDs are different, the Switch will drop the packet. Because of the existence of the PVID for untagged packets and the VID for tagged packets, tag-aware and tag-unaware network devices can coexist on the same network.

A switch port can have only one PVID, but can have as many VIDs as the Switch has memory in its VLAN table to store them.

Because some devices on a network may be tag-unaware, a decision must be made at each port on a tag-aware device before packets are transmitted - should the packet to be transmitted have a tag or not? If the transmitting port is connected to a tag-unaware device, the packet should be untagged. If the transmitting port is connected to a tag-aware device, the packet should be tagged.

Tagging and Untagging

Every port on an 802.1Q compliant switch can be configured as tagging or untagging.

Ports with tagging enabled will put the VID number, priority and other VLAN information into the header of all packets that flow into and out of it. If a packet has previously been tagged, the port will not alter the packet, thus keeping the VLAN information intact. The VLAN information in the tag can then be used by other 802.1Q compliant devices on the network to make packet-forwarding decisions.

Ports with untagging enabled will strip the 802.1Q tag from all packets that flow into and out of those ports. If the packet doesn't have an 802.1Q VLAN tag, the port will not alter the packet. Thus, all packets received by and forwarded by an untagging port will have no 802.1Q VLAN information. (Remember that the PVID is only used internally within the Switch). Untagging is used to send packets from an 802.1Q-compliant network device to a non-compliant network device.

Ingress Filtering

A port on a switch where packets are flowing into the Switch and VLAN decisions must be made is referred to as an ingress port. If ingress filtering is enabled for a port, the Switch will examine the VLAN information in the packet header (if present) and decide whether or not to forward the packet.

If the packet is tagged with VLAN information, the ingress port will first determine if the ingress port itself is a member of the tagged VLAN. If it is not, the packet will be dropped. If the ingress port is a member of the 802.1Q VLAN, the Switch then determines if the destination port is a member of the 802.1Q VLAN. If it is not, the packet is dropped. If the destination port is a member of the 802.1Q VLAN, the packet is forwarded and the destination port transmits it to its attached network segment.

If the packet is not tagged with VLAN information, the ingress port will tag the packet with its own PVID as a VID (if the port is a tagging port). The switch then determines if the destination port is a member of the same VLAN (has the same

VID) as the ingress port. If it does not, the packet is dropped. If it has the same VID, the packet is forwarded and the destination port transmits it on its attached network segment.

This process is referred to as ingress filtering and is used to conserve bandwidth within the Switch by dropping packets that are not on the same VLAN as the ingress port at the point of reception. This eliminates the subsequent processing of packets that will just be dropped by the destination port.

Default VLANs

The Switch initially configures one VLAN, VID = 1, called "default." The factory default setting assigns all ports on the Switch to the "default." As new VLANs are configured in Port-based mode, their respective member ports are removed from the "default."

Packets cannot cross VLANs. If a member of one VLAN wants to connect to another VLAN, the link must be through an external router.



NOTE: If no VLANs are configured on the Switch, then all packets will be forwarded to any destination port. Packets with unknown source addresses will be flooded to all ports. Broadcast and multicast packets will also be flooded to all ports.

An example is presented below:

VLAN Name	VID	Switch Ports
System (default)	1	5, 6, 7, 8, 21, 22, 23, 24
Engineering	2	9, 10, 11, 12
Marketing	3	13, 14, 15, 16
Finance	4	17, 18, 19, 20
Sales	5	1, 2, 3, 4

Table 6- 2. VLAN Example - Assigned Ports

Port-based VLANs

Port-based VLANs limit traffic that flows into and out of switch ports. Thus, all devices connected to a port are members of the VLAN(s) the port belongs to, whether there is a single computer directly connected to a switch, or an entire department.

On port-based VLANs, NICs do not need to be able to identify 802.1Q tags in packet headers. NICs send and receive normal Ethernet packets. If the packet's destination lies on the same segment, communications take place using normal Ethernet protocols. Even though this is always the case, when the destination for a packet lies on another switch port, VLAN considerations come into play to decide if the packet is dropped by the Switch or delivered.

VLAN Segmentation

Take for example a packet that is transmitted by a machine on Port 1 that is a member of VLAN 2. If the destination lies on another port (found through a normal forwarding table lookup), the Switch then looks to see if the other port (Port 10) is a member of VLAN 2 (and can therefore receive VLAN 2 packets). If Port 10 is not a member of VLAN 2, then the packet will be dropped by the Switch and will not reach its destination. If Port 10 is a member of VLAN 2, the packet will go through. This selective forwarding feature based on VLAN criteria is how VLANs segment networks. The key point being that Port 1 will only transmit on VLAN 2.

Network resources such as printers and servers however, can be shared across VLANs. This is achieved by setting up overlapping VLANs. That is ports can belong to more than one VLAN group. For example, setting VLAN 1 members to ports 1, 2, 3, and 4 and VLAN 2 members to ports 1, 5, 6, and 7. Port 1 belongs to two VLAN groups. Ports 8, 9, and 10 are not configured to any VLAN group. This means ports 8, 9, and 10 are in the same VLAN group.

VLAN and Trunk Groups

The members of a trunk group have the same VLAN setting. Any VLAN setting on the members of a trunk group will apply to the other member ports.



NOTE: In order to use VLAN segmentation in conjunction with port trunk groups, you can first set the port trunk group(s), and then you may configure VLAN settings. If you wish to change the port trunk grouping with VLANs already in place, you will not need to reconfigure the VLAN settings after changing the port trunk group settings. VLAN settings will automatically change in conjunction with the change of the port trunk group settings.

Protocol VLANs

The DES-6500 switch incorporates protocol-based VLANs. This standard, defined by the IEEE 802.1v standard maps packets to protocol-defined VLANs by examining the type octet within the packet header to discover the type of protocol associated with it. After assessing the protocol, the Switch will forward the packets to all ports within the protocol-assigned VLAN. This feature will benefit the administrator by better balancing load sharing and enhancing traffic classification. The Switch supports fourteen (14) pre-defined protocols for configuration. The user may also choose a protocol that is not one of the fourteen defined protocols by properly configuring the *userDefined* protocol VLAN. The supported protocols for the protocol VLAN function on this switch include IP, IPX, DEC LAT, SNAP, NetBIOS, AppleTalk, XNS, SNA, IPv6, RARP and VINES.

The following is a list of type headers for each protocol listed for VLAN configuration.

Protocol	Type Header in Hexadecimal Form
IP over Ethernet	0x0800
IPX 802.3	0xFFFF
IPX 802.2	0xE0E0
IPX SNAP	0x8137
IPX over Ethernet2	0x8137
decLAT	0x6000
SNA 802.2	0x0404
netBios	0xF0F0
XNS	0x0600
VINES	0x0BAD
IPV6	0x86DD
AppleTalk	0x809B
RARP	0x8035
SNA over Ethernet2	0x80D5

Table 6- 3. Protocol VLAN and the corresponding type header

In configuring the user-defined protocol, the administrator must make sure that the pre-defined user type header does not match any other type header. A match may cause discrepancies within the local network and failure to define the VLAN to which to forward packets.

VLAN Entry

In the **Configuration** folder, open the **VLAN** folder and click the **VLAN Entry** link to open the following window:

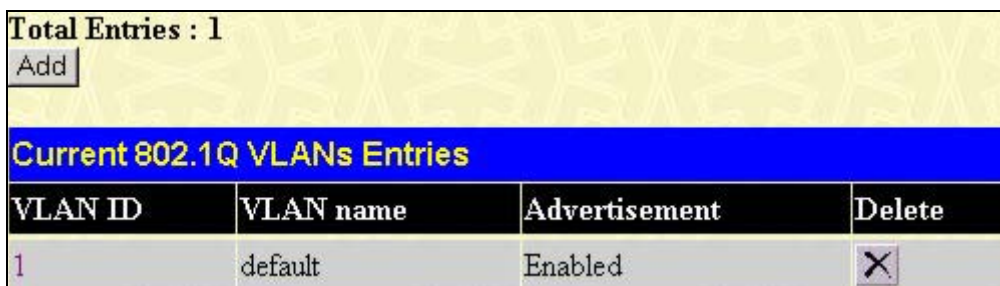

Figure 6- 34. Current 802.1Q Static VLANs Entries window

The **802.1Q Static VLANs** menu lists all previously configured VLANs by **VLAN ID** and **VLAN Name**. To delete an existing 802.1Q VLAN, click the corresponding button under the **Delete** heading.

To create a new 802.1Q VLAN, click the **Add** button in the **802.1Q Static VLANs** menu. A new menu will appear, as shown below, to configure the port settings and to assign a unique name and number to the new VLAN. See the table below for a description of the parameters in the new menu.

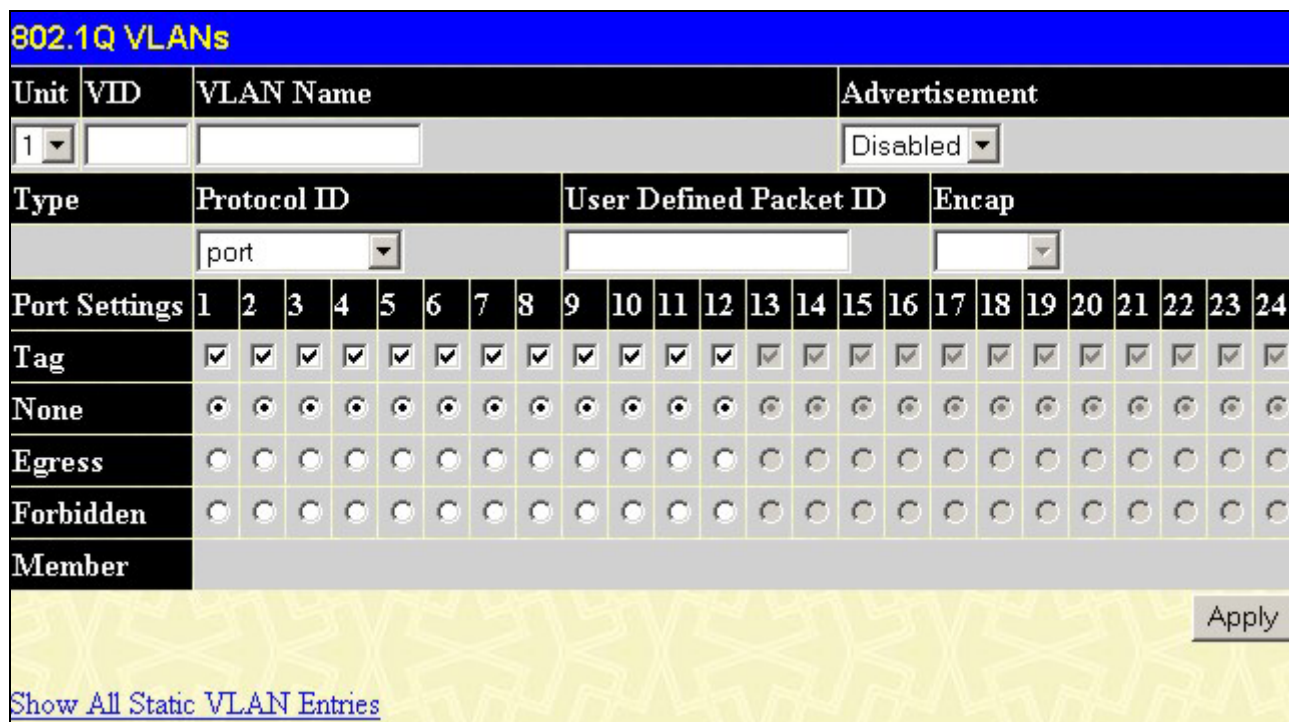

Figure 6- 35. 802.1Q Static VLANs - Add

To return to the **Current 802.1Q Static VLANs Entries** window, click the [Show All Static VLAN Entries](#) link. To change an existing 802.1Q VLAN entry, click the hyperlinked **VLAN ID** button of the corresponding entry to modify. A new menu will appear to configure the port settings and to assign a unique name and number to the new VLAN. See the table below for a description of the parameters in the new menu.

802.1Q VLANs																									
Unit	VID	VLAN Name														Advertisement									
1	1	default														Enabled									
Type	Protocol ID											User Defined Packet ID				Encap									
1QVLAN	port																								
Port Settings	1	2	3	4	5	6	7	8	9	10	11	12	13	14	15	16	17	18	19	20	21	22	23	24	
Tag	<input type="checkbox"/>	<input type="checkbox"/>	<input type="checkbox"/>	<input type="checkbox"/>	<input type="checkbox"/>	<input type="checkbox"/>	<input type="checkbox"/>	<input type="checkbox"/>	<input type="checkbox"/>	<input type="checkbox"/>	<input type="checkbox"/>	<input type="checkbox"/>	<input checked="" type="checkbox"/>	<input checked="" type="checkbox"/>	<input checked="" type="checkbox"/>	<input checked="" type="checkbox"/>	<input checked="" type="checkbox"/>	<input checked="" type="checkbox"/>	<input checked="" type="checkbox"/>	<input checked="" type="checkbox"/>	<input checked="" type="checkbox"/>	<input checked="" type="checkbox"/>	<input checked="" type="checkbox"/>	<input checked="" type="checkbox"/>	
None	<input type="radio"/>	<input type="radio"/>	<input type="radio"/>	<input type="radio"/>	<input type="radio"/>	<input type="radio"/>	<input type="radio"/>	<input type="radio"/>	<input type="radio"/>	<input type="radio"/>	<input type="radio"/>	<input type="radio"/>	<input type="radio"/>	<input type="radio"/>	<input type="radio"/>	<input type="radio"/>	<input type="radio"/>	<input type="radio"/>	<input type="radio"/>	<input type="radio"/>	<input type="radio"/>	<input type="radio"/>	<input type="radio"/>	<input type="radio"/>	
Egress	<input type="radio"/>	<input type="radio"/>	<input type="radio"/>	<input type="radio"/>	<input type="radio"/>	<input type="radio"/>	<input type="radio"/>	<input type="radio"/>	<input type="radio"/>	<input type="radio"/>	<input type="radio"/>	<input type="radio"/>	<input type="radio"/>	<input type="radio"/>	<input type="radio"/>	<input type="radio"/>	<input type="radio"/>	<input type="radio"/>	<input type="radio"/>	<input type="radio"/>	<input type="radio"/>	<input type="radio"/>	<input type="radio"/>	<input type="radio"/>	
Forbidden	<input type="radio"/>	<input type="radio"/>	<input type="radio"/>	<input type="radio"/>	<input type="radio"/>	<input type="radio"/>	<input type="radio"/>	<input type="radio"/>	<input type="radio"/>	<input type="radio"/>	<input type="radio"/>	<input type="radio"/>	<input type="radio"/>	<input type="radio"/>	<input type="radio"/>	<input type="radio"/>	<input type="radio"/>	<input type="radio"/>	<input type="radio"/>	<input type="radio"/>	<input type="radio"/>	<input type="radio"/>	<input type="radio"/>	<input type="radio"/>	
Member	1:1-1:12,2:1-2:8,3:1-3:16,4:1-4:24																								
<input type="button" value="Apply"/>																									
Show All Static VLAN Entries																									

Figure 6- 36. 802.1Q Static VLANs Entry Settings - Modify

The following fields can then be set in either the **Add** or **Modify 802.1Q Static VLANs** menus:

Parameter	Description
Unit	Choose the Switch ID number of the Switch in the switch stack to be modified.
VID (VLAN ID)	Allows the entry of a VLAN ID in the Add dialog box, or displays the VLAN ID of an existing VLAN in the Modify dialog box. VLANs can be identified by either the VID or the VLAN name.
VLAN Name	Allows the entry of a name for the new VLAN in the Add dialog box, or will display the VLAN name.
Advertisement	Enabling this function will allow the Switch to send out GVRP packets to outside sources, notifying that they may join the existing VLAN.
Type	Displays the type of protocol associated with this VLAN.
Protocol ID	<p>The following parameters allow for the creation of protocol-based VLANs. The Switch supports 14 pre-configured protocol-based VLANs plus one user-defined protocol based VLAN where the administrator may configure the settings for the appropriate protocol and forwarding of packets (15 total). Selecting a specific protocol will indicate which protocol will be utilized in determining the VLAN ownership of a tagged packet. Pre-set protocol-based VLANs on the Switch include:</p> <p><i>port</i> – Using this parameter will allow the creation of a normal 802.1Q VLAN on the Switch.</p> <p><i>ip</i> – Using this parameter will instruct the Switch to forward packets to this VLAN if the tag in the packet header is concurrent with this protocol. This packet header information is based on the Ethernet protocol.</p> <p><i>rarp</i> - Using this parameter will instruct the Switch to forward packets to this VLAN if the tag in the packet header is concurrent with this protocol. This packet header information is defined by the Reverse Address Resolution (RARP) Protocol.</p> <p><i>ipx802dot3</i> - Using this parameter will instruct the Switch to forward packets to this</p>

VLAN if the tag in the packet header is concurrent with this protocol. This packet header information is defined by Novell NetWare 802.3 (IPX - Internet Packet Exchange).

ipx802dot2 - Using this parameter will instruct the Switch to forward packets to this VLAN if the tag in the packet header is concurrent with this protocol. This packet header information is defined by Novell NetWare 802.2 (IPX - Internet Packet Exchange).

ipxSnap - Using this parameter will instruct the Switch to forward packets to this VLAN if the tag in the packet header is concurrent with this protocol. This packet header information is defined by Novell and the Sub Network Access Protocol (SNAP).

ipxEthernet2 - Using this parameter will instruct the Switch to forward packets to this VLAN if the tag in the packet header is concurrent with this protocol. This packet header information is defined by Novell Ethernet II Protocol.

appleTalk - Using this parameter will instruct the Switch to forward packets to this VLAN if the tag in the packet header is concurrent with this protocol. This packet header information is defined by the AppleTalk protocol.

decLAT - Using this parameter will instruct the Switch to forward packets to this VLAN if the tag in the packet header is concurrent with this protocol. This packet header information is defined by the Digital Equipment Corporation (DEC) Local Area Transport (LAT) protocol.

sna802dot2 - Using this parameter will instruct the Switch to forward packets to this VLAN if the tag in the packet header is concurrent with this protocol. This packet header information is defined by the Systems Network Architecture (SNA) 802.2 Protocol.

snaEthernet2 - Using this parameter will instruct the Switch to forward packets to this VLAN if the tag in the packet header is concurrent with this protocol. This packet header information is defined by the Systems Network Architecture (SNA) Ethernet II Protocol.

netBios - Using this parameter will instruct the Switch to forward packets to this VLAN if the tag in the packet header is concurrent with this protocol. This packet header information is defined by the NetBIOS Protocol.

xns - Using this parameter will instruct the Switch to forward packets to this VLAN if the tag in the packet header is concurrent with this protocol. This packet header information is defined by the Xerox Network Systems (XNS) Protocol.

vines - Using this parameter will instruct the Switch to forward packets to this VLAN if the tag in the packet header is concurrent with this protocol. This packet header information is defined by the Banyan Virtual Integrated Network Service (VINES) Protocol.

ipV6 - Using this parameter will instruct the Switch to forward packets to this VLAN if the tag in the packet header is concurrent with this protocol. This packet header information is defined by the Internet Protocol Version 6 (IPv6) Protocol.

userDefined - Using this parameter will instruct the Switch to forward packets to this VLAN if the tag in the packet header is concurrent with this protocol defined by the user. This packet header information is defined by entering the following information:

User Defined Pid - Specifies that the VLAN will only accept packets with this hexadecimal 802.1Q Ethernet type value in the packet header. The user may define an entry, in the hexadecimal form (ffff) to define the packet identification. *(The user only need enter the final four integers of the hexadecimal format to define the packet ID – {hex 0x0 0xffff})* This field is only operable if *userDefined* is selected in the Protocol ID field.

encap [ethernet | llc | snap | all] – Specifies that the Switch will examine the octet of the packet header referring to one of the protocols listed (Ethernet, LLC or SNAP), looking for a match of the hexadecimal value previously entered. *all* will instruct the Switch to examine the total packet header. After a match is found, the Switch will forward the packet to this VLAN. This field is only operable if *userDefined* is selected in the Protocol ID field.

Port Settings	Allows an individual port to be specified as member of a VLAN.
Tag	Specifies the port as either 802.1Q tagging or 802.1Q untagged. Checking the box will designate the port as Tagged.
None	Allows an individual port to be specified as a non-VLAN member.
Egress	Select this to specify the port as a static member of the VLAN. Egress member ports are ports that will be transmitting traffic for the VLAN. These ports can be either tagged or untagged.
Forbidden	Select this to specify the port as not being a member of the VLAN and that the port is forbidden from becoming a member of the VLAN dynamically.

Click **Apply** to implement changes made. Click the [Show All Static VLAN Entries](#) link to return to the **Current 802.1Q Static VLAN Entries** window.

GVRP Settings

In the **Configuration** menu, open the **VLANs** folder and click **GVRP Settings**.

The **GVRP Settings** dialog box, shown below, allows you to determine whether the Switch will share its VLAN configuration information with other GARP VLAN Registration Protocol (GVRP) enabled switches. In addition, **Ingress Checking** can be used to limit traffic by filtering incoming packets whose PVID does not match the PVID of the port. Results can be seen in the table under the configuration settings, as seen below.

GVRP Settings							
Unit	From	To	State	Ingress Check	Acceptable Frame Type	PVID	Apply
1	Port 1	Port 1	Disabled	Enabled	All		Apply
GVRP Table							
Port	PVID	GVRP	Ingress Check	Acceptable Frame Type			
1	1	Disabled	Enabled	All Frames			
2	1	Disabled	Enabled	All Frames			
3	1	Disabled	Enabled	All Frames			
4	1	Disabled	Enabled	All Frames			
5	1	Disabled	Enabled	All Frames			
6	1	Disabled	Enabled	All Frames			
7	1	Disabled	Enabled	All Frames			
8	1	Disabled	Enabled	All Frames			
9	1	Disabled	Enabled	All Frames			
10	1	Disabled	Enabled	All Frames			
11	1	Disabled	Enabled	All Frames			
12	1	Disabled	Enabled	All Frames			

Figure 6- 37. GVRP Settings and GVRP Table window

The following fields can be set:

Parameter	Description
Unit	Choose the Switch ID number of the Switch in the switch stack to be modified.
From/To	These two fields allow you to specify the range of ports that will be included in the Port-based VLAN that you are creating using the GVRP Settings page.
GVRP	The Group VLAN Registration Protocol (GVRP) enables the port to dynamically become a member of a VLAN. GVRP is <i>Disabled</i> by default.
Ingress Check	This field can be toggled using the space bar between <i>Enabled</i> and <i>Disabled</i> . <i>Enabled</i> enables the port to compare the VID tag of an incoming packet with the PVID number assigned to the port. If the two are different, the port filters (drops) the packet. <i>Disabled</i> disables ingress filtering. Ingress Checking is <i>Enabled</i> by default.
Acceptable Frame Type	This field denotes the type of frame that will be accepted by the port. The user may choose between <i>Tagged Only</i> , which means only VLAN tagged frames will be accepted, and <i>Admit_All</i> , which means both tagged and untagged frames will be accepted. <i>Admit_All</i> is enabled by default.
PVID	The read only field in the GVRP Table shows the current PVID assignment for each port, which may be manually assigned to a VLAN when created in the 802.1Q Port Settings table. The Switch's default is to assign all ports to the default VLAN with a VID of 1. The PVID is used by the port to tag outgoing, untagged packets, and to make filtering decisions about incoming packets. If the port is specified to accept only tagged frames - as tagging, and an untagged packet is forwarded to the port for transmission, the port will add an 802.1Q tag using the PVID to write the VID in the tag. When the packet arrives at its destination, the receiving device will use the PVID to make VLAN forwarding decisions. If a packet is received by the port, and Ingress filtering is enabled, the port will compare the VID of the incoming packet to its PVID. If the two are unequal, the port will drop the packet. If the two are equal, the port will receive the packet.

Click **Apply** to implement changes made.

Traffic Control

Use the **Traffic Control** menu to enable or disable storm control and adjust the threshold for multicast and broadcast storms, as well as DLF (Destination Look Up Failure). Traffic control settings are applied to individual Switch modules. To view the following window, click **Configuration > Traffic Control**:

Traffic Control Settings							
Unit	From	To	Broadcast Storm	Multicast Storm	Destination Lookup Fail	Threshold	Apply
1	Port 1	Port 1	Disabled	Disabled	Disabled	128	Apply

Traffic Control Table				
Port	Broadcast Storm	Multicast Storm	Destination Lookup Fail	Threshold
1	Disabled	Disabled	Disabled	128
2	Disabled	Disabled	Disabled	128
3	Disabled	Disabled	Disabled	128
4	Disabled	Disabled	Disabled	128
5	Disabled	Disabled	Disabled	128
6	Disabled	Disabled	Disabled	128
7	Disabled	Disabled	Disabled	128
8	Disabled	Disabled	Disabled	128
9	Disabled	Disabled	Disabled	128
10	Disabled	Disabled	Disabled	128
11	Disabled	Disabled	Disabled	128
12	Disabled	Disabled	Disabled	128

Figure 6- 38. Traffic Control Settings and Traffic Control Table window

To configure **Traffic Control**, first select the Switch's **Unit** ID number from the pull down menu and then a group of ports by using the **Group** pull down menu. Finally, enable or disable the **Broadcast Storm**, **Multicast Storm** and **Destination Unknown** using their corresponding pull-down menus.

The purpose of this window is to limit too many broadcast, multicast or unknown unicast packets flooding the network. Each port has a counter that tracks the number of broadcast packets received per second, and this counter is cleared once every second. If the broadcast, multicast or unknown unicast storm control is enabled, the port will discard all broadcast, multicast or unknown unicast packets received when the counter exceeds or equals the Threshold specified.

The **Threshold** value is the upper threshold at which the specified traffic control is switched on. This is the number of Broadcast, Multicast or DLF packets, in Kpps (kilo packets per second), received by the Switch that will trigger the storm traffic control measures. The **Threshold** value can be set from 0 to 255 kilo packets per second. The default setting is 128. The settings of each port may be viewed in the **Traffic Control Table** in the same window. Click **Apply** to implement changes made.

Port Security

A given ports' (or a range of ports') dynamic MAC address learning can be locked such that the current source MAC addresses entered into the MAC address forwarding table can not be changed once the port lock is enabled. The port can be locked by using the **Admin State** pull-down menu to *Enabled*, and clicking **Apply**.

Port Security is a security feature that prevents unauthorized computers (with source MAC addresses) unknown to the Switch prior to locking the port (or ports) from connecting to the Switch's locked ports and gaining access to the network. To view the following window, click **Configuration > Port Security**.

Port Security Settings						
Unit	From	To	Admin State	Max.Addr(0-64)	Mode	Apply
1	Port 1	Port 1	Disabled	0	Permanent	Apply

Port Security Table			
Port	Admin State	Max.Learning Addr	Lock Address Mode
1	Disabled	1	DeleteOnReset
2	Disabled	1	DeleteOnReset
3	Disabled	1	DeleteOnReset
4	Disabled	1	DeleteOnReset
5	Disabled	1	DeleteOnReset
6	Disabled	1	DeleteOnReset
7	Disabled	1	DeleteOnReset
8	Disabled	1	DeleteOnReset
9	Disabled	1	DeleteOnReset
10	Disabled	1	DeleteOnReset
11	Disabled	1	DeleteOnReset
12	Disabled	1	DeleteOnReset

Figure 6- 39. Port Security Settings and Table window

The following parameters can be set:

Parameter	Description
Unit	Choose the Switch ID number of the Switch in the switch stack to be modified.
From/To	A consecutive group of ports may be configured starting with the selected port.
Admin State	This pull-down menu allows you to enable or disable Port Security (locked MAC address table for the selected ports).
Max. Addr (0-64)	The number of MAC addresses that will be in the MAC address forwarding table for the selected switch and group of ports.
Mode	This pull-down menu allows you to select how the MAC address table locking will be implemented on the Switch, for the selected group of ports. The options are: <ul style="list-style-type: none"> <i>Permanent</i> – The locked addresses will not age out after the aging timer expires. <i>DeleteOnTimeout</i> – The locked addresses will age out after the aging timer expires. <i>DeleteOnReset</i> – The locked addresses will not age out until the Switch has been reset.

Click **Apply** to implement changes made.

Port Lock Entries

The **Port Lock Entry Delete** window is used to remove an entry from the port security entries learned by the Switch and entered into the forwarding database. To view the following window, click **Configuration > Port Lock Entries**:

Port Lock Entries Table						
VID	VLAN Name	MAC Address	Unit	Port	Type	Delete
1	default	00-00-80-c8-09-89	1	11	Secured_Permanent	<input type="checkbox"/>
1	default	00-01-30-10-00-0b	1	11	Secured_Permanent	<input type="checkbox"/>
1	default	00-02-06-12-34-56	1	11	Secured_Permanent	<input type="checkbox"/>
1	default	00-02-a5-9a-f5-61	1	11	Secured_Permanent	<input type="checkbox"/>
1	default	00-03-09-18-10-01	1	11	Secured_Permanent	<input type="checkbox"/>
1	default	00-04-13-04-03-01	1	11	Secured_Permanent	<input type="checkbox"/>
1	default	00-05-5d-ed-84-ea	1	11	Secured_Permanent	<input type="checkbox"/>
1	default	00-06-01-01-01-00	1	11	Secured_Permanent	<input type="checkbox"/>
1	default	00-08-02-54-0e-9d	1	11	Secured_Permanent	<input type="checkbox"/>
1	default	00-08-02-54-0f-ce	1	11	Secured_Permanent	<input type="checkbox"/>
1	default	00-0c-6e-12-e1-1a	1	11	Secured_Permanent	<input type="checkbox"/>
1	default	00-0c-6e-1f-9c-aa	1	11	Secured_Permanent	<input type="checkbox"/>
1	default	00-0c-6e-35-90-ee	1	11	Secured_Permanent	<input type="checkbox"/>
1	default	00-0c-6e-d5-5b-f0	1	11	Secured_Permanent	<input type="checkbox"/>
1	default	00-0c-f8-20-90-01	1	11	Secured_Permanent	<input type="checkbox"/>
1	default	00-0c-f8-3e-e0-0d	1	11	Secured_Permanent	<input type="checkbox"/>
1	default	00-0c-f8-42-c0-01	1	11	Secured_Permanent	<input type="checkbox"/>
1	default	00-0c-f8-44-10-01	1	11	Secured_Permanent	<input type="checkbox"/>
1	default	00-0e-a6-01-d5-6c	1	11	Secured_Permanent	<input type="checkbox"/>
1	default	00-0e-a6-11-7c-5f	1	11	Secured_Permanent	<input type="checkbox"/>

Figure 6-40. Port Lock Entries Table

This function is only operable if the **Mode** in the **Port Security** window is selected as **Permanent** or **DeleteOnReset**, or in other words, only addresses that are permanently learned by the Switch can be deleted. Once the entry has been defined by entering the correct information into the window above, click the under the **Delete** heading of the corresponding MAC address to be deleted. Click the **Next** button to view the next page of entries listed in this table. This window displays the following information:

Parameter	Description
VID	The VLAN ID of the entry in the forwarding database table that has been permanently learned by the Switch.
VLAN NAME	The VLAN Name of the entry in the forwarding database table that has been permanently learned by the Switch.

MAC Address	The MAC address of the entry in the forwarding database table that has been permanently learned by the Switch.
Unit	The ID number of the Switch in the switch stack that has permanently learned the MAC address.
Port	The ID number of the port that has permanently learned the MAC address.
Type	The type of MAC address in the forwarding database table. Only entries marked Secured_Permanent can be deleted.
Delete	Click the  in this field to delete the corresponding MAC address that was permanently learned by the Switch.

QoS

The DES-6500 switch supports 802.1p priority queuing Quality of Service. The following section discusses the implementation of QoS (Quality of Service) and benefits of using 802.1p priority queuing.

The Advantages of QoS

QoS is an implementation of the IEEE 802.1p standard that allows network administrators a method of reserving bandwidth for important functions that require a large bandwidth or have a high priority, such as VoIP (voice-over Internet Protocol), web browsing applications, file server applications or video conferencing. Not only can a larger bandwidth be created, but other less critical traffic can be limited, so excessive bandwidth can be saved. The Switch has separate hardware queues on every physical port to which packets from various applications can be mapped to, and, in turn prioritized. View the following map to see how the DES-6500 switch implements basic 802.1P priority queuing.

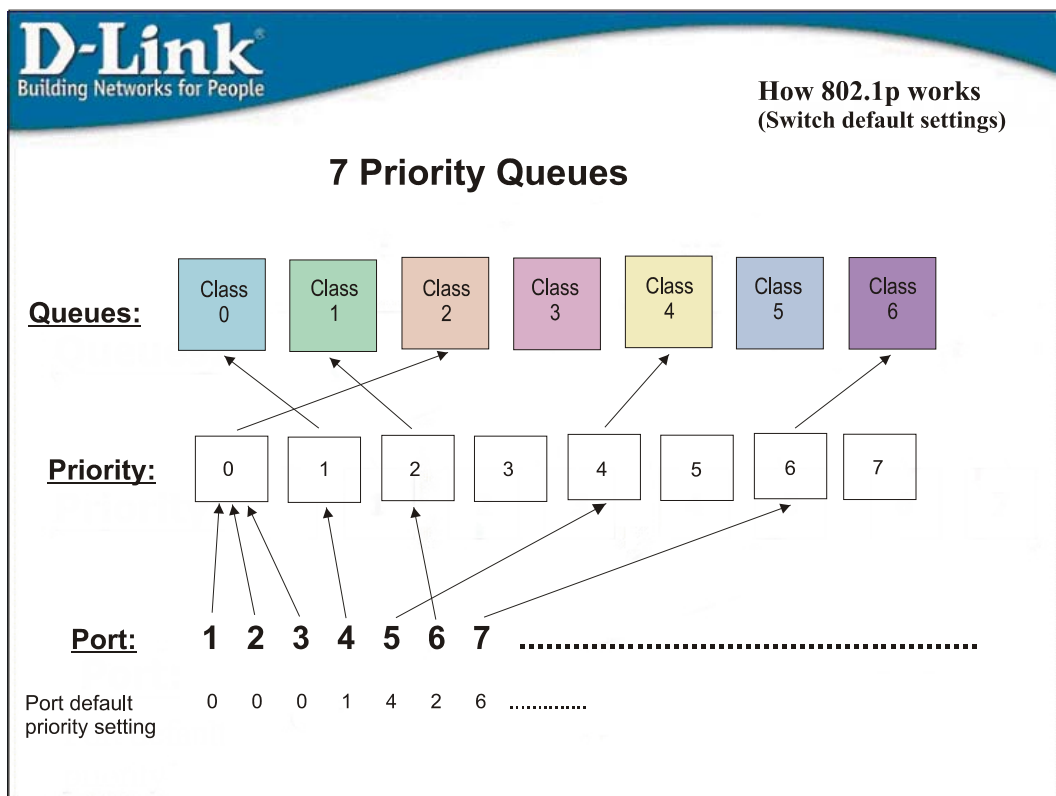

Figure 6- 41. An Example of the Default QoS Mapping on the Switch

The picture above shows the default priority setting for the Switch. Class-6 has the highest priority of the seven priority classes of service on the Switch. In order to implement QoS, the user is required to instruct the Switch to examine the header of a packet to see if it has the proper identifying tag. Then the user may forward these tagged packets to designated classes of service on the Switch where they will be emptied, based on priority.

For example, let's say a user wishes to have a video conference between two remotely set computers. The administrator can add priority tags to the video packets being sent out, utilizing the Access Profile commands. Then, on the receiving end, the administrator instructs the Switch to examine packets for this tag, acquires the tagged packets and maps them to a class queue on the Switch. Then in turn, the administrator will set a priority for this queue so that it will be emptied before any other packet is forwarded. This results in the end user receiving all packets sent as quickly as possible, thus prioritizing the queue and allowing for an uninterrupted stream of packets, which optimizes the use of bandwidth available for the video conference.

Understanding QoS

The Switch has eight priority classes of service, one of which is internal and not configurable. These priority classes of service are labeled as 6, the high class to 0, the lowest class. The eight priority tags, specified in IEEE 802.1p are mapped to the Switch's priority classes of service as follows:

- Priority 0 is assigned to the Switch's Q2 class.
- Priority 1 is assigned to the Switch's Q0 class.
- Priority 2 is assigned to the Switch's Q1 class.
- Priority 3 is assigned to the Switch's Q3 class.
- Priority 4 is assigned to the Switch's Q4 class.
- Priority 5 is assigned to the Switch's Q5 class.
- Priority 6 is assigned to the Switch's Q6 class.
- Priority 7 is assigned to the Switch's Q6 class.

For strict priority-based scheduling, any packets residing in the higher priority classes of service are transmitted first. Multiple strict priority classes of service are emptied based on their priority tags. Only when these classes are empty, are packets of lower priority transmitted.

For weighted round-robin queuing, the number of packets sent from each priority queue depends upon the assigned weight. For a configuration of 8 CoS queues, A~H with their respective weight value: 8~1, the packets are sent in the following sequence: A1, B1, C1, D1, E1, F1, G1, H1, A2, B2, C2, D2, E2, F2, G2, A3, B3, C3, D3, E3, F3, A4, B4, C4, D4, E4, A5, B5, C5, D5, A6, B6, C6, A7, B7, A8, A1, B1, C1, D1, E1, F1, G1, H1.

For weighted round-robin queuing, if each CoS queue has the same weight value, then each CoS queue has an equal opportunity to send packets just like round-robin queuing.

For weighted round-robin queuing, if the weight for a CoS is set to 0, then it will continue processing the packets from this CoS until there are no more packets for this CoS. The other CoS queues that have been given a nonzero value, and depending upon the weight, will follow a common weighted round-robin scheme.

Remember that the DES-6500 switch has 7 configurable priority queues (and seven Classes of Service) for each port on the Switch.



NOTICE: The Switch contains eight classes of service for each port on the Switch. One of these classes is reserved for internal use on the Switch and is therefore not configurable. All references in the following section regarding classes of service will refer to only the seven classes of service that may be used and configured by the Switch's Administrator.

Bandwidth Control

The bandwidth control settings are used to place a ceiling on the transmitting and receiving data rates for any selected port. In the **Configuration** folder, click **QoS > Bandwidth Control**, to view the screen shown below.

Bandwidth Settings						
Unit	From	To	Type	no_limit	Rate	Apply
1	Port 1	Port 1	Both	Disabled	1	Apply

Port Bandwidth Table		
Port	RX Rate (Mbit/sec)	TX Rate (Mbit/sec)
1	no_limit	no_limit
2	no_limit	no_limit
3	no_limit	no_limit
4	no_limit	no_limit
5	no_limit	no_limit
6	no_limit	no_limit
7	no_limit	no_limit
8	no_limit	no_limit
9	no_limit	no_limit
10	no_limit	no_limit
11	no_limit	no_limit
12	no_limit	no_limit

Figure 6- 42. Bandwidth Settings and Port Bandwidth Table window

The following parameters can be set or are displayed:

Parameter	Description
Unit	Choose the Switch ID number of the Switch in the switch stack to be modified.
From/To	A consecutive group of ports may be configured starting with the selected port.
Type	This drop-down menu allows you to select between <i>RX</i> (receive,) <i>TX</i> (transmit,) and <i>Both</i> . This setting will determine whether the bandwidth ceiling is applied to receiving, transmitting, or both receiving and transmitting packets.
No Limit	This drop-down menu allows you to specify that the selected port will have no bandwidth limit. <i>Enabled</i> disables the limit.
Rate	This field allows you to enter the data rate, in Mbit/s, that will be the limit for the selected port. The user may choose a rate between 1 and 999 Mbit/s.

Click **Apply** to set the bandwidth control for the selected ports. Results of configured **Bandwidth Settings** will be displayed in the **Port Bandwidth Table**.

QoS Scheduling Mechanism

This drop-down menu allows you to select between a **Weight Fair** and a **Strict** mechanism for emptying the priority classes. In the **Configuration** menu open the **QoS** folder and click **QoS Scheduling Mechanism**, to view the screen shown below.

QoS Scheduling Mechanism	
Scheduling Mechanism	Strict
Apply	
QoS Scheduling Mechanism Table	
Class ID	Mechanism
Class-0	Strict
Class-1	Strict
Class-2	Strict
Class-3	Strict
Class-4	Strict
Class-5	Strict
Class-6	Strict

Figure 6- 43. QoS Scheduling Mechanism and QoS Scheduling Mechanism Table window

The **Scheduling Mechanism** has the following parameters.

Parameter	Description
Strict	The highest class of service is the first to process traffic. That is, the highest class of service will finish before other queues empty.
Weight fair	Use the weighted round-robin (<i>WRR</i>) algorithm to handle packets in an even distribution in priority classes of service.

Click **Apply** to let your changes take effect.

QoS Output Scheduling

QoS can be customized by changing the output scheduling used for the hardware classes of service in the Switch. As with any changes to QoS implementation, careful consideration should be given to how network traffic in lower priority classes of service is affected. Changes in scheduling may result in unacceptable levels of packet loss or significant transmission delay. If you choose to customize this setting, it is important to monitor network performance, especially during peak demand, as bottlenecks can quickly develop if the QoS settings are not suitable. In the **Configuration** folder open the **QoS** folder and click **QoS Output Scheduling**, to view the screen shown below.

QoS Output Scheduling	
	Max. Packets
Class-0	1
Class-1	2
Class-2	3
Class-3	4
Class-4	5
Class-5	6
Class-6	7

Apply

Figure 6- 44. QoS Output Scheduling Configuration window

You may assign the following values to the QoS classes to set the scheduling.

Parameter	Description
Max. Packets	Specifies the maximum number of packets the above specified hardware priority class of service will be allowed to transmit before allowing the next lowest priority queue to transmit its packets. A value between 0 and 15 can be specified.

Click **Apply** to implement changes made.



NOTE: Entering a 0 for the **Max Packets** field in the **QoS Output Scheduling Configuration** window above will create a Combination Queue. For more information on implementation of this feature, see the next section, **Configuring the Combination Queue**.

Configuring the Combination Queue

Utilizing the **QoS Output Scheduling Configuration** window shown above, the DES-6500 switch can implement a combination queue for forwarding packets. This combination queue allows for a combination of strict and weight-fair (weighted round-robin “*WRR*”) scheduling for emptying given classes of service. To set the combination queue, enter a 0 for the Max Packets entry of the corresponding priority classes of service listed in the window above. Priority classes of service that have a 0 in the **Max Packet** field will forward packets with strict priority scheduling. The remaining classes of service, that do not have a 0 in their **Max Packet** field, will follow a weighted round-robin (*WRR*) method of forwarding packets — as long as the priority classes of service with a 0 in their **Max Packet** field are empty. When a packet arrives in a priority class with a 0 in its **Max Packet** field, this class of service will automatically begin forwarding packets until it is empty. Once a priority class of service with a 0 in its **Max Packet** field is empty, the remaining priority classes of service will reset the weighted round-robin (*WRR*) cycle of forwarding packets, starting with the highest available priority class of service. Priority classes of service with an equal level of priority and equal entries in their **Max Packet** field will empty their fields based on hardware priority scheduling. The **Max Packet** parameter allows you to specify the maximum number of packets a given priority class of service can transmit per weighted round-robin (*WRR*) scheduling cycle. This provides for a controllable CoS behavior while allowing other classes to empty as well. A value between 0 and 15 packets can be specified per priority class of service to create the combination queue.

The example window below displays an example of the combination queue where Class-1 will have a strict priority for emptying its class, while the other classes will follow a weight fair scheduling.

QoS Output Scheduling	
	Max. Packets
Class-0	<input type="text" value="1"/>
Class-1	<input type="text" value="0"/>
Class-2	<input type="text" value="3"/>
Class-3	<input type="text" value="4"/>
Class-4	<input type="text" value="5"/>
Class-5	<input type="text" value="6"/>
Class-6	<input type="text" value="7"/>

Figure 6- 45. QoS Output Scheduling window – Combination queue example

802.1p Default Priority

The Switch allows the assignment of a default 802.1p priority to each port on the Switch. In the **Configuration** folder open the **QoS** folder and click **802.1p Default Priority**, to view the screen shown below.

Port Default Priority assignment				
Unit	From	To	Priority(0~7)	Apply
<input type="text" value="1"/>	<input type="text" value="Port 1"/>	<input type="text" value="Port 1"/>	<input type="text" value="0"/>	<input type="button" value="Apply"/>

The Port Priority Table	
Port	Priority
1	0
2	0
3	0
4	0
5	0
6	0
7	0
8	0
9	0
10	0
11	0
12	0

Figure 6- 46. Port Default Priority assignment and The Port Priority Table window

This page allows you to assign a default 802.1p priority to any given port on the Switch. The priority tags are numbered from 0, the lowest priority, to 7, the highest priority. To implement a new default priority, choose the Switch of the Switch stack to be configured by using the **Unit** pull-down menu, choose a port range by using the **From** and **To** pull-down menus and then insert a priority value, from 0-7 in the **Priority** field. Click **Apply** to implement your settings.

802.1p User Priority

The DES-6500 switch allows the assignment of a class of service to each of the 802.1p priorities. In the **Configuration** folder open the **QoS** folder and click **802.1p User Priority**, to view the screen shown below.

User Priority Configuration	
Priority-0	Class-2
Priority-1	Class-0
Priority-2	Class-1
Priority-3	Class-3
Priority-4	Class-4
Priority-5	Class-5
Priority-6	Class-6
Priority-7	Class-6

Apply

Figure 6- 47. User Priority Configuration window

Once you have assigned a priority to the port groups on the Switch, you can then assign this Class to each of the eight levels of 802.1p priorities. Click **Apply** to set your changes.

Traffic Segmentation

Traffic segmentation is used to limit traffic flow from a single port to a group of ports on either a single Switch (in standalone mode) or a group of ports on another switch in a switch stack. This method of segmenting the flow of traffic is similar to using VLANs to limit traffic, but is more restrictive. It provides a method of directing traffic that does not increase the overhead of the Master switch CPU.

In the **Configuration** folder open the **QoS** folder and click **Traffic Segmentation**, to view the screen shown below.

Unit	Port Map
1	1-12
2	1-8
3	1-16
4	1-24
5	
6	
7	
8	

Figure 6- 48. Current Traffic Segmentation Table

Click on the **Setup** button to open the **Setup Forwarding ports** page, as shown below.

Unit	Port	Apply
1	Port 1	Apply

Setup Forwarding ports																								
Unit	1																							
Forward Port	1	2	3	4	5	6	7	8	9	10	11	12	13	14	15	16	17	18	19	20	21	22	23	24
	<input checked="" type="checkbox"/>	<input checked="" type="checkbox"/>	<input checked="" type="checkbox"/>	<input checked="" type="checkbox"/>	<input checked="" type="checkbox"/>	<input checked="" type="checkbox"/>	<input checked="" type="checkbox"/>	<input checked="" type="checkbox"/>	<input checked="" type="checkbox"/>	<input checked="" type="checkbox"/>	<input checked="" type="checkbox"/>	<input checked="" type="checkbox"/>	<input type="checkbox"/>	<input type="checkbox"/>	<input type="checkbox"/>	<input type="checkbox"/>	<input type="checkbox"/>	<input type="checkbox"/>	<input type="checkbox"/>	<input type="checkbox"/>	<input type="checkbox"/>	<input type="checkbox"/>	<input type="checkbox"/>	<input type="checkbox"/>
																								Apply
View Settings of Unit 1 Port 1																								

Figure 6-49. Setup Forwarding Ports window

This page allows you to determine which port on a given switch in a switch stack will be allowed to forward packets to other ports on that switch.

Configuring traffic segmentation on the DES-6500 switch is accomplished in two parts. First, you specify a switch from a switch stack by using the **Unit** pull-down menu, and then a port from that switch, using the **Port** pull-down menu. Then specify a second switch from the switch stack, and then you select which ports (or different ports on the same switch,) on that switch that you want to be able to receive packets from the switch and port you specified in the first part.

Clicking the **Apply** button will enter the combination of transmitting port and allowed receiving ports into the Switch's **Traffic Segmentation** table.

The **Unit** drop-down menu at the top of the page allows you to select a switch from a switch stack using that switch's Unit ID. The **Port** drop-down menu allows you to select a port from that switch. This is the port that will be transmitting packets.

The **Unit** drop-down menu under the Setup Forwarding ports heading allows you to select a switch from a switch stack using that switch's Unit ID. The **Forward Port** click boxes allow you to select which of the ports on the selected switch will be able to forward packets. These ports will be allowed to receive packets from the port specified above.

Click **Apply** to enter the settings into the Switch's **Traffic Segmentation** table.

Clicking the **Apply** button will enter the combination of transmitting port and allowed receiving ports into the Switch's **Traffic Segmentation Table**.

System Log Server

The Switch can send Syslog messages to up to four designated servers using the **System Log Host** window. In the **Configuration** folder, click **System Log Host**, to view the screen shown below.

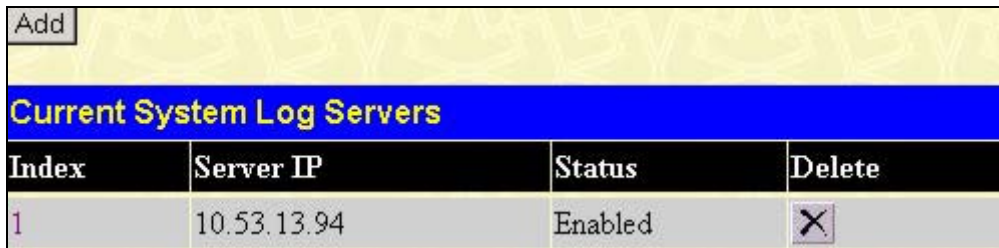

Current System Log Servers			
Index	Server IP	Status	Delete
1	10.53.13.94	Enabled	X

Figure 6- 50. System Log Host window

The parameters configured for adding and editing **System Log Server** settings are the same. To add a new Syslog Server, click the **Add** button. To modify a current entry, click the hyperlinked number of the server in the **Index** field. Both actions will result in the same screen to configure. See the table below for a description of the parameters in the following window.

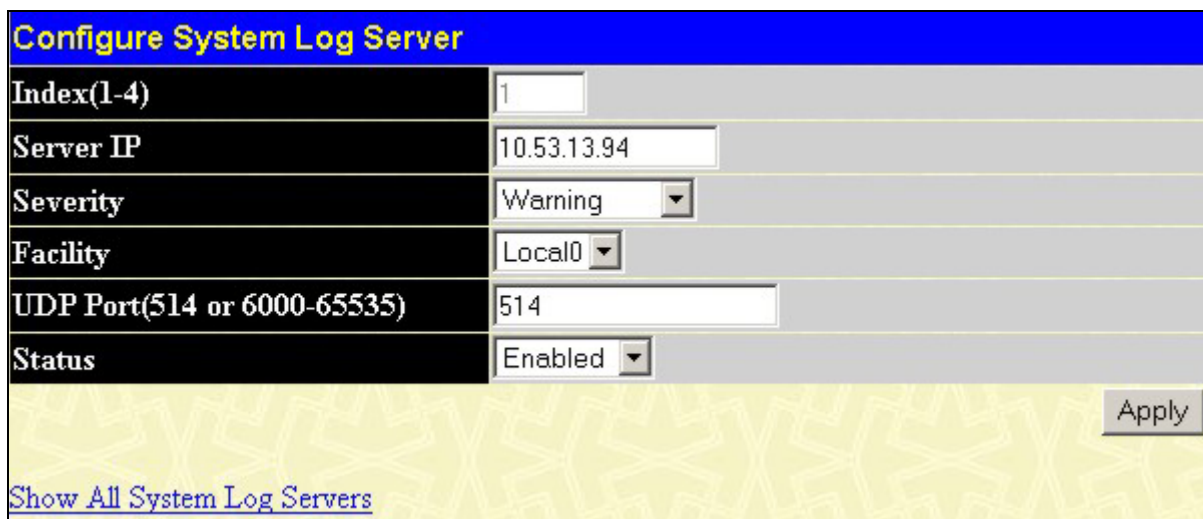

Configure System Log Server	
Index(1-4)	1
Server IP	10.53.13.94
Severity	Warning
Facility	Local0
UDP Port(514 or 6000-65535)	514
Status	Enabled
Apply	
Show All System Log Servers	

Figure 6- 51. Configure System Log Server - Edit

The following parameters can be set:

Parameter	Description
Index	Syslog server settings index (1-4).
Server IP	The IP address of the Syslog server.
Severity	This drop-down menu allows you to select the level of messages that will be sent. The options are <i>Warning</i> , <i>Informational</i> , and <i>All</i> .
Facility	Some of the operating system daemons and processes have been assigned Facility values. Processes and daemons that have not been explicitly assigned a Facility may use any of the "local use" facilities or they may use the "user-level" Facility. Those Facilities that have been designated are shown in the following. Bold font denotes the facility values that the Switch currently implements. Numerical Facility Code 0 kernel messages 1 user-level messages

	2	mail system
	3	system daemons
	4	security/authorization messages
	5	messages generated internally by syslog line printer subsystem
	7	network news subsystem
	8	UUCP subsystem
	9	clock daemon
	10	security/authorization messages
	11	FTP daemon
	12	NTP subsystem
	13	log audit
	14	log alert
	15	clock daemon
	16	local use 0 (local0)
	17	local use 1 (local1)
	18	local use 2 (local2)
	19	local use 3 (local3)
	20	local use 4 (local4)
	21	local use 5 (local5)
	22	local use 6 (local6)
	23	local use 7 (local7)
UDP Port (514 or 6000-65535)	Enter the UDP port number used for sending Syslog messages. The default is 514.	
Status	Choose <i>Enabled</i> or <i>Disabled</i> to activate or deactivate.	

To set the System Log Server configuration, click **Apply**. To delete an entry from the **Current System Log Server** window, click the corresponding  under the **Delete** heading of the entry to delete. To return to the **Current System Log Servers** window, click the [Show All System Log Servers](#) link.

System Severity Log

The **System Severity Log** allows users to configure where and when events occurring on the Switch will be recorded. These events are classified by the Switch into the following three categories:

- **Information** – Events classified as information are basic events occurring on the Switch that are not deemed as problematic, such as enabling or disabling various functions on the Switch. This is the lowest severity level.
- **Warning** - Events classified as warning are problematic events that are not critical to the overall function of the Switch but do require attention, such as unsuccessful downloads or uploads and failed logins. This level is regarded as a mid-level warning.
- **Critical** – Events classified as critical are fatal exceptions occurring on the Switch, such as hardware failures or spoofing attacks. This level is regarded as the highest severity level.

When an event occurs, the Switch classifies it into one of these three categories. If the severity of the event is higher than the level configured, the Switch will send a message to the SNMP trap, the Switch's log or both, depending on user configuration. If the event classified as lower than the configured severity level, the message is regarded as unimportant and will be discarded.

To configure the system severity levels, open the following window by clicking **Configuration > System Severity Log** in the main menu.

Figure 6- 52. System Severity Log Configurations window

The user may set the following parameters to configure the **System Severity**. Configurations will be displayed in the **System Severity Table**. Click **Apply** to implement changes made.

Parameter	Description
System Severity Log	<p>Choose one of the following to identify what type of severity warnings are to be sent to the switch log file.</p> <ul style="list-style-type: none"> <i>critical</i> – Entering this parameter along with the proper destination, stated above, will instruct the Switch to send only critical events to the Switch’s log or SNMP agent. <i>warning</i> – Entering this parameter along with the proper destination, stated above, will instruct the Switch to send critical and warning events to the Switch’s log and/or SNMP agent. <i>information</i> – Entering this parameter along with the proper destination, stated above, will instruct the Switch to send informational, warning and critical events to the Switch’s log and/or SNMP agent.
System Severity Trap	<p>Choose one of the following to identify what type of severity warnings are to be sent to the SNMP trap.</p> <ul style="list-style-type: none"> <i>critical</i> – Entering this parameter along with the proper destination, stated above, will instruct the Switch to send only critical events to the Switch’s log or SNMP agent. <i>warning</i> – Entering this parameter along with the proper destination, stated above, will instruct the Switch to send critical and warning events to the Switch’s log and/or SNMP agent. <i>information</i> – Entering this parameter along with the proper destination, stated above, will instruct the Switch to send informational, warning and critical events to the Switch’s log and/or SNMP agent.

SNTP Settings

Time Settings

To configure the time settings for the Switch, open the **Configuration** folder, then the **SNTP** folder and click on the **Time Settings** link, revealing the following screen for the user to configure.

Current Time: Status	
System Boot Time	19 Apr 2005 09:15:27
Time Source	System Clock
Current Time: SNTP Settings	
SNTP State	Disabled ▾
SNTP Primary Server	0.0.0.0
SNTP Secondary Server	0.0.0.0
SNTP Poll Interval in Seconds	720
Current Time: Set Current Time	
Year	2005 ▾
Month	April ▾
Day	19 ▾
Time in HH MM SS	16 ▾ 43 ▾ 58 ▾
Apply	

Figure 6- 53. Current Time Settings window

The following parameters can be set or are displayed:

Parameter	Description
Time Settings - Current Time	
System Boot Time	Displays the time when the Switch was initially started for this session.
Current Time	Displays the current time.
Time Source	Displays the source of the time settings viewed here.
SNTP Settings	
SNTP State	Use this pull-down menu to Enable or Disable SNTP.
SNTP Primary Server	The IP address of the primary server the SNTP information will be taken from.
SNTP Secondary Server	The IP address of the secondary server the SNTP information will be taken from.
SNTP Poll Interval in Seconds (30-99999)	The interval, in seconds, between requests for updated SNTP information.

Time Settings - Set Current Time	
Year	Enter the current year, if you want to update the system clock.
Month	Enter the current month, if you would like to update the system clock.
Day	Enter the current day, if you would like to update the system clock.
Time in HH MM SS	Enter the current time in hours and minutes, if you would like to update the system clock.

Click **Apply** to implement your changes.

Time Zone and DST

The following are screens used to configure time zones and Daylight Savings time settings for SNTP. Open the **Configuration** folder, then the **SNTP** folder and click on the **Time Zone and DST** link, revealing the following screen.

Time Zone and DST Settings	
Daylight Saving Time State	Disabled ▾
Daylight Saving Time Offset in Minutes	60 ▾
Time Zone Offset from GMT in +/-HH.MM	+ ▾ 00 ▾ 00 ▾
DST Repeating Settings	
From:Which Day	First ▾
From:Day of Week	Sunday ▾
From:Month	April ▾
From:time in HH MM	00 ▾ 00 ▾
To:Which Day	Last ▾
To:Day of Week	Sunday ▾
To:Month	October ▾
To:time in HH MM	00 ▾ 00 ▾
DST Annual Settings	
From:Month	April ▾
From:Day	29 ▾
From:time in HH MM	00 ▾ 00 ▾
To:Month	October ▾
To:Day	12 ▾
To:Time in HH MM	00 ▾ 00 ▾
Apply	

Figure 6- 54. Time Zone and DST Settings page

The following parameters can be set:

Parameter	Description
Time Zone and DST	
Daylight Saving Time State	Use this pull-down menu to Enable or Disable the DST Settings.
Daylight Saving Time Offset in Minutes	Use this pull-down menu to specify the amount of time that will constitute your local DST offset - 30, 60, 90, or 120 minutes.
Time Zone Offset from GMT in +/- HH:MM	Use these pull-down menus to specify your local time zone's offset from Greenwich Mean Time (GMT.)
DST Repeating Settings	
Using repeating mode will enable DST seasonal time adjustment. Repeating mode requires that the DST beginning and ending date be specified using a formula. For example, specify to begin DST on Saturday during the second week of April and end DST on Sunday during the last week of October.	
From: Which Day	Enter the week of the month that DST will start.
From: Day of Week	Enter the day of the week that DST will start on.
From: Month	Enter the month DST will start on.
From: Time in HH:MM	Enter the time of day that DST will start on.
To: Which Day	Enter the week of the month the DST will end.
To: Day of Week	Enter the day of the week that DST will end.
To: Month	Enter the month that DST will end.
To: time in HH:MM	Enter the time DST will end.
DST Annual Settings	
Using annual mode will enable DST seasonal time adjustment. Annual mode requires that the DST beginning and ending date be specified concisely. For example, specify to begin DST on April 3 and end DST on October 14.	
From: Month	Enter the month DST will start on, each year.
From: Day	Enter the day of the month DST will start on, each year.
From: Time in HH:MM	Enter the time of day DST will start on, each year.
To: Month	Enter the month DST will end on, each year.
To: Day	Enter the day of the month DST will end on, each year.
To: Time in HH:MM	Enter the time of day that DST will end on, each year.

Click **Apply** to implement changes made to the **Time Zone and DST** window.

Access Profile Table

Configuring the Access Profile Table

Access profiles allow you to establish criteria to determine whether the Switch will forward packets based on the information contained in each packet's header. These criteria can be specified on a basis of VLAN, MAC address or IP address.

Creating an access profile is divided into two basic parts. The first is to specify which part or parts of a frame the Switch will examine, such as the MAC source address or the IP destination address. The second part is entering the criteria the Switch will use to determine what to do with the frame. The entire process is described below in two parts.

To display the currently configured Access Profiles on the Switch, open the **Configuration** folder and click on the **Access Profile Table** link. This will open the **Access Profile Table** page, as shown below.

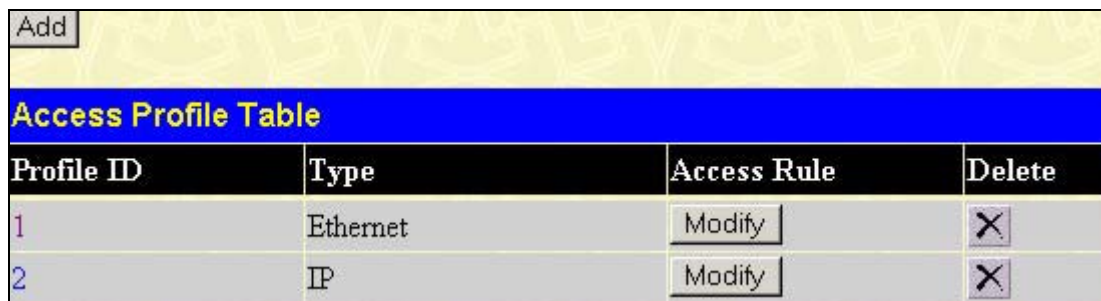

Profile ID	Type	Access Rule	Delete
1	Ethernet	Modify	X
2	IP	Modify	X

Figure 6- 55. Access Profile Table

To add an entry to the **Access Profile Table**, click the **Add** button. This will open the **Access Profile Configuration** page, as shown below. There are three **Access Profile Configuration** pages; one for **Ethernet** (or MAC address-based) profile configuration, one for **IP** address-based profile configuration and one for the **Packet Content Mask**. You can switch between the three **Access Profile Configuration** pages by using the **Type** drop-down menu. The page shown below is the **Ethernet Access Profile Configuration** page.

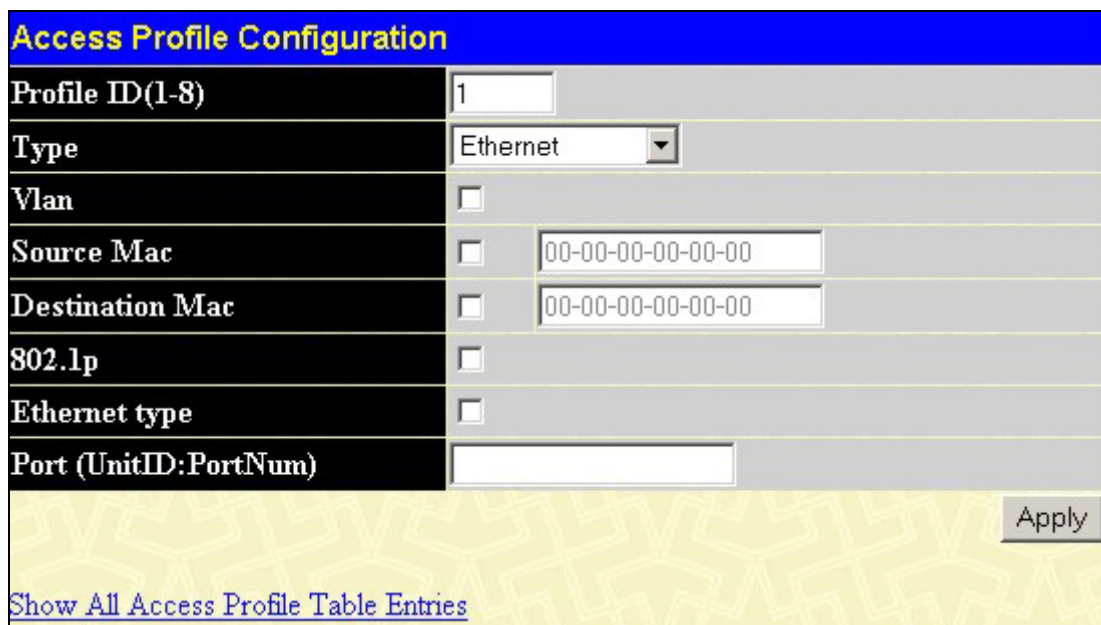

Profile ID(1-8)	1
Type	Ethernet
Vlan	<input type="checkbox"/>
Source Mac	<input type="checkbox"/> 00-00-00-00-00-00
Destination Mac	<input type="checkbox"/> 00-00-00-00-00-00
802.1p	<input type="checkbox"/>
Ethernet type	<input type="checkbox"/>
Port (UnitID:PortNum)	

Apply

[Show All Access Profile Table Entries](#)

Figure 6- 56. Access Profile Configuration (Ethernet)

The following parameters can be set, for the **Ethernet** type:

Parameter	Description
Profile ID (1-8)	Type in a unique identifier number for this profile set. This value can be set from 1 - 8.
Type	Select profile based on Ethernet (MAC Address), IP address or packet content mask. This will change the menu according to the requirements for the type of profile. <ul style="list-style-type: none"> Select <i>Ethernet</i> to instruct the Switch to examine the layer 2 part of each packet header. Select <i>IP</i> to instruct the Switch to examine the IP address in each frame's header. Select <i>Packet Content Mask</i> to specify a mask to hide the content of the packet header.
VLAN	Selecting this option instructs the Switch to examine the VLAN identifier of each packet header and use this as the full or partial criterion for forwarding.
Source MAC	Source MAC Mask - Enter a MAC address mask for the source MAC address.
Destination MAC	Destination MAC Mask - Enter a MAC address mask for the destination MAC address.
802.1p	Selecting this option instructs the Switch to examine the 802.1p priority value of each packet header and use this as the, or part of the criterion for forwarding.
Ethernet type	Selecting this option instructs the Switch to examine the Ethernet type value in each frame's header.
Port	The Access Profile Configuration may be configured on a per-port basis. The port list is specified by listing the lowest slot number and the beginning port number on that slot, separated by a colon. Then the highest slot number, and the highest port number of the range (also separated by a colon) are specified. The beginning and end of the port list range are separated by a dash. For example, 1:3 specifies slot number 1, port 3. 2:4 specifies slot number 2, port 4. 1:3-2:4 specifies all of the ports between slot 1, port 3 and slot 2, port 4 – in numerical order.

The page shown below is the **IP Access Profile Configuration** page.

Access Profile Configuration	
Profile ID(1-8)	<input type="text" value="1"/>
Type	<input type="text" value="IP"/>
Vlan	<input type="checkbox"/>
Source IP Mask	<input type="checkbox"/> <input type="text" value="0.0.0.0"/>
Destination IP Mask	<input type="checkbox"/> <input type="text" value="0.0.0.0"/>
Dscp	<input type="checkbox"/>
Protocol	<input type="checkbox"/> <input checked="" type="radio"/> ICMP <input type="checkbox"/> type <input type="checkbox"/> code <input type="checkbox"/> <input type="radio"/> IGMP <input type="checkbox"/> type <input type="checkbox"/> <input type="radio"/> TCP <input type="checkbox"/> src port mask <input type="text" value="0000"/> <input type="checkbox"/> dest port mask <input type="text" value="0000"/> <input type="checkbox"/> flag mask bit <input type="checkbox"/> urg <input type="checkbox"/> ack <input type="checkbox"/> psh <input type="checkbox"/> rst <input type="checkbox"/> syn <input type="checkbox"/> fin <input type="checkbox"/> <input type="radio"/> UDP <input type="checkbox"/> src port mask <input type="text" value="0000"/> <input type="checkbox"/> dest port mask <input type="text" value="0000"/> <input type="checkbox"/> <input type="radio"/> protocol id <input type="checkbox"/> user mask <input type="text" value="00000000"/>
Port (UnitID:PortNum)	<input type="text"/>
<input type="button" value="Apply"/>	
Show All Access Profile Table Entries	

Figure 6- 57. Access Profile Configuration (IP)

The following parameters can be set, for **IP**:

Parameter	Description
Profile ID (1-8)	Type in a unique identifier number for this profile set. This value can be set from 1 - 8.
Type	<p>Select profile based on Ethernet (MAC Address), IP address or Packet Content Mask. This will change the menu according to the requirements for the type of profile.</p> <ul style="list-style-type: none"> Select <i>Ethernet</i> to instruct the Switch to examine the layer 2 part of each packet header. Select <i>IP</i> to instruct the Switch to examine the IP address in each frame's header. Select <i>Packet Content Mask</i> to specify a mask to hide the content of the packet header.
VLAN	Selecting this option instructs the Switch to examine the VLAN part of each packet header and use this as the, or part of the criterion for forwarding.
Source IP Mask	Enter an IP address mask for the source IP address.

Destination IP Mask	Enter an IP address mask for the destination IP address.
DSCP	Selecting this option instructs the Switch to examine the DiffServ Code part of each packet header and use this as the, or part of the criterion for forwarding.
Protocol	<p>Selecting this option instructs the Switch to examine the protocol type value in each frame's header. You must then specify what protocol(s) to include according to the following guidelines:</p> <p>Select ICMP to instruct the Switch to examine the Internet Control Message Protocol (ICMP) field in each frame's header.</p> <ul style="list-style-type: none"> Select Type to further specify that the access profile will apply an ICMP type value, or specify Code to further specify that the access profile will apply an ICMP code value. <p>Select IGMP to instruct the Switch to examine the Internet Group Management Protocol (IGMP) field in each frame's header.</p> <ul style="list-style-type: none"> Select Type to further specify that the access profile will apply an IGMP type value <p>Select TCP to use the TCP port number contained in an incoming packet as the forwarding criterion. Selecting TCP requires that you specify a source port mask and/or a destination port mask. The user may also identify which flag bits to filter. Flag bits are parts of a packet that determine what to do with the packet. The user may filter packets by filtering certain flag bits within the packets, by checking the boxes corresponding to the flag bits of the TCP field. The user may choose between urg (urgent), ack (acknowledgement), psh (push), rst (reset), syn (synchronize), fin (finish).</p> <ul style="list-style-type: none"> src port mask - Specify a TCP port mask for the source port in hex form (hex 0x0-0xffff), which you wish to filter. dest port mask - Specify a TCP port mask for the destination port in hex form (hex 0x0-0xffff) which you wish to filter. <p>Select UDP to use the UDP port number contained in an incoming packet as the forwarding criterion. Selecting UDP requires that you specify a source port mask and/or a destination port mask.</p> <ul style="list-style-type: none"> src port mask - Specify a TCP port mask for the source port in hex form (hex 0x0-0xffff). dest port mask - Specify a TCP port mask for the destination port in hex form (hex 0x0-0xffff). <p>protocol id - Enter a value defining the protocol ID in the packet header to mask. Specify the protocol ID mask in hex form (hex 0x0-0xffffffff).</p>
Port	The Access Profile Configuration may be configured on a per-port basis. The port list is specified by listing the lowest slot number and the beginning port number on that slot, separated by a colon. Then the highest slot number, and the highest port number of the range (also separated by a colon) are specified. The beginning and end of the port list range are separated by a dash. For example, 1:3 specifies slot number 1, port 3. 2:4 specifies slot number 2, port 4. 1:3-2:4 specifies all of the ports between slot 1, port 3 and slot 2, port 4 – in numerical order.

The page shown below is the **Packet Content Mask** configuration window.

Figure 6- 58. Access Profile Configuration window (Packet Content Mask)

This screen will aid the user in configuring the Switch to mask packet headers beginning with the offset value specified. The following fields are used to configure the **Packet Content Mask**:

Parameter	Description
Profile ID (1-8)	Type in a unique identifier number for this profile set. This value can be set from 1 - 8.
Type	Select profile based on Ethernet (MAC Address), IP address or packet content. This will change the menu according to the requirements for the type of profile. <ul style="list-style-type: none"> Select <i>Ethernet</i> to instruct the Switch to examine the layer 2 part of each packet header. Select <i>IP</i> to instruct the Switch to examine the IP address in each frame's header. Select <i>Packet Content Mask</i> to specify a mask to hide the content of the packet header.
Offset	This field will instruct the Switch to mask the packet header beginning with the offset value specified: <ul style="list-style-type: none"> <i>value (0-15)</i> - Enter a value in hex form to mask the packet from the beginning of the packet to the 15th byte. <i>value (16-31)</i> – Enter a value in hex form to mask the packet from byte 16 to byte 31. <i>value (32-47)</i> – Enter a value in hex form to mask the packet from byte 32 to byte 47. <i>value (48-63)</i> – Enter a value in hex form to mask the packet from byte 48 to byte 63. <i>value (64-79)</i> – Enter a value in hex form to mask the packet from byte 64 to byte 79.
Port	The Access Profile Configuration may be configured on a per-port basis. The port list is specified by listing the lowest slot number and the beginning port number on that slot, separated by a colon. Then the highest slot number, and the highest port number of the range (also separated by a colon) are specified. The beginning and end of the port list range are separated by a dash. For example, 1:3 specifies slot number 1, port 3. 2:4 specifies slot number 2, port 4. 1:3-2:4 specifies all of the ports between slot 1, port 3 and slot 2, port 4 – in numerical order.

Click **Apply** to implement changes made.

To establish the rule for a previously created Access Profile:

In the **Configuration** folder, click the **Access Profile Table** link opening the **Access Profile Table**. Under the heading **Access Rule**, clicking **Modify**, will open the following window.

Profile ID	Mode	Type	Access ID	Display	Delete
2	Permit	IP	1	View	

[Add](#)

[Show All Access Profile Entries](#)

Figure 6- 59. Access Rule Table window – IP

To create a new rule set for an access profile click the **Add** button. A new window is displayed. To remove a previously created rule, click the corresponding button.

Access Rule Configuration	
Profile ID	2
Mode	<input checked="" type="radio"/> Permit <input type="radio"/> Deny
Access ID	<input type="text" value="1"/>
Type	IP
Priority(0-7)	<input type="checkbox"/> <input type="text" value="0"/> <input type="checkbox"/> replace priority
Replace Dscp(0-63)	<input type="checkbox"/> <input type="text" value="0"/>
Vlan Name	<input type="text"/>
Source IP	<input type="text" value="0.0.0.0"/>
Destination IP	<input type="text" value="0.0.0.0"/>
Dscp(0-63)	<input type="text" value="0"/>
Protocol	Protocol id <input type="text" value="0"/> user define <input type="text" value="00000000"/>

[Show All Access Rule Entries](#)

[Apply](#)

Figure 6- 60. Access Rule Configuration window (IP)

Configure the following **Access Rule Configuration** settings for IP:

Parameter	Description
Profile ID	This is the identifier number for this profile set.
Mode	Select Permit to specify that the packets that match the access profile are forwarded by the Switch, according to any additional rule added (see below). Select Deny to specify that packets that do not match the access profile are not forwarded by the Switch and will be filtered.
Access ID	Type in a unique identifier number for this access. This value can be set from 1 - 100.

Type	<p>Selected profile based on Ethernet (MAC Address), IP address or Packet Content Mask.</p> <ul style="list-style-type: none"> • <i>Ethernet</i> instructs the Switch to examine the layer 2 part of each packet header. • <i>IP</i> instructs the Switch to examine the IP address in each frame's header. • <i>Packet Content Mask</i> instructs the Switch to examine the packet header.
Priority (0-7)	<p>This parameter is specified if you want to re-write the 802.1p default priority previously set in the Switch, which is used to determine the CoS queue to which packets are forwarded to. Once this field is specified, packets accepted by the Switch that match this priority are forwarded to the CoS queue specified previously by the user.</p> <p><i>Replace priority with</i> – Click the corresponding box if you want to re-write the 802.1p default priority of a packet to the value entered in the Priority field, which meets the criteria specified previously in this command, before forwarding it on to the specified CoS queue. Otherwise, a packet will have its incoming 802.1p user priority re-written to its original value before being forwarded by the Switch.</p> <p>For more information on priority queues, CoS queues and mapping for 802.1p, see the QoS section of this manual.</p>
Replace Dscp (0-63)	Select this option to instruct the Switch to replace the DSCP value (in a packet that meets the selected criteria) with the value entered in the adjacent field.
VLAN Name	Allows the entry of a name for a previously configured VLAN.
Source IP	Source IP Address - Enter an IP Address mask for the source IP address.
Destination IP	Destination IP Address- Enter an IP Address mask for the destination IP address.
Dscp (0-63)	This field allows the user to enter a DSCP value in the space provided, which will instruct the Switch to examine the DiffServ Code part of each packet header and use this as the, or part of the criterion for forwarding. The user may choose a value between 0 and 63.
Protocol	This field allows the user to modify the protocol used to configure the Access Rule Table ; depending on which protocol the user has chosen in the Access Profile Table .

To view the settings of a previously correctly configured rule, click  in the **Access Rule Table** to view the following screen:

Access Rule Display	
Profile ID	2
Access ID	1
Mode	Permit
Type	IP
Priority	-----
Replace Dscp	-----
Vlan Name	-----
Source IP	-----
Destination IP	-----
Dscp	-----
Protocol	-----
Show All Access Rule Entries	

Figure 6- 61. Access Rule Display window (IP)

To configure the **Access Rule for Ethernet**, open the **Access Profile Table** and click **Modify** for an Ethernet entry. This will open the following screen:

Access Rule Table					
Profile ID	Mode	Type	Access ID	Display	Delete
1	Permit	Ethernet	1	View	<input type="button" value="X"/>
Show All Access Profile Entries					

Figure 6- 62. Access Rule Table

To remove a previously created rule, select it and click the button. To add a new Access Rule, click the **Add** button:

Access Rule Configuration	
Profile ID	1
Mode	<input checked="" type="radio"/> Permit <input type="radio"/> Deny
Access ID	1
Type	Ethernet
Priority(0-7)	<input type="checkbox"/> 0 <input type="checkbox"/> replace priority
Vlan Name	
Source Mac	00-00-00-00-00-00
Destination Mac	00-00-00-00-00-00
802.1p(0-7)	0
Ethernet Type	0000
<input type="button" value="Apply"/>	
Show All Access Rule Entries	

Figure 6- 63. Access Rule Configuration window - Ethernet.

To set the Access Rule for Ethernet, adjust the following parameters and click **Apply**.

Parameters	Description
Profile ID	This is the identifier number for this profile set.
Mode	Select Permit to specify that the packets that match the access profile are forwarded by the Switch, according to any additional rule added (see below). Select Deny to specify that packets that do not match the access profile are not forwarded by the Switch and will be filtered.
Access ID	Type in a unique identifier number for this access. This value can be set from 1 - 100.
Type	Selected profile based on Ethernet (MAC Address), IP address or Packet Content Mask. <ul style="list-style-type: none"> <i>Ethernet</i> instructs the Switch to examine the layer 2 part of each packet header. <i>IP</i> instructs the Switch to examine the IP address in each frame's header. <i>Packet Content Mask</i> instructs the Switch to examine the packet header.
Priority (0-7)	This parameter is specified if you want to re-write the 802.1p default priority previously set in the Switch, which is used to determine the CoS queue to which packets are forwarded to. Once this field is specified, packets accepted by the Switch that match this priority are forwarded to the CoS queue specified previously by the user. <i>replace priority</i> – Click the corresponding box if you want to re-write the 802.1p default priority of a packet to the value entered in the Priority field, which meets the criteria specified previously in this command, before forwarding it on to the specified CoS queue. Otherwise, a packet will have its incoming 802.1p user priority re-written to its original value before being forwarded by the Switch. For more information on priority queues, CoS queues and mapping for 802.1p, see the QoS section of this manual.
VLAN Name	Allows the entry of a name for a previously configured VLAN.

Source MAC	Source MAC Address - Enter a MAC Address for the source MAC address.
Destination MAC	Destination MAC Address - Enter a MAC Address mask for the destination MAC address.
802.1p (0-7)	Enter a value from 0-7 to specify that the access profile will apply only to packets with this 802.1p priority value.
Ethernet Type	Specifies that the access profile will apply only to packets with this hexadecimal 802.1Q Ethernet type value (hex 0x0-0xffff) in the packet header. The Ethernet type value may be set in the form: hex 0x0-0xffff, which means the user may choose any combination of letters and numbers ranging from a-f and from 0-9999.

To view the settings of a previously correctly configured rule, click  in the **Access Rule Table** to view the following screen:

Access Rule Display	
Profile ID	1
Access ID	1
Mode	Permit
Type	Ethernet
Priority	-----
Replace Dscp	-----
Vlan Name	-----
Source Mac	-----
Destination Mac	-----
802.1p	-----
Ethernet Type	-----
Show All Access Rule Entries	

Figure 6- 64. Access Rule Display window (Ethernet)

To configure the Access Rule for **Packet Content Mask**, open the **Access Profile Table** and click **Modify** for a **Packet Content Mask** entry. This will open the following screen:

Access Rule Table					
Profile ID	Mode	Type	Access ID	Display	Delete
4	Permit	Packet Content	1	View	
Show All Access Profile Entries					

Figure 6- 65. Access Rule Table (Packet Content Mask)

To remove a previously created rule, select it and click the  button. To add a new Access Rule, click the **Add** button:

Access Rule Configuration	
Profile ID	5
Mode	<input checked="" type="radio"/> Permit <input type="radio"/> Deny
Access ID	1
Type	Packet Content
Priority(0-7)	<input type="checkbox"/> 0 <input type="checkbox"/> replace priority
Offset_0-15	<input type="checkbox"/> 00000000 00000000 00000000 00000000
Offset_16-31	<input type="checkbox"/> 00000000 00000000 00000000 00000000
Offset_32-47	<input type="checkbox"/> 00000000 00000000 00000000 00000000
Offset_48-63	<input type="checkbox"/> 00000000 00000000 00000000 00000000
Offset_64-79	<input type="checkbox"/> 00000000 00000000 00000000 00000000
<input type="button" value="Apply"/>	
Show All Access Rule Entries	

Figure 6- 66. Access Rule Configuration - Packet Content Mask

To set the Access Rule for the **Packet Content Mask**, adjust the following parameters and click **Apply**.

Parameter	Description
Profile ID	This is the identifier number for this profile set.
Mode	Select Permit to specify that the packets that match the access profile are forwarded by the Switch, according to any additional rule added (see below). Select Deny to specify that packets that do not match the access profile are not forwarded by the Switch and will be filtered.
Access ID	Type in a unique identifier number for this access. This value can be set from 1 - 100.
Type	Selected profile based on Ethernet (MAC Address), IP address or Packet Content Mask. <ul style="list-style-type: none"> <i>Ethernet</i> instructs the Switch to examine the layer 2 part of each packet header. <i>IP</i> instructs the Switch to examine the IP address in each frame's header. <i>Packet Content Mask</i> instructs the Switch to examine the packet header.
Priority	This parameter is specified if you want to re-write the 802.1p default priority previously set in the Switch, which is used to determine the CoS queue to which packets are forwarded to. Once this field is specified, packets accepted by the Switch that match this priority are forwarded to the CoS queue specified previously by the user. <i>replace priority</i> – Click the corresponding box if you want to re-write the 802.1p default priority of a packet to the value entered in the Priority field, which meets the criteria specified previously in this command, before forwarding it on to the specified CoS queue. Otherwise, a packet will have its incoming 802.1p user priority re-written to its original value before being forwarded by the Switch. For more information on priority queues, CoS queues and mapping for 802.1p, see the QoS section of this manual.

Offset	<p>This field will instruct the Switch to mask the packet header beginning with the offset value specified:</p> <ul style="list-style-type: none"> • <i>value (0-15)</i> - Enter a value in hex form to mask the packet from the beginning of the packet to the 15th byte. • <i>value (16-31)</i> - Enter a value in hex form to mask the packet from byte 16 to byte 31. • <i>value (32-47)</i> - Enter a value in hex form to mask the packet from byte 32 to byte 47. • <i>value (48-63)</i> - Enter a value in hex form to mask the packet from byte 48 to byte 63. • <i>value (64-79)</i> - Enter a value in hex form to mask the packet from byte 64 to byte 79.
---------------	---

To view the settings of a previously correctly configured rule, click [View](#) in the **Access Rule Table** to view the following screen:

Access Rule Display	
Profile ID	5
Access ID	10
Mode	Permit
Type	Packet Content
Priority	-----
Replace Dscp	-----
Vlan Name	-----
Offset 0-15	0x00000000 0x00000000 0x00000000 0x00000000
Offset 16-31	-----
Offset 32-47	-----
Offset 48-63	-----
Offset 64-79	-----
Show All Access Rule Entries	

Figure 6- 67. Access Rule Display window (Packet Content Mask)

CPU Interface Filtering

Due to a chipset limitation and needed extra switch security, the DES-6500 incorporates CPU Interface filtering. This added feature increases the running security of the Switch by enabling the user to create a list of access rules for packets destined for the Switch's CPU interface. Employed similarly to the Access Profile feature previously mentioned, CPU interface filtering examines Ethernet, IP and Packet Content Mask packet headers destined for the CPU and will either forward them or filter them, based on the user's implementation. As an added feature for the CPU Filtering, the DES-6500 allows the CPU filtering mechanism to be enabled or disabled globally, permitting the user to create various lists of rules without immediately enabling them.

Creating an access profile for the CPU is divided into two basic parts. The first is to specify which part or parts of a frame the Switch will examine, such as the MAC source address or the IP destination address. The second part is entering the criteria the Switch will use to determine what to do with the frame. The entire process is described below.

CPU Interface Filtering State Settings

In the following window, the user may globally enable or disable the CPU Interface Filtering mechanism by using the pull-down menu to change the running state. To access this window, click **Configuration > CPU Interface Filtering > CPU Interface Filtering State**. Choose **Enabled** to enable CPU packets to be scrutinized by the Switch and **Disabled** to disallow this scrutiny.



Figure 6- 68. CPU Interface Filtering State Settings window

CPU Interface Filtering Table

The **CPU Interface Filtering Table** displays the CPU Access Profile Table entries created on the Switch. To view the configurations for an entry, click the hyperlinked **Profile ID** number.

CPU Interface Filtering Table			
Profile ID	Type	Access Rule	Delete
1	Ethernet	Modify	X
2	IP	Modify	X
3	Packet Content	Modify	X

Figure 6- 69. CPU Interface Filtering Table

To add an entry to the **CPU Interface Filtering Table**, click the **Add** button. This will open the **CPU Interface Filtering Configuration** page, as shown below. There are three **Access Profile Configuration** pages; one for **Ethernet** (or MAC address-based) profile configuration, one for **IP** address-based profile configuration and one for the **Packet Content Mask**. You can switch between the three **Access Profile Configuration** pages by using the **Type** drop-down menu. The page shown below is the **Ethernet CPU Interface Filtering Configuration** page.

CPU Interface Filtering Configuration	
Profile ID(1-5)	1
Type	Ethernet
Vlan	<input type="checkbox"/>
Source Mac	<input type="checkbox"/> 00-00-00-00-00-00
Destination Mac	<input type="checkbox"/> 00-00-00-00-00-00
Ethernet type	<input type="checkbox"/>
Port (UnitID:PortNum)	
Apply	
Show All CPU Interface Filtering Table Entries	

Figure 6- 70. CPU Interface Filtering Configuration window – Ethernet

Parameter	Description
Profile ID (1-5)	Type in a unique identifier number for this profile set. This value can be set from 1 - 5.
Type	Select profile based on Ethernet (MAC Address), IP address or packet content mask. This will change the menu according to the requirements for the type of profile. <ul style="list-style-type: none"> Select <i>Ethernet</i> to instruct the Switch to examine the layer 2 part of each packet header. Select <i>IP</i> to instruct the Switch to examine the IP address in each frame's header. Select <i>Packet Content Mask</i> to specify a mask to hide the content of the packet header.
VLAN	Selecting this option instructs the Switch to examine the VLAN identifier of each packet header and use this as the full or partial criterion for forwarding.
Source MAC	Source MAC Mask - Enter a MAC address mask for the source MAC address.
Destination MAC	Destination MAC Mask - Enter a MAC address mask for the destination MAC address.
Ethernet type	Selecting this option instructs the Switch to examine the Ethernet type value in each frame's header.
Port	Specify a port or group of ports for this Access Profile. The port list is specified by listing the lowest slot number and the beginning port number on that slot, separated by a colon. Then the highest slot number, and the highest port number of the range (also separated by a colon) are specified. The beginning and end of the port list range are separated by a dash. For example, 1:3 specifies slot number 1, port 3. 2:4 specifies slot number 2, port 4. 1:3-2:4 specifies all of the ports between slot 1, port 3 and slot 2, port 4 – in numerical order.

Click **Apply** to set this entry in the Switch's memory.

The page shown below is the **IP Access Profile Configuration** page.

CPU Interface Filtering Configuration		
Profile ID(1-5)	<input type="text" value="1"/>	
Type	IP	
Vlan	<input type="checkbox"/>	
Source IP Mask	<input type="checkbox"/> <input type="text" value="0.0.0.0"/>	
Destination IP Mask	<input type="checkbox"/> <input type="text" value="0.0.0.0"/>	
Dscp	<input type="checkbox"/>	
Protocol	<input type="checkbox"/> <input checked="" type="radio"/> ICMP <input type="checkbox"/> type <input type="checkbox"/> code <input type="checkbox"/> IGMP <input type="checkbox"/> type <input type="checkbox"/> TCP <input type="checkbox"/> src port mask <input type="text" value="0000"/> <input type="checkbox"/> dest port mask <input type="text" value="0000"/> <input type="checkbox"/> flag mask bit <input type="checkbox"/> urg <input type="checkbox"/> ack <input type="checkbox"/> psh <input type="checkbox"/> rst <input type="checkbox"/> syn <input type="checkbox"/> fin <input type="checkbox"/> UDP <input type="checkbox"/> src port mask <input type="text" value="0000"/> <input type="checkbox"/> dest port mask <input type="text" value="0000"/> <input type="checkbox"/> protocol id <input type="checkbox"/> user mask <input type="text" value="00000000"/>	
Port (UnitID:PortNum)	<input type="text"/>	
<input type="button" value="Apply"/>		
Show All CPU Interface Filtering Table Entries		

Figure 6- 71. CPU Interface Filtering Configuration window- IP

Parameter	Description
Profile ID (1-5)	Type in a unique identifier number for this profile set. This value can be set from 1 - 5.
Type	<p>Select profile based on Ethernet (MAC Address), IP address or Packet Content Mask. This will change the menu according to the requirements for the type of profile.</p> <ul style="list-style-type: none"> Select <i>Ethernet</i> to instruct the Switch to examine the layer 2 part of each packet header. Select <i>IP</i> to instruct the Switch to examine the IP address in each frame's header. Select <i>Packet Content Mask</i> to specify a mask to hide the content of the packet header.
VLAN	Selecting this option instructs the Switch to examine the VLAN part of each packet header and use this as the, or part of the criterion for forwarding.
Source IP Mask	Enter an IP address mask for the source IP address.
Destination IP Mask	Enter an IP address mask for the destination IP address.
DSCP	Selecting this option instructs the Switch to examine the DiffServ Code part of each packet header and use this as the, or part of the criterion for forwarding.

Protocol	<p>Selecting this option instructs the Switch to examine the protocol type value in each frame's header. You must then specify what protocol(s) to include according to the following guidelines:</p> <p>Select ICMP to instruct the Switch to examine the Internet Control Message Protocol (ICMP) field in each frame's header.</p> <ul style="list-style-type: none"> Select Type to further specify that the access profile will apply an ICMP type value, or specify Code to further specify that the access profile will apply an ICMP code value. <p>Select IGMP to instruct the Switch to examine the Internet Group Management Protocol (IGMP) field in each frame's header.</p> <ul style="list-style-type: none"> Select Type to further specify that the access profile will apply an IGMP type value <p>Select TCP to use the TCP port number contained in an incoming packet as the forwarding criterion. Selecting TCP requires that you specify a source port mask and/or a destination port mask. The user may also identify which flag bits to filter. Flag bits are parts of a packet that determine what to do with the packet. The user may filter packets by filtering certain flag bits within the packets, by checking the boxes corresponding to the flag bits of the TCP field. The user may choose between urg (urgent), ack (acknowledgement), psh (push), rst (reset), syn (synchronize), fin (finish).</p> <ul style="list-style-type: none"> src port mask - Specify a TCP port mask for the source port in hex form (hex 0x0-0xffff), which you wish to filter. dest port mask - Specify a TCP port mask for the destination port in hex form (hex 0x0-0xffff) which you wish to filter. <p>Select UDP to use the UDP port number contained in an incoming packet as the forwarding criterion. Selecting UDP requires that you specify a source port mask and/or a destination port mask.</p> <ul style="list-style-type: none"> src port mask - Specify a TCP port mask for the source port in hex form (hex 0x0-0xffff). dest port mask - Specify a TCP port mask for the destination port in hex form (hex 0x0-0xffff). <p>protocol id - Enter a value defining the protocol ID in the packet header to mask. Specify the protocol ID mask in hex form (hex 0x0-0xffffffff).</p>
Port	<p>Specify a port or group of ports for this Access Profile. The port list is specified by listing the lowest slot number and the beginning port number on that slot, separated by a colon. Then the highest slot number, and the highest port number of the range (also separated by a colon) are specified. The beginning and end of the port list range are separated by a dash. For example, 1:3 specifies slot number 1, port 3. 2:4 specifies slot number 2, port 4. 1:3-2:4 specifies all of the ports between slot 1, port 3 and slot 2, port 4 – in numerical order.</p>

Click **Apply** to set this entry in the Switch's memory.

The page shown below is the **Packet Content Mask** configuration window.

CPU Interface Filtering Configuration

Profile ID(1-5)

Type

Offset_0-15

Offset_16-31

Offset_32-47

Offset_48-63

Offset_64-79

Port (UnitID:PortNum)

[Show All CPU Interface Filtering Table Entries](#)

Figure 6-72. CPU Interface Filtering Configuration window- Packet Content

This screen will aid the user in configuring the Switch to mask packet headers beginning with the offset value specified. The following fields are used to configure the **Packet Content Mask**:

Parameter	Description
Profile ID (1-5)	Type in a unique identifier number for this profile set. This value can be set from 1 - 5.
Type	Select profile based on Ethernet (MAC Address), IP address or packet content mask. This will change the menu according to the requirements for the type of profile. <ul style="list-style-type: none"> Select <i>Ethernet</i> to instruct the Switch to examine the layer 2 part of each packet header. Select <i>IP</i> to instruct the Switch to examine the IP address in each frame's header. Select <i>Packet Content Mask</i> to specify a mask to hide the content of the packet header.
Offset	This field will instruct the Switch to mask the packet header beginning with the offset value specified: <ul style="list-style-type: none"> <i>value (0-15)</i> - Enter a value in hex form to mask the packet from the beginning of the packet to the 15th byte. <i>value (16-31)</i> - Enter a value in hex form to mask the packet from byte 16 to byte 31. <i>value (32-47)</i> - Enter a value in hex form to mask the packet from byte 32 to byte 47. <i>value (48-63)</i> - Enter a value in hex form to mask the packet from byte 48 to byte 63. <i>value (64-79)</i> - Enter a value in hex form to mask the packet from byte 64 to byte 79.

Port	Specify a port or group of ports for this Access Profile. The port list is specified by listing the lowest slot number and the beginning port number on that slot, separated by a colon. Then the highest slot number, and the highest port number of the port list range (also separated by a colon) are specified. The beginning and end of the port list range are separated by a dash. For example, 1:3 specifies slot number 1, port 3. 2:4 specifies slot number 2, port 4. 1:3-2:4 specifies all of the ports between slot 1, port 3 and slot 2, port 4 – in numerical order.
-------------	--

Click **Apply** to implement changes made.

To establish the rule for a previously created CPU Access Profile:

In the **Configuration** folder, click the **CPU Interface Filtering > CPU Interface Filtering State** to open the **CPU Interface Filtering Table**.

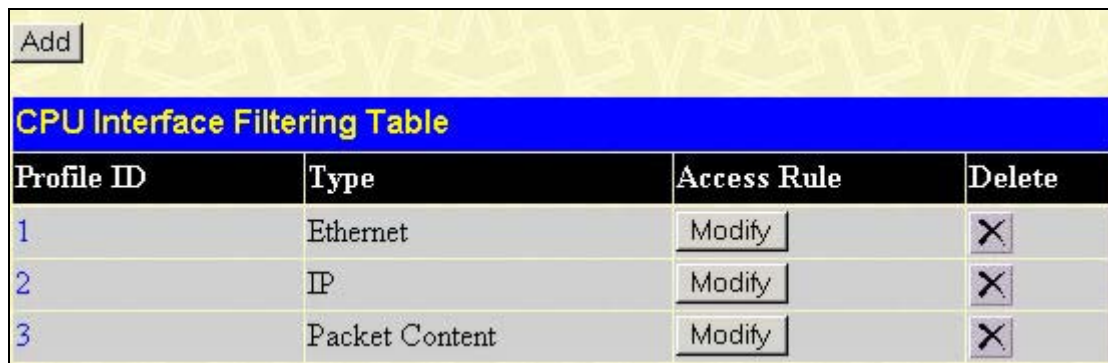

CPU Interface Filtering Table			
Profile ID	Type	Access Rule	Delete
1	Ethernet	Modify	X
2	IP	Modify	X
3	Packet Content	Modify	X

Figure 6- 73. CPU Interface Filtering Table

In this window, the user may add a rule to a previously created CPU access profile by clicking the corresponding Modify button of the entry to configure, either **Ethernet**, **IP** or **Packet Content**. Each entry will open a new and unique window, as shown in the examples below.

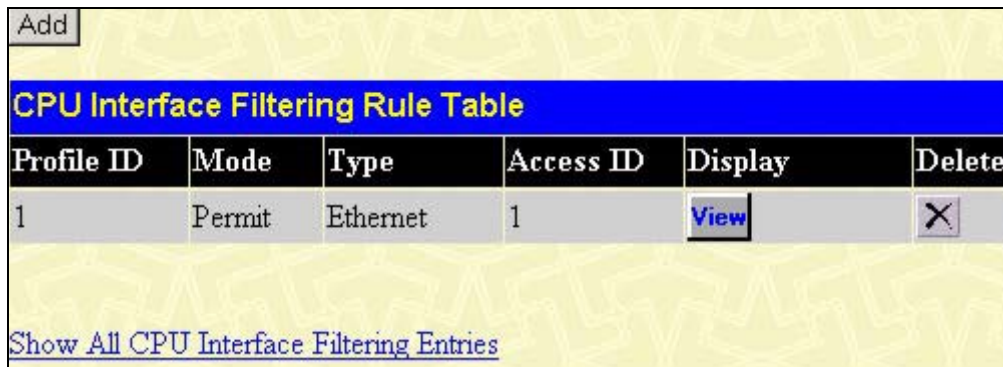

CPU Interface Filtering Rule Table					
Profile ID	Mode	Type	Access ID	Display	Delete
1	Permit	Ethernet	1	View	X

[Show All CPU Interface Filtering Entries](#)

Figure 6- 74. CPU Interface Filtering Table – Ethernet

To create a new rule set for an access profile click the **Add** button. A new window is displayed. To remove a previously created rule, click the corresponding  button. The following window is used for the Ethernet Rule configuration.

CPU Interface Filtering Rule Configuration	
Profile ID	1
Mode	<input checked="" type="radio"/> Permit <input type="radio"/> Deny
Access ID(1-100)	1
Type	Ethernet
Vlan Name	
Source Mac	00-00-00-00-00-00
Destination Mac	00-00-00-00-00-00
Ethernet Type	0000
<input type="button" value="Apply"/>	
Show All CPU Interface Filtering Rule Entries	

Figure 6- 75. CPU Interface Filtering Rule Configuration – Ethernet

To set the Access Rule for Ethernet, adjust the following parameters and click **Apply**.

Parameters	Description
Profile ID	This is the identifier number for this profile set.
Mode	Select Permit to specify that the packets that match the access profile are forwarded by the Switch, according to any additional rule added (see below). Select Deny to specify that packets that do not match the access profile are not forwarded by the Switch and will be filtered.
Access ID	Type in a unique identifier number for this access and priority. This value can be set from 1 - 100.
Type	Selected profile based on Ethernet (MAC Address), IP address or Packet Content. <ul style="list-style-type: none"> <i>Ethernet</i> instructs the Switch to examine the layer 2 part of each packet header. <i>IP</i> instructs the Switch to examine the IP address in each frame's header. <i>Packet Content Mask</i> instructs the Switch to examine the packet header.
VLAN Name	Allows the entry of a name for a previously configured VLAN.
Source MAC	Source MAC Address - Enter a MAC Address for the source MAC address.
Destination MAC	Destination MAC Address - Enter a MAC Address mask for the destination MAC address.
Ethernet Type	Specifies that the access profile will apply only to packets with this hexadecimal 802.1Q Ethernet type value (hex 0x0-0xffff) in the packet header. The Ethernet type value may be set in the form: hex 0x0-0xffff, which means the user may choose any combination of letters and numbers ranging from a-f and from 0-9999.

To view the settings of a previously correctly configured rule, click in the **Access Rule Table** to view the following screen:

CPU Interface Filtering Rule Display	
Profile ID	1
Access ID	1
Mode	Permit
Type	Ethernet
Vlan Name	default
Source Mac	-----
Destination Mac	-----
Ethernet Type	-----

[Show All CPU Interface Filtering Rule Entries](#)

Figure 6- 76. CPU Interface Filtering Rule Display – Ethernet

The following window is the CPU Interface Filtering Rule Table for IP.

Add

CPU Interface Filtering Rule Table					
Profile ID	Mode	Type	Access ID	Display	Delete
2	Permit	IP	1	View	<input type="button" value="X"/>

[Show All CPU Interface Filtering Entries](#)

Figure 6- 77. CPU Interface Filtering Rule Table – IP

To create a new rule set for an access profile click the **Add** button. A new window is displayed. To remove a previously created rule, click the corresponding button. The following window is used for the IP Rule configuration.

CPU Interface Filtering Rule Configuration	
Profile ID	2
Mode	<input checked="" type="radio"/> Permit <input type="radio"/> Deny
Access ID(1-100)	<input type="text" value="1"/>
Type	IP
Vlan Name	<input type="text"/>
Source IP	<input type="text" value="0.0.0.0"/>
Destination IP	<input type="text" value="0.0.0.0"/>
Dscp(0-63)	<input type="text" value="0"/>

[Show All CPU Interface Filtering Rule Entries](#)

Figure 6- 78. CPU Interface Filtering Rule Configuration – IP

Configure the following Access Rule Configuration settings for IP:

Parameter	Description
Profile ID	This is the identifier number for this profile set.
Mode	Select Permit to specify that the packets that match the access profile are forwarded by the Switch, according to any additional rule added (see below). Select Deny to specify that packets that do not match the access profile are not forwarded by the Switch and will be filtered.
Access ID	Type in a unique identifier number for this access. This value can be set from 1 - 100.
Type	Selected profile based on Ethernet (MAC Address), IP address or Packet Content. <ul style="list-style-type: none"> <i>Ethernet</i> instructs the Switch to examine the layer 2 part of each packet header. <i>IP</i> instructs the Switch to examine the IP address in each frame's header. <i>Packet Content Mask</i> instructs the Switch to examine the packet header.
VLAN Name	Allows the entry of a name for a previously configured VLAN.
Source IP	Source IP Address - Enter an IP Address mask for the source IP address.
Destination IP	Destination IP Address- Enter an IP Address mask for the destination IP address.

To view the settings of a previously correctly configured rule, click [View](#) in the **Access Rule Table** to view the following screen:

CPU Interface Filtering Rule Display	
Profile ID	2
Access ID	2
Mode	Permit
Type	IP
Vlan Name	default
Source IP	-----
Destination IP	-----
Dscp	-----
Protocol	-----
Show All CPU Interface Filtering Rule Entries	

Figure 6- 79. CPU Interface Filtering Rule Display - IP

The following window is the **CPU Interface Filtering Rule Table** for Packet Content.

CPU Interface Filtering Rule Table					
Profile ID	Mode	Type	Access ID	Display	Delete
3	Permit	Packet Content	1	View	

[Show All CPU Interface Filtering Entries](#)

Figure 6- 80. CPU Interface Filtering Rule Table – Packet Content

To remove a previously created rule, select it and click the button. To add a new Access Rule, click the **Add** button:

CPU Interface Filtering Rule Configuration				
Profile ID	3			
Mode	<input checked="" type="radio"/> Permit <input type="radio"/> Deny			
Access ID(1-100)	<input type="text" value="1"/>			
Type	Packet Content			
Offset_0-15	<input type="checkbox"/>	<input type="text" value="00000000"/>	<input type="text" value="00000000"/>	<input type="text" value="00000000"/>
Offset_16-31	<input type="checkbox"/>	<input type="text" value="00000000"/>	<input type="text" value="00000000"/>	<input type="text" value="00000000"/>
Offset_32-47	<input type="checkbox"/>	<input type="text" value="00000000"/>	<input type="text" value="00000000"/>	<input type="text" value="00000000"/>
Offset_48-63	<input type="checkbox"/>	<input type="text" value="00000000"/>	<input type="text" value="00000000"/>	<input type="text" value="00000000"/>
Offset_64-79	<input type="checkbox"/>	<input type="text" value="00000000"/>	<input type="text" value="00000000"/>	<input type="text" value="00000000"/>
				<input type="button" value="Apply"/>

[Show All CPU Interface Filtering Rule Entries](#)

Figure 6- 81. CPU Interface Filtering Rule Configuration - Packet Content

To set the Access Rule for Ethernet, adjust the following parameters and click **Apply**.

Parameters	Description
Profile ID	This is the identifier number for this profile set.
Mode	Select Permit to specify that the packets that match the access profile are forwarded by the Switch, according to any additional rule added (see below). Select Deny to specify that packets that do not match the access profile are not forwarded by the Switch and will be filtered.
Access ID	Type in a unique identifier number for this access. This value can be set from 1 - 100.
Type	Selected profile based on Ethernet (MAC Address), IP address or Packet Content. <ul style="list-style-type: none"> <i>Ethernet</i> instructs the Switch to examine the layer 2 part of each packet header. <i>IP</i> instructs the Switch to examine the IP address in each frame's header. <i>Packet Content Mask</i> instructs the Switch to examine the packet header.

Offset	<p>This field will instruct the Switch to mask the packet header beginning with the offset value specified:</p> <ul style="list-style-type: none"> • <i>value (0-15)</i> - Enter a value in hex form to mask the packet from the beginning of the packet to the 15th byte. • <i>value (16-31)</i> - Enter a value in hex form to mask the packet from byte 16 to byte 31. • <i>value (32-47)</i> - Enter a value in hex form to mask the packet from byte 32 to byte 47. • <i>value (48-63)</i> - Enter a value in hex form to mask the packet from byte 48 to byte 63. • <i>value (64-79)</i> - Enter a value in hex form to mask the packet from byte 64 to byte 79.
---------------	---

To view the settings of a previously correctly configured rule, click [View](#) in the **Access Rule Table** to view the following screen:

CPU Interface Filtering Rule Display	
Profile ID	3
Access ID	3
Mode	Deny
Type	Packet Content
Vlan Name	-----
Offset 0-15	0x00000000 0x00000000 0x00000000 0x00000000
Offset 16-31	-----
Offset 32-47	-----
Offset 48-63	-----
Offset 64-79	-----
Show All CPU Interface Filtering Rule Entries	

Figure 6- 82. CPU Interface Filtering Rule Display – Packet Content

Port Access Entity (802.1X)

802.1x Port-Based and MAC-Based Access Control

The IEEE 802.1x standard is a security measure for authorizing and authenticating users to gain access to various wired or wireless devices on a specified Local Area Network by using a Client and Server based access control model. This is accomplished by using a RADIUS server to authenticate users trying to access a network by relaying Extensible Authentication Protocol over LAN (EAPOL) packets between the Client and the Server. The following figure represents a basic EAPOL packet:

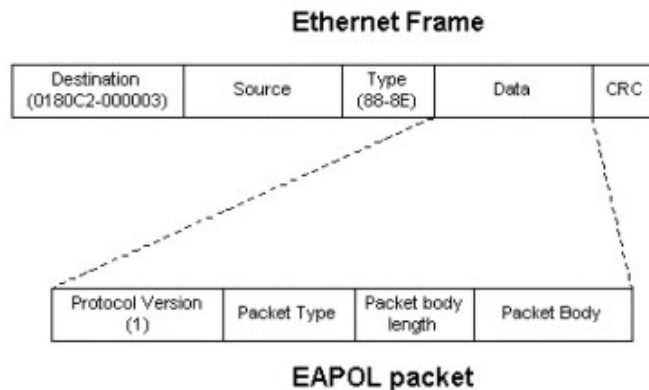

Figure 6- 83. The EAPOL Packet

Utilizing this method, unauthorized devices are restricted from connecting to a LAN through a port to which the user is connected. EAPOL packets are the only traffic that can be transmitted through the specific port until authorization is granted. The 802.1x Access Control method holds three roles, each of which are vital to creating and upkeeping a stable and working Access Control security method.

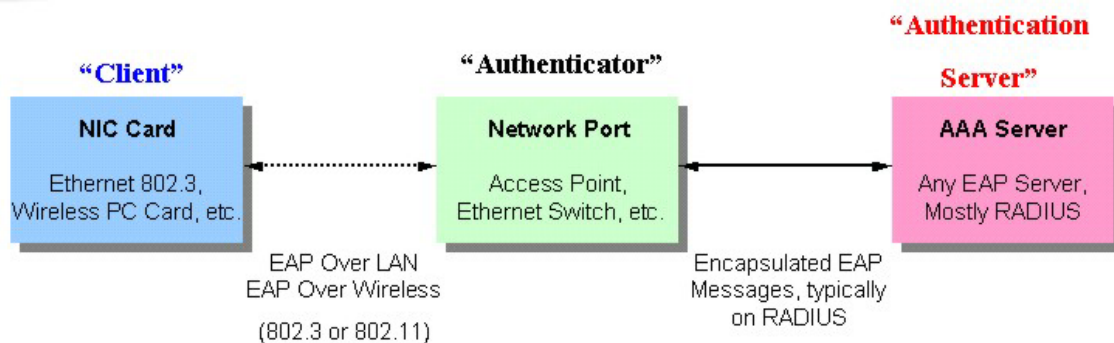

Figure 6- 84. The three roles of 802.1x

The following section will explain the three roles of Client, Authenticator and Authentication Server in greater detail.

Authentication Server

The Authentication Server is a remote device that is connected to the same network as the Client and Authenticator, must be running a RADIUS Server program and must be configured properly on the Authenticator (Switch). Clients connected to a port on the Switch must be authenticated by the Authentication Server (RADIUS) before attaining any services offered by the Switch on the LAN. The role of the Authentication Server is to certify the identity of the Client attempting to access the network by exchanging secure information between the RADIUS server and the Client through EAPOL packets and, in turn, informs the Switch whether or not the Client is granted access to the LAN and/or switches services.

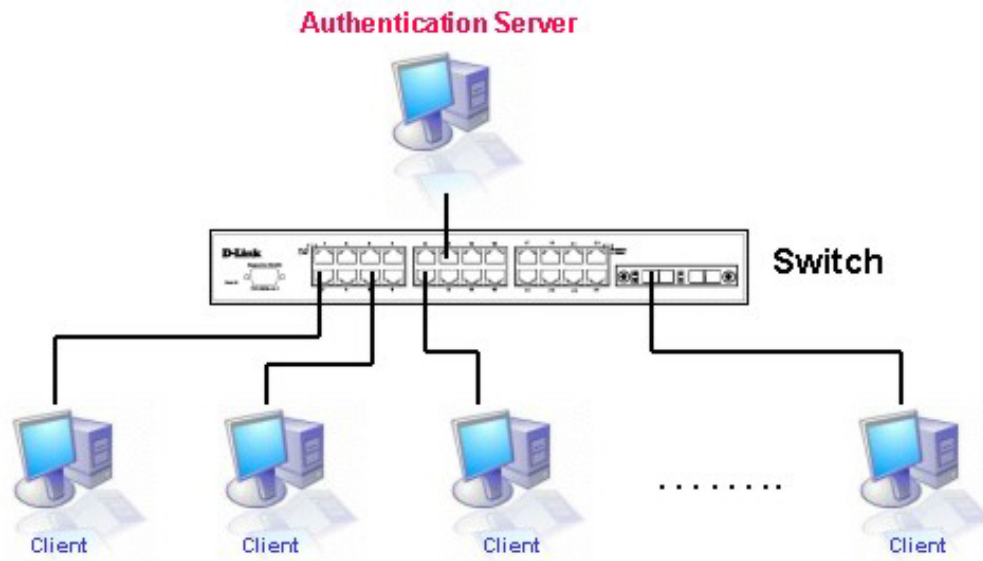

Figure 6- 85. The Authentication Server

Authenticator

The Authenticator (the Switch) is an intermediary between the Authentication Server and the Client. The Authenticator serves two purposes when utilizing 802.1x. The first purpose is to request certification information from the Client through EAPOL packets, which is the only information allowed to pass through the Authenticator before access is granted to the Client. The second purpose of the Authenticator is to verify the information gathered from the Client with the Authentication Server, and to then relay that information back to the Client.

Three steps must be implemented on the Switch to properly configure the Authenticator.

1. The 802.1x State must be *Enabled*. (**Configuration / Port Access Entity / 802.1X Auth Mode Settings**)
2. The 802.1x settings must be implemented by port (**Configuration / Port Access Entity / 802.1X Authenticator Settings**)
3. A RADIUS server must be configured on the Switch. (**Configuration / Port Access Entity / RADIUS Server**)

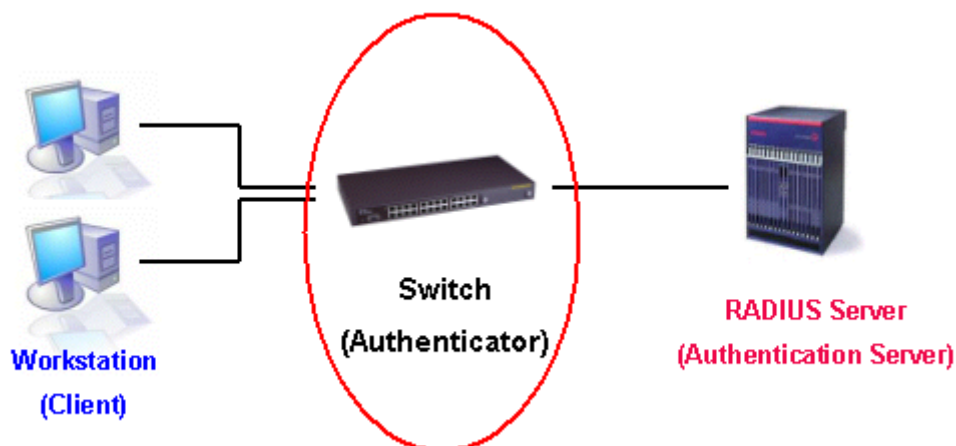

Figure 6- 86. The Authenticator

Client

The Client is simply the endstation that wishes to gain access to the LAN or switch services. All endstations must be running software that is compliant with the 802.1x protocol. For users running Windows XP, that software is included within the operating system. All other users are required to attain 802.1x client software from an outside source. The Client will request access to the LAN and or Switch through EAPOL packets and, in turn will respond to requests from the Switch.

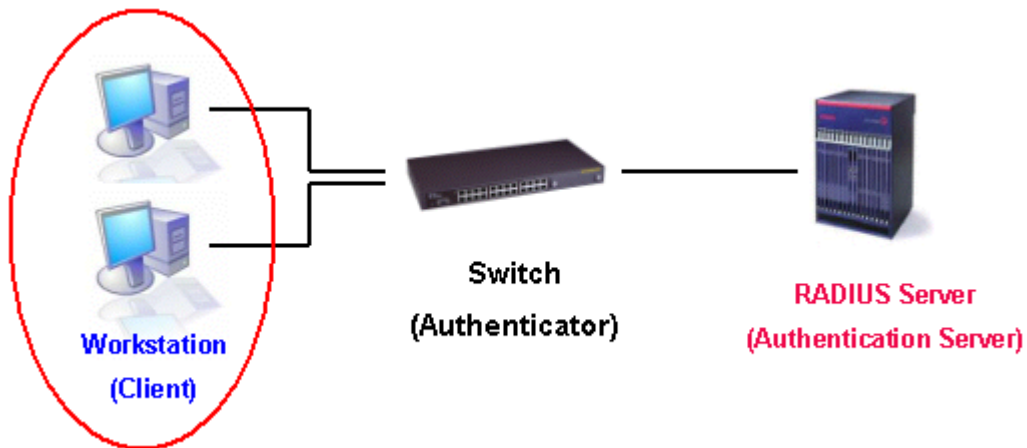

Figure 6- 87. The Client

Authentication Process

Utilizing the three roles stated above, the 802.1x protocol provides a stable and secure way of authorizing and authenticating users attempting to access the network. Only EAPOL traffic is allowed to pass through the specified port before a successful authentication is made. This port is “locked” until the point when a Client with the correct username and password (and MAC address if 802.1x is enabled by MAC address) is granted access and therefore successfully “unlocks” the port. Once unlocked, normal traffic is allowed to pass through the port. The following figure displays a more detailed explanation of how the authentication process is completed between the three roles stated above.

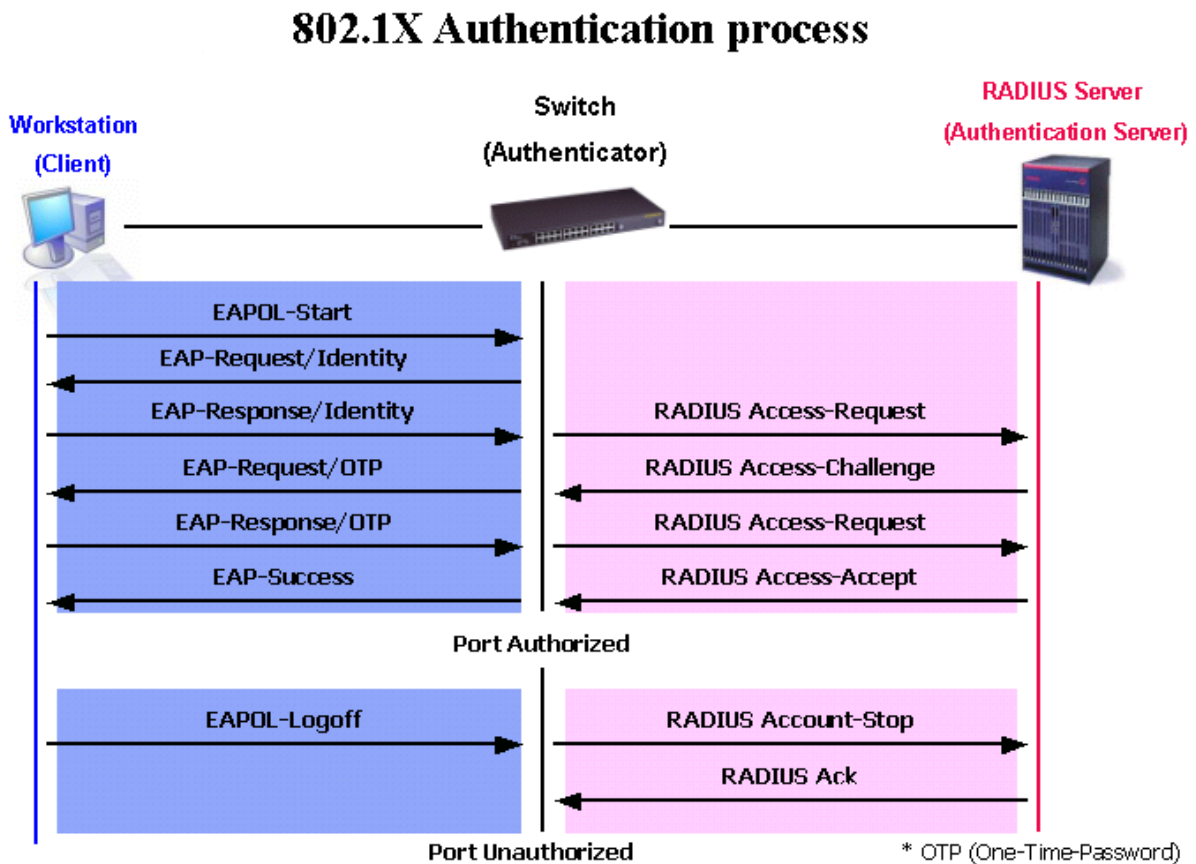

Figure 6- 88. The 802.1x Authentication Process

The D-Link implementation of 802.1x allows network administrators to choose between two types of Access Control used on the Switch, which are:

1. Port-Based Access Control – This method requires only one user to be authenticated per port by a remote RADIUS server to allow the remaining users on the same port access to the network.
2. MAC-Based Access Control – Using this method, the Switch will automatically learn up to sixteen MAC addresses by port and set them in a list. Each MAC address must be authenticated by the Switch using a remote RADIUS server before being allowed access to the Network.

Understanding 802.1x Port-based and MAC-based Network Access Control

The original intent behind the development of 802.1X was to leverage the characteristics of point-to-point in LANs. As any single LAN segment in such infrastructures has no more than two devices attached to it, one of which is a Bridge Port. The Bridge Port detects events that indicate the attachment of an active device at the remote end of the link, or an active device becoming inactive. These events can be used to control the authorization state of the Port and initiate the process of authenticating the attached device if the Port is unauthorized. This is the Port-Based Network Access Control.

Port-Based Network Access Control

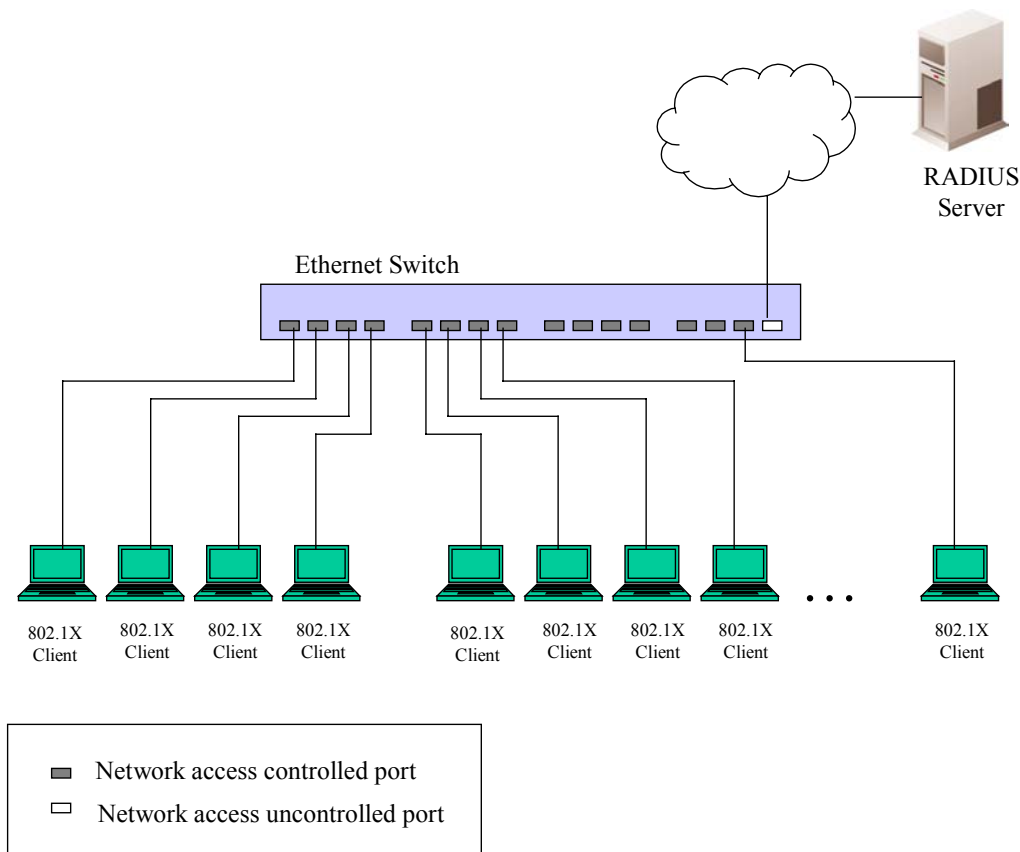

Figure 6- 89. Example of Typical Port-Based Configuration

Once the connected device has successfully been authenticated, the Port then becomes Authorized, and all subsequent traffic on the Port is not subject to access control restriction until an event occurs that causes the Port to become Unauthorized. Hence, if the Port is actually connected to a shared media LAN segment with more than one attached device, successfully authenticating one of the attached devices effectively provides access to the LAN for all devices on the shared segment. Clearly, the security offered in this situation is open to attack.

MAC-Based Network Access Control

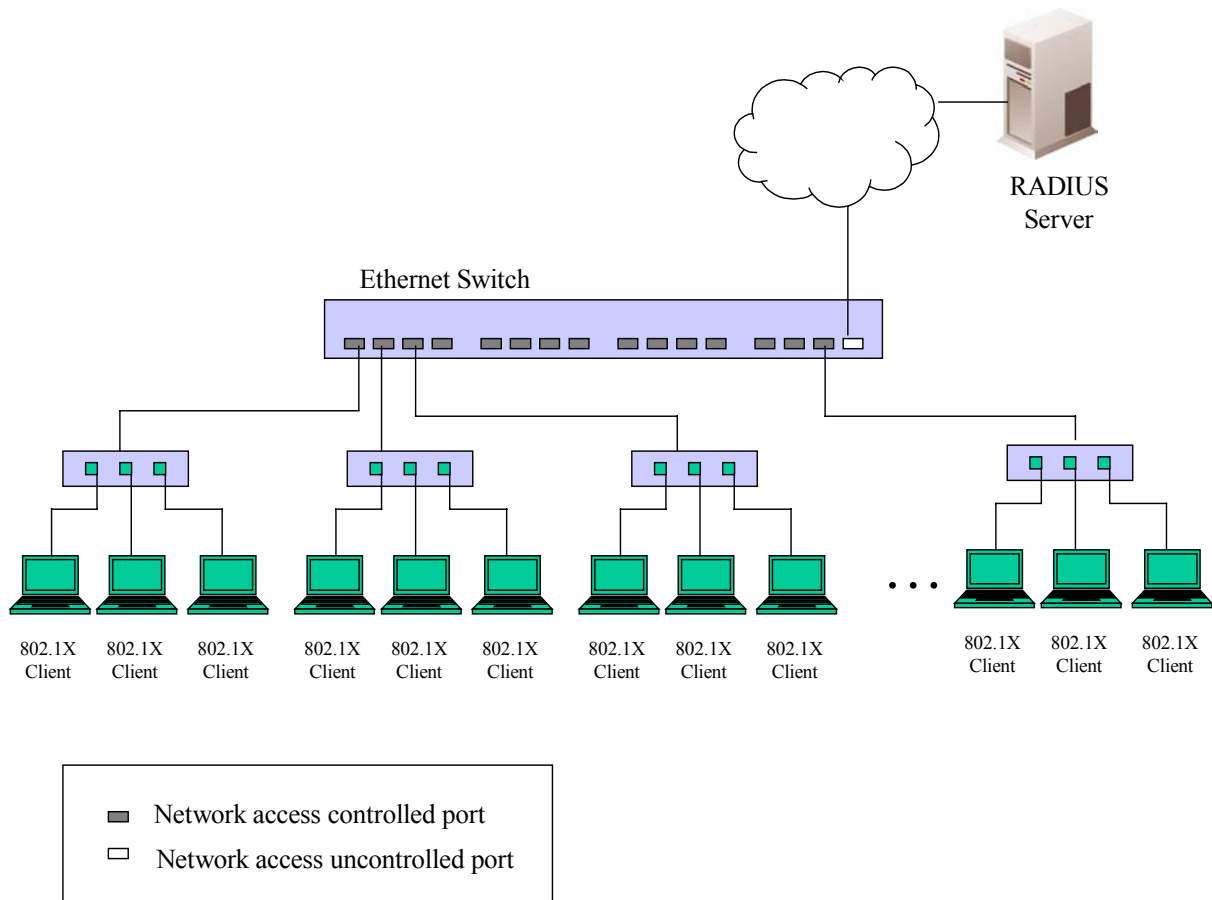

Figure 6- 90. Example of Typical MAC-Based Configuration

In order to successfully make use of 802.1X in a shared media LAN segment, it would be necessary to create “logical” Ports, one for each attached device that required access to the LAN. The Switch would regard the single physical Port connecting it to the shared media segment as consisting of a number of distinct logical Ports, each logical Port being independently controlled from the point of view of EAPOL exchanges and authorization state. The Switch learns each attached devices’ individual MAC addresses, and effectively creates a logical Port that the attached device can then use to communicate with the LAN via the Switch.

802.1x Auth Mode Settings

The following window is used to set the type of authentication mode used in employing the 802.1X security settings. Simply use the pull down menu to select **port_based** or **mac_based** 802.1X and click the **Apply** button.



Figure 6- 91. 802.1X Auth Mode Settings window

802.1X Authenticator Settings

To configure the 802.1X authenticator settings, click **Configuration > Port Access Entity > 802.1x Authenticator Settings**:

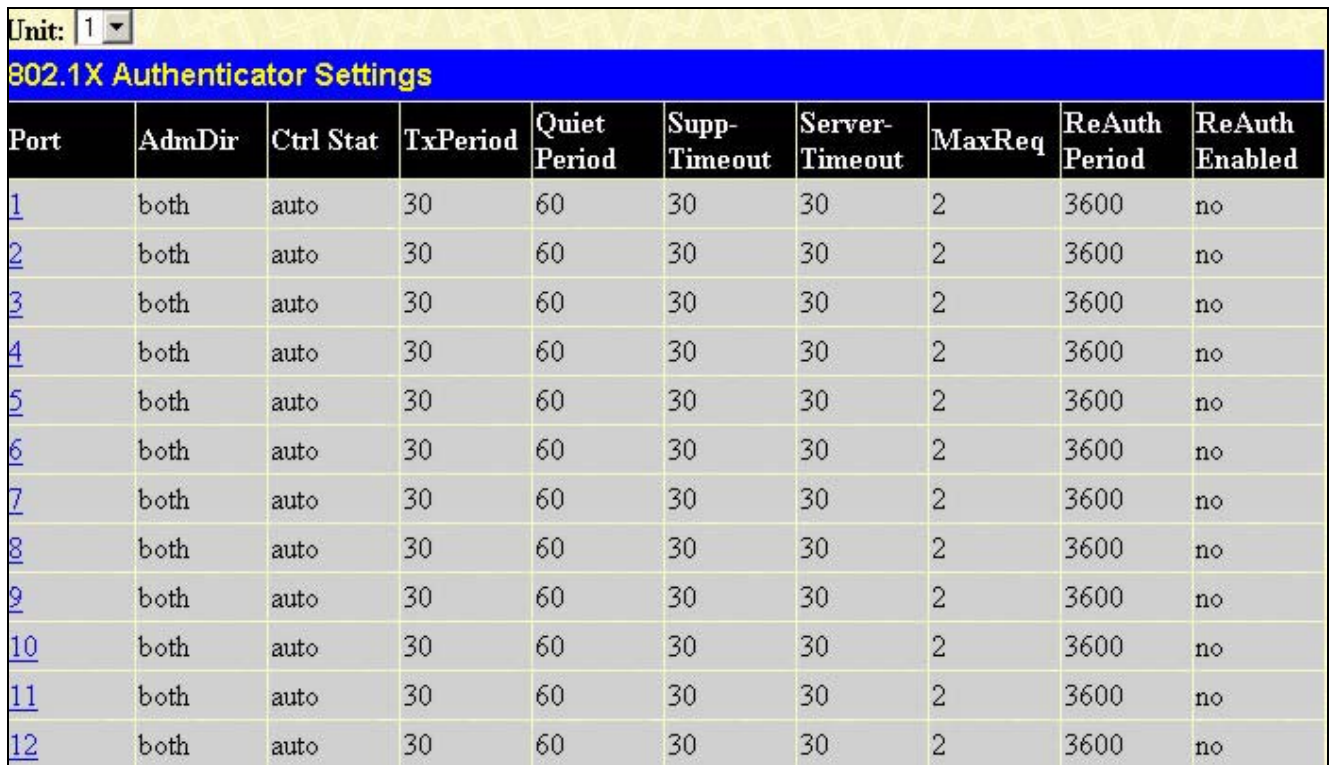

Port	AdmDir	Ctrl Stat	TxPeriod	Quiet Period	Supp-Timeout	Server-Timeout	MaxReq	ReAuth Period	ReAuth Enabled
1	both	auto	30	60	30	30	2	3600	no
2	both	auto	30	60	30	30	2	3600	no
3	both	auto	30	60	30	30	2	3600	no
4	both	auto	30	60	30	30	2	3600	no
5	both	auto	30	60	30	30	2	3600	no
6	both	auto	30	60	30	30	2	3600	no
7	both	auto	30	60	30	30	2	3600	no
8	both	auto	30	60	30	30	2	3600	no
9	both	auto	30	60	30	30	2	3600	no
10	both	auto	30	60	30	30	2	3600	no
11	both	auto	30	60	30	30	2	3600	no
12	both	auto	30	60	30	30	2	3600	no

Figure 6- 92. Configure 802.1X Authenticator Parameter window

To view the 802.1X authenticator settings on a different switch in the switch stack, use the **Unit** pull-down menu to select that switch by its ID number in the switch stack. To configure the settings by port, click on the hyperlinked port number under the **Port** heading, which will display the following table to configure:

802.1X Authenticator Settings-Unit 1	
Unit	1
From	Port 1
To	Port 1
AdmDir	both
PortControl	auto
TxPeriod	30
QuietPeriod	60
Supp Timeout	30
ServerTimeout	30
MaxReq	2
ReAuthPeriod	3600
ReAuth	Disabled
Show Authenticators Setting for Unit 1 Apply	

Figure 6-93. 802.1X Authenticator Settings – Modify window

This screen allows you to set the following features:

Parameter	Description
Unit	Choose the Switch ID number of the Switch in the switch stack to be modified.
From [] To []	Enter the port or ports to be set.
AdmCtrlDir	<p>Sets the administrative-controlled direction to either <i>in</i> or <i>both</i>.</p> <p>If <i>in</i> is selected, control is only exerted over incoming traffic through the port you selected in the first field.</p> <p>If <i>both</i> is selected, control is exerted over both incoming and outgoing traffic through the controlled port selected in the first field.</p>
PortControl	<p>This allows you to control the port authorization state.</p> <p>Select <i>forceAuthorized</i> to disable 802.1X and cause the port to transition to the authorized state without any authentication exchange required. This means the port transmits and receives normal traffic without 802.1X-based authentication of the client.</p> <p>If <i>forceUnauthorized</i> is selected, the port will remain in the unauthorized state, ignoring all attempts by the client to authenticate. The Switch cannot provide authentication services to the client through the interface.</p> <p>If <i>Auto</i> is selected, it will enable 802.1X and cause the port to begin in the unauthorized state, allowing only EAPOL frames to be sent and received through the port. The authentication process begins when the link state of the port transitions from down to up, or when an EAPOL-start frame is received. The Switch then requests the identity of the client and begins relaying authentication messages between the client and the authentication server.</p> <p>The default setting is <i>Auto</i>.</p>

TxPeriod	This sets the TxPeriod of time for the authenticator PAE state machine. This value determines the period of an EAP Request/Identity packet transmitted to the client. The default setting is 30 seconds.
QuietPeriod	This allows you to set the number of seconds that the Switch remains in the quiet state following a failed authentication exchange with the client. The default setting is 60 seconds.
SuppTimeout	This value determines timeout conditions in the exchanges between the Authenticator and the client. The default setting is 30 seconds.
ServerTimeout	This value determines timeout conditions in the exchanges between the Authenticator and the authentication server. The default setting is 30 seconds.
MaxReq	The maximum number of times that the Switch will retransmit an EAP Request to the client before it times out of the authentication sessions. The default setting is 2.
ReAuthPeriod	A constant that defines a nonzero number of seconds between periodic reauthentication of the client. The default setting is 3600 seconds.
ReAuth	Determines whether regular reauthentication will take place on this port. The default setting is <i>Disabled</i> .

Click **Apply** to implement your configuration changes. To view configurations for the **802.1X Authenticator Settings** on a port-by-port basis, see the **802.1X Authenticator Settings** table.

Local Users

In the **Configuration** folder, open the **Port Access Entity** folder and click **Local Users** to open the **802.1x Local User Table Configuration** window. This window will allow the user to set different local users on the Switch.

802.1x Local User Table Configuration		
User Name	Password	Confirm Password
<input type="text"/>	<input type="text"/>	<input type="text"/>
<input type="button" value="Apply"/>		
Total Entries: 1		
802.1x Local User Table		
User Name	Password	Delete
Darren	1	<input type="button" value="X"/>

Figure 6- 94. 802.1x User and 802.1x User Table window

Enter a **User Name**, **Password** and confirmation of that password. Properly configured local users will be displayed in the **802.1x Local User Table** in the same window.

PAE System Control

Existing 802.1x port and MAC settings are displayed and can be configured using the windows below.

Port Capability

Click **Port Access Entity > PAE System Control > 802.1x Capability Settings** to view the following window:

802.1X Capability Settings				
Unit	From	To	Capability	Apply
1	Port 1	Port 1	None	Apply
802.1X Capability Table				
Port	Capability			
1	None			
2	None			
3	None			
4	None			
5	None			
6	None			
7	None			
8	None			
9	None			
10	None			
11	None			
12	None			

Figure 6- 95. 802.1x Capability Settings and Table window

To set up the Switch's 802.1x port-based authentication, select the switch in the switch stack by using the **Unit** pull-down menu and then select which ports are to be configured in the **From** and **To** fields. Next, enable the ports by selecting *Authenticator* from the drop-down menu under **Capability**. Click **Apply** to let your change take effect.

Configure the following 802.1x capability settings:

Parameter	Description
Unit	Choose the Switch ID number of the Switch in the switch stack to be modified.
From and To	Ports being configured for 802.1x settings.
Capability	Two role choices can be selected: <i>Authenticator</i> - A user must pass the authentication process to gain access to the network. <i>None</i> - The port will not be controlled by the 802.1x functions.

Initializing Ports for Port Based 802.1x

Existing 802.1x port and MAC settings are displayed and can be configured using the window below.

Click **Port Access Entity > PAE System Control > Initialize Port(s)** to open the following window:

Initialize Port			
Unit	From	To	Apply
1	Port 1	Port 1	Apply

Initialize Port Table			
Port	Auth PAE State	Backend_State	Port Status
4	ForceAuth	Success	Authorized
5	ForceAuth	Success	Authorized
6	ForceAuth	Success	Authorized
7	ForceAuth	Success	Authorized
8	ForceAuth	Success	Authorized
9	ForceAuth	Success	Authorized
10	ForceAuth	Success	Authorized
11	ForceAuth	Success	Authorized
12	ForceAuth	Success	Authorized

Figure 6- 96. Initialize Port window

This window allows you to initialize a port or group of ports. The **Initialize Port Table** in the bottom half of the window displays the current status of the port(s).

This window displays the following information:

Parameter	Description
Unit	Choose the Switch ID number of the Switch in the switch stack to be modified.
From and To	Select ports to be initialized.
Port	A read only field indicating a port on the Switch.
MAC Address	The MAC address of the Switch connected to the corresponding port, if any.
Auth PAE State	The Authenticator PAE State will display one of the following: <i>Initialize, Disconnected, Connecting, Authenticating, Authenticated, Aborting, Held, ForceAuth, ForceUnauth, and N/A.</i>
Backend State	The Backend Authentication State will display one of the following: <i>Request, Response, Success, Fail, Timeout, Idle, Initialize, and N/A.</i>
Port Status	The status of the controlled port can be <i>Authorized, Unauthorized, or N/A.</i>

Initializing Ports for MAC Based 802.1x

To initialize ports for the MAC side of 802.1x, the user must first enable 802.1x by MAC address in the **Advanced Settings** window. Click **Configuration > Port Access Entity > PAE System Control > Initialize Port(s)** to open the following window:

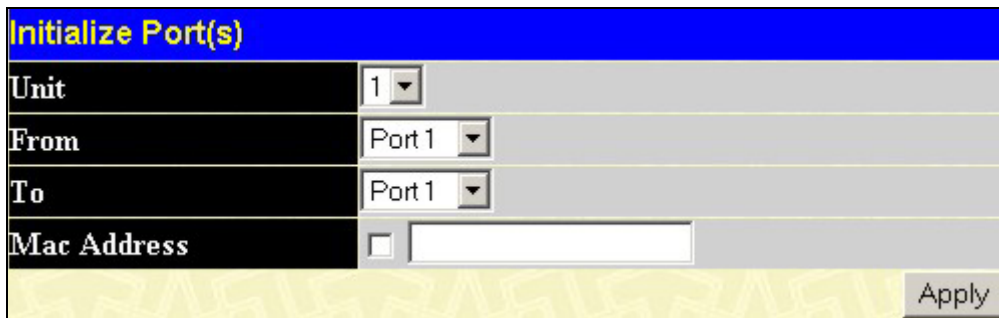

Initialize Port(s)	
Unit	1
From	Port 1
To	Port 1
Mac Address	<input type="checkbox"/> <input type="text"/>
Apply	

Figure 6- 97. Initialize Ports (MAC based 802.1x)

To initialize ports, first choose the switch in the switch stack by using the **Unit** pull-down menu, then the range of ports in the **From** and **To** field. Then the user must specify the MAC address to be initialized by entering it into the **MAC Address** field and checking the corresponding check box. To begin the initialization, click **Apply**.



NOTE: The user must first globally enable 802.1X in the **802.1X Auth Mode Settings** window before initializing ports. Information in the **Initialize Ports Table** cannot be viewed before enabling 802.1X.

Reauthenticate Port(s) for Port Based 802.1x

This window allows you to reauthenticate a port or group of ports by choosing a port or group of ports by using the pull down menus **From** and **To** and clicking **Apply**. The **Reauthenticate Port Table** displays the current status of the reauthenticated port(s) once you have clicked **Apply**.

Click **Configuration > Port Access Entity > PAE System Control > Reauthenticate Port(s)** to open the **Reauthenticate Port** window:

Reauthenticate Port			
Unit	From	To	Apply
1	Port 1	Port 1	Apply

Reauthenticate Port Table			
Port	Auth PAE State	Backend State	Port Status
4	ForceAuth	Success	Authorized
5	ForceAuth	Success	Authorized
6	ForceAuth	Success	Authorized
7	ForceAuth	Success	Authorized
8	ForceAuth	Success	Authorized
9	ForceAuth	Success	Authorized
10	ForceAuth	Success	Authorized
11	ForceAuth	Success	Authorized
12	ForceAuth	Success	Authorized

Figure 6- 98. Reauthenticate Port and Reauthenticate Port Table window

This window displays the following information:

Parameter	Description
Unit	Choose the Switch ID number of the Switch in the switch stack to be modified.
Port	The port number of the reauthenticated port.
MAC Address	Displays the physical address of the Switch where the port resides.
Auth PAE State	The Authenticator State will display one of the following: <i>Initialize, Disconnected, Connecting, Authenticating, Authenticated, Aborting, Held, ForceAuth, ForceUnauth, and N/A.</i>
BackendState	The Backend State will display one of the following: <i>Request, Response, Success, Fail, Timeout, Idle, Initialize, and N/A.</i>
PortStatus	The status of the controlled port can be <i>Authorized, Unauthorized, or N/A.</i>



NOTE: The user must first globally enable 802.1X in the **Advanced Settings** window in the **Configuration** folder before reauthenticating ports. Information in the **Reauthenticate Ports Table** cannot be viewed before enabling 802.1X.

Reauthenticate Port(s) for MAC-based 802.1x

To reauthenticate ports for the MAC side of 802.1x, the user must first enable 802.1x by MAC address in the **Advanced Settings** window. Click **Configuration > Port Access Entity > PAE System Control > Reauthenticate Port(s)** to open the following window:

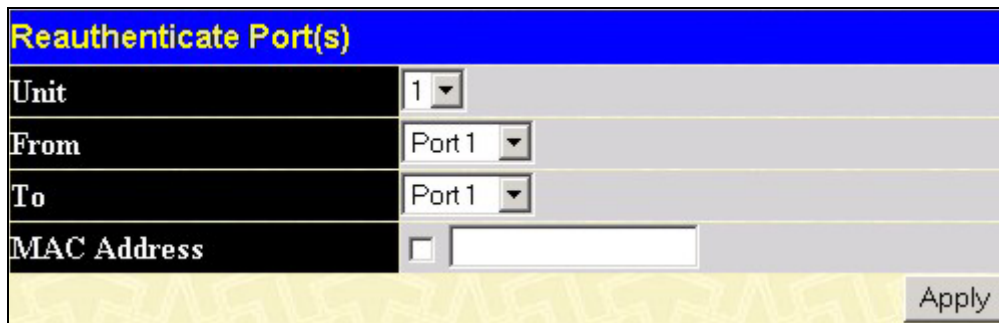

Reauthenticate Port(s)	
Unit	1
From	Port 1
To	Port 1
MAC Address	<input type="checkbox"/> <input type="text"/>
Apply	

Figure 6- 99. Reauthenticate Ports – MAC based 802.1x

To reauthenticate ports, first choose the switch in the switch stack by using the **Unit** pull-down menu, then the range of ports in the **From** and **To** field. Then the user must specify the MAC address to be reauthenticated by entering it into the **MAC Address** field and checking the corresponding check box. To begin the reauthentication, click **Apply**.

RADIUS Server

The RADIUS feature of the Switch allows you to facilitate centralized user administration as well as providing protection against a sniffing, active hacker. The Web Manager offers three windows.

Click **Configuration > Port Access Entity > RADIUS Server > Authentic RADIUS Server** to open the **Authentic RADIUS Server Setting** window shown below:

Authentic RADIUS Server					
Succession	First <input type="button" value="v"/>				
RADIUS Server	0.0.0.1 <input type="text"/>				
Authentic Port	1812 <input type="text"/>				
Accounting Port	1813 <input type="text"/>				
Key	<input type="text"/>				
Confirm Key	<input type="text"/>				
Status	Valid <input type="button" value="v"/>				
					<input type="button" value="Apply"/>
Current RADIUS Server(s) Settings Table					
Succession	RADIUS Server	Auth UDP Port	Acct UDP Port	Status	Key
First					
Second					
Third					

Figure 6- 100. Authentic RADIUS Server and Current RADIUS Server Settings Table window

This window displays the following information:

Parameter	Description
Succession	Choose the desired RADIUS server to configure: <i>First</i> , <i>Second</i> or <i>Third</i> .
RADIUS Server	Set the RADIUS server IP.
Authentic Port	Set the RADIUS authentic server(s) UDP port. The default port is 1812.
Accounting Port	Set the RADIUS account server(s) UDP port. The default port is 1813.
Key	Set the key the same as that of the RADIUS server.
Confirm Key	Confirm the shared key is the same as that of the RADIUS server.
Status	This allows you to set the RADIUS Server as <i>Valid</i> (Enabled) or <i>Invalid</i> (Disabled).

Click **Apply** to implement changes made.

Layer 3 IP Networking

Layer 3 Global Advanced Settings

The **L3 Global Advanced Settings** window allows the user to enable and disable Layer 3 settings and functions from a single window. The full settings and descriptions for these functions will appear later in this section. To view this window, open the **Configuration** folder and then the **Layer 3 IP Networking** folder and click on the **L3 Global Advanced Settings** link to access the following window.

L3 Global Advanced Settings	
DVMRP State	Disabled ▾
PIM-DM State	Disabled ▾
RIP State	Disabled ▾
OSPF State	Disabled ▾
ARP Aging Time	20
Apply	

Figure 6- 101. L3 Global Advanced Settings window

The user may set the following:

Parameter	Description
DVMRP State	The user may globally enable or disable the Distance Vector Multicast Routing Protocol (DVMRP) function by using the pull down menu.
PIM-DM State	The user may globally enable or disable the Protocol Independent Multicast - Dense Mode (PIM-DM) function by using the pull down menu.
RIP State	The user may globally enable or disable the Routing Information Protocol (RIP) function by using the pull down menu.
OSPF State	The user may globally enable or disable the Open Shortest Path first (OSPF) function by using the pull down menu.
ARP Aging Time	The user may globally set the maximum amount of time, in minutes, that an Address Resolution Protocol (ARP) entry can remain in the Switch's ARP table, without being accessed, before it is dropped from the table. The value may be set in the range of 0-65535 minutes with a default setting of 20 minutes.

IP Multinetting

IP Multinetting is a function that allows multiple IP interfaces to be assigned to the same VLAN. This is beneficial to the administrator when the number of IPs on the original interface is insufficient and the network administrator wishes not to resize the interface. IP Multinetting is capable of assigning another IP interface on the same VLAN without affecting the original stations or settings of the original interface.

Two types of interfaces are configured for IP multinetting, *primary* and *secondary*, and every IP interface must be classified as one of these. A *primary* interface refers to the first interface created on a VLAN, with no exceptions. All other interfaces created will be regarded as *secondary* only, and can only be created once a *primary* interface has been configured. There may be five interfaces per VLAN (one primary, and up to four secondary) and they are, in most cases, independent of each other. *Primary* interfaces cannot be deleted if the VLAN contains a *secondary* interface. Once the user creates multiple interfaces for a specified VLAN (*primary* and *secondary*), that set IP interface cannot be changed to another VLAN.



Application Limitation: A multicast router cannot be connected to IP interfaces that are utilizing the IP Multinetting function.



NOTE: Only the primary IP interface will support the BOOTP relay agent.

IP Multinetting is a valuable tool for network administrators requiring a multitude of IP addresses, but configuring the Switch for IP multinetting may cause troubleshooting and bandwidth problems, and should not be used as a long term solution. Problems may include:

- The Switch may use extra resources to process packets for multiple IP interfaces.
- The amount of broadcast data, such as RIP update packets and PIM hello packets, will be increased.

IP Interface Setup

Each VLAN must be configured prior to setting up the VLAN's corresponding IP interface.

An example is presented below:

VLAN Name	VID	Switch Ports
System (default)	1	5, 6, 7, 8, 21, 22, 23, 24
Engineer	2	9, 10, 11, 12
Marketing	3	13, 14, 15, 16
Finance	4	17, 18, 19, 20
Sales	5	1, 2, 3, 4
Backbone	6	25, 26

Table 6-4. VLAN Example - Assigned Ports

In this case, six IP interfaces are required, so a CIDR notation of 10.32.0.0/11 (or a 11-bit) addressing scheme will work. This addressing scheme will give a subnet mask of 11111111.11100000.00000000.00000000 (binary) or 255.224.0.0 (decimal).

Using a 10.xxx.xxx.xxx IP address notation, the above example would give six network addresses and six subnets.

Any IP address from the allowed range of IP addresses for each subnet can be chosen as an IP address for an IP interface on the switch.

For this example, we have chosen the next IP address above the network address for the IP interface's IP Address:

VLAN Name	VID	Network Number	IP Address
System (default)	1	10.32.0.0	10.32.0.1
Engineer	2	10.64.0.0	10.64.0.1
Marketing	3	10.96.0.0	10.96.0.1
Finance	4	10.128.0.0	10.128.0.1
Sales	5	10.160.0.0	10.160.0.1
Backbone	6	10.192.0.0	10.192.0.1

Table 6- 5. VLAN Example - Assigned IP Interfaces

The six IP interfaces, each with an IP address (listed in the table above), and a subnet mask of 255.224.0.0 can be entered into the **Setup IP Interface** window.

To setup IP Interfaces on the Switch:

Go to the **Configuration** folder, and click on the **Layer 3 IP Networking** folder, and then click on the **IP Interfaces Table** link to open the following dialog box:

IP Interface Table						
Interface Name	Secondary	IP Address	Subnet Mask	VLAN Name	Active	Delete
System	False	10.53.13.65	255.0.0.0	default	Enabled	X

Total Entries: 1

Figure 6- 102. IP Interface Table

To setup a new IP interface, click the **Add** button. To edit an existing IP Interface entry, click on an entry under the **Interface Name** heading. Both actions will result in the same screen to configure, as shown below.

Figure 6- 103. IP Interface Configuration window

Enter a name for the new interface to be added in the **Interface Name** field (if you are editing an IP interface, the **Interface Name** will already be in the top field as seen in the window above). Enter the interface's IP address and subnet mask in the corresponding fields. Pull the **State** pull-down menu to *Enabled* and click **Apply** to enter to make the IP interface effective. To view entries in the **IP Interface Table**, click the [Show All IP Interface Entries](#) hyperlink. Use the **Save Changes** dialog box from the **Maintenance** folder to enter the changes into NV-RAM.

The following fields can be set:

Parameter	Description
Interface Name	This field displays the name for the IP interface. The default IP interface is named "System". Secondary – Click the check box to set the IP interface as a secondary IP interface. <i>Secondary</i> interfaces can only be configured if a <i>primary</i> interface is first configured.
IP Address	This field allows the entry of an IP address to be assigned to this IP interface.
Subnet Mask	This field allows the entry of a subnet mask to be applied to this IP interface.
VLAN Name	This field allows the entry of the VLAN Name for the VLAN the IP interface belongs to.
State	This field may be altered between <i>Enabled</i> and <i>Disabled</i> using the pull down menu. This entry determines whether the interface will be active or not.
Link Status	This read only field states the current status of the IP Interface on the Switch. <i>Link Up</i> denotes that the IP interface is up and running on the Switch. <i>Link Down</i> will denote that the IP interface is not currently set and/or enabled on the Switch.

Click **Apply** to implement changes made.

MD5 Key Configuration

The **MD5 Key Configuration** menu allows the entry of a sixteen-character Message Digest – version 5 (MD5) key which can be used to authenticate every packet exchanged between OSPF routers. It is used as a security mechanism to limit the exchange of network topology information to the OSPF routing domain.

MD5 Keys created here can be used in the **OSPF** menu below.

To configure an **MD5 Key**, click the **MD5 Key Configuration** link to open the following dialog box:

MD5 Key Configuration		
Key ID	Key	
1		
Add/Modify		
MD5 Key Table		
Key ID	Key	Delete
1	45	

Figure 6- 104. MD5 Key Configuration and Table window

The following fields can be set:

Parameter	Description
Key ID	A number from 1 to 255 used to identify the MD5 Key.
Key	A alphanumeric string of between 1 and 16 case-sensitive characters used to generate the Message Digest which is in turn, used to authenticate OSPF packets within the OSPF routing domain.

Click **Apply** to enter the new Key ID settings. To delete a Key ID entry, click the corresponding under the **Delete** heading.

Route Redistribution Settings

Route redistribution allows routers on the network, which are running different routing protocols to exchange routing information. This is accomplished by comparing the routes stored in the various routers routing tables and assigning appropriate metrics. This information is then exchanged among the various routers according to the individual routers current routing protocol. The Switch can redistribute routing information between the OSPF and RIP routing protocols to all routers on the network that are running OSPF or RIP. Routing information entered into the **Static Routing Table** on the local DES-6500 switch is also redistributed.

Routing information source – OSPF and the Static Route table. Routing information will be redistributed to RIP. The following table lists the allowed values for the routing metrics and the types (or forms) of the routing information that will be redistributed.

Route Source	Metric	Type
OSPF	0 to 16	All Internal External ExtType1 ExtType2 Inter-E1 Inter-E2
RIP	0 to 16777214	Type 1 Type 2
Static	0 to 16777214	Type 1 Type 2
Local	0 to 16777214	Type 1 Type 2

Table 6- 6. Route Redistribution Source table

Entering the Type combination – internal type_1 type_2 is functionally equivalent to all. Entering the combination type_1 type_2 is functionally equivalent to external. Entering the combination internal external is functionally equivalent to all.

Entering the metric 0 specifies transparency.

This window will redistribute routing information between the OSPF and RIP routing protocols to all routers on the network that are running OSPF or RIP. To access the **Route Redistribution Settings** window, go to **Configuration > Layer 3 IP Networking > Route Redistribution Settings**:

Route Redistribution Settings				
Dest Protocol	Src Protocol	Type	Metric	
RIP	RIP	All		
			Add/Modify	
Route Redistribution Table				
Src Protocol	Dest Protocol	Type	Metric	Delete

Figure 6- 105. Route Redistribution Settings and Table window

The following parameters may be set or viewed:

Parameter	Description
Dst. Protocol	Allows for the selection of the protocol for the destination device. Choose between <i>RIP</i> and <i>OSPF</i> .
Src. Protocol	Allows for the selection of the protocol for the source device. Choose between <i>RIP</i> , <i>OSPF</i> , <i>Static</i> and <i>Local</i> .
Type	Allows for the selection of one of six methods of calculating the metric value. The user may choose between <i>All</i> , <i>Internal</i> , <i>External</i> , <i>ExtType1</i> , <i>ExtType2</i> , <i>Inter-E1</i> , <i>Inter-E2</i> . See the table above for available metric value types for each source protocol.
Metric	Allows the entry of an OSPF interface cost. This is analogous to a Hop Count in the RIP routing protocol. The user may specify a cost between 0 and 16.

Click **Add/Modify** to implement changes made.



NOTE: The source protocol (**Src. Protocol**) entry and the destination protocol (**Dst. Protocol**) entry cannot be the same.

Static/Default Route Settings

Entries into the Switch's forwarding table can be made using both MAC addresses and IP addresses. Static IP forwarding is accomplished by the entry of an IP address into the Switch's **Static IP Routing Table**. To view the following window, click **Configuration > Layer 3 IP Networking > Static/Default Route**.

IP Address	Subnet Mask	Gateway	Hops	Protocol	Backup State	Delete
Total Entries: 0						

Figure 6- 106. Static/Default Route Settings window

This window shows the following values:

Parameter	Description
IP Address	The IP address of the Static/Default Route.
Subnet Mask	The corresponding Subnet Mask of the IP address entered into the table.
Gateway	The corresponding Gateway of the IP address entered into the table.
Hops	Represents the metric value of the IP interface entered into the table. This field may read a number between 1-65535 for an OSPF setting, and 1-16 for a RIP setting.
Protocol	Represents the protocol used for the Routing Table entry of the IP interface. This field may read OSPF, RIP, Static or Local.
Backup State	Represents the Backup state that this IP interface is configured for. This field may read Primary or Backup.
Delete	Click the <input type="checkbox"/> if you would like to delete this entry from the Static/Default Route Settings table.

To enter an IP Interface into the Switch's **Static/Default Route Settings** window, click the **Add** button, revealing the following window to configure.

Figure 6- 107. Static/Default Route Settings – Add window

The following fields can be set:

Parameter	Description
Backup State	Allows the user to configure the type of IP route entries on the Switch. <i>Default</i> – Choosing this parameter will allow the user to configure the default gateway for the next hop router only. <i>Static</i> – Choosing this parameter will allow the user to create static destination routes.
IP Address	Allows the entry of an IP address that will be a static entry into the Switch's Routing Table.
Subnet Mask	Allows the entry of a subnet mask corresponding to the IP address above.
Gateway IP	Allows the entry of an IP address of a gateway for the IP address above.
Metric (1-65535)	Allows the entry of a routing protocol metric representing the number of routers between the Switch and the IP address above.
Backup State	The user may choose between <i>Primary</i> and <i>Backup</i> . If the Primary Static/Default Route fails, the Backup Route will support the entry. Please take note that the Primary and Backup entries cannot have the same Gateway.

Click **Apply** to implement changes made.

Static ARP Table

The *Address Resolution Protocol (ARP)* is a TCP/IP protocol that converts IP addresses into physical addresses. This table allows network managers to view, define, modify and delete ARP information for specific devices.

Static entries can be defined in the **ARP Table**. When static entries are defined, a permanent entry is entered and is used to translate IP address to MAC addresses.

To open the **Static ARP Table** open the **Configuration** folder, and then open the **Layer 3 IP Networking** folder and click on the **Static ARP Settings** link.

Static ARP Settings				
Interface Name	IP Address	MAC Address	Type	Delete
System	10.1.1.2	00-05-5d-19-a5-ab	Static	Modify <input type="button" value="X"/>

Total Entries: 1

Figure 6- 108. Static ARP Settings window

To add a new entry, click the **Add** button, revealing the following screen to configure:

Static ARP Table - Add a New Entry	
IP Address	<input type="text" value="0.0.0.0"/>
MAC Address	<input type="text" value="00-00-00-00-00-00"/>
<input type="button" value="Apply"/>	
Show All Static ARP Entries	

Figure 6- 109. Static ARP Settings – Add window

To modify a current entry, click the corresponding **Modify** button of the entry to be modified, revealing the following screen to configure:

Static ARP Table - Modify	
IP Address	<input type="text" value="10.1.1.2"/>
MAC Address	<input type="text" value="00-05-5d-19-a5-ab"/>
<input type="button" value="Apply"/>	
Show All Static ARP Entries	

Figure 6- 110. Static ARP Settings – Edit window

The following fields can be set or viewed:

Parameter	Description
IP Address	The IP address of the ARP entry. This field cannot be edited in the Static ARP Settings – Edit window.
MAC Address	The MAC address of the ARP entry.

After entering the IP Address and MAC Address of the **Static ARP** entry, click **Apply** to implement the new entry. To completely clear the **Static ARP Settings**, click the **Clear All** button.

RIP

The Routing Information Protocol is a distance-vector routing protocol. There are two types of network devices running RIP - active and passive. Active devices advertise their routes to others through RIP messages, while passive devices listen to these messages. Both active and passive routers update their routing tables based upon RIP messages that active routers exchange. Only routers can run RIP in the active mode.

Every 30 seconds, a router running RIP broadcasts a routing update containing a set of pairs of network addresses and a distance (represented by the number of hops or routers between the advertising router and the remote network). So, the vector is the network address and the distance is measured by the number of routers between the local router and the remote network.

RIP measures distance by an integer count of the number of hops from one network to another. A router is one hop from a directly connected network, two hops from a network that can be reached through a router, etc. The more routers between a source and a destination, the greater the RIP distance (or hop count).

There are a few rules to the routing table update process that help to improve performance and stability. A router will not replace a route with a newly learned one if the new route has the same hop count (sometimes referred to as 'cost'). So learned routes are retained until a new route with a lower hop count is learned.

When learned routes are entered into the routing table, a timer is started. This timer is restarted every time this route is advertised. If the route is not advertised for a period of time (usually 180 seconds), the route is removed from the routing table.

RIP does not have an explicit method to detect routing loops. Many RIP implementations include an authorization mechanism (a password) to prevent a router from learning erroneous routes from unauthorized routers.

To maximize stability, the hop count RIP uses to measure distance must have a low maximum value. Infinity (that is, the network is unreachable) is defined as 16 hops. In other words, if a network is more than 16 routers from the source, the local router will consider the network unreachable.

RIP can also be slow to converge (to remove inconsistent, unreachable or looped routes from the routing table) because RIP messages propagate relatively slowly through a network.

Slow convergence can be solved by using split horizon update, where a router does not propagate information about a route back to the interface on which it was received. This reduces the probability of forming transient routing loops.

Hold down can be used to force a router to ignore new route updates for a period of time (usually 60 seconds) after a new route update has been received. This allows all routers on the network to receive the message.

A router can 'poison reverse' a route by adding an infinite (16) hop count to a route's advertisement. This is usually used in conjunction with triggered updates, which force a router to send an immediate broadcast when an update of an unreachable network is received.

RIP Version 1 Message Format

There are two types of RIP messages: routing information messages and information requests. Both types use the same format.

The Command field specifies an operation according the following table:

Command	Meaning
1	Request for partial or full routing information
2	Response containing network-distance pairs from sender's routing table
3	Turn on trace mode (obsolete)
4	Turn off trace mode (obsolete)
5	Reserved for Sun Microsystem's internal use
9	Update Request

10	Update Response
11	Update Acknowledgement

RIP Command Codes

The field VERSION contains the protocol version number (1 in this case), and is used by the receiver to verify which version of RIP the packet was sent.

RIP 1 Message

RIP is not limited to TCP/IP. Its address format can support up to 14 octets (when using IP, the remaining 10 octets must be zeros). Other network protocol suites can be specified in the Family of Source Network field (IP has a value of 2). This will determine how the address field is interpreted.

RIP specifies that the IP address, 0.0.0.0, denotes a default route.

The distances, measured in router hops are entered in the Distance to Source Network, and Distance to Destination Network fields.

RIP 1 Route Interpretation

RIP was designed to be used with classed address schemes, and does not include an explicit subnet mask. An extension to version 1 does allow routers to exchange subnetted addresses, but only if the subnet mask used by the network is the same as the subnet mask used by the address. This means the RIP version 1 cannot be used to propagate classless addresses.

Routers running RIP version 1 must send different update messages for each IP interface to which it is connected. Interfaces that use the same subnet mask as the router's network can contain subnetted routes, other interfaces cannot. The router will then advertise only a single route to the network.

RIP Version 2 Extensions

RIP version 2 includes an explicit subnet mask entry, so RIP version 2 can be used to propagate variable length subnet addresses or CIDR classless addresses. RIP version 2 also adds an explicit next hop entry, which speeds convergence and helps prevent the formation of routing loops.

RIP2 Message Format

The message format used with RIP2 is an extension of the RIP1 format:

RIP version 2 also adds a 16-bit route tag that is retained and sent with router updates. It can be used to identify the origin of the route.

Because the version number in RIP2 occupies the same octet as in RIP1, both versions of the protocols can be used on a given router simultaneously without interference.

RIP Global Configuration

To setup RIP for the IP interfaces configured on the Switch, the user must first globally enable RIP and then configure RIP settings for the individual IP interfaces. To globally enable RIP on the Switch, open the **Configuration** folder to **Layer 3 Networking** and then open the **RIP** folder and click on the **RIP Global Configuration** link to access the following screen:



Figure 6- 111. RIP Global Settings window

To enable RIP, simply use the pull-down menu, select **Enabled** and click **Apply**.

RIP Settings

RIP settings are configured for each IP interface on the Switch. Click the **RIP Interface Settings** link in the **RIP** folder. The menu appears in table form listing settings for IP interfaces currently on the Switch. To configure RIP settings for an individual interface, click on the hyperlinked **Interface Name**. To view the next page of RIP Interface Settings, click the **Next** button.

RIP Interface Settings					
Interface Name	IP Address	Tx Mode	RX Mode	Auth.	State
System	10.53.13.126	Disabled	Disabled	Disabled	Disabled
					Next

Figure 6- 112. RIP Interface Settings window

Click the hyperlinked name of the interface you want to set up for RIP, which will give access to the following menu:

RIP Interface Settings-Edit	
Interface Name	System
IP Address	10.53.13.126
Tx Mode	Disabled ▾
RX Mode	Disabled ▾
Authentication	Disabled ▾
Password	<input type="text"/>
State	Disabled ▾
Interface Metric	1
Apply	
Show All RIP Interface Entries	

Figure 6- 113. RIP Interface Settings - Edit window

Refer to the table below for a description of the available parameters for RIP interface settings.

The following RIP settings can be applied to each IP interface:

Parameter	Description
Interface Name	The name of the IP interface on which RIP is to be setup. This interface must be previously configured on the Switch.
IP Address	The IP address corresponding to the Interface Name showing in the field above.
TX Mode	Toggle among <i>Disabled</i> , <i>V1 Only</i> , <i>V1 Compatible</i> , and <i>V2 Only</i> . This entry specifies which version of the RIP protocol will be used to transmit RIP packets. <i>Disabled</i> prevents the transmission of RIP packets.
RX Mode	Toggle among <i>Disabled</i> , <i>V1 Only</i> , <i>V2 Only</i> , and <i>V1 or V2</i> . This entry specifies which version of the RIP protocol will be used to interpret received RIP packets. <i>Disabled</i> prevents the reception of RIP packets.
Authentication	Toggle between <i>Disabled</i> and <i>Enabled</i> to specify that routers on the network should use the Password above to authenticate router table exchanges.

Password	A password to be used to authenticate communication between routers on the network.
State	Toggle between <i>Disabled</i> and <i>Enabled</i> to disable or enable this RIP interface on the switch.
Interface Metric	A read only field that denotes the Metric value of the current IP Interface setting.

Click **Apply** to implement changes made.

OSPF

The Open Shortest Path First (OSPF) routing protocol uses a *link-state* algorithm to determine routes to network destinations. A “link” is an interface on a router and the “state” is a description of that interface and its relationship to neighboring routers. The state contains information such as the IP address, subnet mask, type of network the interface is attached to, other routers attached to the network, etc. The collection of link-states is then collected in a link-state database that is maintained by routers running OSPF.

OSPF specifies how routers will communicate to maintain their link-state database and defines several concepts about the topology of networks that use OSPF.

To limit the extent of link-state update traffic between routers, OSPF defines the concept of *Area*. All routers within an area share the exact same link-state database, and a change to this database on one router triggers an update to the link-state database of all other routers in that area. Routers that have interfaces connected to more than one area are called *Border Routers* and take the responsibility of distributing routing information between areas.

One area is defined as *Area 0* or the *Backbone*. This area is central to the rest of the network in that all other areas have a connection (through a router) to the backbone. Only routers have connections to the backbone and OSPF is structured such that routing information changes in other areas will be introduced into the backbone, and then propagated to the rest of the network.

When constructing a network to use OSPF, it is generally advisable to begin with the backbone (area 0) and work outward

Link-State Algorithm

An OSPF router uses a link-state algorithm to build a shortest path tree to all destinations known to the router. The following is a simplified description of the algorithm’s steps:

- When OSPF is started, or when a change in the routing information changes, the router generates a link-state advertisement. This advertisement is a specially formatted packet that contains information about all the link-states on the router.
- This link-state advertisement is flooded to all router in the area. Each router that receives the link-state advertisement will store the advertisement and then forward a copy to other routers.
- When the link-state database of each router is updated, the individual routers will calculate a Shortest Path Tree to all destinations – with the individual router as the root. The IP routing table will then be made up of the destination address, associated cost, and the address of the next hop to reach each destination.
- Once the link-state databases are updated, Shortest Path Trees calculated, and the IP routing tables written – if there are no subsequent changes in the OSPF network (such as a network link going down) there is very little OSPF traffic.

Shortest Path Algorithm

The Shortest Path to a destination is calculated using the Dijkstra algorithm. Each router is places at the root of a tree and then calculates the shortest path to each destination based on the cumulative cost to reach that destination over multiple possible routes. Each router will then have its own Shortest Path Tree (from the perspective of its location in the network area) even though every router in the area will have and use the exact same link-state database.

The following sections describe the information used to build the Shortest Path Tree.

OSPF Cost

Each OSPF interface has an associated cost (also called “metric”) that is representative of the overhead required to send packets over that interface. This cost is inversely proportional to the bandwidth of the interface (i.e. a higher bandwidth interface has a lower cost). There is then a higher cost (and longer time delays) in sending packets over a 56 Kbps dial-up connection than over a 10 Mbps Ethernet connection. The formula used to calculate the OSPF cost is as follows:

Cost = 100,000,000 / bandwidth in bps

As an example, the cost of a 10 Mbps Ethernet line will be 10 and the cost to cross a 1.544 Mbps T1 line will be 64.

Shortest Path Tree

To build Router A's shortest path tree for the network diagramed below, Router A is put at the root of the tree and the smallest cost link to each destination network is calculated.

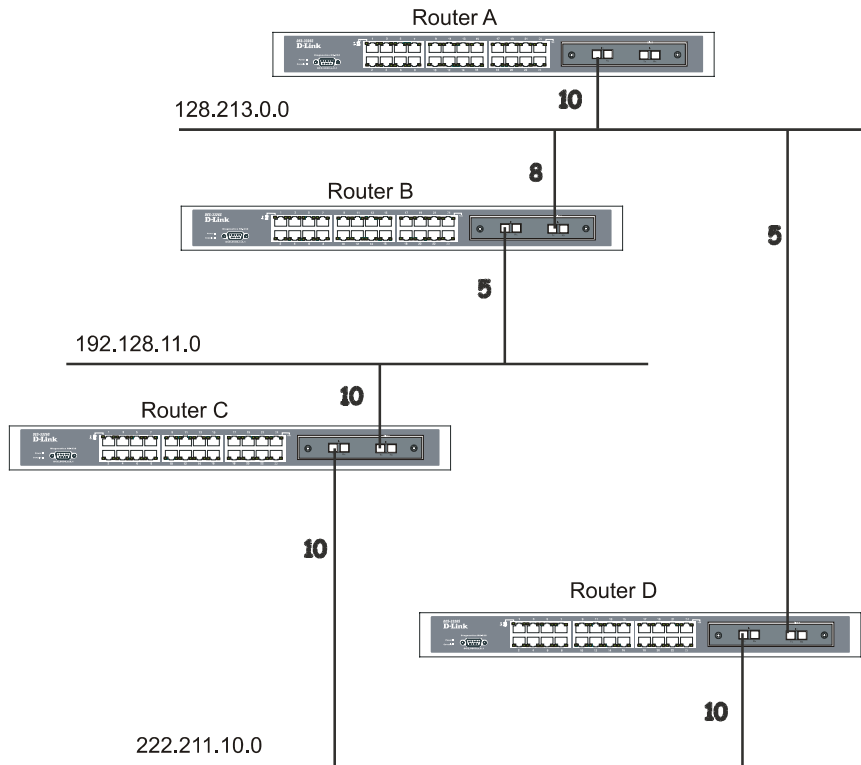

Figure 6- 114. Constructing a Shortest Path Tree

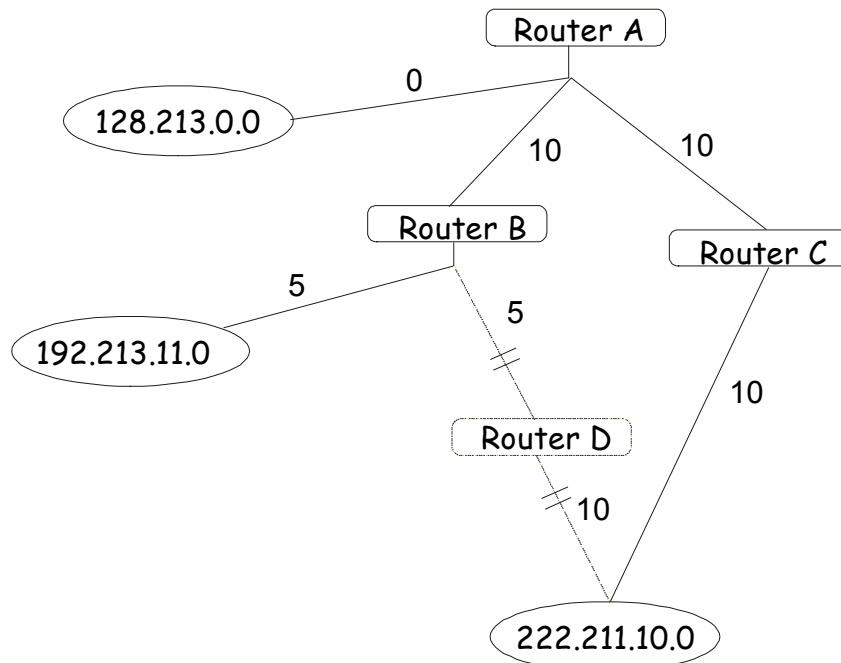

Figure 6- 115. Constructing a Shortest Path Tree

The diagram above shows the network from the viewpoint of Router A. Router A can reach 192.213.11.0 through Router B with a cost of $10 + 5 = 15$. Router A can reach 222.211.10.0 through Router C with a cost of $10 + 10 = 20$. Router A can also reach 222.211.10.0 through Router B and Router D with a cost of $10 + 5 + 10 = 25$, but the cost is higher than the route through Router C. This higher-cost route will not be included in the Router A's shortest path tree. The resulting tree will look like this:

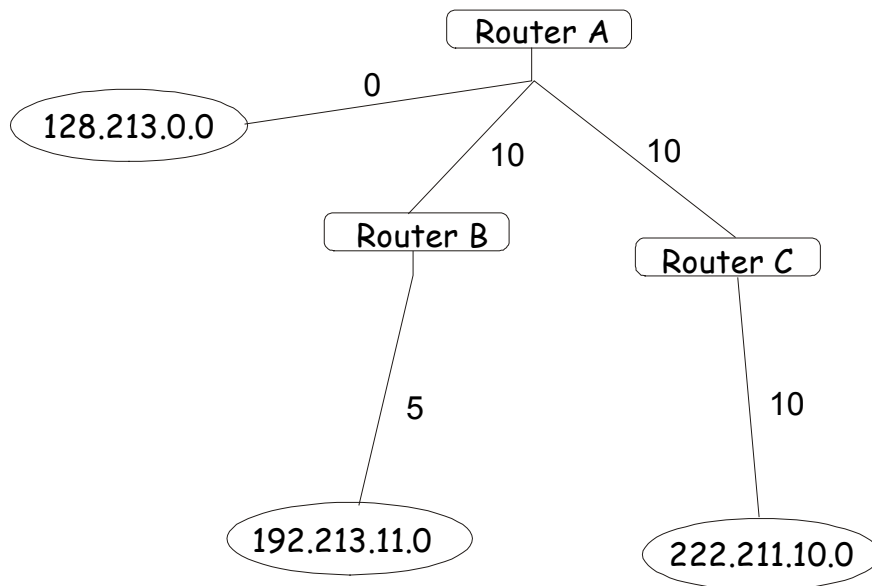

Figure 6- 116. Constructing a Shortest Path Tree - Completed

Note that this shortest path tree is only from the viewpoint of Router A. The cost of the link from Router B to Router A, for instance is not important to constructing Router A's shortest path tree, but is very important when Router B is constructing its shortest path tree.

Note also that directly connected networks are reached at a cost of zero, while other networks are reached at the cost calculated in the shortest path tree.

Router A can now build its routing table using the network addresses and costs calculated in building the above shortest path tree.

Areas and Border Routers

OSPF link-state updates are forwarded to other routers by flooding to all routers on the network. OSPF uses the concept of areas to define where on the network routers that need to receive particular link-state updates are located. This helps ensure that routing updates are not flooded throughout the entire network and to reduce the amount of bandwidth consumed by updating the various router's routing tables.

Areas establish boundaries beyond which link-state updates do not need to be flooded. So the exchange of link-state updates and the calculation of the shortest path tree are limited to the area that the router is connected to.

Routers that have connections to more than one area are called Border Routers (BR). The Border Routers have the responsibility of distributing necessary routing information and changes between areas.

Areas are specific to the router interface. A router that has all of its interfaces in the same area is called an Internal Router. A router that has interfaces in multiple areas is called a Border Router. Routers that act as gateways to other networks (possibly using other routing protocols) are called Autonomous System Border Routers (ASBRs).

Link-State Packets

There are a number of different types of link-state packets, four of which are illustrated below:

- Router Link-State Updates – These describe a router's links to destinations within an area.
- Summary Link-State Updates – Issued by Border Routers and describe links to networks outside the area but within the Autonomous System (AS).
- Network Link-State Updates – Issued by multi-access areas that have more than one attached router. One router is elected as the Designated Router (DR) and this router issues the network link-state updates describing every router on the segment.
- External Link-State Updates – Issued by an Autonomous System Border Router and describes routes to destinations outside the AS or a default route to the outside AS.

The format of these link-state updates is described in more detail below.

Router link-state updates are flooded to all routers in the current area. These updates describe the destinations reachable through all of the router's interfaces.

Summary link-state updates are generated by Border Routers to distribute routing information about other networks within the AS. Normally, all Summary link-state updates are forwarded to the backbone (area 0) and are then forwarded to all other areas in the network. Border Routers also have the responsibility of distributing routing information from the Autonomous System Border Router in order for routers in the network to get and maintain routes to other Autonomous Systems.

Network link-state updates are generated by a router elected as the Designated Router on a multi-access segment (with more than one attached router). These updates describe all of the routers on the segment and their network connections.

External link-state updates carry routing information to networks outside the Autonomous System. The Autonomous System Border Router is responsible for generating and distributing these updates.

OSPF Authentication

OSPF packets can be authenticated as coming from trusted routers by the use of predefined passwords. The default for routers is to use not authentication.

There are two other authentication methods – simple password authentication (key) and Message Digest authentication (MD-5).

Message Digest Authentication (MD-5)

MD-5 authentication is a cryptographic method. A key and a key-ID are configured on each router. The router then uses an algorithm to generate a mathematical “message digest” that is derived from the OSPF packet, the key and the key-ID. This message digest (a number) is then appended to the packet. The key is not exchanged over the wire and a non-decreasing sequence number is included to prevent replay attacks.

Simple Password Authentication

A password (or key) can be configured on a per-area basis. Routers in the same area that participate in the routing domain must be configured with the same key. This method is possibly vulnerable to passive attacks where a link analyzer is used to obtain the password.

Backbone and Area 0

OSPF limits the number of link-state updates required between routers by defining areas within which a given router operates. When more than one area is configured, one area is designated as area 0 – also called the backbone.

The backbone is at the center of all other areas – all areas of the network have a physical (or virtual) connection to the backbone through a router. OSPF allows routing information to be distributed by forwarding it into area 0, from which the information can be forwarded to all other areas (and all other routers) on the network.

In situations where an area is required, but is not possible to provide a physical connection to the backbone, a virtual link can be configured.

Virtual Links

Virtual links accomplish two purposes:

- Linking an area that does not have a physical connection to the backbone.
- Patching the backbone in case there is a discontinuity in area 0.

Areas Not Physically Connected to Area 0

All areas of an OSPF network should have a physical connection to the backbone, but in some cases it is not possible to physically connect a remote area to the backbone. In these cases, a virtual link is configured to connect the remote area to the backbone. A virtual path is a logical path between two border routers that have a common area, with one border router connected to the backbone.

Partitioning the Backbone

OSPF also allows virtual links to be configured to connect the parts of the backbone that are discontinuous. This is the equivalent to linking different area 0s together using a logical path between each area 0. Virtual links can also be added for redundancy to protect against a router failure. A virtual link is configured between two border routers that both have a connection to their respective area 0s.

Neighbors

Routers that are connected to the same area or segment become neighbors in that area. Neighbors are elected via the Hello protocol. IP multicast is used to send out Hello packets to other routers on the segment. Routers become neighbors when they see themselves listed in a Hello packet sent by another router on the same segment. In this way, two-way communication is guaranteed to be possible between any two neighbor routers.

Any two routers must meet the following conditions before they become neighbors:

- **Area ID** – Two routers having a common segment – their interfaces have to belong to the same area on that segment. Of course, the interfaces should belong to the same subnet and have the same subnet mask.
- **Authentication** – OSPF allows for the configuration of a password for a specific area. Two routers on the same segment and belonging to the same area must also have the same OSPF password before they can become neighbors.
- **Hello and Dead Intervals** – The Hello interval specifies the length of time, in seconds, between the hello packets that a router sends on an OSPF interface. The dead interval is the number of seconds that a router's Hello packets have not been seen before its neighbors declare the OSPF router down. OSPF routers exchange Hello packets on each segment in order to acknowledge each other's existence on a segment and to elect a Designated Router on multi-access segments. OSPF requires these intervals to be exactly the same between any two neighbors. If any of these intervals are different, these routers will not become neighbors on a particular segment.
- **Stub Area Flag** – Any two routers also have to have the same stub area flag in their Hello packets in order to become neighbors.

Adjacencies

Adjacent routers go beyond the simple Hello exchange and participate in the link-state database exchange process. OSPF elects one router as the Designated Router (DR) and a second router as the Backup Designated Router (BDR) on each multi-access segment (the BDR is a backup in case of a DR failure). All other routers on the segment will then contact the DR for link-state database updates and exchanges. This limits the bandwidth required for link-state database updates.

Designated Router Election

The election of the DR and BDR is accomplished using the Hello protocol. The router with the highest OSPF priority on a given multi-access segment will become the DR for that segment. In case of a tie, the router with the highest Router ID wins. The default OSPF priority is 1. A priority of zero indicates a router that cannot be elected as the DR.

Building Adjacency

Two routers undergo a multi-step process in building the adjacency relationship. The following is a simplified description of the steps required:

- **Down** – No information has been received from any router on the segment.
- **Attempt** – On non-broadcast multi-access networks (such as Frame Relay or X.25), this state indicates that no recent information has been received from the neighbor. An effort should be made to contact the neighbor by sending Hello packets at the reduced rate set by the Poll Interval.
- **Init** – The interface has detected a Hello packet coming from a neighbor but bi-directional communication has not yet been established.
- **Two-way** – Bi-directional communication with a neighbor has been established. The router has seen its address in the Hello packets coming from a neighbor. At the end of this stage the DR and BDR election would have been done. At the end of the Two-way stage, routers will decide whether to proceed in building an adjacency or not. The decision is based on whether one of the routers is a DR or a BDR or the link is a point-to-point or virtual link.
- **Exstart** – (Exchange Start) Routers establish the initial sequence number that is going to be used in the information exchange packets. The sequence number insures that routers always get the most recent information. One router will become the primary and the other will become secondary. The primary router will poll the secondary for information.
- **Exchange** – Routers will describe their entire link-state database by sending database description packets.

- **Loading** – The routers are finalizing the information exchange. Routers have link-state request list and a link-state retransmission list. Any information that looks incomplete or outdated will be put on the request list. Any update that is sent will be put on the retransmission list until it gets acknowledged.
- **Full** – The adjacency is now complete. The neighboring routers are fully adjacent. Adjacent routers will have the same link-state database.

Adjacencies on Point-to-Point Interfaces

OSPF Routers that are linked using point-to-point interfaces (such as serial links) will always form adjacencies. The concepts of DR and BDR are unnecessary.

OSPF Packet Formats

All OSPF packet types begin with a standard 24-byte header and there are five packet types. The header is described first, and each packet type is described in a subsequent section.

All OSPF packets (except for Hello packets) forward link-state advertisements. Link-State Update packets, for example, flood advertisements throughout the OSPF routing domain.

- OSPF packet header
- Hello packet
- Database Description packet
- Link-State Request packet
- Link-State Update packet
- Link-State Acknowledgment packet

OSPF Packet Header

Every OSPF packet is preceded by a common 24-byte header. This header contains the information necessary for a receiving router to determine if the packet should be accepted for further processing.

The format of the OSPF packet header is shown below:

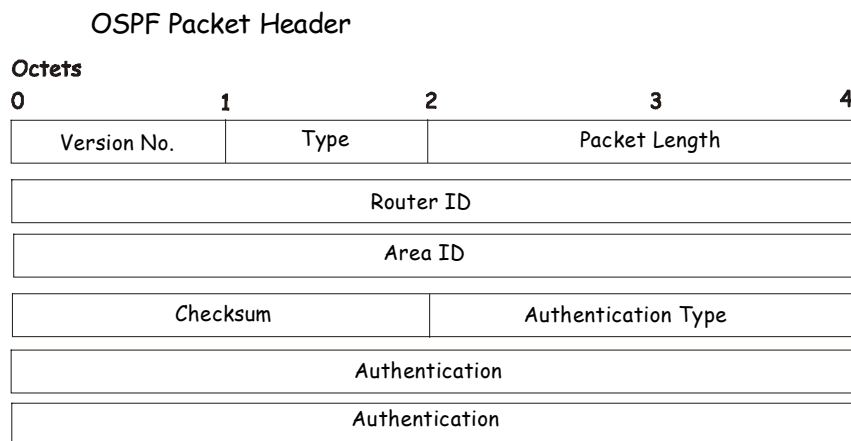

Figure 6- 117. OSPF Packet Header Format

Field	Description
Version No.	The OSPF version number
Type	The OSPF packet type. The OSPF packet types are as follows: Type Description Hello Database Description Link-State Request Link-State Update Link-State Acknowledgment
Packet Length	The length of the packet in bytes. This length includes the 24-byte header.

Router ID	The Router ID of the packet's source.
Area ID	A 32-bit number identifying the area that this packet belongs to. All OSPF packets are associated with a single area. Packets traversing a virtual link are assigned the backbone Area ID of 0.0.0.0
Checksum	A standard IP checksum that includes all of the packet's contents except for the 64-bit authentication field.
Authentication Type	The type of authentication to be used for the packet.
Authentication	A 64-bit field used by the authentication scheme.

Hello Packet

Hello packets are OSPF packet type 1. They are sent periodically on all interfaces, including virtual links, in order to establish and maintain neighbor relationships. In addition, Hello Packets are multicast on those physical networks having a multicast or broadcast capability, enabling dynamic discovery of neighboring routers.

All routers connected to a common network must agree on certain parameters such as the Network Mask, the Hello Interval, and the Router Dead Interval. These parameters are included in the hello packets, so that differences can inhibit the forming of neighbor relationships. A detailed explanation of the receive process for Hello packets is necessary so that differences can inhibit the forming of neighbor relationships.

The format of the Hello packet is shown below:

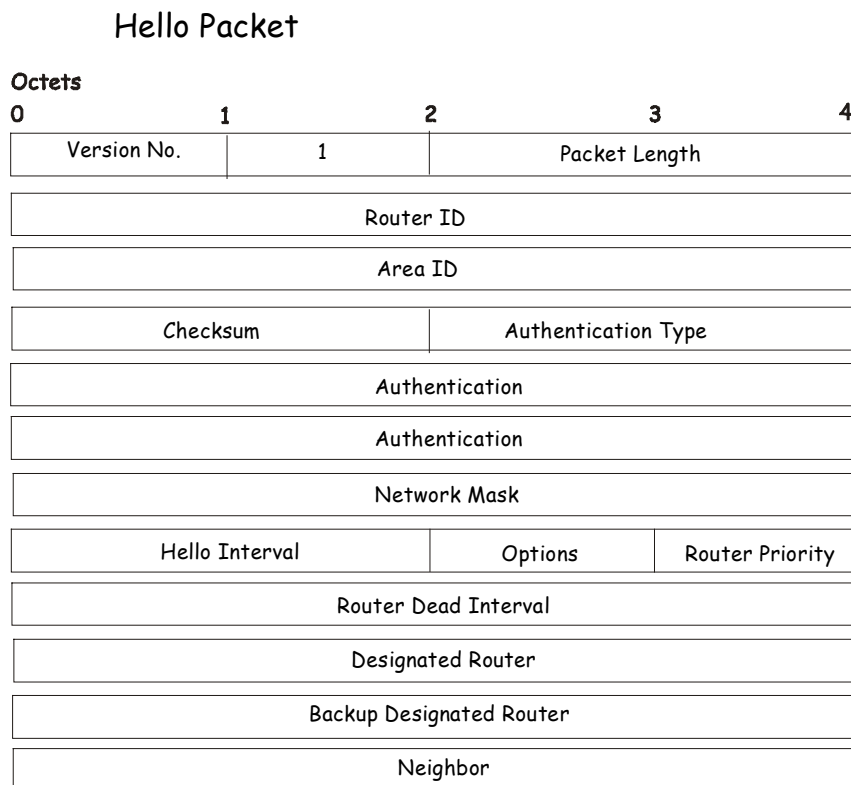

Figure 6- 118. Hello Packet

Field	Description
Network Mask	The network mask associated with this interface.
Options	The optional capabilities supported by the router.
Hello Interval	The number of seconds between this router's Hello packets.
Router Priority	This router's Router Priority. The Router Priority is used in the election of the DR and BDR. If this field is set to 0, the router is ineligible to become the DR or the BDR.
Router Dead Interval	The number of seconds that must pass before declaring a silent router as down.
Designated Router	The identity of the DR for this network, in the view of the advertising router. The DR is identified here by its IP interface address on the network.
Backup Designated Router	The identity of the Backup Designated Router (BDR) for this network. The BDR is identified here by its IP interface address on the network. This field is set to 0.0.0.0 if there is no BDR.
Field	Description
Neighbor	The Router IDs of each router from whom valid Hello packets have been seen within the Router Dead Interval on the network.

Database Description Packet

Database Description packets are OSPF packet type 2. These packets are exchanged when an adjacency is being initialized. They describe the contents of the topological database. Multiple packets may be used to describe the database. For this purpose, a poll-response procedure is used. One of the routers is designated to be master, the other a slave. The master sends Database Description packets (polls) that are acknowledged by Database Description packets sent by the slave (responses). The responses are linked to the polls via the packets' DD sequence numbers.

Database Description Packet

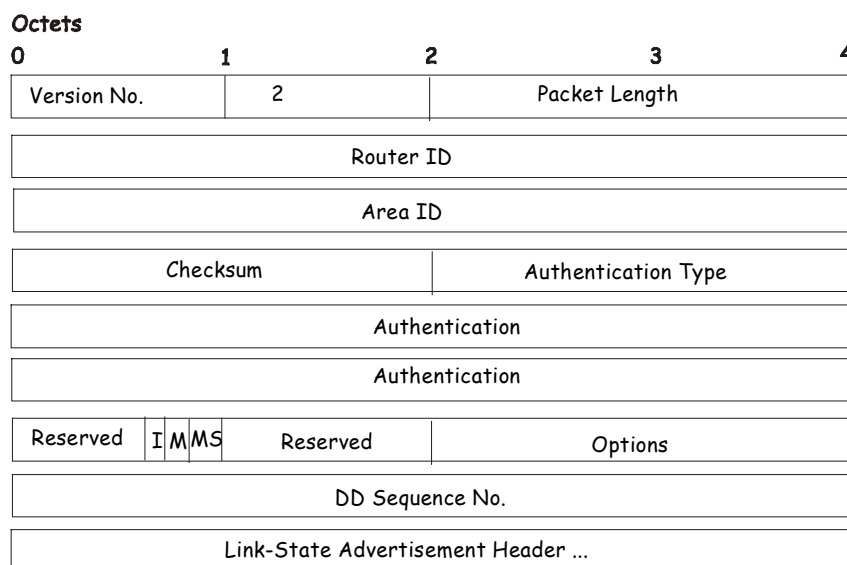

Figure 6- 119. Database Description Packet

Field	Description
Options	The optional capabilities supported by the router.
I - bit	The Initial bit. When set to 1, this packet is the first in the sequence of Database Description packets.
M - bit	The More bit. When set to 1, this indicates that more Database Description packets will follow.
MS - bit	The Master Slave bit. When set to 1, this indicates that the router is the master during the Database Exchange process. A zero indicates the opposite.
DD Sequence Number	User to sequence the collection of Database Description Packets. The initial value (indicated by the Initial bit being set) should be unique. The DD sequence number then increments until the complete database description has been sent.

The rest of the packet consists of a list of the topological database's pieces. Each link state advertisement in the database is described by its link state advertisement header.

Link-State Request Packet

Link-State Request packets are OSPF packet type 3. After exchanging Database Description packets with a neighboring router, a router may find that parts of its topological database are out of date. The Link-State Request packet is used to request the pieces of the neighbor's database that are more up to date. Multiple Link-State Request packets may need to be used. The sending of Link-State Request packets is the last step in bringing up an adjacency.

A router that sends a Link-State Request packet has in mind the precise instance of the database pieces it is requesting, defined by LS sequence number, LS checksum, and LS age, although these fields are not specified in the Link-State Request packet itself. The router may receive even more recent instances in response.

The format of the Link-State Request packet is shown below:

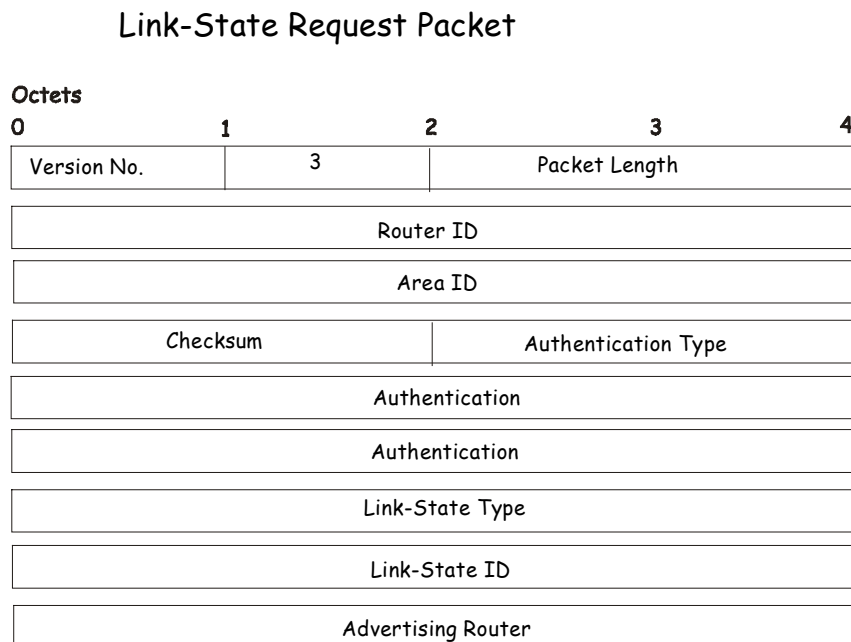

Figure 6- 120. Link-State Request Packet

Each advertisement requested is specified by its Link-State Type, Link-State ID, and Advertising Router. This uniquely identifies the advertisement, but not its instance. Link-State Request packets are understood to be requests for the most recent instance.

Link-State Update Packet

Link-State Update packets are OSPF packet type 4. These packets implement the flooding of link-state advertisements. Each Link-State Update packet carries a collection of link-state advertisements one hop further from its origin. Several link-state advertisements may be included in a single packet.

Link-State Update packets are multicast on those physical networks that support multicast/broadcast. In order to make the flooding procedure reliable, flooded advertisements are acknowledged in Link-State Acknowledgment packets. If retransmission of certain advertisements is necessary, the retransmitted advertisements are always carried by unicast Link-State Update packets.

The format of the Link-State Update packet is shown below:

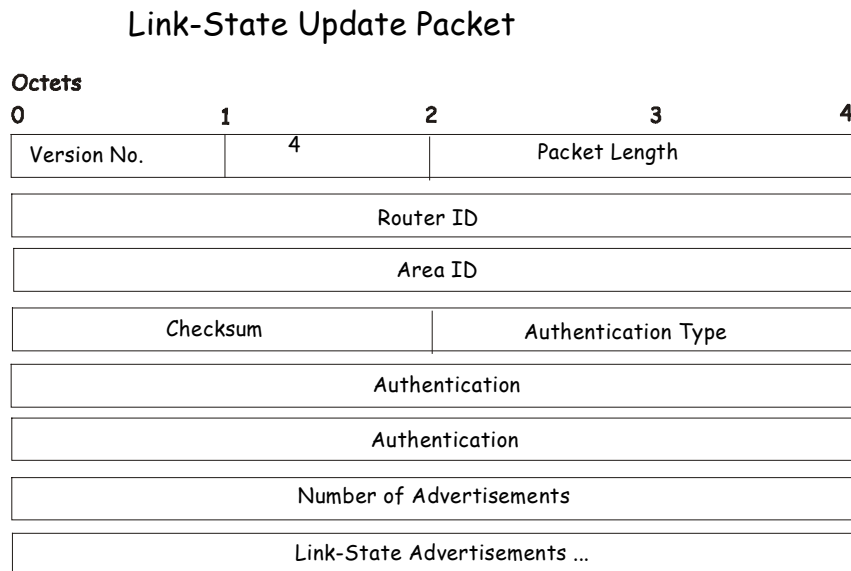

Figure 6- 121. Link-State Update Packet

The body of the Link-State Update packet consists of a list of link-state advertisements. Each advertisement begins with a common 20-byte header, the link-state advertisement header. Otherwise, the format of each of the five types of link-state advertisements is different.

Link-State Acknowledgment Packet

Link-State Acknowledgment packets are OSPF packet type 5. To make the folding of link-state advertisements reliable, flooded advertisements are explicitly acknowledged. This acknowledgment is accomplished through the sending and receiving of Link-State Acknowledgment packets. Multiple link-state advertisements can be acknowledged in a single Link-State Acknowledgment packet.

Depending on the state of the sending interface and the source of the advertisements being acknowledged, a Link-State Acknowledgment packet is sent either to the multicast address AllSPFRouters, to the multicast address AllDRouters, or as a unicast packet.

The format of this packet is similar to that of the Data Description packet. The body of both packets is simply a list of link-state advertisement headers.

The format of the Link-State Acknowledgment packet is shown below:

Link-State Acknowledgment Packet

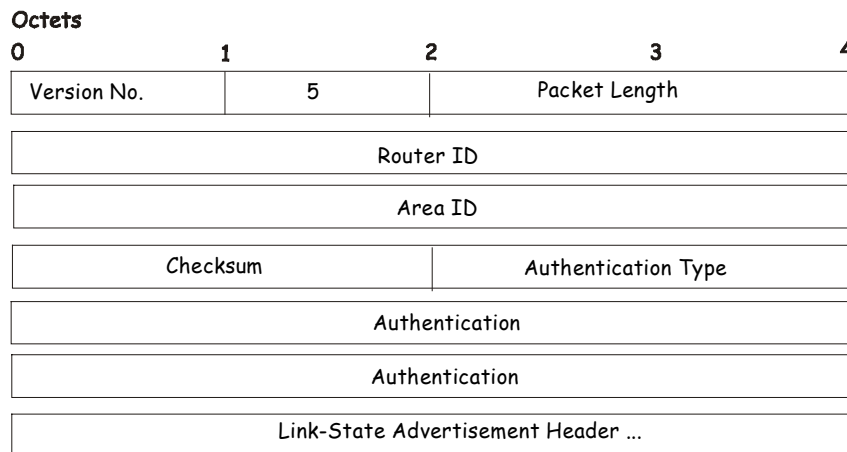

Figure 6- 122. Link State Acknowledge Packet

Each acknowledged link-state advertisement is described by its link-state advertisement header. It contains all the information required to uniquely identify both the advertisement and the advertisement's current instance.

Link-State Advertisement Formats

There are five distinct types of link-state advertisements. Each link-state advertisement begins with a standard 20-byte link-state advertisement header. Succeeding sections then diagram the separate link-state advertisement types.

Each link-state advertisement describes a piece of the OSPF routing domain. Every router originates a router links advertisement. In addition, whenever the router is elected as the Designated Router, it originates a network links advertisement. Other types of link-state advertisements may also be originated. The flooding algorithm is reliable, ensuring that all routers have the same collection of link-state advertisements. The collection of advertisements is called the link-state (or topological) database.

From the link-state database, each router constructs a shortest path tree with itself as root. This yields a routing table.

There are four types of link state advertisements, each using a common link state header. These are:

- Router Links Advertisements
- Network Links Advertisements
- Summary Link Advertisements
- Autonomous System Link Advertisements

Link State Advertisement Header

All link state advertisements begin with a common 20-byte header. This header contains enough information to uniquely identify the advertisements (Link State Type, Link State ID, and Advertising Router). Multiple instances of the link state advertisement may exist in the routing domain at the same time. It is then necessary to determine which instance is more recent. This is accomplished by examining the link state age, link state sequence number and link state checksum fields that are also contained in the link state advertisement header.

The format of the Link State Advertisement Header is shown below:

Link-State Advertisement Header

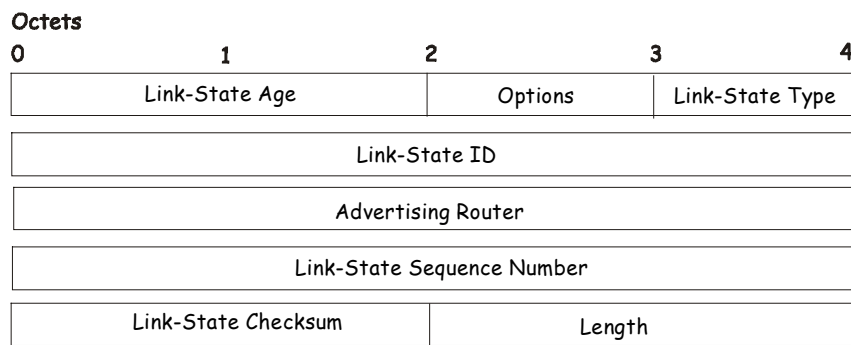

Figure 6- 123. Link State Advertisement Header

Field	Description
Link State Age	The time in seconds since the link state advertisement was originated.
Options	The optional capabilities supported by the described portion of the routing domain.
Link State Type	The type of the link state advertisement. Each link state type has a separate advertisement format. The link state types are as follows: Router Links, Network Links, Summary Link (IP Network), Summary Link (ASBR), AS External Link.
Link State ID	This field identifies the portion of the internet environment that is being described by the advertisement. The contents of this field depend on the advertisement's Link State Type.
Advertising Router	The Router ID of the router that originated the Link State Advertisement. For example, in network links advertisements this field is set to the Router ID of the network's Designated Router.
Link State Sequence Number	Detects old or duplicate link state advertisements. Successive instances of a link state advertisement are given successive Link State Sequence numbers.
Link State Checksum	The Fletcher checksum of the complete contents of the link state advertisement, including the link state advertisement header by accepting the Link State Age field.
Length	The length in bytes of the link state advertisement. This includes the 20-byte link state advertisement header.

Router Links Advertisements

Router links advertisements are type 1 link state advertisements. Each router in an area originates a router links advertisement. The advertisement describes the state and cost of the router's links to the area. All of the router's links to the area must be described in a single router links advertisement.

The format of the Router Links Advertisement is shown below:

Routers Links Advertisements

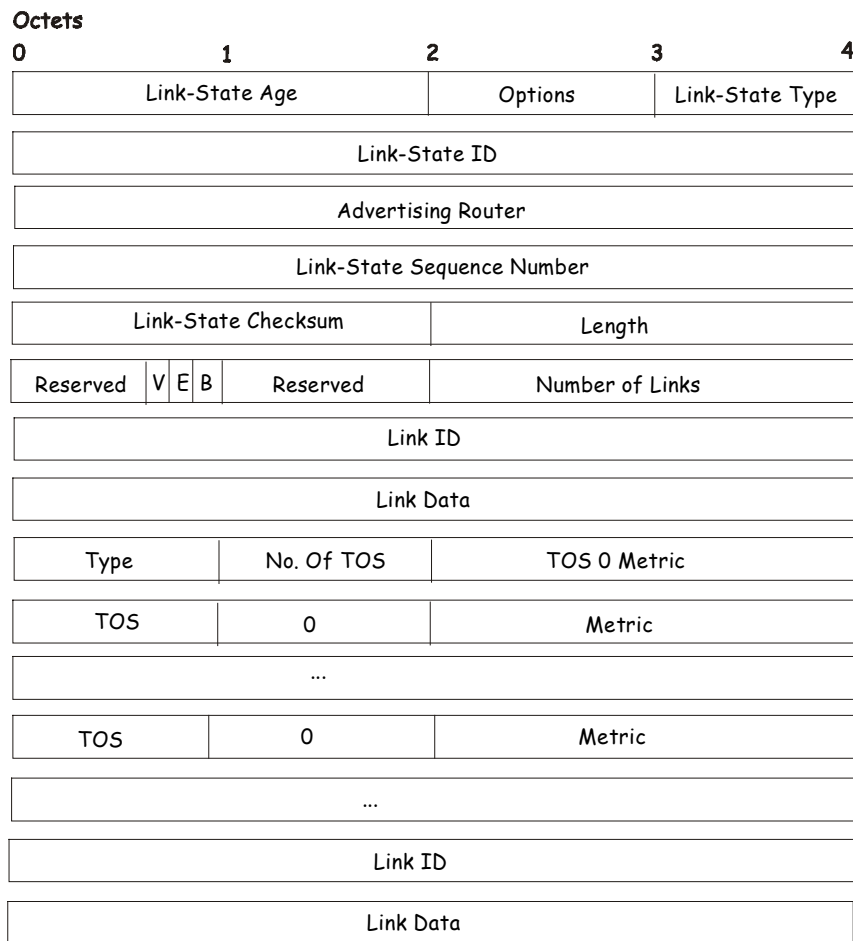

Figure 6- 124. Routers Links Advertisements

In router links advertisements, the Link State ID field is set to the router's OSPF Router ID. The T - bit is set in the advertisement's Option field if and only if the router is able to calculate a separate set of routes for each IP Type of Service (TOS). Router links advertisements are flooded throughout a single area only.

Field	Description
V - bit	When set, the router is an endpoint of an active virtual link that is using the described area as a Transit area (V is for Virtual link endpoint).
E - bit	When set, the router is an Autonomous System (AS) boundary router (E is for External).
B - bit	When set, the router is an area border router (B is for Border).
Number of Links	The number of router links described by this advertisement. This must be the total collection of router links to the area.

The following fields are used to describe each router link. Each router link is typed. The Type field indicates the kind of link being described. It may be a link to a transit network, to another router or to a stub network. The values of all the other fields describing a router link depend on the link's Type. For example, each link has an associated 32-bit data field. For links to stub networks, this field specifies the network's IP address mask. For other link types, the Link Data specifies the router's associated IP interface address.

Field	Description
Type	A quick classification of the router link. One of the following: Type Description Point-to-point connection to another router. Connection to a transit network. Connection to a stub network. Virtual link.
Link ID	Identifies the object that this router link connects to. Value depends on the link's Type. When connecting to an object that also originates a link state advertisement (i.e. another router or a transit network) the Link ID is equal to the neighboring advertisement's Link State ID. This provides the key for looking up an advertisement in the link state database. Type Link ID Neighboring router's Router ID. IP address of Designated Router. IP network/subnet number. Neighboring router's Router ID
Link Data	Contents again depend on the link's Type field. For connections to stub networks, it specifies the network's IP address mask. For unnumbered point-to-point connection, it specifies the interface's MIB-II ifIndex value. For other link types it specifies the router's associated IP interface address. This latter piece of information is needed during the routing table build process, when calculating the IP address of the next hop.
No. of TOS	The number of different Type of Service (TOS) metrics given for this link, not counting the required metric for TOS 0. If no additional TOS metrics are given, this field should be set to 0.
TOS 0 Metric	The cost of using this router link for TOS 0.

For each link, separate metrics may be specified for each Type of Service (TOS). The metric for TOS 0 must always be included, and was discussed above. Metrics for non-zero TOS are described below. Note that the cost for non-zero TOS values that are not specified defaults to the TOS 0 cost. Metrics must be listed in order of increasing TOS encoding. For example, the metric for TOS 16 must always follow the metric for TOS 8 when both are specified.

Field	Description
TOS	IP Type of Service that this metric refers to.
Metric	The cost of using this outbound router link, for traffic of the specified TOS.

Network Links Advertisements

Network links advertisements are Type 2 link state advertisements. A network links advertisement is originated for each transit network in the area. A transit network is a multi-access network that has more than one attached router. The network links advertisement is originated by the network's Designated router. The advertisement describes all routers attached to the network, including the Designated Router itself. The advertisement's Link State ID field lists the IP interface address of the Designated Router.

The distance from the network to all attached routers is zero, for all TOS. This is why the TOS and metric fields need not be specified in the network links advertisement.

The format of the Network Links Advertisement is shown below:

Network Link Advertisements

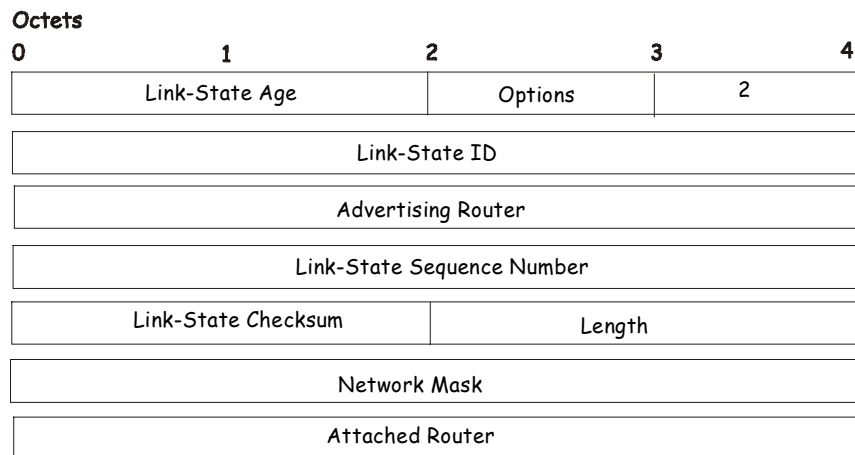

Figure 6- 125. Network Link Advertisements

Field	Description
Network Mask	The IP address mask for the network.
Attached Router	The Router Ids of each of the routers attached to the network. Only those routers that are fully adjacent to the Designated Router (DR) are listed. The DR includes itself in this list.

Summary Link Advertisements

Summary link advertisements are Type 3 and 4 link state advertisements. These advertisements are originated by Area Border routers. A separate summary link advertisement is made for each destination known to the router, that belongs to the Autonomous System (AS), yet is outside the area.

Type 3 link state advertisements are used when the destination is an IP network. In this case, the advertisement's Link State ID field is an IP network number. When the destination is an AS boundary router, a Type 4 advertisement is used, and the Link State ID field is the AS boundary router's OSPF Router ID. Other than the difference in the Link State ID field, the format of Type 3 and 4 link state advertisements is identical.

Summary Link Advertisements

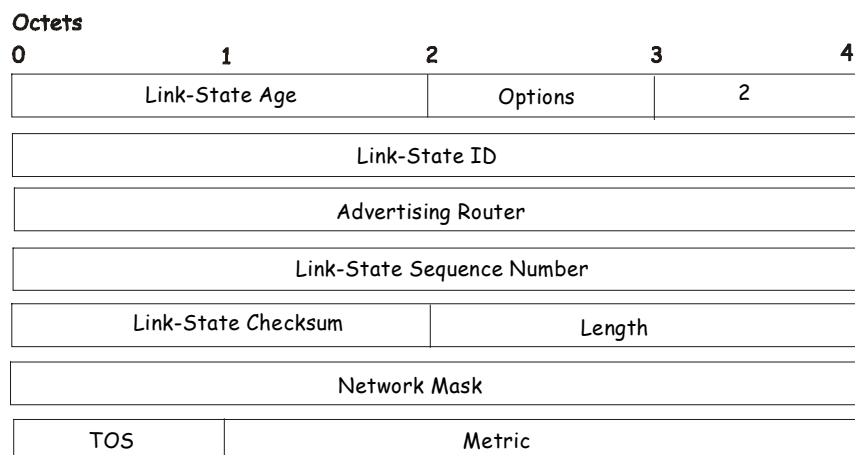

Figure 6- 126. Summary Link Advertisements

For stub area, Type 3 summary link advertisements can also be used to describe a default route on a per-area basis. Default summary routes are used in stub area instead of flooding a complete set of external routes. When describing a default

summary route, the advertisement's Link State ID is always set to the Default Destination – 0.0.0.0, and the Network Mask is set to 0.0.0.0.

Separate costs may be advertised for each IP Type of Service. Note that the cost for TOS 0 must be included, and is always listed first. If the T-bit is reset in the advertisement's Option field, only a route for TOS 0 is described by the advertisement. Otherwise, routes for the other TOS values are also described. If a cost for a certain TOS is not included, its cost defaults to that specified for TOS 0.

Field	Description
Network Mask	For Type 3 link state advertisements, this indicates the destination network's IP address mask. For example, when advertising the location of a class A network the value 0xff000000
TOS	The Type of Service that the following cost is relevant to.
Metric	The cost of this route. Expressed in the same units as the interface costs in the router links advertisements.

Autonomous Systems External Link Advertisements

Autonomous Systems (AS) link advertisements are Type 5 link state advertisements. These advertisements are originated by AS boundary routers. A separate advertisement is made for each destination known to the router that is external to the AS.

AS external link advertisements usually describe a particular external destination. For these advertisements the Link State ID field specifies an IP network number. AS external link advertisements are also used to describe a default route. Default routes are used when no specific route exists to the destination. When describing a default route, the Link Stat ID is always set the Default Destination address (0.0.0.0) and the Network Mask is set to 0.0.0.0.

The format of the AS External Link Advertisement is shown below:

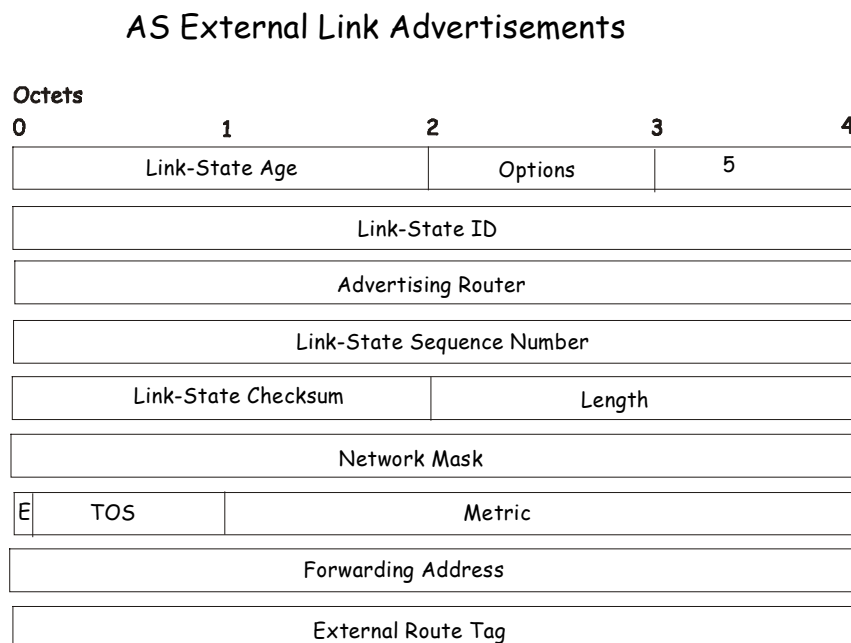

Figure 6- 127. AS External Link Advertisements

Field	Description
Network Mask	The IP address mask for the advertised destination.
E - bit	The type of external metric. If the E - bit is set, the metric specified is a Type 2 external metric. This means the metric is considered larger than any link state path. If the E - bit is zero, the specified metric is a Type 1 external metric. This means that is comparable directly to the link state metric.
Forwarding Address	Data traffic for the advertised destination will be forwarded to this address. If the Forwarding Address is set to 0.0.0.0, data traffic will be forwarded instead to the advertisement's originator.
TOS	The Type of Service that the following cost is relevant to.
Metric	The cost of this route. The interpretation of this metric depends on the external type indication (the E - bit above).
External Route Tag	A 32-bit field attached to each external route. This is not used by the OSPF protocol itself.

OSPF General Settings

The **OSPF General Settings** menu allows OSPF to be enabled or disabled on the Switch – without changing the Switch's OSPF configuration.

To view the following window, click **Configuration > Layer 3 IP Networking > OSPF > General**. To enable OSPF, first supply an **OSPF Route ID** (see below), select *Enabled* from the **State** drop-down menu and click the **Apply** button.

Figure 6- 128. OSPF General Settings window

The following parameters are used for general OSPF configuration:

Parameter	Description
OSPF Route ID	A 32-bit number (in the same format as an IP address – xxx.xxx.xxx.xxx) that uniquely identifies the Switch in the OSPF domain. It is common to assign the highest IP address assigned to the Switch (router). In this case, it would be 10.53.13.189, but any unique 32-bit number will do. If 0.0.0.0 is entered, the highest IP address assigned to the Switch will become the OSPF Route ID.
Current Route ID	Displays the OSPF Route ID currently in use by the Switch. This Route ID is displayed as a convenience to the user when changing the Switch's OSPF Route ID.
State	Allows OSPF to be enabled or disabled globally on the Switch without changing the OSPF configuration.

OSPF Area ID Settings

This menu allows the configuration of OSPF Area IDs and to designate these areas as either **Normal** or **Stub**. Normal OSPF areas allow Link-State Database (LSDB) advertisements of routes to networks that are external to the area. Stub areas do not allow the LSDB advertisement of external routes. Stub areas use a default summary external route (0.0.0.0 or Area 0) to reach external destinations.

To set up an OSPF area configuration click **Configuration > Layer 3 IP Networking > OSPF > OSPF Area ID Settings** link to open the following dialog box:

OSPF Area ID Settings				
Area ID	Type	Stub Import Summary LSA	Stub Default Cost	
0.0.0.0	Normal	Disabled	1	
				Add/Modify
OSPF Area ID Table				
Area ID	Type	Stub Import Summary LSA	Stub Default Cost	Delete
0.0.0.0	Normal	None	None	X

Figure 6- 129. OSPF Area Settings and Table window

To add an OSPF Area to the table, type a unique **Area ID** (see below) select the **Type** from the drop-down menu. For a Stub type, choose *Enabled* or *Disabled* from the **Stub Import Summary LSA** drop-down menu and determine the **Stub Default Cost**. Click the **Add/Modify** button to add the area ID set to the table.

To remove an Area ID configuration set, simply click  in the **Delete** column for the configuration.

To change an existing set in the list, type the **Area ID** of the set you want to change, make the changes and click the **Add/Modify** button. The modified OSPF area ID will appear in the table.

OSPF Area ID Settings				
Area ID	Type	Stub Import Summary LSA	Stub Default Cost	
0.0.0.0	Stub	Disabled	1	
				Add/Modify
OSPF Area ID Table				
Area ID	Type	Stub Import Summary LSA	Stub Default Cost	Delete
0.0.0.0	Normal	None	None	X
10.53.13.94	Stub	Disabled	1	X

Figure 6- 130. OSPF Area Settings example window

See the parameter descriptions below for information on the **OSPF Area ID Settings**.

The **Area ID** settings are as follows:

Parameter	Description
Area ID	A 32-bit number in the form of an IP address (xxx.xxx.xxx.xxx) that uniquely identifies the OSPF area in the OSPF domain.
Type	This field can be toggled between <i>Normal</i> and <i>Stub</i> using the space bar. When it is toggled to <i>Stub</i> , additional fields appear – Stub Import Summary LSA , and the Stub Default Cost .

Stub Import Summary LSA	Displays whether or not the selected Area will allow Summary Link-State Advertisements (Summary LSAs) to be imported into the area from other areas.
Stub Default Cost	Displays the default cost for the route to the stub of between 0 and 65,535. The default is 1.

OSPF Interface Settings

To set up OSPF interfaces, click **Configuration > Layer 3 IP Networking > OSPF > OSPF Interface Settings** to view OSPF settings for existing IP interfaces. If there are no IP interfaces configured (besides the default System interface), only the System interface settings will appear listed. To change settings for in IP interface, click on the hyperlinked name of the interface to see the configuration menu for that interface.

OSPF Interface Settings					
Interface Name	IP Address	Area ID	Auth. Type	State	Metric
System	10.53.13.121	0.0.0.0	None	Disabled	1
Trinity	12.1.1.1	0.0.0.0	None	Disabled	1

Figure 6- 131. OSPF Interface Settings window

OSPF Interface Settings - Edit	
Interface Name	System
IP Address	10.53.13.65(Link Up)
Network Medium Type	BROADCAST
Area ID	<input type="text" value="0.0.0.0"/>
Router Priority	<input type="text" value="1"/>
Hello Interval	<input type="text" value="10"/>
Dead Interval	<input type="text" value="40"/>
State	Disabled <input type="button" value="v"/>
Auth. Type	None <input type="button" value="v"/>
Auth. Key ID	<input type="text"/>
Metric	<input type="text" value="1"/>
DR State	DOWN
DR Address	0.0.0.0
Backup DR Address	0.0.0.0
transmit Delay	1
Retransmit Time	5
<input type="button" value="Apply"/>	
Show All OSPF Interface Entries	

Figure 6- 132. OSPF Interface Settings - Edit window

Configure each IP interface individually using the **OSPF Interface Settings - Edit** menu. Click the **Apply** button when you have entered the settings. The new configuration appears listed in the **OSPF Interface Settings** table. To return to the **OSPF Interface Settings** table, click the [Show All OSPF Interface Entries](#) link.

OSPF interface settings are described below. Some OSPF interface settings require previously configured OSPF settings. Read the descriptions below for details.

Parameter	Description
Interface Name	Displays the of an IP interface previously configured on the Switch.
IP Address	Displays the IP address of the interface and its current status (Link Up / Link Down)
Network Medium Type	A read only field describing the type of network medium in use. This field will only read Broadcast due to OSPF configurations permanently set in the Switch.
Area ID	Allows the entry of an OSPF Area ID configured above.
Router Priority	Allows the entry of a number between 0 and 255 representing the OSPF priority of the selected area. If a Router Priority of 0 is selected, the Switch cannot be elected as the Designated Router for the network.
Hello Interval	Allows the specification of the interval between the transmission of OSPF Hello packets, in seconds. Between 1 and 65535 seconds can be specified. The Hello Interval , Dead Interval , Authorization Type , and Authorization Key should be the same for all routers on the same network.
Dead Interval	Allows the specification of the length of time between the receipt of Hello packets from a neighbor router before the selected area declares that router down. An interval between 1 and 65535 seconds can be specified. The Dead Interval must be evenly divisible by the Hello Interval .
State	Allows the OSPF interface to be disabled for the selected area without changing the configuration for that area.
Auth Type	<p>This field can be toggled between None, Simple, and MD5 using the space bar. This allows a choice of authorization schemes for OSPF packets that may be exchanged over the OSPF routing domain.</p> <ul style="list-style-type: none"> • None specifies no authorization. • Simple uses a simple password to determine if the packets are from an authorized OSPF router. When Simple is selected, the Auth Key field allows the entry of an 8-character password that must be the same as a password configured on a neighbor OSPF router. • MD5 uses a cryptographic key entered in the MD5 Key Table Configuration menu. When MD5 is selected, the Auth Key ID field allows the specification of the Key ID as defined in the MD5 configuration above. This must be the same MD5 Key as used by the neighboring router.
Auth. Key ID	Enter a Key ID of up to 5 characters to set the Auth. Key ID for either the Simple Auth Type or the MD5 Auth Type, as specified in the previous parameter.
Metric	This field allows the entry of a number between 1 and 65,535 that is representative of the OSPF cost of reaching the selected OSPF interface. The default metric is 1.
DR State	A read only field describing the Designated Router state of the IP interface. This field may read DR if the interface is the designated router, or Backup DR if the interface is the Backup Designated Router. The highest IP address will be the Designated Router and is determined by the OSPF Hello Protocol of the Switch.
DR Address	The IP address of the aforementioned Designated Router.
Backup DR Address	The IP address of the aforementioned Backup Designated Router.

Transmit Delay	A read only field that denotes the estimated time to transmit a Link State Update Packet over this interface, in seconds.
Retransmit Time	A read only field that denotes the time between LSA retransmissions over this interface, in seconds.

OSPF Virtual Interface Settings

Click the **OSPF Virtual Interface Settings** link to view the current **OSPF Virtual Interface Settings**. There are not virtual interface settings configured by default, so the first time this table is viewed there will be not interfaces listed. To add a new OSPF virtual interface configuration set to the table, click the **Add** button. A new menu appears (see below). To change an existing configuration, click on the hyperlinked **Transit Area ID** for the set you want to change. The menu to modify an existing set is the same as the menu used to add a new one. To eliminate an existing configuration, click the  in the **Delete** column.

Add								
OSPF Virtual Interface Settings								
Transit Area ID	Neighbor Router ID	Hello Interval	Dead Interval	Auth. Type	Transmit Delay	RetransInterval	Status	Delete

Figure 6- 133. OSPF Virtual Link Settings

The status of the virtual interface appears (Up or Down) in the **Status** column.

OSPF Virtual Link Settings - Add	
Transit Area ID	<input type="text" value="0.0.0.0"/>
Neighbor Router ID	<input type="text" value="0.0.0.0"/>
Hello Interval(1-65535)	<input type="text" value="10"/>
Dead Interval(1-65535)	<input type="text" value="60"/>
Auth Type	None <input type="button" value="v"/>
Password/Auth. Key ID	<input type="text"/>
Transmit Delay	<input type="text" value="1"/>
Retransmit Interval	<input type="text" value="5"/>
<input type="button" value="Apply"/>	
Show All OSPF Virtual Link Entries	

Figure 6- 134. OSPF Virtual Link Settings – Add

Configure the following parameters if you are adding or changing an **OSPF Virtual Interface**:

Parameter	Description
Transit Area ID	Allows the entry of an OSPF Area ID – previously defined on the Switch – that allows a remote area to communicate with the backbone (area 0). A Transit Area cannot be a Stub Area or a Backbone Area.

Neighbor Router	The OSPF router ID for the remote router. This is a 32-bit number in the form of an IP address (xxx.xxx.xxx.xxx) that uniquely identifies the remote area's Area Border Router.
Hello Interval (1-65535)	Specify the interval between the transmission of OSPF Hello packets, in seconds. Enter a value between 1 and 65535 seconds. The Hello Interval , Dead Interval , Authorization Type , and Authorization Key should have identical settings for all routers on the same network.
Dead Interval (1-65535)	Specify the length of time between (receiving) Hello packets from a neighbor router before the selected area declares that router down. Again, all routers on the network should use the same setting.
Auth Type	If using authorization for OSPF routers, select the type being used. MD5 key authorization must be set up in the MD5 Key Settings menu.
Password/Auth. Key ID	Enter a case-sensitive password for simple authorization or enter the MD5 key you set in the MD5 Key settings menu.
Transmit Delay	The number of seconds required to transmit a link state update over this virtual link. Transit delay takes into account transmission and propagation delays. This field is fixed at 1 second.
RetransInterval	The number of seconds between link state advertisement retransmissions for adjacencies belonging to this virtual link. This field is fixed at 5 seconds.

Click **Apply** to implement changes made.



NOTE: For OSPF to function properly some settings should be identical on all participating OSPF devices. These settings include the Hello Interval and Dead Interval. For networks using authorization for OSPF devices, the Authorization Type and Password or Key used must likewise be identical.

OSPF Area Aggregation Settings

Area Aggregation allows all of the routing information that may be contained within an area to be aggregated into a summary LSDB advertisement of just the network address and subnet mask. This allows for a reduction in the volume of LSDB advertisement traffic as well as a reduction in the memory overhead in the Switch used to maintain routing tables.

Click **Configuration > Layer 3 IP Networking > OSPF > OSPF Area Aggregation Settings** link to view the current settings. There are no aggregation settings configured by default, so there will not be any listed the first accessing the menu. To add a new **OSPF Area Aggregation** setting, click the **Add** button. A new menu (pictured below) appears. To change an existing configuration, click on the hyperlinked Area ID for the set you want to change. The menu to modify an

existing configuration is the same as the menu used to add a new one. To eliminate an existing configuration, click the  in the **Delete** column for the configuration being removed.

OSPF Area Aggregation Settings					
Area ID	Network Number	Network Mask	LSDB Type	Advertisement	Delete
255.255.255.255	201.0.0.0	255.254.0.0	Summary	Enabled	<input type="checkbox"/>
255.255.255.255	201.2.0.0	255.254.0.0	Summary	Enabled	<input type="checkbox"/>

Figure 6- 135. OSPF Area Aggregation Settings table

Use the menu below to change settings or add a new **OSPF Area Aggregation** setting.

OSPF Aggregation Configuration - Add	
Area ID	<input type="text" value="0.0.0.0"/>
Network Number	<input type="text" value="0.0.0.0"/>
Network Mask	<input type="text" value="0.0.0.0"/>
LSDB Type	<input type="text" value="Summary"/>
Advertisement	<input type="text" value="Enabled"/>
<input type="button" value="Apply"/>	
Show All OSPF Aggregation Entries	

Figure 6- 136. OSPF Area Aggregation Settings – Add window

Specify the OSPF aggregation settings and click the **Apply** button to add or change the settings. The new settings will appear listed in the **OSPF Area Aggregation Settings** table. To view the table, click the [Show All OSPF Aggregation Entries](#) link to return to the previous window.

Use the following parameters to configure the following settings for **OSPF Area Aggregation**:

Parameter	Description
Area ID	Allows the entry the OSPF Area ID for which the routing information will be aggregated. This Area ID must be previously defined on the Switch.
Network Number	Sometimes called the Network Address. The 32-bit number in the form of an IP address that uniquely identifies the network that corresponds to the OSPF Area above.
Network Mask	The corresponding network mask for the Network Number specified above.
LSDB Type	Specifies the type of address aggregation, which is set at <i>Summary</i> .
Advertisement	Select <i>Enabled</i> or <i>Disabled</i> to determine whether the selected OSPF Area will advertise it's summary LSDB (Network-Number and Network-Mask).

Click **Apply** to implement changes made.

OSPF Host Route Settings

OSPF host routes work in a way analogous to RIP, only this is used to share OSPF information with other OSPF routers. This is used to work around problems that might prevent OSPF information sharing between routers.

To configure OSPF host routes, click the **OSPF Host Route Settings** link. To add a new OSPF Route, click the **Add** button. Configure the setting in the menu that appears. The **Add** and **Modify** menus for OSPF host route setting are nearly identical. The difference being that if you are changing an existing configuration you will be unable to change the **Host Address**. To change an existing configuration, click on the hyperlinked **Host Address** in the list for the configuration you want to change and proceed to change the metric or area ID. To eliminate an existing configuration, click the  in the **Delete** column for the configuration being removed.

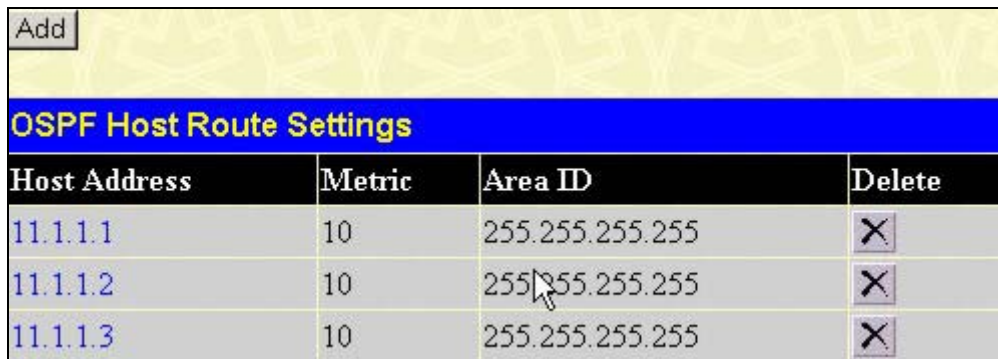



OSPF Host Route Settings			
Host Address	Metric	Area ID	Delete
11.1.1.1	10	255.255.255.255	
11.1.1.2	10	255.255.255.255	
11.1.1.3	10	255.255.255.255	

Figure 6- 137. OSPF Host Route Settings table

Use the menu below to set up OSPF host routes.

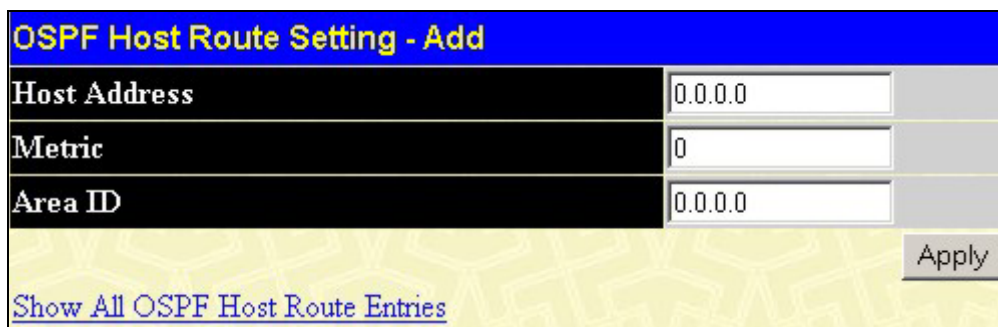

OSPF Host Route Setting - Add	
Host Address	<input type="text" value="0.0.0.0"/>
Metric	<input type="text" value="0"/>
Area ID	<input type="text" value="0.0.0.0"/>
<input type="button" value="Apply"/>	
Show All OSPF Host Route Entries	

Figure 6- 138. OSPF Host Route Settings – Add window

Specify the host route settings and click the **Apply** button to add or change the settings. The new settings will appear listed in the **OSPF Host Route Settings** list. To view the previous window, click the [Show All OSPF Host Route Entries](#) link to return to the previous window.

The following fields are configured for OSPF host route:

Parameter	Description
Host Address	The IP address of the OSPF host.
Metric	A value between 1 and 65535 that will be advertised for the route.
Area ID	A 32-bit number in the form of an IP address (xxx.xxx.xxx.xxx) that uniquely identifies the OSPF area in the OSPF domain.

IP Multicast Routing Protocol

The functions supporting IP multicasting are added under the **IP Multicast Routing Protocol** folder, from the **Layer 3 IP Networking** folder.

IGMP, **DVMRP**, and **PIM-DM** can be enabled or disabled on the Switch without changing the individual protocol's configuration.

IGMP

Computers and network devices that want to receive multicast transmissions need to inform nearby routers that they will become members of a multicast group. The **Internet Group Management Protocol (IGMP)** is used to communicate this information. IGMP is also used to periodically check the multicast group for members that are no longer active.

In the case where there is more than one multicast router on a subnetwork, one router is elected as the 'querier'. This router then keeps track of the membership of the multicast groups that have active members. The information received from IGMP is then used to determine if multicast packets should be forwarded to a given subnetwork or not. The router can check, using IGMP, to see if there is at least one member of a multicast group on a given subnetwork. If there are no members on a subnetwork, packets will not be forwarded to that subnetwork.

IGMP Versions 1 and 2

Multicast groups allow members to join or leave at any time. IGMP provides the method for members and multicast routers to communicate when joining or leaving a multicast group.

IGMP version 1 is defined in RFC 1112. It has a fixed packet size and no optional data.

The format of an IGMP packet is shown below:

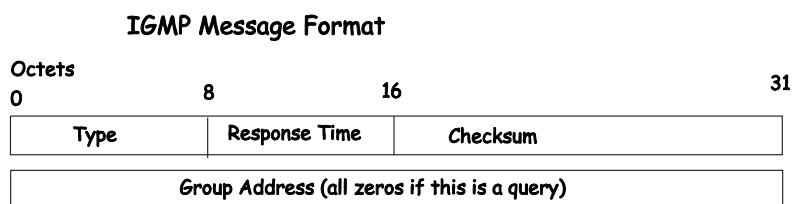

Figure 6- 139. IGMP Message Format

The IGMP Type codes are shown below:

Type	Meaning
0x11	Membership Query (if Group Address is 0.0.0.0)
0x11	Specific Group Membership Query (if Group Address is Present)
0x16	Membership Report (version 2)
0x17	Leave a Group (version 2)
0x12	Membership Report (version 1)

Table 6- 7. IGMP Type Codes

IGMP packets enable multicast routers to keep track of the membership of multicast groups, on their respective subnetworks. The following outlines what is communicated between a multicast router and a multicast group member using IGMP.

A host sends an IGMP "report" to join a group

A host will never send a report when it wants to leave a group (for version 1).

A host will send a "leave" report when it wants to leave a group (for version 2).

Multicast routers send IGMP queries (to the all-hosts group address: 224.0.0.1) periodically to see whether any group members exist on their subnetworks. If there is no response from a particular group, the router assumes that there are no group members on the network.

The Time-to-Live (TTL) field of query messages is set to 1 so that the queries will not be forwarded to other subnetworks.

IGMP version 2 introduces some enhancements such as a method to elect a multicast querier for each LAN, an explicit leave message, and query messages that are specific to a given group.

The states a computer will go through to join or to leave a multicast group are shown below:

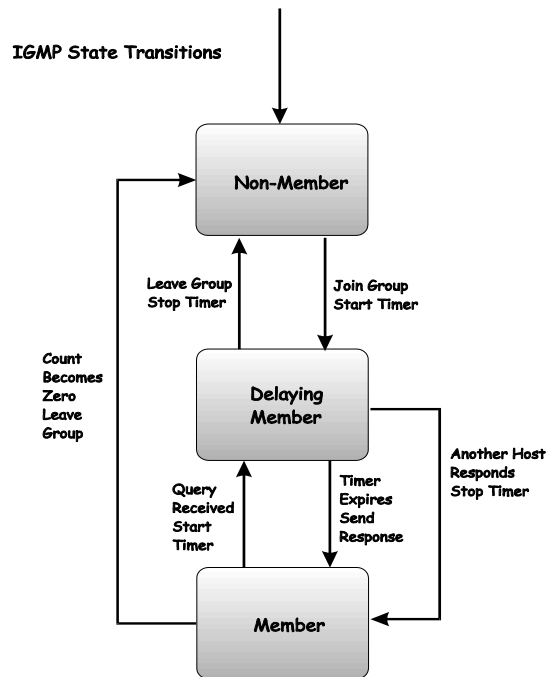

Figure 6- 140. IGMP State Transitions

IGMP Interface Configuration

The Internet Group Multicasting Protocol (IGMP) can be configured on the Switch on a per-IP interface basis. To view the **IGMP Interface Table**, open the **IP Multicast Routing Protocol** folder under **Configuration** and click **IGMP Interface Settings**. Each IP interface configured on the Switch is displayed in the below **IGMP Interface Table** dialog box. To configure IGMP for a particular interface, click the corresponding hyperlink for that IP interface. This will open another **IGMP Interface Configuration** window:

Total Entries : 1							
IGMP Interface Table							
Interface Name	IP Address	Version	Query	Max Response Time	Robustness Value	Last Member Query Interval	State
System	10.53.13.65	2	125	10	2	1	Disabled

Figure 6- 141. IGMP Interface Settings window

IGMP Interface Configuration	
Interface Name	System
IP Address	10.53.13.65
Version	2 ▾
Query Interval(1-65535)	125
Max Response Time(1-25)	10
Robustness Variable(1-255)	2
Last Member Query Interval(1-25)	1
State	Disabled ▾
Apply	
Show All IGMP Interface Entries	

Figure 6- 142. IGMP Interface Settings - Edit window

This window allows the configuration of IGMP for each IP interface configured on the Switch. IGMP can be configured as Version 1, 2 or 3 by toggling the **Version** field using the pull-down menu. The length of time between queries can be varied by entering a value between 1 and 31,744 seconds in the **Query Interval** field. The maximum length of time between the receipt of a query and the sending of an IGMP response report can be varied by entering a value in the **Max Response Time** field.

The **Robustness Variable** field allows IGMP to be ‘tuned’ for sub-networks that are expected to lose many packets. A high value (max. 255) for the robustness variable will help compensate for ‘lossy’ sub-networks. A low value (min. 2) should be used for less ‘lossy’ sub-networks.

The following fields can be set:

Parameter	Description
Interface Name	Displays the name of the IP interface that is to be configured for IGMP. This must be a previously configured IP interface.
IP Address	Displays the IP address corresponding to the IP interface name above.

Version	Enter the IGMP version (1, 2 or 3) that will be used to interpret IGMP queries on the interface.
Query Interval	Allows the entry of a value between 1 and 65535 seconds, with a default of 125 seconds. This specifies the length of time between sending IGMP queries.
Max Response Time	Sets the maximum amount of time allowed before sending an IGMP response report. A value between 1 and 25 seconds can be entered, with a default of 10 seconds.
Robustness Variable	A tuning variable to allow for subnetworks that are expected to lose a large number of packets. A value between 2 and 255 can be entered, with larger values being specified for subnetworks that are expected to lose larger numbers of packets.
Last Member Query Interval	Specifies the maximum amount of time between group-specific query messages, including those sent in response to leave group messages. A value between 1 and 25. The default is 1 second.
State	This field can be toggled between <i>Enabled</i> and <i>Disabled</i> and enables or disables IGMP for the IP interface. The default is <i>Disabled</i> .

Click **Apply** to implement changes made.

DVMRP Interface Configuration

The Distance Vector Multicast Routing Protocol (**DVMRP**) is a hop-based method of building multicast delivery trees from multicast sources to all nodes of a network. Because the delivery trees are ‘pruned’ and ‘shortest path’, DVMRP is relatively efficient. Because multicast group membership information is forwarded by a distance-vector algorithm, propagation is slow. DVMRP is optimized for high delay (high latency) relatively low bandwidth networks, and can be considered as a ‘best-effort’ multicasting protocol.

DVMRP resembles the Routing Information Protocol (RIP), but is extended for multicast delivery. DVMRP builds a routing table to calculate ‘shortest paths’ back to the source of a multicast message, but defines a ‘route cost’ (similar to the hop count in RIP) as a relative number that represents the real cost of using this route in the construction of a multicast delivery tree to be ‘pruned’ - once the delivery tree has been established.

When a sender initiates a multicast, DVMRP initially assumes that all users on the network will want to receive the multicast message. When an adjacent router receives the message, it checks its unicast routing table to determine the interface that gives the shortest path (lowest cost) back to the source. If the multicast was received over the shortest path, then the adjacent router enters the information into its tables and forwards the message. If the message is not received on the shortest path back to the source, the message is dropped.

Route cost is a relative number that is used by DVMRP to calculate which branches of a multicast delivery tree should be ‘pruned’. The ‘cost’ is relative to other costs assigned to other DVMRP routes throughout the network.

The higher the route cost, the lower the probability that the current route will be chosen to be an active branch of the multicast delivery tree (not ‘pruned’) - if there is an alternative route.

DVMRP Configuration

To enable DVMRP globally on the Switch, click **Configuration > Layer 3 IP Networking > IP Multicast Routing Protocol > Configuration**. This will give the user access to the following screen:



Figure 6- 143. DVMRP Global Settings window

Use the pull down menu, choose *Enabled*, and click **Apply** to implement the DVMRP function on the Switch.

DVMRP Interface Settings

To view the **DVMRP Interface Table**, click **Configuration > Layer 3 IP Networking > IP Multicast Routing Protocol > DVMRP Interface Settings**. This menu allows the **Distance-Vector Multicast Routing Protocol (DVMRP)** to be configured for each IP interface defined on the Switch. Each IP interface configured on the Switch is displayed in the below **DVMRP Interface Configuration** dialog box. To configure DVMRP for a particular interface, click the corresponding hyperlink for that IP interface. This will open the **DVMRP Interface Settings** window:

DVMRP Interface Settings					
Interface Name	IP Address	Neighbor Timeout	Probe	Metric	State
System	10.53.13.121	35	10	1	Disabled
Trinity	12.1.1.1	35	10	1	Disabled

Figure 6- 144. DVMRP Interface Settings window

DVMRP Interface Settings	
Interface Name	System
IP Address	10.53.13.65
Neighbor Timeout Interval(1-65535 sec)	<input type="text" value="35"/>
Probe Interval(1-65535 sec)	<input type="text" value="10"/>
Metric(1-31)	<input type="text" value="1"/>
State	Disabled <input type="button" value="v"/>
<input type="button" value="Apply"/>	
Show All DVMRP Interface Entries	

Figure 6- 145. DVMRP Interface Settings – Edit window

The following fields can be set:

Parameter	Description
Interface Name	Displays the name of the IP interface for which DVMRP is to be configured. This must be a previously defined IP interface.
IP Address	Displays the IP address corresponding to the IP Interface name entered above.
Neighbor Timeout Interval (1-65535)	This field allows an entry between 1 and 65,535 seconds and defines the time period DVMRP will hold Neighbor Router reports before issuing poison route messages. The default is 35 seconds.
Probe Interval (1-65535)	This field allows an entry between 1 and 65,535 seconds and defines the interval between 'probes'. The default is 10.
Metric (1-31)	This field allows an entry between 1 and 31 and defines the route cost for the IP interface. The DVMRP route cost is a relative number that represents the real cost of using this route in the construction of a multicast delivery tree. It is similar to, but not defined as, the hop count in RIP. The default cost is 1.
State	This field can be toggled between <i>Enabled</i> and <i>Disabled</i> and enables or disables DVMRP for the IP interface. The default is <i>Disabled</i> .

Click **Apply** to implement changes made. Click [Show All DVMRP Interface Entries](#) to return to the **DVMRP Interface Settings** window.

PIM-DM Interface Configuration

The *Protocol Independent Multicast - Dense Mode* (PIM-DM) protocol should be used in networks with a low delay (low latency) and high bandwidth as PIM-DM is optimized to guarantee delivery of multicast packets, not to reduce overhead.

The PIM-DM multicast routing protocol assumes that all downstream routers want to receive multicast messages and relies upon explicit prune messages from downstream routers to remove branches from the multicast delivery tree that do not contain multicast group members.

PIM-DM has no explicit 'join' messages. It relies upon periodic flooding of multicast messages to all interfaces and then either waiting for a timer to expire (the **Join/Prune Interval**) or for the downstream routers to transmit explicit 'prune' messages indicating that there are no multicast members on their respective branches. PIM-DM then removes these branches ('prunes' them) from the multicast delivery tree.

Because a member of a pruned branch of a multicast delivery tree may want to join a multicast delivery group (at some point in the future), the protocol periodically removes the 'prune' information from its database and floods multicast messages to all interfaces on that branch. The interval for removing 'prune' information is the **Join/Prune Interval**.

PIM-DM Configuration

To enable PIM-DM globally on the Switch, go to **Configuration > Layer 3 IP Networking > IP Multicast Routing Protocol > PIM > PIM-DM Configuration**. This will give the user access to the following screen:



Figure 6- 146. PIM-DM Global Settings window

Use the pull down menu, choose *Enabled*, and click **Apply** to set the PIM-DM function on the Switch.

PIM-DM Interface Configuration

To view the **PIM-DM Table**, click **Configuration > IP Multicast Routing Protocol > PIM > PIM-DM Interface Settings**. This window allows the **PIM-DM** to be configured for each IP interface defined on the Switch. Each IP interface configured on the Switch is displayed in the below **PIM-DM Interface Settings** dialog box. To configure PIM-DM for a particular interface, click the corresponding hyperlink for that IP interface. This will open the **PIM-DM Interface Settings** window:

PIM-DM Interface Settings				
Interface Name	IP Address	Hello Interval	Join/Prune Interval	State
System	10.53.13.121	30	60	Disabled
Trinity	12.1.1.1	30	60	Disabled

Figure 6- 147. PIM-DM Interface Settings window

To view the configuration window for a specific entry, click its hyperlinked name, revealing the following window.

PIM-DM Interface Settings - Edit	
Interface Name	Trinity
IP Address	12.1.1.1
Hello Interval (1-18724 sec)	<input type="text" value="30"/>
Join/Prune Interval (1-18724 sec)	<input type="text" value="60"/>
State	Disabled ▾
<input type="button" value="Apply"/>	
Show All PIM-DM Interface Entries	

Figure 6- 148. PIM-DM Interface Settings - Edit window

The following fields can be set or viewed:

Parameter	Description
Interface Name	Allows the entry of the name of the IP interface for which PIM-DM is to be configured. This must be a previously defined IP interface.
IP Address	Displays the IP address for the IP interface named above.
Hello Interval (1-18724)	This field allows an entry of between <i>1</i> and <i>18724</i> seconds and determines the interval between sending Hello packets to other routers on the network. The default is <i>30</i> seconds.
Join/Prune Interval (1-18724)	This field allows an entry of between <i>1</i> and <i>18724</i> seconds. This interval also determines the time interval the router uses to automatically remove prune information from a branch of a multicast delivery tree and begin to flood multicast messages to all branches of that delivery tree. These two actions are equivalent. The default is <i>60</i> seconds.
State	This field can be toggled between <i>Enabled</i> and <i>Disabled</i> using the pull-down menu, and is used to enable or disable PIM-DM for the IP interface. The default is <i>Disabled</i> .

Click **Apply** to implement changes made. Click [Show All PIM-DM Interface Entries](#) to return to the **PIM-DM Interface Table**.

DNS Relay

Computer users usually prefer to use text names for computers for which they may want to open a connection. Computers themselves, require 32 bit IP addresses. Somewhere, a database of network devices' text names and their corresponding IP addresses must be maintained.

The Domain Name System (DNS) is used to map names to IP addresses throughout the Internet and has been adapted for use within intranets.

For two DNS servers to communicate across different subnets, the **DNS Relay** of the Switch must be used. The DNS servers are identified by IP addresses.

Mapping Domain Names to Addresses

Name-to-address translation is performed by a program called a Name server. The client program is called a Name resolver. A Name resolver may need to contact several Name servers to translate a name to an address.

The Domain Name System (DNS) servers are organized in a somewhat hierarchical fashion. A single server often holds names for a single network, which is connected to a root DNS server - usually maintained by an ISP.

Domain Name Resolution

The domain name system can be used by contacting the name servers one at a time, or by asking the domain name system to do the complete name translation. The client makes a query containing the name, the type of answer required, and a code specifying whether the domain name system should do the entire name translation, or simply return the address of the next DNS server if the server receiving the query cannot resolve the name.

When a DNS server receives a query, it checks to see if the name is in its sub domain. If it is, the server translates the name and appends the answer to the query, and sends it back to the client. If the DNS server cannot translate the name, it determines what type of name resolution the client requested. A complete translation is called recursive resolution and requires the server to contact other DNS servers until the name is resolved. Iterative resolution specifies that if the DNS server cannot supply an answer, it returns the address of the next DNS server the client should contact.

Each client must be able to contact at least one DNS server, and each DNS server must be able to contact at least one root server.

The address of the machine that supplies domain name service is often supplied by a DHCP or BOOTP server, or can be entered manually and configured into the operating system at startup.

DNS Relay Information

To configure the DNS function on the Switch, click **Configuration > Layer 3 IP Networking > DNS Relay > DNS Relay Information**, which will open the **DNS Relay Information** window, as seen below:

DNS Relay Information	
DNS Relay Status	Disabled ▾
Primary Name Server	0.0.0.0
Secondary Name Server	0.0.0.0
DNSR Cache Status	Disabled ▾
DNSR Static Table Status	Disabled ▾
Apply	

Figure 6- 149. DNS Relay Global Settings window

The following fields can be set:

Parameter	Description
DNS Relay Status	This field can be toggled between <i>Disabled</i> and <i>Enabled</i> using the pull-down menu, and is used to enable or disable the DNS Relay service on the Switch.
Primary Name Server	Allows the entry of the IP address of a primary domain name server (DNS).
Secondary Name Server	Allows the entry of the IP address of a secondary domain name server (DNS).
DNSR Cache Status	This can be toggled between <i>Disabled</i> and <i>Enabled</i> . This determines if a DNS cache will be enabled on the Switch.
DNSR Static Table State	This field can be toggled using the pull-down menu between <i>Disabled</i> and <i>Enabled</i> . This determines if the static DNS table will be used or not.

Click **Apply** to implement changes made.

DNS Relay Static Settings

To view the **DNS Relay Static Settings**, click **Configuration > Layer 3 IP Networking > DNS Relay > DNS Relay Static Settings**, which will open the **DNS Relay Static Settings** window, as seen below:

DNS Relay Static Settings		
Domain Name	IP Address	Apply
<input type="text"/>	<input type="text" value="0.0.0.0"/>	Add
DNS Relay Static Table		
Domain Name	IP Address	Delete
System	10.53.13.94	X

Figure 6- 150. DNS Relay Static Settings and Table window

To add an entry into the **DNS Relay Static Table**, simply enter a **Domain Name** with its corresponding IP address and click **Add** under the **Apply** heading. A successful entry will be presented in the table below, as shown in the example above. To erase an entry from the table, click the  corresponding of the entry you wish to delete.

DHCP / BOOTP Relay

The BOOTP hops count limit allows the maximum number of hops (routers) that the BOOTP messages can be relayed through to be set. If a packet's hop count is more than the hop count limit, the packet is dropped. The range is between 1 and 16 hops, with a default value of 4. The relay time threshold sets the minimum time (in seconds) that the Switch will wait before forwarding a BOOTREQUEST packet. If the value in the seconds field of the packet is less than the relay time threshold, the packet will be dropped. The range is between 0 and 65,536 seconds, with a default value of 0 seconds.

DHCP Auto Configuration Settings

This window is used to enable the DHCP Autoconfiguration feature on the Switch. When enabled, the Switch is instructed to receive a configuration file from a TFTP server, which will set the Switch to become a DHCP client automatically on boot up. To employ this method, the DHCP server must be set up to deliver the TFTP server Ip address and configuration file name information in the DHCP reply packet. The TFTP server must be up and running and hold the necessary configuration file stored in its base directory when the request is received from the Switch. For more information about loading a configuration file for use by a client, see the DHCP server and/or TFTP server software instructions. The user may also consult the Upload screen description located in the Maintenance section of this manual.

If the Switch is unable to complete the DHCP auto configuration, the previously saved configuration file present in the Switch's memory will be used.

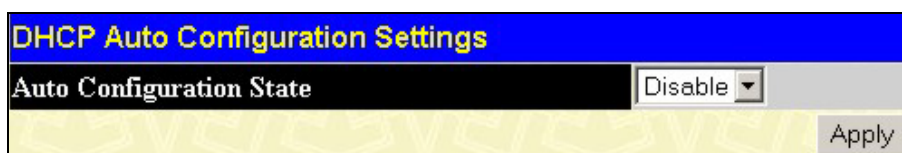

Figure 6- 151. DHCP Auto Configuration Settings window

To enable the **DHCP Auto Configuration State**, use the pull-down menu to choose **Enable** and click the Apply button.

DHCP / BOOTP Relay Information

To enable and configure BOOTP or DHCP on the Switch, click **Configuration > DHCP/BOOTP Relay > DHCP/BOOTP Relay Information**:

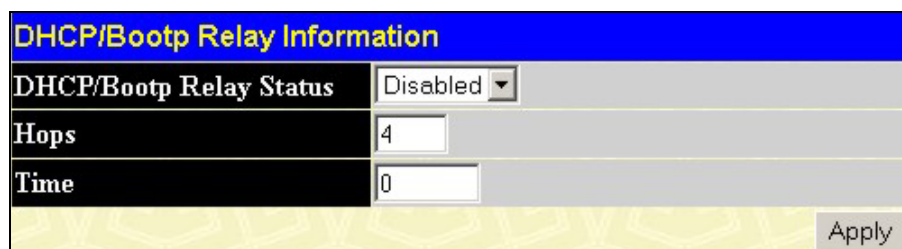



Figure 6- 152. DHCP/ BOOTP Relay Global Settings window

The following fields can be set:

Parameter	Description
BOOTP Relay Status	This field can be toggled between <i>Enabled</i> and <i>Disabled</i> using the pull-down menu. It is used to enable or disable the BOOTP/DHCP Relay service on the Switch. The default is <i>Disabled</i>
Hops	This field allows an entry between 1 and 16 to define the maximum number of router hops BOOTP messages can be forwarded across. The default hop count is 4.
Time	Allows an entry between 0 and 65535 seconds, and defines the maximum time limit for routing a BOOTP/DHCP packet. If a value of 0 is entered, the Switch will not process the value in the seconds field of the BOOTP or DHCP packet. If a non-zero value is entered, the Switch will use that value, along with the hop count to determine whether to forward a given BOOTP or DHCP packet.

DHCP/BOOTP Relay Settings

The **DHCP/ BOOTP Relay Settings** allow the user to set up a server, by IP address, for relaying DHCP / BOOTP information to the Switch. The user may enter a previously configured IP interface on the Switch that will be connected directly to the DHCP/BOOTP server using the following window. Properly configured settings will be displayed in the **BOOTP Relay Table** at the bottom of the following window, once the user clicks the **Add** button under the **Apply** heading. The user may add up to four server IPs per IP interface on the Switch. Entries may be deleted by clicking it's corresponding .



DHCP/Bootp Relay Settings				
Interface Name	IP Address			Apply
<input type="text"/>	<input type="text" value="0.0.0.0"/>			<input type="button" value="Add"/>
				
DHCP/Bootp Relay Table				
Interface	Server 1	Server 2	Server 3	Server 4
System	 10.53.13.94			

Figure 6- 153. DHCP/BOOTP Relay Interface Settings and DHCP/BOOTP Relay Interface Table window

The following parameters may be configured or viewed.

Parameter	Description
Interface Name	The IP interface on the Switch that will be connected directly to the Server.
IP Address	Enter the IP address of the DHCP/BOOTP server. Up to four server IPs can be configured per IP Interface

VRRP

VRRP or *Virtual Routing Redundancy Protocol* is a function on the Switch that dynamically assigns responsibility for a virtual router to one of the VRRP routers on a LAN. The VRRP router that controls the IP address associated with a virtual router is called the Master, and will forward packets sent to this IP address. This will allow any Virtual Router IP address on the LAN to be used as the default first hop router by end hosts. Utilizing VRRP, the administrator can achieve a higher available default path cost without needing to configure every end host for dynamic routing or routing discovery protocols.

Statically configured default routes on the LAN are prone to a single point of failure. VRRP is designed to eliminate these failures by setting an election protocol that will assign a responsibility for a virtual router to one of the VRRP routers on the LAN. When a virtual router fails, the election protocol will select a virtual router with the highest priority to be the Master router on the LAN. This retains the link and the connection is kept alive, regardless of the point of failure.

To configure VRRP for virtual routers on the Switch, an IP interface must be present on the system and it must be a part of a VLAN. VRRP IP interfaces may be assigned to every VLAN, and therefore IP interface, on the Switch. VRRP routers within the same VRRP group must be consistent in configuration settings for this protocol to function optimally.

VRRP Global Settings

To enable VRRP globally on the Switch, click **Configuration > Layer 3 IP Networking > VRRP > VRRP Global Settings**:

Figure 6- 154. VRRP Global Settings window

The following fields can be set:

Parameter	Description
Global VRRP	Use the pull-down menu to enable or disable VRRP globally on the Switch. The default is <i>Disabled</i> .
Non-owner response PING	Enabling this parameter will allow the virtual IP address to be pinged from other host end nodes to verify connectivity. This will only enable the ping connectivity check function. This command is <i>Disabled</i> by default.

Click **Apply** to implement changes made.

VRRP Virtual Router Settings

The following window will allow the user to view the parameters for the VRRP function on the Switch. To view this window, click **Configuration > Layer 3 IP Networking > VRRP > VRRP Virtual Router Settings**:

VRRP Virtual Router Settings				
VRID	Interface Name	Authentication type	Display	Delete
1	System	No Authentication	View	

Figure 6- 155. VRRP Virtual Router Settings window

The following fields are displayed in the window above:

Parameter	Description
VRID	VRID - Displays the virtual router ID set by the user. This will uniquely identify the VRRP Interface on the network.
Interface Name	An IP interface name that has been enabled for VRRP. This entry must have been previously set in the IP Interfaces table.
Authentication Type	Displays the Authentication in use on this Virtual Interface. Possible authentication types include: <ul style="list-style-type: none"> <i>No authentication</i> - No authentication has been selected to compare VRRP packets received by a virtual router. <i>Simple Text Password</i> - A <i>Simple</i> password has been selected to compare VRRP packets received by a virtual router, for authentication. <i>IP Authentication Header</i> - An MD5 message digest algorithm has been selected to compare VRRP packets received by a virtual router, for authentication.
Display	Click the button to display the settings for this particular VRRP entry.
Delete	Click the to delete this VRRP entry.

Click the **Add** button to display the following window to configure a VRRP interface.

VRRP Virtual Router Settings	
VRID(1-255)	<input type="text" value="0"/>
Interface Name	<input type="text"/>
IP Address	<input type="text" value="0.0.0.0"/>
Admin. State	Enable <input type="button" value="v"/>
Priority(1-254)	<input type="text" value="100"/>
Advertisement Interval(1-255)	<input type="text" value="1"/>
Preempt Mode	True <input type="button" value="v"/>
Critical IP Address	<input type="text" value="0.0.0.0"/>
Checking Critical IP	Disable <input type="button" value="v"/>
<input type="button" value="Apply"/>	
Show All VRRP Interface Entries	

Figure 6- 156. VRRP Virtual Router Settings – Add window

Or, the user may click the hyperlinked **Interface Name** to view the same window:

The following parameters may be set to configure an existing or new VRRP virtual router.

Parameter	Description
VRID (1-255)	Enter a value between 1 and 255 to uniquely identify this VRRP group on the Switch. All routers participating in this group must be assigned the same VRID value. This value MUST be different from other VRRP groups set on the Switch.
Interface Name	Enter the name of a previously configured IP interface for which to create a VRRP entry. This IP interface must be assigned to a VLAN on the Switch.
IP Address	Enter the IP address that will be assigned to the VRRP router. This IP address is also the default gateway that will be statically assigned to end hosts and must be set for all routers that participate in this group.
Admin. State	Used to enable (Up) and disable (Down) the VRRP IP interface on the Switch.
Priority (1-254)	Enter a value between 1 and 254 to indicate the router priority. The VRRP Priority value may determine if a higher priority VRRP router overrides a lower priority VRRP router. A higher priority will increase the probability that this router will become the Master router of the group. A lower priority will increase the probability that this router will become the backup router. VRRP routers that are assigned the same priority value will elect the highest physical IP address as the Master router. The default value is 100. (The value of 255 is reserved for the router that owns the IP address associated with the virtual router and is therefore set automatically.)
Advertisement Interval (1-255)	Enter a time interval value, in seconds, for sending VRRP message packets. This value must be consistent with all participating routers. The default is 1 second.
Preempt Mode	This entry will determine the behavior of backup routers within the VRRP group by controlling whether a higher priority backup router will preempt a lower priority Master router. A <i>True</i> entry, along with having the backup router's priority set higher than the masters priority, will set the backup router as the Master router. A <i>False</i> entry will disable the backup router from becoming the Master router. This setting must be consistent with all routers participating within the same VRRP group. The default setting is <i>True</i> .
Critical IP Address	Enter the IP address of the physical device that will provide the most direct route to the Internet or other critical network connections from this virtual router. This must be a real IP address of a real device on the network. If the connection from the virtual router to this IP address fails, the virtual router will automatically disabled. A new Master will be elected from the backup routers participating in the VRRP group. Different critical IP addresses may be assigned to different routers participating in the VRRP group, and can therefore define multiple routes to the Internet or other critical network connections.
Checking Critical IP	Use the pull-down menu to enable or disable the Critical IP address entered above.

Click **Apply** to implement changes made.

To view the settings for a particular VRRP setting, click the corresponding [View](#) in the **VRRP Interface Table** of the entry, which will display the following:

VRRP Virtual Router Entry Display	
VRID	1
Interface Name	System
Authentication type	No Authentication
Virtual IP Address	10.53.13.65
Virtual MAC Address	00:00:5e:00:01:01
Virtual Router State	Initialize
Admin. State	Enabled
Priority	255
Master IP Address	10.53.13.65
Critical IP Address	0.0.0.0
Checking Critical IP	Disabled
Advertisement Interval	1
Preempt Mode	True
Virtual Router Up Time	0
Show All VRRP Interface Entries	

Figure 6- 157. VRRP Virtual Router Settings - Display window

This window displays the following information:

Parameter	Description
VRID	Displays the virtual router ID set by the user. This will uniquely identify the VRRP Interface on the network.
Interface Name	An IP interface name that has been enabled for VRRP. This entry must have been previously set in the IP Interface Settings table.
Authentication type	Displays the type of authentication used to compare VRRP packets received by a virtual router. Possible authentication types include: <ul style="list-style-type: none"> <i>No authentication</i> - No authentication has been selected to compare VRRP packets received by a virtual router. <i>Simple Text Password</i> - A <i>Simple</i> password has been selected to compare VRRP packets received by a virtual router, for authentication. <i>IP Authentication Header</i> - An MD5 message digest algorithm has been selected to compare VRRP packets received by a virtual router, for authentication.
Virtual IP Address	The IP address of the Virtual router configured on the Switch.
Virtual MAC Address	The MAC address of the device that holds the Virtual router.
Virtual Router State	Displays the current status of the virtual router. Possible states include <i>Initialize</i> , <i>Master</i> and <i>Backup</i> .

Admin. State	Displays the current state of the router. <i>Up</i> will be displayed if the virtual router is enabled and <i>Down</i> , if the virtual router is disabled.
Priority	Displays the priority of the virtual router. A higher priority will increase the probability that this router will become the Master router of the group. A lower priority will increase the probability that this router will become the backup router. The lower the number, the higher the priority.
Master IP Address	Displays the IP address of the Master router for the VRRP function.
Critical IP Address	Displays the critical IP address of the VRRP function. This address will judge if a virtual router is qualified to be a master router.
Checking Critical IP	Displays the status of the Critical IP address. May be enabled or disabled.
Advertisement Interval	Displays the time interval, in seconds, which VRRP messages are sent out to the network.
Preempt Mode	Displays the mode for determining the behavior of backup routers set on this VRRP interface. <i>True</i> will denote that this will be the backup router, if the routers priority is set higher than the master router. <i>False</i> will disable the backup router from becoming the master router.
Virtual Router Up Time	Displays the time, in minutes, since the virtual router has been initialized

VRRP Authentication Settings

The **VRRP Authentication Settings** window is used to set the authentication for each Interface configured for VRRP. This authentication is used to identify incoming message packets received by a router. If the authentication is not consistent with incoming packets, they will be discarded. The **Authentication Type** must be consistent with all routers participating within the VRRP group.

To view the following window, click **Configuration > Layer 3 IP Networking > VRRP > VRRP Interface Settings**.

VRRP Interface Settings	
Interface Name	Authentication type
System	No Authentication

Figure 6- 158. VRRP Authentication Settings window

To configure the authentication for a pre-created interface, click its hyperlinked name, revealing the following window to configure:

VRRP Interface Settings	
Interface Name	System
Auth. Type	None <input type="button" value="v"/>
Auth. Data	null <input type="text"/>
<input type="button" value="Apply"/>	
Show All VRRP Interface Entries	

Figure 6- 159. VRRP Authentication Settings – Edit window

The following parameters may be viewed or configured:

Parameter	Description
Interface Name	The name of a previously created IP interface for which to configure the VRRP authentication.
Auth. Type	<p>Specifies the type of authentication used. The Auth. Type must be consistent with all routers participating within the VRRP group. The choices are:</p> <ul style="list-style-type: none"> • <i>None</i> - Selecting this parameter indicates that VRRP protocol exchanges will not be authenticated. • <i>Simple</i> - Selecting this parameter will require the user to set a simple password in the Auth. Data field for comparing VRRP message packets received by a router. If the two passwords are not exactly the same, the packet will be dropped. • <i>IP</i> - Selecting this parameter will require the user to set a MD5 message digest for authentication in comparing VRRP messages received by the router. If the two values are inconsistent, the packet will be dropped.
Auth. Data	<p>This field is only valid if the user selects <i>Simple</i> or <i>IP</i> in the Auth.Type field.</p> <ul style="list-style-type: none"> • <i>Simple</i> will require the user to enter an alphanumeric string of no more than eight characters to identify VRRP packets received by a router. • <i>IP</i> will require the user to enter a MD5 message digest for authentication in comparing VRRP messages received by the router. <p>This entry must be consistent with all routers participating in the same IP interface.</p>

Click **Apply** to implement changes made.

Section 7

Security Management

Security IP

User Accounts

Access Authentication Control (TACACS)

Secure Sockets Layer (SSL)

Secure Shell (SSH)

The following section will aid the user in configuring security functions for the Switch. The Switch includes various functions for security, including *TACACS*, *Security IPs*, *SSL*, and *SSH*, all discussed in detail in the following section.

Security IP

Go to the **Security Management** folder and click on the **Security IP Management** link; the following screen will appear.

Security IP Management	
IP1 Access to Switch	<input type="text" value="0.0.0.0"/>
IP2 Access to Switch	<input type="text" value="0.0.0.0"/>
IP3 Access to Switch	<input type="text" value="0.0.0.0"/>
IP4 Access to Switch	<input type="text" value="0.0.0.0"/>
<input type="button" value="Apply"/>	
<p>Note : Create a list of IP addresses that can access the switch. Your local host IP address must be one of the IP addresses to avoid disconnection.</p>	

Figure 8- 1. Security IP window

Use the **Security IP Management** to permit remote stations to manage the Switch. If you choose to define one or more designated management stations, only the chosen stations, as defined by IP address, will be allowed management privilege through the web manager or Telnet session. To define a management station IP setting, type in the IP address and click the **Apply** button.

User Account Management

Use the **User Accounts Management** window to control user privileges. To view existing User Accounts, open the **Security Management** folder and click on the **User Account Management** link. This will open the **User Account Management** page, as shown below.

User Account Management		
User Name	Access Right	Add
Darren	Admin	<input type="button" value="Modify"/>

Figure 8- 2. User Account Management window

To add a new user, click on the **Add** button. To modify or delete an existing user, click on the **Modify** button for that user.

User Account Modify Table	
User Name	<input type="text"/>
New Password	<input type="text"/>
Confirm New Password	<input type="text"/>
Access Right	Admin ▾
<input type="button" value="Apply"/>	
Show All User Account Entries	

Figure 8- 3. User Accounts Modify Table - Add

Add a new user by typing in a **User Name**, and **New Password** and retype the same password in the **Confirm New Password**. Choose the level of privilege (*Admin* or *User*) from the **Access Right** drop-down menu.

User Account Modify Table	
User Name	Darren
Old Password	<input type="text"/>
New Password	<input type="text"/>
Confirm New Password	<input type="text"/>
Access Right	Admin
<input type="button" value="Apply"/> <input type="button" value="Delete"/>	
Show All User Account Entries	

Figure 8- 4. User Account Modify Table - Modify

Modify or delete an existing user account in the **User Account Modify Table**. To delete the user account, click on the **Delete** button. To change the password, type in the **New Password** and retype it in the **Confirm New Password** entry field. The level of privilege (*Admin* or *User*) can be viewed in the **Access Right** field.

Admin and User Privileges

There are two levels of user privileges, **Admin** and **User**. Some menu selections available to users with **Admin** privileges may not be available to those with **User** privileges.

The following table summarizes the Admin and User privileges:

Management	Admin	User
Configuration	Yes	Read Only
Network Monitoring	Yes	Read Only
Community Strings and Trap Stations	Yes	Read Only
Update Firmware and Configuration Files	Yes	No
System Utilities	Yes	No

Factory Reset	Yes	No
User Account Management		
Add/Update/Delete User Accounts	Yes	No
View User Accounts	Yes	No

Table 7- 1. Admin and User Privileges

After establishing a User Account with Admin-level privileges, be sure to save the changes by opening the **Maintenance** folder, opening the **Save Changes** window and clicking the **Save Configuration** button.

Secure Shell (SSH)

SSH is an abbreviation of *Secure Shell*, which is a program allowing secure remote login and secure network services over an insecure network. It allows a secure login to remote host computers, a safe method of executing commands on a remote end node, and will provide secure encrypted and authenticated communication between two non-trusted hosts. SSH, with its array of unmatched security features is an essential tool in today's networking environment. It is a powerful guardian against numerous existing security hazards that now threaten network communications.

The steps required to use the SSH protocol for secure communication between a remote PC (the SSH client) and the Switch (the SSH server) are as follows:

1. Create a user account with admin-level access using the User Accounts window in the **Security Management** folder. This is identical to creating any other admin-level User Account on the Switch, including specifying a password. This password is used to logon to the Switch, once a secure communication path has been established using the SSH protocol.
2. Configure the User Account to use a specified authorization method to identify users that are allowed to establish SSH connections with the Switch using the **SSH User Authentication** window. There are three choices as to the method SSH will use to authorize the user, which are **Host Based**, **Password** and **Public Key**.
3. Configure the encryption algorithm that SSH will use to encrypt and decrypt messages sent between the SSH client and the SSH server, using the **SSH Algorithm** window.
4. Finally, enable SSH on the Switch using the **SSH Configuration** window.

After completing the preceding steps, a SSH Client on a remote PC can be configured to manage the Switch using a secure, in band connection.

SSH Configuration

The following window is used to configure and view settings for the SSH server and can be opened by clicking **Security Management > Secure Shell (SSH) > SSH Configuration**:

Current SSH Configuration Settings	
SSH Server Status	Disabled
Max Session	8
Time Out	120
Auth. Fail	2
Session Rekeying	Never
Ports	22

New SSH Configuration Settings	
SSH Server Status	Disabled ▾
Max Session(1-8)	8
Time Out(120-600)	120
Auth. Fail(2-20)	2
Session Rekeying	Never ▾
Port(1-65535)	22

Apply

Figure 8- 5. Current SSH Configuration and New Settings window

To configure the SSH server on the Switch, modify the following parameters and click **Apply**:

Parameter	Description
SSH Server Status	Use the pull-down menu to enable or disable SSH on the Switch. The default is <i>Disabled</i> .
Max Session (1-8)	Enter a value between 1 and 8 to set the number of users that may simultaneously access the Switch. The default setting is 8.
Connection TimeOut (120-600)	Allows the user to set the connection timeout. The user may set a time between 120 and 600 seconds. The default setting is 120 seconds.
Auth. Fail (2-20)	Allows the Administrator to set the maximum number of attempts that a user may try to log on to the SSH Server utilizing the SSH authentication. After the maximum number of attempts has been exceeded, the Switch will be disconnected and the user must reconnect to the Switch to attempt another login. The number of maximum attempts may be set between 2 and 20. The default setting is 2.
Session Rekeying	This field is used to set the time period that the Switch will change the security shell encryptions by using the pull-down menu. The available options are <i>Never</i> , <i>10 min</i> , <i>30 min</i> , and <i>60 min</i> . The default setting is <i>Never</i> .
Port	Enter the virtual port number to be used with this feature. The common port number for SSH is 22.

SSH Algorithm

The SSH Algorithm window allows the configuration of the desired types of SSH algorithms used for authentication encryption. There are three categories of algorithms listed and specific algorithms of each may be enabled or disabled by using their corresponding pull-down menus. All algorithms are enabled by default. To open the following window, click **Security Management > Secure Shell (SSH) > SSH Authentication Mode and Algorithm Settings**:

Encryption Algorithm	
3DES-CBC	Enabled ▾
Blow-fish-CBC	Enabled ▾
AES128-CBC	Enabled ▾
AES192-CBC	Enabled ▾
AES256-CBC	Enabled ▾
Arcfour	Enabled ▾
Cast128-CBC	Enabled ▾
Twofish128	Enabled ▾
Twofish192	Enabled ▾
Twofish256	Enabled ▾
Data Integrity Algorithm	
HMAC-SHA1	Enabled ▾
HMAC-MD5	Enabled ▾
Public Key Algorithm	
HMAC-RSA	Enabled ▾
HMAC-DSA	Enabled ▾
Authentication Algorithm	
Password	Enabled ▾
Publickey	Enabled ▾
Host-based	Enabled ▾
Apply	

Figure 8- 6. SSH Algorithms window

The following algorithms may be set:

Parameter	Description
Encryption Algorithm	
3DES-CBC	Use the pull-down to enable or disable the Triple Data Encryption Standard encryption algorithm with Cipher Block Chaining. The default is <i>Enabled</i> .
Blow-fish CBC	Use the pull-down to enable or disable the Blowfish encryption algorithm with Cipher Block Chaining. The default is <i>Enabled</i> .

AES128-CBC	Use the pull-down to enable or disable the Advanced Encryption Standard AES128 encryption algorithm with Cipher Block Chaining. The default is <i>Enabled</i> .
AES192-CBC	Use the pull-down to enable or disable the Advanced Encryption Standard AES192 encryption algorithm with Cipher Block Chaining. The default is <i>Enabled</i> .
AES256-CBC	Use the pull-down to enable or disable the Advanced Encryption Standard AES-256 encryption algorithm with Cipher Block Chaining. The default is <i>Enabled</i> .
ARC4	Use the pull-down to enable or disable the Arcfour encryption algorithm with Cipher Block Chaining. The default is <i>Enabled</i> .
Cast128-CBC	Use the pull-down to enable or disable the Cast128 encryption algorithm with Cipher Block Chaining. The default is <i>Enabled</i> .
Twofish128	Use the pull-down to enable or disable the twofish128 encryption algorithm. The default is <i>Enabled</i> .
Twofish192	Use the pull-down to enable or disable the twofish192 encryption algorithm. The default is <i>Enabled</i> .
Twofish256	Use the pull-down to enable or disable the twofish256 encryption algorithm. The default is <i>Enabled</i> .
Data Integrity Algorithm	
HMAC-SHA1	Use the pull-down to enable or disable the HMAC (Hash for Message Authentication Code) mechanism utilizing the Secure Hash algorithm. The default is <i>Enabled</i> .
HMAC-MD5	Use the pull-down to enable or disable the HMAC (Hash for Message Authentication Code) mechanism utilizing the MD5 Message Digest encryption algorithm. The default is <i>Enabled</i> .
Public Key Algorithm	
HMAC-RSA	Use the pull-down to enable or disable the HMAC (Hash for Message Authentication Code) mechanism utilizing the RSA encryption algorithm. The default is <i>Enabled</i> .
HMAC-DSA	Use the pull-down to enable or disable the HMAC (Hash for Message Authentication Code) mechanism utilizing the Digital Signature Algorithm (DSA) encryption. The default is <i>Enabled</i> .
Authentication Algorithm	
Password	This field may be enabled or disabled to choose if the administrator wishes to use a locally configured password for authentication on the Switch. This field is <i>Enabled</i> by default.
Public Key	This field may be enabled or disabled to choose if the administrator wishes to use a publickey configuration set on a SSH server, for authentication. This field is <i>Enabled</i> by default.
Host-based	This field may be enabled or disabled to choose if the administrator wishes to use a host computer for authentication. This parameter is intended for Linux users requiring SSH authentication techniques and the host computer is running the Linux operating system with a SSH program previously installed. This field is <i>Enabled</i> by default.

Click **Apply** to implement changes made.

SSH User Authentication Mode

The following windows are used to configure parameters for users attempting to access the Switch through SSH. To access the following window, click **Security Management > Secure Shell > SSH User Authentication**.

Current Accounts			
User Name	Auth. Mode	Host Name	Host IP
Darren	Password		

Figure 8- 7. Current Accounts window

In the example screen above, the User Account “Darren” has been previously set using the User Accounts window in the **Security Management** folder. A User Account **MUST** be set in order to set the parameters for the SSH user. To configure the parameters for a SSH user, click on the hyperlinked **User Name** in the **Current Accounts** window, which will reveal the following window to configure.

User Name	<input type="text" value="Darren"/>
Auth. Mode	<input type="text" value="Password"/> ▾
Host Name	<input type="text"/>
Host IP	<input type="checkbox"/> <input type="text" value="0.0.0.0"/>
<input type="button" value="Apply"/>	
Show All User Authentication Entries	

Figure 8- 8. SSH User window

The user may set the following parameters:

Parameter	Description
User Name	Enter a User Name of no more than 15 characters to identify the SSH user. This User Name must be a previously configured user account on the Switch.
Auth. Mode	<p>The administrator may choose one of the following to set the authorization for users attempting to access the Switch.</p> <p><i>Host Based</i> – This parameter should be chosen if the administrator wishes to use a remote SSH server for authentication purposes. Choosing this parameter requires the user to input the following information to identify the SSH user.</p> <ul style="list-style-type: none"> <i>Host Name</i> – Enter an alphanumeric string of no more than 32 characters to identify the remote SSH user. <i>Host IP</i> – Enter the corresponding IP address of the SSH user. <p><i>Password</i> – This parameter should be chosen if the administrator wishes to use an administrator-defined password for authentication. Upon entry of this parameter, the Switch will prompt the administrator for a password, and then to re-type the password for confirmation.</p> <p><i>Public Key</i> – This parameter should be chosen if the administrator wishes to use the public key on a SSH server for authentication.</p>
Host Name	Enter an alphanumeric string of no more than 32 characters to identify the remote SSH user. This parameter is only used in conjunction with the <i>Host Based</i> choice in the Auth. Mode field.
Host IP	Enter the corresponding IP address of the SSH user. This parameter is only used in conjunction with the <i>Host Based</i> choice in the Auth. Mode field.

Click **Apply** to implement changes made.



NOTE: To set the **SSH User Authentication** parameters on the Switch, a User Account must be previously configured. For more information on configuring local User Accounts on the Switch, see the **User Accounts** section of this manual located in this section.

Access Authentication Control

The TACACS / XTACACS / TACACS+ / RADIUS commands let you secure access to the Switch using the TACACS / XTACACS / TACACS+ / RADIUS protocols. When a user logs in to the Switch or tries to access the administrator level privilege, he or she is prompted for a password. If TACACS / XTACACS / TACACS+ / RADIUS authentication is enabled on the Switch, it will contact a TACACS / XTACACS / TACACS+ / RADIUS server to verify the user. If the user is verified, he or she is granted access to the Switch.

There are currently three versions of the TACACS security protocol, each a separate entity. The Switch's software supports the following versions of TACACS:

- **TACACS** (Terminal Access Controller Access Control System) - Provides password checking and authentication, and notification of user actions for security purposes utilizing via one or more centralized TACACS servers, utilizing the UDP protocol for packet transmission.
- **Extended TACACS (XTACACS)** - An extension of the TACACS protocol with the ability to provide more types of authentication requests and more types of response codes than TACACS. This protocol also uses UDP to transmit packets.
- **TACACS+ (Terminal Access Controller Access Control System plus)** - Provides detailed access control for authentication for network devices. TACACS+ is facilitated through Authentication commands via one or more centralized servers. The TACACS+ protocol encrypts all traffic between the Switch and the TACACS+ daemon, using the TCP protocol to ensure reliable delivery

In order for the TACACS / XTACACS / TACACS+ / RADIUS security function to work properly, a TACACS / XTACACS / TACACS+ / RADIUS server must be configured on a device other than the Switch, called an Authentication Server Host and it must include usernames and passwords for authentication. When the user is prompted by the Switch to enter usernames and passwords for authentication, the Switch contacts the TACACS / XTACACS / TACACS+ / RADIUS server to verify, and the server will respond with one of three messages:

- The server verifies the username and password, and the user is granted normal user privileges on the Switch.
- The server will not accept the username and password and the user is denied access to the Switch.
- The server doesn't respond to the verification query. At this point, the Switch receives the timeout from the server and then moves to the next method of verification configured in the method list.

The Switch has four built-in *Authentication Server Groups*, one for each of the TACACS, XTACACS, TACACS+ and RADIUS protocols. These built-in Authentication Server Groups are used to authenticate users trying to access the Switch. The users will set *Authentication Server Hosts* in a preferable order in the built-in Authentication Server Groups and when a user tries to gain access to the Switch, the Switch will ask the first Authentication Server Hosts for authentication. If no authentication is made, the second server host in the list will be queried, and so on. The built-in Authentication Server Groups can only have hosts that are running the specified protocol. For example, the TACACS Authentication Server Groups can only have TACACS Authentication Server Hosts.

The administrator for the Switch may set up six different authentication techniques per user-defined method list (TACACS / XTACACS / TACACS+ / RADIUS / local / none) for authentication. These techniques will be listed in an order preferable, and defined by the user for normal user authentication on the Switch, and may contain up to eight authentication techniques. When a user attempts to access the Switch, the Switch will select the first technique listed for authentication. If the first technique goes through its Authentication Server Hosts and no authentication is returned, the Switch will then go to the next technique listed in the server group for authentication, until the authentication has been verified or denied, or the list is exhausted.

Please note that users granted access to the Switch will be granted normal user privileges on the Switch. To gain access to administrator level privileges, the user must access the **Enable Admin** window and then enter a password, which was previously configured by the administrator of the Switch.



NOTE: TACACS, XTACACS and TACACS+ are separate entities and are not compatible. The Switch and the server must be configured exactly the same, using the same protocol. (For example, if the Switch is set up for TACACS authentication, so must be the host server.)

Authentication Policy & Parameters

This command will enable an administrator-defined authentication policy for users trying to access the Switch. When enabled, the device will check the **Login Method List** and choose a technique for user authentication upon login.

To access the following window, click **Security Management > Access Authentication Control > Authentication Policy & Parameter Settings**:

Figure 8- 9. Authentication Policy and Parameter Settings window

The following parameters can be set:

Parameters	Description
Authentication Policy	Use the pull down menu to enable or disable the Authentication Policy on the Switch.
Response Timeout (1-255)	This field will set the time the Switch will wait for a response of authentication from the user. The user may set a time between 1 and 255 seconds. The default setting is 30 seconds.
User Attempts (1-255)	This command will configure the maximum number of times the Switch will accept authentication attempts. Users failing to be authenticated after the set amount of attempts will be denied access to the Switch and will be locked out of further authentication attempts. Command line interface users will have to wait 60 seconds before another authentication attempt. TELNET and web users will be disconnected from the Switch. The user may set the number of attempts from 1 to 255. The default setting is 3.

Click **Apply** to implement changes made.

Application's Authentication Settings

This window is used to configure switch configuration applications (console, Telnet, SSH, web) for login at the user level and at the administration level (**Enable Admin**) utilizing a previously configured method list. To view the following window, click **Security Management > Access Authentication Control > Application Authentication Settings**:

Application's authentication settings		
Application	Login Method List	Enable Method List
Console	default ▾	default ▾
Telnet	default ▾	default ▾
SSH	default ▾	default ▾
HTTP	default ▾	default ▾
		Apply

Figure 8- 10. Application's Authentication Settings window

The following parameters can be set:

Parameter	Description
Application	Lists the configuration applications on the Switch. The user may configure the Login Method List and Enable Method List for authentication for users utilizing the Console (Command Line Interface) application, the Telnet application, SSH and the Web (HTTP) application.
Login Method List	Using the pull down menu, configure an application for normal login on the user level, utilizing a previously configured method list. The user may use the default Method List or other Method List configured by the user. See the Login Method Lists window, in this section, for more information.
Enable Method List	Using the pull down menu, configure an application for normal login on the user level, utilizing a previously configured method list. The user may use the default Method List or other Method List configured by the user. See the Enable Method Lists window, in this section, for more information.

Click **Apply** to implement changes made.

Authentication Server Group

This window will allow users to set up *Authentication Server Groups* on the Switch. A server group is a technique used to group TACACS/XTACACS/TACACS+/RADIUS server hosts into user-defined categories for authentication using method lists. The user may define the type of server group by protocol or by previously defined server group. The Switch has three built-in Authentication Server Groups that cannot be removed but can be modified. Up to eight authentication server hosts may be added to any particular group.

To view the following window, click **Security Management > Access Authentication Control > Authentication Server Group**:

Authentication Server Group Settings	
Group Name	Delete
Trinity	X
radius	X
tacacs	X
tacacs+	X
xtacacs	X

Figure 8- 11. Authentication Server Group window

This screen displays the Authentication Server Groups on the Switch. The Switch has four built-in Authentication Server Groups that cannot be removed but can be modified. To modify a particular group, click its hyperlinked **Group Name**, which will then display the following window.

Add a Server Host to Server Group (Trinity)		
IP Address	0.0.0.0	
Protocol	TACACS	
Add		
Server Group (Trinity)		
IP Address	Protocol	Delete
Show All Server Group Entries		

Figure 8- 12. Add a Server Host to Server Group (XTACACS) window.

To add an Authentication Server Host to the list, enter its IP address in the IP Address field, choose the protocol associated with the IP address of the Authentication Server Host and click **Add** to add this Authentication Server Host to the group.

To add a server group other than the ones listed, click the add button, revealing the following window to configure.



Figure 8- 13. Authentication Server Group Table Add Settings window

Enter a group name of up to 15 characters into the **Group Name** field and click **Apply**. The entry should appear in the **Authentication Server Group Settings** window, as shown in Figure 8-12 (Trinity).



NOTE: The user must configure Authentication Server Hosts using the Authentication Server Hosts window before adding hosts to the list. Authentication Server Hosts must be configured for their specific protocol on a remote centralized server before this function can work properly.



NOTE: The three built in server groups can only have server hosts running the same TACACS daemon. TACACS/XTACACS/TACACS+ protocols are separate entities and are not compatible with each other.

Authentication Server Host

This window will set user-defined *Authentication Server Hosts* for the TACACS / XTACACS / TACACS+ / RADIUS security protocols on the Switch. When a user attempts to access the Switch with Authentication Policy enabled, the Switch will send authentication packets to a remote TACACS / XTACACS / TACACS+ / RADIUS server host on a remote host. The TACACS / XTACACS / TACACS+ / RADIUS server host will then verify or deny the request and return the appropriate message to the Switch. More than one authentication protocol can be run on the same physical server host but, remember that TACACS / XTACACS / TACACS+ / RADIUS are separate entities and are not compatible with each other. The maximum supported number of server hosts is 16.

To view the following window, click **Security Management > Access Authentication Control > Authentication Server Host**:

Authentication Server Host Settings						
IP Address	Protocol	Port	Timeout	Retransmit	Key	Delete
10.1.1.5	TACACS	49	5	2	---	

Figure 8- 14. Authentication Server Host window

To add an Authentication Server Host, click the **Add** button, revealing the following window:

Authentication Server Host Setting - Add	
IP Address	0.0.0.0
Protocol	TACACS
Port(1-65535)	49
Timeout(1-255)	5
Retransmit(1-255)	2
Key	

[Show All Authentication Server Host Entries](#)

Figure 8- 15. Authentication Server Host Setting - Add window

Configure the following parameters to add an Authentication Server Host:

Parameter	Description
IP Address	The IP address of the remote server host to add.
Protocol	The protocol used by the server host. The user may choose one of the following: <ul style="list-style-type: none"> <i>TACACS</i> - Enter this parameter if the server host utilizes the TACACS protocol. <i>XTACACS</i> - Enter this parameter if the server host utilizes the XTACACS protocol. <i>TACACS+</i> - Enter this parameter if the server host utilizes the TACACS+ protocol. <i>RADIUS</i> - Enter this parameter if the server host utilizes the RADIUS protocol.

Port (1-65535)	Enter a number between 1 and 65535 to define the virtual port number of the authentication protocol on a server host. The default port number is 49 for TACACS/XTACACS/TACACS+ servers and 1813 for RADIUS servers but the user may set a unique port number for higher security.
Timeout (1-255)	Enter the time in seconds the Switch will wait for the server host to reply to an authentication request. The default value is 5 seconds.
Retransmit (1-255)	Enter the value in the retransmit field to change how many times the device will resend an authentication request when the TACACS server does not respond.
Key	Authentication key to be shared with a configured TACACS+ or RADIUS servers only. Specify an alphanumeric string up to 254 characters.

Click **Apply** to add the server host.



NOTE: More than one authentication protocol can be run on the same physical server host but, remember that TACACS/XTACACS/TACACS+ are separate entities and are not compatible with each other

Login Method Lists

This command will configure a user-defined or default **Login Method List** of authentication techniques for users logging on to the Switch. The sequence of techniques implemented in this command will affect the authentication result. For example, if a user enters a sequence of techniques, for example TACACS - XTACACS- local, the Switch will send an authentication request to the first TACACS host in the server group. If no response comes from the server host, the Switch will send an authentication request to the second TACACS host in the server group and so on, until the list is exhausted. At that point, the Switch will restart the same sequence with the following protocol listed, XTACACS. If no authentication takes place using the XTACACS list, the local account database set in the Switch is used to authenticate the user. When the local method is used, the privilege level will be dependant on the local account privilege configured on the Switch.

Successful login using any of these techniques will give the user a "User" privilege only. If the user wishes to upgrade his or her status to the administrator level, the user must use the **Enable Admin** window, in which the user must enter a previously configured password, set by the administrator. (See the **Enable Admin** part of this section for more detailed information concerning the **Enable Admin** command.)

To view the following screen click **Security Management > Access Authentication Control > Login Method Lists**:

Method List Name	Method 1	Method 2	Method 3	Method 4	Delete
default	local				X

Figure 8- 16. Login Method List Settings window

The Switch contains one **Method List** that is set and cannot be removed, yet can be modified. To delete a Login Method List defined by the user, click the  under the **Delete** heading corresponding to the entry desired to be deleted. To modify a Login Method List, click on its hyperlinked **Method List Name**. To configure a new Method List, click the **Add** button.

Both actions will result in the same screen to configure:

Method List Name	default
Method 1	local Keyword
Method 2	
Method 3	
Method 4	

Apply

[Show All Authentication Login Method List Entries](#)

Figure 8- 17. Login Method List - Edit window (default)

Figure 8- 18. Login Method List – Add window

To define a Login Method List, set the following parameters and click **Apply**:

Parameter	Description
Method List Name	Enter a method list name defined by the user of up to 15 characters.
Method 1, 2, 3, 4	<p>The user may add one, or a combination of up to four (4) of the following authentication methods to this method list:</p> <ul style="list-style-type: none"> • <i>tacacs</i> - Adding this parameter will require the user to be authenticated using the TACACS protocol from a remote TACACS server. • <i>xtacacs</i> - Adding this parameter will require the user to be authenticated using the XTACACS protocol from a remote XTACACS server. • <i>tacacs+</i> - Adding this parameter will require the user to be authenticated using the TACACS+ protocol from a remote TACACS+ server. • <i>radius</i> - Adding this parameter will require the user to be authenticated using the RADIUS protocol from a remote RADIUS server. • <i>server_group</i> - Adding this parameter will require the user to be authenticated using a user-defined server group previously configured on the Switch. • <i>local</i> - Adding this parameter will require the user to be authenticated using the local user account database on the Switch. • <i>none</i> - Adding this parameter will require no authentication to access the Switch.

Enable Method Lists

The *Enable Method Lists* window is used to set up Method Lists to promote users with user level privileges to Administrator (Admin) level privileges using authentication methods on the Switch. Once a user acquires normal user level privileges on the Switch, he or she must be authenticated by a method on the Switch to gain administrator privileges on the Switch, which is defined by the Administrator. A maximum of eight (8) Enable Method Lists can be implemented on the Switch, one of which is a default Enable Method List. This default Enable Method List cannot be deleted but can be configured.

The sequence of methods implemented in this command will affect the authentication result. For example, if a user enters a sequence of methods like TACACS - XTACACS - Local Enable, the Switch will send an authentication request to the first TACACS host in the server group. If no verification is found, the Switch will send an authentication request to the second TACACS host in the server group and so on, until the list is exhausted. At that point, the Switch will restart the same sequence with the following protocol listed, XTACACS. If no authentication takes place using the XTACACS list, the Local Enable password set in the Switch is used to authenticate the user.

Successful authentication using any of these methods will give the user an "Admin" privilege.



NOTE: To set the Local Enable Password, see the next section, entitled Local Enable Password.

To view the following table, click **Security Management > Access Authentication Control > Enable Method Lists**:

Enable Method List Settings					
Method List Name	Method 1	Method 2	Method 3	Method 4	Delete
default	local_enable				

Figure 8- 19. Enable Method List Settings window

To delete an Enable Method List defined by the user, click the under the **Delete** heading corresponding to the entry desired to be deleted. To modify an Enable Method List, click on its hyperlinked **Method List Name**. To configure a Method List, click the **Add** button.

Both actions will result in the same screen to configure:

Enable Method List - Edit	
Method List Name	<input type="text" value="default"/>
Method 1	<input type="text" value="local_enable"/> Keyword
Method 2	<input type="text"/>
Method 3	<input type="text"/>
Method 4	<input type="text"/>
<input type="button" value="Apply"/>	
Show All Authentication Enable List Entries	

Figure 8- 20. Enable Method List - Edit window

Figure 8- 21. Enable Method List - Add window

To define an Enable Login Method List, set the following parameters and click **Apply**:

Parameter	Description
Method List Name	Enter a method list name defined by the user of up to 15 characters.
Method 1, 2, 3, 4	<p>The user may add one, or a combination of up to four (4) of the following authentication methods to this method list:</p> <ul style="list-style-type: none"> • <i>local_enable</i> - Adding this parameter will require the user to be authenticated using the local enable password database on the Switch. The local enable password must be set by the user in the next section entitled Local Enable Password. • <i>none</i> - Adding this parameter will require no authentication to access the Switch. • <i>radius</i> - Adding this parameter will require the user to be authenticated using the RADIUS protocol from a remote RADIUS server. • <i>tacacs</i> - Adding this parameter will require the user to be authenticated using the TACACS protocol from a remote TACACS server. • <i>xtacacs</i> - Adding this parameter will require the user to be authenticated using the XTACACS protocol from a remote XTACACS server. • <i>tacacs+</i> - Adding this parameter will require the user to be authenticated using the TACACS protocol from a remote TACACS server. • <i>server_group</i> - Adding a previously configured server group will require the user to be authenticated using a user-defined server group previously configured on the Switch.

Local Enable Password

This window will configure the locally enabled password for the **Enable Admin** command. When a user chooses the "local_enable" method to promote user level privileges to administrator privileges, he or she will be prompted to enter the password configured here that is locally set on the Switch.

To view the following window, click **Security Management > Access Authentication Control > Local Enable Password**:

Figure 8- 22. Configure Local Enable Password window

To set the Local Enable Password, set the following parameters and click **Apply**.

Parameter	Description
Old Local Enable	If a password was previously configured for this entry, enter it here in order to change it to a new password
New Local Enable	Enter the new password that you wish to set on the Switch to authenticate users attempting to access Administrator Level privileges on the Switch. The user may set a password of up to 15 characters.
Confirm Local Enable	Confirm the new password entered above. Entering a different password here from the one set in the New Local Enabled field will result in a fail message.

Click **Apply** to implement changes made.

Enable Admin

The *Enable Admin* window is for users who have logged on to the Switch on the normal user level, and wish to be promoted to the administrator level. After logging on to the Switch, users will have only user level privileges. To gain access to administrator level privileges, the user will open this window and will have to enter an authentication password. Possible authentication methods for this function include TACACS/XTACACS/TACACS+/RADIUS, user defined server groups, local enable (local account on the Switch), or no authentication (none). Because XTACACS and TACACS do not support the enable function, the user must create a special account on the server host, which has the username "enable", and a password configured by the administrator that will support the "enable" function. This function becomes inoperable when the authentication policy is disabled.

To view the following window, click **Security Management > Access Authentication Control > Enable Admin**:

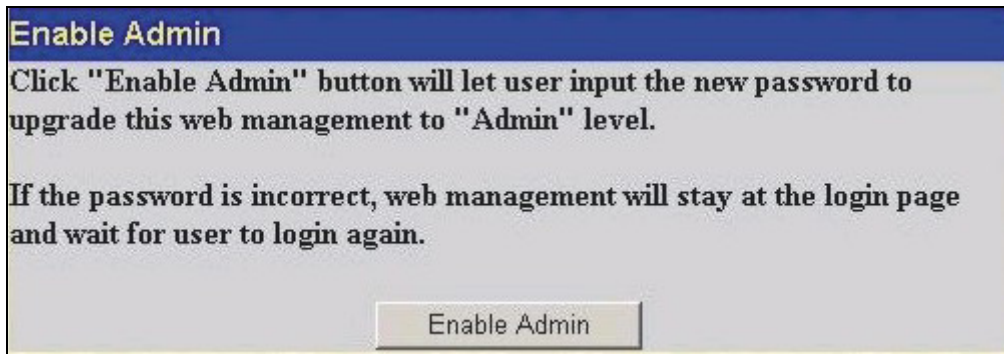

Figure 8- 23. Enable Admin Screen

When this screen appears, click the **Enable Admin** button revealing a window for the user to enter authentication (password, username), as seen below. A successful entry will promote the user to Administrator level privileges on the Switch.



Figure 8- 24. Enter Network Password window

Secure Socket Layer (SSL)

Secure Sockets Layer or *SSL* is a security feature that will provide a secure communication path between a host and client through the use of authentication, digital signatures and encryption. These security functions are implemented through the use of a *ciphersuite*, which is a security string that determines the exact cryptographic parameters, specific encryption algorithms and key sizes to be used for an authentication session and consists of three levels:

1. **Key Exchange:** The first part of the cyphersuite string specifies the public key algorithm to be used. This switch utilizes the Rivest Shamir Adleman (RSA) public key algorithm and the Digital Signature Algorithm (DSA), specified here as the *DHE DSS* Diffie-Hellman (DHE) public key algorithm. This is the first authentication process between client and host as they “exchange keys” in looking for a match and therefore authentication to be accepted to negotiate encryptions on the following level.
2. **Encryption:** The second part of the ciphersuite that includes the encryption used for encrypting the messages sent between client and host. The Switch supports two types of cryptology algorithms:
 - Stream Ciphers – There are two types of stream ciphers on the Switch, *RC4 with 40-bit keys* and *RC4 with 128-bit keys*. These keys are used to encrypt messages and need to be consistent between client and host for optimal use.
 - CBC Block Ciphers – CBC refers to Cipher Block Chaining, which means that a portion of the previously encrypted block of encrypted text is used in the encryption of the current block. The Switch supports the *3DES EDE* encryption code defined by the Data Encryption Standard (DES) to create the encrypted text.
3. **Hash Algorithm:** This part of the ciphersuite allows the user to choose a message digest function which will determine a Message Authentication Code. This Message Authentication Code will be encrypted with a sent message to provide integrity and prevent against replay attacks. The Switch supports two hash algorithms, *MD5* (Message Digest 5) and *SHA* (Secure Hash Algorithm).

These three parameters are uniquely assembled in four choices on the Switch to create a three-layered encryption code for secure communication between the server and the host. The user may implement any one or combination of the ciphersuites available, yet different ciphersuites will affect the security level and the performance of the secured connection. The information included in the ciphersuites is not included with the Switch and requires downloading from a third source in a file form called a *certificate*. This function of the Switch cannot be executed without the presence and implementation of the certificate file and can be downloaded to the Switch by utilizing a TFTP server. The Switch supports SSLv3. Other versions of SSL may not be compatible with this Switch and may cause problems upon authentication and transfer of messages from client to host.

Download Certificate

This window is used to download a certificate file for the SSL function on the Switch from a TFTP server. The certificate file is a data record used for authenticating devices on the network. It contains information on the owner, keys for authentication and digital signatures. Both the server and the client must have consistent certificate files for optimal use of the SSL function. The Switch only supports certificate files with .der file extensions. Currently, all DES-6500 switches come with a certificate pre-loaded though the user may need to download more, depending on user circumstances.

To view the following window, click **Security Management > Secure Socket Layer (SSL) > Download Certificate**:

Download Certificate	
Server IP	<input type="text" value="0.0.0.0"/>
Certificate File Name	<input type="text"/>
Key File Name	<input type="text"/>
<input type="button" value="Apply"/>	
Current Certificate: Loaded with RSA Certificate!	

Figure 8- 25. Download Certificate window

To download certificates, set the following parameters and click **Apply**.

Parameter	Description
Server IP	Enter the IP address of the TFTP server where the certificate files are located.
Certificate File Name	Enter the path and the filename of the certificate file to download. This file must have a .der extension. (Ex. c:/cert.der)
Key File Name	Enter the path and the filename of the key file to download. This file must have a .der extension (Ex. c:/pkey.der)

Click **Apply** to implement changes made.

Configuration

This screen will allow the user to enable SSL on the Switch and implement any one or combination of listed ciphersuites on the Switch. A *ciphersuite* is a security string that determines the exact cryptographic parameters, specific encryption algorithms and key sizes to be used for an authentication session. The Switch possesses four possible ciphersuites for the SSL function, which are all enabled by default. To utilize a particular ciphersuite, disable the unwanted ciphersuites, leaving the desired one for authentication.

When the SSL function has been enabled, the web will become disabled. To manage the Switch through the web based management while utilizing the SSL function, the web browser must support SSL encryption and the header of the URL must begin with https://. (Ex. https://10.90.90.90) Any other method will result in an error and no access can be authorized for the web-based management.

To view the following window, click **Security Management > Secure Socket Layer (SSL) > Configuration**:

The screenshot shows the 'SSL Configuration' window. It has a blue header with the title 'SSL Configuration'. Below the header is a section titled 'Ciphersuite' with a blue background. This section contains four rows, each with a ciphersuite name, a status dropdown menu, and a hexadecimal value:

RSA with RC4 128 MD5	Enabled	0x0004
RSA with 3DES EDE CBC SHA	Enabled	0x000a
DHE DSS with 3DES EDE CBC SHA	Enabled	0x0013
RSA EXPORT with RC4 40 MD5	Enabled	0x0003

Below the ciphersuite section is another blue header titled 'Configuration'. This section contains two rows:

Cache Timeout(60-86400 sec)	600
SSL Status	Disabled

At the bottom right of the window is an 'Apply' button.

Figure 8- 26. Ciphersuite window

To set up the SSL function on the Switch, configure the following parameters and click **Apply**.

Parameter	Description
Ciphersuite	
RSA with RC4 128 MD5	This ciphersuite combines the RSA key exchange, stream cipher RC4 encryption with 128-bit keys and the MD5 Hash Algorithm. Use the pull down menu to enable or disable this ciphersuite. This field is <i>Enabled</i> by default.
RSA with 3DES EDE CBC SHA	This ciphersuite combines the RSA key exchange, CBC Block Cipher 3DES_EDE encryption and the SHA Hash Algorithm. Use the pull down menu to enable or disable this ciphersuite. This field is <i>Enabled</i> by default.

DHS DSS with 3DES EDE CBC SHA	This ciphersuite combines the DSA Diffie Hellman key exchange, CBC Block Cipher 3DES_EDE encryption and SHA Hash Algorithm. Use the pull down menu to enable or disable this ciphersuite. This field is <i>Enabled</i> by default.
RSA EXPORT with RC4 40 MD5	This ciphersuite combines the RSA Export key exchange and stream cipher RC4 encryption with 40-bit keys. Use the pull down menu to enable or disable this ciphersuite. This field is <i>Enabled</i> by default.
Configuration	
SSL Status	Use the pull down menu to enable or disable the SSL status on the switch. The default is <i>Disabled</i> .
Cache Timeout (60-86400)	This field will set the time between a new key exchange between a client and a host using the SSL function. A new SSL session is established every time the client and host go through a key exchange. Specifying a longer timeout will allow the SSL session to reuse the master key on future connections with that particular host, therefore speeding up the negotiation process. The default setting is 600 seconds.



NOTE: Certain implementations concerning the function and configuration of SSL are not available on the web-based management of this Switch and need to be configured using the command line interface. For more information on SSL and its functions, see the ***DES-6500 Command Line Interface Reference Manual***, located on the documentation CD of this product.



NOTE: Enabling the SSL command will disable the web-based switch management. To log on to the Switch again, the header of the URL must begin with https://. Entering anything else into the address field of the web browser will result in an error and no authentication will be granted.

Section 8

SNMP Manager

SNMP Settings

Simple Network Management Protocol (SNMP) is an OSI Layer 7 (Application Layer) designed specifically for managing and monitoring network devices. SNMP enables network management stations to read and modify the settings of gateways, routers, switches, and other network devices. Use SNMP to configure system features for proper operation, monitor performance and detect potential problems in the Switch, switch group or network.

Managed devices that support SNMP include software (referred to as an agent), which runs locally on the device. A defined set of variables (managed objects) is maintained by the SNMP agent and used to manage the device. These objects are defined in a Management Information Base (MIB), which provides a standard presentation of the information controlled by the on-board SNMP agent. SNMP defines both the format of the MIB specifications and the protocol used to access this information over the network.

The DES-6500 switch supports the SNMP versions 1, 2c, and 3. You can specify which version of the SNMP you want to use to monitor and control the Switch. The three versions of SNMP vary in the level of security provided between the management station and the network device.

In SNMP v.1 and v.2c, user authentication is accomplished using 'community strings', which function like passwords. The remote user SNMP application and the Switch SNMP must use the same community string. SNMP packets from any station that has not been authenticated are ignored (dropped).

The default community strings for the Switch used for SNMP v.1 and v.2c management access are:

public - Allows authorized management stations to retrieve MIB objects.

private - Allows authorized management stations to retrieve and modify MIB objects.

SNMPv3 uses a more sophisticated authentication process that is separated into two parts. The first part is to maintain a list of users and their attributes that are allowed to act as SNMP managers. The second part describes what each user on that list can do as an SNMP manager.

The Switch allows groups of users to be listed and configured with a shared set of privileges. The SNMP version may also be set for a listed group of SNMP managers. Thus, you may create a group of SNMP managers that are allowed to view read-only information or receive traps using SNMPv1 while assigning a higher level of security to another group, granting read/write privileges using SNMPv3.

Using SNMPv3 individual users or groups of SNMP managers can be allowed to perform or be restricted from performing specific SNMP management functions. The functions allowed or restricted are defined using the Object Identifier (OID) associated with a specific MIB. An additional layer of security is available for SNMPv3 in that SNMP messages may be encrypted. To read more about how to configure SNMPv3 settings for the Switch read the next section.

Traps

Traps are messages that alert network personnel of events that occur on the Switch. The events can be as serious as a reboot (someone accidentally turned OFF the Switch), or less serious like a port status change. The Switch generates traps and sends them to the trap recipient (or network manager). Typical traps include trap messages for Authentication Failure, Topology Change and New Root.

MIBs

Management and counter information are stored by the Switch in the Management Information Base (MIB). The Switch uses the standard MIB-II Management Information Base module. Consequently, values for MIB objects can be retrieved from any SNMP-based network management software. In addition to the standard MIB-II, the Switch also supports its own proprietary enterprise MIB as an extended Management Information Base. The proprietary MIB may also be retrieved by specifying the MIB Object Identifier. MIB values can be either read-only or read-write.

The DES-6500 switch incorporates a flexible SNMP management for the switching environment. SNMP management can be customized to suit the needs of the networks and the preferences of the network administrator. Use the SNMP V3 menus to select the SNMP version used for specific tasks.

The DES-6500 switch supports the Simple Network Management Protocol (SNMP) versions 1, 2c, and 3. The administrator can specify the SNMP version used to monitor and control the Switch. The three versions of SNMP vary in the level of security provided between the management station and the network device.

SNMP settings are configured using the menus located on the SNMP V3 folder of the web manager. Workstations on the network that are allowed SNMP privileged access to the Switch can be restricted with the Management Station IP Address menu.

SNMP Trap Settings

The following window is used to enable or disable SNMP traps on the Switch. There are two types of traps located on the Switch, SNMP traps and SNMP Authenticate traps which the user may enable or disable by using the corresponding pull-down menu. After changes are made, click the **Apply** button to save it to the Switch's memory.

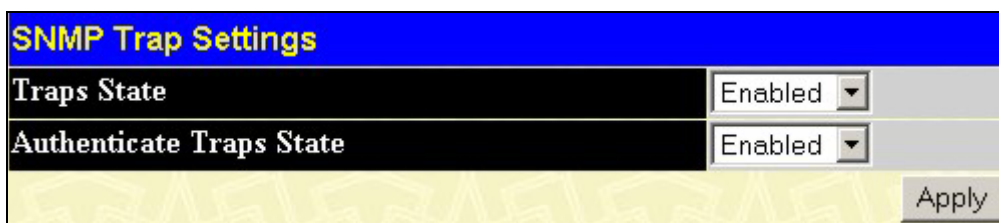

SNMP Trap Settings	
Traps State	Enabled ▾
Authenticate Traps State	Enabled ▾
Apply	

Figure 8- 27. SNMP Trap Settings window

SNMP User Table

The **SNMP User Table** displays all of the SNMP User's currently configured on the Switch.

In the **SNMP Manager** folder, click on the **SNMP User Table** link. This will open the **SNMP User Table**, as shown below.



SNMP User Table			
User Name	Group Name	SNMP Version	Delete
initial	initial	V3	<input type="checkbox"/>

Figure 8- 28. SNMP User Table

To delete an existing SNMP User Table entry, click the below the **Delete** heading corresponding to the entry you wish to delete.

To display the detailed entry for a given user, click on the hyperlinked User Name. This will open the **SNMP User Table Display** page, as shown below.

SNMP User Table Display	
User Name	initial
Group Name	initial
SNMP Version	V3
Auth-Protocol	None
Priv-Protocol	None
Show All SNMP User Table Entries	

Figure 8- 29. SNMP User Table Display

The following parameters are displayed:

Parameter	Description
User Name	An alphanumeric string of up to 32 characters. This is used to identify the SNMP users.
Group Name	This name is used to specify the SNMP group created can request SNMP messages.
SNMP Version	V1 - Indicates that SNMP version 1 is in use. V2 - Indicates that SNMP version 2 is in use. V3 - Indicates that SNMP version 3 is in use.
Auth-Protocol	<i>None</i> - Indicates that no authorization protocol is in use. <i>MD5</i> - Indicates that the HMAC-MD5-96 authentication level will be used. <i>SHA</i> - Indicates that the HMAC-SHA authentication protocol will be used.
Priv-Protocol	<i>None</i> - Indicates that no authorization protocol is in use. <i>DES</i> - Indicates that DES 56-bit encryption is in use based on the CBC-DES (DES-56) standard.

To return to the **SNMP User Table**, click the [Show All SNMP User Table Entries](#) link.

To add a new entry to the **SNMP User Table Configuration**, click on the **Add** button on the **SNMP User Table** page. This will open the **SNMP User Table Configuration** page, as shown below.

SNMP User Table Configuration	
User Name	<input type="text"/>
Group Name	<input type="text"/>
SNMP Version	V3 <input type="checkbox"/> encrypted
Method	By Password <input type="checkbox"/>
Auth-Protocol	MD5 <input type="text" value="Password"/>
Priv-Protocol	DES <input type="text" value="Password"/>
Apply	
Show All SNMP User Table Entries	

Figure 8- 30. SNMP User Table Configuration window

The following parameters can set:

Parameter	Description
User Name	Enter an alphanumeric string of up to 32 characters. This is used to identify the SNMP user.
Group Name	This name is used to specify the SNMP group created can request SNMP messages.
SNMP Version	V1 - Specifies that SNMP version 1 will be used. V2 - Specifies that SNMP version 2 will be used. V3 - Specifies that SNMP version 3 will be used.
Method	This field only becomes possible to configure when the encrypted check box is clicked in the following field. This field requires the user to choose the type of encryption to be employed for this SNMP user. The user may choose: <i>By Password</i> – Requires the SNMP user to enter a password for authentication and privacy. The password is defined by specifying the auth password below. This method is recommended. <i>By Key</i> - Requires the SNMP user to enter a encryption key for authentication and privacy. The key is defined by specifying the key in hex form below. This method is not recommended.
Auth-Protocol	<i>MD5</i> - Specifies that the HMAC-MD5-96 authentication level will be used. This field is only operable when <i>V3</i> is selected in the SNMP Version field and the Encryption field has been checked. This field will require the user to enter a password. <i>SHA</i> - Specifies that the HMAC-SHA authentication protocol will be used. This field is only operable when <i>V3</i> is selected in the SNMP Version field and the Encryption field has been checked. This field will require the user to enter a password.
Priv-Protocol	<i>None</i> - Specifies that no authorization protocol is in use. <i>DES</i> - Specifies that DES 56-bit encryption is in use, based on the CBC-DES (DES-56) standard. This field is only operable when <i>V3</i> is selected in the SNMP Version field and the Encryption field has been checked. This field will require the user to enter a password between 8 and 16 alphanumeric characters.
Encrypted	Checking the corresponding box will enable encryption for SNMP V3 and is only operable in SNMP V3 mode.

To implement changes made, click **Apply**. To return to the **SNMP User Table**, click the [Show All SNMP User Table Entries](#) link.

SNMP View Table

The SNMP View Table is used to assign views to community strings that define which MIB objects can be accessed by a remote SNMP manager. To view the **SNMP View Table**, open the **SNMP Manager** folder and click the **SNMP View Table** entry. The following screen should appear:

Add			
Total Entries:8 (Note:Maximum of 30 entries.)			
SNMP View Table			
View Name	Subtree	View Type	Delete
restricted	1.3.6.1.2.1.1	Included	X
restricted	1.3.6.1.2.1.11	Included	X
restricted	1.3.6.1.6.3.10.2.1	Included	X
restricted	1.3.6.1.6.3.11.2.1	Included	X
restricted	1.3.6.1.6.3.15.1.1	Included	X
CommunityView	1	Included	X
CommunityView	1.3.6.1.6.3	Excluded	X
CommunityView	1.3.6.1.6.3.1	Included	X

Figure 8- 31. SNMP View Table

To delete an existing **SNMP View Table** entry, click the in the **Delete** column corresponding to the entry to delete. To create a new entry, click the **Add** button and a separate menu will appear.

SNMP View Table Configuration	
View Name	<input type="text"/>
Subtree OID	<input type="text"/>
View Type	Included <input type="button" value="v"/>
<input type="button" value="Apply"/>	
Show All SNMP View Table Entries	

Figure 8- 32. SNMP View Table Configuration window

The SNMP Group created with this table maps SNMP users (identified in the **SNMP User Table**) to the views created in the previous menu.

The following parameters can set:

Parameter	Description
View Name	Type an alphanumeric string of up to 32 characters. This is used to identify the new SNMP view being created.
Subtree OID	Type the Object Identifier (OID) Subtree for the view. The OID identifies an object tree (MIB tree) that will be included or excluded from access by an SNMP manager.
View Type	Select Included to include this object in the list of objects that an SNMP manager can access. Select Excluded to exclude this object from the list of objects that an SNMP manager can access.

To implement your new settings, click **Apply**. To return to the **SNMP View Table**, click the [Show All SNMP View Table Entries](#) link.

SNMP Group Table

An SNMP Group created with this table maps SNMP users (identified in the SNMP User Table) to the views created in the previous menu. To view the **SNMP Group Table**, open the **SNMP Manager** folder and click the **SNMP Group Table** entry. The following screen should appear:

Add			
Total Entries:9 (Note:Maximum of 30 entries.)			
SNMP Group Table			
Group Name	Security Model	Security Level	Delete
public	SNMPv1	NoAuthNoPriv	<input type="checkbox"/>
public	SNMPv2	NoAuthNoPriv	<input type="checkbox"/>
initial	SNMPv3	NoAuthNoPriv	<input type="checkbox"/>
private	SNMPv1	NoAuthNoPriv	<input type="checkbox"/>
private	SNMPv2	NoAuthNoPriv	<input type="checkbox"/>
ReadGroup	SNMPv1	NoAuthNoPriv	<input type="checkbox"/>
ReadGroup	SNMPv2	NoAuthNoPriv	<input type="checkbox"/>
WriteGroup	SNMPv1	NoAuthNoPriv	<input type="checkbox"/>
WriteGroup	SNMPv2	NoAuthNoPriv	<input type="checkbox"/>

Figure 8- 33. SNMP Group Table

To delete an existing **SNMP Group Table** entry, click the corresponding under the **Delete** heading.

To display the current settings for an existing **SNMP Group Table** entry, click the hyperlink for the entry under the **Group Name**.

SNMP Group Table Display	
Group Name	public
Read View Name	CommunityView
Write View Name	
Notify View Name	CommunityView
Security Model	SNMPv1
Security Level	NoAuthNoPriv
Show All SNMP Group Table Entries	

Figure 8- 34. SNMP Group Table Display – View window

To add a new entry to the Switch's **SNMP Group Table**, click the **Add** button in the upper left-hand corner of the **SNMP Group Table** page. This will open the **SNMP Group Table Configuration** page, as shown below.

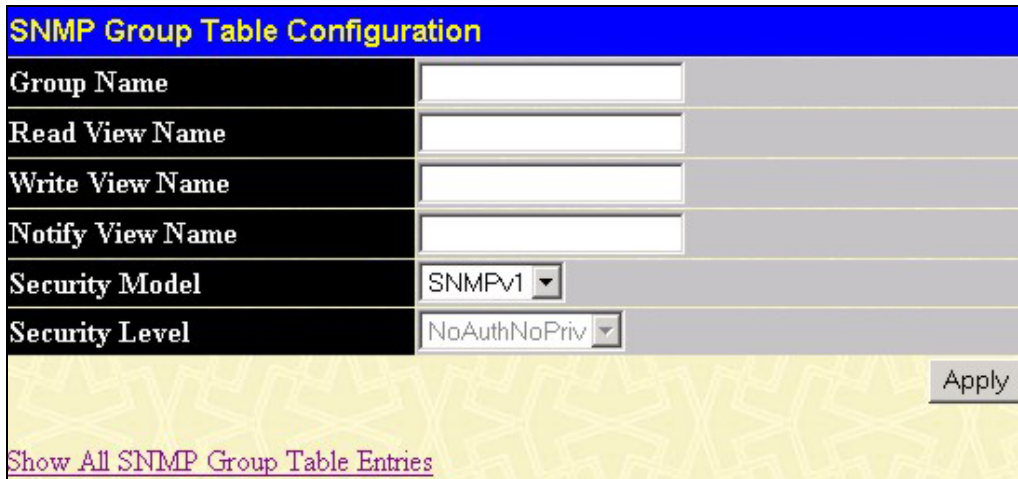

The image shows a configuration window titled "SNMP Group Table Configuration". It contains several input fields and dropdown menus. The fields are: Group Name, Read View Name, Write View Name, and Notify View Name, all of which are empty. The Security Model dropdown is set to "SNMPv1" and the Security Level dropdown is set to "NoAuthNoPriv". There is an "Apply" button at the bottom right and a link "Show All SNMP Group Table Entries" at the bottom left.

Figure 8- 35. SNMP Group Table Configuration – Add window

The following parameters can set:

Parameter	Description
Group Name	Type an alphanumeric string of up to 32 characters. This is used to identify the new SNMP group of SNMP users.
Read View Name	This name is used to specify the SNMP group created can request SNMP messages.
Write View Name	Specify a SNMP group name for users that are allowed SNMP write privileges to the Switch's SNMP agent.
Notify View Name	Specify a SNMP group name for users that can receive SNMP trap messages generated by the Switch's SNMP agent.
Security Model	<p><i>SNMPv1</i> - Specifies that SNMP version 1 will be used.</p> <p><i>SNMPv2</i> - Specifies that SNMP version 2c will be used. The SNMPv2 supports both centralized and distributed network management strategies. It includes improvements in the Structure of Management Information (SMI) and adds some security features.</p> <p><i>SNMPv3</i> - Specifies that the SNMP version 3 will be used. SNMPv3 provides secure access to devices through a combination of authentication and encrypting packets over the network.</p>
Security Level	<p>The Security Level settings only apply to SNMPv3.</p> <ul style="list-style-type: none"> <i>NoAuthNoPriv</i> - Specifies that there will be no authorization and no encryption of packets sent between the Switch and a remote SNMP manager. <i>AuthNoPriv</i> - Specifies that authorization will be required, but there will be no encryption of packets sent between the Switch and a remote SNMP manager. <i>AuthPriv</i> - Specifies that authorization will be required, and that packets sent between the Switch and a remote SNMP manger will be encrypted.

To implement your new settings, click **Apply**. To return to the **SNMP Group Table**, click the [Show All SNMP Group Table Entries](#) link.

SNMP Community Table

Use this table to create an SNMP community string to define the relationship between the SNMP manager and an agent. The community string acts like a password to permit access to the agent on the Switch. One or more of the following characteristics can be associated with the community string:

- An Access List of IP addresses of SNMP managers that are permitted to use the community string to gain access to the Switch's SNMP agent.
- Any MIB view that defines the subset of all MIB objects will be accessible to the SNMP community.
- Read/write or read-only level permission for the MIB objects accessible to the SNMP community.

To configure **SNMP Community** entries, open the **SNMP Manager** folder, and click the **SNMP Community Table** link, which will open the following screen:

Community Name	View Name	Access Right	
<input type="text"/>	<input type="text"/>	Read_Only	<input type="button" value="Apply"/>
Total Entries: 2 (Note: Maximum of 10 entries.)			
Community Name	View Name	Access Right	Delete
private	CommunityView	Read_Write	<input type="button" value="X"/>
public	CommunityView	Read_Only	<input type="button" value="X"/>

Figure 8- 36. SNMP Community Table window

The following parameters can set:

Parameter	Description
Community Name	Type an alphanumeric string of up to 32 characters that is used to identify members of an SNMP community. This string is used like a password to give remote SNMP managers access to MIB objects in the Switch's SNMP agent.
View Name	Type an alphanumeric string of up to 32 characters that is used to identify the group of MIB objects that a remote SNMP manager is allowed to access on the Switch. The view name must exist in the SNMP View Table.
Access Right	<p><i>Read Only</i> - Specifies that SNMP community members using the community string created can only read the contents of the MIBs on the Switch.</p> <p><i>Read Write</i> - Specifies that SNMP community members using the community string created can read from, and write to the contents of the MIBs on the Switch.</p>

To implement the new settings, click **Apply**. To delete an entry from the **SNMP Community Table**, click the  under the **Delete** heading, corresponding to the entry you wish to delete.

SNMP Host Table

Use the **SNMP Host Table** to set up SNMP trap recipients.

Open the **SNMP Manager** folder and click on the **SNMP Host Table** link. This will open the **SNMP Host Table** page, as shown below.

To delete an existing **SNMP Host Table** entry, click the corresponding  under the **Delete** heading.

To display the current settings for an existing **SNMP Group Table** entry, click the blue link for the entry under the **Host IP Address** heading.

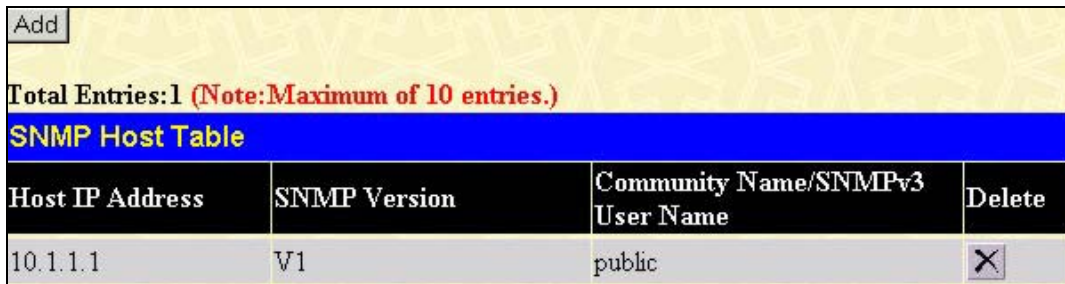

SNMP Host Table			
Host IP Address	SNMP Version	Community Name/SNMPv3 User Name	Delete
10.1.1.1	V1	public	

Figure 8- 37. SNMP Host Table

To add a new entry to the Switch's **SNMP Host Table**, click the **Add** button in the upper left-hand corner of the page. This will open the **SNMP Host Table Configuration** page, as shown below.

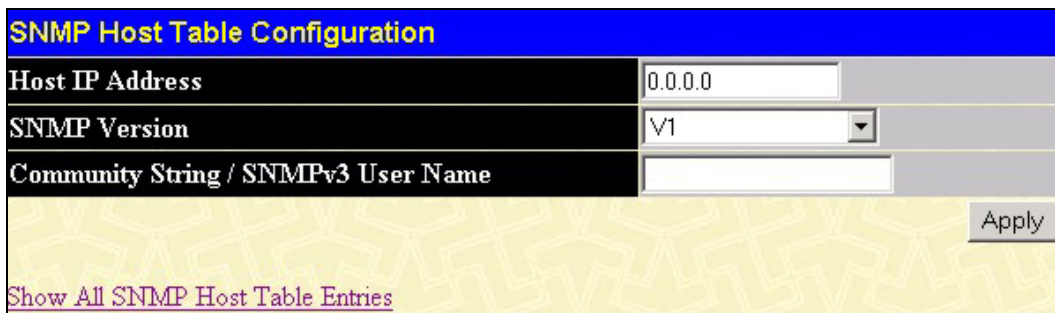

Figure 8- 38. SNMP Host Table Configuration window

The following parameters can set:

Parameter	Description
Host IP Address	Type the IP address of the remote management station that will serve as the SNMP host for the Switch.
SNMP Version	<p>V1 - To specifies that SNMP version 1 will be used.</p> <p>V2 - To specify that SNMP version 2 will be used.</p> <p>V3-NoAuth-NoPriv - To specify that the SNMP version 3 will be used, with a NoAuth-NoPriv security level.</p> <p>V3-Auth-NoPriv - To specify that the SNMP version 3 will be used, with an Auth-NoPriv security level.</p> <p>V3-Auth-Priv - To specify that the SNMP version 3 will be used, with an Auth-Priv security level.</p>
Community String or SNMP V3 User Name	Type in the community string or SNMP V3 user name as appropriate.

To implement your new settings, click **Apply**. To return to the **SNMP Host Table**, click the [Show All SNMP Host Table Entries](#) link.

SNMP Engine ID

The Engine ID is a unique identifier used for SNMP V3 implementations. This is an alphanumeric string used to identify the SNMP engine on the Switch.

To display the Switch's SNMP Engine ID, open the **SNMP Manger** folder and click on the **SNMP Engine ID** link. This will open the **SNMP Engine ID Configuration** window, as shown below.

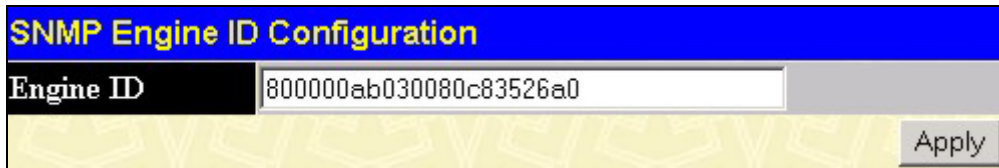
The image shows a configuration window titled "SNMP Engine ID Configuration". It features a blue header bar with the title in yellow text. Below the header, there is a label "Engine ID" in a black box on the left, and a white text input field on the right containing the alphanumeric string "800000ab030080c83526a0". At the bottom right of the window, there is a grey button labeled "Apply". The background of the window is light yellow with a faint, repeating pattern of the letters "SVS".

SNMP Engine ID Configuration	
Engine ID	800000ab030080c83526a0
Apply	

Figure 8- 39. SNMP Engine ID Configuration window

To change the Engine ID, type the new Engine ID in the space provided and click the **Apply** button.

Section 9

Monitoring

CPU Utilization

Port Utilization

Packets

Errors

Size

Stacking Information

Device Status

MAC Address

Switch History Log

IGMP Snooping Group

IGMP Snooping Forward

Browse Router Port

Port Access Control

Layer 3 Feature

CPU Utilization

The **CPU Utilization** displays the percentage of the CPU being used, expressed as an integer percentage and calculated as a simple average by time interval. To view the **CPU Utilization** window, open the **Monitoring** folder and click the **CPU Utilization** link.

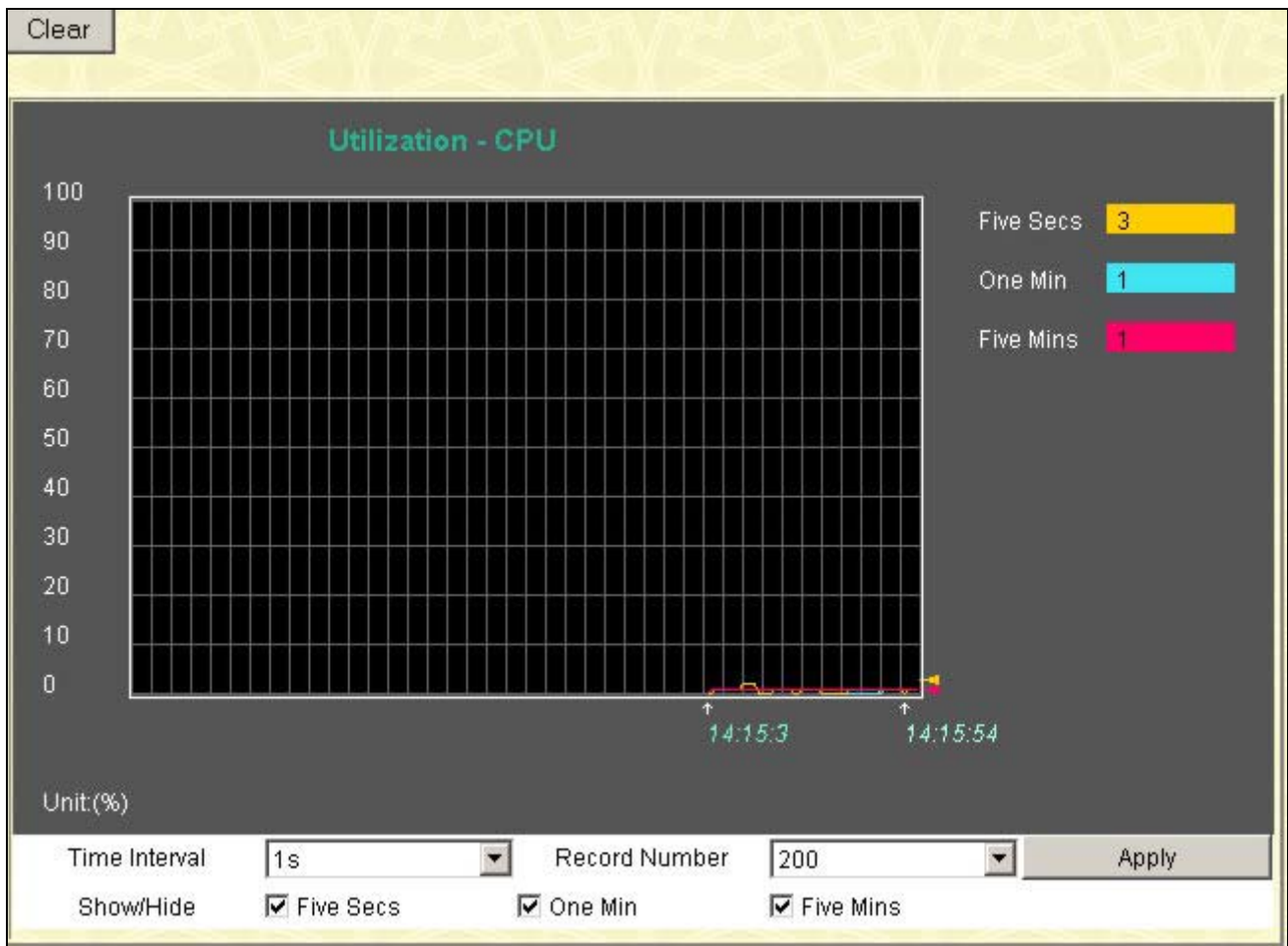

Figure 9- 1. CPU Utilization graph

To view the CPU utilization by port, use the real-time graphic of the Switch and/or switch stack at the top of the web page by simply clicking on a port. Click **Apply** to implement the configured settings. The window will automatically refresh with new updated statistics.

The information is described as follows:

Parameter	Description
Time Interval [1s]	Select the desired setting between 1s and 60s, where "s" stands for seconds. The default value is one second.
Record Number [200]	Select number of times the Switch will be polled between 20 and 200. The default value is 200.

Port Utilization

The **Port Utilization** page displays the percentage of the total available bandwidth being used on the port.

To view the port utilization, open the **Monitoring** folder and then the **Port Utilization** link:

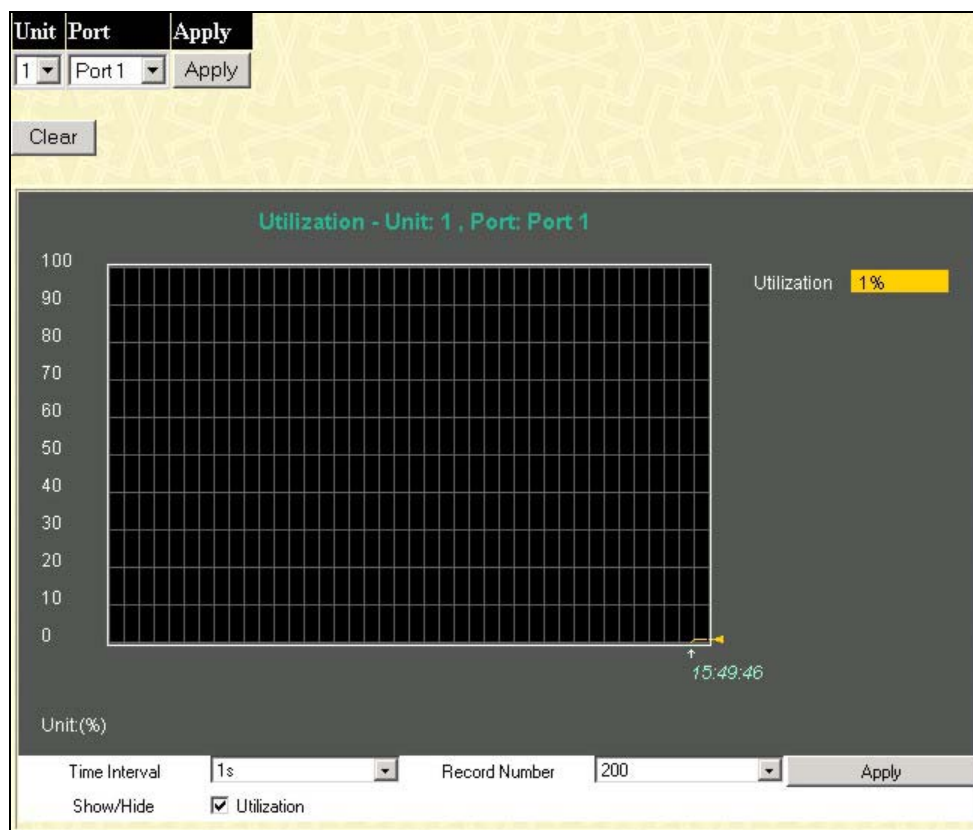

Figure 9- 2. Port Utilization window

To select a port to view these statistics for, first select the line card slot in the chassis switch by using the **Unit** pull-down menu and then select the port by using the **Port** pull down menu. The user may also use the real-time graphic of the Switch and/or switch stack at the top of the web page by simply clicking on a port. The following field can be set:

Parameter	Description
Time Interval	Select the desired setting between 1s and 60s, where "s" stands for seconds. The default value is one second.
Record Number	Select number of times the Switch will be polled between 20 and 200. The default value is 200.

Click **Clear** to refresh the graph. Click **Apply** to implement changes made.

Packets

The Web Manager allows various packet statistics to be viewed as either a line graph or a table. Six windows are offered.

Received (RX)

Click the **Received (RX)** link in the **Packets** folder of the **Monitoring** menu to view the following graph of packets received on the Switch. To select a port to view these statistics for, first select the Switch in the switch stack by using the **Unit** pull-down menu and then select the port by using the **Port** pull down menu. The user may also use the real-time graphic of the Switch and/or switch stack at the top of the web page by simply clicking on a port.

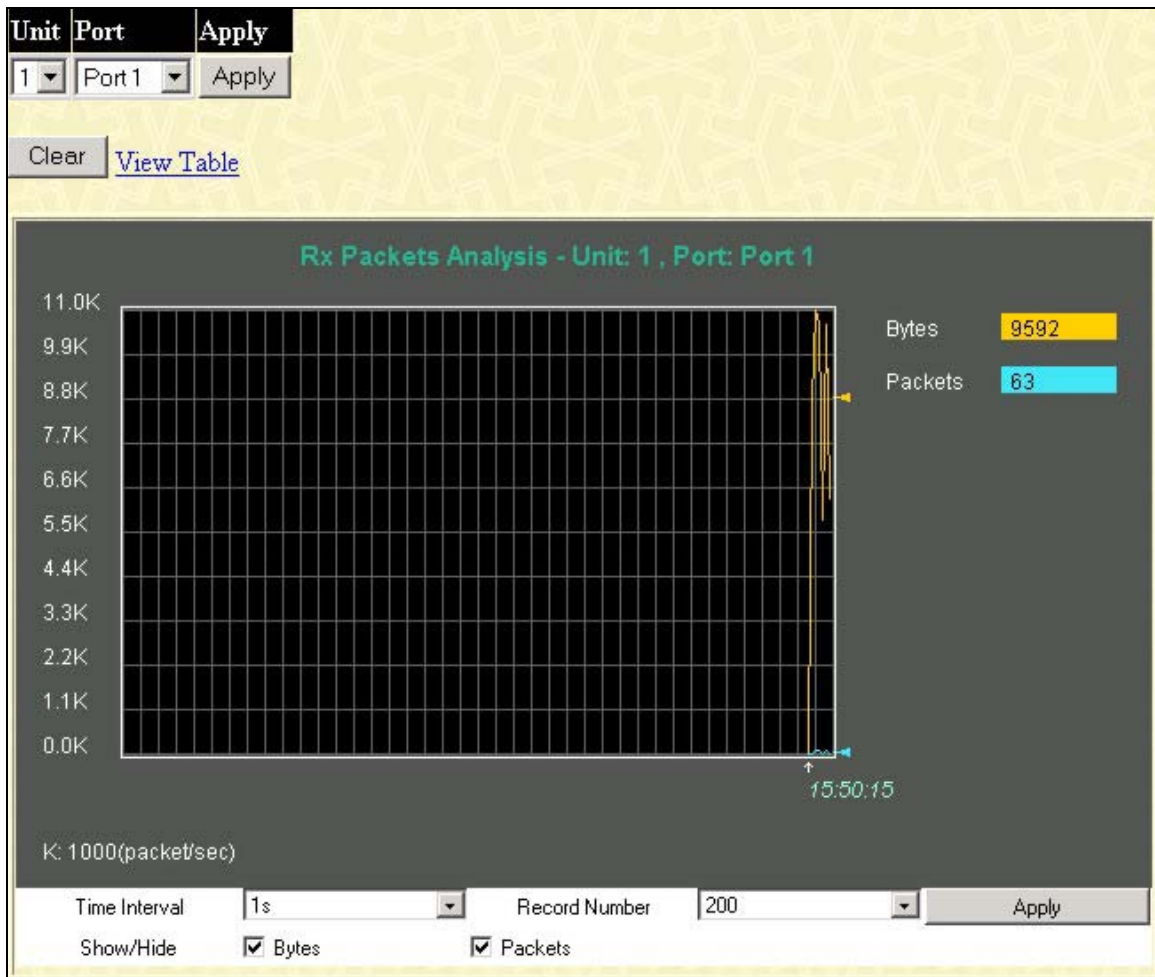

Figure 9- 3. Rx Packets Analysis window (line graph for Bytes and Packets)

To view the **Received Packets Table**, click the link [View Table](#), which will show the following table:

[View LineChart](#)

Unit: 1 , Port: Port 1 Time Interval

Rx Packets	Total	Rate(1/Sec)	Max Rate
Bytes	0	0	0
Packets	0	0	0

Rx Packets	Total	Rate(1/Sec)	Max Rate
Unicast	0	0	0
Multicast	0	0	0
Broadcast	0	0	0

Tx Packets	Total	Rate(1/Sec)	Max Rate
Bytes	0	0	0
Packets	0	0	0

Figure 9- 4. Rx Packets Analysis Table

The following fields may be set or viewed:

Parameter	Description
Time Interval [1s]	Select the desired setting between 1s and 60s, where "s" stands for seconds. The default value is one second.
Record Number [200]	Select number of times the Switch will be polled between 20 and 200. The default value is 200.
Bytes	Counts the number of bytes received on the port.
Packets	Counts the number of packets received on the port.
Unicast	Counts the total number of good packets that were received by a unicast address.
Multicast	Counts the total number of good packets that were received by a multicast address.
Broadcast	Counts the total number of good packets that were received by a broadcast address.
Show/Hide	Check whether to display Bytes and Packets.
Clear	Clicking this button clears all statistics counters on this window.
View Table	Clicking this button instructs the Switch to display a table rather than a line graph.
View Line Chart	Clicking this button instructs the Switch to display a line graph rather than a table.

UMB Cast (RX)

Click the **UMB Cast (RX)** link in the **Packets** folder of the **Monitoring** menu to view the following graph of UMB cast packets received on the Switch. To select a port to view these statistics for, first select the Switch in the switch stack by using the **Unit** pull-down menu and then select the port by using the **Port** pull down menu. The user may also use the real-time graphic of the Switch and/or switch stack at the top of the web page by simply clicking on a port.



Figure 9- 5. Rx Packets Analysis window (line graph for Unicast, Multicast, and Broadcast Packets)

To view the **UMB Cast Table**, click the [View Table](#) link, which will show the following table:

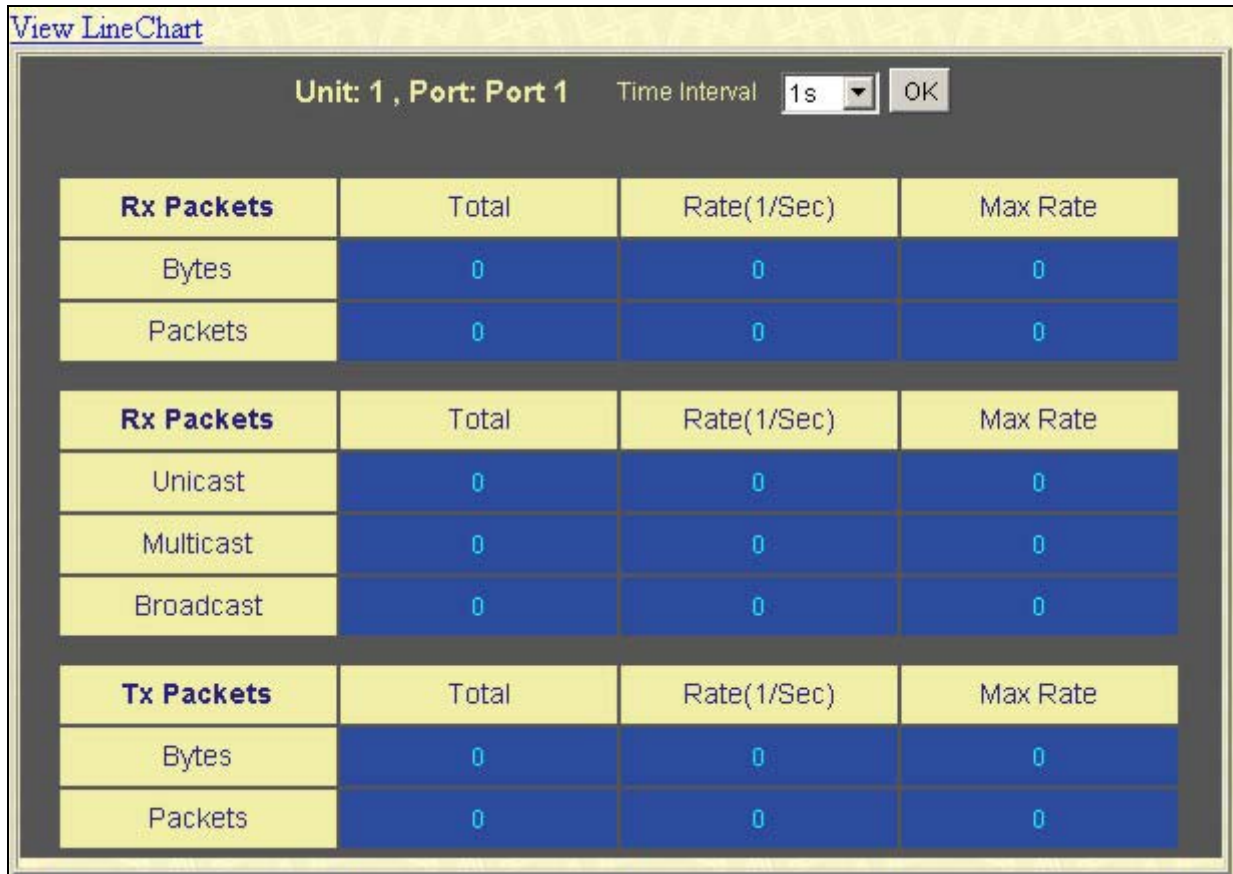

Figure 9- 6. Rx Packets Analysis window (table for Unicast, Multicast, and Broadcast Packets)

The following fields may be set or viewed:

Parameter	Description
Time Interval [1s]	Select the desired setting between 1s and 60s, where "s" stands for seconds. The default value is one second.
Record Number [200]	Select number of times the Switch will be polled between 20 and 200. The default value is 200.
Unicast	Counts the total number of good packets that were received by a unicast address.
Multicast	Counts the total number of good packets that were received by a multicast address.
Broadcast	Counts the total number of good packets that were received by a broadcast address.
Show/Hide	Check whether or not to display Multicast, Broadcast, and Unicast Packets.
Clear	Clicking this button clears all statistics counters on this window.
View Table	Clicking this button instructs the Switch to display a table rather than a line graph.
View Line Chart	Clicking this button instructs the Switch to display a line graph rather than a table.

Transmitted (TX)

Click the **Transmitted (TX)** link in the **Packets** folder of the **Monitoring** menu to view the following graph of packets transmitted from the Switch. To select a port to view these statistics for, first select the Switch in the switch stack by using the **Unit** pull-down menu and then select the port by using the Port pull down menu. The user may also use the real-time graphic of the Switch and/or switch stack at the top of the web page by simply clicking on a port.

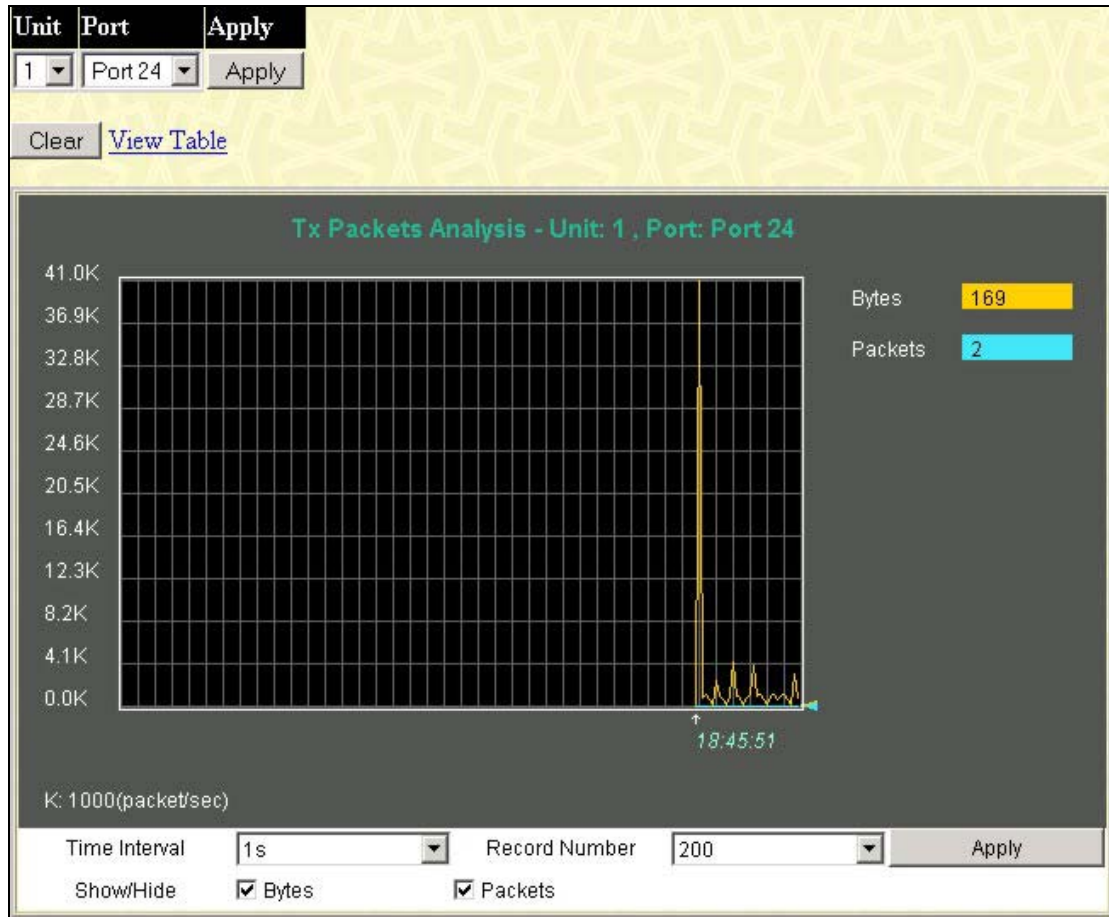

Figure 9- 7. Tx Packets Analysis window (line graph for Bytes and Packets)

To view the **Transmitted (TX) Table**, click the link [View Table](#), which will show the following table:

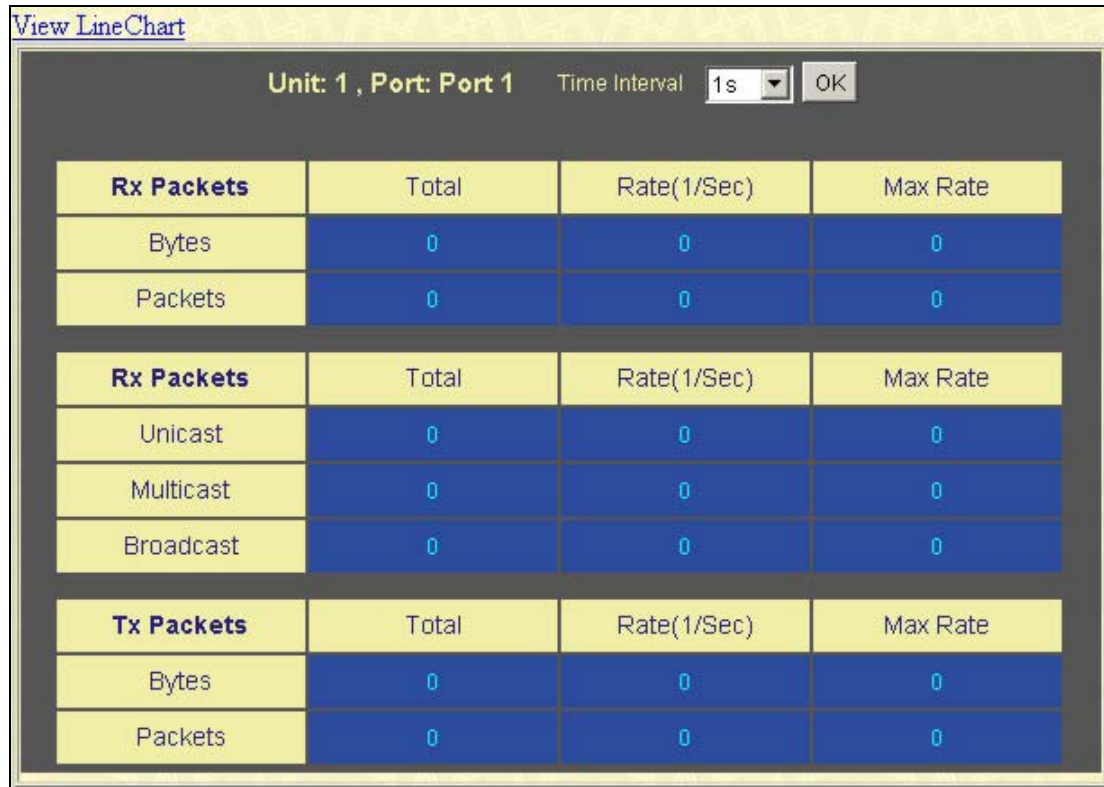

Figure 9- 8. Tx Packets Analysis window (table for Bytes and Packets)

The following fields may be set or viewed:

Parameter	Description
Time Interval [1s]	Select the desired setting between 1s and 60s, where "s" stands for seconds. The default value is one second.
Record Number [200]	Select number of times the Switch will be polled between 20 and 200. The default value is 200.
Bytes	Counts the number of bytes successfully sent from the port.
Packets	Counts the number of packets successfully sent on the port.
Unicast	Counts the total number of good packets that were transmitted by a unicast address.
Multicast	Counts the total number of good packets that were transmitted by a multicast address.
Broadcast	Counts the total number of good packets that were transmitted by a broadcast address.
Show/Hide	Check whether or not to display Bytes and Packets.
Clear	Clicking this button clears all statistics counters on this window.
View Table	Clicking this button instructs the Switch to display a table rather than a line graph.
View Line Chart	Clicking this button instructs the Switch to display a line graph rather than a table.

Errors

The Web Manager allows port error statistics compiled by the Switch's management agent to be viewed as either a line graph or a table. Four windows are offered.

Received (RX)

Click the **Received (RX)** link in the **Error** folder of the **Monitoring** menu to view the following graph of error packets received on the Switch. To select a port to view these statistics for, first select the Switch in the switch stack by using the **Unit** pull-down menu and then select the port by using the **Port** pull down menu. The user may also use the real-time graphic of the Switch and/or switch stack at the top of the web page by simply clicking on a port.

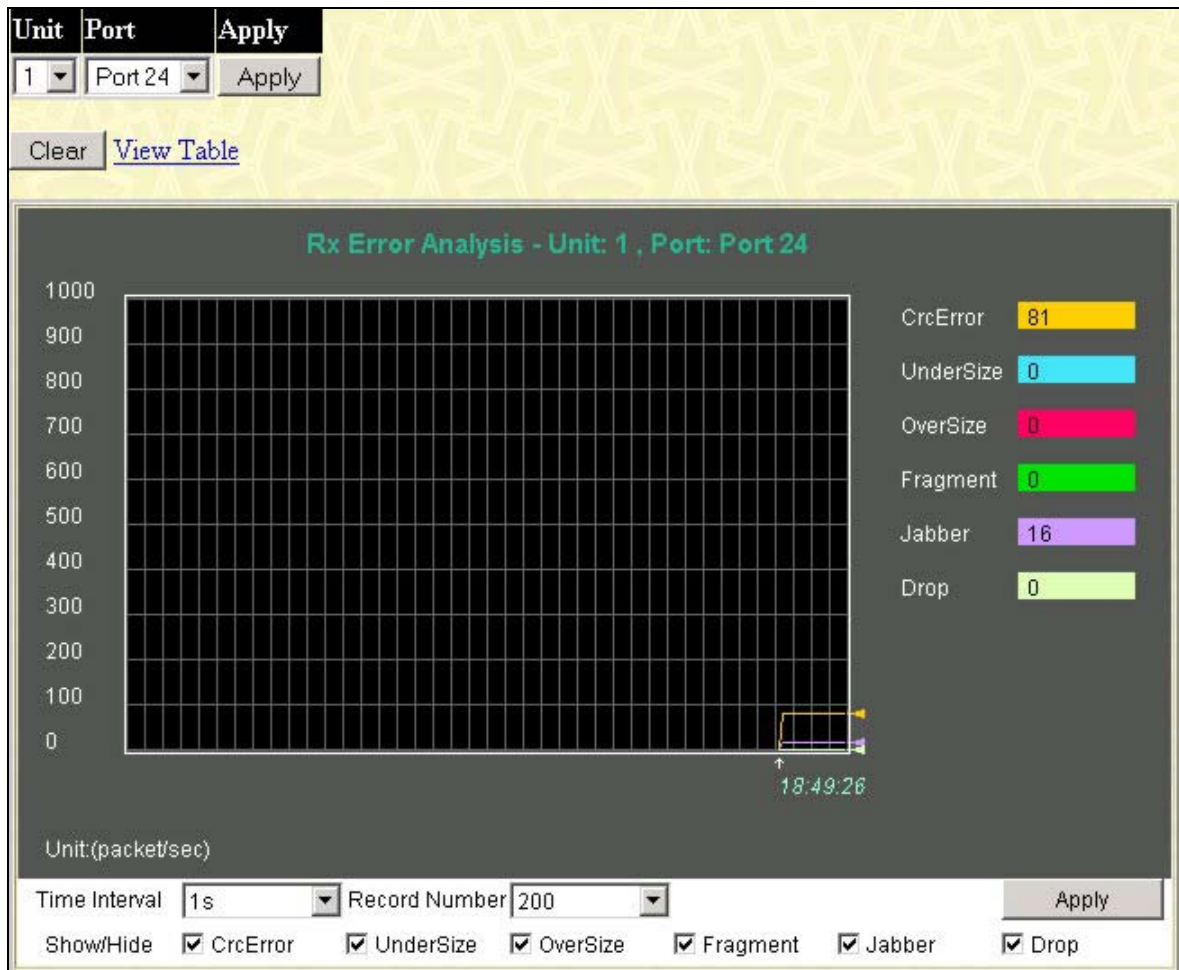

Figure 9- 9. Rx Error Analysis window (line graph)

To view the **Received Error Packets Table**, click the link **View Table**, which will show the following table:

The screenshot shows a window titled "View LineChart" for "Unit: 1, Port: Port 1". The "Time Interval" is set to "1s". Below the window is a table with the following data:

Rx Error	Total	Rate(1/Sec)	Max Rate
CrcError	0	0	0
UnderSize	0	0	0
OverSize	0	0	0
Fragment	0	0	0
Jabber	0	0	0
Drop	0	0	0

Figure 8- 40. Rx Error Analysis window (table)

The following fields can be set:

Parameter	Description
Time Interval [1s]	Select the desired setting between 1s and 60s, where "s" stands for seconds. The default value is one second.
Record Number [200]	Select number of times the Switch will be polled between 20 and 200. The default value is 200.
Crc Error	Counts otherwise valid packets that did not end on a byte (octet) boundary.
UnderSize	The number of packets detected that are less than the minimum permitted packets size of 64 bytes and have a good CRC. Undersize packets usually indicate collision fragments, a normal network occurrence.
OverSize	Counts packets received that were longer than 1518 octets, or if a VLAN frame is 1522 octets, and less than the MAX_PKT_LEN. Internally, MAX_PKT_LEN is equal to 1522.
Fragment	The number of packets less than 64 bytes with either bad framing or an invalid CRC. These are normally the result of collisions.
Jabber	The number of packets with lengths more than the MAX_PKT_LEN bytes. Internally, MAX_PKT_LEN is equal to 1522.
Drop	The number of packets that are dropped by this port since the last Switch reboot.
Show/Hide	Check whether or not to display Crc Error, Under Size, Over Size, Fragment, Jabber, and Drop errors.
Clear	Clicking this button clears all statistics counters on this window.
View Table	Clicking this button instructs the Switch to display a table rather than a line graph.
View Line Chart	Clicking this button instructs the Switch to display a line graph rather than a table.

Transmitted (TX)

Click the Transmitted (TX) link in the Error folder of the Monitoring menu to view the following graph of error packets received on the Switch. To select a port to view these statistics for, first select the Switch in the switch stack by using the **Unit** pull-down menu and then select the port by using the **Port** pull down menu. The user may also use the real-time graphic of the Switch and/or switch stack at the top of the web page by simply clicking on a port.

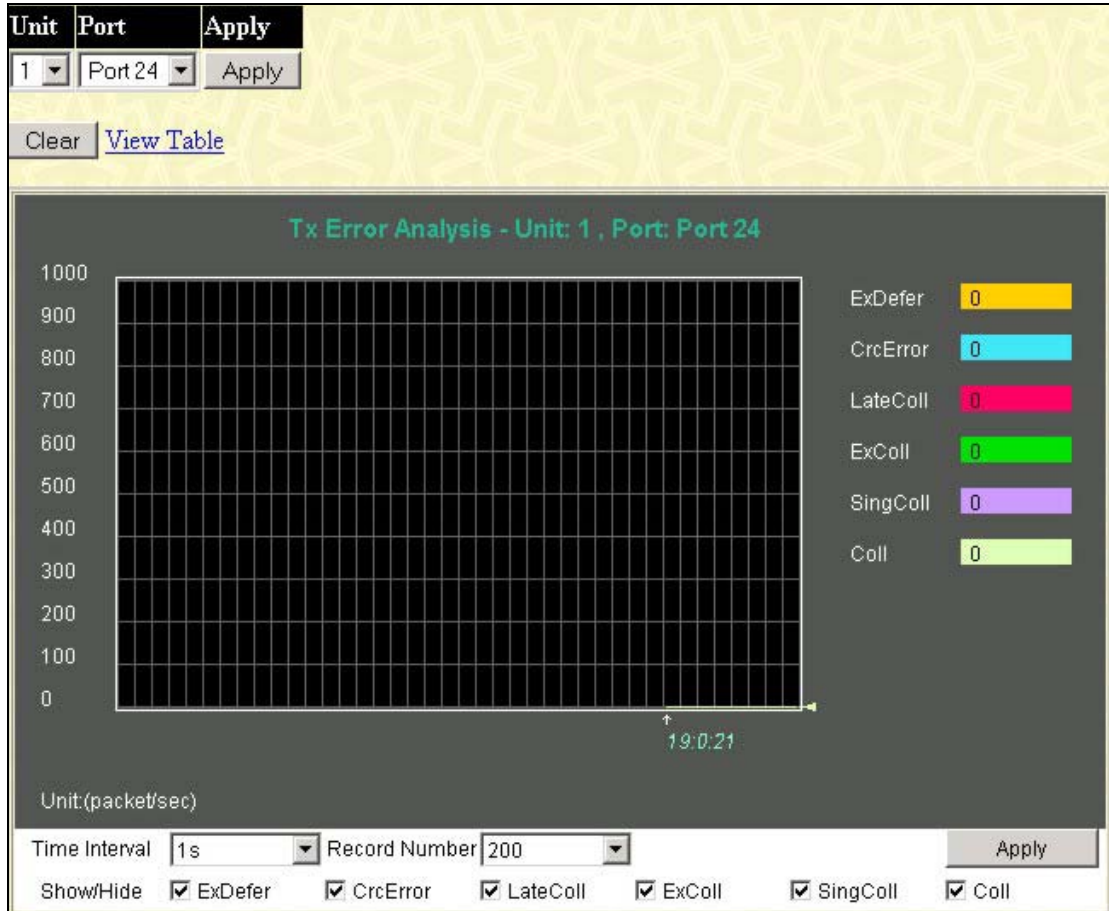

Figure 8- 41. Tx Error Analysis window (line graph)

To view the **Transmitted Error Packets Table**, click the link [View Table](#), which will show the following table:

View LineChart

Unit: 1 , Port: Port 1 Time Interval 1s OK

Tx Error	Total	Rate(1/Sec)	Max Rate
ExDefer	0	0	0
LateColl	0	0	0
ExColl	0	0	0
SingColl	0	0	0
Coll	0	0	0

Figure 8- 42. Tx Error Analysis window (table)

The following fields may be set or viewed:

Parameter	Description
Time Interval [1s]	Select the desired setting between 1s and 60s, where "s" stands for seconds. The default value is one second.
Record Number [200]	Select number of times the Switch will be polled between 20 and 200. The default value is 200.
ExDefer	Counts the number of packets for which the first transmission attempt on a particular interface was delayed because the medium was busy.
CRC Error	Counts otherwise valid packets that did not end on a byte (octet) boundary.
LateColl	Counts the number of times that a collision is detected later than 512 bit-times into the transmission of a packet.
ExColl	Excessive Collisions. The number of packets for which transmission failed due to excessive collisions.
SingColl	Single Collision Frames. The number of successfully transmitted packets for which transmission is inhibited by more than one collision.
Coll	An estimate of the total number of collisions on this network segment.
Show/Hide	Check whether or not to display ExDefer, LateColl, ExColl, SingColl, and Coll errors.
Clear	Clicking this button clears all statistics counters on this window.
View Table	Clicking this button instructs the Switch to display a table rather than a line graph.
View Line Chart	Clicking this button instructs the Switch to display a line graph rather than a table.

Size

The Web Manager allows packets received by the Switch, arranged in six groups and classed by size, to be viewed as either a line graph or a table. Two windows are offered. To select a port to view these statistics for, first select the Switch in the switch stack by using the **Unit** pull-down menu and then select the port by using the **Port** pull down menu. The user may also use the real-time graphic of the Switch and/or switch stack at the top of the web page by simply clicking on a port.

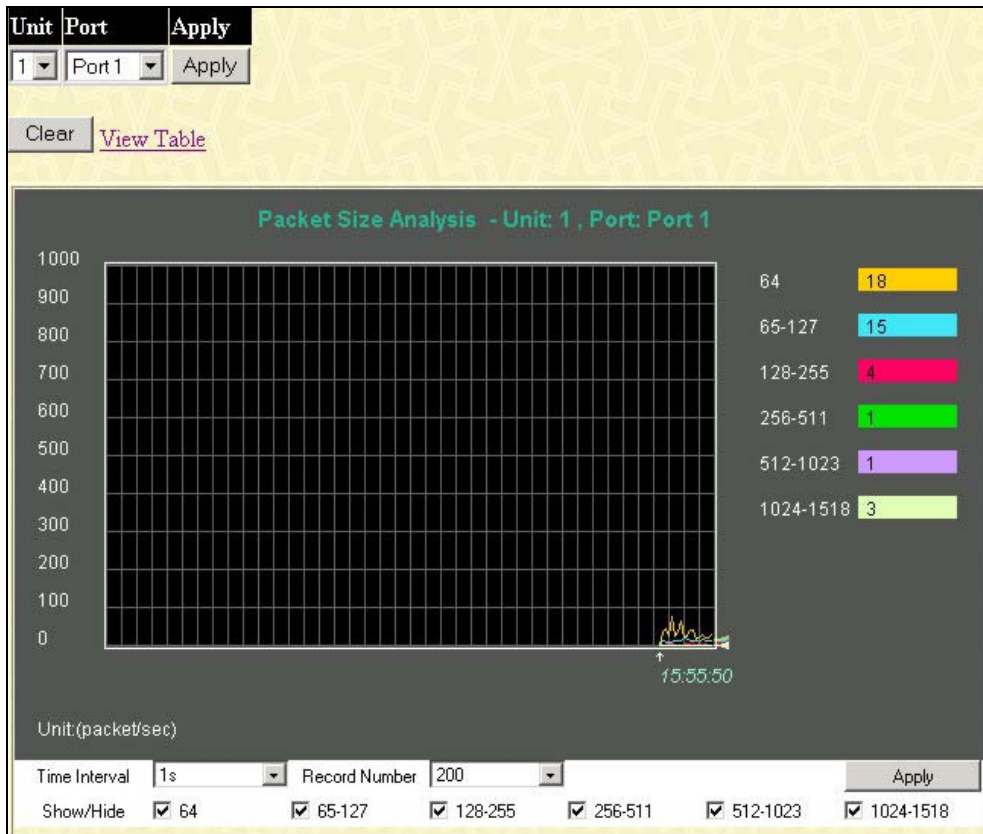

Figure 8- 43. Rx Size Analysis window (line graph)

To view the **Packet Size Analysis Table**, click the link [View Table](#), which will show the following table:

[View Line Chart](#)

Unit: 1 , Port: Port 1 Time Interval: 1s OK

Packet Size	Total	Rate(1/Sec)	Max Rate
64	0	0	0
65-127	0	0	0
128-255	0	0	0
256-511	0	0	0
512-1023	0	0	0
1024-1518	0	0	0

Figure 8- 44. Rx Size Analysis window (table)

The following fields can be set or viewed:

Parameter	Description
Time Interval [1s]	Select the desired setting between 1s and 60s, where "s" stands for seconds. The default value is one second.
Record Number [200]	Select number of times the Switch will be polled between 20 and 200. The default value is 200.
64	The total number of packets (including bad packets) received that were 64 octets in length (excluding framing bits but including FCS octets).
65-127	The total number of packets (including bad packets) received that were between 65 and 127 octets in length inclusive (excluding framing bits but including FCS octets).
128-255	The total number of packets (including bad packets) received that were between 128 and 255 octets in length inclusive (excluding framing bits but including FCS octets).
256-511	The total number of packets (including bad packets) received that were between 256 and 511 octets in length inclusive (excluding framing bits but including FCS octets).
512-1023	The total number of packets (including bad packets) received that were between 512 and 1023 octets in length inclusive (excluding framing bits but including FCS octets).
1024-1518	The total number of packets (including bad packets) received that were between 1024 and 1518 octets in length inclusive (excluding framing bits but including FCS octets).
Show/Hide	Check whether or not to display 64, 65-127, 128-255, 256-511, 512-1023, and 1024-1518 packets received.
Clear	Clicking this button clears all statistics counters on this window.
View Table	Clicking this button instructs the Switch to display a table rather than a line graph.
View Line Chart	Clicking this button instructs the Switch to display a line graph rather than a table.

Stacking Information

The following window displays detailed information about the stacking of the line cards set in the chassis. The DES-6500 may incorporate up to eight hot-swappable line cards for varying port counts of up to one hundred and ninety-two (192) 10/100 Mbps Fast Ethernet ports or up to ninety-two (92) 1000 Mbps Gigabit Ethernet ports.

When the line cards are properly interconnected through their optional Stacking Modules, information about the resulting switch stack is displayed under the **Stack Information** link.

To view the stacking information, click on the **Stacking Information** link from the **Monitoring** folder:

Stacking Information						
Box ID	Type	Exist	Priority	Prom version	Runtime version	H/W version
1	DES6504	exist	16	00170B20	2.00-B15	0A1
2	DES6505	exist	16	00170B20	2.00-B15	0A1
3	DES6508	exist	16	00170B20	2.00-B15	0A1
4	DES6510	exist	16	00170B20	2.00-B15	2A1
5	USR-NOT-CFG	no				
6	USR-NOT-CFG	no				
7	USR-NOT-CFG	no				
8	USR-NOT-CFG	no				
Topology :		STAR				
Current state :		MASTER				
Box count :		4				

Figure 9- 10. Stacking Information window

The **Stacking Information** window holds the following information:

Parameters	Description
Box ID	Displays the slot order in the chassis.
Type	Displays the model name of the corresponding switch in a stack.
Exist	Denotes whether a switch does or does not exist in a stack.
Priority	Displays the priority ID of the line card. The lower the number, the higher the priority. The line card with the lowest priority number in the stack denotes the Master module.
Prom Version	Shows the PROM in use for the Switch. This may be different from the values shown in the illustration.
Runtime Version	Shows the firmware version in use for the line card. This may be different from the values shown in the illustrations.
H/W Version	Shows the hardware version in use for the line card. This may be different from the values shown in the illustration.
Topology	Show the current stacking topology employed using this Switch.
Current State	Displays the current stacking state of the Switch, which may be MASTER or SLAVE.
Box Count	Displays the number of line cards currently in use in the chassis.

Device Status

The **Device Status** window can be found in the **Monitoring** menu by clicking the **Device Status** link. This window shows the status of the physical attributes of the Switch, including power sources and fans.

Device Status				
	Status	Output Voltage	Fan1	Fan2
RPS1	Powered	Normal	Normal	Normal
RPS2	Not Exist	--	--	--
System FAN1 : Normal				
System FAN2 : Normal				
System FAN3 : Normal				
System FAN4 : Normal				

Figure 9- 11. Device Status window

The following fields may be viewed in this window:

Parameter	Description
Redundant Power Supply	Displays the RPS' that may be in use.
Status	A read only field denoting the current status of the internal power supply. <i>Powered</i> will suggest the mechanism is functioning correctly while <i>Not Exist</i> will show the mechanism is not functioning correctly.
Output Voltage	A read only field denoting the current status of the external power supply. <i>Normal</i> will suggest the mechanism is functioning correctly while <i>Fail</i> will show the mechanism is not functioning correctly.
Fan1	A read only field denoting if the Switch's #1 fan is functioning properly.
Fan2	A read only field denoting if the Switch's #2 fan is functioning properly.
System FAN	A read only field describing the operating status of other system fans in use on the Switch.

MAC Address

This allows the Switch's dynamic MAC address forwarding table to be viewed. When the Switch learns an association between a MAC address and a port number, it makes an entry into its forwarding table. These entries are then used to forward packets through the Switch.

To view the MAC Address forwarding table, from the **Monitoring** menu, click the **MAC Address** link:

VLAN Name	<input type="text"/>	Find	Delete		
MAC Address	<input type="text" value="00-00-00-00-00-00"/>	Find			
Unit - Port	<input type="text" value="1"/> <input type="text" value="Port 1"/>	Find	Delete		
		View All Entry	Delete All Entry		
MAC Address Table					
VID	Vlan Name	MAC Address	Unit	Port	Type
1	default	00-00-01-02-03-a2	3	1	Dynamic
1	default	00-00-50-77-16-00	3	1	Dynamic
1	default	00-00-5e-00-01-5f	3	1	Dynamic
1	default	00-00-81-17-11-00	3	1	Dynamic
1	default	00-00-e2-93-66-06	3	1	Dynamic
1	default	00-01-06-30-10-63	3	1	Dynamic
1	default	00-01-30-12-13-02	3	1	Dynamic
1	default	00-02-a5-fd-66-97	3	1	Dynamic
1	default	00-03-09-18-10-01	3	1	Dynamic
1	default	00-03-44-ae-bc-12	3	1	Dynamic
1	default	00-03-47-91-4a-1c	3	1	Dynamic
1	default	00-03-47-93-11-34	3	1	Dynamic
1	default	00-03-6d-1e-76-79	3	1	Dynamic
1	default	00-05-5d-30-c1-11	3	1	Dynamic
1	default	00-05-5d-64-96-97	3	1	Dynamic
1	default	00-05-5d-6a-a5-36	3	1	Dynamic
1	default	00-05-5d-7e-80-fa	3	1	Dynamic
1	default	00-05-5d-7e-91-c0	3	1	Dynamic
1	default	00-05-5d-84-6f-74	3	1	Dynamic
1	default	00-05-5d-9a-fe-5d	3	1	Dynamic
Total Entries: 225					Next

Figure 9- 12. MAC Address Table

The following fields can be viewed or set:

Parameter	Description
VLAN Name	Enter a VLAN Name for the forwarding table to be browsed by.
MAC Address	Enter a MAC address for the forwarding table to be browsed by.

Unit – Port	Select the switch Unit ID of the switch in the Switch stack and then the port by using the corresponding pull-down menus.
Find	Allows the user to move to a sector of the database corresponding to a user defined port, VLAN, or MAC address.
VID	The VLAN ID of the VLAN of which the port is a member.
VLAN Name	The VLAN Name of the VLAN of which the port is a member.
MAC Address	The MAC address entered into the address table.
Unit	Refers to the Unit of the switch stack from which the MAC address was learned.
Port	The port to which the MAC address above corresponds.
Type	Describes the method which the Switch discovered the MAC address. The possible entries are Dynamic, Self, and Static.
Next	Click this button to view the next page of the address table.
View All Entry	Clicking this button will allow the user to view all entries of the address table.
Delete All Entry	Clicking this button will allow the user to delete all entries of the address table.

Switch History Log

The Web manager allows the Switch's history log, as compiled by the Switch's management agent, to be viewed. To view the Switch history log, open the **Maintenance** folder and click the **Switch History Log** link.

Switch History Log		
Sequence	Time	Log Text
159	2005-04-20, 15:07:42	Successful login through Web (Username: Anonymous)
158	2005-04-20, 14:55:40	Port 3:1 link up, 100Mbps FULL duplex
157	2005-04-20, 14:55:40	Port 2:8 link down
156	2005-04-20, 14:55:40	Port 2:7 link down
155	2005-04-20, 14:55:40	Port 2:6 link down
154	2005-04-20, 14:55:39	Port 2:5 link down
153	2005-04-20, 14:55:39	Port 2:4 link down
152	2005-04-20, 14:55:39	Port 2:3 link down
151	2005-04-20, 14:55:39	Port 2:2 link down
150	2005-04-20, 14:55:39	Port 2:1 link down
149	2005-04-20, 14:55:39	Unit 9, Console session timed out (Username: Anonymous)
148	2005-04-20, 14:55:39	Unit 9, System started up
147	2005-04-15, 15:58:53	Successful login through Web (Username: admin)
146	2005-04-15, 15:58:52	Unit 9, Configuration saved to flash (Username: Darren)
145	2005-04-15, 15:58:27	Unit 9, Successful login through Console (Username: Darren)
144	2005-04-15, 15:58:15	Unit 9, Login failed through Console (Username: Anonymous)
143	2005-04-15, 15:45:27	Unit 9, Console session timed out (Username: Anonymous)
142	2005-04-15, 14:32:29	Unit 9, Configuration saved to flash (Username: Anonymous)
141	2005-04-15, 14:02:25	Unit 9, Successful login through Console (Username: Anonymous)
140	2005-04-15, 14:01:58	Unit 9, Console session timed out (Username: Anonymous)
Clear		Next

Figure 9- 13. Switch History Log window

The Switch can record event information in its own logs, to designated SNMP trap receiving stations, and to the PC connected to the console manager. Click **Next** to go to the next page of the **Switch History Log**. Clicking **Clear** will allow the user to clear the **Switch History Log**.

The information is described as follows:

Parameter	Description
Sequence	A counter incremented whenever an entry to the Switch's history log is made. The table displays the last entry (highest sequence number) first.
Time	Displays the time in days, hours, and minutes since the Switch was last restarted.
Log Text	Displays text describing the event that triggered the history log entry.

IGMP Snooping Group

This window allows the Switch's **IGMP Snooping Group Table** to be viewed. IGMP Snooping allows the Switch to read the Multicast Group IP address and the corresponding MAC address from IGMP packets that pass through the Switch. The number of IGMP reports that were snooped is displayed in the **Reports** field.

To view the **IGMP Snooping Group Table**, click **IGMP Snooping Group** on the **Monitoring** menu:

VLAN ID		Multicast Group		MAC Address		Reports																		
0		0.0.0.0		00:00:00:00:00:00		0																		
Unit	Port Map																							
	1	2	3	4	5	6	7	8	9	10	11	12	13	14	15	16	17	18	19	20	21	22	23	24
1																								
2																								
3																								
4																								
5																								
6																								
7																								
8																								

Figure 9- 14. IGMP Snooping Group Table

The user may search the **IGMP Snooping Group Table** by VID by entering it in the top left hand corner and clicking **Search**.

The following field can be viewed:

Parameter	Description
VLAN ID	The VLAN ID of the multicast group.
Multicast Group	The IP address of the multicast group.
MAC Address	The MAC address of the multicast group.
Reports	The total number of reports received for this group.
Port Map	These are the ports where the IGMP packets were snooped are displayed.



NOTE: To configure IGMP snooping for the DES-6500 switch, go to the **Configuration** folder and select **IGMP Snooping**. Configuration and other information concerning IGMP snooping may be found in Section 6 of this manual under **IGMP Snooping**.

IGMP Snooping Forwarding

This window will display the current IGMP snooping forwarding table entries currently configured on the Switch. To view the following screen, open the **Monitoring** folder and click the **IGMP Snooping Forwarding** link.

VLAN Name		Source IP	Multicast Group																					
		0.0.0.0	0.0.0.0																					
Unit	Port Map																							
	1	2	3	4	5	6	7	8	9	10	11	12	13	14	15	16	17	18	19	20	21	22	23	24
1																								
2																								
3																								
4																								
5																								
6																								
7																								
8																								

Figure 9- 15. IGMP Snooping Forwarding Table

The user may search the **IGMP Snooping Forwarding Table** by VLAN Name using the top left hand corner **Search**.

The following field can be viewed:

Parameter	Description
VLAN Name	The VLAN Name of the multicast group.
Source IP	The Source IP address of the multicast group.
Multicast Group	The IP address of the multicast group.
Port Map	These are the ports to which the IP multicast packets are being forwarded.

Browse Router Port

This displays which of the Switch's ports are currently configured as router ports. A router port configured by a user (using the console or Web-based management interfaces) is displayed as a static router port, designated by **S**. A router port that is dynamically configured by the Switch is designated by **D** and a Forbidden port is designated by **F**.

Total Entries : 1																									
Browse Router Port																									
VLAN ID													VLAN Name												
1													default												
Unit	Ports																								
	1	2	3	4	5	6	7	8	9	10	11	12	13	14	15	16	17	18	19	20	21	22	23	24	
1																									
2																									
3																									
4																									
5																									
6																									
7																									
8																									

S : Static
D : Dynamic
F : Fobidden

Figure 9- 16. Browse Router Port window

Port Access Control

The following screens are used to monitor 802.1x statistics of the Switch, on a per port basis. To view the **Port Access Control** screens, open the monitoring folder and click the **Port Access Control** folder. There are six screens to monitor.



NOTE: The **Authenticator State**, **Authenticator Statistics**, **Authenticator Session Statistics** and **Authenticator Diagnostics** windows in this section cannot be viewed on the DES-6500 switch unless 802.1x is enabled by port or by MAC address. To enable 802.1x, go to the Port Access Entity folder in the configuration folder and select the heading **802.1X Auth Mode Settings**.

Authenticator State

The following section describes the 802.1X Status on the Switch. To view the Authenticator State, click **Monitoring > Port Access Control > Authenticator State**.

The screenshot shows the 'Authenticator State of Unit 1' window. At the top, there is a 'Unit' dropdown set to '1' and an 'Apply' button. Below this, the window title is 'Authenticator State of Unit 1' and there is a 'Time Interval' dropdown set to '1s' with an 'OK' button. The main content is a table with four columns: 'Port', 'Auth_PAE_State', 'Backend_State', and 'PortStatus'. The table lists 12 ports, all showing 'ForceAuth' for the PAE state, 'Success' for the Backend state, and 'Authorized' for the PortStatus.

Port	Auth_PAE_State	Backend_State	PortStatus
1	ForceAuth	Success	Authorized
2	ForceAuth	Success	Authorized
3	ForceAuth	Success	Authorized
4	ForceAuth	Success	Authorized
5	ForceAuth	Success	Authorized
6	ForceAuth	Success	Authorized
7	ForceAuth	Success	Authorized
8	ForceAuth	Success	Authorized
9	ForceAuth	Success	Authorized
10	ForceAuth	Success	Authorized
11	ForceAuth	Success	Authorized
12	ForceAuth	Success	Authorized

Figure 9- 17. Authenticator State window – Port-based 802.1x

Unit	Port	Apply
1	Port1	Apply

Authenticator State of Unit 1 Port 1 of Unit 1				Time Interval	OK
Index	Mac Address	Auth PAE State	Backend State	Port Status	
1	N/A	N/A	N/A	N/A	
2	N/A	N/A	N/A	N/A	
3	N/A	N/A	N/A	N/A	
4	N/A	N/A	N/A	N/A	
5	N/A	N/A	N/A	N/A	
6	N/A	N/A	N/A	N/A	
7	N/A	N/A	N/A	N/A	
8	N/A	N/A	N/A	N/A	
9	N/A	N/A	N/A	N/A	
10	N/A	N/A	N/A	N/A	
11	N/A	N/A	N/A	N/A	
12	N/A	N/A	N/A	N/A	
13	N/A	N/A	N/A	N/A	
14	N/A	N/A	N/A	N/A	
15	N/A	N/A	N/A	N/A	
16	N/A	N/A	N/A	N/A	

Figure 9- 18. Authenticator State window – MAC-Based 802.1x

This window displays the **Authenticator State** for individual ports on a selected device. To select unit within the switch stack, use the pull-down menu at the top of the window and click **Apply**. A polling interval between *1* and *60* seconds can be set using the drop-down menu at the top of the window and clicking **OK**.

The information on this window is described as follows:

Parameter	Description
Auth PAE State	The Authenticator PAE State value can be: <i>Initialize, Disconnected, Connecting, Authenticating, Authenticated, Aborting, Held, Force_Auth, Force_Unauth</i> , or <i>N/A</i> . <i>N/A</i> (Not Available) indicates that the port's authenticator capability is disabled.
Backend State	The Backend Authentication State can be <i>Request, Response, Success, Fail, Timeout, Idle, Initialize</i> , or <i>N/A</i> . <i>N/A</i> (Not Available) indicates that the port's authenticator capability is disabled.
Port Status	Controlled Port Status can be <i>Authorized, Unauthorized</i> , or <i>N/A</i> .

Authenticator Diagnostics

This table contains the diagnostic information regarding the operation of the Authenticator associated with each port. The user may choose the line card and port to view these statistics for by using the pull-down menus in the top left and corner. This window is identical for both MAC-based and port-based 802.1X, except for the inclusion of the MAC address for MAC-based. To view the **Authenticator Diagnostics**, click **Monitoring > Port Access Control > Authenticator Diagnostics**.

Item	Value
MAC address	-
EntersConnecting	-
EapLogoffsWhileConnecting	-
EntersAuthenticating	-
SuccessWhileAuthenticating	-
TimeoutsWhileAuthenticating	-
FailWhileAuthenticating	-
ReauthsWhileAuthenticated	-
EapStartsWhileAuthenticated	-
EapLogoffWhileAuthenticated	-
BackendResponses	-
BackendAccessChallenges	-
BackendOtherRequestsToSupplicant	-
BackendNonNakResponsesFromSupplicant	-
BackendAuthSuccesses	-
BackendAuthFails	-

Figure 9- 19. Authenticator Diagnostics window

The user can specify a switch in a switch stack using that switch's **Unit** ID by using the pull down menu in the top left hand corner. The user may also select the desired time interval to update the statistics, between *1s* and *60s*, where "s" stands for seconds. The default value is one second.

The following fields can be viewed:

Parameter	Description
MAC address	The identification number assigned to the Port by the System in which the Port resides.
EnterConnecting	Counts the number of times that the state machine transitions to the CONNECTING state from any other state.
EapLogoffsWhile Connecting	Counts the number of times that the state machine transitions from CONNECTING to DISCONNECTED as a result of receiving an EAPOL-Logoff message.

EntersAuthenticating	Counts the number of times that the state machine transitions from CONNECTING to AUTHENTICATING, as a result of an EAP-Response/Identity message being received from the Supplicant.
SuccessWhileAuthenticating	Counts the number of times that the state machine transitions from AUTHENTICATING to AUTHENTICATED, as a result of the Backend Authentication state machine indicating successful authentication of the Supplicant (authSuccess = TRUE).
TimeoutsWhileAuthenticating	Counts the number of times that the state machine transitions from AUTHENTICATING to ABORTING, as a result of the Backend Authentication state machine indicating authentication timeout (authTimeout = TRUE).
FailWhileAuthenticating	Counts the number of times that the state machine transitions from AUTHENTICATING to HELD, as a result of the Backend Authentication state machine indicating authentication failure (authFail = TRUE).
ReauthsWhileAuthenticating	Counts the number of times that the state machine transitions from AUTHENTICATING to ABORTING, as a result of a reauthentication request (reAuthenticate = TRUE).
EapStartsWhileAuthenticating	Counts the number of times that the state machine transitions from AUTHENTICATING to ABORTING, as a result of an EAPOL-Start message being received from the Supplicant.
EapLogoffWhileAuthenticating	Counts the number of times that the state machine transitions from AUTHENTICATING to ABORTING, as a result of an EAPOL-Logoff message being received from the Supplicant.
ReauthsWhileAuthenticated	Counts the number of times that the state machine transitions from AUTHENTICATED to CONNECTING, as a result of a reauthentication request (reAuthenticate = TRUE).
EapStartsWhileAuthenticated	Counts the number of times that the state machine transitions from AUTHENTICATED to CONNECTING, as a result of an EAPOL-Start message being received from the Supplicant.
EapLogoffWhileAuthenticated	Counts the number of times that the state machine transitions from AUTHENTICATED to DISCONNECTED, as a result of an EAPOL-Logoff message being received from the Supplicant.
BackendResponses	Counts the number of times that the state machine sends an initial Access-Request packet to the Authentication server (i.e., executes sendRespToServer on entry to the RESPONSE state). Indicates that the Authenticator attempted communication with the Authentication Server.
BackendAccessChallenges	Counts the number of times that the state machine receives an initial Access-Challenge packet from the Authentication server (i.e., aReq becomes TRUE, causing exit from the RESPONSE state). Indicates that the Authentication Server has communication with the Authenticator.

BackendOtherRequestsToSupplicant	Counts the number of times that the state machine sends an EAP-Request packet (other than an Identity, Notification, Failure, or Success message) to the Supplicant (i.e., executes txReq on entry to the REQUEST state). Indicates that the Authenticator chose an EAP-method.
BackendNonNakResponsesFromSupplicant	Counts the number of times that the state machine receives a response from the Supplicant to an initial EAP-Request, and the response is something other than EAP-NAK (i.e., rxResp becomes TRUE, causing the state machine to transition from REQUEST to RESPONSE, and the response is not an EAP-NAK). Indicates that the Supplicant can respond to the Authenticator's chosen EAP-method.
BackendAuthSuccesses	Counts the number of times that the state machine receives an Accept message from the Authentication Server (i.e., a Success becomes TRUE, causing a transition from RESPONSE to SUCCESS). Indicates that the Supplicant has successfully authenticated to the Authentication Server.
BackendAuthFails	Counts the number of times that the state machine receives a Reject message from the Authentication Server (i.e., aFail becomes TRUE, causing a transition from RESPONSE to FAIL). Indicates that the Supplicant has not authenticated to the Authentication Server.

Authenticator Session Statistics

This table contains the session statistics objects for the Authenticator PAE associated with each port. To view the **Authenticator Session Statistics**, click **Monitoring > Port Access Control > Authenticator Session Statistics**.

Item	Value
SessionOctetsRx	0
SessionOctetsTx	0
SessionFramesRx	0
SessionFramesTx	0
SessionId	
SessionAuthenticMethod	Remote Authentication Server
SessionTime	0
SessionTerminateCause	SupplicantLogoff
SessionUserName	

Figure 9- 20. Authenticator Session Statistics window

The user can specify a switch in a switch stack using that switch's Unit ID by using the pull down menu in the top left hand corner. The user may also select the desired time interval to update the statistics, between 1s and 60s, where "s" stands for seconds. The default value is one second.

The following fields can be viewed:

Parameter	Description
SessionOctetsRx	The number of octets received in user data frames on this port during the session.
SessionOctetsTx	The number of octets transmitted in user data frames on this port during the session.

SessionFramesRx	The number of user data frames received on this port during the session.
SessionFramesTx	The number of user data frames transmitted on this port during the session.
SessionID	A unique identifier for the session, in the form of a printable ASCII string of at least three characters.
SessionAuthenticMethod	<p>The authentication method used to establish the session. Valid Authentic Methods include:</p> <p>(1) Remote Authentic Server - The Authentication Server is external to the Authenticator's System.</p> <p>(2) Local Authentic Server - The Authentication Server is located within the Authenticator's System.</p>
SessionTime	The duration of the session in seconds.
SessionTerminateCause	<p>The reason for the session termination. There are eight possible reasons for termination.</p> <ol style="list-style-type: none"> 1) Supplicant Logoff 2) Port Failure 3) Supplicant Restart 4) Reauthentication Failure 5) AuthControlledPortControl set to ForceUnauthorized 6) Port re-initialization 7) Port Administratively Disabled 8) Not Terminated Yet
SessionUserName	The User-Name representing the identity of the Supplicant PAE.

Authenticator Statistics

This table contains the statistics objects for the Authenticator PAE associated with each port. An entry appears in this table for each port that supports the Authenticator function. To view the Authenticator Statistics, click **Monitoring > Port Access Control > Authenticator Statistics**.

Item	Value
EapolFramesRx	0
EapolFramesTx	0
EapolStartFramesRx	0
EapolReqIdFramesTx	0
EapolLogoffFramesRx	0
EapolReqFramesTx	0
EapolRespIdFramesRx	0
EapolRespFramesRx	0
InvalidEapolFramesRx	0
EapLengthErrorFramesRx	0
LastEapolFrameVersion	0
LastEapolFrameSource	00-00-00-00-00-00

Figure 9- 21. Authenticator Statistics window

The user can specify a switch in a switch stack using that switch's Unit ID by using the pull down menu in the top left hand corner. The user may also select the desired time interval to update the statistics, between *1s* and *60s*, where "s" stands for seconds. The default value is one second.

The following fields can be viewed:

Parameter	Description
EapolFramesRx	The number of valid EAPOL frames that have been received by this Authenticator.
EapolFramesTx	The number of EAPOL frames that have been transmitted by this Authenticator.

EapolStartFramesRx	The number of EAPOL Start frames that have been received by this Authenticator.
EapolReqIdFramesTx	The number of EAP Req/Id frames that have been transmitted by this Authenticator.
EapolLogoffFramesRx	The number of EAPOL Logoff frames that have been received by this Authenticator.
EapolReqFramesTx	The number of EAP Request frames (other than Rq/Id frames) that have been transmitted by this Authenticator.
EapolRespIdFramesRx	The number of EAP Resp/Id frames that have been received by this Authenticator.
EapolRespFramesRx	The number of valid EAP Response frames (other than Resp/Id frames) that have been received by this Authenticator.
InvalidEapolFramesRx	The number of EAPOL frames that have been received by this Authenticator in which the frame type is not recognized.
EapLengthErrorFramesRx	The number of EAPOL frames that have been received by this Authenticator in which the Packet Body Length field is invalid.
LastEapolFrameVersion	The protocol version number carried in the most recently received EAPOL frame.
LastEapolFrameSource	The source MAC address carried in the most recently received EAPOL frame.

RADIUS Accounting

This window shows managed objects used for managing RADIUS accounting clients, and the current statistics associated with them. To view the **RADIUS Accounting**, click **Monitoring > Port Access Control > RADIUS Accounting**.

The screenshot shows a window titled "View Radius Account Client" with a "Server Index" dropdown set to "1" and an "Apply" button. A "Time Interval" dropdown is set to "1s" with an "OK" button. The main content is a table with two columns: "Item" and "Value".

Item	Value
radiusAcctClientInvalidServerAddresses	0
radiusAcctClientIdentifier	D-Link
radiusAccServerIndex	0
radiusAccServerAddress	0.0.0.0
radiusAccClientServerPortNumber	0
radiusAccClientRoundTripTime	0
radiusAccClientRequests	0
radiusAccClientRetransmissions	0
radiusAccClientResponses	0
radiusAccClientMalformedResponses	0
radiusAccClientBadAuthenticators	0
radiusAccClientPendingRequests	0
radiusAccClientTimeouts	0
radiusAccClientUnknownTypes	0
radiusAccClientPacketsDropped	0

Figure 9- 22. RADIUS Accounting window

The user may also select the desired time interval to update the statistics, between *1s* and *60s*, where “s” stands for seconds. The default value is one second. To clear the current statistics shown, click the *Clear* button in the top left hand corner.

The following fields can be viewed:

Parameter	Description
ClientInvalidServerAddresses	The number of RADIUS Accounting-Response packets received from unknown addresses.
ClientIdentifier	The NAS-Identifier of the RADIUS accounting client. (This is not necessarily the same as sysName in MIB II.)

ServerIndex	The identification number assigned to each RADIUS Accounting server that the client shares a secret with.
ServerAddress	The (conceptual) table listing the RADIUS accounting servers with which the client shares a secret.
ServerPortNumber	The UDP port the client is using to send requests to this server.
ClientRoundTripTime	The time interval between the most recent Accounting-Response and the Accounting-Request that matched it from this RADIUS accounting server.
ClientRequests	The number of RADIUS Accounting-Request packets sent. This does not include retransmissions.
ClientRetransmissions	The number of RADIUS Accounting-Request packets retransmitted to this RADIUS accounting server. Retransmissions include retries where the Identifier and Acct-Delay have been updated, as well as those in which they remain the same.
ClientResponses	The number of RADIUS packets received on the accounting port from this server.
ClientMalformedResponses	The number of malformed RADIUS Accounting-Response packets received from this server. Malformed packets include packets with an invalid length. Bad authenticators and unknown types are not included as malformed accounting responses.
ClientBadAuthenticators	The number of RADIUS Accounting-Response packets, which contained invalid authenticators, received from this server.
ClientPendingRequests	The number of RADIUS Accounting-Request packets sent to this server that have not yet timed out or received a response. This variable is incremented when an Accounting-Request is sent and decremented due to receipt of an Accounting-Response, a timeout or a retransmission.
ClientTimeouts	The number of accounting timeouts to this server. After a timeout the client may retry to the same server, send to a different server, or give up. A retry to the same server is counted as a retransmit as well as a timeout. A send to a different server is counted as an Accounting-Request as well as a timeout.
ClientUnknownTypes	The number of RADIUS packets of unknown type which were received from this server on the accounting port.
ClientPacketsDropped	The number of RADIUS packets, which were received from this server on the accounting port and dropped for some other reason.



Note: To configure 802.1x features for the DES-6500, go to the **Configuration** folder and select **Port Access Entity**. Configuration and other information concerning 802.1x may be found in Section 6 of this manual under **Port Access Entity**.

RADIUS Authentication

This table contains information concerning the activity of the RADIUS authentication client on the client side of the RADIUS authentication protocol. To view the **RADIUS Authentication**, click **Monitoring > Port Access Control > RADIUS Authentication**.

The screenshot shows a window titled "View Radius Auth Client" with a "Time Interval" dropdown set to "1s" and an "OK" button. At the top left, there is a "Server Index" dropdown set to "1" and an "Apply" button. The main content is a table with two columns: "Item" and "Value".

Item	Value
radiusAuthClientInvalidServerAddresses	0
radiusAuthClientIdentifier	D-Link
radiusAuthServerIndex	0
radiusAuthServerAddress	0.0.0.0
radiusAuthClientServerPortNumber	0
radiusAuthClientRoundTripTime	0
radiusAuthClientAccessRequests	0
radiusAuthClientAccessRetransmissions	0
radiusAuthClientAccessAccepts	0
radiusAuthClientAccessRejects	0
radiusAuthClientAccessChallenges	0
radiusAuthClientMalformedAccessResponses	0
radiusAuthClientBadAuthenticators	0
radiusAuthClientPendingRequests	0
radiusAuthClientTimeouts	0
radiusAuthClientUnknownTypes	0
radiusAuthClientPacketsDropped	0

Figure 9- 23. RADIUS Authentication window

The user may also select the desired time interval to update the statistics, between *1s* and *60s*, where “s” stands for seconds. The default value is one second. To clear the current statistics shown, click the *Clear* button in the top left hand corner.

The following fields can be viewed:

Parameter	Description
ClientInvalidServerAddresses	The number of RADIUS Access-Response packets received from unknown addresses.

ClientIdentifier	The NAS-Identifier of the RADIUS authentication client. (This is not necessarily the same as sysName in MIB II.)
ServerIndex	The identification number assigned to each RADIUS Authentication server that the client shares a secret with.
AuthServerAddress	The (conceptual) table listing the RADIUS authentication servers with which the client shares a secret.
ClientServerPortNumber	The UDP port the client is using to send requests to this server.
ClientRoundTripTime	The time interval (in hundredths of a second) between the most recent Access-Reply/Access-Challenge and the Access-Request that matched it from this RADIUS authentication server.
ClientAccessRequests	The number of RADIUS Access-Request packets sent to this server. This does not include retransmissions.
ClientAccessRetransmissions	The number of RADIUS Access-Request packets retransmitted to this RADIUS authentication server.
ClientAccessAccepts	The number of RADIUS Access-Accept packets (valid or invalid) received from this server.
ClientAccessRejects	The number of RADIUS Access-Reject packets (valid or invalid) received from this server.
ClientAccessChallenges	The number of RADIUS Access-Challenge packets (valid or invalid) received from this server.
ClientAccessResponses	The number of malformed RADIUS Access-Response packets received from this server. Malformed packets include packets with an invalid length. Bad authenticators or Signature attributes or known types are not included as malformed access responses.
ClientBadAuthenticators	The number of RADIUS Access-Response packets containing invalid authenticators or Signature attributes received from this server.
ClientPendingRequests	The number of RADIUS Access-Request packets destined for this server that have not yet timed out or received a response. This variable is incremented when an Access-Request is sent and decremented due to receipt of an Access-Accept, Access-Reject or Access-Challenge, a timeout or retransmission.
ClientTimeouts	The number of authentication timeouts to this server. After a timeout the client may retry to the same server, send to a different server, or give up. A retry to the same server is counted as a retransmit as well as a timeout. A send to a different server is counted as a Request as well as a timeout.
ClientUnknownTypes	The number of RADIUS packets of unknown type which were received from this server on the authentication port
ClientPacketsDropped	The number of RADIUS packets of which were received from this server on the authentication port and dropped for some other reason.

Layer 3 Feature

This folder in the **Monitoring** section will display information concerning settings configured in **Layer 3 IP Networking** of the **Configuration** folder. These settings and parameters have been previously described in **Section 6** of this manual, under **Layer 3 IP Networking**.

Browse IP Address Table

The **Browse IP Address Table** may be found in the **Monitoring** menu in the **Layer 3 Feature** folder. The **Browse IP Address Table** is a read only screen where the user may view IP addresses discovered by the Switch. To search a specific IP address, enter it into the field labeled **IP Address** at the top of the screen and click **Find** to begin your search.

IP Address		<input type="text" value="0.0.0.0"/>	<input type="button" value="Find"/>
IP Address Table			
Interface	IP Address	Port	Learned
System	10.0.25.1	3:1	Dynamic
System	10.0.58.4	3:1	Dynamic
System	10.1.1.101	3:1	Dynamic
System	10.1.1.102	3:1	Dynamic
System	10.1.1.103	3:1	Dynamic
System	10.1.1.151	3:1	Dynamic
System	10.1.1.152	3:1	Dynamic
System	10.1.1.157	3:1	Dynamic
System	10.1.1.161	3:1	Dynamic
System	10.1.1.162	3:1	Dynamic
System	10.1.1.163	3:1	Dynamic
System	10.1.1.164	3:1	Dynamic
System	10.1.1.166	3:1	Dynamic
System	10.1.1.168	3:1	Dynamic
System	10.1.1.169	3:1	Dynamic
System	10.1.1.170	3:1	Dynamic
System	10.1.1.171	3:1	Dynamic
System	10.1.1.172	3:1	Dynamic
System	10.1.1.173	3:1	Dynamic
System	10.1.1.174	3:1	Dynamic
Total Entries: 317			<input type="button" value="Next"/>

Figure 9- 24. IP Address Table

Browse Routing Table

The **Browse Routing Table** window may be found in the **Monitoring** menu in the **Layer 3 Feature** folder. This screen shows the current IP routing table of the Switch. To find a specific IP route, enter an IP address into the **Destination Address** field along with a proper subnet mask into the **Mask** field and click **Find**.

Destination Address	<input type="text" value="0.0.0.0"/>				
Mask	<input type="text" value="0.0.0.0"/>	<input type="button" value="Find"/>			
Routing Table					
IP Address	Netmask	Gateway	Interface	Cost	Protocol
10.0.0.0	255.0.0.0	0.0.0.0	System	1	Local
Total Entries: 1					

Figure 9- 25. Browse Routing Table window

Browse ARP Table

The **Browse ARP Table** window may be found in the **Monitoring** menu in the **Layer 3 Feature** folder. This window will show current ARP entries on the Switch. To search a specific ARP entry, enter an interface name into the **Interface Name** or an **IP address** and click **Find**. To clear the **ARP Table**, click **Clear All**.

Interface Name	<input type="text"/>		
IP Address	<input type="text" value="0.0.0.0"/>	<input type="button" value="Find"/> <input type="button" value="Clear All"/>	
ARP Table			
Interface Name	IP Address	MAC Address	Type
System	10.0.0.0	ff-ff-ff-ff-ff-ff	Local/Broadcast
System	10.0.0.107	00-80-c8-34-56-79	Dynamic
System	10.0.46.1	00-80-c8-91-15-eb	Dynamic
System	10.0.51.12	00-50-ba-da-00-1d	Dynamic
System	10.1.1.2	00-05-5d-19-a5-ab	Static
System	10.1.1.101	00-50-ba-15-48-56	Dynamic
System	10.1.1.102	00-50-ba-97-d7-c0	Dynamic
System	10.1.1.151	00-50-ba-70-d6-d0	Dynamic
System	10.1.1.152	00-13-00-00-00-01	Dynamic
System	10.1.1.154	00-50-ba-97-d9-56	Dynamic
System	10.1.1.157	00-50-ba-71-20-d6	Dynamic
System	10.1.1.161	00-50-ba-70-e4-89	Dynamic
System	10.1.1.166	00-50-ba-70-e4-58	Dynamic
System	10.1.1.167	00-50-ba-70-e4-45	Dynamic
System	10.1.1.168	00-50-ba-70-e4-57	Dynamic
System	10.1.1.169	00-50-ba-70-e4-4e	Dynamic
System	10.1.1.170	00-50-ba-70-e4-7a	Dynamic
System	10.1.1.171	00-50-ba-70-cc-19	Dynamic
System	10.1.1.172	00-50-ba-70-e4-49	Dynamic
System	10.1.1.173	00-50-ba-70-e4-6e	Dynamic
Total Entries: 306			<input type="button" value="Next"/>

Figure 9- 26. Browse ARP Table window

Browse IP Multicast Forwarding Table

The **Browse IP Multicast Forwarding Table** window may be found in the **Monitoring** menu in the **Layer 3 Feature** folder. This window will show current IP multicasting information on the Switch. To search a specific entry, enter an multicast group IP address into the **Multicast Group** field or a **Source IP** address and click **Find**.

Multicast Group	<input type="text" value="0.0.0.0"/>				
Source IP Address	<input type="text" value="0.0.0.0"/>			<input type="button" value="Find"/>	
IP Multicast Forwarding Table					
Multicast Group	Source IP Address	Source Netmask	Upstream Neighbor	Expire Time	Protocol
224.2.140.247	10.0.0.0	255.0.0.0	10.100.100.251	109	DVMRP
224.2.142.32	10.0.0.0	255.0.0.0	10.100.100.251	105	DVMRP
229.55.150.208	10.0.0.0	255.0.0.0	10.100.100.251	118	DVMRP
239.255.255.250	10.0.0.0	255.0.0.0	10.100.100.251	39	DVMRP
Total Entries: 4					

Figure 9- 27. Browse IP Multicast Forwarding Table

Browse IGMP Group Table

The **Browse IGMP Group Table** window may be found in the **Monitoring** menu in the **Layer 3 Feature** folder. This window will show current IGMP group entries on the Switch. To search a specific IGMP group entry, enter an interface name into the **Interface Name** field or a **Multicast Group** IP address and click **Find**.

Interface Name	<input type="text"/>				
Multicast Group	<input type="text" value="0.0.0.0"/>			<input type="button" value="Find"/>	
IGMP Group Table					
Interface Name	Multicast Group	Last Reporter IP	IP Querier	IP Expire	
Total Entries: 0					

Figure 9- 28. Browse IGMP Group Table

To view the specific details for an entry, click the corresponding  icon.

OSPF Monitoring

This section offers windows regarding OSPF (Open Shortest Path First) information on the Switch, including the **OSPF LSDB Table**, **OSPF Neighbor Table** and the **OSPF Virtual Neighbor Table**. To view these tables, open the **Monitoring** folder and click **OSPF Monitoring**.

Browse OSPF LSDB Table

This table can be found in the **OSPF Monitoring** folder by clicking on the **Browse OSPF LSDB Table** link. The **OSPF Link-State Database Table** displays the current link-state database in use by the OSPF routing protocol on a per-OSPF area basis.

Search Type	ALL				
Area ID	0.0.0.0				
Adv. Router ID	0.0.0.0				
LSDB Type	RTRLInk <input type="button" value="Find"/>				
OSPF LSDB Table					
Area ID	LSDB Type	Adv. Router ID	Link State ID	Cost	Sequence
0.0.0.0	RTRLInk	1.0.0.0	1.0.0.0	*	0x80000007
0.0.0.0	RTRLInk	2.0.0.0	2.0.0.0	*	0x80000005
0.0.0.0	RTRLInk	10.9.68.96	10.9.68.96	*	0x80000018
0.0.0.0	RTRLInk	14.99.68.254	14.99.68.254	*	0x80000004
0.0.0.0	RTRLInk	211.1.1.251	211.1.1.251	*	0x80000006
0.0.0.0	NETLink	10.9.68.96	10.9.68.96	*	0x80000001
0.0.0.0	Summary	1.0.0.0	11.1.1.1	10	0x80000002
0.0.0.0	Summary	2.0.0.0	11.1.1.1	11	0x80000002
0.0.0.0	Summary	211.1.1.251	11.1.1.1	10	0x80000001
0.0.0.0	Summary	1.0.0.0	11.1.1.2	10	0x80000002
0.0.0.0	Summary	2.0.0.0	11.1.1.2	11	0x80000002
0.0.0.0	Summary	211.1.1.251	11.1.1.2	10	0x80000001
0.0.0.0	Summary	1.0.0.0	11.1.1.3	10	0x80000002
0.0.0.0	Summary	2.0.0.0	11.1.1.3	11	0x80000002
0.0.0.0	Summary	211.1.1.251	11.1.1.3	10	0x80000001
0.0.0.0	Summary	1.0.0.0	201.0.0.0	1	0x80000003
0.0.0.0	Summary	211.1.1.251	201.0.0.0	1	0x80000001
0.0.0.0	Summary	2.0.0.0	201.1.0.0	1	0x80000002
0.0.0.0	Summary	2.0.0.0	201.2.0.0	2	0x80000002
0.0.0.0	Summary	211.1.1.251	201.2.0.0	1	0x80000002

Figure 9- 29. Browse OSPF LSDB Table

The user may search for a specific entry by entering the following information into the fields at the top of the screen:

To browse the **OSPF LSDB Table**, you first must select which browse method you want to use in the **Search Type** field. The choices are *All*, *Area ID*, *Advertise Router ID*, *LSDB*, *Area ID & Advertise Router ID*, *Area ID & LSDB*, and *Advertise Router ID & LSDB*.

If *Area ID* is selected as the browse method, you must enter the IP address in the **Area ID** field, and then click *Find*.

If *Adv. Router ID* is selected, you must enter the IP address in the **Advertisement Router ID** field, and then click **Find**.

If *LSDB* is selected, you must select the type of link state (*RtrLink*, *NetLink*, *Summary*, *ASSummary* and *ASExtLink*) in the **LSDB Type** field, and then click **Find**.

The following fields are displayed in the **OSPF LSDB Table**:

Parameter	Description										
Area ID	Allows the entry of an OSPF Area ID. This Area ID will then be used to search the table, and display an entry – if there is one.										
LSDB Type	Displays which one of eight types of link advertisements by which the current link was discovered by the Switch: <i>All</i> , Router link (<i>RTRLINK</i>), Network link (<i>NETLink</i>), Summary link (<i>Summary</i>), Autonomous System link (<i>ASSummary</i>), Autonomous System external link (<i>ASExternal</i>), MCGLink (<i>Multicast Group</i>), and NSSA (<i>Not So Stubby Area</i>)										
Adv. Router ID	Displays the Advertising Router's ID.										
Link State ID	This field identifies the portion of the Internet environment that is being described by the advertisement. The contents of this field depend on the advertisement's LS type. <table border="1"> <thead> <tr> <th>LS Type</th> <th>Link State ID</th> </tr> </thead> <tbody> <tr> <td>1</td> <td>The originating router's Router ID.</td> </tr> <tr> <td>2</td> <td>The IP interface address of the network's Designated Router.</td> </tr> <tr> <td>3</td> <td>The destination network's IP address.</td> </tr> <tr> <td>4</td> <td>The Router ID of the described AS boundary router.</td> </tr> </tbody> </table>	LS Type	Link State ID	1	The originating router's Router ID.	2	The IP interface address of the network's Designated Router.	3	The destination network's IP address.	4	The Router ID of the described AS boundary router.
LS Type	Link State ID										
1	The originating router's Router ID.										
2	The IP interface address of the network's Designated Router.										
3	The destination network's IP address.										
4	The Router ID of the described AS boundary router.										
Cost	Displays the cost of the table entry.										
Sequence	Displays a sequence number corresponding to number of times the current link has been advertised as changed.										

Browse OSPF Neighbor Table

This table can be found in the **OSPF Monitoring** folder by clicking on the **Browse OSPF Neighbor Table** link. Routers that are connected to the same area or segment become neighbors in that area. Neighbors are elected via the Hello protocol. IP multicast is used to send out Hello packets to other routers on the segment. Routers become neighbors when they see themselves listed in a Hello packet sent by another router on the same segment. In this way, two-way communication is guaranteed to be possible between any two neighbor routers. This table displays OSPF neighbors of the Switch.

IP Address	<input type="text" value="0.0.0.0"/>	<input type="button" value="Find"/>			
OSPF Neighbor Table					
IP Address	Neighbor Router ID	Option	Priority	State	Events
Total Entries: 0					

Figure 9- 30. OSPF Neighbor Table

To search for OSPF neighbors, enter an IP address and click **Find**. Valid OSPF neighbors will appear in the **OSPF Neighbor Table** below.

OSPF Virtual Neighbor

This table can be found in the **OSPF Monitoring** folder by clicking on the **Browse OSPF Virtual Neighbor Table** link. This table displays a list of **Virtual OSPF Neighbors** of the Switch. The user may choose specifically search a virtual neighbor by using one of the two search options at the top of the screen, which are:

Parameter	Description
Transit Area ID	Allows the entry of an OSPF Area ID – previously defined on the Switch – that allows a remote area to communicate with the backbone (area 0). A Transit Area cannot be a Stub Area or a Backbone Area.
Virtual Neighbor Router ID	The OSPF router ID for the remote router. This IP address uniquely identifies the remote area's Area Border Router.

Transit Area ID	<input type="text" value="0.0.0.0"/>				
Virtual Neighbor Router ID	<input type="text" value="0.0.0.0"/>	<input type="button" value="Browse"/>			
OSPF Virtual Neighbor Table					
Transit Area ID	Virtual Neighbor Router ID	Virtual Neighbor IP Address	Virtual Neighbor Option	Virtual Neighbor State	Events
255.255.255.255	2.0.0.0	201.1.1.250	2	Full	5
Total Entries: 1					

Figure 9- 31.OSPF Virtual Neighbor Table

DVMRP Monitoring

This menu allows the **DVMRP** (Distance-Vector Multicast Routing Protocol) to be monitored for each IP interface defined on the Switch. This folder, found in the **Monitoring** folder, offers 3 screens for monitoring; **Browse DVMRP Routing Table**, **Browse DVMRP Neighbor Address Table** and **Browse DVMRP Routing Next Hop Table**. Information on DVMRP and its features in relation to the DES-6500 can be found in Section 6, under **IP Multicast Routing Protocol**.

Browse DVMRP Routing Table

Multicast routing information is gathered and stored by DVMRP in the **DVMRP Routing Table**, which may be found in the **Monitoring** folder under **Browse DVMRP Monitoring**, contains one row for each port in a DVMRP mode. Each routing entry contains information about the source and multicast group, and incoming and outgoing interfaces. You may define your search by entering a **Source IP Address** and its subnet mask into the fields at the top of the page.

Source IP Address	Source Netmask	Upstream Neighbor	Metric	Learned	Interface Name	Expire Time
10.0.0.0	255.0.0.0	10.100.100.251	1	Local	n10	---
11.0.0.0	255.0.0.0	10.20.6.251	2	Dynamic	n10	86
12.0.0.0	255.0.0.0	10.20.6.251	3	Dynamic	n10	86
13.0.0.0	255.0.0.0	10.20.6.251	4	Dynamic	n10	86
192.1.0.0	255.255.0.0	10.20.6.251	2	Dynamic	n10	86
192.2.0.0	255.255.0.0	10.20.6.251	4	Dynamic	n10	86
192.168.1.0	255.255.255.0	10.254.254.251	2	Dynamic	n10	90
201.1.0.0	255.255.0.0	201.1.1.1	1	Local	n2001	---
201.2.0.0	255.255.0.0	201.2.1.1	1	Local	n2002	---
201.3.0.0	255.255.0.0	201.3.1.1	1	Local	n2003	---
201.4.0.0	255.255.0.0	201.4.1.1	1	Local	n2004	---
201.5.0.0	255.255.0.0	201.5.1.1	1	Local	n2005	---
201.6.0.0	255.255.0.0	201.6.1.1	1	Local	n2006	---
201.7.0.0	255.255.0.0	201.7.1.1	1	Local	n2007	---
201.8.0.0	255.255.0.0	201.8.1.1	1	Local	n2008	---
223.255.255.252	255.255.255.252	10.20.6.251	2	Dynamic	n10	86
Total Entries: 16						

Figure 9- 32. DVMRP Routing Table

Browse DVMRP Neighbor Table

This table, found in the **Monitoring** menu under **DVMRP Monitor > Browse DVMRP Neighbor Table** contains information about DVMRP neighbors of the Switch. To search this table, enter either an **Interface Name** or **Neighbor Address** into the respective field and click the **Find** button. DVMRP neighbors of that entry will appear in the **DVMRP Neighbor Table** below.

Interface Name	<input type="text"/>		
Neighbor Address	<input type="text" value="0.0.0.0"/>		
Net Mask	<input type="text" value="255.255.255.0"/>		<input type="button" value="Find"/>
DVMRP Neighbor Table			
Interface Name	Neighbor Address	Generation ID	Expire Time
Total Entries: 0			

Figure 9- 33. DVMRP Neighbor Table

Browse DVMRP Routing Next Hop Table

The **DVMRP Routing Next Hop Table** contains information regarding the next-hop for forwarding multicast packets on outgoing interfaces. Each entry in the **DVMRP Routing Next Hop Table** refers to the next-hop of a specific source to a specific multicast group address. This table is found in the **Monitoring** menu under **DVMRP Monitoring**, with the heading **Browse DVMRP Routing Next Hop Table**. To search this table, enter either an **Interface Name** or **Source IP Address** into the respective field and click the **Find** button. The next hop of that DVMRP Routing entry will appear in the **DVMRP Routing Next Hop Table** below.

Interface Name	<input type="text"/>		
Source IP Address	<input type="text" value="0.0.0.0"/>		
Net Mask	<input type="text" value="255.255.255.0"/>		<input type="button" value="Find"/>
DVMRP Routing Next Hop Table			
Source IP Address	Source Mask	Interface Name	Type
Total Entries: 0			

Figure 9- 34. DVMRP Routing Next Hop Table

PIM Monitoring

Multicast routers use **Protocol Independent Multicast (PIM)** to determine which other multicast routers should receive multicast packets. To find out more information concerning PIM and its configuration on the Switch, see the **IP Multicast Routing Protocol** chapter of Section 6, **Configuration**.

PIM Neighbor Address Table

The **PIM Neighbor Address Table** contains information regarding each of a router's PIM neighbors. This screen may be found in the **Monitoring** folder under the heading **PIM Monitor**. To search this table, enter either an **Interface Name** or **Neighbor Address** into the respective field and click the **Find** button. PIM neighbors of that entry will appear in the **PIM Neighbor Table** below.

Interface Name	<input type="text"/>	
Neighbor IP Address	<input type="text" value="0.0.0.0"/>	<input type="button" value="Find"/>
PIM Neighbor Table		
Interface Name	Neighbor IP Address	Expire Time
n10	10.9.68.96	101
Total Entries: 1		

Figure 9- 35. PIM Neighbor Table

Section 10

Switch Maintenance

TFTP Services

Ping Test

TraceRoute

Save Configuration

Reset

Reboot Services

Logout

TFTP Services

Trivial File Transfer Protocol (TFTP) services allow the Switch's firmware to be upgraded by transferring a new firmware file from a TFTP server to the Switch. A configuration file can also be loaded into the Switch from a TFTP server, switch settings can be saved to the TFTP server, and a history log can be uploaded from the Switch to the TFTP server.

Download Firmware

To update the Switch's firmware, open the **TFTP Services** folder in the **Maintenance** folder and then click the **Download Firmware** link:

Figure 10- 1. Download Firmware window

Unit Number – Select which slot in the chassis you want to update the firmware on. This allows the selection of a particular slot from slot stack if you have properly inserted the line cards in the chassis. **All** indicates all slots in the chassis will download the same firmware.

Enter the IP address of the TFTP server in the **Server IP Address** field.

The TFTP server must be on the same IP subnet as the Switch.

Enter the path and the filename to the firmware file on the TFTP server. Note that in the above example, the firmware file is in the root directory of the D drive of the TFTP server.

The TFTP server must be running TFTP server software to perform the file transfer. TFTP server software is a part of many network management software packages – such as NetSight, or can be obtained as a separate program.

Click **Start** to record the IP address of the TFTP server and initiate the file transfer.



NOTE: Please check the firmware version of the CPU and line cards of the DES-6500 before upgrading to firmware release 2.00-B-20. For firmware upgrading information, cautions and procedures for release 2, please see Appendix B at the end of the manual.

Download Configuration

To download a configuration file from a TFTP server, click on the **TFTP Service** folder in the **Maintenance** folder and then the **Download Configuration File** link:



Download Configuration	
Server IP Address	0.0.0.0
File Name	
Increment	<input type="checkbox"/>
Start	

Figure 10- 2. Download Configuration window

Enter the IP address of the TFTP server and specify the location of the switch configuration file on the TFTP server. Click the **Increment** check box to download a part of this file only.

Click **Start** to initiate the file transfer.

Upload Configuration

To upload the Switch's settings to a TFTP server, click on the **TFTP Service** folder in the **Maintenance** folder and then click the **Upload Configuration** link:

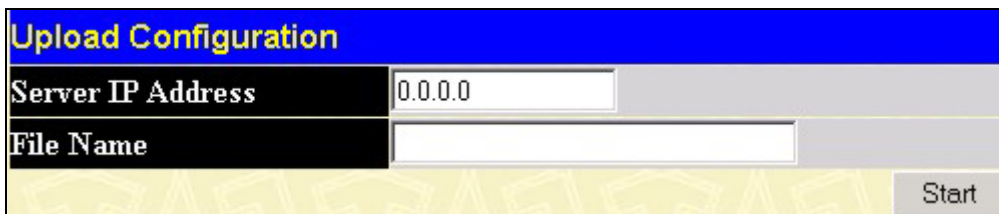

Upload Configuration	
Server IP Address	0.0.0.0
File Name	
Start	

Figure 10- 3. Upload Configuration window

Enter the IP address of the TFTP server and the path and filename for the configuration file on the TFTP server.

Click **Start** to initiate the file transfer.

Upload History Log

To upload the Switch history log file to a TFTP server, open the **TFTP Service** folder in the **Maintenance** folder and then click the **Upload Log** link:

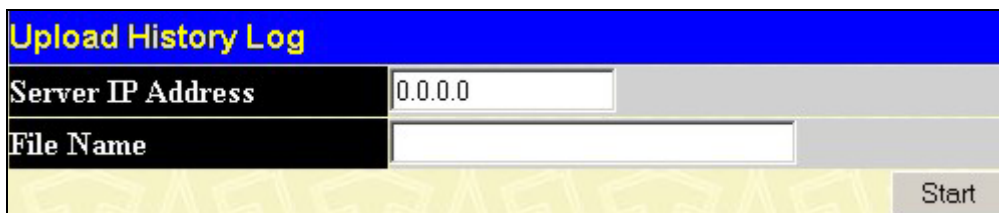

Upload History Log	
Server IP Address	0.0.0.0
File Name	
Start	

Figure 10- 4. Upload Log window

Enter the IP address of the TFTP server and the path and filename for the history log on the TFTP server.

Click **Start** to record the IP address of the TFTP server and to initiate the file transfer.

Ping Test

Ping is a small program that sends ICMP Echo packets to the IP address you specify. The destination node then responds to or "echoes" the packets sent from the Switch. This is very useful to verify connectivity between the Switch and other nodes on the network.

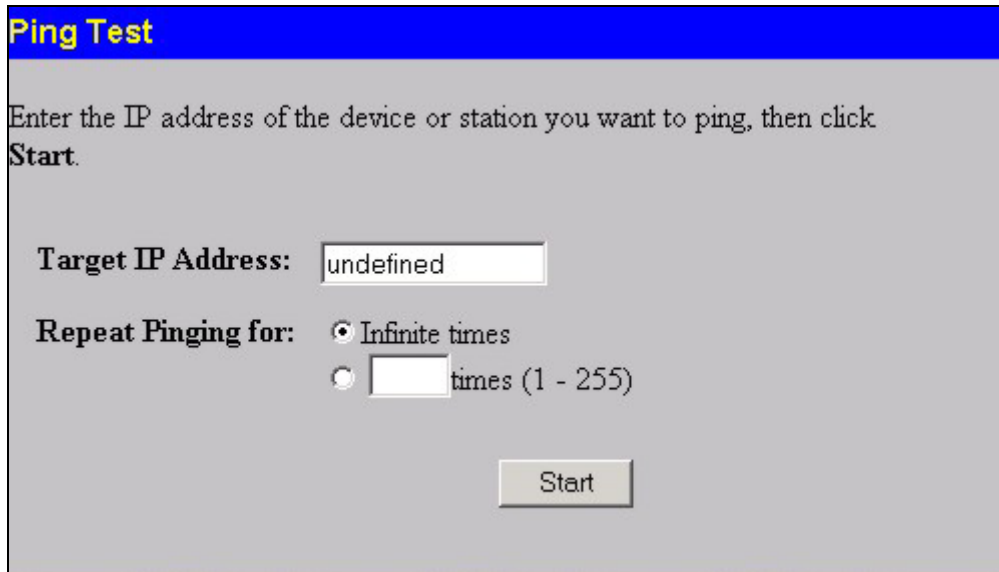

Figure 10- 5. Ping Test

The user may use Infinite times radio button, in the **Repeat Pinging for:** field, which will tell the ping program to keep sending ICMP Echo packets to the specified IP address until the program is stopped. The user may opt to choose a specific number of times to ping the **Target IP Address** by clicking its radio button and entering a number between 1 and 255. Click **Start** to initiate the Ping program.

Traceroute

The following window will aid the user in back tracing the route taken by a packet before arriving at the Switch. When initiated, the Traceroute program will display the IP addresses of the previous hops a packet takes from the **Target IP Address** entered in the window, until it reaches the Switch.

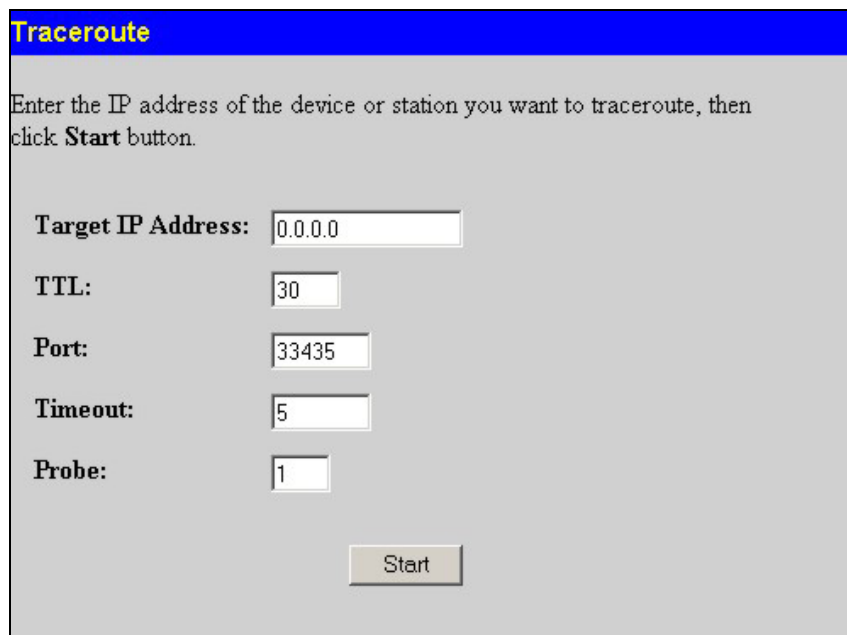

Figure 10- 6. Traceroute window

To trace the route of a packet, set the following parameters located in this window, and click **Start**.

Parameter	Description
Target IP Address	Enter the IP address of the computer to be traced.
TTL	The time to live value of the trace route request. This is the maximum number of routers the traceroute command will cross while seeking the network path between two devices.
Port	The virtual port number. The port number must be above 1024. The value range is from 30000 to 64900.
Timeout	Defines the time-out period while waiting for a response from the remote device. The user may choose an entry between 1 and 65535 seconds.
Probe	The probe value is the number of times the Switch will send probe packets to the next hop on the intended traceroute path. The default is 1.

Save Configuration

The DES-6500 switch has two levels of memory, normal RAM and non-volatile or NV-RAM. Configuration changes are made effective clicking the **Apply** button. When this is done, the settings will be immediately applied to the switching software in RAM, and will immediately take effect.

Some settings, though, require you to restart the Switch before they will take effect. Restarting the Switch erases all settings in RAM and reloads the stored settings from the NV-RAM. Thus, it is necessary to save all setting changes to NV-RAM before rebooting the switch.

To retain any configuration changes permanently, click on the **Save** button in the **Save Changes** page, as shown below.

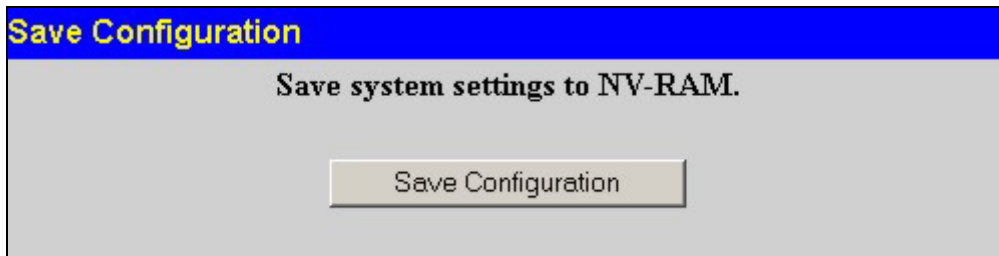

Figure 10- 7. Save Changes screen

Reset

The **Reset** function has several options when resetting the Switch. Some of the current configuration parameters can be retained while resetting all other configuration parameters to their factory defaults.



NOTE: Only the **Reset System** option will enter the factory default parameters into the Switch's non-volatile RAM, and then restart the Switch. All other options enter the factory defaults into the current configuration, but do not save this configuration. **Reset System** will return the Switch's configuration to the state it was when it left the factory

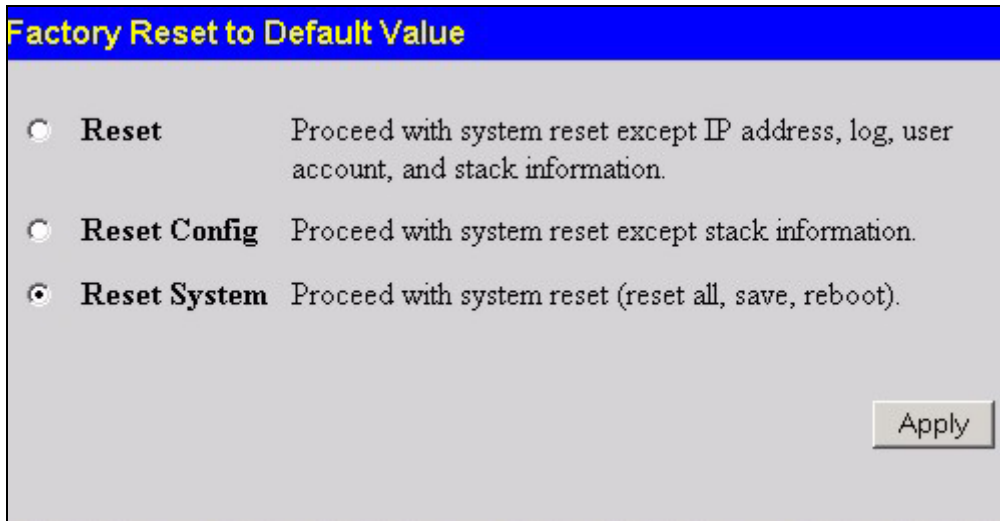

Figure 10- 8. Factory Reset to Default Value window

Reboot Device

The following menu is used to restart the Switch.

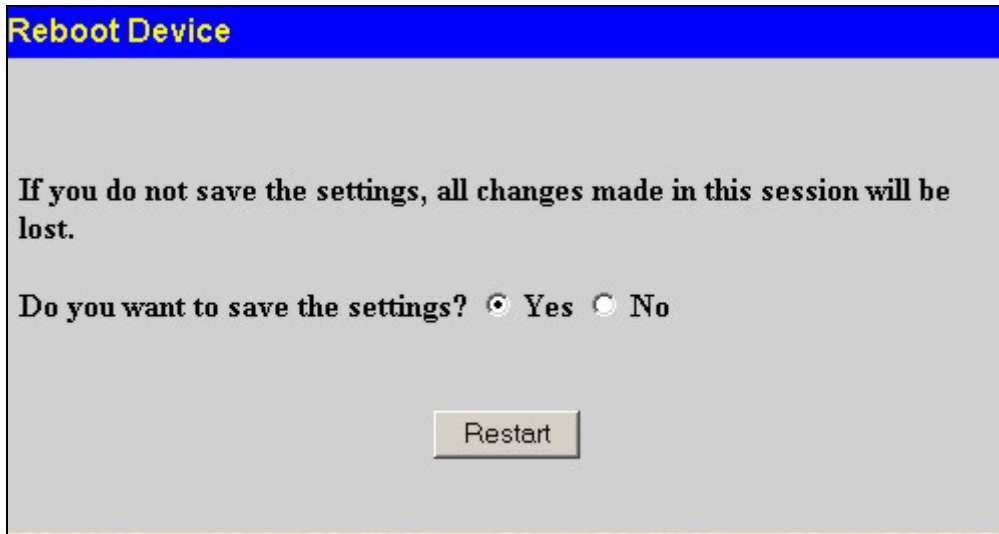

Figure 10- 9. Reboot System window

Clicking the **Yes** click-box will instruct the Switch to save the current configuration to non-volatile RAM before restarting the Switch.

Clicking the **No** click-box instructs the Switch not to save the current configuration before restarting the Switch. All of the configuration information entered from the last time **Save Changes** was executed, will be lost.

Click the **Restart** button to restart the Switch.

Logout

Use the **Logout** page to logout of the Switch's Web-based management agent by clicking on the **Log Out** button.

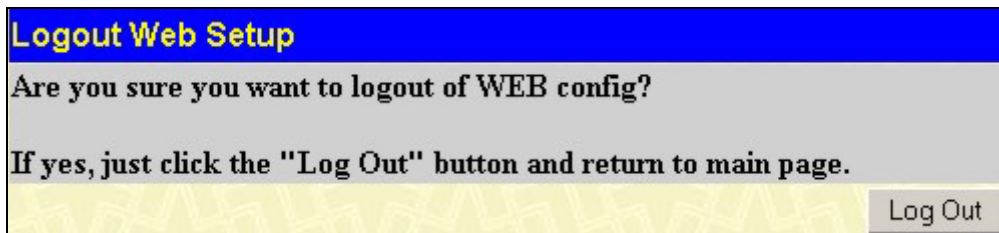

Figure 10- 10. Logout window

Section 11

D-Link Single IP Management

Single IP Management (SIM) Overview

Topology

Firmware Upgrade

Configuration Backup/Restore

Single IP Management (SIM) Overview

Simply put, D-Link Single IP Management is a concept that will stack switches together over Ethernet instead of using stacking ports or modules. There are some advantages in implementing the "Single IP Management" feature:

1. SIM can simplify management of small workgroups or wiring closets while scaling the network to handle increased bandwidth demand.
2. SIM can reduce the number of IP address needed in your network.
3. SIM can eliminate any specialized cables for stacking connectivity and remove the distance barriers that typically limit your topology options when using other stacking technology.

Switches using D-Link Single IP Management (labeled here as SIM) must conform to the following rules:

- SIM is an optional feature on the Switch and can easily be enabled or disabled through the Command Line Interface or Web Interface. SIM grouping has no effect on the normal operation of the Switch in the user's network.
- There are three classifications for switches using SIM. The **Commander Switch (CS)**, which is the master switch of the group, **Member Switch (MS)**, which is a switch that is recognized by the CS a member of a SIM group, and a **Candidate Switch (CaS)**, which is a Switch that has a physical link to the SIM group but has not been recognized by the CS as a member of the SIM group.
- A SIM group can only have one Commander Switch (CS).
- All switches in a particular SIM group must be in the same IP subnet (broadcast domain). Members of a SIM group cannot cross a router.
- A SIM group accepts up to 32 switches (numbered 0-31), including the Commander Switch (numbered 0).

There is no limit to the number of SIM groups in the same IP subnet (broadcast domain), however a single switch can only belong to one group.

If multiple VLANs are configured, the SIM group will only utilize the default VLAN on any switch.

SIM allows intermediate devices that do not support SIM. This enables the user to manage switches that are more than one hop away from the CS.

The SIM group is a group of switches that are managed as a single entity. The DES-6500 switch may take on three different roles:

1. **Commander Switch (CS)** - This is a switch that has been manually configured as the controlling device for a group, and takes on the following characteristics:
 - It has an IP Address.
 - It is not a command switch or member switch of another Single IP group.
 - It is connected to the member switches through its management VLAN.
2. **Member Switch (MS)** - This is a switch that has joined a single IP group and is accessible from the CS, and it takes on the following characteristics:
 - It is not a CS or MS of another IP group.

- It is connected to the CS through the CS management VLAN.
3. **Candidate Switch (CaS)** - This is a switch that is ready to join a SIM group but is not yet a member of the SIM group. The Candidate Switch may join the SIM group of the DES-6500 switch by manually configuring it to be a MS of a SIM group. A switch configured as a CaS is not a member of a SIM group and will take on the following characteristics:
- It is not a CS or MS of another Single IP group.
 - It is connected to the CS through the CS management VLAN

The following rules also apply to the above roles:

- Each device begins in a Commander state.
- CS's must change their role to CaS and then to MS, to become a MS of a SIM group. Thus, the CS cannot directly be converted to a MS.
- The user can manually configure a CS to become a CaS.

A MS can become a CaS by:

- Being configured as a CaS through the CS.
- If report packets from the CS to the MS time out.
- The user can manually configure a CaS to become a CS
- The CaS can be configured through the CS to become a MS.

After configuring one switch to operate as the CS of a SIM group, additional DES-6500 switches may join the group by manually configuring the Switch to be a MS. The CS will then serve as the in band entry point for access to the MS. The CS's IP address will become the path to all MS's of the group and the CS's Administrator's password, and/or authentication will control access to all MS's of the SIM group.

With SIM enabled, the applications in the CS will redirect the packet instead of executing the packets. The applications will decode the packet from the administrator, modify some data, then send it to the MS. After execution, the CS may receive a response packet from the MS, which it will encode and send it back to the administrator.

When a CS becomes a MS, it automatically becomes a member of the first SNMP community (include read/write and read only) to which the CS belongs. However, if a MS has its own IP address, it can belong to SNMP communities to which other switches in the group, including the CS, do not belong.

SIM Using the Web Interface

All DES-6500 switches are set as Candidate (CaS) switches as their factory default configuration and Single IP Management will be disabled. To enable SIM for the Switch using the Web interface, go to the **Single IP Management** folder and click the **SIM Settings** link, revealing the following window.



Figure 11- 1. SIM Settings window (disabled)

Change the **SIM State** to *Enabled* using the pull down menu and click **Apply**. The screen will then refresh and the **SIM Settings** window will look like this:

SIM Settings	
SIM State	Enabled ▾
Role State	Commander ▾
Discovery Interval	60 (30..90 sec)
Holdtime	180 (100..255 sec)
Apply	

Figure 11- 2. SIM Settings window (enabled)

The following parameters can be set:

Parameters	Description
SIM State	Use the pull down menu to either enable or disable the SIM state on the Switch. <i>Disabled</i> will render all SIM functions on the Switch inoperable.
Role State	Use the pull down menu to change the SIM role of the Switch. The two choices are: <ul style="list-style-type: none"> <i>Candidate</i> - A Candidate Switch (CaS) is not the member of a SIM group but is connected to a Commander Switch. This is the default setting for the SIM role. <i>Commander</i> - Choosing this parameter will make the Switch a Commander Switch (CS). The user may join other switches to this Switch, over Ethernet, to be part of its SIM group. Choosing this option will also enable the Switch to be configured for SIM.
Discovery Interval	The user may set the discovery protocol interval, in seconds that the Switch will send out discovery packets. Returning information to a Commander Switch will include information about other switches connected to it. (Ex. MS, CaS). The user may set the Discovery Interval from 30 to 90 seconds.
Holdtime	This parameter may be set for the time, in seconds the Switch will hold information sent to it from other switches, utilizing the Discovery Interval . The user may set the hold time from 100 to 255 seconds.

Click **Apply** to implement the settings changed.

After enabling the Switch to be a Commander Switch (CS), the **Single IP Management** folder will then contain three added links to aid the user in configuring SIM through the web, including **Topology**, **Firmware Upgrade** and **Configuration Backup/Restore**.

Topology

The **Topology** window will be used to configure and manage the Switch within the SIM group and requires Java script to function properly on your computer.

The Java Runtime Environment on your server should initiate and lead you to the topology window, as seen below.

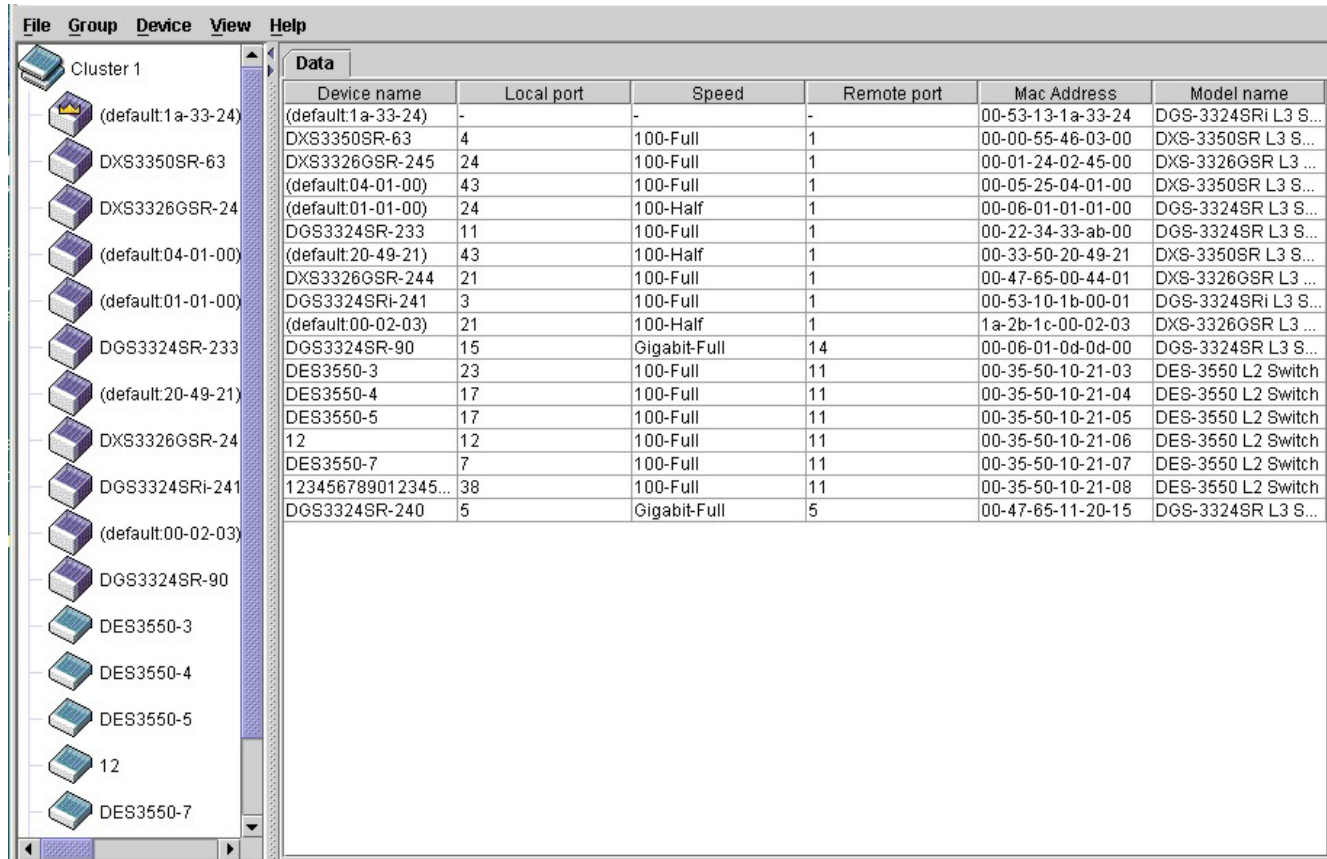

Device name	Local port	Speed	Remote port	Mac Address	Model name
(default:1a-33-24)	-	-	-	00-53-13-1a-33-24	DGS-3324SRI L3 S...
DXS3350SR-63	4	100-Full	1	00-00-55-46-03-00	DXS-3350SR L3 S...
DXS3326GSR-245	24	100-Full	1	00-01-24-02-45-00	DXS-3326GSR L3 ...
(default:04-01-00)	43	100-Full	1	00-05-25-04-01-00	DXS-3350SR L3 S...
(default:01-01-00)	24	100-Half	1	00-06-01-01-01-00	DGS-3324SR L3 S...
DGS3324SR-233	11	100-Full	1	00-22-34-33-ab-00	DGS-3324SR L3 S...
(default:20-49-21)	43	100-Half	1	00-33-50-20-49-21	DXS-3350SR L3 S...
DXS3326GSR-244	21	100-Full	1	00-47-65-00-44-01	DXS-3326GSR L3 ...
(default:00-02-03)	3	100-Full	1	00-53-10-1b-00-01	DGS-3324SRI L3 S...
DGS3324SR-90	21	100-Half	1	1a-2b-1c-00-02-03	DXS-3326GSR L3 ...
DGS3324SR-90	15	Gigabit-Full	14	00-06-01-0d-0d-00	DGS-3324SR L3 S...
DES3550-3	23	100-Full	11	00-35-50-10-21-03	DES-3550 L2 Switch
DES3550-4	17	100-Full	11	00-35-50-10-21-04	DES-3550 L2 Switch
DES3550-5	17	100-Full	11	00-35-50-10-21-05	DES-3550 L2 Switch
12	12	100-Full	11	00-35-50-10-21-06	DES-3550 L2 Switch
DES3550-7	7	100-Full	11	00-35-50-10-21-07	DES-3550 L2 Switch
123456789012345...	38	100-Full	11	00-35-50-10-21-08	DES-3550 L2 Switch
DGS3324SR-240	5	Gigabit-Full	5	00-47-65-11-20-15	DGS-3324SR L3 S...

Figure 11- 3. Single IP Management window - Tree View

The Tree View window holds the following information under the Data tab:

Parameter	Description
Device Name	This field will display the Device Name of the switches in the SIM group configured by the user. If no Device Name is configured by the name, it will be given the name default and tagged with the last six digits of the MAC Address to identify it.
Local Port	Displays the number of the physical port on the CS that the MS or CaS is connected to. The CS will have no entry in this field.
Speed	Displays the connection speed between the CS and the MS or CaS.
Remote Port	Displays the number of the physical port on the MS or CaS that the CS is connected to. The CS will have no entry in this field.
MAC Address	Displays the MAC Address of the corresponding Switch.
Model Name	Displays the full Model Name of the corresponding Switch.

To view the **Topology Map**, click the View menu in the toolbar and then Topology, which will produce the following screen. The **Topology View** will refresh itself periodically (20 seconds by default).

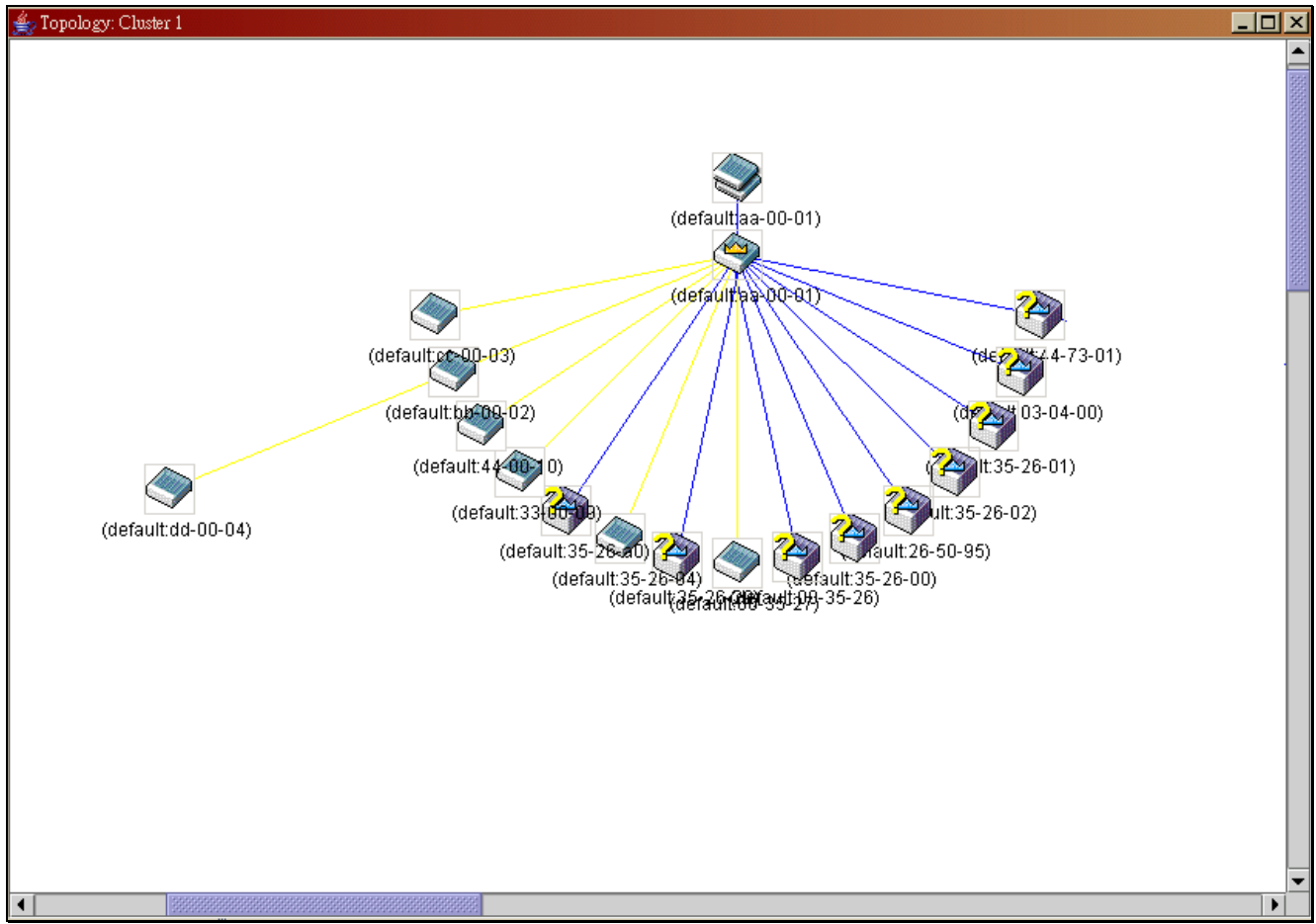













Figure 11- 4. Topology view

This screen will display how the devices within the Single IP Management Group are connected to other groups and devices. Possible icons in this screen are as follows:

Icon	Description
	Group
	Layer 2 commander switch
	Layer 3 commander switch
	Commander switch of other group
	Layer 2 member switch.
	Layer 3 member switch
	Member switch of other group

	Layer 2 candidate switch
	Layer 3 candidate switch
	Unknown device
	Non-SIM devices

Tool Tips

In the Topology view window, the mouse plays an important role in configuration and in viewing device information. Setting the mouse cursor over a specific device in the topology window (tool tip) will display the same information about a specific device as the Tree view does. See the window below for an example.

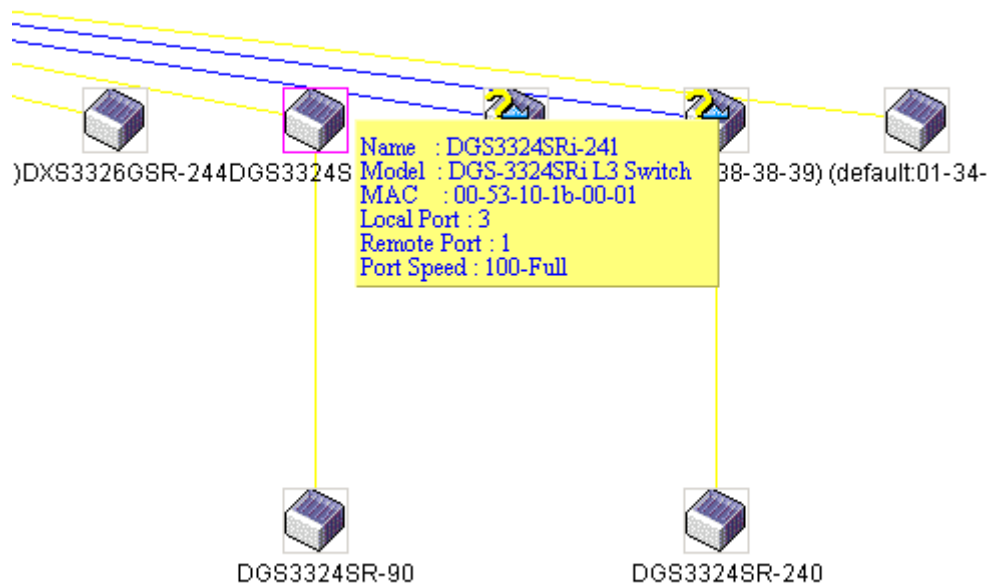

Figure 11- 5. Device Information Utilizing the Tool Tip

Setting the mouse cursor over a line between two devices will display the connection speed between the two devices, as shown below.

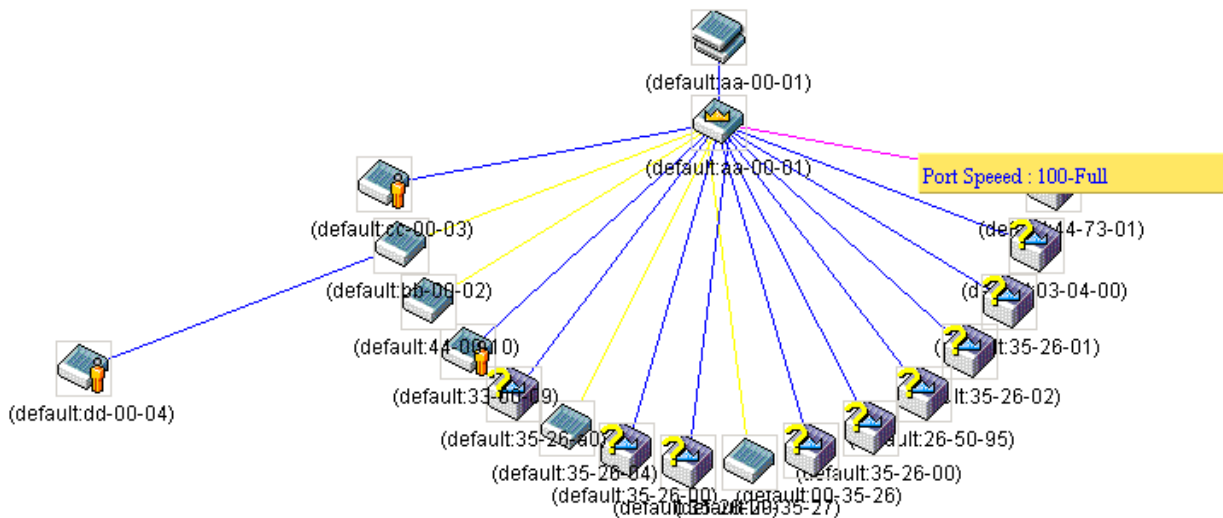

Figure 11- 6. Port Speed Utilizing the Tool Tip

Right Click

Right clicking on a device will allow the user to perform various functions, depending on the role of the Switch in the SIM group and the icon associated with it.

Group Icon

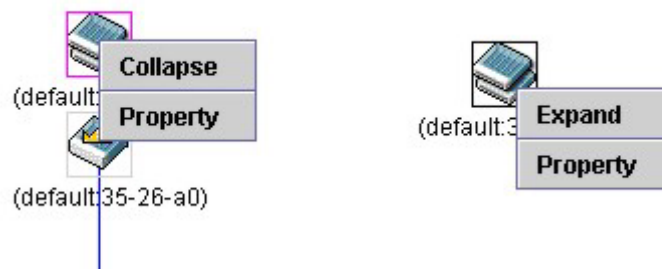

Figure 11- 7. Right Clicking a Group Icon

The following options may appear for the user to configure:

- **Collapse** - to collapse the group that will be represented by a single icon.
- **Expand** - to expand the SIM group, in detail.
- **Property** - to pop up a window to display the group information.

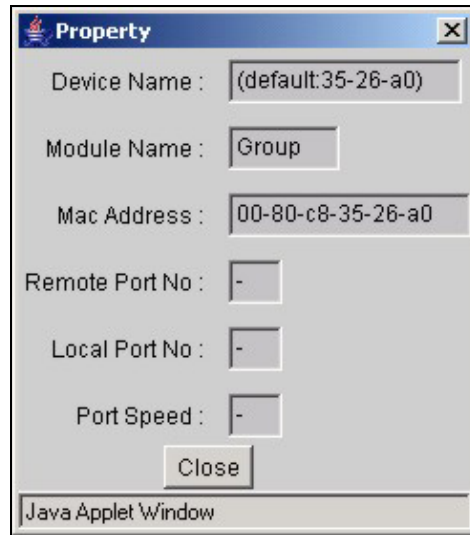

Figure 11- 8. Property window

Commander Switch Icon

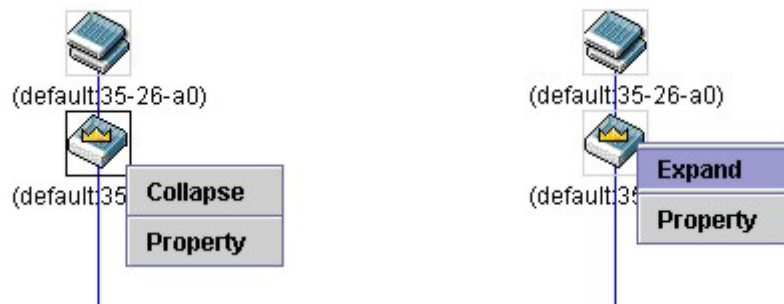

Figure 11- 9. Right Clicking a Commander Icon

The following options may appear for the user to configure:

- **Collapse** - to collapse the group that will be represented by a single icon.
- **Expand** - to expand the SIM group, in detail.
- **Property** - to pop up a window to display the group information.

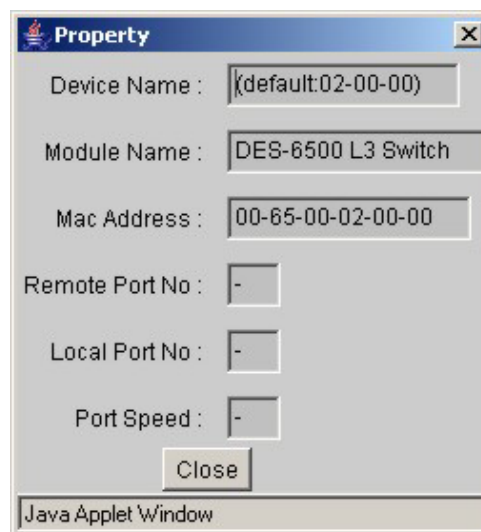

Figure 11- 10. Property window

Member Switch Icon



Figure 11- 11. Right Clicking a Member icon

The following options may appear for the user to configure:

- **Collapse** - to collapse the group that will be represented by a single icon.
- **Expand** - to expand the SIM group, in detail.
- **Remove from group** - remove a member from a group.
- **Configure** - launch the web management to configure the Switch.
- **Property** - to pop up a window to display the device information.

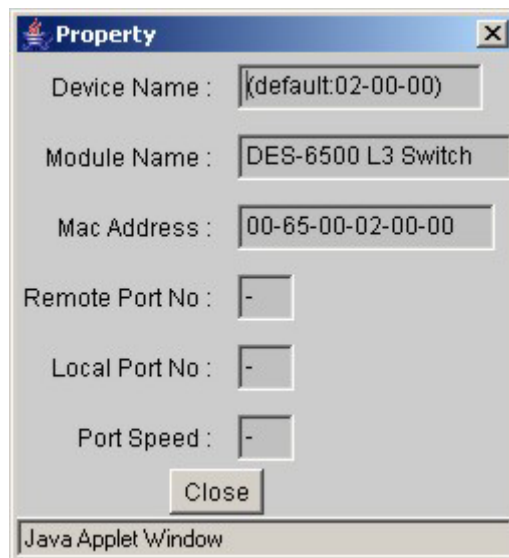

Figure 11- 12. Property window

Candidate Switch Icon

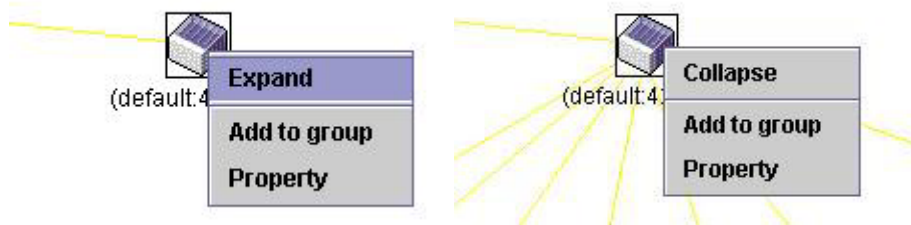

Figure 11- 13. Right Clicking a Candidate icon

The following options may appear for the user to configure:

- **Collapse** - to collapse the group that will be represented by a single icon.
- **Expand** - to expand the SIM group, in detail.

- **Add to group** - add a candidate to a group. Clicking this option will reveal the following screen for the user to enter a password for authentication from the Candidate Switch before being added to the SIM group. Click OK to enter the password or Cancel to exit the window.



Figure 11- 14. Input password window.

- **Property** - to pop up a window to display the device information, as shown below.

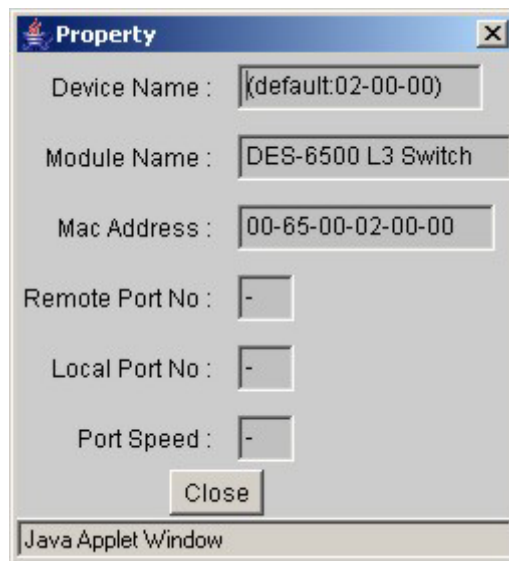

Figure 11- 15. Device Property window.

This window holds the following information:

Parameter	Description
Device Name	This field will display the Device Name of the switches in the SIM group configured by the user. If no Device Name is configured by the name, it will be given the name default and tagged with the last six digits of the MAC Address to identify it.
Module Name	Displays the full module name of the switch that was right-clicked.
MAC Address	Displays the MAC Address of the corresponding Switch.
Remote Port No.	Displays the number of the physical port on the MS or CaS that the CS is connected to. The CS will have no entry in this field.
Local Port No.	Displays the number of the physical port on the CS that the MS or CaS is connected to. The CS will have no entry in this field.
Port Speed	Displays the connection speed between the CS and the MS or CaS

Click **Close** to close the **Property** window.

Menu Bar

The **Single IP Management** window contains a menu bar for device configurations, as seen below.



Figure 11- 16. Menu Bar of the Topology View

The five menus on the menu bar are as follows.

File

- **Print Setup** - will view the image to be printed.
- **Print Topology** - will print the topology map.
- **Preference** - will set display properties, such as polling interval, and the views to open at SIM startup.

Group

- **Add to group** - add a candidate to a group. Clicking this option will reveal the following screen for the user to enter a password for authentication from the Candidate Switch before being added to the SIM group. Click OK to enter the password or Cancel to exit the window.

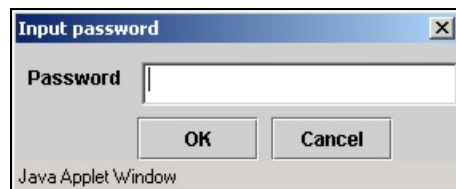

Figure 11- 17. Input password window.

- **Remove from Group** - remove an MS from the group.

Device

- **Configure** - will open the web manager for the specific device.

View

- **Refresh** - update the views with the latest status.
- **Topology** - display the Topology view.

Help

- **About** - Will display the SIM information, including the current SIM version.



NOTE: Upon this firmware release, some functions of the SIM can only be configured through the Command Line Interface. See the ***DES-6500 Command Line Interface Reference Manual*** for more information on SIM and its configurations.

Firmware Upgrade

This screen is used to upgrade firmware from the Commander Switch to the Member Switch. To access the following window, click **Single IP Management > Firmware Upgrade**. Member Switches will be listed in the table and will be specified by **Port** (port on the CS where the MS resides), **MAC Address**, **Model Name** and **Version**. To specify a certain Switch for firmware download, click its corresponding check box under the **Port** heading. To update the firmware, enter the **Server IP Address** where the firmware resides and enter the **Path/Filename** of the firmware. Click **Download** to initiate the file transfer.

Firmware Upgrade				
Port	MAC Address	Model Name	Version	
Server IP Address		0	0	0
Path \ Filename				
				Download

Figure 11- 18. Firmware Upgrade window

Configuration File Backup/Restore

This screen is used to upgrade configuration files from the Commander Switch to the Member Switch using a TFTP server. Member Switches will be listed in the table and will be specified by **Port** (port on the CS where the MS resides), **MAC Address**, **Model Name** and **Version**. To specify a certain Switch for upgrading configuration files, click its corresponding radio button under the **Port** heading. To update the configuration file, enter the **Server IP Address** where the file resides and enter the **Path/Filename** of the configuration file. Click **Download** to initiate the file transfer from a TFTP server to the Switch. Click **Upload** to backup the configuration file to a TFTP server.

Configuration File Backup/Restore				
Port	MAC Address	Model Name	Version	
Server IP Address		0	0	0
Path \ Filename				
				Upload Download

Figure 11- 19. Configuration File Backup/Restore window

Appendix A

General

Standards	<p>IEEE 802.3u 100BASE-TX Fast Ethernet</p> <p>IEEE 802.3ab 1000BASE-T Gigabit Ethernet</p> <p>IEEE 802.1D Spanning Tree</p> <p>IEEE 802.1w Rapid Spanning Tree</p> <p>IEEE 802.1s Multiple Spanning Tree</p> <p>IEEE 802.1 P/Q VLAN</p> <p>IEEE 802.1p Priority Queues</p> <p>IEEE 802.1x Port and MAC Based Access Control</p> <p>IEEE 802.3ad Link Aggregation Control</p> <p>IEEE 802.3x Full-duplex Flow Control</p> <p>IEEE 802.3 Nway auto-negotiation</p>
Protocols	CSMA/CD
Data Transfer Rates:	Half-duplex Full-duplex
Ethernet	10 Mbps 20Mbps
Fast Ethernet	100Mbps 200Mbps
Gigabit Ethernet	1000Mbps 2000Mbps
Fiber Optic	<p>IEEE 802.3z 1000BASE-LX (DEM-310GT Transceiver)</p> <p>IEEE 802.3z 1000BASE-SX (DEM-311GT Transceiver)</p> <p>IEEE 802.3z 1000BASE-LH (DEM-314GT Transceiver)</p> <p>IEEE 802.3z 1000BASE-ZX (DEM-315GT Transceiver)</p>
Topology	Star
Network Cables	<p>UTP Cat.5, Cat.5 Enhanced for 1000Mbps</p> <p>UTP Cat.5 for 100Mbps</p> <p>UTP Cat.3, 4, 5 for 10Mbps</p> <p>EIA/TIA-568 100-ohm screened twisted-pair (STP)(100m)</p>

Physical And Environment

AC inputs & External Redundant Power Supply	100 - 240 VAC, 50/60 Hz (internal universal power supply)
Power Consumption:	<p>296W maximum</p> <p>DES-6504: 30W maximum</p>

	DES-6505: 20W maximum DES-6507: 30W maximum DES-6508: 27W maximum DES-6509: 20W maximum DES-6510: 28W maximum
DC fans:	Four built-in 80 x 80 x 25 mm fans.
Operating Temperature:	0 to 40 degrees Celsius
Storage Temperature:	-25 to 55 degrees Celsius
Humidity:	Operating: 5% to 95% RH non-condensing Storage: 0% to 95% RH non-condensing
Dimensions:	440 mm x 294 mm x 356 mm (1U), 19 inch rack-mount width Modules: 330mm x 281mm x 27.5mm
Weight:	TBD
EMI:	FCC Part 15 Class A/ ICES-003 Class (Canada) EN55022 Class A/ EN55024
Safety:	CSA International

Performance

Transmission Method:	Store-and-forward
RAM Buffer:	256 MB per line card, 256MB for CPU Card
Filtering Address Table:	16 K MAC addresses per device 3K IP addresses per device
Packet Filtering/ Forwarding Rate:	Full-wire speed for all connections. 148,810 pps per port (for 100Mbps) 1,488,100 pps per port (for 1000Mbps)
MAC Address Learning:	Automatic update.
Forwarding Table Age Time:	Max age: 10 - 1000000 seconds. Default = 300.

Appendix B

Upgrading Instructions for Release 2.5 Firmware (R2.50-B12)

For firmware release R2.50-B12, certain guidelines must be followed for proper installation of line cards and their appropriate firmware. **Failing to follow these rules may result in inoperability of the switch or installed line cards.**

Line Card Firmware Compatibility

The DES-6500 chassis switch supports the following line cards:

- DES-6504 12-port 100BASE-FX (SFF) Fast Ethernet Switch module
- DES-6505 8-port 1000Base-SX SC Fiber Module
- DES-6506 Patch Panel for 24 port RJ45
- DES-6507 12-port 10BASE-T/100BASE-TX/1000BASE-T + Combo 2 SFP
- DES-6508 16-port 10/100M Base-T module
- DES-6509 12-port mini GBIC Fiber Module
- DES-6510 24-port 10/100M RJ21 Module
- DES-6512 2-port 10 GE XFP switch module

These line cards have various compatibilities with different CPU firmware runtime versions. See the following table for a better understanding.

Runtime Code Version	Supported Line Card
R1.01-B37	DES-6507/DES-6509
R1.01-B40	DES-6505 /DES-6507/DES-6509
R1.20-B09	DES-6505/DES-6507/ DES-6508 /DES-6509/ DES-6510
R1.30-B02	DES-6504 /DES-6505/DES-6507/DES-6508/DES-6509/DES-6510
R1.40-B03	DES-6504/DES-6505/DES-6507/DES-6508/DES-6509/DES-6510
R2.00-B20	DES-6504/DES-6505/DES-6507/DES-6508/DES-6509/DES-6510
R2.50-B12	DES-6504/DES-6505/DES-6507/DES-6508/DES-6509/DES-6510/ DES-6512

In the previous table, the Runtime Code Version is the earliest firmware version that the corresponding cards listed in the Supported Line Card column can utilize. For example, the DES-6507 and the DES-6509 are listed for every firmware and therefore are compatible with every firmware release dating back to R1.01-B37. The DES-6505 starts with R1.01-B40 and is compatible with every firmware release dating back to R1.01-B40, and so on. **Installing a line card in the chassis containing unsupported firmware will result in a system boot-up failure for the chassis.** Line cards marked in bold denote recently added firmware support for these line cards with the corresponding listed firmware. **All installed line cards must be using the same firmware release runtime code as the chassis CPU, or compatibility problems will arise.**

Precautions for Adding New Line Cards to the Chassis

Certain guidelines must be followed when attempting to add a new line card to the chassis.

1. Ensure the firmware version of the chassis will support the new line cards and their corresponding firmware.
2. Remove line cards which cause a compatibility issue before adding the new line cards. See the next section for more information on line card compatibility.
3. Perform a system reset on the chassis before updating the firmware code of the new line cards. See the next section for more information regarding updating firmware for the chassis and the Switch.

Upgrading to R2.50-B12

For this firmware version, some procedures and implementations have changed since the previous firmware release. **Failure to follow these rules may lead to compatibility problems and inoperability of the Switch.** Please see the guide below for detailed information regarding the proper firmware upgrade procedure.

PROM Code

We strongly recommend that the user upgrade the PROM (Programmable Read Only Memory) code to R2.00-B20. Before upgrading the PROM code, the user MSUT first upgrade the runtime firmware for both the CPU and any line cards set in the DES-6500 to R2.0, R2.5 or later. These upgrades can be performed through a TFTP server application, yet the PROM code itself must be upgraded through the CLI interface only.

Firmware Filenames

For the DES-6500 chassis switch and associated line cards, there are two different Runtime Code filenames which must be correctly specified when upgrading either the CPU or the line cards. A capital **S** in the firmware filename (6500r**S**_2.50-B12.had) indicates the firmware is for the line card only, while a capital **U** (6500r**U**_2.50-B12.had) indicates the firmware is for the CPU card only. When downloading the firmware, be sure to specify in the CLI command or through the web, whether the firmware is for the CPU or the line card. Downloading the incorrect firmware will cause problems with the Switch.



Failing to follow this procedure will cause problems with the switch and the supported line cards. All Prom code versions (R0.00-B15, R0.00-B16, R1.50-B19 and R2.00-B20) are compatible with all firmware versions of the chassis and line cards. In addition, we strongly recommend that the user upgrade the PROM code to the latest release for maximum functionality of the chassis and the installed line cards.

Upgrading to R2.50-B12

To upgrade the firmware Runtime Code to R2.50-B12, follow the steps below to guide you through the firmware upgrading process. **Remember the CPU firmware runtime code must be downloaded to the Switch before the line card firmware Runtime code or the PROM code is downloaded.**

Step 1

Power on the chassis and check the Firmware version currently set in the Switch by entering the “**show switch**” command into the CLI interface, as shown below.

```
DES-6500:4#show switch
Command: show switch

Device Type       : DES-6500 Chassis Ethernet Switch
MAC Address       : DA-10-21-00-00-01
IP Address        : 10.41.44.22 (Manual)
VLAN Name         : default
Subnet Mask       : 255.0.0.0
Default Gateway   : 0.0.0.0
Boot PROM Version : Build 1.50-B19
Firmware Version  : Build 2.00-B20
Hardware Version  : 2A1
Device S/N        :
System Name       : DES-6500_#3
System Location   : 7th_flr_east_cabinet
System Contact    : Julius_Erving_212-555-6666
Spanning Tree     : Disabled
GVRP              : Disabled
IGMP Snooping    : Disabled
802.1X           : Disabled
Jumbo Frame       : Off
Clipaging         : Enabled
Port Mirror       : Disabled
SNTP              : Disabled
Boot Relay        : Disabled
DNSR Status       : Disabled
VRRP              : Disabled
DVMRP             : Disabled
PIM-DM           : Disabled
RIP               : Disabled
OSPF              : Disabled
TELNET           : Enabled (TCP 23)
WEB               : Enabled (TCP 80)
RMON              : Enabled
HOL Prevention State : Enabled
Syslog Global State : Disabled

DES-6500:4#
```

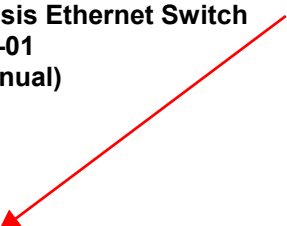

Once you have verified your Firmware version, check the “**show stack_information**” command in the CLI interface to view the runtime codes of the line card modules set in the Switch.

```
DES-6500:4#show stack_information
Command: show stack_information

Box ID      Type          Exist  Prio-  Prom   Runtime  H/W
---  -----  ---  rity   version  version  version
1      DES-6505    exist  16    0.00-B16 2.00-B20 0A1
2      DES-6507    exist  16    0.00-B16 2.00-B20 3A1
3      USR-NOT-CFG no
4      DES-6508    exist  16    1.50-B19 2.00-B20 0A1
5      DES-6508    exist  16    1.50-B19 2.00-B20 0A1
6      DES-6507    exist  16    1.50-B19 2.00-B20 2A1
7      DES-6504    exist  16    2.00-B20 2.00-B20 2A1
8      USR-NOT-CFG no

-----
Topology      :STAR
Current state :MASTER
Box Count     :6

DES-6500:4#
```

Step 2

Upgrade the CPU firmware R2.50-B12, as shown below.

```
DES-6500:4#download firmware_fromTFTP 10.48.74.121 c:/6500rU_2.50-B12.had unit cpu
Command: download firmware_fromTFTP 10.48.74.121 c:/6500rU_2.50-B12.had unit cpu

Connecting to server..... Done.
Download firmware..... Done. Do not power off!
Please wait, programming flash.....Done.
Saving current settings to NV-RAM.....Done.
Please wait, the switch is rebooting...
```

Step 3

Once rebooted, check the “**show switch**” command to verify that the firmware was downloaded correctly. The user can then upgrade the Runtime Version code for the inserted line cards using the following syntax in the CLI.

```
DES-6500:4#download firmware_fromTFTP 10.48.74.121 c:/6500rS_2.50-B12.had unit all_line_card
Command: download firmware_fromTFTP 10.48.74.121 c:/6500rS_2.50-B12.had unit all_line_card

Connecting to server..... Done.
Download firmware..... Done.
Connecting to slave.....Done.
Upload firmware .....Done.
Line card will automatically reboot after a few minutes. Please don't power off!
Success.

DES-6500:4#
```



Before installing the DES-6512 line card, the user must upgrade the CPU and line card runtime firmware codes to R2.50-B12. Failure to do this may result in inoperability of the switch and/or inserted line cards.

Step 5

Once the line cards have rebooted, check the “**show stack_information**” command in the CLI to verify all line cards are now holding the same firmware version as the CPU. If there is a discrepancy in any line card, the user must again repeat the download firmware process for the line cards in question.

Step 6

After confirming all firmware runtime codes are the same, the user must download the PROM code through a TFTP server. Although the same PROM code is to be used for both line cards and the CPU, the user must download the PROM code to both the CPU and the line cards separately. This may be done in any order preferable to the user but two downloads must take place, as shown below.

```
DES-6500:4#download firmware_fromTFTP 10.48.74.121 c:/DES6500_PROM_B20.had unit all_line_card
Command: download firmware_fromTFTP 10.48.74.121 c:/DES6500_PROM_B20.had unit all_line_card
```

```
Connecting to server..... Done.
Download firmware..... Done.
Connecting to slave.....Done.
Upload firmware.....Done.
Line card will automatically reboot after a few minutes. Please don't power off!
Success.
```

```
DES-6500:4#
```

```
DES-6500:4#download firmware_fromTFTP 10.48.74.121 c:/DES6500_PROM_B20.had unit cpu
Command: download firmware_fromTFTP 10.48.74.121 c:/DES6500_PROM_B20.had unit cpu
```

```
Connecting to server..... Done.
Download firmware..... Done. Do not power off!
Please wait, programming flash.....Done.
Saving current settings to NV-RAM.....Done.
Please wait, the switch is rebooting...
```

Step 7

Once the whole system has been upgraded to R2.50-B12 with PROM code R2.00-B20, the user may verify all downloads have been successful by checking the “**show switch**” and “**show stack_information**” commands in the CLI one final time. These commands should look similar to the ones shown below.

```
DES-6500:4#show stack_information
Command: show stack_information

Box ID      Type           Exist  Priority  Prom version  Runtime version  H/W version
---  -----  ----  -
1      DES-6505     exist   16    2.00-B20  2.50-B12  0A1
2      DES-6507     exist   16    2.00-B20  2.50-B12  3A1
3      USR-NOT-CFG  no
4      DES-6508     exist   16    2.00-B20  2.50-B12  0A1
5      DES-6508     exist   16    2.00-B20  2.50-B12  0A1
6      DES-6507     exist   16    2.00-B20  2.50-B12  2A1
7      DES-6504     exist   16    2.00-B20  2.50-B12  2A1
8      USR-NOT-CFG  no

-----
Topology      :STAR
Current state :MASTER
Box Count     :6

DES-6500:4#
```

```
DES-6500:4#show switch
Command: show switch

Device Type       : DES-6500 Chassis Ethernet Switch
MAC Address       : DA-10-21-00-00-01
IP Address        : 10.41.44.22 (Manual)
VLAN Name         : default
Subnet Mask       : 255.0.0.0
Default Gateway   : 0.0.0.0
Boot PROM Version : Build 2.00-B20
Firmware Version  : Build 2.50-B12
Hardware Version  : 2A1
Device S/N        :
System Name       : DES-6500_#3
System Location   : 7th_flr_east_cabinet
System Contact    : Julius_Erving_212-555-6666
Spanning Tree     : Disabled
GVRP              : Disabled
IGMP Snooping    : Disabled
802.1X            : Disabled
Jumbo Frame       : Off
Clipaging         : Enabled
Port Mirror       : Disabled
SNTP              : Disabled
Boot Relay        : Disabled
DNSR Status       : Disabled
VRRP              : Disabled
DVMRP             : Disabled
PIM-DM           : Disabled
RIP               : Disabled
OSPF              : Disabled
TELNET            : Enabled (TCP 23)
WEB               : Enabled (TCP 80)
RMON              : Enabled
HOL Prevention State : Enabled
Syslog Global State : Disabled

DES-6500:4#
```

Adding Runtime R1.01 DES-6505/DES-6507/DES-6509 Line Cards to the Runtime R1.30/1.4/2.0/2.5 Chassis

For owners of the DES-6500 chassis switch, certain software incongruencies have surfaced with the adding and removing new line cards in the chassis. If a DES-6500 chassis switch has been uploaded with R1.30/1.4/2.0/2.5 or later runtime code, and yet line cards DES-6505/DES-6507/DES-6509 are R1.01, line cards DES-6504/DES-6508/DES-6510/DES-6512 cannot be recognized by the chassis' CPU. To solve this problem, first remove the DES-6504/DES-6508/DES-6510/DES-6512 line cards from the chassis, upgrade the DES-6505/DES-6507/DES-6509 to R1.30/1.4/2.0/2.5 and then re-insert the DES-6504/DES-6508/DES-6510/DES-6512 line cards into the chassis. The system should be recovered and the chassis should function normally. Follow the following steps to guide you through the process.

Step 1

Execute the "show switch" command to confirm the CPU firmware status currently set on the chassis.

```

DES-6500:4#show switch
Command: show switch

Device Type       : DES-6500 Chassis Ethernet Switch
MAC Address       : DA-10-21-00-00-01
IP Address        : 10.41.44.22 (Manual)
VLAN Name         : default
Subnet Mask       : 255.0.0.0
Default Gateway   : 0.0.0.0
Boot PROM Version : Build 2.00-B20
Firmware Version  : Build 2.50-B12
Hardware Version  : 2A1
Device S/N        :
System Name       : DES-6500_#3
System Location   : 7th_flr_east_cabinet
System Contact    : Julius_Erving_212-555-6666
Spanning Tree     : Disabled
GVRP              : Disabled
IGMP Snooping    : Disabled
802.1X           : Disabled
Jumbo Frame       : Off
Clipaging         : Enabled
Port Mirror       : Disabled
SNTP              : Disabled
Boot Relay        : Disabled
DNSR Status       : Disabled
VRRP              : Disabled
DVMRP             : Disabled
PIM-DM           : Disabled
RIP               : Disabled
OSPF              : Disabled
TELNET           : Enabled (TCP 23)
WEB               : Enabled (TCP 80)
RMON              : Enabled
HOL Prevention State : Enabled
Syslog Global State : Disabled

DES-6500:4#

```

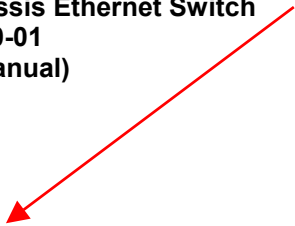

Step 2

Remove all DES-6504/DES-6508/DES-6510/DES-6512 line cards from the slots in the chassis switch. Next enter the “**reset system**” command and the whole system should reboot with stacking in tact. Enter the “**show stack_information**” command to verify that the switch has completely removed the line card from the chassis.

```
DES-6500:4#reset system
```

```
Command: reset system
```

```
Are you sure you want to proceed with the system reset? (y/n)
```

```
(reset all, save, reboot) y
```

```
Reboot & Load Factory Default Configuration.....
```

```
Saving all configurations to NV-RAM.....Done
```

```
DES-6500:4#show stack_information
```

```
Command: show stack_information
```

Box ID	Type	Exist	Prio- rity	Prom version	Runtime version	H/W version
1	DES-6505	exist	16	2.00-B20	2.50-B12	0A1
2	DES-6507	exist	16	2.00-B20	2.50-B12	3A1
3	USR-NOT-CFG	no				
4	USR-NOT-CFG	no				
5	USR-NOT-CFG	no				
6	USR-NOT-CFG	no				
7	USR-NOT-CFG	no				
8	USR-NOT-CFG	no				

```
-----
Topology      :STAR
Current state :MASTER
Box Count     :2
```

```
DES-6500:4#
```

Step 3

After removing the DES-6504/DES-6508/DES-6510/DES-6512 line cards from the switch, enter the new DES-6505/DES-6507/DES-6509 into the chassis. Check the “**show stack_information**” command again to see if the new line card(s) are recognized by the switch.

```
DES-6500:4#show stack_information
Command: show stack_information

Box ID      Type          Exist  Prio- Prom  Runtime  H/W
---  -----  ----  rity  version  version  version
1     DES-6505    exist  16    2.00-B20 2.50-B12 0A1
2     DES-6507    exist  16    2.00-B20 2.50-B12 3A1
3     USR-NOT-CFG no
4     USR-NOT-CFG no
5     USR-NOT-CFG no
6     DES-6507    exist  16    0.00-B16 1.01-B37 2A1
7     USR-NOT-CFG no
8     USR-NOT-CFG no
-----
Topology    :STAR
Current state :MASTER
Box Count   :3

DES-6500:4#
```

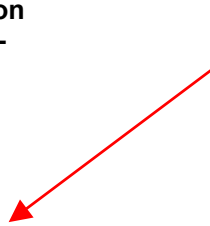
Step 4

Download the Runtime Version Code (R2.50-B12 for this example) to the new line card in the chassis.

```
DES-6500:4#download firmware_fromTFTP 10.48.74.121 c:/6500rS_2.50-B12.had unit 6
Command: download firmware_fromTFTP 10.48.74.121 c:/6500rS_2.50-B12.had unit 6

Connecting to server..... Done.
Download firmware..... Done.
Connecting to slave.....Done.
Upload firmware .....Done.
Line card will automatically reboot after a few minutes. Please don't power off!
Success.

DES-6500:4#
```

Step 5

Check the upgrade result with the “**show stack_information**” command.

```
DES-6500:4#show stack_information
Command: show stack_information
```

Box ID	Type	Exist	Priority	Prom version	Runtime version	H/W version
1	DES-6505	exist	16	2.00-B20	2.50-B12	0A1
2	DES-6507	exist	16	2.00-B20	2.50-B12	3A1
3	USR-NOT-CFG	no				
4	USR-NOT-CFG	no				
5	USR-NOT-CFG	no				
6	DES-6507	exist	16	0.00-B16	2.50-B12	2A1
7	USR-NOT-CFG	no				
8	USR-NOT-CFG	no				

```
-----
Topology      :STAR
Current state :MASTER
Box Count     :3

DES-6500:4#
```

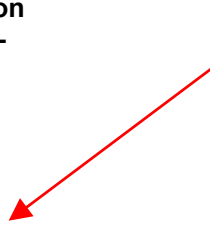
Step 6

Re-insert the DES-6504/DES-6508/DES-6510/DES-6512 line card(s) into the chassis and check the “**show stack_information**” one more time. All line cards should now be recognized by the Switch and they should all be showing the same firmware Runtime Version.

```
DES-6500:4#show stack_information
Command: show stack_information
```

Box ID	Type	Exist	Priority	Prom version	Runtime version	H/W version
1	DES-6505	exist	16	2.00-B20	2.50-B12	0A1
2	DES-6507	exist	16	2.00-B20	2.50-B12	3A1
3	DES-6510	exist	16	2.00-B20	2.50-B12	2A1
4	USR-NOT-CFG	no				
5	DES-6508	exist	16	2.00-B20	2.50-B12	2A1
6	DES-6507	exist	16	0.00-B16	2.50-B12	2A1
7	DES-6504	exist	16	2.00-B20	2.50-B12	2A1
8	DES-6512	exist	16	2.00-B20	2.50-B12	1A1

```
-----
Topology      :STAR
Current state :MASTER
Box Count     :7

DES-6500:4#
```

Firmware Downgrade Procedure

For users wishing to downgrade their firmware versions for the chassis CPU and corresponding line cards, there are certain guidelines and steps that need to be followed to ensure optimum functionality of the chassis and supported line cards. Failing to follow these rules may result in inoperability of the chassis and installed line cards. Please see the explanation below for more information regarding this subject.

Procedure Overview

1. **Before commencing with the firmware downgrade, the administrator must remove all line cards not supported for that firmware release.** (ex. If the user is downgrading to R1.20-B09, the DES-6504 line card must be removed from the chassis before beginning the firmware downgrade). See the **Line Card Firmware Compatibility** table at the beginning of this section for more information on line cards and their supported firmware versions.
2. After removing the unsupported line card, the user must execute the “**reset system**” command in the CLI interface. This will clear the configurations of the unsupported line card in the chassis.
3. Once the “reset System” command is executed and the removal is a success, the user may then download the lower version runtime code into the chassis CPU. **Remember to downgrade the installed line cards firmware before downgrading the chassis’ CPU firmware.** This downgrade order **MUST** be followed or compatibility issues will arise with the chassis and the line cards and may render your chassis inoperable.
4. Finally, the user must once again execute the “**reset system**” command into the CLI interface.

Downgrade Example

This downgrade example will refer to the downgrade procedure from R2.00-B20 to R1.20-B09 but is universal to all firmware downgrade procedures for the DES-6500 chassis switch.

Step1

Power on the chassis and once it has booted completely, enter the “**show switch**” command into the CLI interface to view the firmware version of the CPU runtime code currently employed in the chassis.

```
DES-6500:4#show switch
Command: show switch

Device Type       : DES-6500 Chassis Ethernet Switch
MAC Address       : DA-10-21-00-00-01
IP Address        : 10.41.44.22 (Manual)
VLAN Name         : default
Subnet Mask       : 255.0.0.0
Default Gateway   : 0.0.0.0
Boot PROM Version : Build 2.00-B20
Firmware Version  : Build 2.00-B20
Hardware Version  : 2A1
Device S/N        :
System Name       : DES-6500_#3
System Location   : 7th_flr_east_cabinet
System Contact    : Julius_Erving_212-555-6666
Spanning Tree     : Disabled
GVRP              : Disabled
IGMP Snooping    : Disabled
802.1X           : Disabled
Jumbo Frame       : Off
Clipaging         : Enabled
Port Mirror       : Disabled
SNTP              : Disabled
Boot Relay        : Disabled
DNSR Status       : Disabled
VRRP              : Disabled
DVMRP             : Disabled
PIM-DM           : Disabled
RIP               : Disabled
OSPF              : Disabled
TELNET           : Enabled (TCP 23)
WEB               : Enabled (TCP 80)
RMON              : Enabled
HOL Prevention State : Enabled
Syslog Global State : Disabled

DES-6500:4#
```

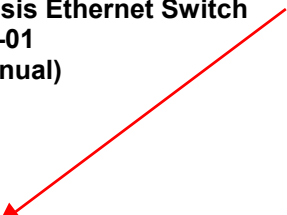

Step 2

Next enter the “**show stack_information**” command into the CLI to display the Runtime Version Code of the line cards currently set in the chassis.

```
DES-6500:4#show stack_information
Command: show stack_information
```

Box ID	Type	Exist	Prio- rity	Prom version	Runtime version	H/W version
1	DES-6505	exist	16	2.00-B20	2.00-B20	0A1
2	DES-6507	exist	16	2.00-B20	2.00-B20	2A1
3	DES-6510	exist	16	2.00-B20	2.00-B20	0A1
4	USR-NOT-CFG	no				
5	DES-6508	exist	16	2.00-B20	2.00-B20	0A1
6	DES-6507	exist	16	2.00-B20	2.00-B20	2A1
7	DES-6504	exist	16	2.00-B20	2.00-B20	0A1
8	USR-NOT-CFG	no				

```
-----
Topology      :STAR
Current state :MASTER
Box Count     :6

DES-6500:4#
```

Step 3

Remove unsupported line cards from the chassis (in this case, the DES-6504 line card for downgrade to 1.20-B09). Next enter the “**reset system**” command and the whole system should reboot with stacking in tact. Enter the “**show stack_information**” command again to verify that the switch has completely removed the line card from the chassis.

```
DES-6500:4#show stack_information
Command: show stack_information
```

Box ID	Type	Exist	Prio- rity	Prom version	Runtime version	H/W version
1	DES-6505	exist	16	2.00-B20	2.00-B20	0A1
2	DES-6507	exist	16	2.00-B20	2.00-B20	2A1
3	DES-6510	exist	16	2.00-B20	2.00-B20	0A1
4	USR-NOT-CFG	no				
5	DES-6508	exist	16	2.00-B20	2.00-B20	0A1
6	DES-6507	exist	16	2.00-B20	2.00-B20	2A1
7	DES-6504	no				
8	USR-NOT-CFG	no				

```
-----
Topology      :STAR
Current state :MASTER
Box Count     :5

DES-6500:4#
```

```
DES-6500:4#reset system
```

```
Command: reset system
```

```
Are you sure you want to proceed with the system reset?(y/n)
```

```
(reset all, save, reboot) y
```

```
Reboot & Load Factory Default Configuration...
```

```
Saving all configurations to NV-RAM..... Done
```

```
DES-6500:4#show stack_information
```

```
Command: show stack_information
```

Box ID	Type	Exist	Prio- rity	Prom version	Runtime version	H/W version
1	DES-6505	exist	16	2.00-B20	2.00-B20	0A1
2	DES-6507	exist	16	2.00-B20	2.00-B20	2A1
3	DES-6510	exist	16	2.00-B20	2.00-B20	0A1
4	USR-NOT-CFG	no				
5	DES-6508	exist	16	2.00-B20	2.00-B20	0A1
6	DES-6507	exist	16	2.00-B20	2.00-B20	2A1
7	USR-NOT-CFG	no				
8	USR-NOT-CFG	no				

```
-----
Topology      :STAR
Current state :MASTER
Box Count     :5
```

```
DES-6500:4#
```

Step 4

Download the line card Runtime Code Version R1.20-B09 to the available line cards in the chassis.

```
DES-6500:4#download firmware_fromTFTP 10.48.74.121 c:/6500rS_1.20-B09.had unit all_line_card
Command: download firmware_fromTFTP 10.48.74.121 c:/6500rS_1.20-B09.had unit all_line_card
```

```
Connecting to server..... Done.
```

```
Download firmware..... Done.
```

```
Connecting to slave.....Done.
```

```
Upload firmware .....Done.
```

```
Line card will automatically reboot after a few minutes. Please don't power off!
```

```
Success.
```

Step 5

After the chassis reboots and returns to normal operation and stacking configuration, download Runtime Code Version R1.20-B09 to the chassis CPU.

```
DES-6500:4#download firmware_fromTFTP 10.48.74.121 c:/6500rU_1.20-B09.had unit cpu
Command: download firmware_fromTFTP 10.48.74.121 c:/6500rU_1.20-B09.had unit cpu

Connecting to server..... Done.
Download firmware..... Done.
Connecting to slave.....Done.
Upload firmware .....Done.
Line card will automatically reboot after a few minutes. Please don't power off!
Success.

DES-6500:4#
```

Step 6

Once the CPU and all line cards have been downgraded, the user may verify that all downloads have been successfully completed by entering the “**show switch**” command and the “**show stack_information**” command.

```
DES-6500:4#show stack_information
Command: show stack_information
```

Box ID	Type	Exist	Prio- rity	Prom version	Runtime version	H/W version
1	DES-6505	exist	16	2.00-B20	1.20-B09	0A1
2	DES-6507	exist	16	2.00-B20	1.20-B09	2A1
3	DES-6510	exist	16	2.00-B20	1.20-B09	0A1
4	USR-NOT-CFG	no				
5	DES-6508	exist	16	2.00-B20	1.20-B09	0A1
6	DES-6507	exist	16	2.00-B20	1.20-B09	2A1
7	USR-NOT-CFG	no				
8	USR-NOT-CFG	no				

```
-----
Topology      :STAR
Current state :MASTER
Box Count     :5

DES-6500:4#
```

```
DES-6500:4#show switch
Command: show switch

Device Type       : DES-6500 Chassis Ethernet Switch
MAC Address       : DA-10-21-00-00-01
IP Address        : 10.41.44.22 (Manual)
VLAN Name         : default
Subnet Mask       : 255.0.0.0
Default Gateway   : 0.0.0.0
Boot PROM Version : Build 2.00-B20
Firmware Version  : Build 1.20-B09
Hardware Version  : 2A1
Device S/N        :
System Name       : DES-6500_#3
System Location   : 7th_flr_east_cabinet
System Contact    : Julius_Erving_212-555-6666
Spanning Tree     : Disabled
GVRP              : Disabled
IGMP Snooping     : Disabled
802.1X            : Disabled
Jumbo Frame       : Off
Clipaging         : Enabled
Port Mirror       : Disabled
SNTP              : Disabled
Boot Relay        : Disabled
DNSR Status       : Disabled
VRRP              : Disabled
DVMRP             : Disabled
PIM-DM           : Disabled
RIP               : Disabled
OSPF              : Disabled
TELNET            : Enabled (TCP 23)
WEB               : Enabled (TCP 80)
RMON              : Enabled
HOL Prevention State : Enabled
Syslog Global State : Disabled

DES-6500:4#
```

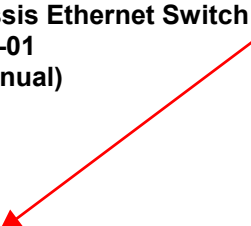

Appendix C

Cables and Connectors

When connecting the Switch to another switch, a bridge or hub, a normal cable is necessary. Please review these products for matching cable pin assignment.

The following diagrams and tables show the standard RJ-45 receptacle/connector and their pin assignments.

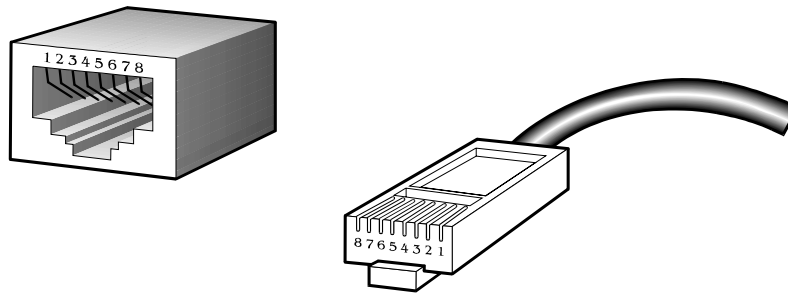

Appendix 1- 1. The standard RJ-45 port and connector

RJ-45 Pin Assignments		
Contact	MDI-X Port	MDI-II Port
1	BI-DB+	BI-DA+
2	BI-DB-	BI-DA-
3	BI-DA+	BI-DB+
4	BI-DD+	BI-DC+
5	BI-DD-	BI-DC-
6	BI-DA-	BI-DB-
7	BI-DC+	BI-DD+
8	BI-DC-	BI-DD+

Appendix 1- 2. The standard RJ-45 pin assignments

Appendix D

Cable Lengths

Use the following table to as a guide for the maximum cable lengths.

Standard	Media Type	Maximum Distance
Mini-GBIC	1000BASE-LX, Single-mode fiber module	10km
	1000BASE-SX, Multi-mode fiber module	550m
	1000BASE-LHX, Single-mode fiber module	40km
	1000BASE-ZX, Single-mode fiber module	80km
1000BASE-T	Category 5e UTP Cable	100m
	Category 5 UTP Cable (1000 Mbps)	
100BASE-TX	Category 5 UTP Cable (100 Mbps)	100m
10BASE-T	Category 3 UTP Cable (10 Mbps)	100m

Glossary

1000BASE-LX: A short laser wavelength on multimode fiber optic cable for a maximum length of 550 meters

1000BASE-SX: A long wavelength for a "long haul" fiber optic cable for a maximum length of 10 kilometers

100BASE-FX: 100Mbps Ethernet implementation over fiber.

100BASE-TX: 100Mbps Ethernet implementation over Category 5 and Type 1 Twisted Pair cabling.

10BASE-T: The IEEE 802.3 specification for Ethernet over Unshielded Twisted Pair (UTP) cabling.

ageing: The automatic removal of dynamic entries from the Switch Database which have timed-out and are no longer valid.

ATM: Asynchronous Transfer Mode. A connection oriented transmission protocol based on fixed length cells (packets). ATM is designed to carry a complete range of user traffic, including voice, data and video signals.

auto-negotiation: A feature on a port which allows it to advertise its capabilities for speed, duplex and flow control. When connected to an end station that also supports auto-negotiation, the link can self-detect its optimum operating setup.

backbone port: A port which does not learn device addresses, and which receives all frames with an unknown address. Backbone ports are normally used to connect the Switch to the backbone of your network. Note that backbone ports were formerly known as designated downlink ports.

backbone: The part of a network used as the primary path for transporting traffic between network segments.

bandwidth: Information capacity, measured in bits per second, that a channel can transmit. The bandwidth of Ethernet is 10Mbps, the bandwidth of Fast Ethernet is 100Mbps.

baud rate: The switching speed of a line. Also known as line speed between network segments.

BOOTP: The BOOTP protocol allows you to automatically map an IP address to a given MAC address each time a device is started. In addition, the protocol can assign the subnet mask and default gateway to a device.

bridge: A device that interconnects local or remote networks no matter what higher level protocols are involved. Bridges form a single logical network, centralizing network administration.

broadcast: A message sent to all destination devices on the network.

broadcast storm: Multiple simultaneous broadcasts that typically absorb available network bandwidth and can cause network failure.

console port: The port on the Switch accepting a terminal or modem connector. It changes the parallel arrangement of data within computers to the serial form used on data transmission links. This port is most often used for dedicated local management.

CSMA/CD: Channel access method used by Ethernet and IEEE 802.3 standards in which devices transmit only after finding the data channel clear for some period of time. When two devices transmit simultaneously, a collision occurs and the colliding devices delay their retransmissions for a random amount of time.

data center switching: The point of aggregation within a corporate network where a switch provides high-performance access to server farms, a high-speed backbone connection and a control point for network management and security.

Ethernet: A LAN specification developed jointly by Xerox, Intel and Digital Equipment Corporation. Ethernet networks operate at 10Mbps using CSMA/CD to run over cabling.

Fast Ethernet: 100Mbps technology based on the Ethernet/CD network access method.

Flow Control: (IEEE 802.3z) A means of holding packets back at the transmit port of the connected end station. Prevents packet loss at a congested switch port.

forwarding: The process of sending a packet toward its destination by an internetworking device.

full duplex: A system that allows packets to be transmitted and received at the same time and, in effect, doubles the potential throughput of a link.

half duplex: A system that allows packets to be transmitted and received, but not at the same time. Contrast with full duplex.

IP address: Internet Protocol address. A unique identifier for a device attached to a network using TCP/IP. The address is written as four octets separated with full-stops (periods), and is made up of a network section, an optional subnet section and a host section.

IPX: Internetwork Packet Exchange. A protocol allowing communication in a NetWare network.

LAN - Local Area Network: A network of connected computing resources (such as PCs, printers, servers) covering a relatively small geographic area (usually not larger than a floor or building). Characterized by high data rates and low error rates.

latency: The delay between the time a device receives a packet and the time the packet is forwarded out of the destination port.

line speed: See baud rate.

main port: The port in a resilient link that carries data traffic in normal operating conditions.

MDI - Medium Dependent Interface: An Ethernet port connection where the transmitter of one device is connected to the receiver of another device.

MDI-X - Medium Dependent Interface Cross-over: An Ethernet port connection where the internal transmit and receive lines are crossed.

MIB - Management Information Base: Stores a device's management characteristics and parameters. MIBs are used by the Simple Network Management Protocol (SNMP) to contain attributes of their managed systems. The Switch contains its own internal MIB.

multicast: Single packets copied to a specific subset of network addresses. These addresses are specified in the destination-address field of the packet.

protocol: A set of rules for communication between devices on a network. The rules dictate format, timing, sequencing and error control.

resilient link: A pair of ports that can be configured so that one will take over data transmission should the other fail. See also main port and standby port.

RJ-45: Standard 8-wire connectors for IEEE 802.3 10BASE-T networks.

RMON: Remote Monitoring. A subset of SNMP MIB II that allows monitoring and management capabilities by addressing up to ten different groups of information.

RPS - Redundant Power System: A device that provides a backup source of power when connected to the Switch.

server farm: A cluster of servers in a centralized location serving a large user population.

SLIP - Serial Line Internet Protocol: A protocol which allows IP to run over a serial line connection.

SNMP - Simple Network Management Protocol: A protocol originally designed to be used in managing TCP/IP internets. SNMP is presently implemented on a wide range of computers and networking equipment and may be used to manage many aspects of network and end station operation.

Spanning Tree Protocol (STP): A bridge-based system for providing fault tolerance on networks. STP works by allowing you to implement parallel paths for network traffic, and ensure that redundant paths are disabled when the main paths are operational and enabled if the main paths fail.

stack: A group of network devices that are integrated to form a single logical device.

standby port: The port in a resilient link that will take over data transmission if the main port in the link fails.

switch: A device which filters, forwards and floods packets based on the packet's destination address. The switch learns the addresses associated with each switch port and builds tables based on this information to be used for the switching decision.

TCP/IP: A layered set of communications protocols providing Telnet terminal emulation, FTP file transfer, and other services for communication among a wide range of computer equipment.

telnet: A TCP/IP application protocol that provides virtual terminal service, letting a user log in to another computer system and access a host as if the user were connected directly to the host.

TFTP - Trivial File Transfer Protocol: Allows you to transfer files (such as software upgrades) from a remote device using your switch's local management capabilities.

UDP - User Datagram Protocol: An Internet standard protocol that allows an application program on one device to send a datagram to an application program on another device.

VLAN - Virtual LAN: A group of location- and topology-independent devices that communicate as if they are on a common physical LAN.

VLT - Virtual LAN Trunk: A Switch-to-Switch link which carries traffic for all the VLANs on each Switch.

VT100: A type of terminal that uses ASCII characters. VT100 screens have a text-based appearance.

Warranties and Registration

LIMITED WARRANTY

D-Link provides this limited warranty for its product only to the person or entity who originally purchased the product from D-Link or its authorized reseller or distributor. D-Link would fulfill the warranty obligation according to the local warranty policy in which you purchased our products.

Limited Hardware Warranty: D-Link warrants that the hardware portion of the D-Link products described below (“Hardware”) will be free from material defects in workmanship and materials from the date of original retail purchase of the Hardware, for the period set forth below applicable to the product type (“Warranty Period”) if the Hardware is used and serviced in accordance with applicable documentation; provided that a completed Registration Card is returned to an Authorized D-Link Service Office within ninety (90) days after the date of original retail purchase of the Hardware. If a completed Registration Card is not received by an authorized D-Link Service Office within such ninety (90) period, then the Warranty Period shall be ninety (90) days from the date of purchase.

<i>Product Type</i>	<i>Warranty Period</i>
Product (including Power Supplies and Fans)	One (1) Year
Spare parts and pare kits	Ninety (90) days

D-Link’s sole obligation shall be to repair or replace the defective Hardware at no charge to the original owner. Such repair or replacement will be rendered by D-Link at an Authorized D-Link Service Office. The replacement Hardware need not be new or of an identical make, model or part; D-Link may in its discretion may replace the defective Hardware (or any part thereof) with any reconditioned product that D-Link reasonably determines is substantially equivalent (or superior) in all material respects to the defective Hardware. The Warranty Period shall extend for an additional ninety (90) days after any repaired or replaced Hardware is delivered. If a material defect is incapable of correction, or if D-Link determines in its sole discretion that it is not practical to repair or replace the defective Hardware, the price paid by the original purchaser for the defective Hardware will be refunded by D-Link upon return to D-Link of the defective Hardware. All Hardware (or part thereof) that is replaced by D-Link, or for which the purchase price is refunded, shall become the property of D-Link upon replacement or refund.

Limited Software Warranty: D-Link warrants that the software portion of the product (“Software”) will substantially conform to D-Link’s then current functional specifications for the Software, as set forth in the applicable documentation, from the date of original delivery of the Software for a period of ninety (90) days (“Warranty Period”), if the Software is properly installed on approved hardware and operated as contemplated in its documentation. D-Link further warrants that, during the Warranty Period, the magnetic media on which D-Link delivers the Software will be free of physical defects. D-Link’s sole obligation shall be to replace the non-conforming Software (or defective media) with software that substantially conforms to D-Link’s functional specifications for the Software. Except as otherwise agreed by D-Link in writing, the replacement Software is provided only to the original licensee, and is subject to the terms and conditions of the license granted by D-Link for the Software. The Warranty Period shall extend for an additional ninety (90) days after any replacement Software is delivered. If a material non-conformance is incapable of correction, or if D-Link determines in its sole discretion that it is not practical to replace the non-conforming Software, the price paid by the original licensee for the non-conforming Software will be refunded by D-Link; provided that the non-conforming Software (and all copies thereof) is first returned to D-Link. The license granted respecting any Software for which a refund is given automatically terminates.

What You Must Do For Warranty Service:

Registration Card. The Registration Card provided at the back of this manual must be completed and returned to an Authorized D-Link Service Office for each D-Link product within ninety (90) days after the product is purchased and/or licensed. The addresses/telephone/fax list of the nearest Authorized D-Link Service Office is provided in the back of this manual. FAILURE TO PROPERLY COMPLETE AND TIMELY RETURN THE REGISTRATION CARD MAY AFFECT THE WARRANTY FOR THIS PRODUCT.

Submitting A Claim. Any claim under this limited warranty must be submitted in writing before the end of the Warranty Period to an Authorized D-Link Service Office. The claim must include a written description of the Hardware defect or Software nonconformance in sufficient detail to allow D-Link to confirm the same. The original product owner must obtain a Return Material Authorization (RMA) number from the Authorized D-Link Service Office and, if requested, provide written proof of purchase of the product (such as a copy of the dated purchase invoice for the product) before the warranty service is provided. After an RMA number is issued, the defective product must be packaged securely in the original or other suitable shipping package to ensure that it will not be damaged in transit, and the RMA number must be prominently marked on the outside of the package. The packaged product shall be insured and shipped to Authorized D-Link Service Office with all shipping costs prepaid. D-Link may reject or return any product that is not packaged and shipped in strict compliance with the foregoing requirements, or for which an RMA number is not visible from the outside of the package. The product owner agrees to pay D-Link's reasonable handling and return shipping charges for any product that is not packaged and shipped in accordance with the foregoing requirements, or that is determined by D-Link not to be defective or non-conforming.

What Is Not Covered:

This limited warranty provided by D-Link does not cover:

Products that have been subjected to abuse, accident, alteration, modification, tampering, negligence, misuse, faulty installation, lack of reasonable care, repair or service in any way that is not contemplated in the documentation for the product, or if the model or serial number has been altered, tampered with, defaced or removed;

Initial installation, installation and removal of the product for repair, and shipping costs;

Operational adjustments covered in the operating manual for the product, and normal maintenance;

Damage that occurs in shipment, due to act of God, failures due to power surge, and cosmetic damage;

and Any hardware, software, firmware or other products or services provided by anyone other than D-Link.

Disclaimer of Other Warranties: EXCEPT FOR THE LIMITED WARRANTY SPECIFIED HEREIN, THE PRODUCT IS PROVIDED "AS-IS" WITHOUT ANY WARRANTY OF ANY KIND INCLUDING, WITHOUT LIMITATION, ANY WARRANTY OF MERCHANTABILITY, FITNESS FOR A PARTICULAR PURPOSE AND NON-INFRINGEMENT. IF ANY IMPLIED WARRANTY CANNOT BE DISCLAIMED IN ANY TERRITORY WHERE A PRODUCT IS SOLD, THE DURATION OF SUCH IMPLIED WARRANTY SHALL BE LIMITED TO NINETY (90) DAYS. EXCEPT AS EXPRESSLY COVERED UNDER THE LIMITED WARRANTY PROVIDED HEREIN, THE ENTIRE RISK AS TO THE QUALITY, SELECTION AND PERFORMANCE OF THE PRODUCT IS WITH THE PURCHASER OF THE PRODUCT.

Limitation of Liability: TO THE MAXIMUM EXTENT PERMITTED BY LAW, D-LINK IS NOT LIABLE UNDER ANY CONTRACT, NEGLIGENCE, STRICT LIABILITY OR OTHER LEGAL OR EQUITABLE THEORY FOR ANY LOSS OF USE OF THE PRODUCT, INCONVENIENCE OR DAMAGES OF ANY CHARACTER, WHETHER DIRECT, SPECIAL, INCIDENTAL OR CONSEQUENTIAL (INCLUDING, BUT NOT LIMITED TO, DAMAGES FOR LOSS OF GOODWILL, WORK STOPPAGE, COMPUTER FAILURE OR MALFUNCTION, LOSS OF INFORMATION OR DATA CONTAINED IN, STORED ON, OR INTEGRATED WITH ANY PRODUCT RETURNED TO D-LINK FOR WARRANTY SERVICE) RESULTING FROM THE USE OF THE PRODUCT, RELATING TO WARRANTY SERVICE, OR ARISING OUT OF ANY BREACH OF THIS LIMITED WARRANTY, EVEN IF D-LINK HAS BEEN ADVISED OF THE POSSIBILITY OF SUCH DAMAGES. THE SOLE REMEDY FOR A BREACH OF THE FOREGOING LIMITED WARRANTY IS REPAIR, REPLACEMENT OR REFUND OF THE DEFECTIVE OR NON-CONFORMING PRODUCT.

GOVERNING LAW: This Limited Warranty shall be governed by the laws of the state of California.

Some states do not allow exclusion or limitation of incidental or consequential damages, or limitations on how long an implied warranty lasts, so the foregoing limitations and exclusions may not apply. This limited warranty provides specific legal rights and the product owner may also have other rights which vary from state to state.

Trademarks

Copyright 2005 D-Link Corporation. Contents subject to change without prior notice. D-Link is a registered trademark of D-Link Corporation/D-Link Systems, Inc. All other trademarks belong to their respective proprietors.

Copyright Statement

No part of this publication may be reproduced in any form or by any means or used to make any derivative such as translation, transformation, or adaptation without permission from D-Link Corporation/D-Link Systems Inc., as stipulated by the United States Copyright Act of 1976.

FCC Warning

This equipment has been tested and found to comply with the limits for a Class A digital device, pursuant to Part 15 of the FCC Rules. These limits are designed to provide reasonable protection against harmful interference when the equipment is operated in a commercial environment. This equipment generates, uses, and can radiate radio frequency energy and, if not installed and used in accordance with this manual, may cause harmful interference to radio communications. Operation of this equipment in a residential area is likely to cause harmful interference in which case the user will be required to correct the interference at his own expense.

Subject to the terms and conditions set forth herein, D-Link Systems, Inc. ("D-Link") provides this Limited Warranty:

- Only to the person or entity that originally purchased the product from D-Link or its authorized reseller or distributor, and
- Only for products purchased and delivered within the fifty states of the United States, the District of Columbia, U.S. Possessions or Protectorates, U.S. Military Installations, or addresses with an APO or FPO.

Limited Warranty: D-Link warrants that the hardware portion of the D-Link product described below ("Hardware") will be free from material defects in workmanship and materials under normal use from the date of original retail purchase of the product, for the period set forth below ("Warranty Period"), except as otherwise stated herein.

Limited Lifetime Warranty for the product is defined as follows:

- Hardware: For as long as the original customer/end user owns the product, or five (5) years after product discontinuance, whichever occurs first (excluding power supplies and fans)
- Power supplies and fans: Three (3) Year
- Spare parts and spare kits: Ninety (90) days

The customer's sole and exclusive remedy and the entire liability of D-Link and its suppliers under this Limited Warranty will be, at D-Link's option, to repair or replace the defective Hardware during the Warranty Period at no charge to the original owner or to refund the actual purchase price paid. Any repair or replacement will be rendered by D-Link at an Authorized D-Link Service Office. The replacement hardware need not be new or have an identical make, model or part. D-Link may, at its option, replace the defective Hardware or any part thereof with any reconditioned product that D-Link reasonably determines is substantially equivalent (or superior) in all material respects to the defective Hardware. Repaired or replacement hardware will be warranted for the remainder of the original Warranty Period or ninety (90) days, whichever is longer, and is subject to the same limitations and exclusions. If a material defect is incapable of correction, or if D-Link determines that it is not practical to repair or replace the defective Hardware, the actual price paid by the original purchaser for the defective Hardware will be refunded by D-Link upon return to D-Link of the defective Hardware. All Hardware or part thereof that is replaced by D-Link, or for which the purchase price is refunded, shall become the property of D-Link upon replacement or refund.

Limited Software Warranty: D-Link warrants that the software portion of the product ("Software") will substantially conform to D-Link's then current functional specifications for the Software, as set forth in the applicable documentation, from the date of original retail purchase of the Software for a period of ninety (90) days ("Software Warranty Period"), provided that the Software is properly installed on approved hardware and operated as contemplated in its documentation. D-Link further warrants that, during the Software Warranty Period, the magnetic media on which D-Link delivers the Software will be free of physical defects. The customer's sole and exclusive remedy and the entire liability of D-Link and its suppliers under this Limited Warranty will be, at D-Link's option, to replace the non-conforming Software (or defective media) with software that substantially conforms to D-Link's functional specifications for the Software or to refund the portion of the actual purchase price paid that is attributable to the Software. Except as otherwise agreed by D-Link in writing, the replacement Software is provided only to the original licensee, and is subject to the terms and conditions of the license granted by D-Link for the Software. Replacement Software will be warranted for the remainder of the original Warranty Period and is subject to the same limitations and exclusions. If a material non-conformance is incapable of correction, or if D-Link determines in its sole discretion that it is not practical to replace the non-conforming Software, the price paid by the original licensee for the non-conforming Software will be refunded by D-Link; provided that the non-conforming Software (and all copies thereof) is first returned to D-Link. The license granted respecting any Software for which a refund is given automatically terminates.

Non-Applicability of Warranty: The Limited Warranty provided hereunder for Hardware and Software portions of D-Link's products will not be applied to and does not cover any refurbished product and any product purchased through the inventory clearance or liquidation sale or other sales in which D-Link, the sellers, or the liquidators expressly disclaim their warranty obligation pertaining to the product and in that case, the product is being sold "As-Is" without any warranty whatsoever including, without limitation, the Limited Warranty as described herein, notwithstanding anything stated herein to the contrary.

Submitting A Claim: The customer shall return the product to the original purchase point based on its return policy. In case the return policy period has expired and the product is within warranty, the customer shall submit a claim to D-Link as outlined below:

- The customer must submit with the product as part of the claim a written description of the Hardware defect or Software nonconformance in sufficient detail to allow D-Link to confirm the same, along with proof of purchase of the product (such as a copy of the dated purchase invoice for the product) if the product is not registered.
- The customer must obtain a Case ID Number from D-Link Technical Support at 1-877-453-5465, who will attempt to assist the customer in resolving any suspected defects with the product. If the product is considered defective, the customer must obtain a Return Material Authorization ("RMA") number by completing the RMA form and entering the assigned Case ID Number at <https://rma.dlink.com/>.
- After an RMA number is issued, the defective product must be packaged securely in the original or other suitable shipping package to ensure that it will not be damaged in transit, and the RMA number must be prominently marked on the outside of the package. Do not include any manuals or accessories in the shipping package. D-Link will only replace the defective portion of the product and will not ship back any accessories.
- The customer is responsible for all in-bound shipping charges to D-Link. No Cash on Delivery ("COD") is allowed. Products sent COD will either be rejected by D-Link or become the property of D-Link. Products shall be fully insured by the customer and shipped to **D-Link Systems, Inc., 17595 Mt. Herrmann, Fountain Valley, CA 92708**. D-Link will not be held responsible for any packages that are lost in transit to D-Link. The repaired or replaced packages will be shipped to the customer via UPS Ground or any common carrier selected by D-Link. Return shipping charges shall be prepaid by D-Link if you use an address in the United States, otherwise we will ship the product to you freight collect. Expedited shipping is available upon request and provided shipping charges are prepaid by the customer.

D-Link may reject or return any product that is not packaged and shipped in strict compliance with the foregoing requirements, or for which an RMA number is not visible from the outside of the package. The product owner agrees to pay D-Link's reasonable handling and return shipping charges for any product that is not packaged and shipped in accordance with the foregoing requirements, or that is determined by D-Link not to be defective or non-conforming.

What Is Not Covered: The Limited Warranty provided herein by D-Link does not cover: Products that, in D-Link's judgment, have been subjected to abuse, accident, alteration, modification, tampering, negligence, misuse, faulty installation, lack of reasonable care, repair or service in any way that is not contemplated in the documentation for the product, or if the model or serial number has been altered, tampered with, defaced or removed; Initial installation, installation and removal of the product for repair, and shipping costs; Operational adjustments covered in the operating manual for the product, and normal maintenance; Damage that occurs in shipment, due to act of God, failures due to power surge, and cosmetic damage; Any hardware, software, firmware or other products or services provided by anyone other than D-Link; and Products that have been purchased from inventory clearance or liquidation sales or other sales in which D-Link, the sellers, or the liquidators expressly disclaim their warranty obligation pertaining to the product. While necessary maintenance or repairs on your Product can be performed by any company, we recommend that you use only an Authorized D-Link Service Office. Improper or incorrectly performed maintenance or repair voids this Limited Warranty.

Disclaimer of Other Warranties: EXCEPT FOR THE LIMITED WARRANTY SPECIFIED HEREIN, THE PRODUCT IS PROVIDED "AS-IS" WITHOUT ANY WARRANTY OF ANY KIND WHATSOEVER INCLUDING, WITHOUT LIMITATION, ANY WARRANTY OF MERCHANTABILITY, FITNESS FOR A PARTICULAR PURPOSE AND NON-INFRINGEMENT. IF ANY IMPLIED WARRANTY CANNOT BE DISCLAIMED IN ANY TERRITORY WHERE A PRODUCT IS SOLD, THE DURATION OF SUCH IMPLIED WARRANTY SHALL BE LIMITED TO NINETY (90) DAYS. EXCEPT AS EXPRESSLY COVERED UNDER THE LIMITED WARRANTY PROVIDED HEREIN, THE ENTIRE RISK AS TO THE QUALITY, SELECTION AND PERFORMANCE OF THE PRODUCT IS WITH THE PURCHASER OF THE PRODUCT.

Limitation of Liability: TO THE MAXIMUM EXTENT PERMITTED BY LAW, D-LINK IS NOT LIABLE UNDER ANY CONTRACT, NEGLIGENCE, STRICT LIABILITY OR OTHER LEGAL OR EQUITABLE THEORY FOR ANY LOSS OF USE OF THE PRODUCT, INCONVENIENCE OR DAMAGES OF ANY CHARACTER, WHETHER DIRECT, SPECIAL, INCIDENTAL OR CONSEQUENTIAL (INCLUDING, BUT NOT LIMITED TO, DAMAGES FOR LOSS OF GOODWILL, LOSS OF REVENUE OR PROFIT, WORK STOPPAGE, COMPUTER FAILURE OR MALFUNCTION, FAILURE OF OTHER EQUIPMENT OR COMPUTER PROGRAMS TO WHICH D-LINK'S PRODUCT IS CONNECTED WITH, LOSS OF INFORMATION OR DATA CONTAINED IN, STORED ON, OR INTEGRATED WITH ANY PRODUCT RETURNED TO D-LINK FOR WARRANTY SERVICE) RESULTING FROM THE USE OF THE PRODUCT, RELATING TO WARRANTY SERVICE, OR ARISING OUT OF ANY BREACH OF THIS LIMITED WARRANTY, EVEN IF D-LINK HAS BEEN ADVISED OF THE POSSIBILITY OF SUCH DAMAGES. THE SOLE REMEDY FOR A BREACH OF THE FOREGOING LIMITED WARRANTY IS REPAIR, REPLACEMENT OR REFUND OF THE DEFECTIVE OR NON-CONFORMING PRODUCT. THE MAXIMUM LIABILITY OF D-LINK UNDER THIS WARRANTY IS LIMITED TO THE PURCHASE PRICE OF THE PRODUCT COVERED BY THE WARRANTY. THE FOREGOING EXPRESS WRITTEN WARRANTIES AND REMEDIES ARE EXCLUSIVE AND ARE IN LIEU OF ANY OTHER WARRANTIES OR REMEDIES, EXPRESS, IMPLIED OR STATUTORY.

Governing Law: This Limited Warranty shall be governed by the laws of the State of California. Some states do not allow exclusion or limitation of incidental or consequential damages, or limitations on how long an implied warranty lasts, so the foregoing limitations and exclusions may not apply. This Limited Warranty provides specific legal rights and you may also have other rights which vary from state to state.

Trademarks: D-Link is a registered trademark of D-Link Systems, Inc. Other trademarks or registered trademarks are the property of their respective owners.

Copyright Statement: No part of this publication or documentation accompanying this product may be reproduced in any form or by any means or used to make any derivative such as translation, transformation, or adaptation without permission from D-Link Corporation/D-Link Systems, Inc., as stipulated by the United States Copyright Act of 1976 and any amendments thereto. Contents are subject to change without prior notice.
Copyright 2004 by D-Link Corporation/D-Link Systems, Inc. All rights reserved.

CE Mark Warning: This is a Class A product. In a residential environment, this product may cause radio interference, in which case the user may be required to take adequate measures.

FCC Statement: This equipment has been tested and found to comply with the limits for a Class A digital device, pursuant to part 15 of the FCC Rules. These limits are designed to provide reasonable protection against harmful interference in a commercial installation. This equipment generates, uses, and can radiate radio frequency energy and, if not installed and used in accordance with the instructions, may cause harmful interference to radio communication. However, there is no guarantee that interference will not occur in a particular installation. Operation of this equipment in a residential environment is likely to cause harmful interference to radio or television reception. If this equipment does cause harmful interference to radio or television reception, which can be determined by turning the equipment off and on, the user is encouraged to try to correct the interference by one or more of the following measures:

- Reorient or relocate the receiving antenna.
- Increase the separation between the equipment and receiver.
- Connect the equipment into an outlet on a circuit different from that to which the receiver is connected.
- Consult the dealer or an experienced radio/TV technician for help.

For detailed warranty information applicable to products purchased outside the United States, please contact the corresponding local D-Link office.

Product Registration

Register your D-Link product online at <http://support.dlink.com/register>

Product registration is entirely voluntary and failure to complete or return this form will not diminish your warranty rights.

D-Link Europe Limited Product Warranty

General Terms

The Limited Product Warranty set forth below is given by D-LINK (Europe) Ltd. (herein referred to as "D-LINK"). This Limited Product Warranty is only effective upon presentation of the proof of purchase. Upon further request by D-LINK, this warranty card has to be presented, too.

EXCEPT AS EXPRESSLY SET FORTH IN THIS LIMITED WARRANTY, D-LINK MAKES NO OTHER WARRANTIES, EXPRESS OR IMPLIED, INCLUDING ANY IMPLIED WARRANTIES OF MERCHANTABILITY AND FITNESS FOR A PARTICULAR PURPOSE. D-LINK EXPRESSLY DISCLAIMS ALL WARRANTIES NOT STATED IN THIS LIMITED WARRANTY. ANY IMPLIED WARRANTIES THAT MAY BE IMPOSED BY LAW ARE LIMITED IN DURATION TO THE LIMITED WARRANTY PERIOD. SOME STATES OR COUNTRIES DO NOT ALLOW A LIMITATION ON HOW LONG AN IMPLIED WARRANTY LASTS OR THE EXCLUSION OR LIMITATION OF INCIDENTAL OR CONSEQUENTIAL DAMAGES FOR CONSUMER PRODUCTS. IN SUCH STATES OR COUNTRIES, SOME EXCLUSIONS OR LIMITATIONS OF THIS LIMITED WARRANTY MAY NOT APPLY TO YOU. THIS LIMITED WARRANTY GIVES YOU SPECIFIC LEGAL RIGHTS. YOU MAY ALSO HAVE OTHER RIGHTS THAT MAY VARY FROM STATE TO STATE OR FROM COUNTRY TO COUNTRY. YOU ARE ADVISED TO CONSULT APPLICABLE STATE OR COUNTRY LAWS FOR

A FULL DETERMINATION OF YOUR RIGHTS.

This limited warranty applies to D-LINK branded hardware products (collectively referred to in this limited warranty as "D-LINK Hardware Products") sold by from D-LINK (Europe) Ltd., its worldwide subsidiaries, affiliates, authorized resellers, or country distributors (collectively referred to in this limited warranty as "D-LINK") with this limited warranty. The Term "D-LINK Hardware Product" is limited to the hardware components and all its internal components including firmware. The term "D-LINK Hardware Product" DOES NOT include any software applications or programs.

Geographical Scope of the Limited Product Warranty

This Limited Product Warranty is applicable in all European Countries as listed in the addendum "European Countries for D-LINK Limited Product Warranty". The term "European Countries" in this D-LINK Limited Product Warranty only include the countries as listed in this addendum. The Limited Product Warranty will be honored in any country where D-LINK or its authorized service providers offer warranty service subject to the terms and conditions set forth in this Limited Product Warranty. However, warranty service availability and response times may vary from country to country and may also be subject to registration requirements.

Limitation of Product Warranty

D-LINK warrants that the products described below under normal use are free from material defects in materials and workmanship during the Limited Product Warranty Period set forth below ("Limited Product Warranty Period"), if the product is used and serviced in accordance with the user manual and other documentation provided to the purchaser at the time of purchase (or as amended from time to time). D-LINK does not warrant that the products will operate uninterrupted or error-free or that all deficiencies, errors, defects or non-conformities will be corrected.

This warranty shall not apply to problems resulting from: (a) unauthorised alterations or attachments; (b) negligence, abuse or misuse, including failure to operate the product in accordance with specifications or interface requirements; (c) improper handling; (d) failure of goods or services not obtained from D-LINK or not subject to a then-effective D-LINK warranty or maintenance agreement; (e) improper use or storage; or (f) fire, water, acts of God or other catastrophic events. This warranty shall also not apply to any particular product if any D-LINK serial number has been removed or defaced in any way.

D-LINK IS NOT RESPONSIBLE FOR DAMAGE THAT OCCURS AS A RESULT OF YOUR FAILURE TO FOLLOW THE INSTRUCTIONS FOR THE D-LINK HARDWARE PRODUCT.

Limited Product Warranty Period

The Limited Product Warranty Period starts on the date of purchase from D-LINK. Your dated sales or delivery receipt, showing the date of purchase of the product, is your proof of the purchase date. You may be required to provide proof of purchase as a condition of receiving warranty service. You are entitled to warranty service according to the terms and conditions of this document if a repair to your D-LINK branded hardware is required within the Limited Product Warranty Period.

This Limited Product Warranty extends only to the original end-user purchaser of this D-LINK Hardware Product and is not transferable to anyone who obtains ownership of the D-LINK Hardware Product from the original end-user purchaser.

Product Type	Product Warranty Period
Managed Switches (i.e. switches with built in SNMP agent)(including modules and management software)	Five (5) years
All other products	Two (2) years
Spare parts (i.e. External Power Adapters, Fans)	One (1) year

The warranty periods listed above are effective in respect of all D-LINK products sold in European Countries by D-LINK or one of its authorized resellers or distributors from 1st of January 2004. All products sold in European Countries by D-LINK or one of its authorized resellers or distributors before 1st January 2004 carry 5 years warranty, except power supplies, fans and accessories that are provided with 2 year warranty.

The warranty period stated in this card supersedes and replaces the warranty period as stated in the user's manual or in the purchase contract for the relevant products. For the avoidance of doubt, if you have purchased the relevant D-LINK product as a consumer your statutory rights remain unaffected.

Performance of the Limited Product Warranty

If a product defect occurs, D-LINK's sole obligation shall be to repair or replace any defective product free of charge to the original purchaser provided it is returned to an Authorized D-LINK Service Center during the warranty period. Such repair or replacement will be rendered by D-LINK at an Authorized D-LINK Service Center. All component parts or hardware products removed under this limited warranty become the property of D-LINK. The replacement part or product takes on the remaining limited warranty status of the removed part or product. The replacement product need not be new or of an identical make, model or part; D-LINK may in its discretion replace the defective product (or any part thereof) with any reconditioned equivalent (or superior) product in all material respects to the defective product. Proof of purchase may be required by D-LINK.

Warrantor

D-Link (Europe) Ltd.
4th Floor, Merit House
Edgware Road
Colindale
London NW9 5 AB
United Kingdom

Telephone: +44-020-8731-5555

Facsimile: +44-020-8731-5511

www.dlink.co.uk

D-Link Europe Limited Produktgarantie

Allgemeine Bedingungen

Die hierin beschriebene eingeschränkte Garantie wird durch D-LINK (Europe) Ltd. gewährt (im Folgenden: „D-LINK“). Diese eingeschränkte Garantie setzt voraus, dass der Kauf des Produkts nachgewiesen wird. Auf Verlangen von D-LINK muss auch dieser Garantieschein vorgelegt werden.

AUSSER IN DEM HIER AUSDRÜCKLICH BESCHRIEBENEN UMFANG GEWÄHRT D-LINK KEINE WEITEREN GARANTIE, WEDER AUSDRÜCKLICH NOCH STILLSCHWEIGEND. INSBESONDERE WIRD NICHT STILLSCHWEIGEND EINE GARANTIE FÜR DIE ALLGEMEINE GEBRAUCHSTAUGLICHKEIT ODER DIE EIGNUNG FÜR EINEN BESTIMMTEN ZWECK ERKLÄRT. D-LINK LEHNT AUSDRÜCKLICH JEDE GARANTIE AB, DIE ÜBER DIESE EINGESCHRÄNKTE GARANTIE HINAUSGEHT. JEDE GESETZLICH ANGEORDNETE GARANTIE IST AUF DIE LAUFZEIT DER EINGESCHRÄNKTEN GARANTIE BESCHRÄNKT. IN EINIGEN STAATEN ODER LÄNDERN IST DIE ZEITLICHE BESCHRÄNKUNG EINER STILLSCHWEIGEND ERKLÄRTEN GARANTIE SOWIE AUSSCHLUSS ODER BESCHRÄNKUNG VON SCHADENERSATZ FÜR NEBEN- ODER FOLGESCHÄDEN BEIM VERBRAUCHSGÜTERKAUF UNTERSAGT. SOWEIT SIE IN SOLCHEN STAATEN ODER LÄNDERN LEBEN, ENTFALTEN MÖGLICHERWEISE EINIGE AUSSCHLÜSSE ODER EINSCHRÄNKUNGEN DIESER EINGESCHRÄNKTEN GARANTIE GEGENÜBER IHNEN KEINE WIRKUNG. DIESE EINGESCHRÄNKTE GARANTIE GEWÄHRT IHNEN SPEZIFISCHE RECHTE. DARÜBER HINAUS STEHEN IHNEN MÖGLICHERWEISE NOCH WEITERE RECHTE ZU, DIE SICH JEDOCH VON STAAT ZU STAAT ODER VON LAND ZU LAND UNTERSCHIEDEN KÖNNEN. UM DEN UMFANG IHRER RECHTE ZU BESTIMMEN, WIRD IHNEN EMPFOHLEN, DIE ANWENDBAREN GESETZE DES JEWEILIGEN STAATES ODER LANDES ZU ZIEHEN.

Diese eingeschränkte Garantie ist auf Hardware-Produkte der Marke D-LINK (insgesamt im Folgenden: „D-LINK Hardware-Produkte“) anwendbar, die von D-LINK (Europe) Ltd. oder dessen weltweiten Filialen, Tochtergesellschaften, Fachhändlern oder Länderdistributoren (insgesamt im Folgenden: „D-LINK“) mit dieser eingeschränkten Garantie verkauft wurden. Der Begriff „D-LINK Hardware-Produkte“ beinhaltet nur Hardwarekomponenten und deren Bestandteile einschließlich Firmware. Der Begriff „D-LINK Hardware-Produkte“ umfasst KEINE Software-Anwendungen oder -programme.

Räumlicher Geltungsbereich der eingeschränkten Garantie

Diese eingeschränkte Garantie gilt für alle genannten europäischen Staaten gemäß dem Anhang „Eingeschränkte Garantie von D-LINK in europäischen Staaten“. Im Rahmen dieser eingeschränkten Garantie sind mit dem Begriff „europäische Staaten“ nur die im Anhang genannten Staaten gemeint. Die eingeschränkte Garantie findet überall Anwendung, wo D-LINK oder dessen autorisierte Servicepartner Garantiedienste gemäß den Bestimmungen dieser eingeschränkten Garantie erbringen. Gleichwohl kann sich die Verfügbarkeit von Garantiediensten und die Bearbeitungszeit von Land zu Land unterscheiden und von Registrierungsanforderungen abhängig sein.

Einschränkung der Garantie

D-LINK gewährleistet, dass die nachstehend aufgeführten Produkte bei gewöhnlicher Verwendung für die unten angegebene Laufzeit der eingeschränkten Garantie („Garantielaufzeit“) frei von wesentlichen Verarbeitungs- und Materialfehlern sind. Voraussetzung hierfür ist jedoch, dass das Produkt entsprechend dem Benutzerhandbuch und den weiteren Dokumentationen, die der Benutzer beim Kauf (oder später) erhalten hat, genutzt und gewartet wird. D-LINK garantiert nicht, dass die Produkte störungs- oder fehlerfrei arbeiten oder dass alle Mängel, Fehler, Defekte oder Kompatibilitätsstörungen beseitigt werden können.

Diese Garantie gilt nicht für Probleme wegen: (a) unerlaubter Veränderung oder Hinzufügung, (b) Fahrlässigkeit, Missbrauch oder Zweckentfremdung, einschließlich des Gebrauchs des Produkts entgegen den Spezifikationen oder den durch Schnittstellen gegebenen Vorgaben, (c) fehlerhafter Bedienung, (d) Versagen von Produkten oder Diensten, die nicht von D-LINK stammen oder nicht Gegenstand einer zum maßgeblichen Zeitpunkt gültigen Garantie- oder Wartungsvereinbarung sind, (e) Fehlgebrauch oder fehlerhafter Lagerung oder (f) Feuer, Wasser, höherer Gewalt oder anderer Katastrophen. Diese Garantie gilt ebenfalls nicht für Produkte, bei denen eine D-LINK-Seriennummer entfernt oder auf sonstige Weise unkenntlich gemacht wurde.

D-LINK STEHT NICHT FÜR SCHÄDEN EIN, DIE DADURCH ENTSTEHEN, DASS DIE ANLEITUNG FÜR DAS D-LINK HARDWARE-PRODUKT NICHT BEFOLGT WIRD.

Laufzeit der eingeschränkten Garantie

Die Laufzeit der eingeschränkten Garantie beginnt mit dem Zeitpunkt, zu dem das Produkt von D-LINK gekauft wurde. Als Nachweis für den Zeitpunkt des Kaufs gilt der datierte Kauf- oder Lieferbeleg. Es kann von Ihnen verlangt werden, dass Sie zur Inanspruchnahme von Garantiediensten den Kauf des Produkts nachweisen. Wenn Ihre Hardware-Produkte der Marke D-LINK innerhalb der Laufzeit der eingeschränkten Garantie eine Reparatur benötigen, so sind Sie berechtigt, gemäß den Bedingungen dieser eingeschränkten Garantie Garantiedienste in Anspruch zu nehmen.

Diese eingeschränkte Garantie gilt nur für denjenigen, der das D-LINK Hardware-Produkt ursprünglich als originärer Endbenutzer gekauft hat. Sie ist nicht auf Dritte übertragbar, die das D-LINK-Produkt von dem ursprünglichen originären Endbenutzer erworben haben.

Produkttyp	Gewährleistungslaufzeit
Verwaltete Switches (d. h. Switches mit eingebauten SNMP-Agents) (einschließlich Modulen und Verwaltungssoftware)	Fünf (5) Jahre
Alle weiteren Produkte	Zwei (2) Jahre
Ersatzteile (z.B. externe Netzteile, Lüfter)	Ein (1) Jahr

Die oben aufgeführten Garantielaufzeiten gelten für alle D-LINK-Produkte, die in europäischen Staaten ab dem 1. Januar 2004 von D-LINK oder einem autorisierten Fachhändler oder Distributor verkauft werden. Alle vor dem 1. Januar 2004 von D-LINK oder einem autorisierten Vertragshändler oder Distributor verkauften Produkte haben eine Gewährleistung von 5 Jahren; ausgenommen sind Netzteile, Lüfter und Zubehör, diese haben eine Garantie von 2 Jahren.

Die durch diesen Garantieschein festgelegte Garantielaufzeit tritt an die Stelle der im Benutzerhandbuch oder im Kaufvertrag für das jeweilige Produkt angegebenen Laufzeit. Sollten Sie das betreffende D-LINK-Produkt als Verbraucher erworben haben, so sei klargestellt, dass Ihre gesetzlichen Rechte hiervon unberührt bleiben.

Leistungsumfang der eingeschränkten Garantie

Bei Auftreten eines Produktfehlers besteht die einzige Verpflichtung von D-LINK darin, dem ursprünglichen Käufer das defekte Produkt kostenlos zu reparieren oder es auszutauschen. Voraussetzung hierfür ist, dass das Produkt während der Garantielaufzeit einem autorisierten D-LINK-Servicecenter übergeben wird. Reparatur oder Austausch werden von D-LINK durch ein autorisiertes D-LINK-Servicecenter durchgeführt. Bauteile oder Hardware-Produkte, die gemäß dieser eingeschränkten Garantie entfernt werden, gehen in das Eigentum von D-LINK über. Die verbliebene eingeschränkte Garantie des entfernten Teils oder Produkts wird auf das Ersatzteil oder -produkt übertragen. Das Austauschprodukt muss weder neu sein noch dem defekten Produkt ganz oder in Teilen entsprechen. D-LINK darf dieses nach eigenem Ermessen gegen ein entsprechendes wiederaufbereitetes Produkt austauschen, welches dem defekten Produkt im Wesentlichen entspricht (oder höherwertig ist). D-LINK kann verlangen, dass der Kauf des Produkts nachgewiesen wird.

DIE VORSTEHENDE GARANTIE WURDE IN DIE DEUTSCHE SPRACHE AUS DEM ENGLISCHEN ÜBERSETZT. BEI ABWEICHUNGEN ZWISCHEN DER ENGLISCHEN VERSION UND DER DEUTSCHEN ÜBERSETZUNG GELTEN DIE BESTIMMUNGEN DER ENGLISCHEN VERSION.

Garantiegeber

D-Link (Europe) Ltd.
4th Floor, Merit House
Edgware Road
Colindale
London NW9 5 AB
Vereinigtes Königreich

Telefon: +44-020-8731-5555

Fax: +44-020-8731-5511

www.dlink.com

D-Link Europe a limité la garantie des produits

Conditions Générales

La Garantie Produit Limitée énoncée ci-dessous émane de D-LINK (Europe) Ltd. (ci-après « D-LINK »). Cette Garantie Produit Limitée n'est valable que sur présentation de la preuve d'achat. D-LINK peut également exiger la présentation du présent bon de garantie.

SAUF INDICATION EXPLICITE DES PRESENTES, D-LINK NE FOURNIT AUCUNE AUTRE GARANTIE, EXPLICITE OU IMPLICITE, Y COMPRIS UNE GARANTIE IMPLICITE DE VALEUR MARCHANDE OU D'ADAPTATION DU PRODUIT A UN USAGE PRECIS. D-LINK DECLINE EXPLICITEMENT TOUTE GARANTIE NON ENONCEE DANS LES PRESENTES. TOUTE GARANTIE IMPLICITE IMPOSEE PAR LA LOI, LE CAS ECHEANT, EST LIMITEE DANS SA DUREE A CELLE DE LA GARANTIE LIMITEE. CERTAINS ETATS OU PAYS NE PERMETTENT PAS DE LIMITER LA DUREE DE LA GARANTIE IMPLICITE OU INTERDISENT D'EXCLURE OU DE LIMITER LA COUVERTURE DES DOMMAGES DIRECTS OU INDIRECTS OCCASIONNES AUX PRODUITS GRAND PUBLIC. DANS LES ETATS OU PAYS EN QUESTION, CERTAINES EXCLUSIONS OU LIMITATIONS DE LA PRESENTE GARANTIE PEUVENT NE PAS S'APPLIQUER A VOTRE CAS. LA PRESENTE GARANTIE LIMITEE VOUS OCTROIE CERTAINS DROITS LEGAUX SPECIFIQUES. VOUS POUVEZ EGALEMENT BENEFICIER D'AUTRES DROITS VARIABLES D'UN ETAT OU D'UN PAYS A L'AUTRE. NOUS VOUS RECOMMANDONS DE CONSULTER LA LEGISLATION EN VIGUEUR DANS VOTRE LIEU DE RESIDENCE POUR CONNAITRE L'ETENDUE DE VOS DROITS.

La présente garantie limitée s'applique aux produits matériels commercialisés sous la marque D-LINK (collectivement ici « les Produits Matériels D-LINK ») vendus par D-LINK (Europe) Ltd., ses filiales, sociétés affiliées, revendeurs agréés ou distributeurs locaux à travers le monde (collectivement ici « D-LINK ») avec la présente garantie limitée. Le terme de « Produit Matériel D-LINK » se limite aux composants matériels et à l'ensemble de leurs composants internes, notamment le firmware. Le terme de « Produit Matériel D-LINK » N'englobe PAS les applications ou programmes logiciels.

Etendue géographique de la Garantie Produit Limitée

La présente Garantie Produit Limitée s'applique à tous les pays européens figurant dans l'annexe « Pays européens où s'applique la Garantie Produit Limitée D-LINK ». Le terme de « pays européens » utilisé dans la présente Garantie Produit Limitée D-LINK englobe uniquement les pays figurant dans la liste en annexe. La Garantie Produit Limitée sera honorée dans tout pays où D-LINK ou ses prestataires agréés proposent le service de garantie, sous réserve des modalités énoncées dans la présente Garantie Produit Limitée. Cependant, la disponibilité du service de garantie et les temps de réponse varient d'un pays à l'autre et peuvent également être assujettis à un enregistrement.

Limitation de la Garantie Produit

D-LINK garantit que les produits décrits ci-dessous, dans le cadre d'une utilisation normale, sont dénués de défauts conséquents, tant au niveau de leurs composants matériels que de leur fabrication, et ce pendant toute la Période de Garantie Produit Limitée indiquée ci-dessous (« Période de Garantie Produit Limitée »), sous réserve qu'ils soient utilisés et entretenus conformément au manuel utilisateur et aux autres documents remis au client lors de l'achat (ou amendés de temps à autre). D-LINK ne garantit pas le fonctionnement ininterrompu ou sans erreur de ses produits. D-LINK ne s'engage pas non plus à corriger tous les défauts, erreurs ou non conformités.

La présente garantie ne s'applique pas aux problèmes qui sont la conséquence : (a) d'altérations ou d'ajouts non autorisés ; (b) d'une négligence, d'un abus ou d'une mauvaise utilisation, notamment une utilisation du produit non conforme à ses spécifications ou aux interfaces requises ; (c) d'une mauvaise manipulation ; (d) d'une panne de biens ou de services acquis auprès d'une société tierce (non D-LINK) ou qui ne font pas l'objet d'un contrat D-LINK de garantie ou de maintenance en bonne et due forme ; (e) d'une mauvaise utilisation ou d'un rangement dans des conditions inadéquates ; ou (f) du feu, de l'eau, d'une catastrophe naturelle ou autre. La présente garantie ne s'applique pas non plus à un produit dont le numéro de série D-LINK aurait été retiré ou altéré de quelque manière que ce soit.

D-LINK N'EST NULLEMENT RESPONSABLE DE DOMMAGES RESULTANT DE VOTRE INOBSERVATION DES INSTRUCTIONS FOURNIES POUR L'UTILISATION DE SON PRODUIT MATERIEL.

Période de Garantie Produit Limitée

La Période de Garantie Produit Limitée court à compter de la date d'achat auprès de D-LINK. La date de votre reçu ou bon de livraison correspond à la date d'achat du produit et constitue la date de votre preuve d'achat. Il est possible que le service de garantie ne vous soit accordé que sur production de votre preuve d'achat. Vous avez droit à un service de garantie conforme aux modalités énoncées dans les présentes dès lors que votre matériel de marque D-LINK nécessite une réparation pendant la Période de Garantie Produit Limitée.

La présente Garantie Produit Limitée s'applique uniquement à l'acheteur utilisateur final initial du Produit Matériel D-LINK. Elle est non cessible à quiconque se procure le Produit Matériel D-LINK auprès de l'acheteur utilisateur final initial.

Type de produit	Période de Garantie
Switches gérés (switches comportant un agent SNMP intégré)(y compris modules et logiciels de gestion)	Cinq (5) ans
Tous autres produits	Deux (2) ans
Pièces détachées (adaptateurs d'alimentation externes, ventilateurs)	Un (1) an

Les périodes de garantie indiquées ci-dessus s'appliquent à tous les produits D-LINK vendus depuis le 1er janvier 2004 dans les pays européens par D-LINK ou l'un de ses revendeurs ou distributeurs agréés. Tous les produits vendus avant le 1er janvier 2004 dans les pays européens par D-LINK ou l'un de ses revendeurs ou distributeurs agréés bénéficient d'une garantie de 5 ans, excepté les fournitures électriques, ventilateurs et accessoires, qui sont couverts par une garantie de 2 ans.

La période de garantie indiquée sur ce bon annule et remplace celle qui figure dans le manuel utilisateur ou dans le contrat d'achat des produits considérés. Pour éviter le doute, si vous avez acheté votre produit D-LINK en tant que consommateur, vos droits légaux demeurent inchangés.

Exécution de la Garantie Produit Limitée

En cas de défaut ou d'erreur d'un produit, l'unique obligation de D-LINK se limite à la réparation ou au remplacement gratuit du produit défectueux, au bénéfice de l'acheteur initial, sous réserve que le produit soit rapporté à un Centre de Service Agréé D-LINK pendant la période de garantie. D-LINK assure la réparation ou le remplacement dans un Centre de Service Agréé D-LINK. Les composants, pièces ou produits retirés dans le cadre de cette garantie limitée deviennent propriété de D-LINK. La pièce ou le produit de remplacement est couvert par la garantie limitée de la pièce ou du produit d'origine pendant la période restante. Le produit de remplacement n'est pas nécessairement neuf, ni d'une marque ou d'un modèle identique ; D-LINK peut décider, de manière discrétionnaire, de remplacer le produit défectueux (ou ses pièces) par un équivalent (ou un article supérieur) reconditionné ayant toutes les fonctionnalités du produit défectueux. D-LINK peut exiger la preuve d'achat.

Garant

D-Link (Europe) Ltd.
4th Floor, Merit House
Edgware Road
Colindale
London NW9 5 AB
Royaume-Uni

Tél : +44-020-8731-5555

Fax : +44-020-8731-5511

www.dlink.co.uk

Garantía limitada del producto D-LINK Europa

Condiciones generales

Esta garantía la ofrece D-LINK (Europe) Ltd. (en este documento, "D-LINK"). La garantía limitada del producto sólo es válida si se acompaña del comprobante de la compra. También deberá presentarse la tarjeta de garantía si D-LINK lo solicita.

EXCEPTO EN LO EXPRESAMENTE INDICADO EN ESTA GARANTÍA LIMITADA, D-LINK NO CONCEDE OTRAS GARANTÍAS, NI EXPLÍCITAS NI IMPLÍCITAS, INCLUIDAS LAS GARANTÍAS IMPLÍCITAS DE COMERCIALIZACIÓN Y APTITUD A UN FIN DETERMINADO. D-LINK RECHAZA EXPLÍCITAMENTE CUALQUIER GARANTÍA QUE NO FIGURE EN ESTA GARANTÍA LIMITADA. LA DURACIÓN DE CUALQUIER GARANTÍA IMPLÍCITA QUE PUEDA SER IMPUESTA POR LEY QUEDA LIMITADA AL PERIODO DE LA GARANTÍA LIMITADA. ALGUNOS ESTADOS O PAÍSES NO PERMITEN QUE EN LA GARANTÍA LIMITADA DE PRODUCTOS DE CONSUMO SE RESTRINJA LA DURACIÓN TEMPORAL, NI QUE SE EXCLUYAN O LIMITEN LOS DAÑOS INCIDENTALES O RESULTANTES PARA EL CONSUMIDOR DE LOS PRODUCTOS. EN ESTOS ESTADOS O PAÍSES, A USTED NO LE PUEDEN APLICAR ALGUNAS EXCLUSIONES O LIMITACIONES DE LA GARANTÍA LIMITADA. ESTA GARANTÍA LIMITADA LE CONCEDE DETERMINADOS DERECHOS. PUEDE, TAMBIÉN, TENER OTROS DERECHOS, QUE PUEDEN SER DISTINTOS DE UN ESTADO A OTRO O DE UN PAÍS A OTRO. SE RECOMIENDA QUE CONSULTE LAS LEYES PERTINENTES DE UN ESTADO O PAÍS A FIN DE QUE CONOZCA SUS DERECHOS.

Esta garantía limitada se aplica a los productos de hardware de la marca D-LINK (llamados en esta guía "Productos de hardware D-LINK") comprados a D-LINK (Europe) Ltd., a sus filiales en el mundo, a sus proveedores autorizados o a sus distribuidores locales (llamados en este documento "D-LINK") con esta garantía limitada. El término "producto de hardware D-LINK" se restringe a los componentes de hardware y a los componentes internos de estos, incluyendo el firmware. El término "producto de hardware D-LINK" NO incluye ni las aplicaciones ni los programas de software.

Cobertura geográfica de la garantía limitada del producto

Esta garantía limitada del producto es válida en todos los países europeos que figuran en el apéndice "Países europeos de la garantía limitada del producto D-LINK". En esta garantía limitada del producto D-Link, el término "países europeos" sólo incluye los países que figuran en el apéndice. La garantía limitada del producto será válida en cualquier país en el que D-LINK o sus proveedores autorizados de servicios ofrezcan un servicio de garantía sujeto a los términos y condiciones recogidos en esta garantía limitada del producto. Sin embargo, la disponibilidad del servicio de garantía, así como el tiempo de respuesta, pueden variar de un país a otro y pueden estar sujetos a requisitos de registro.

Limitación de la garantía del producto

D-LINK garantiza que los productos descritos más adelante están libres de defectos de fabricación y materiales, en condiciones normales de uso, a lo largo del periodo de la garantía limitada del producto que se indica en este documento ("periodo de la garantía limitada del producto"), si el producto se ha utilizado y mantenido conforme a lo recogido en el manual del usuario o en otra documentación que se haya proporcionado al comprador en el momento de la compra (o que se haya corregido). D-LINK no garantiza que los productos funcionarán sin interrupciones o sin errores, ni que se corregirán todas las deficiencias, errores, defectos o disconformidades.

Esta garantía no cubre problemas derivados de: (a) modificaciones o conexiones no autorizadas; (b) negligencia, abuso o mal uso, incluyendo el incumplimiento de las especificaciones y de los requisitos de la interfaz en el funcionamiento del producto; (c) manejo incorrecto; (d) errores en artículos o servicios ajenos a D-LINK o no sujetos a una garantía o un contrato de mantenimiento vigentes de D-LINK; (e) uso o almacenamiento incorrecto; o (f) fuego, agua, casos fortuitos u otros hechos catastróficos. Esta garantía tampoco es válida para aquellos productos a los que se haya eliminado o alterado de algún modo el número de serie D-LINK.

D-LINK NO SE RESPONSABILIZA DE LOS DAÑOS CAUSADOS COMO CONSECUENCIA DEL INCUMPLIMIENTO DE LAS INSTRUCCIONES DEL PRODUCTO DE HARDWARE D-LINK.

Periodo de la garantía limitada del producto

El periodo de la garantía limitada del producto se inicia en la fecha en que se realizó la compra a D-LINK. Para el comprador, el comprobante de la fecha de la compra es el recibo de la venta o de la entrega, en el que figura la fecha de la compra del producto. Puede ser necesario tener que presentar el comprobante de la compra a fin de que se preste el servicio de garantía. El comprador tiene derecho al servicio de garantía conforme a los términos y condiciones de este documento, si requiere una reparación del hardware de la marca D-LINK dentro del periodo de garantía limitada del producto.

Esta garantía limitada del producto cubre sólo al originario comprador-usuario final de este producto de hardware D-LINK, y no es transferible a otras personas que reciban el producto de hardware D-LINK del originario comprador-usuario final.

Tipo de producto	Periodo de garantía del producto
Conmutadores gestionados (p. ej., conmutadores con agente SNMP integrado) (incluyendo módulos y software de gestión)	Cinco (5) años
Resto de productos	Dos (2) años
Piezas de repuesto (p. ej., adaptadores de alimentación externos, ventiladores)	Un (1) año

Estos periodos de garantía están en vigor para todos los productos D-LINK que hayan sido comprados en países europeos a D-LINK o a alguno de sus proveedores o distribuidores autorizados a partir del 1 de enero del 2004. Todos los productos comprados en países europeos a D-LINK o a uno de sus proveedores o distribuidores autorizados antes del 1 de enero del 2004 cuentan con 5 años de garantía, excepto las fuentes de alimentación, los ventiladores y los accesorios, que cuentan con 2 años de garantía.

El periodo de garantía que figura en esta tarjeta sustituye y reemplaza al periodo de garantía que consta en el manual del usuario o en el contrato de compra de los productos correspondientes. Para evitar dudas: si usted ha comprado el producto D-LINK correspondiente como consumidor, sus derechos legales no se ven afectados.

Uso de la garantía limitada del producto

Si un producto presenta algún defecto, la obligación exclusiva de D-LINK será reparar o reemplazar, sin coste alguno para el comprador originario, cualquier producto defectuoso siempre y cuando éste sea entregado en un centro autorizado de servicio D-LINK durante el periodo de garantía. D-LINK realizará la reparación o sustitución para un centro autorizado de servicio D-LINK. Todos los productos de hardware o componentes que se eliminen bajo esta garantía limitada serán propiedad de D-LINK. La parte o el producto de repuesto adquiere, para el resto de la garantía limitada, el estatus de parte o producto eliminado. El producto de repuesto no ha de ser nuevo o de la misma marca, modelo o parte; D-LINK puede sustituir a discreción el producto defectuoso (o cualquier parte) con un producto equivalente reacondicionado (o superior) en cualquier material respecto al producto defectuoso. D-LINK puede pedir el comprobante de compra.

Garante

D-Link (Europe) Ltd.
4th Floor, Merit House
Edgware Road
Colindale
London NW9 5 AB
United Kingdom

Teléfono: +44-020-8731-5555

Fax: +44-020-8731-5511

www.dlink.co.uk

D-Link Europe Termini di Garanzia dei Prodotti

Generalità

La presente Garanzia viene fornita da D-LINK (Europe) Ltd. (di seguito denominata "D-LINK"). Essa viene riconosciuta solo se accompagnata dalla prova di acquisto. D-LINK può richiedere anche l'esibizione della presente cartolina di garanzia.

SALVO QUANTO ESPRESSAMENTE STABILITO NELLA PRESENTE GARANZIA LIMITATA, D-LINK NON FORNISCE NESSUN'ALTRA GARANZIA NE' ESPRESSA NE' IMPLICITA, COMPRESSE EVENTUALI GARANZIE DI COMMERCIALIZZABILITÀ O DI IDONEITÀ PER UN PARTICOLARE SCOPO. D-LINK NEGA ESPRESSAMENTE QUALUNQUE ALTRA GARANZIA CHE NON RIENTRI NELLA PRESENTE GARANZIA LIMITATA. QUALSIASI GARANZIA IMPLICITA, CHE DOVESSE ESSERE IMPOSTA PER LEGGE, SARÀ CIRCOSCRITTA ALLA DURATA DELLA PRESENTE GARANZIA. ALCUNI PAESI VIETANO QUALSIASI LIMITAZIONE DEL PERIODO DI VALIDITÀ DELLE GARANZIE IMPLICITE OPPURE L'ESCLUSIONE O LA LIMITAZIONE DEI DANNI INCIDENTALI O CONSEGUENZIALI PER I PRODOTTI. IN TALI PAESI, EVENTUALI ESCLUSIONI O LIMITAZIONI DELLA PRESENTE GARANZIA NON POTRANNO APPLICARSI AL VOSTRO CASO. LA PRESENTE GARANZIA VI CONFERISCE DIRITTI LEGALI SPECIFICI. INOLTRE POTRETE GODERE DI ULTERIORI DIRITTI CHE POSSONO VARIARE A SECONDA DEL PAESE. SIETE INVITATI A CONSULTARE LE LEGGI APPLICABILI DEL VOSTRO PAESE AL FINE DI DETERMINARE CON PRECISIONE I VOSTRI DIRITTI.

La presente garanzia trova applicazione su tutti i prodotti hardware recanti il marchio D-LINK (di seguito denominati collettivamente "Prodotti hardware D-LINK") venduti da D-LINK (Europe) Ltd., dalle sue controllate, dalle sue affiliate, dai rivenditori autorizzati o dai distributori nazionali (di seguito denominati collettivamente "D-LINK"), accompagnati dalla presente garanzia limitata. Il termine "Prodotto hardware D-LINK" si riferisce esclusivamente ai componenti hardware e a tutte le parti interne compreso il firmware. Il termine "Prodotto hardware D-LINK" NON comprende eventuali applicazioni o programmi software.

Ambito geografico della Garanzia limitata

La presente Garanzia è estesa a tutti i Paesi europei elencati nell'appendice "Paesi europei - Garanzia limitata dei prodotti D-LINK". Il termine "Paesi europei" si riferisce esclusivamente ai paesi nominati in questa appendice. La Garanzia verrà riconosciuta in tutti i paesi nei quali D-LINK o i suoi Centri di Assistenza autorizzati offrono assistenza conformemente alle condizioni e ai termini stabiliti nella presente Garanzia. Tuttavia, la disponibilità all'assistenza e i tempi di intervento variano da paese a paese e possono essere soggetti a eventuali requisiti di registrazione.

Limitazione della Garanzia

D-LINK garantisce che i prodotti sotto descritti in condizioni di normale utilizzo non presentano difetti di fabbricazione o vizi di materiale durante il Periodo di garanzia sotto specificato ("Periodo di garanzia"), a condizione che vengano utilizzati e sottoposti a manutenzione in conformità con il manuale d'uso e con ogni altra documentazione fornita all'acquirente all'atto dell'acquisto (e relativi emendamenti). D-LINK non garantisce che il funzionamento del prodotto sarà ininterrotto o esente da errori né tanto meno che tutti gli eventuali errori, carenze, difetti o non conformità potranno essere corretti.

La presente garanzia non copre eventuali problemi derivanti da: (a) alterazioni o aggiunte non autorizzate; (b) negligenza, abuso o utilizzo improprio, compresa l'incapacità di far funzionare il prodotto in conformità con le specifiche e i requisiti di connessione; (c) movimentazione impropria; (d) guasto di prodotti o servizi non forniti da D-LINK o non soggetti a una garanzia successiva di D-LINK o a un accordo di manutenzione; (e) impiego o conservazione impropri; (f) incendio, inondazione, cause di forza maggiore o altro evento catastrofico accidentale. La presente garanzia non si applica altresì ad alcun prodotto particolare qualora il numero di serie di D-LINK sia stato rimosso o reso illeggibile in altro modo.

D-LINK DECLINA OGNI RESPONSABILITÀ PER EVENTUALI DANNI RISULTANTI DAL MANCATO RISPETTO DELLE ISTRUZIONI RELATIVE AL PRODOTTO HARDWARE D-LINK.

Periodo di garanzia

Il Periodo di garanzia ha decorrenza dalla data dell'acquisto presso D-LINK. Prova della data di acquisto è il documento fiscale (scontrino fiscale o ricevuta) recante la data di acquisto del prodotto. Per avere diritto alla garanzia può esservi richiesto di esibire la prova di acquisto. Potete beneficiare delle prestazioni di assistenza previste dalla garanzia in conformità con i termini e le condizioni di cui sotto nel momento in cui il Vostro prodotto hardware D-LINK necessita di una riparazione durante il Periodo di garanzia.

La presente Garanzia si applica esclusivamente al primo acquirente del Prodotto hardware D-LINK e non può essere trasferita a terzi che abbiano ottenuto la proprietà del Prodotto hardware D-LINK dal primo acquirente.

Tipo di prodotto	Periodo di garanzia
Switch (solo switch dotati di agente SNMP incorporato) (inclusi moduli e software di gestione)	5 (cinque) anni
Tutti gli altri prodotti	2 (due) anni
Pezzi di ricambio (es. adattatori esterni di potenza, alimentatori esterni, ventole)	1 (un) anno

Il periodo di garanzia sopra specificato relativamente a tutti i prodotti D-LINK venduti nei Paesi europei da D-LINK o da qualsiasi suo rivenditore o distributore autorizzato decorre dal 1° gennaio 2004. Tutti i prodotti venduti nei Paesi europei da D-LINK o da uno qualsiasi dei suoi rivenditori o distributori autorizzati prima del 1° gennaio 2004 sono coperti da una garanzia di 5 anni fatto salvo per alimentatori, ventole e accessori che hanno 2 anni di garanzia.

Il periodo di garanzia qui menzionato sostituisce qualsiasi altro periodo di garanzia definito nel manuale d'uso o nel contratto di acquisto del prodotto. Se avete acquistato un prodotto D-LINK in qualità di consumatore i Vostri diritti rimangono invariati.

Prestazioni della Garanzia limitata

Qualora comparisse un difetto o una non conformità, D-LINK avrà l'unico obbligo di riparare o sostituire il prodotto non conforme senza alcun costo per l'acquirente a condizione che il prodotto venga restituito a un Centro di Assistenza autorizzato D-LINK entro il periodo di garanzia. La riparazione o la sostituzione verranno eseguite da D-LINK presso un Centro di Assistenza autorizzato D-LINK. Tutti i componenti o i prodotti hardware rimossi conformemente ai termini e alle condizioni della presente garanzia divengono di proprietà di D-LINK. Il pezzo o il prodotto in sostituzione beneficerà della garanzia per il tempo residuo della parte o del prodotto originale. Il prodotto in sostituzione non deve necessariamente essere nuovo o di identica fattura, modello o composizione; D-LINK può a sua discrezione sostituire il prodotto non conforme (o qualsiasi parte di esso) con un prodotto che risulti essere equivalente (o di valore superiore) al prodotto non conforme. D-LINK può richiedere che venga esibita la prova di acquisto.

Garante

D-Link (Europe) Ltd.

4th Floor, Merit House

Edgware Road

Colindale

Londra NW9 5 AB

Regno Unito

Telefono: +44-020-8731-5555

Fax: +44-020-8731-5511

www.dlink.co.uk

Technical Support

You can find software updates and user documentation on the D-Link website.

Tech Support for customers within Australia:

D-Link Technical Support over the Telephone:

1300-766-868

Monday to Friday 8:00am to 8:00pm EST

Saturday 9:00am to 1:00pm EST

D-Link Technical Support over the Internet:

<http://www.dlink.com.au>

email: support@dlink.com.au

Tech Support for customers within New Zealand:

D-Link Technical Support over the Telephone:

0800-900-900

Monday to Friday 8:30am to 8:30pm

Saturday 9:00am to 5:00pm

D-Link Technical Support over the Internet:

<http://www.dlink.co.nz>

email: support@dlink.co.nz

D-Link[®]
Building Networks for People

Technical Support

You can find software updates and user documentation on the D-Link website.

Tech Support for customers within South Eastern Asia and Korea:

D-Link South Eastern Asia and Korea Technical Support over the Telephone:

+65-6895-5355

Monday to Friday 9:00am to 12:30pm, 2:00pm-6:00pm
Singapore Time

D-Link Technical Support over the Internet:

email: support@dlink.com.sg

D-Link[®]
Building Networks for People

Technical Support

You can find software updates and user documentation on the D-Link website.

Tech Support for customers within India

D-Link Technical Support over the Telephone:

+91-22-26526741

+91-22-26526696 –ext 161 to 167

Monday to Friday 9:30AM to 7:00PM

D-Link Technical Support over the Internet:

<http://www.dlink.co.in>

<http://www.dlink.co.in/dlink/drivers/support.asp>

<ftp://support.dlink.co.in>

email: techsupport@dlink.co.in

D-Link[®]
Building Networks for People

Technical Support

You can find software updates and user documentation on the D-Link website.

D-Link provides free technical support for customers for the duration of the warranty period on this product.

Customers can contact D-Link technical support through our web site or by phone.

Tech Support for customers within the Russia

D-Link Technical Support over the Telephone:

(095) 744-00-99

Monday to Friday 10:00am to 6:30pm

D-Link Technical Support over the Internet

<http://www.dlink.ru>

email: support@dlink.ru



Technical Support

You can find software updates and user documentation on the D-Link website.

Tech Support for customers within the U.A.E & North Africa:

D-Link Technical Support over the Telephone:

(971) 4-391-6480 (U.A.E)

Sunday to Wednesday 9:00am to 6:00pm GMT+4

Thursday 9:00am to 1:00pm GMT+4

D-Link Middle East & North Africa

D-Link Technical Support over the Internet:

<http://support.dlink-me.com>

email: support@dlink-me.com

Tech Support for customers within Israel:

D-Link Technical Support over the Telephone:

(972) 971-5701

Sunday to Thursday 9:00am to 5:00pm

D-Link Technical Support over the Internet:

<http://www.dlink.co.il/forum>

e-mail: support@dlink.co.il

Tech Support for customers within Turkey:

D-Link Technical Support over the Telephone:

(+90) 212-289 56 59

Monday to Friday 9:00am to 6:00pm

D-Link Technical Support over the Internet:

<http://www.dlink.com.tr>

e-mail: turkiye@dlink-me.com

Tech Support for customers within Egypt:

D-Link Technical Support over the Telephone:

(202) 414-4295

Sunday to Thursday 9:00am to 5:00pm

D-Link Technical Support over the Internet:

<http://support.dlink-me.com>

e-mail: amostafa@dlink-me.com

D-Link®
Building Networks for People

Technical Support

You can find software updates and user documentation on the D-Link website.

Tech Support for customers within South Africa and Sub Sahara Region:

D-Link South Africa and Sub Sahara Technical Support over the Telephone:

+27-12-665-2165

08600 DLINK (For South Africa only)

Monday to Friday 8:30am to 9:00pm South Africa Time

D-Link Technical Support over the Internet:

<http://www.d-link.co.za>

[email:support@d-link.co.za](mailto:support@d-link.co.za)

D-Link[®]
Building Networks for People

Technical Support

You can find updates and user documentation on the D-Link website

Tech Support for Latin America customers:

D-Link Technical Support over the followings Telephones:

Argentina: 0800-666 1442	Monday to Friday 09:00am to 22:00pm
Chile: 800-214 422	Monday to Friday 08:00am to 21:00pm
Colombia: 01800-700 1588	Monday to Friday 07:00am to 20:00pm
Ecuador: 1800-777 711	Monday to Friday 07:00am to 20:00pm
El Salvador: 800-6137	Monday to Friday 06:00am to 19:00pm
Guatemala: 1800-300 0017	Monday to Friday 06:00am to 19:00pm
Panama: 0800-560 0193	Monday to Friday 07:00am to 20:00pm
Peru: 0800-52049	Monday to Friday 07:00am to 20:00pm
Venezuela: 0800-100 3470	Monday to Friday 08:00am to 21:00pm

D-Link Technical Support over the Internet:

www.dlinkla.com

www.dlinklatinamerica.com

[email:support@dlink.cl](mailto:support@dlink.cl)

Tech Support for customers within Brazil:

D-Link Technical Support over the Telephone:

0800-7014104

Monday to Friday 8:30am to 18:30pm

D-Link Technical Support over the Internet:

www.dlinkbrasil.com.br

[email:suporte@dlinkbrasil.com.br](mailto:suporte@dlinkbrasil.com.br)

D-Link®
Building Networks for People

Техническая поддержка

Обновления программного обеспечения и документация доступны на Интернет-сайте D-Link.

D-Link предоставляет бесплатную поддержку для клиентов в течение гарантийного срока.

Клиенты могут обратиться в группу технической поддержки D-Link по телефону или через Интернет.

Техническая поддержка D-Link:
(095) 744-00-99

Техническая поддержка через Интернет
<http://www.dlink.ru>
email: support@dlink.ru

D-Link[®]
Building Networks for People

Asistencia Técnica

D-Link Latin América pone a disposición de sus clientes, especificaciones, documentación y software mas reciente a través de nuestro Sitio Web

www.dlinklatinamerica.com

El servicio de soporte técnico tiene presencia en numerosos países de la Región Latino América, y presta asistencia gratuita a todos los clientes de D-Link, en forma telefónica e internet, a través de la casilla

soporte@dlinkla.com

Soporte Técnico Help Desk Argentina:

Teléfono: 0800-6661442 Lunes a Viernes 09:00 am a 22:00 pm

Soporte Técnico Help Desk Chile:

Teléfono: 800-214422 Lunes a Viernes 08:00 am a 21:00 pm

Soporte Técnico Help Desk Colombia:

Teléfono: 01800-7001588 Lunes a Viernes 07:00 am a 20:00 pm

Soporte Técnico Help Desk Ecuador:

Teléfono: 1800-777 711 Lunes a Viernes 07:00 am a 20:00 pm

Soporte Técnico Help Desk El Salvador:

Teléfono: 800-6137 Lunes a Viernes 06:00 am a 19:00 pm

Soporte Técnico Help Desk Guatemala:

Teléfono: 1800-300 0017 Lunes a Viernes 06:00 am a 19:00 pm

Soporte Técnico Help Desk Panamá:

Teléfono: 0800-560 0193 Lunes a Viernes 07:00 am a 20:00 pm

Soporte Técnico Help Desk Perú:

Teléfono: 0800-52049 Lunes a Viernes 07:00 am a 20:00 pm

Soporte Técnico Help Desk Venezuela:

Teléfono: 0800-1003470 Lunes a Viernes 08:00 am a 21:00 pm

D-Link[®]
Building Networks for People

Suporte Técnico

Você pode encontrar atualizações de software e documentação de usuário no site da D-Link Brasil
www.dlinkbrasil.com.br.

A D-Link fornece suporte técnico gratuito para clientes no Brasil durante o período de vigência da garantia deste produto.

Suporte Técnico para clientes no Brasil:

Telefone

São Paulo (11) 2185-9301

Segunda à sexta

Das 8h30 às 18h30

Demais Regiões do Brasil 0800 70 14 104

友冠技術支援

台灣地區用戶可以透過我們的網站，電子郵件或電話與友冠資訊技術支援人員聯絡。

支援服務時間從
週一到週五，上午8:30 a.m. 到 7:00 p.m

Web: <http://www.dlinktw.com.tw/>

FAQ: <http://www.dlinktw.com.tw/support.asp>

Email: dssqa_service@dlinktw.com.tw

Phone: 0800-002-615

如果您是台灣地區以外的用戶，請參考使用手冊中記載的D-Link 全球各地分公司的聯絡資訊取得支援服務。

產品維修與保固相關資訊，請參考友冠資訊網頁說明：
<http://www.dlinktw.com.tw/suppQuick.asp>

D-Link[®]
Building Networks for People

Technical Support

You can find software updates and user documentation on the D-Link website.

D-Link provides free technical support for customers within the United States and within Canada for the duration of the warranty period on this product.

U.S. and Canadian customers can contact D-Link technical support through our website, or by phone.

Tech Support for customers within the United States:

D-Link Technical Support over the Telephone:

(888) 843-6100

Hours of Operation: 8:00AM to 6:00PM PST

D-Link Technical Support over the Internet:

<http://support.dlink.com>

email: support@dlink.com

Tech Support for customers within Canada:

D-Link Technical Support over the Telephone:

(800) 361-5265



Technical Support

You can find software updates and user documentation on the D-Link websites.

D-Link provides free technical support for customers within Canada,
the United Kingdom, and Ireland.

Customers can contact D-Link technical support through our websites,
or by phone.

For Customers within The United Kingdom & Ireland:

D-Link UK & Ireland Technical Support over the Telephone:

(08456 12 0003 (United Kingdom)

+44 8456 12 0003 (Ireland)

Monday to Friday 8:00 am to 10:00 pm GMT

Sat & Sun 10.00 am to 7.00 pm GMT

D-Link UK & Ireland Technical Support over the Internet:

<http://www.dlink.co.uk>

<ftp://ftp.dlink.co.uk>

For Customers within Canada:

D-Link Canada Technical Support over the Telephone:

1-800-361-5265 (Canada)

Monday to Friday 7:30 am to 12:00 am EST

D-Link Canada Technical Support over the Internet:

<http://support.dlink.ca>

email: support@dlink.ca

D-Link[®]
Building Networks for People

Technische Unterstützung

Aktualisierte Versionen von Software und Benutzerhandbuch finden Sie auf der Website von D-Link.

D-Link bietet kostenfreie technische Unterstützung für Kunden innerhalb Deutschlands, Österreichs, der Schweiz und Osteuropas.

Unsere Kunden können technische Unterstützung über unsere Website, per E-Mail oder telefonisch anfordern.

Web: <http://www.dlink.de>

E-Mail: support@dlink.de

Telefon: +49 (1805)2787

0,12€/Min aus dem Festnetz der Deutschen Telekom.

Telefonische technische Unterstützung erhalten Sie Montags bis Freitags von 09.00 bis 17.30 Uhr.

Wenn Sie Kunde von D-Link außerhalb Deutschlands, Österreichs, der Schweiz und Osteuropas sind, wenden Sie sich bitte an die zuständige Niederlassung aus der Liste im Benutzerhandbuch.

D-Link[®]
Building Networks for People

Assistance technique

Vous trouverez la documentation et les logiciels les plus récents sur le site web **D-Link**.

Le service technique de **D-Link** est gratuit pour les clients aux Etats-Unis durant la période de garantie.

Ceux-ci peuvent contacter le service technique de **D-Link** par notre site internet ou par téléphone.

Support technique destiné aux clients établis en France:

Assistance technique D-Link par téléphone :

0 820 0803 03

Assistance technique D-Link sur internet :

<http://www.dlink.fr>

e-mail : support@dlink.fr

Support technique destiné aux clients établis au
Canada :

Assistance technique D-Link par téléphone :

(800) 361-5265

Lun.-Ven. 7h30 à 21h00 HNE.

Assistance technique D-Link sur internet :

<http://support.dlink.ca>

e-mail : support@dlink.ca

D-Link[®]
Building Networks for People

Asistencia Técnica

Puede encontrar el software más reciente y documentación para el usuario en el sitio web de **D-Link** . **D-Link** ofrece asistencia técnica gratuita para clientes dentro de España durante el periodo de garantía del producto. Los clientes españoles pueden ponerse en contacto con la asistencia técnica de **D-Link** a través de nuestro sitio web o por teléfono.

Asistencia Técnica de D-Link por teléfono:

902 304545

de lunes a viernes desde las 9:00 hasta las 14:00 y de las 15:00 hasta las 18:00

Asistencia Técnica de D-Link a través de Internet:

<http://www.dlink.es>
email: soporte@dlink.es

D-Link[®]
Building Networks for People

Supporto tecnico

Gli ultimi aggiornamenti e la documentazione sono disponibili sul sito D-Link.

Supporto tecnico per i clienti residenti in Italia

D-Link Mediterraneo S.r.L.

Via N. Bonnet 6/B 20154 Milano

Supporto Tecnico dal lunedì al venerdì dalle ore
9.00 alle ore 19.00 con orario continuato
Telefono: 02-39607160

URL : <http://www.dlink.it/supporto.html>

Email: tech@dlink.it

D-Link[®]
Building Networks for People

Technical Support

You can find software updates and user documentation on the D-Link website.

D-Link provides free technical support for customers within Benelux for the duration of the warranty period on this product.

Benelux customers can contact D-Link technical support through our website, or by phone.

Tech Support for customers within the Netherlands:

D-Link Technical Support over the Telephone:

0900 501 2007

Monday to Friday 8:00 am to 10:00 pm

D-Link Technical Support over the Internet:

www.dlink.nl

Tech Support for customers within Belgium:

D-Link Technical Support over the Telephone:

+32(0)2 717 3248

Monday to Friday 8:00 am to 10:00 pm

D-Link Technical Support over the Internet:

www.dlink.be

Tech Support for customers within Luxemburg:

D-Link Technical Support over the Telephone:

+352 342 080 82 13

Monday to Friday 8:00 am to 10:00 pm

D-Link Technical Support over the Internet:

www.dlink.be



Pomoc techniczna

Najnowsze wersje oprogramowania i dokumentacji użytkownika można znaleźć w serwisie internetowym firmy D-Link.

D-Link zapewnia bezpłatną pomoc techniczną klientom w Polsce w okresie gwarancyjnym produktu.

Klienci z Polski mogą się kontaktować z działem pomocy technicznej firmy D-Link za pośrednictwem Internetu lub telefonicznie.

Telefoniczna pomoc techniczna firmy D-Link:

+49 (1805)-2787

Pomoc techniczna firmy D-Link świadczona przez Internet:

URL: <http://www.dlink.pl>

e-mail: pomoc_techiczna@dlink.de



Technická podpora

Aktualizované verze software a uživatelských příruček najdete na webové stránce firmy D-Link.

D-Link poskytuje svým zákazníkům bezplatnou technickou podporu

Zákazníci mohou kontaktovat oddělení technické podpory přes webové stránky, mailem nebo telefonicky

Web: <http://www.dlink.de>

E-Mail: support@dlink.de

Telefon: +49 (1805)-2787

Telefonická podpora je v provozu:

PO-ČT od 08.00 do 19.00

PÁ od 08.00 do 17.00

D-Link[®]
Building Networks for People

Technikai Támogatás

Meghajtó programokat és frissítéseket a **D-Link** Magyarország weblapjáról tölthet le.
Telefonon technikai segítséget munkanapokon hétfőtől-
csütörtökig 9.00 – 16.00 óráig és pénteken 9.00 – 14.00
óráig kérhet
a **(1) 461-3001** telefonszámon vagy a **support@dlink.hu**
emailcímen.

Magyarországi technikai támogatás :

D-Link Magyarország

1074 Budapest, Alsóerdősor u. 6. – R70 Irodaház 1 em.

Tel. : 06 1 461-3001

Fax : 06 1 461-3004

email : support@dlink.hu

URL : http://www.dlink.hu

D-Link[®]
Building Networks for People

Teknisk Support

Du kan finne programvare oppdateringer og bruker dokumentasjon på D-Links web sider.

D-Link tilbyr sine kunder gratis teknisk support under produktets garantitid.

Kunder kan kontakte D-Links teknisk support via våre hjemmesider, eller på tlf.

Teknisk Support:

D-Link Teknisk telefon Support:

800 10 610

(Hverdager 08:00-20:00)

D-Link Teknisk Support over Internett:

<http://www.dlink.no>



Teknisk Support

Du finder software opdateringer og bruger-dokumentation på D-Link's hjemmeside.

D-Link tilbyder gratis teknisk support til kunder i Danmark i hele produktets garantiperiode.

Danske kunder kan kontakte D-Link's tekniske support via vores hjemmeside eller telefonisk.

D-Link teknisk support over telefonen:

Tlf. 7026 9040

Åbningstider: kl. 08:00 – 20:00

D-Link teknisk support på Internettet:

<http://www.dlink.dk>

[email:support@dlink.dk](mailto:support@dlink.dk)

D-Link[®]
Building Networks for People

Teknistä tukea asiakkaille Suomessa:

D-Link tarjoaa teknistä tukea asiakkailleen.

Tuotteen takuun voimassaoloajan.

Tekninen tuki palvelee seuraavasti:

Arkisin klo. 9 - 21

numerosta

0800-114 677

Internetin kautta

Ajurit ja lisätietoja tuotteista.

<http://www.dlink.fi>

Sähköpostin kautta

voit myös tehdä kyselyitä.

support@dlink.fi

D-Link[®]
Building Networks for People

Teknisk Support

På vår hemsida kan du hitta mer information om mjukvaru uppdateringar och annan användarinformation.

D-Link tillhandahåller teknisk support till kunder i Sverige under hela garantitiden för denna produkt.

Teknisk Support för kunder i Sverige:

D-Link Teknisk Support via telefon:

0770-33 00 35

Vardagar 08.00-20.00

D-Link Teknisk Support via Internet:

<http://www.dlink.se>

email:support@dlink.se

D-Link[®]
Building Networks for People

技术支持

办公地址：北京市朝阳区建国路 71 号惠通时代广场 C1 座
202 室 邮编: 100025

技术支持中心电话：8008868192/(028)85176977

技术支持中心传真：(028)85176948

维修中心地址：北京市朝阳区建国路 71 号惠通时代广场 C1 座
202 室 邮编: 100025

维修中心电话：(010) 58635800

维修中心传真：(010) 58635799

网址：<http://www.dlink.com.cn>

办公时间：周一到周五，早09:00到晚18:00

D-Link[®]
Building Networks for People

International Offices

U.S.A

17595 Mt. Herrmann Street
Fountain Valley, CA. 92708
TEL: 714-885-6000
Fax 866-743-4905
URL: www.dlink.com

Canada

2180 Winston Park Drive
Oakville, Ontario, L6H 5W1
Canada
TEL: 1-905-8295033
FAX: 1-905-8295223
URL: www.dlink.ca

Europe (U. K.)

4th Floor, Merit House
Edgware Road, Colindale
London NW9 5AB
U.K.
TEL: 44-20-8731-5555
FAX: 44-20-8731-5511
URL: www.dlink.co.uk

Germany

Schwalbacher Strasse 74
D-65760 Eschborn
Germany
TEL: 49-6196-77990
FAX: 49-6196-7799300
URL: www.dlink.de

France

Le Florilege #.2, Allee de la Fresnerie
78330 Fontenay le Fleury
France
TEL: 33-1-30238688
FAX: 33-1-30238689
URL: www.dlink-france.fr

Netherlands

Weena 290
3012 NJ Rotterdam
Netherlands
Tel: +31-10-282-1445
Fax: +31-10-282-1331
URL: www.dlink-benelux.com

Belgium

Rue des Colonies 11
B-1000 Brussels
Belgium
Tel: +32(0)2 517 7111
Fax: +32(0)2 517 6500
URL: www.dlink-benelux.com

Italy

Via Nino Bonnet n. 6/b
20154 – Milano,
Italy
TEL: 39-02-2900-0676
FAX: 39-02-2900-1723
URL: www.dlink.it

Sweden

P.O. Box 15036, S-167 15 Bromma
Sweden
TEL: 46-(0)8564-61900
FAX: 46-(0)8564-61901
URL: www.dlink.se

Denmark

Naverland 2, DK-2600
Glostrup, Copenhagen,
TEL: 45-43-969040
FAX: 45-43-424347
URL: www.dlink.dk

Norway

Karihaugveien 89
1086 Oslo
Norway
TEL: 47-23-897189
FAX: 47-22-309085
URL: www.dlink.no

Finland

Latokartanontie 7A
FIN-00700 HELSINKI
Finland
TEL : +358-10 309 8840
FAX: +358-10 309 8841
URL: www.dlink.fi

Iberia

C/Sabino De Arana,
56 Bajos
08028 Barcelona
TEL: 34 93 4090770
FAX: 34 93 4910795
URL: www.dlinkiberia.es

Singapore

1 International Business Park
#03-12 The Synergy
Singapore 609917
TEL: 65-6774-6233
FAX: 65-6774-6322
URL: www.dlink-intl.com

Australia

1 Giffnock Avenue,
North Ryde, NSW 2113
Australia
TEL: 61-2-8899-1800
FAX: 61-2-8899-1868
URL: www.dlink.com.au

India

D-Link House, Kurla Bandra Complex Road,
Off CST Road, Santacruz (East), Mumbai -
400098.
India
TEL: 91-022-26526696/56902210
FAX: 91-022-26528914
URL: www.dlink.co.in

Middle East (Dubai)

P.O.Box: 500376
Office No.: 103, Building:3
Dubai Internet City
Dubai, United Arab Emirates
Tel:+971-4-3916480
Fax:+971-4-3908881
URL: www.dlink-me.com

Turkey

Regus Offices
Beybi Giz Plaza, Ayazaga Mah. Meydan Sok.
No:28
Maslak 34396, Istanbul-Turkiye
TEL: +90 212 335 2553
FAX: +90 212 335 2500
URL: www.dlink.com.tr

Egypt

19 El-Shahed Helmy, El Masri
Al-Maza, Heliopolis
Cairo, Egypt.
TEL: +202 414 4295
FAX: +202 415 6704
URL: www.dlink-me.com

Israel

11 Hamanofim Street
Ackerstein Towers, Regus Business Center
P.O.B 2148, Hertzelia-Pituach 46120.
Israel
TEL: +972-9-9715700
FAX: +972-9-9715601
URL: www.dlink.co.il

LatinAmerica

Isidora Goyechea 2934 of 702,
Las Condes
Santiago – Chile S.A.
TEL: 56-2-232-3185
FAX: 56-2-232-0923
URL: www.dlink.cl

Brasil

Av das Nacoes Unidas,
11857 - 14 - andar - cj 141/142
Brooklin Novo
Sao Paulo - SP - Brazil
CEP 04578-000
TEL: +55 11 55039320
FAX: +55 11 55039322
URL: www.dlinkbrasil.com.br

South Africa

Einstein Park II
Block B
102-106 Witch-Hazel Avenue
Highveld Technopark
Centurion
Gauteng
Republic of South Africa
TEL: 27-12-665-2165
FAX: 27-12-665-2186
URL: www.d-link.co.za

Russia

Grafsky per., 14, floor 6
Moscow
129626 Russia
TEL: 7-095-744-0099
FAX: 7-095-744-0099 #350
URL: www.dlink.ru

China

No.202,C1 Building, Huitong Office Park,
No.71, Jianguo Road, Chaoyang District, Beijing,
100025, China.
TEL +86-10-58635800
FAX: +86-10-58635799
URL: www.dlink.com.cn

Taiwan

2F, No. 119, Pao-Chung Rd.
Hsin-Tien, Taipei
Taiwan
TEL: 886-2-2910-2626
FAX: 886-2-2910-1515
URL: www.dlinktw.com.tw

Headquarters

2F, No. 233-2, Pao-Chiao Rd.
Hsin-Tien, Taipei
Taiwan
TEL: 886-2-2916-1600
FAX: 886-2-2914-6299
URL: www.dlink.com

Registration Card

All Countries and Regions Excluding USA

Print, type or use block letters.

Your name: Mr./Ms _____
 Organization: _____ Dept. _____
 Your title at organization: _____
 Telephone: _____ Fax: _____
 Organization's full address: _____

 Country: _____
 Date of purchase (Month/Day/Year): _____

Product Model	Product Serial No.	* Product installed in type of computer (e.g., Compaq 486)	* Product installed in computer serial No.

(* Applies to adapters only)

Product was purchased from:

Reseller's name: _____
 Telephone: _____ Fax: _____
 Reseller's full address: _____

Answers to the following questions help us to support your product:

1. **Where and how will the product primarily be used?**
Home Office Travel Company Business Home Business Personal Use
2. **How many employees work at installation site?**
1 employee 2-9 10-49 50-99 100-499 500-999 1000 or more
3. **What network protocol(s) does your organization use ?**
XNS/IPX TCP/IP DECnet Others _____
4. **What network operating system(s) does your organization use ?**
D-Link LANsmart Novell NetWare NetWare Lite SCO Unix/Xenix PC NFS 3Com 3+Open
Banyan Vines DECnet Pathwork Windows NT Windows NTAS Windows '95
Others _____
5. **What network management program does your organization use ?**
D-View HP OpenView/Windows HP OpenView/Unix SunNet Manager Novell NMS
NetView 6000 Others _____
6. **What network medium/media does your organization use ?**
Fiber-optics Thick coax Ethernet Thin coax Ethernet 10BASE-T UTP/STP
100BASE-TX 100BASE-T4 100VGAnyLAN Others _____
7. **What applications are used on your network?**
Desktop publishing Spreadsheet Word processing CAD/CAM
Database management Accounting Others _____
8. **What category best describes your company?**
Aerospace Engineering Education Finance Hospital Legal Insurance/Real Estate Manufacturing
Retail/Chainstore/Wholesale Government Transportation/Utilities/Communication VAR
System house/company Other _____
9. **Would you recommend your D-Link product to a friend?**
Yes No Don't know yet
10. **Your comments on this product?**

