



User Manual

Vigilance Full HD Outdoor PoE Mini Bullet Camera

DCS-4703E

Preface

D-Link reserves the right to revise this publication and to make changes in the content hereof without obligation to notify any person or organization of such revisions or changes. Information in this document may become obsolete as our services and websites develop and change.

Manual Revisions

Revision	Date	Description
1.0	December 6, 2016	DCS-4703E Revision A1 with firmware version 1.00

Trademarks

D-Link and the D-Link logo are trademarks or registered trademarks of D-Link Corporation or its subsidiaries in the United States or other countries. All other company or product names mentioned herein are trademarks or registered trademarks of their respective companies.

Copyright © 2016 D-Link Corporation.

All rights reserved. This publication may not be reproduced, in whole or in part, without prior expressed written permission from D-Link Corporation.

Table of Contents

Product Overview.....	4	ICR and IR.....	42
Package Contents.....	4	HTTPS.....	43
Introduction.....	5	Access List.....	44
System Requirements	5	SNMP	45
Features.....	6	Maintenance.....	47
Hardware Overview	7	Admin.....	47
Front and Back.....	7	System	48
Sides	8	Firmware Upgrade.....	49
Mounting the Camera.....	9	Status	50
Waterproofing Your Installation	11	Device Info	50
Software Installation.....	14	Logs	51
Configuration	17	Help.....	52
Using the Configuration Interface.....	17	Technical Specifications.....	53
Live Video	19	Regulatory Information	55
Setup	20		
Setup Wizard	20		
Network Setup.....	25		
Dynamic DNS	28		
Image Setup	29		
Video	31		
Motion Detection	32		
Time and Date.....	33		
Event Setup.....	34		
Advanced.....	42		

Product Overview

Package Contents



DCS-4703E Vigilance Full HD Outdoor PoE Mini Bullet Camera



Cable Waterproofing Connector



Rubber Power Connector Plug



Mounting Kit



CD-ROM with User Manual and software



Quick Installation Guide



If any of the above items are missing, please contact your reseller.

Safety Notice: Installation and servicing should be done by certified technicians so as to conform to all local codes and prevent voiding your warranty.

Introduction

Congratulations on your purchase of the DCS-4703E Vigilance Full HD Outdoor PoE Mini Bullet Camera. The DCS-4703E is a professional surveillance and security solution for small, medium, and large enterprises alike. The DCS-4703E uses an HD progressive scan CMOS sensor; the professional sensor results in low noise and high sensitivity capabilities ideal for surveillance applications.

The DCS-4703E is a complete system with a built-in CPU and incorporates a web server, allowing it to transmit excellent real-time Full HD resolution video for security and outdoor surveillance.

The DCS-4703E can be accessed remotely, controlled and configured from any PC/Notebook over your local network or through the Internet via a web browser. The simple installation and intuitive web-based interface offer easy configuration across the full range of its advanced feature set, including granular control over multiple video streams with different configurations and multicast video streams which helps you manage your network load.

The DCS-4703E has an IP66 certified weatherproof housing designed for both indoor and outdoor applications. The built-in removable IR-cut filter and IR LEDs give the DCS-4703E the capability to view up to 30M at night. The DCS-4703E also incorporates Power over Ethernet (PoE), allowing it to be easily installed in a variety of locations without the need for supplemental power cabling. The combination of IP66 weatherproof housing, IR-Cut Filter, IR LEDs, and PoE make the DCS-4703E an ideal solution for a dependable and cost-effective 24 hour surveillance solution with easy clutter-free installation.

System Requirements

- Computer with Microsoft Windows® 10, 8, 7, or Vista® (for CD-ROM Setup Wizard), Mac OS X, or Linux
- Internet Explorer 7, Firefox 20, Chrome 20, or Safari 6 or higher
- Existing 10/100 Ethernet-based network with an available 802.3af Power over Ethernet (PoE) port

Features

Simple to Maintain

The DCS-4703E is a stand-alone system with a built-in CPU, requiring no special hardware or software. The DCS-4703E can be viewed and managed through most web browsers, including Internet Explorer®, Chrome®, Firefox®, and Safari®.

Supports a Variety of Platforms

With support for TCP/IP networking, HTTP, and other Internet related protocols, the DCS-4703E can also be integrated easily into other Internet/ Intranet applications because of its standards-based features. The DCS-4703E works with any 10/100 Ethernet network, making the DCS-4703E easy to integrate into your existing network environment.

Advanced Event Management

The DCS-4703E can be set up to send e-mail notifications with snapshots when an event occurs, such as when motion is detected. Events can be triggered from several sources, such as motion detection and time based events.

IR LEDs for Day and Night Functionality

The built-in infrared LEDs enable night time viewing of up to 20 meters.

IP66 Weatherproof Housing

The DCS-4703E uses an IP66 weatherproof housing, allowing you to rest assured that in the toughest of conditions, it will continue to provide round-the-clock surveillance.

PoE (Power over Ethernet) for Flexible Installation

The DCS-4703E can draw all the power it needs from a PoE switch or PoE injector for a simple and clutter-free installation.

Remote Monitoring Utility

The D-ViewCam application adds enhanced features and functionality for the Network Camera and allows administrators to configure and access the Network Camera from a remote site via Intranet or Internet. Other features include image monitoring, recording images to a hard drive, viewing up to 32 cameras on one screen, and taking snapshots.

Hardware Overview Front and Back

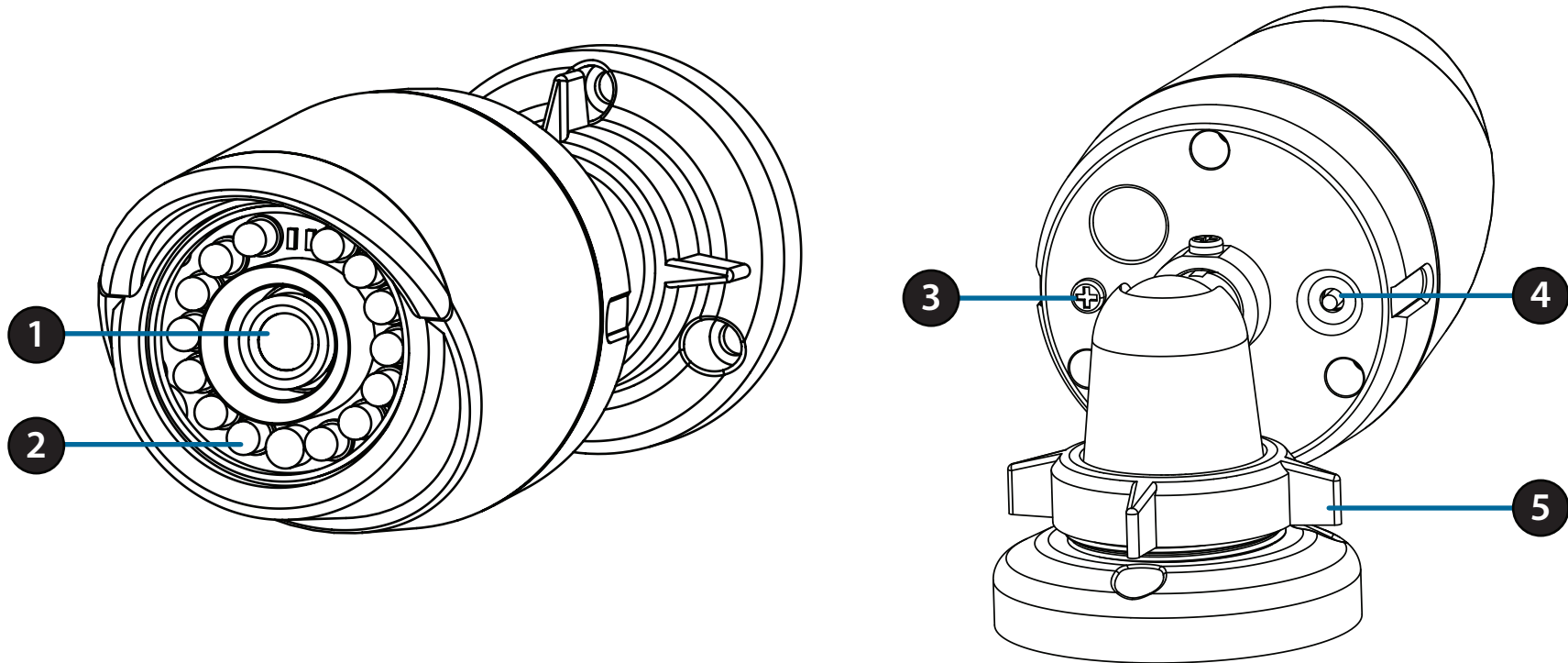

1	Camera Lens	Fixed lens to record video of the surrounding area
2	IR LEDs	Infrared LEDs illuminate the camera's field of view at night
3	Grounding Screw	Can be attached to a grounding wire if desired
4	Reset Button	Press and hold for 10 seconds to reset camera back to the factory default settings
5	Adjustment Ring	Loosen to adjust camera angle and tighten to lock camera angle

Sides

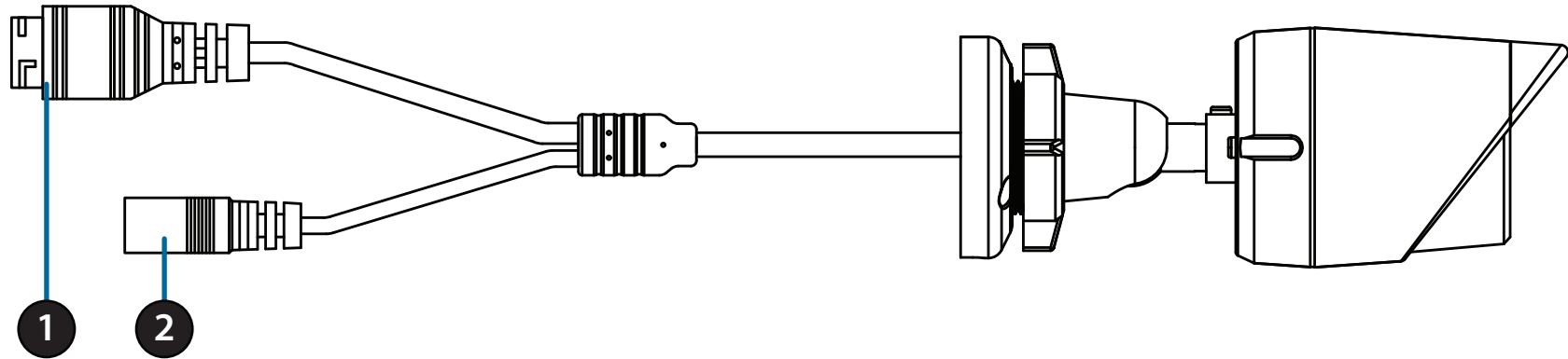

1	Ethernet Jack	RJ-45 connector for Ethernet, can also be used to power the camera using Power over Ethernet (PoE)
2	Power Connector	Connects to an optional 12 V / 1.5 A power adapter (not included)

Mounting the Camera

It is highly recommended that you configure and test your camera before mounting it.

Step 1

Place the mounting sticker where you want to position the camera. Make sure the camera base will be positioned so that the cable channel is on the bottom.

Use a 6 mm drill bit to make the required holes approximately 25 mm deep, then insert the wall anchors into the holes.

If you are running the camera cables through the wall, drill a hole in the center and pull the cables through the hole.

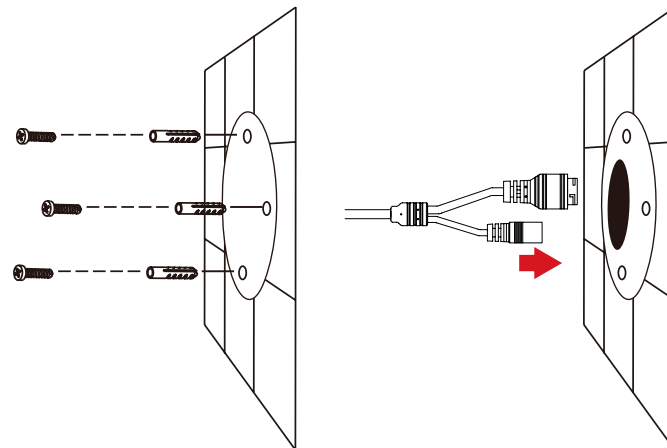

Step 2

Use the screws provided to mount the camera to the wall.

If you are running the camera cables out the side of the camera, guide the camera cables through the cable channel on the base.

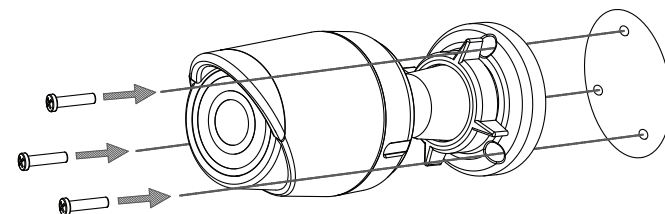

Step 3

Connect the power and Ethernet cables, or just the Ethernet cable if you are using a PoE connection.

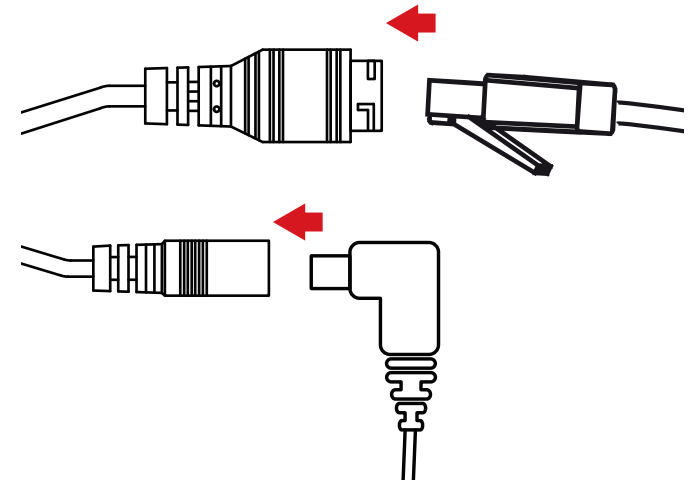

Step 4

To adjust the camera's angle, turn the adjustment ring counterclockwise to loosen it, then move the camera to the desired position and angle. When you are finished, turn the adjustment ring clockwise to tighten it.

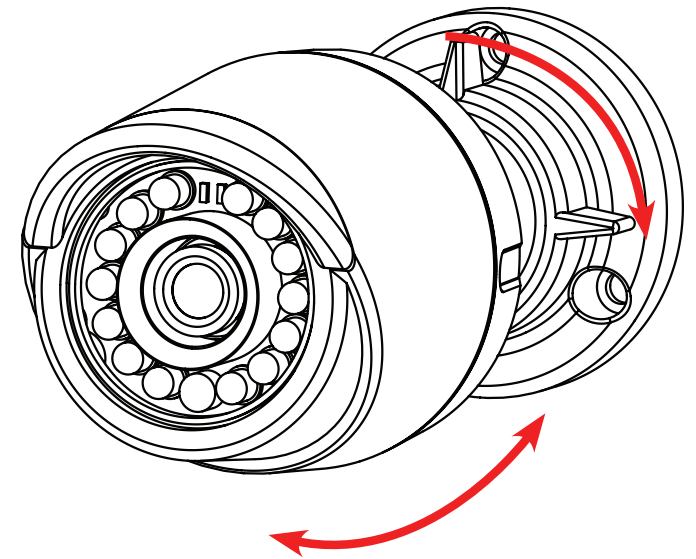

If you need to waterproof your installation, please continue to the next page.

Waterproofing Your Installation

To waterproof your camera installation, follow the instructions below. Round Ethernet cable, a crimping tool, and RJ-45 plugs are required for this procedure.

Step 1

Place the washer around the base of the Ethernet connector as shown.

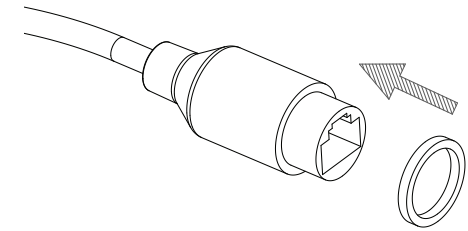

Step 2

Thread bare Ethernet cable through the waterproof connector as shown, then crimp an RJ-45 plug onto the cable.

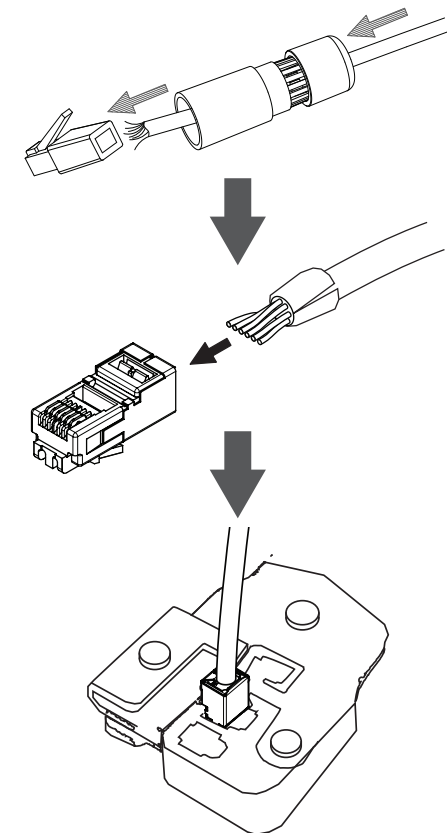

Step 3

Connect the RJ-45 plug into the Ethernet connector, then screw the waterproof connector to the Ethernet connector by turning it about a half-turn clockwise.

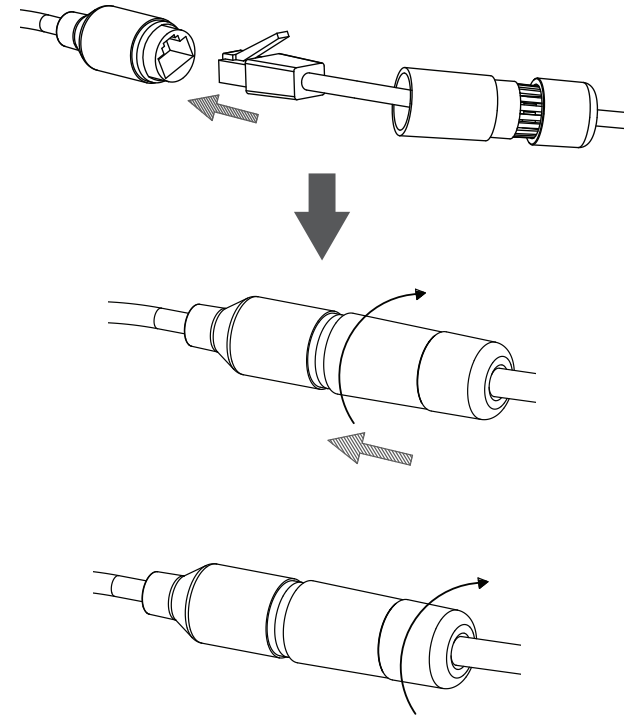

Step 4

Screw the back part of the waterproof connector clockwise until there is a tight seal around the Ethernet cable.

If you are using PoE to power your camera, use the included rubber power connector plug to the power connector.

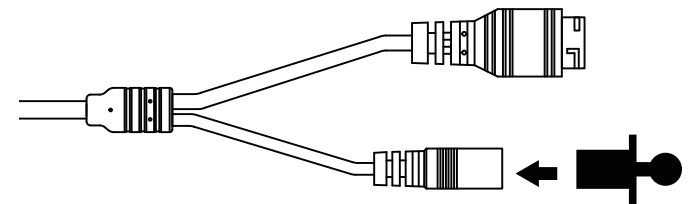

If you are using a power adapter(not included) to power your camera, wind waterproof tape around the connection in an overlapping manner to cover it.

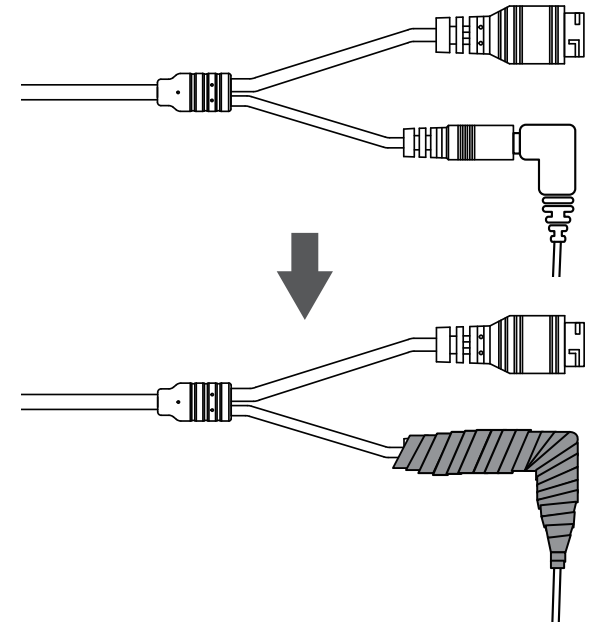

Software Installation

Step 1

Insert the DCS-4703E CD into your computer's CD-ROM drive to begin the installation.

If the Autorun function on your computer is disabled, or if the D-Link Launcher fails to start automatically, click the Start button and type **D:\autorun.exe** (where D: represents the drive letter of your CD-ROM drive) and press Enter.



Step 2

Click on the **D-Link Setup Wizard SE** icon that was created in your Windows Start menu (**Start > D-Link > Setup Wizard SE**).

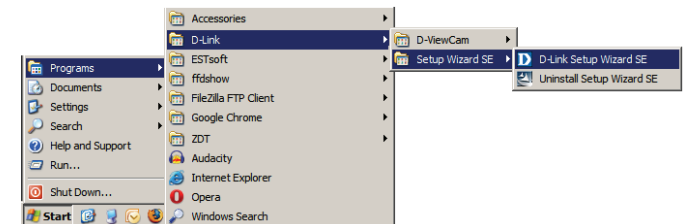

Step 3

The Setup Wizard will appear and display the MAC address and IP address of your camera(s). If you have a DHCP server on your network, a valid IP Address will be displayed. If your network does not use a DHCP server, the network camera's default static IP **192.168.0.20** will be displayed.

Select your camera, then click the **Wizard** button to continue.

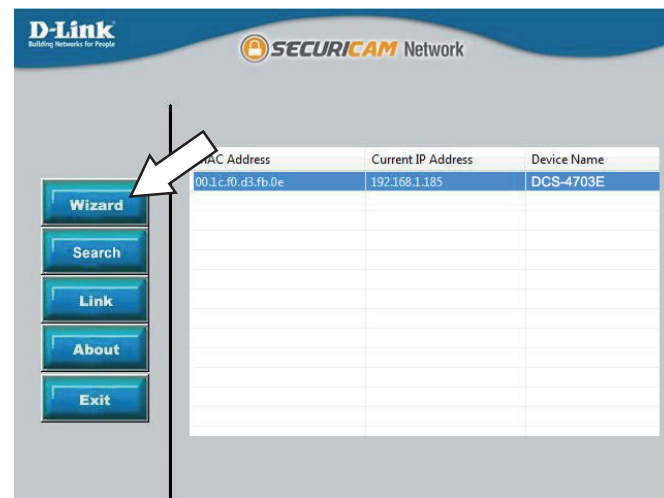

Step 4

Enter the Admin ID and password. When logging in for the first time, the default Admin ID is **admin** with the password left blank.

Click the checkboxes if you wish to change the admin ID and password for the camera, and enter the new ID and password you wish to use.

Click **Next** to continue.



Step 5

Select **DHCP** if your camera obtains an IP address automatically from a DHCP server such as a router. Select **Static IP** if you want to manually enter the IP settings for the camera.

Click **Next** to continue.

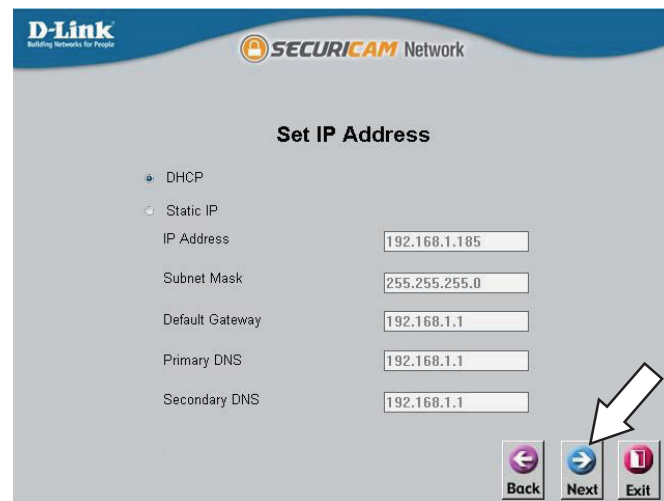

D-Link
Building Networks for People

SECURICAM Network

Set IP Address

DHCP

Static IP

IP Address

Subnet Mask

Default Gateway

Primary DNS

Secondary DNS

Step 6

Take a moment to confirm your settings and click **Restart**.

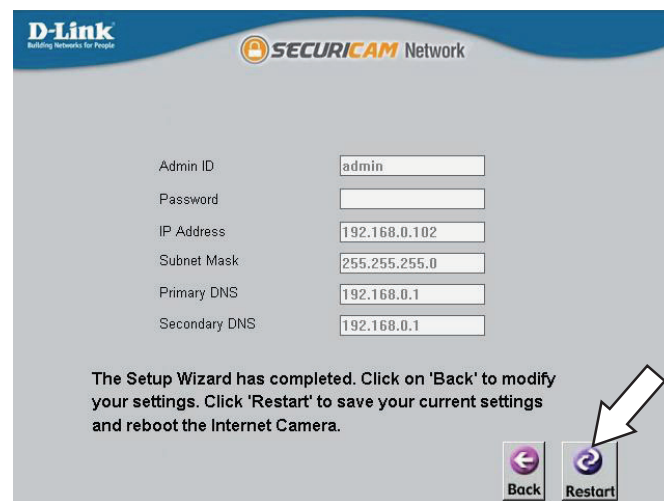

D-Link
Building Networks for People

SECURICAM Network

Admin ID

Password

IP Address

Subnet Mask

Primary DNS

Secondary DNS

The Setup Wizard has completed. Click on 'Back' to modify your settings. Click 'Restart' to save your current settings and reboot the Internet Camera.

Configuration

Using the Configuration Interface

After completing the Camera Installation Wizard, you are ready to use your camera. The camera's built-in Web configuration utility is designed to allow you to easily access and configure your DCS-4703E. At the end of the wizard, click **Link**, or enter the IP address of your camera into a web browser, such as Mozilla Firefox. To log in, use the User name **admin** and the password you created in the Installation Wizard. If you did not create a password, the default password is blank. After entering your password, click **OK**.

Step 1

Click on the **D-Link Setup Wizard SE** icon that was created in your Windows Start menu (**Start > D-Link > Setup Wizard SE**).

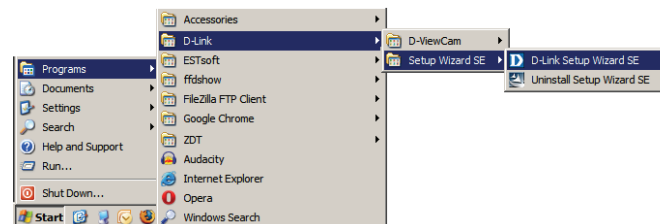

Step 2

Select the camera and click **Link** to access the web configuration.

The Setup Wizard will automatically open your web browser to the IP address of the camera.

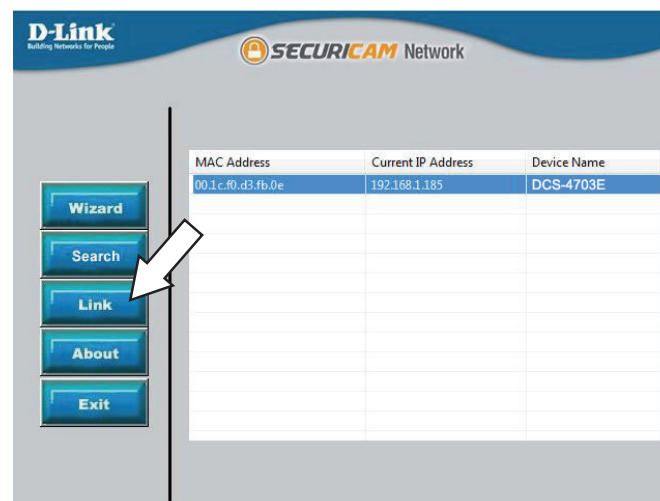

Step 3

The first time you connect to the camera, you will need to create a password for the administrator account. Enter a password, then click the **Save** button.

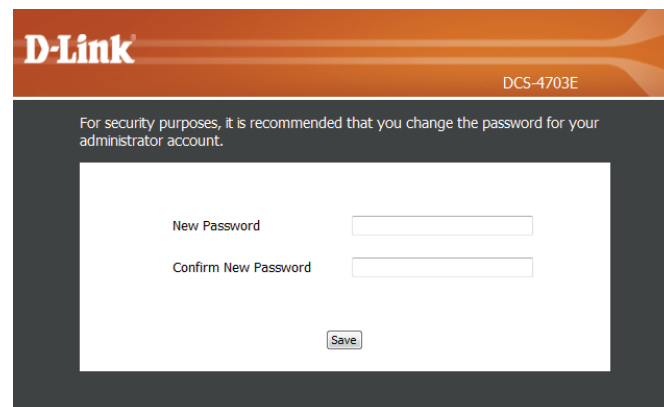

The screenshot shows the D-Link DCS-4703E web interface. At the top, the D-Link logo and model number are visible. A message states: "For security purposes, it is recommended that you change the password for your administrator account." Below this, there are two input fields: "New Password" and "Confirm New Password". A "Save" button is located at the bottom of the form.

Step 4

Enter **admin** as the username and enter the password you just created. Click **OK** to continue.



The screenshot shows a Windows Security dialog box titled "Windows Security". The message reads: "The server 192.168.0.188 at DCS-4703E requires a username and password." Below this, a warning states: "Warning: This server is requesting that your username and password be sent in an insecure manner (basic authentication without a secure connection)." There are two input fields: "admin" in the username field and "Password" in the password field. A checkbox labeled "Remember my credentials" is present. At the bottom, there are "OK" and "Cancel" buttons. A white arrow points to the "OK" button.

Step 5

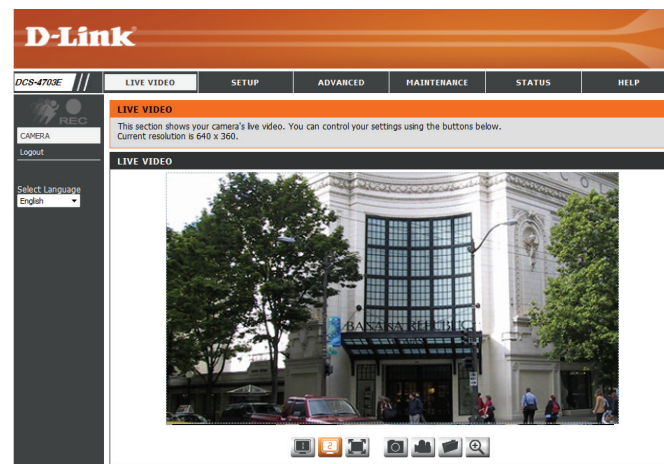

This section displays your camera's live video. You can select your video profile and view or operate the camera.









The screenshot shows the D-Link DCS-4703E web interface. The top navigation bar includes "LIVE VIDEO", "SETUP", "ADVANCED", "MAINTENANCE", "STATUS", and "HELP". The "LIVE VIDEO" section is active, displaying a live video feed of a street scene with a large building. Below the video feed, there are several control icons for zooming and other functions. On the left side, there is a sidebar with "CAMERA" and "Logout" options, and a "Select Language" dropdown menu set to "English".

Live Video

This section shows your camera's live video. You may select any of the available icons listed below to operate the camera. You may also select your language using the drop-down menu on the left side of the screen.

	Motion Trigger Indicator	This indicator will change color when a trigger event occurs. Note: The video motion feature for your camera must be enabled.
	Recording Indicator	When a recording is in progress, this indicator will change color.

Language: You may select the interface language using this menu.

	Video Profile 1/2	Select a video profile to use. For more on setting up your video profiles, refer to Video on page 31.
	Full Screen Mode	This will switch to a full-screen view of your camera's video. Double-click or press the Esc key to exit full-screen mode.
	Take a Snapshot	This will save a snapshot to your PC using the storage folder you have selected.
	Record a Video Clip	This will start recording a video clip to your PC using the storage folder you have selected. Click it again to stop recording. If you close the browser window, the recording will stop.
	Set a Storage Folder	Select a storage folder to save snapshots and video clips to.
	Zoom	This will open a window that will allow you to use a slider to digitally zoom in and out. The red box shows what portion of the live video will be visible, and the box can be dragged to move the view to another part of the live video.

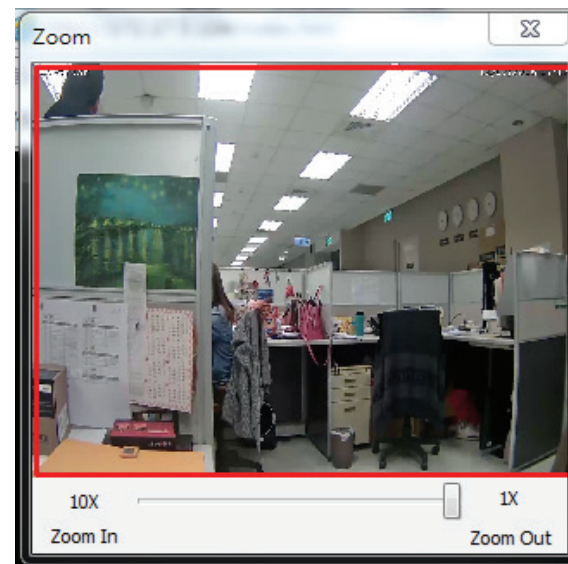
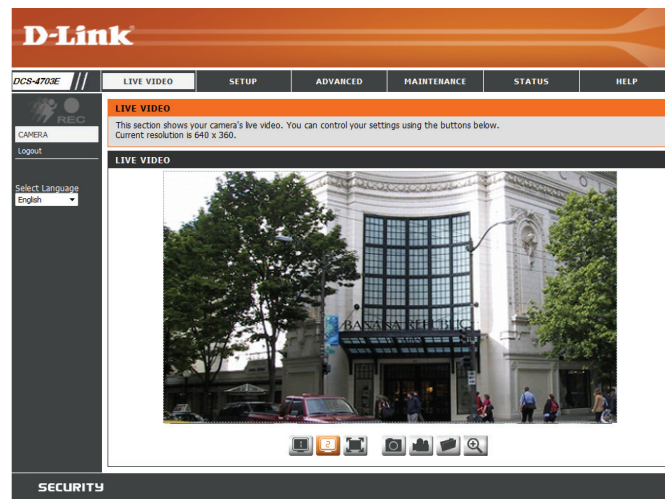

Setup

Setup Wizard

To configure your Network Camera, click **Internet Connection Setup Wizard**. Alternatively, you may click **Manual Internet Connection Setup** to manually configure your Network Camera and skip to **Network Setup** on page 25.

To quickly configure your Network Camera's motion detection settings, click **Motion Detection Setup Wizard**. If you want to enter your settings without running the wizard, click **Manual Motion Detection Setup** and skip to **Motion Detection** on page 32.

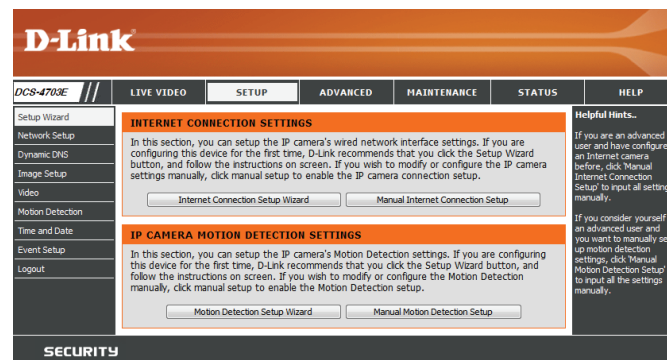

Internet Connection Setup Wizard

This wizard will guide you through a step-by-step process to configure your new D-Link Camera and connect the camera to the internet. Click **Next** to continue.

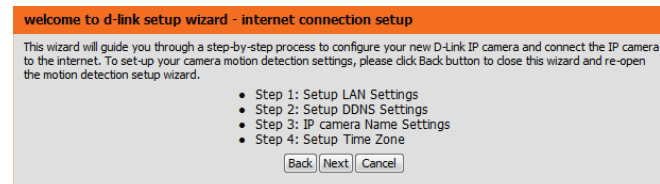

Select how the camera will connect to the Internet.

If your camera is connected to a router, or you are unsure how your camera will connect to the Internet, select DHCP Connection.

Select **Static IP** if your Internet Service Provider has provided you with connection settings, or if you wish to set a static address within your home network. Enter the correct configuration information and click **Next** to continue.

If you are using PPPoE, select **Enable PPPoE** and enter your user name and password.

Click **Next** to continue.

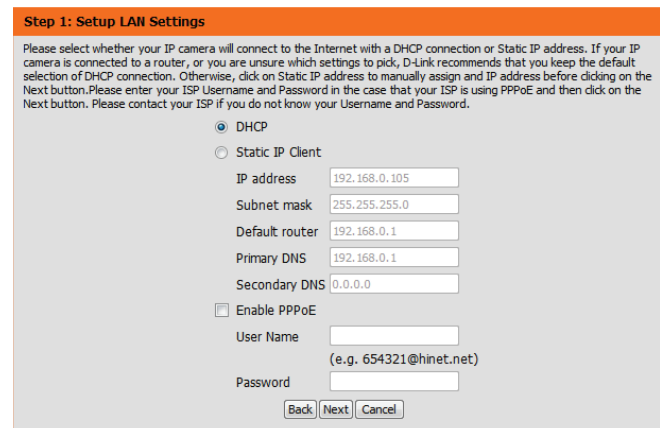

Section 3: Configuration

If you have a Dynamic DNS account and would like the camera to update your IP address automatically, Select **Enable DDNS** and enter your host information. Click **Next** to continue.

Step 2: Setup DDNS Settings

If you have a Dynamic DNS account and would like the IP camera to update your IP address automatically, enable DDNS and enter in your host information below. Please click on the Next button to continue.

Enable DDNS

Server Address <<

Host Name

User Name

Password

Verify Password

Timeout (hours)

Enter a name for your camera and click **Next** to continue.

Step 3: IP camera Name Settings

D-Link recommends that you rename your IP camera for easy accessibility. You can then identify and connect to your IP camera via this name. Please assign a name of your choice before clicking on the Next button.

IP camera Name

Configure the correct time to ensure that all events will be triggered as scheduled. Click **Next** to continue.

Step 4: Setup Time Zone

Please configure the correct time to ensure that all events are triggered, captured and scheduled at the correct time and day and then click on the Next button.

Time Zone

Enable Daylight Saving

If you have selected DHCP, you will see a summary of your settings, including the camera's IP address. Please write down all of this information as you will need it in order to access your camera.

Click **Apply** to save your settings.

Step 5: Setup complete

Below is a summary of your IP camera settings. Click on the Back button to review or modify settings or click on the Apply button if all settings are correct. It is recommended to note down these settings in order to access your IP camera on the network or via your web browser.

IP Address	DHCP
IP camera Name	DCS-4703E
Time Zone	(GMT+08:00) Taipei
DDNS	Disable
PPPoE	Disable

Motion Detection Setup Wizard

This wizard will guide you through a step-by-step process to configure your camera's motion detection functions.

Click **Next** to continue.

Step 1

This step will allow you to enable or disable motion detection, specify the detection sensitivity, and adjust the camera's ability to detect movement.

You may specify whether the camera should capture a snapshot or a video clip when motion is detected.

Refer to **Motion Detection** on page 32 for information about how to configure motion detection.

Step 2

This step allows you to enable motion detection based on a customized schedule. Specify the day and hours. You may also choose to always record whenever motion is detected.

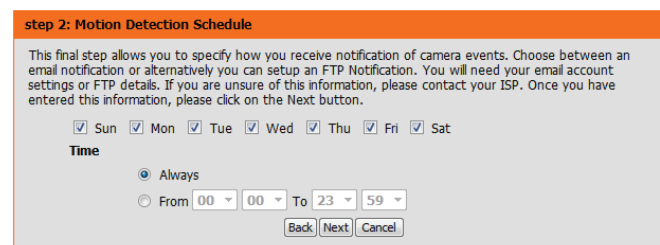
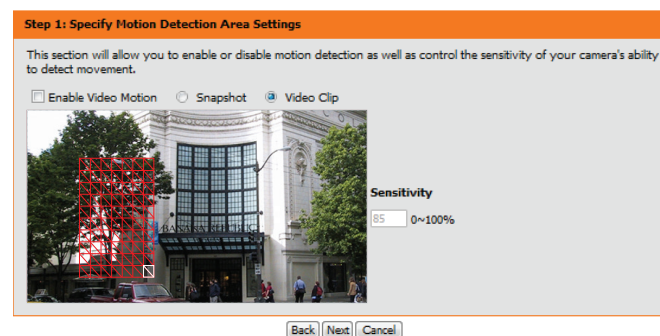
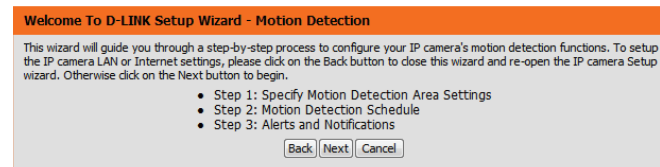

Section 3: Configuration

Step 3

This step allows you to specify how you will receive event notifications from your camera. You may choose not to receive notifications, or to receive notifications via e-mail or FTP.

Please enter the relevant information for your e-mail or FTP account.

Click **Next** to continue.

Step 3: Alerts and Notification

This final step allows you to specify how you receive notification of camera events. Choose between an email notification or alternatively you can setup an FTP Notification. You will need your email account settings or FTP details. If you are unsure of this information, please contact your ISP. Once you have entered this information, please click on the Next button.

Do not notify me

Email

Sender email address:

Recipient email address:

Server address:

User name:

Password:

Port:

This server requires a secure connection (StartTLS)

FTP

Server address:

Port:

User name:

Password:

Remote folder name:

Step 4

You have completed the Motion Detection Wizard.

Please verify your settings and click **Apply** to save them.

Step 4: Setup Complete

You have completed your IP camera setup. Please click the Back button if you want to review or modify your settings or click on the Apply button to save and apply your settings.

Motion Detection : Enable

EVENT : Video Clip

Schedule Day : Sun , Mon , Tue , Wed , Thu , Fri , Sat ,

Schedule Time : Always

Alerts and Notification : Email

Please wait a few moments while the camera saves your settings and restarts.

Step 4: Setup Complete

You have completed your IP camera setup. Please click the Back button if you want to review or modify your settings or click on the Apply button to save and apply your settings.

Changes saved. IP camera's network is restarting, please wait for 6 seconds ...

Network Setup

Use this section to configure the network connections for your camera. All relevant information must be entered accurately. After making any changes, click the **Save Settings** button to save your changes.

LAN Settings: This section lets you configure settings for your local area network.

DHCP: Select this connection if you have a DHCP server running on your network and would like your camera to obtain an IP address automatically.

If you choose DHCP, you do not need to fill out the IP address settings.

Static IP Client: You may obtain a static or fixed IP address and other network information from your network administrator for your camera.

IPv4 Address: Enter the IP address that the camera will use on your network. You may need to get this information from your ISP or network administrator.

Subnet Mask: The default value is "255.255.255.0." Used to determine if the destination is part of the same subnet.

Default Router: The router used to forward frames to destinations in a different subnet. Invalid router settings may cause the failure of transmissions to a different subnet.

Optional Primary DNS: Primary domain name server that translates names to IP addresses.

Optional Secondary DNS: Secondary domain name server to backup the Primary DNS.

Enable UPnP Presentation: Enabling this setting allows your camera to be configured as a UPnP device on your network.

D-Link

DCS-4703E // LIVE VIDEO SETUP ADVANCED MAINTENANCE STATUS HELP

Setup Wizard
Network Setup
Dynamic DNS
Image Setup
Video
Motion Detection
Time and Date
Event Setup
Logout

NETWORK SETUP
You can configure your LAN and Internet settings here.
Save Settings Don't Save Settings

LAN SETTINGS

DHCP
 Static IP Client

IP address: 192.168.0.188
Subnet mask: 255.255.255.0
Default router: 192.168.0.1
Primary DNS: 192.168.0.1
Secondary DNS: 0.0.0.0

Enable UPnP presentation
 Enable UPnP port forwarding
Forwarding Port: 1024 [Test]
Forwarding Status: UPnP forwarding is inactive

PPPOE SETTINGS

Enable Disable

User Name:
Password:
Confirm password:
PPPOE Status: PPPOE is inactive.

HTTP

HTTP port: 80
Access name for stream1: video1.mpeg
Access name for stream2: video2.mpeg

HTTPS

HTTPS port: 443

RTSP

Authentication: Digest
RTSP port: 554
Access name for stream1: live1.sdp
Access name for stream2: live2.sdp

CoS SETTINGS

Enable CoS

VLAN ID: 1 [0-4095]
Live video: 0
Live audio: 0
Event/Alarm: 0
Management: 0

QoS SETTINGS

Enable QoS

Live video: 0
Live audio: 0
Event/Alarm: 0
Management: 0

Helpful Hints...

Select DHCP Connection: If you are running a DHCP server on your network and would like an IP address assigned to your IP camera automatically.

UPnP: Enabling UPnP settings will allow you to configure your IP camera as an UPnP device in the network.

PPPOE Setting: If you use the IP camera to connect directly to the Internet, you will need to enter the username and password, which were given to you when you set up your account with your Internet Service Provider. If the camera is behind a router or a gateway, you do not need to configure this setting.

HTTP: HTTP Port is the port you allocate in order to connect to the IP camera via a standard web browser.

HTTPS: HTTPS Port in a IP camera connects it with a PC via a secure web browser.

RTSP: RTSP Port is the port you allocate in order to connect to a IP camera by using streaming mobile device(s), such as a mobile phone or PDA.

CoS (Class of Service): Coarsely grained traffic control based on the L2 protocol. Class of Service technologies do not guarantee a level of service in terms of bandwidth and delivery time, they offer a "best-effort".

QoS (Quality of Service): Packet or packet traffic control, a resource reservation control mechanism. Quality of service guarantees are important; if the network capacity is insufficient, especially for real-time streaming multimedia applications.

Enable IPv6: Select this option and click Save to enable IPv6 setting. Please note that this only works if your network environment and hardware equipment support IPv6. The browser should be Microsoft® Internet Explorer 6.5, Mozilla Firefox 3.0 or above. When IPv6 is enabled, by default, the Network Camera will listen to router advertisements and be assigned a link-local IPv6 address accordingly.

IPv6 Information: Click this button to obtain the IPv6 information. If your

Enable UPnP Port Forwarding: Enabling this setting allows the camera to add port forwarding entries into the router automatically on a UPnP capable network.

Enable PPPoE: Enable this setting if your network uses PPPoE.

User Name / Password: Enter the username and password for your PPPoE account. Re-enter your password in the Confirm Password field. You may obtain this information from your ISP.

HTTP Port: The default port number is 80.

Access Name for Stream 1~3: The default name is video#.mjpg, where # is the number of the stream.

HTTPS Port: You may use a PC with a secure browser to connect to the HTTPS port of the camera. The default port number is 443.

Authentication: Choose to enable or disable RTSP digest encryption. Digest encryption uses MD5 hashes.

RTSP Port: The port number that you use for RTSP streaming to mobile devices, such as mobile phones or PDAs. The default port number is 554. You may specify the address of a particular stream. For instance, live1.sdp can be accessed at rtsp://x.x.x.x/video1.sdp where the x.x.x.x represents the IP address of your camera.

Enable CoS: Enabling the Class of Service setting implements a best-effort policy without making any bandwidth reservations.

Enable QoS: Enabling QoS allows you to specify a traffic priority policy to ensure a consistent Quality of Service during busy periods. If the Network Camera is connected to a router that itself implements QoS, the router's settings will override the QoS settings of the camera.

LAN SETTINGS	
<input checked="" type="radio"/> DHCP	
<input type="radio"/> Static IP Client	
IP address	<input type="text" value="192.168.0.188"/>
Subnet mask	<input type="text" value="255.255.255.0"/>
Default router	<input type="text" value="192.168.0.1"/>
Primary DNS	<input type="text" value="192.168.0.1"/>
Secondary DNS	<input type="text" value="0.0.0.0"/>
<input checked="" type="checkbox"/> Enable UPnP presentation	
<input type="checkbox"/> Enable UPnP port forwarding	
Forwarding Port	<input type="text" value="1024"/> <input type="button" value="Test"/>
Forwarding Status	UPnP forwarding is inactive

PPPOE SETTINGS	
<input type="radio"/> Enable <input checked="" type="radio"/> Disable	
User Name	<input type="text"/>
Password	<input type="text"/>
Confirm password	<input type="text"/>
PPPoE Status	PPPoE is inactive.

HTTP	
HTTP port	<input type="text" value="80"/>
Access name for stream1	<input type="text" value="video1.mjpeg"/>
Access name for stream2	<input type="text" value="video2.mjpeg"/>

HTTPS	
HTTPS port	<input type="text" value="443"/>

RTSP	
Authentication	<input type="text" value="Digest"/>
RTSP port	<input type="text" value="554"/>
Access name for stream1	<input type="text" value="live1.sdp"/>
Access name for stream2	<input type="text" value="live2.sdp"/>

COS SETTINGS	
<input type="checkbox"/> Enable CoS	
VLAN ID	<input type="text" value="1"/> [0~4095]
Live video	<input type="text" value="0"/>
Live audio	<input type="text" value="0"/>
Event/Alarm	<input type="text" value="0"/>
Management	<input type="text" value="0"/>

QOS SETTINGS	
<input type="checkbox"/> Enable QoS	
Live video	<input type="text" value="0"/>
Live audio	<input type="text" value="0"/>
Event/Alarm	<input type="text" value="0"/>
Management	<input type="text" value="0"/>

Enable Multicast for stream: The DCS-4703E allows you to multicast each of the available streams via a group address and specify the TTL value for each stream. Enter the port and TTL settings you wish to use if you do not want to use the defaults.

Enable Bonjour: Checking the **Bonjour** box will allow the camera to be discoverable on the network and visible to Apple devices.

Bonjour Name: Enter the name to identify this camera on Bonjour.

QOS SETTINGS

Enable QoS

Live video	0
Live audio	0
Event/Alarm	0
Management	0

IPv6

Enable IPv6

IPv6 Information

Manually setup the IP address

Optional IP address / Prefix length: /

Optional default router:

Optional primary DNS:

MULTICAST

Enable multicast for stream 1

Multicast group address	<input type="text" value="239.1.1.1"/>
Multicast video port	<input type="text" value="6550"/>
Multicast RTCP video port	<input type="text" value="6551"/>
Multicast TTL [1~255]	<input type="text" value="64"/>

Enable multicast for stream 2

Multicast group address	<input type="text" value="239.1.1.2"/>
Multicast video port	<input type="text" value="6554"/>
Multicast RTCP video port	<input type="text" value="6555"/>
Multicast TTL [1~255]	<input type="text" value="64"/>

BONJOUR SETTINGS

Enable Bonjour

Bonjour Name: 32 characters maximum

(Characters you may use in a Bonjour Name: "upper or lower case letters", "numbers" and "hyphens".)

Dynamic DNS

DDNS allows you to access your camera using a domain name instead of an IP address. To do this, you will need to have an account with one of the DDNS services listed in the drop-down box on this page. After making any changes, click the **Save Settings** button to save your changes.

Enable DDNS: Check this box to enable the DDNS function.

Server Address: Select your Dynamic DNS Server from the drop down menu.

Host Name: Enter the host name of the DDNS server.

User Name: Enter the username or e-mail address used to connect to the DDNS server.

Password: Enter the password used to connect to the DDNS server.

Timeout: You can set up how often the camera notifies the DDNS server of its current global IP address by entering a whole number in hours.

Status: This shows the current status of your DDNS updates.

The screenshot shows the D-Link web interface for the DCS-4703E camera. The top navigation bar includes 'LIVE VIDEO', 'SETUP', 'ADVANCED', 'MAINTENANCE', 'STATUS', and 'HELP'. The left sidebar lists various setup options: Setup Wizard, Network Setup, Dynamic DNS, Image Setup, Video, Motion Detection, Time and Date, Event Setup, and Logout. The main content area is titled 'DYNAMIC DNS' and contains the following configuration options:

- Enable DDNS:** A checkbox that is currently unchecked.
- Server Address:** A dropdown menu showing 'www.dlinkddns.com' with a '<<' button to the left and a dropdown arrow to the right.
- Host Name:** An empty text input field.
- User Name:** An empty text input field.
- Password:** An empty text input field.
- Verify Password:** An empty text input field.
- Timeout:** A text input field containing '24' followed by '(hours)'.
- Status:** A dropdown menu showing 'Inactive'.

Below the configuration fields are two buttons: 'Save Settings' and 'Don't Save Settings'. To the right of the main content area is a 'Helpful Hints...' section with text explaining the Dynamic DNS feature and a link to 'Sign up for D-Link's Free DDNS service at www.DLinkDDNS.com'. The bottom of the page features a 'SECURITY' header.

Image Setup

In this section, you may configure the video image settings for your camera. A preview of the image will be shown in Live Video.

Enable Privacy Mask: The Privacy Mask setting allows you to specify up to 3 rectangular areas on the camera's image to be blocked/excluded from recordings and snapshots.

You may click and drag the mouse cursor over the camera image to draw a mask area. Right clicking on the camera image brings up the following menu options:

- **Disable All:** Disables all mask areas
- **Enable All:** Enables all mask areas
- **Reset All:** Clears all mask areas.

Mirror: This will mirror the image horizontally.

Flip: This will flip the image vertically. When turning Flip on, you may want to consider turning Mirror on as well.

Anti Flicker: Select the frequency used by your power lines to avoid camera flicker or moving bars in your video. Generally, if your power outlets are 220 to 240 V, you should select **50 Hz**. If your power outlets are 100 to 120 V, you should select **60 Hz**.

White Balance: Use the drop-down box to change white balance settings to help balance colors for different environments. You can choose from Auto, Outdoor, Indoor, and Fluorescent.

Exposure Mode: Changes the exposure mode. Use the drop-down box to set the camera for Indoor, Outdoor, or Night environments, or to Moving to capture moving objects. The Low Noise option will focus on creating a high-quality picture without noise. You can also create 3 different custom exposure modes. The Max Gain setting will allow you to control the maximum amount of gain to apply to brighten the picture.

The screenshot shows the D-Link camera web interface. The top navigation bar includes 'LIVE VIDEO', 'SETUP', 'ADVANCED', 'MAINTENANCE', 'STATUS', and 'HELP'. The 'SETUP' menu is expanded, showing options like 'Setup Wizard', 'Network Setup', 'Dynamic DNS', 'Image Setup', 'Video', 'Motion Detection', 'Time and Date', 'Event Setup', and 'Logout'. The 'IMAGE SETUP' page is active, displaying a message: 'Changes to your IP camera settings are made immediately.' Below this is the 'PRIVACY MASK AREA OF VIDEO SETTING' section, which includes a video preview of a building and a 'Save' button. To the right of the preview are instructions for enabling the privacy mask setting and a list of actions: 'Privacy mask: mask 3 privacy area(s) on video.', 'Click the right mouse button on the video control to show the popmenu.', 'Press the left mouse button, drag and drop to set the privacy area.', 'Privacy area can be enabled or disabled.', and 'After you finish all privacy mask settings, click the Save button.' Below the privacy mask section is the 'IMAGE SETTINGS' section, which includes controls for 'Mirror' (On/Off), 'Flip' (On/Off), 'Anti Flicker' (60 Hz/50 Hz), 'White Balance' (Auto), 'Exposure Mode' (Customize1), 'Shutter' (Min: 1/10000, Max: 1/30), 'Denoise' (1), 'Brightness' (100), 'Contrast' (100), 'Saturation' (100), 'Sharpness' (100), 'WDR Level' (2), and '3D filter' (ON/OFF). A 'Reset Default' button is located at the bottom of the settings section. On the far right, there is a 'Helpful Hints...' section with text explaining the Privacy Mask, Mirror, Flip, and Anti Flicker functions, as well as White Balance, Exposure Mode, Max Gain, and Denoise.

Shutter: This setting will appear if a custom Exposure Mode is selected. Set the minimum and maximum shutter speed (in seconds) the camera will use. Shorter shutter speeds will provide a sharper picture, but require more available light. Longer shutter speeds will provide a brighter picture in low-light environments, but may blur objects that are in motion.

Denoise: This setting controls the amount of noise reduction that will be applied to the picture.

Brightness: Adjust this setting to compensate for backlit subjects.

Contrast: Adjust this setting to alter the color intensity/strength.

Saturation: This setting controls the amount of coloration, from grayscale to fully saturated.

Sharpness: Specify a value from 0 to 8 to specify how much sharpening to apply to the image.

WDR Level: WDR makes it easier to see objects that may appear dark due to strong backlighting conditions during the daytime. Higher WDR levels will make it easier to see objects in shadows.

3D Filter: This setting controls the amount of 3D filtering that will be applied to the picture. 3D filtering reduces the amount of image noise when viewing a low-light environment.

Reset Default: Click this button to reset the image settings to the factory defaults.

The screenshot displays the 'IMAGE SETTINGS' menu with the following options and values:

- Mirror: On Off
- Flip: On Off
- Anti Flicker: 60 Hz 50 Hz
- White Balance: Auto
- Exposure Mode: Customize1 Max Gain: 42 dB
- Shutter: Min: 1/10000 Max: 1/30
- Denoise: 1
- Brightness: 100
- Contrast: 100
- Saturation: 100
- Sharpness: 100
- WDR Level: 2
- 3D filter: ON OFF

A 'Reset Default' button is located at the bottom right of the settings panel.

Video

You may configure up to 2 video profiles with different settings for your camera. Hence, you may set up different profiles for your computer and mobile display. After making any changes, click the **Save Settings** button to save your changes.

Aspect ratio: Set the aspect ratio of the video to 4:3 standard or 16:9 widescreen. After changing this setting, click **Save**.

Mode: Set the video codec to be used to H.264 or JPEG.

Frame size: Frame size determines the total capture resolution. You can select different frame sizes depending on the aspect ratio being used:

- 16:9 1920 x 1080, 1280 x 720, 800 x 448, 640 x 360
- 4:3 2048 x 1536, 1440 x 1080, 1280 x 960, 900 x 720, 800 x 592, 640 x 480

Maximum frame rate: A higher frame rate provides smoother motion for videos and requires more bandwidth. Lower frame rates will result in stuttering motion and requires less bandwidth.

Video Quality: This limits the maximum frame rate, which can be combined with the **Fixed quality** option to optimize the bandwidth utilization and video quality. If fixed bandwidth utilization is desired regardless of the video quality, choose **Constant bit rate** and select the desired bandwidth. When using the JPEG codec, you can only select a **Fixed quality** option.

Constant bit rate: The bps will affect the bit rate of the video recorded by the camera. Higher bit rates result in higher video quality.

Fixed quality: Select the image quality level for the camera to try to maintain. High quality levels will result in increased bit rates.

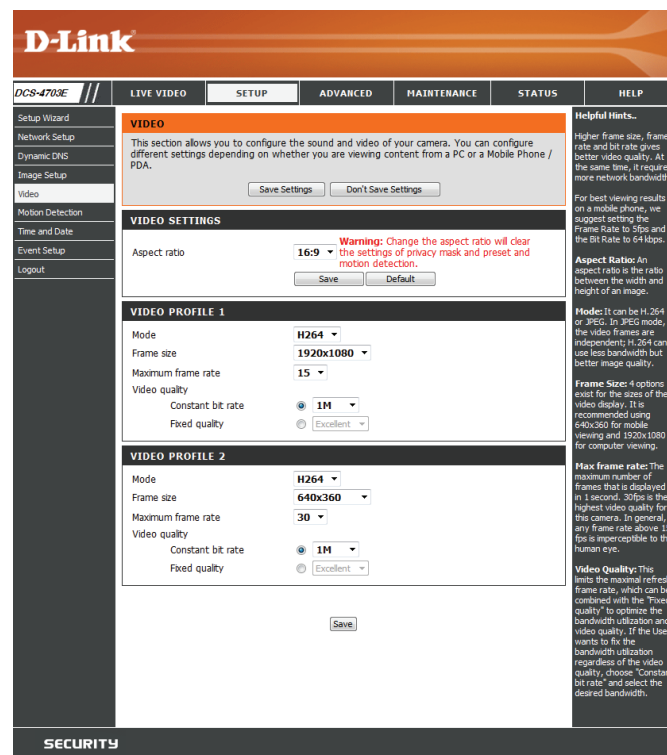

Motion Detection

Motion detection enables the camera to monitor the video feed for movement. Here, you can adjust the sensitivity settings that determine whether motion is detected by the camera or not. After making any changes, click the **Save Settings** button to save your changes.

Enable Video Motion: Select this box to enable the motion detection feature of your camera.

Sensitivity: Specifies how sensitive motion detection will be from 0% to 100%. A low sensitivity setting means that there must be large changes between two images in order to detect motion, and a high sensitivity setting means that even small changes will cause motion to be detected.

Draw Motion Area: Use your mouse to click and drag on the areas that you would like to monitor for motion.

Erase Motion Area: To erase a motion detection area, simply click on the red square that you wish to remove.

Right click on the camera image to bring up the following menu options:

Select All: Draws a motion detection area over the entire screen.

Clear All: Clears any motion detection areas that have been drawn.

Restore: Restores the previously specified motion detection areas.

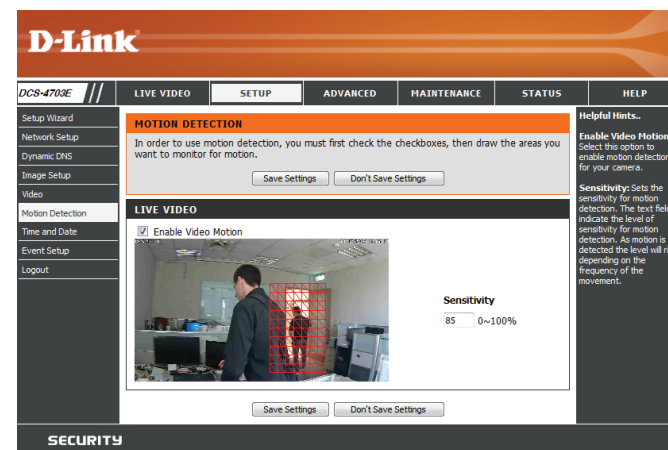

Time and Date

This section allows you to automatically or manually configure, update, and maintain the internal system clock for your camera. After making any changes, click the **Save Settings** button to save your changes.

Time Zone: Select your time zone from the drop-down menu.

Enable Daylight Saving: If your region uses Daylight Saving time, you can enable it here. Select **Set date and time manually** if you want to manually set the offset and the period of time that the Daylight Saving correction should be used.

Synchronize with NTP Server: Network Time Protocol (NTP) will synchronize your camera with an Internet time server. Choose the one that is closest to your camera, or select **Get NTP Server from DHCP** to try and get the NTP server information automatically from your DHCP server.

Set the Date and Time Manually: If **Synchronize NTP Server** is disabled, you can set the date and time manually. You can also click the **Copy Your Computer's Time Settings** button to automatically copy the date and time of the PC you are using.

D-Link

DCS-4703E // LIVE VIDEO SETUP ADVANCED MAINTENANCE STATUS HELP

TIME AND DATE
You can set the current time for the IP camera.
Save Settings Don't Save Settings

TIME CONFIGURATION
Time Zone (GMT +08:00) Taipei
 Enable Daylight Saving
 Auto Daylight Saving
 Set date and time manually
Offset: +02:00
Start time: 1 1 Sunday 0 0
End time: 1 1 Sunday 0 0

AUTOMATIC TIME CONFIGURATION
 Synchronize with NTP Server
NTP Server: ntp1.dlink.com << Select NTP Server

SET DATE AND TIME MANUALLY
 Set date and time manually
Year: 2016 Month: 11 Day: 17
Hour: 12 Minute: 6 Second: 6
Copy Your Computer's Time Settings
Save Settings Don't Save Settings

Helpful Hints...
Good timekeeping is important for accurate logs and scheduled firewall rules.
Time Zone: Select your time zone from the drop-down menu.
Enable Daylight Saving: Select this to enable the daylight saving time.
Auto Daylight Saving: When you select it, the clock is automatically adjusted according to the daylight saving time of the selected time zone.
Offset: Select the time offset, if your location observes daylight saving time.
Synchronize with NTP Servers: With the option selected, the camera will synchronize the time settings with the NTP server over the Internet whenever the camera starts up. If the timeserver cannot be reached, no time settings will be applied.
NTP Server: Network Time Protocol (NTP) synchronizes the IP camera with an Internet time server. Choose the one that is closest to your location.
Copy Your Computer's Time Settings: This will synchronize the time information from your PC.

SECURITY

Event Setup

The DCS-4703E has a versatile Event system that lets you configure the camera to perform certain actions when an event occurs. For example, when motion is detected, you can have snapshots sent to an FTP server or e-mail address. You can also configure the camera to take regular video recordings according to a schedule you define.

Before setting up an event, you will need to specify the following:

- **Server:** This is a destination for media to be sent to, such as an e-mail address or FTP server.
- **Media:** This is the media that will be sent, such as snapshots, video clips, or a system log.

You can then set up Events and Recordings:

- **Event:** This is the actual trigger event that the camera is monitoring for, and the action that it will take. Event triggers include motion detection, loss of network connection, system reboot, and other events.
- **Recording:** This lets you set up a schedule for regular video recording.

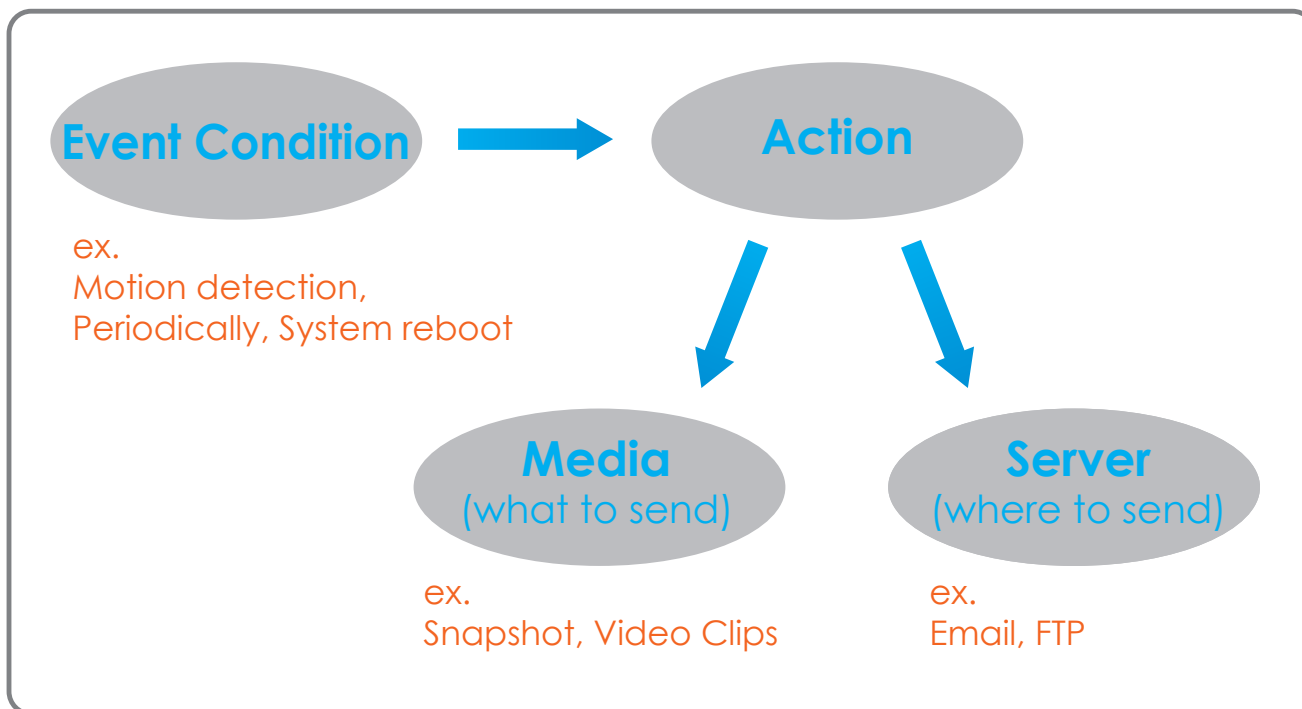

The Event Setup page includes 4 different sections.

- Event
- Server
- Media
- Recording

1. To add a new item server, media, event, or recording item click **Add**. A screen will appear and allow you to update the fields accordingly.
2. To delete the selected item from the server, media, event, or recording drop-down menus, click the **Delete** button next to it.
3. Click on an item to edit it.

Add Server

You can configure up to five servers (destinations) to save snapshots and/or video to. After making any changes, click the **Save Settings** button to save your changes.

Server Name: Enter the name for the server.

E-mail: If you want to use an e-mail address for your server, select this and enter the settings for your target e-mail account.

FTP: If you want to use an FTP server for your server, select this and enter the settings for your target FTP server.

Network Storage: If you want to use a network storage device for your server, select this and enter its settings here. You can only specify a network storage device for one of your server entries.

Add Media

There are three types of media: **Snapshot**, **Video Clip**, and **System Log**. After making any changes, click the **Save Settings** button to save your changes.

Media Name: Enter a unique name for media type you want to create.

Snapshot: Select this option to set the media type to snapshots.

Source: Set the video profile to use as the media source. Refer to **Video** on page 31 for more information on video profiles.

Send pre-event image(s) [0~3]: Set the number of pre-event images to take. Pre-event images are images taken before the main event snapshot is taken.

Send post-event image(s) [0~7]: Set the number of post-event images to take. Post-event images are images taken after the main event snapshot is taken. You can set up to 7 post-event images to be taken.

For example:

If both the Send pre-event images and Send post-event images are set to four, a total of 9 images are generated after a trigger is activated.

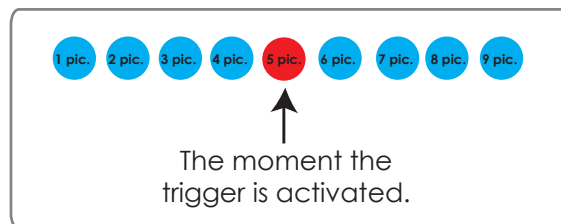

File name prefix: The prefix name will be added to the file name.

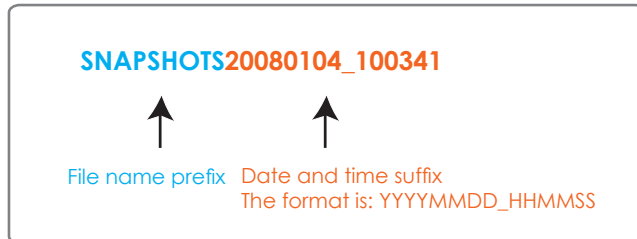

Add date and time suffix to file name: Check this to add the date and time the snapshot was recorded as a file name suffix.

Video clip: Select this option to set the media type to video clips.

Source: Set the video profile to use as the media source. Refer to **Video** on page 31 for more information on video profiles.

Pre-event recording: This sets how many seconds to record before the main event video clip starts. You can record up to 4 seconds of pre-event video.

Maximum duration: Set the maximum length of video to record for your video clips.

Maximum file size: Set the maximum file size to record for your video clips.

File Name Prefix: This is the prefix that will be added to the filename of saved video clips.

System log: Select this option to set the media type to system logs. This will save the event to the camera system log, but will not record any snapshots or video.

MEDIA TYPE

Media name:

Snapshot

Source: profile 1

Send pre-event image(s) [0~4]

Send post-event image(s) [0~7]

File Name Prefix:

Add date and time suffix to file name

Video Clip

Source: profile 1

Pre-event recording: Second(s) [0~3]

Maximum duration: Second(s) [1~100]

Maximum file size: Kbytes [300~5000]

File Name Prefix:

System log

Add Event

Create and schedule up to three events with their own settings here. After making any changes, click the **Save Settings** button to save your changes.

Event name: Enter a name for the event.

Enable this event: Select this box to activate this event.

Priority: Set the priority for this event. The event with higher priority will be executed first.

Delay: Specify the delay time before allowing this event to be triggered again. This is used for both motion detection events and digital input triggers.

Trigger: Specify the input type that triggers the event.

Video Motion Detection: Selecting this will trigger the event when motion is detected during live video monitoring. Make sure you have enabled motion detection and specified what part of the image to monitor for motion. For more details, refer to **Motion Detection** on page 32.

Periodic: Selecting this will trigger the event in specified intervals. The trigger interval unit is in minutes.

System Boot: Selecting this will trigger an event when the system boots up.

Network Lost: Selecting this will trigger an event when the camera's connection to the network is lost.

Event Schedule: Specify when you want to monitor for this event. Select which days to monitor for this event, then select **Always** or enter the time interval to monitor for the specified event.

The screenshot shows the D-Link DCS-4703E web interface for configuring an event. The main content area is titled 'EVENT' and contains the following sections:

- EVENT:**
 - Event name: [Text input field]
 - Enable this event
 - Priority: normal (dropdown)
 - Delay for 10 seconds before detecting next event [For motion detection]
- TRIGGER:**
 - Video motion detection
 - Periodic (Trigger every 1 minutes)
 - System boot
- EVENT SCHEDULE:**
 - Days: Sun, Mon, Tue, Wed, Thu, Fri, Sat (all checked)
 - Time:
 - Always
 - From 00:00 To 23:59
- ACTION:**
 - FTP
 - Attached media: Take snapshots (dropdown)

Buttons for 'Save Settings' and 'Don't Save Settings' are located at the bottom of the configuration area. A 'Helpful Hints...' sidebar on the right provides additional information about event priority, motion detection windows, periodic intervals, system boot events, and scheduling options.

Section 3: Configuration

Action: If you have created Server and Media entries, you will see them appear here. Select which Server you want to send to and which Media you want the camera to send.

ACTION

FTP

Attached media:

Add Recording

Here you can configure and schedule the recording settings. After making any changes, click the **Save Settings** button to save your changes.

Recording entry name: Enter a name for the recording.

Enable this recording: Select this to enable the recording function.

Priority: Set the priority for this entry. An entry with a higher priority value will be executed first.

Source: Select the video profile to use as the recording source.

Recording schedule: Use the checkboxes to set which days to record video on. Select **Always** to record for the entire day, or select From and select what period of time you want to record using the dropdown boxes.

Destination: Select where the recording file will be stored. You should set up a Server entry for a network storage drive first.

Total cycling recording size: Please input a HDD volume between 1MB and 2TB for recording space. The recording data will replace the oldest record when the total recording size exceeds this value. For example, if each recording file is 6MB, and the total cyclical recording size is 600MB, then the camera will record 100 files in the specified location (folder) and then will delete the oldest file and create new file for cyclical recording.

Please note that if the free HDD space is not enough, the recording will stop. Before you set up this option please make sure your HDD has enough space, and it is better to not save other files in the same folder as recording files.

Size of each file for recording: If this is selected, files will be separated based on the file size you specify.

Time of each file for recording: If this is selected, files will be separated based on the maximum length you specify.

File Name Prefix: The prefix name will be added to the file name of the recording file(s).

RECORDING

Recording entry name:

Enable this recording

Priority: normal

Source: profile 1

RECORDING SCHEDULE

Sun Mon Tue Wed Thu Fri Sat

Time

Always

From To

RECORDING SETTINGS

Destination: None

Total cycling recording size: Mbytes [200~2000000]

Size of each file for recording: Mbytes

Time of each file for recording: seconds

File Name Prefix:

Advanced

ICR and IR

Here you can configure the ICR and IR settings. The IR (Infrared) Cut-Removable (ICR) filter can be disengaged for increased sensitivity in low light environments.

Automatic: The Day/Night mode is set automatically. You can use the **Sensitivity** drop-down box to set when the camera will switch to Night mode. The text box to the right shows what lighting conditions are currently being detected by the camera for reference. You can refresh this status by clicking the **Refresh** button.

Day Mode: Day mode enables the IR Cut Filter.

Night Mode: Night mode disables the IR Cut Filter.

Schedule Mode: Set up the Day/Night mode using a schedule. The camera will enter Day mode at the starting time and return to Night mode at the ending time.

IR Light Control: The camera can enable or disable the IR (infrared) light according to your preferences. This setting provides additional controls depending on your specific application.

Off: The IR light will always be off.

On: The IR light will always be on.

Sync with ICR: The IR light will turn on when the ICR filter is disabled (night mode).

Schedule: The IR light will turn on or off according to the schedule that you specify below.

D-Link

DCS-4703E // LIVE VIDEO SETUP ADVANCED MAINTENANCE STATUS HELP

ICR and IR

ICR AND IR

An IR(Infrared) Cut-Removable(ICR) filter can be disengaged from the image path for increased sensitivity in low light environments. The ICR filter will automatically engage depending on the ambient light, allowing the camera to be effective in day/night environments.

- Select the Day/Night from the radio button. The available options are Automatic, Schedule mode, Day mode and Night mode.
- The default value is Automatic.

Light Sensor Sensitivity
Light sensor sensitivity has Low, Medium, and High three different levels. You may get current camera light illumination by clicking Refresh button to set proper level of Light sensor sensitivity. For example, when level sets at High less than 30lux, camera will switch Day & Night mode to Night mode.

IR Light
The built-in IR light illuminators will be activated automatically or manually so as to supplement the low light situation without additional equipment.

Save Settings Don't Save Settings

ICR

Removable IR-Cut filter trigger condition:

Automatic Sensitivity: Medium: <20lux over 30 lux Refresh

Day mode

Night mode

Schedule mode

Day mode(24hr)
From 00 00 To 23 59

IR LIGHT

IR Light Control Highest

Off

On

Sync. With ICR

Schedule

IR Light Control On(24hr)
From 00 00 To 23 59

Save Settings Don't Save Settings

Helpful Hints...

Automatic: The day/night mode is set automatically. It is normally set in the Day mode and changes to the Night mode in a dark place.

Day mode: The Day mode means enable the IR Cut Filter.

Night mode: The Night mode means disable the IR Cut Filter.

Schedule mode: Set the Day/Night mode using the schedule. Fill in the line so the Day/Night mode is normally set to Day mode and it enters the Day mode at the start time and returns to the Night mode at the end time.

IR Light Control: In poor light conditions, open IR Light Control to automatically turn on the light to enable you to take clear picture. The IR Light Control has 4 options: Off, On, Sync. with ICR, and Schedule. Off: This option disable the IR Light Control. On: This option automatically opens the IR Light Control to enable a camera to take clear images in poor light conditions. Sync. with ICR: In this option, the IR Light Control will open automatically and follow the ICR setting. Schedule: In this option, you have to customize the setting to set the time period you want. Please set the Start time and the End time of your chosen schedule.

SECURITY

HTTPS

This page allows you to install and activate an HTTPS certificate for secure access to your camera. After making any changes, click the **Save Settings** button to save your changes.

Enable HTTPS Secure Connection: Enable the HTTPS service.

Create Certificate Method: Choose the way the certificate should be created. Three options are available:

- Create a self-signed certificate automatically
- Create a self-signed certificate manually
- Create a certificate request and install

Status: Displays the status of the certificate.

Note: The certificate cannot be removed while HTTPS is still enabled. To remove the certificate, you must first uncheck **Enable HTTPS secure connection**.

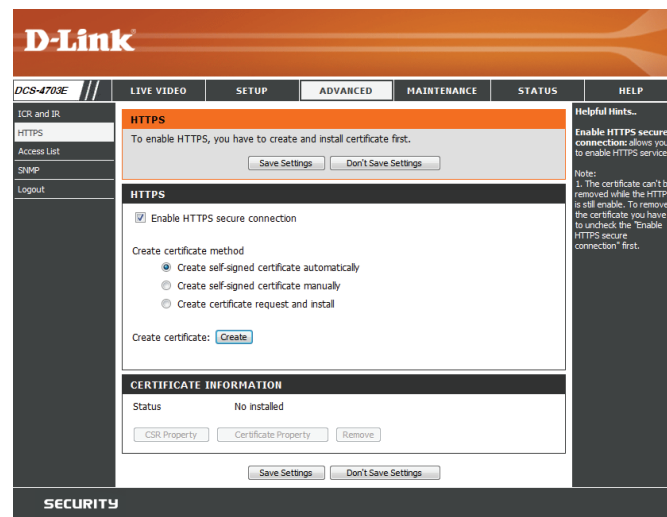

Access List

Here you can set access permissions for users to view your DCS-4703E.

Allow list: The list of IP addresses that have access rights to the camera.

Note: When adding entries to the Allow list, make sure the first entry includes the IP address of the computer or device you are using to access the camera. Otherwise, you may be blocked from accessing the camera after adding the entry to the Allow list.

Start IP address: The starting IP address of the IP address range for the devices (such as a computer) that have permission to access the video of the camera.

End IP address: The ending IP address of the IP address range for the devices (such as a computer) that have permission to access the video of the camera. Click **Add** to save your changes.

Note: A total of seven lists can be configured for both columns.

Delete allow list: Select an entry to remove from the Allow List, then click **Delete**.

Deny list: The list of IP addresses that have no access rights to the camera.

Delete deny list: Select an entry to remove from the Deny List, then click **Delete**.

Note: All addresses in the Deny List will be denied access, even if they are also in the Allow List.

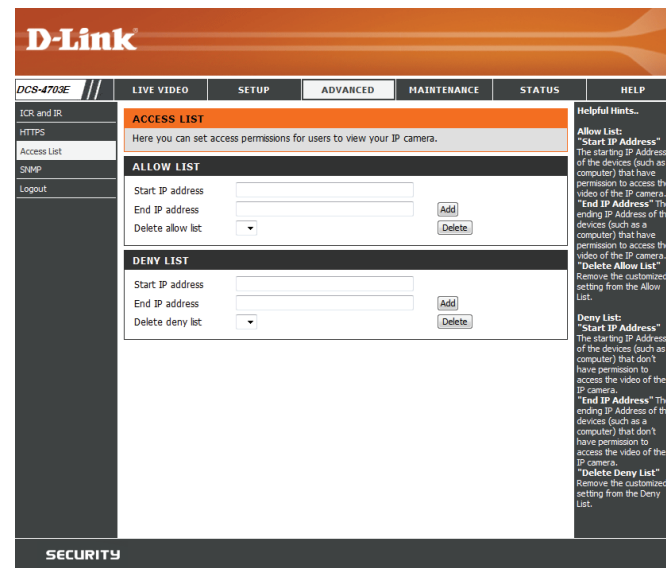

SNMP

Here you can set the SNMP settings for the camera, which allow for SNMP management of the camera.

Enable SNMPv1, SNMPv2c: Enable this option to allow for SNMPv1 and SNMPv2c management of the camera.

Read/Write Community: Enter a name for the read/write community of your SNMP server.

Read Only Community: Enter a name for the read-only community of your SNMP server.

Enable SNMPv3: Enable this option to allow SNMPv3 management of the camera.

Read/Write Security Name: Enter a name for the read/write community of your read/write SNMP server.

Authentication Type: Enter the type of authentication used by your read/write SNMP server.

Authentication Password: Enter the authentication password used for your read/write SNMP server.

Encryption Password: Enter the encryption password used for your read/write SNMP server.

Read Only Security Name: Enter a name for the read-only community of your read-only SNMP server.

Authentication Type: Enter the type of authentication used by your read-only SNMP server.

D-Link

DCS-4703E // LIVE VIDEO SETUP **ADVANCED** MAINTENANCE STATUS HELP

ICR and IR
HTTPS
Access List
SNMP
Logout

SNMP

The Simple Network Management Protocol is an application layer protocol that facilitates the exchange of management information between network devices. It helps network administrators to remotely manage network devices and find, solve network problems with ease.

Save Settings Don't Save Settings

SNMP CONFIGURATION

Enable SNMPv1, SNMPv2c

Read/Write community

Read only community

Enable SNMPv3

Read/Write Security name

Authentication type

Authentication password

Encryption password

Read only security name

Authentication type

Authentication password

Encryption password

Save Settings Don't Save Settings

Helpful Hints...

Enable SNMPv1, SNMPv2c: Select this option and enter the names of Read/Write community and Read Only community according to your NMS setting.

Enable SNMPv3: This option contains cryptographic security, a higher security level which allows you to set the Authentication password and the Encryption password. According to your NMS setting, choose Read/Write or Read Only and enter the community name.

Authentication type: Select MD5 or SHA as the authentication method.

Authentication password: Enter the password for authentication (at least 8 characters).

Encryption password: Enter a password for encryption (at least 8 characters).

SECURITY

Section 3: Configuration

Authentication Password: Enter the authentication password used for your read-only SNMP server.

Encryption Password: Enter the encryption password used for your read-only SNMP server.

SNMP CONFIGURATION
 Enable SNMPv1, SNMPv2c
Read/Write community
Read only community
 Enable SNMPv3
Read/Write Security name
Authentication type
Authentication password
Encryption password
Read only security name
Authentication type
Authentication password
Encryption password

Maintenance Admin

You may modify the name and administrator's password of your camera, as well as add and manage the user accounts for accessing the camera. You may also use this section to create a unique name and configure the OSD settings for your camera.

Admin Password Setting: Set a new password for the administrator's account.

Add User Account: To add a new user account, fill out the User Name and Password for the new account, then click **Add**.

User Name: Enter the user name for the new account.

Password: Enter the password for the new account.

User List: All the existing user accounts will be displayed here. You select an account and click the **Delete** button to remove it. You may want to reserve at least one as a guest account.

IP Camera Name: Create a unique name for your camera that will be added to the file name prefix when creating a snapshot or a video clip.

Enable OSD: Select this option to enable the On-Screen Display feature for your camera.

Label: Enter a label for the camera, which will be shown on the OSD when it is enabled.

LED: You may specify whether or not to illuminate the status LED on the camera.

D-Link

DCS-4703E // LIVE VIDEO SETUP ADVANCED MAINTENANCE STATUS HELP

ADMIN

Here you can change the administrator's password for your IP camera as well as add and/or delete user account(s). You can configure the information, such as IP camera's name and time via this page. You can also enable the OSD (On-Screen Display) feature in order to display the IP camera name and time stamp for your video recordings.

ADMIN PASSWORD SETTING

New Password 63 characters maximum
Retype Password

ADD USER ACCOUNT

User Name 5 users maximum
New Password 63 characters maximum
Retype Password

USER LIST

User Name -- User list --

DEVICE SETTING

IP Camera Name DCS-4703E 16 characters maximum
 Enable OSD
Label DCS-4703E 16 characters maximum

LED

LED On Off

Helpful hints...

Enabling OSD, the IP camera's name and time will be displayed on the video screen for the user.

For security purposes, it is recommended that you change the password for your administrator account. Be sure to write down the new password to avoid having to reset the IP camera in the event that it is forgotten.

LED: In the near panel of your camera there is a LED beside the network adapter. ON: The LED will flash a light to indicate if the network is working or not. OFF: No light will show, forth option is turn off.

SECURITY

System

In this section, you may back up, restore and reset the camera configuration, or reboot the camera.

Save To Local Hard Drive: You may save your current camera configuration as a file on your computer.

Load From Local Hard Drive: Locate a pre-saved configuration by clicking **Browse** and then restore the pre-defined settings to your camera by clicking **Load Configuration**.

Restore to Factory Defaults: You may reset your camera and restore the factory settings by clicking **Restore Factory Defaults**.

Reboot Device: This will restart your camera.

Enable Schedule Reboot: If you want your camera to reboot on a regular schedule, check the **Enable Schedule Reboot** checkbox, then select the days and time you want the camera to reboot on.

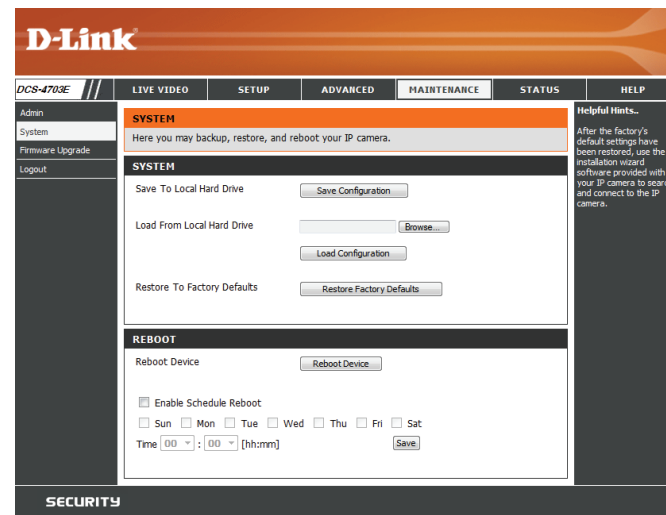

Firmware Upgrade

The camera's current firmware version will be displayed on this screen. You may visit the D-Link Support Website to check for the latest available firmware version.

To upgrade the firmware on your DCS-4703E, please download and save the latest firmware version from the D-Link Support Page to your local hard drive. Locate the file on your local hard drive by clicking the **Browse** button. Select the file and click the **Upload** button to start upgrading the firmware.

Current Firmware Version: Displays the detected firmware version.

Current Product Name: Displays the camera model name.

File Path: Select a firmware file to use on your hard drive by clicking **Browse**.

Upload: Uploads the selected firmware to your camera.



Status

Device Info

This page displays detailed information about your device and network connection.

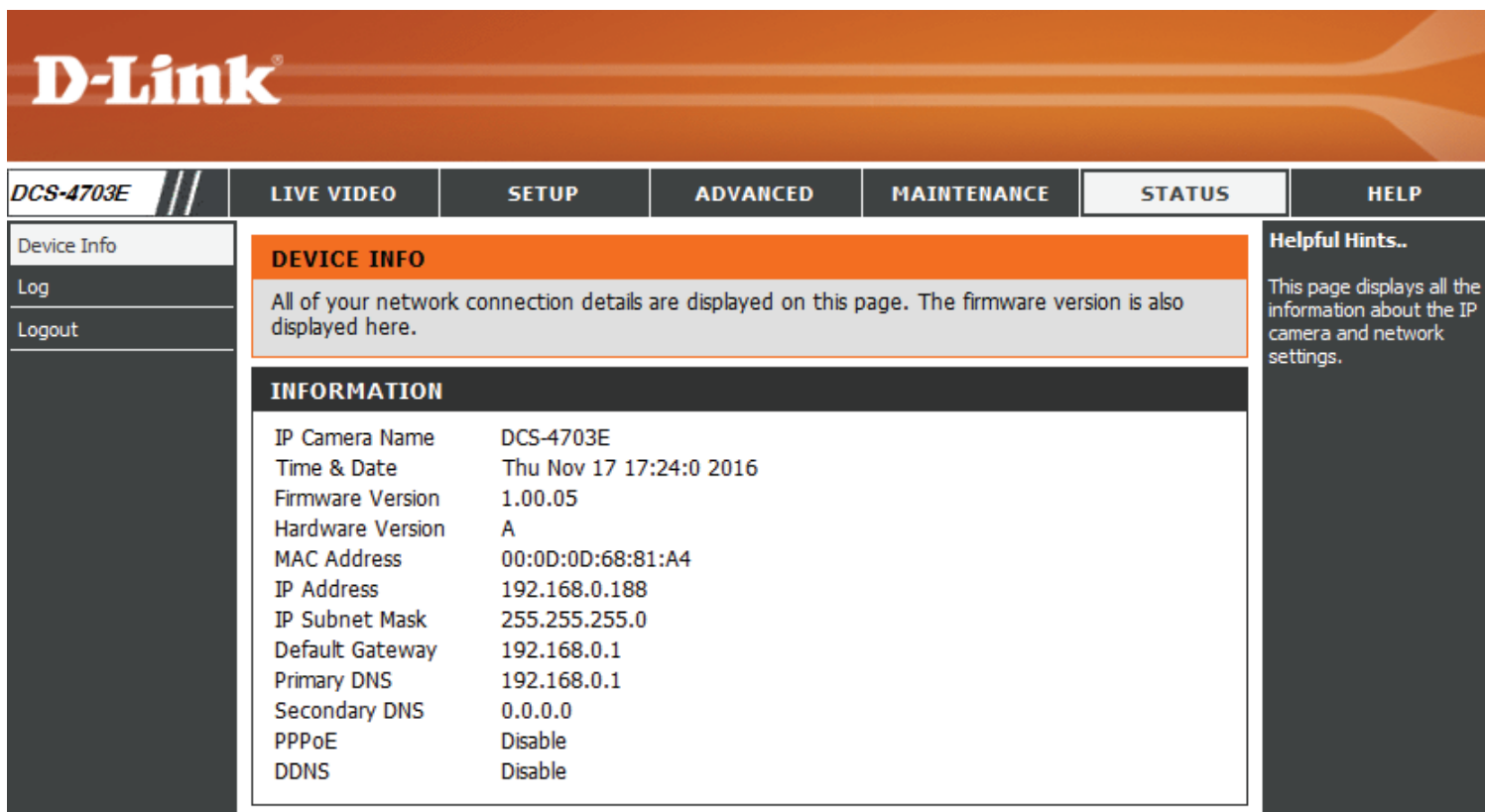

The screenshot shows the D-Link web interface for the DCS-4703E device. The top navigation bar includes links for LIVE VIDEO, SETUP, ADVANCED, MAINTENANCE, STATUS (selected), and HELP. The left sidebar contains links for Device Info (selected), Log, and Logout. The main content area is titled 'DEVICE INFO' and contains a message: 'All of your network connection details are displayed on this page. The firmware version is also displayed here.' Below this is an 'INFORMATION' table with the following data:

INFORMATION	
IP Camera Name	DCS-4703E
Time & Date	Thu Nov 17 17:24:0 2016
Firmware Version	1.00.05
Hardware Version	A
MAC Address	00:0D:0D:68:81:A4
IP Address	192.168.0.188
IP Subnet Mask	255.255.255.0
Default Gateway	192.168.0.1
Primary DNS	192.168.0.1
Secondary DNS	0.0.0.0
PPPoE	Disable
DDNS	Disable

On the right side, there is a 'Helpful Hints..' section with the text: 'This page displays all the information about the IP camera and network settings.'

Logs

This page displays the log information of your camera. You may download the information by clicking **Download**. You may also click **Clear** to delete the saved log information.

D-Link

DCS-4703E // LIVE VIDEO SETUP ADVANCED MAINTENANCE STATUS HELP

Device Info
Log
Logout

SYSTEM LOG
The system log records IP camera events that have occurred.

CURRENT LOG

- 2016/11/17 17:17:31 admin login Ok from 192.168.0.174
- 2016/11/17 12:08:14 admin from 192.168.0.174 Set schedule record 1 ; Name : Office Hours Recording, Turn OFF.
- 2016/11/17 12:07:49 admin from 192.168.0.174 Set event type 1 ; Trigger : Motion Detection.
- 2016/11/17 12:07:18 admin from 192.168.0.174 Set event media 1 ; Name : Take snapshots, Type : Snapshot.
- 2016/11/17 12:06:56 admin from 192.168.0.174 Set event server 1 ; Name : FTP, Type : FTP.
- 2016/11/17 12:04:53 admin from 192.168.0.174 set video exposure mode from Auto to Customize.
- 2016/11/17 12:03:08 admin login Ok from 192.168.0.174
- 2016/11/17 11:41:46 admin from 192.168.0.174 set audio speaker off.
- 2016/11/17 11:41:46 admin from 192.168.0.174 set audio microphone off.
- 2016/11/17 11:41:46 admin from 192.168.0.174 set video profile 2 frame size from 1280x720 to 640x360.
- 2016/11/17 11:41:46 admin from 192.168.0.174 set video profile 2 frame size from 1280x720 to 640x360.
- 2016/11/17 11:39:58 admin login Ok from 192.168.0.174
- 2016/11/17 11:37:05 system power on.
- 2016/11/16 11:38:16 admin login Ok from 172.17.5.63
- 2016/11/16 11:29:23 admin from 172.17.5.63 system language change from Simplified Chinese to English.
- 2016/11/16 11:29:19 admin from 172.17.5.63 system language change from United Kingdom to Simplified Chinese.
- 2016/11/16 11:29:09 system change admin password.
- 2016/11/16 11:27:20 admin login Ok from 172.17.5.63
- 2016/11/16 11:26:24 system power on.
- 2016/11/16 11:26:11 system reset to factory settings.

First Page Previous 20 Next 20
Clear Download

Helpful Hints..
You can save the log to your local hard IP camera by clicking the Download button, and you can clear the log by clicking on the Clear button.

SECURITY

Help

This page provides helpful information regarding camera operation.

The screenshot shows the D-Link web interface for the DCS-4703E camera. The top navigation bar includes the D-Link logo and tabs for LIVE VIDEO, SETUP, ADVANCED, MAINTENANCE, STATUS, and HELP. The HELP tab is selected. The main content area is organized into sections: HELP (with links to LIVE VIDEO, SETUP, MAINTENANCE, ADVANCED, and STATUS), LIVE VIDEO (with a link to Camera), SETUP (with links to Setup Wizard, Network Setup, Dynamic DNS, Image Setup, Video, Motion Detection, Time and Date, and Event Setup), ADVANCED (with links to ICR and IR, HTTPS, Access List, and SNMP), MAINTENANCE (with links to Admin, System, and Firmware Upgrade), and STATUS (with links to Device Info and Log). A SECURITY section is visible at the bottom of the page.

D-Link

DCS-4703E // LIVE VIDEO SETUP ADVANCED MAINTENANCE STATUS HELP

Help
Logout

HELP

- [LIVE VIDEO](#)
- [SETUP](#)
- [MAINTENANCE](#)
- [ADVANCED](#)
- [STATUS](#)

LIVE VIDEO

- [Camera](#)

SETUP

- [Setup Wizard](#)
- [Network Setup](#)
- [Dynamic DNS](#)
- [Image Setup](#)
- [Video](#)
- [Motion Detection](#)
- [Time and Date](#)
- [Event Setup](#)

ADVANCED

- [ICR and IR](#)
- [HTTPS](#)
- [Access List](#)
- [SNMP](#)

MAINTENANCE

- [Admin](#)
- [System](#)
- [Firmware Upgrade](#)

STATUS

- [Device Info](#)
- [Log](#)

SECURITY

Technical Specifications

Camera		
Camera Hardware Profile	<ul style="list-style-type: none"> • 1/3" 3 megapixel progressive CMOS sensor • 20 meter IR illumination distance • Minimum illumination: <ul style="list-style-type: none"> • Day Mode: 0.2 lux • Night Mode (LEDs off): 0.1 lux • Night Mode (LEDs on): 0 lux • Built-in Infrared-Cut Removable (ICR) Filter module • 10x digital zoom • Minimum object distance 0.5 m 	<ul style="list-style-type: none"> • Focal length: 3.6 mm • Aperture: F1.8 • Angle of view: <ul style="list-style-type: none"> • (H) 70° • (V) 40° • (D) 80°
Camera Housing	<ul style="list-style-type: none"> • IP-66 compliant weatherproof housing 	
Image Features	<ul style="list-style-type: none"> • Configurable image size, quality, frame rate, and bit rate • Time stamp and text overlays • Configurable motion detection windows • Configurable privacy mask zones 	<ul style="list-style-type: none"> • Configurable shutter speed, brightness, saturation, contrast, and sharpness • WDR • 3D filter
Video Compression	<ul style="list-style-type: none"> • Simultaneous H.264/MJPEG format compression • H.264/MJPEG multicast streaming 	<ul style="list-style-type: none"> • JPEG for still images
Video Resolution	<ul style="list-style-type: none"> • 16:9 <ul style="list-style-type: none"> • 1920 x 1080, 1280 x 720, 800 x 448, 640 x 360 up to 30 fps 	<ul style="list-style-type: none"> • 4:3 <ul style="list-style-type: none"> • 2048 x 1536, 1440 x 1080 up to 15 fps • 1280 x 960, 900 x 720, 800 x 592, 640 x 480 up to 30 fps
External Device Interface	<ul style="list-style-type: none"> • 10/100 BASE-TX Fast Ethernet port 	<ul style="list-style-type: none"> • Supports 802.3af PoE
Network		
Network Protocols	<ul style="list-style-type: none"> • IPv6 • IPv4 • TCP/IP • UDP • ICMP • DHCP client • NTP client (D-Link) • DNS client • DDNS client (D-Link) • SMTP client • FTP client 	<ul style="list-style-type: none"> • HTTP / HTTPS • Samba client • PPPoE • UPnP port forwarding • RTP / RTSP / RTCP • IP filtering • QoS • CoS • Multicast • SNMP • ONVIF compliant
Security	<ul style="list-style-type: none"> • Administrator and user group protection • Password authentication 	<ul style="list-style-type: none"> • HTTP and RTSP authentication

Appendix A: Technical Specifications

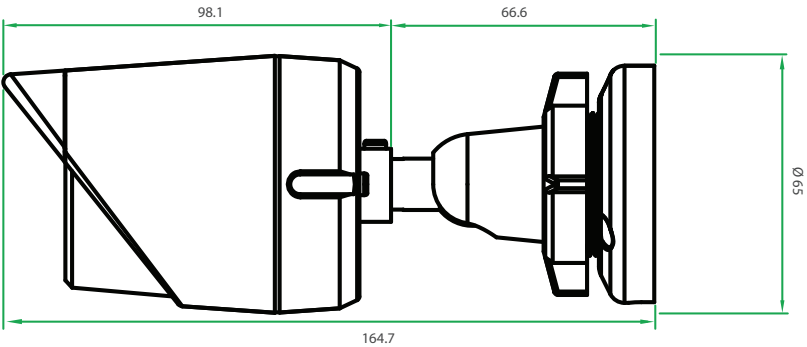
System Management	
System Requirements for Web Interface	<ul style="list-style-type: none"> • Browser: Internet Explorer, Firefox, Chrome, or Safari
Event Management	<ul style="list-style-type: none"> • Motion detection • Event notification and uploading of snapshots/video clips via e-mail or FTP • Supports multiple SMTP and FTP servers • Multiple event notifications • Multiple recording methods for easy backup
Remote Management	<ul style="list-style-type: none"> • Take snapshots/video clips and save to local hard drive • Configuration interface accessible via web browser
D-ViewCam™ System Requirements	<ul style="list-style-type: none"> • Operating System: Microsoft Windows 10/8/7/Vista • Web Browser: Internet Explorer 7 or higher • Protocol: Standard TCP/IP
D-ViewCam™ Software Functions	<ul style="list-style-type: none"> • Supports all management functions provided in web interface • Scheduled motion triggered, or manual recording options • Remote management/control of up to 32 cameras • Viewing of up to 32 cameras on one screen
General	
Weight	<ul style="list-style-type: none"> • 430 g ± 5 %
External Power Adapter	<ul style="list-style-type: none"> • Input: 100 to 240 V AC, 50/60 Hz • Output: 12 V DC 1.5 A
Power Consumption	<ul style="list-style-type: none"> • 6.4 watts ± 5 % (PoE)
Temperature	<ul style="list-style-type: none"> • Operating: -30 to 50 °C (-22 to 122 °F) • Storage: -20 to 70° C (-4° to 158° F)
Humidity	<ul style="list-style-type: none"> • Operating: 20 % to 80 % non-condensing • Storage: 5 % to 95 % non-condensing
Certifications	<ul style="list-style-type: none"> • CE • CE LVD • FCC • C-Tick
Dimensions	 <p>Technical drawing of the D-ViewCam camera showing dimensions:</p> <ul style="list-style-type: none"> 98.1 mm (width of main body) 66.6 mm (width of lens assembly) 164.7 mm (total length) Ø65 mm (diameter of lens assembly)

Regulatory Information

Federal Communication Commission Interference Statement

This equipment has been tested and found to comply with the limits for a Class A digital device, pursuant to part 15 of the FCC Rules. These limits are designed to provide reasonable protection against harmful interference when the equipment is operated in a commercial environment. This equipment generates, uses, and can radiate radio frequency energy and, if not installed and used in accordance with the instruction manual, may cause harmful interference to radio communications. Operation of this equipment in a residential area is likely to cause harmful interference in which case the user will be required to correct the interference at his own expense.

Non-modification Statement

Any changes or modifications not expressly approved by the party responsible for compliance could void the user's authority to operate the equipment.

Caution

This device complies with Part 15 of the FCC Rules. Operation is subject to the following two conditions:

(1) This device may not cause harmful interference, and (2) this device must accept any interference received, including interference that may cause undesired operation.

CE EMI Class A Warning

This equipment is compliant with Class A of CISPR 32. In a residential environment this equipment may cause radio interference.

SAFETY INSTRUCTIONS

The following general safety guidelines are provided to help ensure your own personal safety and protect your product from potential damage. Remember to consult the product user instructions for more details.

- Static electricity can be harmful to electronic components. Discharge static electricity from your body (i.e. touching grounded bare metal) before touching the product.
- Do not attempt to service the product and never disassemble the product. For some products with a user replaceable battery, please read and follow the instructions in the user manual.
- Do not spill food or liquid on your product and never push any objects into the openings of your product.
- Do not use this product near water, areas with high humidity, or condensation unless the product is specifically rated for outdoor application.
- Keep the product away from radiators and other heat sources.
- Always unplug the product from mains power before cleaning and use a dry lint free cloth only.

SICHERHEITSVORSCHRIFTEN

Die folgenden allgemeinen Sicherheitsvorschriften dienen als Hilfe zur Gewährleistung Ihrer eigenen Sicherheit und zum Schutz Ihres Produkts. Weitere Details finden Sie in den Benutzeranleitungen zum Produkt.

- Statische Elektrizität kann elektronischen Komponenten schaden. Um Schäden durch statische Aufladung zu vermeiden, leiten Sie elektrostatische Ladungen von Ihrem Körper ab, (z. B. durch Berühren eines geerdeten blanken Metallteils), bevor Sie das Produkt berühren.
- Unterlassen Sie jeden Versuch, das Produkt zu warten, und versuchen Sie nicht, es in seine Bestandteile zu zerlegen. Für einige Produkte mit austauschbaren Akkus lesen Sie bitte das Benutzerhandbuch und befolgen Sie die dort beschriebenen Anleitungen.
- Vermeiden Sie, dass Speisen oder Flüssigkeiten auf Ihr Produkt gelangen, und stecken Sie keine Gegenstände in die Gehäuseschlitze oder -öffnungen Ihres Produkts.
- Verwenden Sie dieses Produkt nicht in unmittelbarer Nähe von Wasser und nicht in Bereichen mit hoher Luftfeuchtigkeit oder Kondensation, es sei denn, es ist speziell zur Nutzung in Außenbereichen vorgesehen und eingestuft.
- Halten Sie das Produkt von Heizkörpern und anderen Quellen fern, die Wärme erzeugen.
- Trennen Sie das Produkt immer von der Stromzufuhr, bevor Sie es reinigen und verwenden Sie dazu ausschließlich ein trockenes fusselfreies Tuch.

CONSIGNES DE SÉCURITÉ

Les consignes générales de sécurité ci-après sont fournies afin d'assurer votre sécurité personnelle et de protéger le produit d'éventuels dommages. Veuillez consulter les consignes d'utilisation du produit pour plus de détails.

- L'électricité statique peut endommager les composants électroniques. Déchargez l'électricité statique de votre corps (en touchant un objet en métal relié à la terre par exemple) avant de toucher le produit.
- N'essayez pas d'intervenir sur le produit et ne le démontez jamais. Pour certains produits contenant une batterie remplaçable par l'utilisateur, veuillez lire et suivre les consignes contenues dans le manuel d'utilisation.
- Ne renversez pas d'aliments ou de liquide sur le produit et n'insérez jamais d'objets dans les orifices.
- N'utilisez pas ce produit à proximité d'un point d'eau, de zones très humides ou de condensation sauf si le produit a été spécifiquement conçu pour une application extérieure.
- Éloignez le produit des radiateurs et autres sources de chaleur.
- Débranchez toujours le produit de l'alimentation avant de le nettoyer et utilisez uniquement un chiffon sec non pelucheux.

INSTRUCCIONES DE SEGURIDAD

Las siguientes directrices de seguridad general se facilitan para ayudarle a garantizar su propia seguridad personal y para proteger el producto frente a posibles daños. No olvide consultar las instrucciones del usuario del producto para obtener más información.

- La electricidad estática puede resultar nociva para los componentes electrónicos. Descargue la electricidad estática de su cuerpo (p. ej., tocando algún metal sin revestimiento conectado a tierra) antes de tocar el producto.
- No intente realizar el mantenimiento del producto ni lo desmonte nunca. Para algunos productos con batería reemplazable por el usuario, lea y siga las instrucciones del manual de usuario.
- No derrame comida o líquidos sobre el producto y nunca deje que caigan objetos en las aberturas del mismo.
- No utilice este producto cerca del agua, en zonas con humedad o condensación elevadas a menos que el producto esté clasificado específicamente para aplicación en exteriores.
- Mantenga el producto alejado de los radiadores y de otras fuentes de calor.
- Desenchufe siempre el producto de la alimentación de red antes de limpiarlo y utilice solo un paño seco sin pelusa.

ISTRUZIONI PER LA SICUREZZA

Le seguenti linee guida sulla sicurezza sono fornite per contribuire a garantire la sicurezza personale degli utenti e a proteggere il prodotto da potenziali danni. Per maggiori dettagli, consultare le istruzioni per l'utente del prodotto.

- L'elettricità statica può essere pericolosa per i componenti elettronici. Scaricare l'elettricità statica dal corpo (ad esempio toccando una parte metallica collegata a terra) prima di toccare il prodotto.
- Non cercare di riparare il prodotto e non smontarlo mai. Per alcuni prodotti dotati di batteria sostituibile dall'utente, leggere e seguire le istruzioni riportate nel manuale dell'utente.
- Non versare cibi o liquidi sul prodotto e non spingere mai alcun oggetto nelle aperture del prodotto.
- Non usare questo prodotto vicino all'acqua, in aree con elevato grado di umidità o soggette a condensa a meno che il prodotto non sia specificatamente approvato per uso in ambienti esterni.
- Tenere il prodotto lontano da caloriferi e altre fonti di calore.
- Scollegare sempre il prodotto dalla presa elettrica prima di pulirlo e usare solo un panno asciutto che non lasci filacce.

VEILIGHEIDSINFORMATIE

De volgende algemene veiligheidsinformatie werd verstrekt om uw eigen persoonlijke veiligheid te waarborgen en uw product te beschermen tegen mogelijke schade. Denk eraan om de gebruikersinstructies van het product te raadplegen voor meer informatie.

- Statische elektriciteit kan schadelijk zijn voor elektronische componenten. Ontlaad de statische elektriciteit van uw lichaam (d.w.z. het aanraken van geaard bloot metaal) voordat u het product aanraakt.
- U mag nooit proberen het product te onderhouden en u mag het product nooit demonteren. Voor sommige producten met door de gebruiker te vervangen batterij, dient u de instructies in de gebruikershandleiding te lezen en te volgen.
- Mors geen voedsel of vloeistof op uw product en u mag nooit voorwerpen in de openingen van uw product duwen.
- Gebruik dit product niet in de buurt van water, gebieden met hoge vochtigheid of condensatie, tenzij het product specifiek geclassificeerd is voor gebruik buitenshuis.
- Houd het product uit de buurt van radiators en andere warmtebronnen.
- U dient het product steeds los te koppelen van de stroom voordat u het reinigt en gebruik uitsluitend een droge pluisvrije doek.

Disposing and Recycling Your Product

ENGLISH

EN



This symbol on the product or packaging means that according to local laws and regulations this product should be not be disposed of in household waste but sent for recycling. Please take it to a collection point designated by your local authorities once it has reached the end of its life, some will accept products for free. By recycling the product and its packaging in this manner you help to conserve the environment and protect human health.

D-Link and the Environment

At D-Link, we understand and are committed to reducing any impact our operations and products may have on the environment. To minimise this impact D-Link designs and builds its products to be as environmentally friendly as possible, by using recyclable, low toxic materials in both products and packaging.

D-Link recommends that you always switch off or unplug your D-Link products when they are not in use. By doing so you will help to save energy and reduce CO2 emissions.

To learn more about our environmentally responsible products and packaging please visit www.dlinkgreen.com.

DEUTSCH

DE



Dieses Symbol auf dem Produkt oder der Verpackung weist darauf hin, dass dieses Produkt gemäß bestehender örtlicher Gesetze und Vorschriften nicht über den normalen Hausmüll entsorgt werden sollte, sondern einer Wiederverwertung zuzuführen ist. Bringen Sie es bitte zu einer von Ihrer Kommunalbehörde entsprechend amtlich ausgewiesenen Sammelstelle, sobald das Produkt das Ende seiner Nutzungsdauer erreicht hat. Für die Annahme solcher Produkte erheben einige dieser Stellen keine Gebühren. Durch ein auf diese Weise durchgeführtes Recycling des Produkts und seiner Verpackung helfen Sie, die Umwelt zu schonen und die menschliche Gesundheit zu schützen.

D-Link und die Umwelt

D-Link ist sich den möglichen Auswirkungen seiner Geschäftstätigkeiten und seiner Produkte auf die Umwelt bewusst und fühlt sich verpflichtet, diese entsprechend zu mindern. Zu diesem Zweck entwickelt und stellt D-Link seine Produkte mit dem Ziel größtmöglicher Umweltfreundlichkeit her und verwendet wiederverwertbare, schadstoffarme Materialien bei Produktherstellung und Verpackung.

D-Link empfiehlt, Ihre Produkte von D-Link, wenn nicht in Gebrauch, immer auszuschalten oder vom Netz zu nehmen. Auf diese Weise helfen Sie, Energie zu sparen und CO2-Emissionen zu reduzieren.

Wenn Sie mehr über unsere umweltgerechten Produkte und Verpackungen wissen möchten, finden Sie entsprechende Informationen im Internet unter www.dlinkgreen.com.

FRANÇAIS

FR



Ce symbole apposé sur le produit ou son emballage signifie que, conformément aux lois et réglementations locales, ce produit ne doit pas être éliminé avec les déchets domestiques mais recyclé. Veuillez le rapporter à un point de collecte prévu à cet effet par les autorités locales; certains accepteront vos produits gratuitement. En recyclant le produit et son emballage de cette manière, vous aidez à préserver l'environnement et à protéger la santé de l'homme.

D-Link et l'environnement

Chez D-Link, nous sommes conscients de l'impact de nos opérations et produits sur l'environnement et nous engageons à le réduire. Pour limiter cet impact, D-Link conçoit et fabrique ses produits de manière aussi écologique que possible, en utilisant des matériaux recyclables et faiblement toxiques, tant dans ses produits que ses emballages.

D-Link recommande de toujours éteindre ou débrancher vos produits D-Link lorsque vous ne les utilisez pas. Vous réaliserez ainsi des économies d'énergie et réduirez vos émissions de CO2.

Pour en savoir plus sur les produits et emballages respectueux de l'environnement, veuillez consulter le www.dlinkgreen.com.

ESPAÑOL

ES



Este símbolo en el producto o el embalaje significa que, de acuerdo con la legislación y la normativa local, este producto no se debe desechar en la basura doméstica sino que se debe reciclar. Llévelo a un punto de recogida designado por las autoridades locales una vez que ha llegado al fin de su vida útil; algunos de ellos aceptan recogerlos de forma gratuita. Al reciclar el producto y su embalaje de esta forma, contribuye a preservar el medio ambiente y a proteger la salud de los seres humanos.

D-Link y el medio ambiente

En D-Link, comprendemos y estamos comprometidos con la reducción del impacto que puedan tener nuestras actividades y nuestros productos en el medio ambiente. Para reducir este impacto, D-Link diseña y fabrica sus productos para que sean lo más ecológicos posible, utilizando materiales reciclables y de baja toxicidad tanto en los productos como en el embalaje.

D-Link recomienda apagar o desenchufar los productos D-Link cuando no se estén utilizando. Al hacerlo, contribuirá a ahorrar energía y a reducir las emisiones de CO2.

Para obtener más información acerca de nuestros productos y embalajes ecológicos, visite el sitio www.dlinkgreen.com.

ITALIANO

IT



La presenza di questo simbolo sul prodotto o sulla confezione del prodotto indica che, in conformità alle leggi e alle normative locali, questo prodotto non deve essere smaltito nei rifiuti domestici, ma avviato al riciclo. Una volta terminato il ciclo di vita utile, portare il prodotto presso un punto di raccolta indicato dalle autorità locali. Alcuni questi punti di raccolta accettano gratuitamente i prodotti da riciclare. Scegliendo di riciclare il prodotto e il relativo imballaggio, si contribuirà a preservare l'ambiente e a salvaguardare la salute umana.

D-Link e l'ambiente

D-Link cerca da sempre di ridurre l'impatto ambientale dei propri stabilimenti e dei propri prodotti. Allo scopo di ridurre al minimo tale impatto, D-Link progetta e realizza i propri prodotti in modo che rispettino il più possibile l'ambiente, utilizzando materiali riciclabili a basso tasso di tossicità sia per i prodotti che per gli imballaggi.

D-Link raccomanda di spegnere sempre i prodotti D-Link o di scollegarne la spina quando non vengono utilizzati. In questo modo si contribuirà a risparmiare energia e a ridurre le emissioni di anidride carbonica.

Per ulteriori informazioni sui prodotti e sugli imballaggi D-Link a ridotto impatto ambientale, visitate il sito all'indirizzo www.dlinkgreen.com.

NEDERLANDS

NL



Dit symbool op het product of de verpakking betekent dat dit product volgens de plaatselijke wetgeving niet mag worden weggegooid met het huishoudelijk afval, maar voor recyclage moeten worden ingeleverd. Zodra het product het einde van de levensduur heeft bereikt, dient u het naar een inzamelpunt te brengen dat hiertoe werd aangeduid door uw plaatselijke autoriteiten, sommige autoriteiten accepteren producten zonder dat u hiervoor dient te betalen. Door het product en de verpakking op deze manier te recyclen helpt u het milieu en de gezondheid van de mens te beschermen.

D-Link en het milieu

Bij D-Link spannen we ons in om de impact van onze handelingen en producten op het milieu te beperken. Om deze impact te beperken, ontwerpt en bouwt D-Link zijn producten zo milieuvriendelijk mogelijk, door het gebruik van recycleerbare producten met lage toxiciteit in product en verpakking.

D-Link raadt aan om steeds uw D-Link producten uit te schakelen of uit de stekker te halen wanneer u ze niet gebruikt. Door dit te doen bespaart u energie en beperkt u de CO₂-emissies.

Breng een bezoek aan www.dlinkgreen.com voor meer informatie over onze milieuverantwoorde producten en verpakkingen.

POLSKI

PL



Ten symbol umieszczony na produkcie lub opakowaniu oznacza, że zgodnie z miejscowym prawem i lokalnymi przepisami niniejszego produktu nie wolno wyrzucać jak odpady czy śmieci z gospodarstwa domowego, lecz należy go poddać procesowi recyklingu. Po zakończeniu użytkowania produktu, niektóre odpowiednie do tego celu podmioty przyjmą takie produkty nieodpłatnie, dlatego prosimy dostarczyć go do punktu zbiórki wskazanego przez lokalne władze. Poprzez proces recyklingu i dzięki takiemu postępowaniu z produktem oraz jego opakowaniem, pomogą Państwo chronić środowisko naturalne i dbać o ludzkie zdrowie.

D-Link i środowisko

D-Link podchodzimy w sposób świadomy do ochrony otoczenia oraz jesteśmy zaangażowani w zmniejszanie wpływu naszych działań i produktów na środowisko naturalne. W celu zminimalizowania takiego wpływu firma D-Link konstruuje i wytwarza swoje produkty w taki sposób, aby były one jak najbardziej przyjazne środowisku, stosując do tych celów materiały nadające się do powtórnego wykorzystania, charakteryzujące się małą toksycznością zarówno w przypadku samych produktów jak i opakowań.

Firma D-Link zaleca, aby Państwo zawsze prawidłowo wyłączali z użytku swoje produkty D-Link, gdy nie są one wykorzystywane. Postępując w ten sposób pozwalają Państwo oszczędzać energię i zmniejszać emisje CO₂.

Aby dowiedzieć się więcej na temat produktów i opakowań mających wpływ na środowisko prosimy zapoznać się ze stroną Internetową www.dlinkgreen.com.

ČESKY

CZ



Tento symbol na výrobku nebo jeho obalu znamená, že podle místně platných předpisů se výrobek nesmí vyhazovat do komunálního odpadu, ale odeslat k recyklaci. Až výrobek doslouží, odnese jej prosím na sběrné místo určené místními úřady k tomuto účelu. Někteřá sběrná místa přijímají výrobky zdarma. Recyklací výrobku i obalu pomáháte chránit životní prostředí i lidské zdraví.

D-Link a životní prostředí

Ve společnosti D-Link jsme si vědomi vlivu našich provozů a výrobků na životní prostředí a snažíme se o minimalizaci těchto vlivů. Proto své výrobky navrhujeme a vyrábíme tak, aby byly co nejekologičtější, a ve výrobcích i obalech používáme recyklovatelné a nízkotoxické materiály.

Společnost D-Link doporučuje, abyste své výrobky značky D-Link vypnuli nebo vytáhli ze zásuvky vždy, když je nepoužíváte. Pomůžete tak šetřit energii a snížit emise CO₂.

Více informací o našich ekologických výrobcích a obalech najdete na adrese www.dlinkgreen.com.

MAGYAR**HU**

Ez a szimbólum a terméken vagy a csomagoláson azt jelenti, hogy a helyi törvényeknek és szabályoknak megfelelően ez a termék nem semmisíthető meg a háztartási hulladékkal együtt, hanem újrahasznosításra kell küldeni. Kérjük, hogy a termék élettartamának elteltét követően vigye azt a helyi hatóság által kijelölt gyűjtőhelyre. A termékek egyes helyeken ingyen elhelyezhetők. A termék és a csomagolás újrahasznosításával segíti védeni a környezetet és az emberek egészségét.

A D-Link és a környezet

A D-Linknél megértjük és elköteleztük magunkat a műveleteink és termékeink környezetre gyakorolt hatásainak csökkentésére. Az ezen hatás csökkentése érdekében a D-Link a lehető leginkább környezetbarát termékeket tervez és gyárt azáltal, hogy újrahasznosítható, alacsony károsanyag-tartalmú termékeket gyárt és csomagolásokat alkalmaz.

A D-Link azt javasolja, hogy mindig kapcsolja ki vagy húzza ki a D-Link termékeket a tápforrásból, ha nem használja azokat. Ezzel segít az energia megtakarításában és a széndioxid kibocsátásának csökkentésében.

Környezetbarát termékeinkről és csomagolásainkról további információkat a www.dlinkgreen.com weboldalon tudhat meg.

NORSK**NO**

Dette symbolet på produktet eller forpakningen betyr at dette produktet ifølge lokale lover og forskrifter ikke skal kastes sammen med husholdningsavfall, men leveres inn til gjenvinning. Vennligst ta det til et innsamlingssted anvist av lokale myndigheter når det er kommet til slutten av levetiden. Noen steder aksepteres produkter uten avgift. Ved på denne måten å gjenvinne produktet og forpakningen hjelper du å verne miljøet og beskytte folks helse.

D-Link og miljøet

Hos D-Link forstår vi oss på og er forpliktet til å minske innvirkningen som vår drift og våre produkter kan ha på miljøet. For å minimalisere denne innvirkningen designer og lager D-Link produkter som er så miljøvennlig som mulig, ved å bruke resirkulerbare, lav-toksiske materialer både i produktene og forpakningen.

D-Link anbefaler at du alltid slår av eller frakobler D-Link-produkter når de ikke er i bruk. Ved å gjøre dette hjelper du å spare energi og å redusere CO₂-utslipp.

For mer informasjon angående våre miljøansvarlige produkter og forpakninger kan du gå til www.dlinkgreen.com.

DANSK

DK



Dette symbol på produktet eller emballagen betyder, at dette produkt i henhold til lokale love og regler ikke må bortskaffes som husholdningsaffald, mens skal sendes til genbrug. Indlever produktet til et indsamlingssted som angivet af de lokale myndigheder, når det er nået til slutningen af dets levetid. I nogle tilfælde vil produktet blive modtaget gratis. Ved at indlevere produktet og dets emballage til genbrug på denne måde bidrager du til at beskytte miljøet og den menneskelige sundhed.

D-Link og miljøet

Hos D-Link forstår vi og bestræber os på at reducere enhver indvirkning, som vores aktiviteter og produkter kan have på miljøet. For at minimere denne indvirkning designer og producerer D-Link sine produkter, så de er så miljøvenlige som muligt, ved at bruge genanvendelige materialer med lavt giftighedsniveau i både produkter og emballage.

D-Link anbefaler, at du altid slukker eller frakobler dine D-Link-produkter, når de ikke er i brug. Ved at gøre det bidrager du til at spare energi og reducere CO₂-udledningerne.

Du kan finde flere oplysninger om vores miljømæssigt ansvarlige produkter og emballage på www.dlinkgreen.com.

SUOMI

FI



Tämä symboli tuotteen pakkauksessa tarkoittaa, että paikallisten lakien ja säännösten mukaisesti tätä tuotetta ei pidä hävittää yleisen kotitalousjätteen seassa vaan se tulee toimittaa kierrätettäväksi. Kun tuote on elinkaarensa päässä, toimita se lähimpään viranomaisten hyväksymään kierrätyspisteeseen. Kierrättämällä käytetyn tuotteen ja sen pakkauksen autat tukemaan sekä ympäristön että ihmisten terveyttä ja hyvinvointia.

D-Link ja ympäristö

D-Link ymmärtää ympäristönsuojelun tärkeyden ja on sitoutunut vähentämään tuotteistaan ja niiden valmistuksesta ympäristölle mahdollisesti aiheutuvia haittavaikutuksia. Nämä negatiiviset vaikutukset minimoidakseen D-Link suunnittelee ja valmistaa tuotteensa mahdollisimman ympäristöystävällisiksi käyttämällä kierrätettäviä, alhaisia pitoisuuksia haitallisia aineita sisältäviä materiaaleja sekä tuotteissaan että niiden pakkauksissa.

Suosittellemme, että irrotat D-Link-tuotteesi virtalähteestä tai sammutat ne aina, kun ne eivät ole käytössä. Toimimalla näin autat säästämään energiaa ja vähentämään hiilidioksiidipäästöjä.

Lue lisää ympäristöystävällisistä D-Link-tuotteista ja pakkauksistamme osoitteesta www.dlinkgreen.com.

SVENSKA

SE



Den här symbolen på produkten eller förpackningen betyder att produkten enligt lokala lagar och föreskrifter inte skall kastas i hushållssoporna utan i stället återvinnas. Ta den vid slutet av dess livslängd till en av din lokala myndighet utsedd uppsamlingsplats, vissa accepterar produkter utan kostnad. Genom att på detta sätt återvinna produkten och förpackningen hjälper du till att bevara miljön och skydda människors hälsa.

D-Link och miljön

På D-Link förstår vi och är fast beslutna att minska den påverkan våra verksamheter och produkter kan ha på miljön. För att minska denna påverkan utformar och bygger D-Link sina produkter för att de ska vara så miljövänliga som möjligt, genom att använda återvinningsbara material med låg gifthalt i både produkter och förpackningar.

D-Link rekommenderar att du alltid stänger av eller kopplar ur dina D-Link produkter när du inte använder dem. Genom att göra detta hjälper du till att spara energi och minska utsläpp av koldioxid.

För mer information om våra miljöansvariga produkter och förpackningar www.dlinkgreen.com.

PORTUGUÊS

PT



Este símbolo no produto ou embalagem significa que, de acordo com as leis e regulamentações locais, este produto não deverá ser eliminado juntamente com o lixo doméstico mas enviado para a reciclagem. Transporte-o para um ponto de recolha designado pelas suas autoridades locais quando este tiver atingido o fim da sua vida útil, alguns destes pontos aceitam produtos gratuitamente. Ao reciclar o produto e respectiva embalagem desta forma, ajuda a preservar o ambiente e protege a saúde humana.

A D-Link e o ambiente

Na D-Link compreendemos e comprometemo-nos com a redução do impacto que as nossas operações e produtos possam ter no ambiente. Para minimizar este impacto a D-Link concebe e constrói os seus produtos para que estes sejam o mais inofensivos para o ambiente possível, utilizando materiais recicláveis e não tóxicos tanto nos produtos como nas embalagens.

A D-Link recomenda que desligue os seus produtos D-Link quando estes não se encontrarem em utilização. Com esta acção ajudará a poupar energia e reduzir as emissões de CO₂.

Para saber mais sobre os nossos produtos e embalagens responsáveis a nível ambiental visite www.dlinkgreen.com.