

**D-Link™ DES-3326S**  
**24-Port Layer 3 Stackable Switch**

***Manual***

---

---

May 2005

651ES3326S055

**Information in this document is subject to change without notice.**

**© 2005 D-Link Corporation. All rights reserved.**

Reproduction in any manner whatsoever without the written permission of D-Link Corporation is strictly forbidden.

Trademarks used in this text: *D-Link*, the *D-LINK* logo are trademarks of D-Link Computer Corporation; *Microsoft* and *Windows* are registered trademarks of Microsoft Corporation.

Other trademarks and trade names may be used in this document to refer to either the entities claiming the marks and names or their products. D-Link Computer Corporation disclaims any proprietary interest in trademarks and trade names other than its own.

May 2005 P/N 651ES3326S055

<b>About This Manual .....</b>	<b>vii</b>
<b>Intended Readers .....</b>	<b>vii</b>
<b>Notes, Notices, and Cautions .....</b>	<b>vii</b>
<b>Safety Instructions.....</b>	<b>viii</b>
<b>Introduction .....</b>	<b>1</b>
<i>Switch Description .....</i>	<i>1</i>
<b>Features .....</b>	<b>2</b>
<b>Front Panel Components .....</b>	<b>3</b>
<i>LED Indicators .....</i>	<i>3</i>
<i>Stacking LED Indicators.....</i>	<i>4</i>
<b>Rear Panel Description .....</b>	<b>5</b>
<i>Side Panels.....</i>	<i>5</i>
<b>Optional Plug-in Modules .....</b>	<b>6</b>
<b>Management Options .....</b>	<b>15</b>
<b>Installation .....</b>	<b>16</b>
<i>Package Contents.....</i>	<i>16</i>
<b>Before You Connect to the Network .....</b>	<b>17</b>
<i>Connecting the Console Port .....</i>	<i>17</i>
<b>Password Protection.....</b>	<b>18</b>
<b>IP Address Assignment .....</b>	<b>19</b>
<i>SNMP Settings .....</i>	<i>21</i>
<i>Installing the Switch without the Rack.....</i>	<i>22</i>
<i>Installing the Switch in a Rack .....</i>	<i>23</i>
<b>Connecting Stacked Switch Groups.....</b>	<b>24</b>
<i>Notes on Stacking Switches .....</i>	<i>25</i>
<i>Configuring a Switch Group for Stacking .....</i>	<i>26</i>
<i>Notes on Standalone Operation.....</i>	<i>28</i>
<b>Connecting Devices to the Switch .....</b>	<b>29</b>
<b>Switch Management.....</b>	<b>30</b>
<i>Before You Start .....</i>	<i>30</i>
<i>General Deployment Strategy.....</i>	<i>31</i>
<i>Web-based User Interface .....</i>	<i>32</i>
<b>Basic Setup.....</b>	<b>34</b>
<i>Switch Information .....</i>	<i>34</i>
<b>Switch IP Settings .....</b>	<b>35</b>
<b>User Accounts Management .....</b>	<b>37</b>
<i>Admin and User Privileges.....</i>	<i>39</i>
<b>Saving Changes .....</b>	<b>40</b>
<b>Factory Reset.....</b>	<b>40</b>

Restart System .....	41
<b>Stacking Mode.....</b>	<b>42</b>
<b>Port Configuration .....</b>	<b>45</b>
Configure Ports.....	46
Traffic Segmentation.....	50
<b>Link Aggregation .....</b>	<b>51</b>
Configure Link Aggregation .....	52
<b>Port Mirroring .....</b>	<b>55</b>
<b>MAC Forwarding .....</b>	<b>56</b>
MAC Address Aging Time.....	56
Unicast MAC Address Forwarding .....	56
Multicast MAC Address Forwarding.....	58
Broadcast/Multicast Storm Control.....	59
<b>Spanning Tree Protocol.....</b>	<b>61</b>
802.1w Rapid Spanning Tree .....	61
<b>Configure STP Switch Settings.....</b>	<b>62</b>
STP Port Settings .....	64
<b>Quality of Service Configuration .....</b>	<b>66</b>
Configure QoS Output Scheduling.....	67
Configure 802.1p User Priority.....	68
Configure Default Priority.....	69
Configure Bandwidth Control.....	70
<b>MAC Notification .....</b>	<b>71</b>
<b>System Log.....</b>	<b>73</b>
<b>SNTP Settings .....</b>	<b>75</b>
<b>Security Management.....</b>	<b>78</b>
<b>Access Profile Configuration .....</b>	<b>78</b>
<b>CPU Interface Filtering.....</b>	<b>85</b>
<b>802.1X Port-based Network Access Control .....</b>	<b>91</b>
<b>802.1X Configuration.....</b>	<b>93</b>
Port Capability .....	96
<b>SNMP Network Management.....</b>	<b>100</b>
<b>SNMP Version.....</b>	<b>100</b>
SNMP View Table.....	101
SNMP Group Table.....	102
SNMP Community Table .....	103
SNMP Engine ID.....	104

SNMP Host Table .....	105
SNMP User Table .....	106
Security IP Management.....	107
<b>Network Monitoring and Statistics .....</b>	<b>108</b>
Port Utilization Statistics .....	109
Port Packet Statistics .....	110
MAC Address Table.....	113
Routing Table .....	114
ARP Table .....	115
OSPF Information .....	116
DVMRP Information .....	118
PIM Neighbor Address Table.....	120
GVRP Status .....	120
Router Ports.....	121
IGMP Snooping Group Table.....	122
IGMP Snooping Forwarding Table.....	122
IGMP Group Table.....	123
IP Multicast Forwarding Table .....	124
802.1X Authentication Status.....	124
Switch History .....	125
<b>Switch Utilities .....</b>	<b>126</b>
<b>TFTP Services.....</b>	<b>126</b>
Ping Test.....	128
<b>DHCP, BOOTP and DNS Relay .....</b>	<b>129</b>
<b>VLANs and IP Interfaces.....</b>	<b>133</b>
<b>Understanding 802.1Q VLANs.....</b>	<b>133</b>
<b>Configure VLANs .....</b>	<b>137</b>
Configure 802.1Q Static VLANs .....	137
802.1Q Port Settings.....	140
Switch GVRP .....	141
<b>IP Interface Configuration .....</b>	<b>142</b>
<b>Multicast Routing Configuration.....</b>	<b>145</b>
Multicast Global Configurations .....	145
IGMP Snooping Settings.....	146
IGMP Interface Configuration .....	148
DVMRP Interface Configuration.....	150
PIM-DM Settings.....	151

<b>Static Route, Static ARP and RIP Configuration .....</b>	<b>153</b>
<i>Configure Static Routes .....</i>	<i>153</i>
<i>Configure Static ARP .....</i>	<i>154</i>
<i>Routing Information Protocol (RIP) Configuration .....</i>	<i>155</i>
<b>Introduction to OSPF .....</b>	<b>157</b>
<b>Configure OSPF .....</b>	<b>175</b>
<b>MD5 Key Table Configuration .....</b>	<b>176</b>
<b>Configure OSPF Settings.....</b>	<b>177</b>
<i>OSPF Area Setting .....</i>	<i>177</i>
<i>OSPF Interface Configuration .....</i>	<i>179</i>
<i>OSPF Virtual Interface Settings .....</i>	<i>180</i>
<i>Area Aggregation Configuration.....</i>	<i>182</i>
<i>OSPF Host Route Settings .....</i>	<i>183</i>
<i>Route Redistribution Settings .....</i>	<i>184</i>
<b>Technical Specifications .....</b>	<b>186</b>
<b>Network Addressing and Protocols .....</b>	<b>188</b>
<b>IP Addresses.....</b>	<b>188</b>
<b>Internet Protocols.....</b>	<b>193</b>
<i>Packet Headers .....</i>	<i>195</i>
<i>The Domain Name System.....</i>	<i>199</i>
<i>DHCP Servers .....</i>	<i>200</i>
<b>IP Routing, Multicasting, Multicast Routing and Routing Protocols .....</b>	<b>201</b>
<b>ARP .....</b>	<b>202</b>
<b>Multicasting .....</b>	<b>203</b>
<i>Internet Group Management Protocol (IGMP) .....</i>	<i>204</i>
<i>Multicast Routing Protocols .....</i>	<i>206</i>
<i>Routing Protocols.....</i>	<i>207</i>
<b>Glossary.....</b>	<b>210</b>
<b>LIMITED WARRANTY .....</b>	<b>212</b>
<i>FCC Warning .....</i>	<i>214</i>
<b>Product Registration.....</b>	<b>218</b>
<b>D-Link Europe Limited Product Warranty.....</b>	<b>219</b>
<i>International Offices .....</i>	<i>230</i>

## About This Manual

This manual is organized to provide basic setup information in the beginning chapters, followed by presentation of more complex material concerning Layer 2 and Layer 3 switching functions. Some chapters include information pertinent to management of specific functions and protocols. This material is intended as a general introduction to key concepts and is not intended as a thorough or exhaustive study of network management.

## Intended Readers

The DES-3326S Manual contains information useful for setup and management of the DES-3326S Switch. This manual is intended for network managers familiar with network management concepts and terminology.

## Notes, Notices, and Cautions

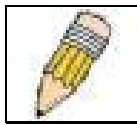

**NOTE:** A NOTE indicates important information that helps you make better use of your device.



**NOTICE:** A NOTICE indicates either potential damage to hardware or loss of data and tells you how to avoid the problem.



**CAUTION:** A CAUTION indicates a potential for property damage, personal injury, or death.

## Safety Instructions

Use the following safety guidelines to ensure your own personal safety and to help protect your system from potential damage. Throughout this safety section, the caution icon (  ) is used to indicate cautions and precautions that you need to review and follow.



### Safety Cautions

To reduce the risk of bodily injury, electrical shock, fire, and damage to the equipment, observe the following precautions.

Observe and follow service markings. Do not service any product except as explained in your system documentation. Opening or removing covers that are marked with the triangular symbol with a lightning bolt may expose you to electrical shock. Components inside these compartments should be serviced only by a trained service technician.

If any of the following conditions occur, unplug the product from the electrical outlet and replace the part or contact your trained service provider:

- The power cable, extension cable, or plug is damaged.
- An object has fallen into the product.
- The product has been exposed to water.
- The product has been dropped or damaged.
- The product does not operate correctly when you follow the operating instructions.
- Keep your system away from radiators and heat sources. Also, do not block cooling vents.
- Do not spill food or liquids on your system components, and never operate the product in a wet environment. If the system gets wet, see the appropriate section in your troubleshooting guide or contact your trained service provider.
- Do not push any objects into the openings of your system. Doing so can cause fire or electric shock by shorting out interior components.
- Use the product only with approved equipment.
- Allow the product to cool before removing covers or touching internal components.
- Operate the product only from the type of external power source indicated on the electrical ratings label. If you are not sure of the type of power source required, consult your service provider or local power company.
- To help avoid damaging your system, be sure the voltage selection Switch (if provided) on the power supply is set to match the power available at your location:
  - 115 volts (V)/60 hertz (Hz) in most of North and South America and some Far Eastern countries such as South Korea and Taiwan
  - 100 V/50 Hz in eastern Japan and 100 V/60 Hz in western Japan
  - 230 V/50 Hz in most of Europe, the Middle East, and the Far East
- Also be sure that attached devices are electrically rated to operate with the power available in your location.
- Use only approved power cable(s). If you have not been provided with a power cable for your system or for any AC-powered option intended for your system, purchase a power cable that is approved for use in your country. The power cable must be rated for the product and for the voltage and current marked on the product's electrical ratings label. The voltage and current rating of the cable should be greater than the ratings marked on the product.
- To help prevent electric shock, plug the system and peripheral power cables into properly grounded electrical outlets. These cables are equipped with three-prong plugs to help ensure proper grounding. Do not use adapter plugs or remove the grounding prong from a cable. If you must use an extension cable, use a 3-wire cable with properly grounded plugs.
- Observe extension cable and power strip ratings. Make sure that the total ampere rating of all products plugged into the extension cable or power strip does not exceed 80 percent of the ampere ratings limit for the extension cable or power strip.
- To help protect your system from sudden, transient increases and decreases in electrical power, use a surge suppressor, line conditioner, or uninterruptible power supply (UPS).



- Position system cables and power cables carefully; route cables so that they cannot be stepped on or tripped over. Be sure that nothing rests on any cables.
- Do not modify power cables or plugs. Consult a licensed electrician or your power company for site modifications. Always follow your local/national wiring rules.
- When connecting or disconnecting power to hot-pluggable power supplies, if offered with your system, observe the following guidelines:
  - Install the power supply before connecting the power cable to the power supply.
  - Unplug the power cable before removing the power supply.
  - If the system has multiple sources of power, disconnect power from the system by unplugging *all* power cables from the power supplies.
- Move products with care; ensure that all casters and/or stabilizers are firmly connected to the system. Avoid sudden stops and uneven surfaces.



### General Precautions for Rack-Mountable Products

Observe the following precautions for rack stability and safety. Also refer to the rack installation documentation accompanying the system and the rack for specific caution statements and procedures.

Systems are considered to be components in a rack. Thus, "component" refers to any system as well as to various peripherals or supporting hardware.



**CAUTION:** Installing systems in a rack without the front and side stabilizers installed could cause the rack to tip over, potentially resulting in bodily injury under certain circumstances. Therefore, always install the stabilizers before installing components in the rack.

After installing system/components in a rack, never pull more than one component out of the rack on its slide assemblies at one time. The weight of more than one extended component could cause the rack to tip over and may result in serious injury.

- Before working on the rack, make sure that the stabilizers are secured to the rack, extended to the floor, and that the full weight of the rack rests on the floor. Install front and side stabilizers on a single rack or front stabilizers for joined multiple racks before working on the rack.

Always load the rack from the bottom up, and load the heaviest item in the rack first.

Make sure that the rack is level and stable before extending a component from the rack.

Use caution when pressing the component rail release latches and sliding a component into or out of a rack; the slide rails can pinch your fingers.

After a component is inserted into the rack, carefully extend the rail into a locking position, and then slide the component into the rack.

Do not overload the AC supply branch circuit that provides power to the rack. The total rack load should not exceed 80 percent of the branch circuit rating.

Ensure that proper airflow is provided to components in the rack.

Do not step on or stand on any component when servicing other components in a rack.



**NOTE:** A qualified electrician must perform all connections to DC power and to safety grounds. All electrical wiring must comply with applicable local or national codes and practices.



**CAUTION:** Never defeat the ground conductor or operate the equipment in the absence of a suitably installed ground conductor. Contact the appropriate electrical inspection authority or an electrician if you are uncertain that suitable grounding is available.



**CAUTION:** The system chassis must be positively grounded to the rack cabinet frame. Do not attempt to connect power to the system until grounding cables are connected. Completed power and safety ground wiring must be inspected by a qualified electrical inspector. An energy hazard will exist if the safety ground cable is omitted or disconnected.

### Protecting Against Electrostatic Discharge

Static electricity can harm delicate components inside your system. To prevent static damage, discharge static electricity from your body before you touch any of the electronic components, such as the microprocessor. You can do so by periodically touching an unpainted metal surface on the chassis.

You can also take the following steps to prevent damage from electrostatic discharge (ESD):

1. When unpacking a static-sensitive component from its shipping carton, do not remove the component from the antistatic packing material until you are ready to install the component in your system. Just before unwrapping the antistatic packaging, be sure to discharge static electricity from your body.
2. When transporting a sensitive component, first place it in an antistatic container or packaging.
3. Handle all sensitive components in a static-safe area. If possible, use antistatic floor pads and workbench pads and an antistatic grounding strap.

# Chapter 1

## Introduction

*Switch Description*

*Features*

*Front Panel Components*

*LED Indicators*

*Rear Panel Description*

*Plug-in Modules*

*Switch Stacking*

*Management Options*

## Switch Description

Layer 3 switching is the integration of two proven technologies: switching and routing. Layer 3 switches are running the same routing routines and protocols as traditional routers. The main difference between traditional routing and Layer 3 switching is the addition of a group of Layer 2 switching domains and the execution of routing routines for most packets via an ASIC – in hardware instead of software.

The DES-3326S can also replace key traditional routers for data centers and server farms, routing between these locations and the rest of the network, and providing 24 ports of Layer 2 switching performance combined with wire-speed routing.

## **Features**

- 8.8 Gbps Switching fabric capacity
- Supports 802.1w Rapid Spanning Tree and 802.1D STP compatible operation for redundant back up bridge paths
- Supports 802.1Q VLAN
- Supports IGMP snooping
- Supports 802.1p Priority Queues
- Supports 802.3ad LACP Link Aggregation
- Supports port mirroring
- Access Control Profile (ACL)
- Multi-layer Access Control (based on MAC address, IP address, VLAN, Protocol, 802.1p, DSCP/ TCP/UDP port)
- Quality of Service (QoS) customized control
- Port Security (MAC address table lock)
- 802.1x (port-based and MAC-based) access control and Radius Client support
- Administrator-definable port security
- Per-port bandwidth control
- Broadcast, Multicast and DLF storm control
- IEEE 802.3z and IEEE 802.3x compliant Flow Control for all Gigabit ports
- SNMP v.1, v.2, v.3 network management, RMON support
- Supports Web-based management.
- Supports CLI management.
- Supports BOOTP/DHCP/DNS Relay
- Supports TFTP upgrade
- Supports System Log
- Fully configurable either in-band or out-of-band control via RS-232 console serial connection.
- Telnet remote control console
- Traffic Segmentation
- Simple Network Time Protocol
- MAC address update notification
- Web GUI Traffic Monitoring
- Supports RIP v1, v2
- Supports OSPF
- Supports PIM-DM
- Supports DVMRP
- Supports IGMP
- Supports floating static route

## Front Panel Components

The front panel of the Switch consists of LED indicators, an RS-232 communication port, a slide-in module slot, and 24 (10/100 Mbps) Ethernet/Fast Ethernet ports.



**Figure 1 - 1. Front Panel View of the Switch as shipped (no modules are installed)**

- Comprehensive LED indicators display the status of the switch and the network (see the *LED Indicators* section below).
- An RS-232 DCE console port for setting up and managing the switch via a connection to a console terminal or PC using a terminal emulation program.
- A front-panel slide-in module slot for Gigabit Ethernet ports can accommodate a 2-port 1000BASE-T Gigabit Ethernet module, a 2-port 1000BASE-SX Gigabit Ethernet module, a 2-port 1000BASE-LX Gigabit Ethernet module, or a 2-port GBIC-based Gigabit Ethernet module.
- Twenty-four high-performance, NWay Ethernet ports all of which operate at 10/100 Mbps with Auto-MDIX function for connections to end stations, servers and hubs. All ports can auto-negotiate between 10Mbps or 100Mbps, full or half duplex, and flow control.

## LED Indicators

The LED indicators of the Switch include Power, Console, and Link/Act. The following shows the LED indicators for the Switch along with an explanation of each indicator.

<b>Power</b>	This indicator on the front panel should be lit during the Power-On Self Test (POST). It will light green approximately 2 seconds after the Switch is powered on to indicate the ready state of the device.
<b>Console</b>	This indicator is lit green when the Switch is being managed via out-of-band/local console management through the RS-232 console port using a straight-through serial cable.
<b>Link/Act/Speed</b>	These indicators are located to the left and right of each port. The right side indicator will light when the port has a link of 100 Mbps; the Link indicator will not light for 10 Mbps links. The LEDs blink whenever there is reception or transmission (i.e. Activity--Act) of data occurring at a port.

See below for description of Stack ID LED indicator.

## Stacking LED Indicators

Stacking LED indicators include the Stack ID indicator on the front panel and the Link/Act indicators on the front of the DES-332GS stacking module.

Each stacking module has **Link** and **Act** LED indicators on its front panel for the IEEE 1394 IN/OUT pair and the GBIC port.

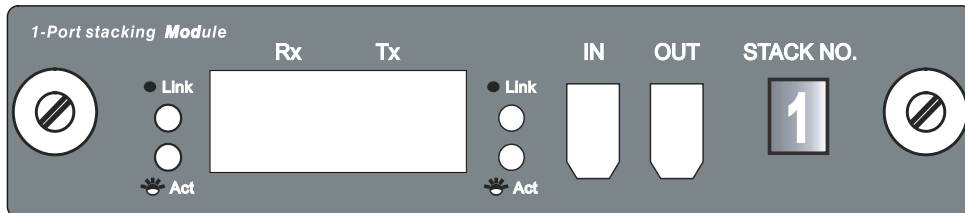

Figure 1-2. Front panel of stacking module

<b>Link</b>	The <b>Link</b> LED lights to confirm a valid link.
<b>Act</b>	The <b>ACT</b> LED blinks to indicate activity on the link.
<b>STACK NO.</b>	The <b>Stack Number</b> seven-segment LED displays the Unit number assigned to the Switch. A <b>zero (0)</b> in the display indicates that the stacking module is in the process of determining the stack status and has not yet resolved the Switch's Unit number.



**NOTICE:** Do not connect the stacked Switch group to the network until you have properly configured all Switches for stacking. An improperly configured Switch stack can cause a broadcast storm.

## Rear Panel Description

The rear panel of the Switch contains an AC power connector.

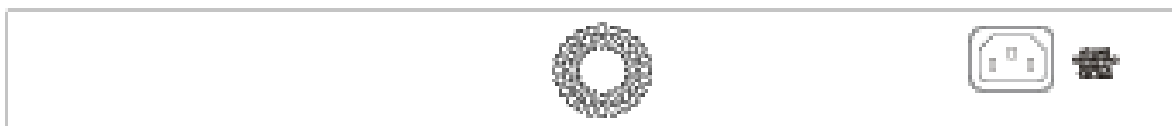
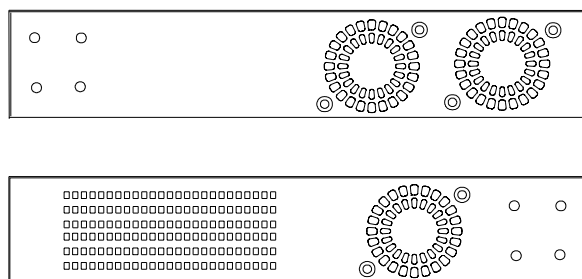

**Figure 1 - 3. Rear panel view of the Switch**

The AC power connector is a standard three-pronged connector that supports the power cord. Plug-in the female connector of the provided power cord into this socket, and the male side of the cord into a power outlet. The Switch automatically adjusts its power setting to any supply voltage in the range from 100 ~ 240 VAC at 50 ~ 60 Hz.

## Side Panels

The right side panel of the Switch contains two system fans (see the top part of the diagram below). The left side panel contains heat vents.



**Figure 1 - 4. Side panel views of the Switch**

The system fans are used to dissipate heat. The sides of the system also provide heat vents to serve the same purpose. Do not block these openings, and leave at least 6 inches of space at the rear and sides of the switch for proper ventilation. Be reminded that without proper heat dissipation and air circulation, system components might overheat, which could lead to system failure.

## Optional Plug-in Modules

The DES-3326S 24-port Fast Ethernet Switch is able to accommodate a range of optional plug-in modules in order to increase functionality and performance. These modules must be purchased separately.

### DES-132 2-port 100BASE-TX Module

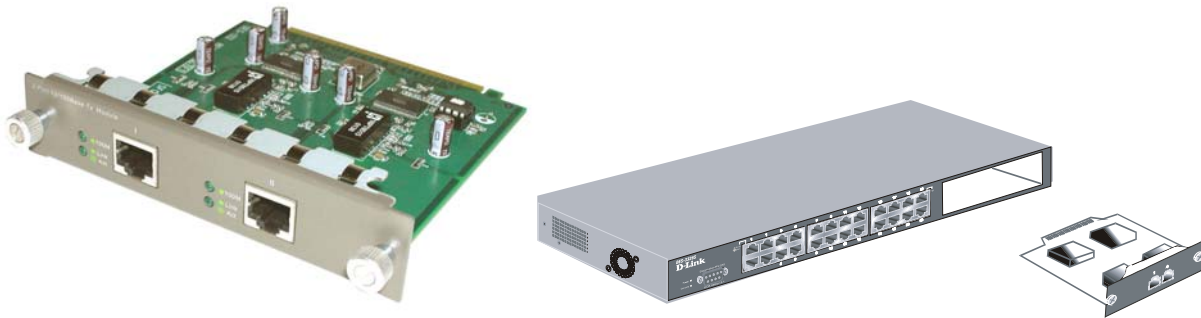

Figure 1 - 5. 100BASE-TX two-port module

### Port Functions

- Fully compliant with IEEE802.3 10BASE-T, IEEE802.3u 100BASE-TX
- Supports auto-negotiation in the following operation:
- 10/100M operation
- Full/Half Duplex operation
- Flow control: IEEE 802.3x compliant Flow Control support for full-duplex. Back pressure Flow Control support for half-duplex mode.

### LED Indicators

<b>Speed</b>	Off – 10M Solid Green – 100M
<b>Link/Activity</b>	Off – No Link Solid Green – Link Blinking Green – Activity



**DES-131F/132F 1/2-port 100BASE-FX Module**

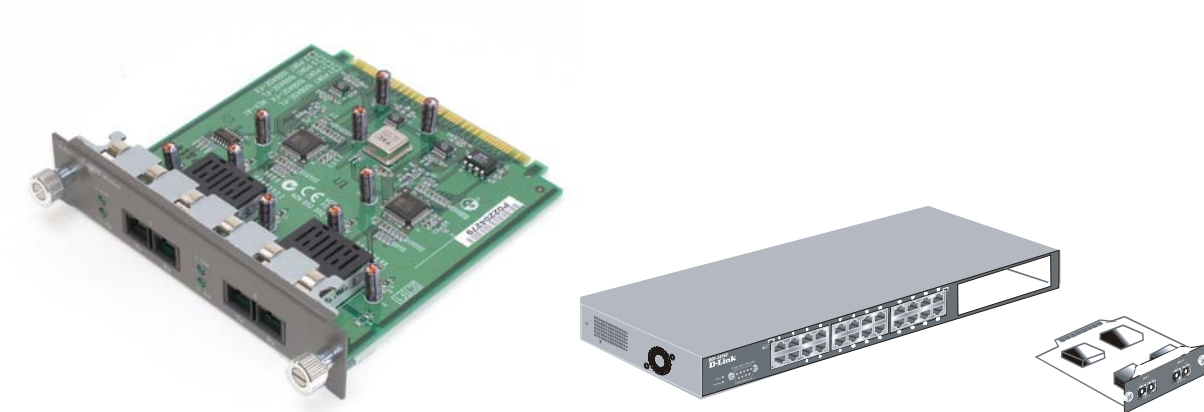

**Figure 1 - 6. 100BASE-FX two-port module**

**Port Functions**

- Fully compliant with IEEE802.3u 100BASE-FX
- Supports auto-negotiation in the following operation: 100M / Full-duplex / Flow control
- IEEE 802.3x compliant Flow Control support for full-duplex

Connector: SC Type

Distance: 2km

**LED Indicators**

<b>Link</b>	Off – No Link Solid Green – Link
<b>Active</b>	Off – No Activity Blinking Green – Activity

**DES-131FL/132FL 1/2-port 100BASE-FX Module**

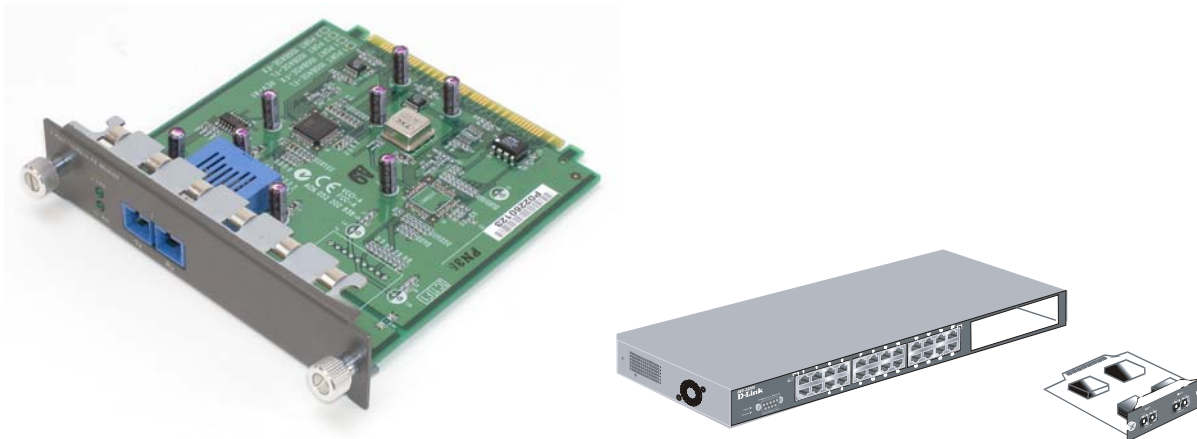

**Figure 1 - 7. 100BASE-FX module**

**Port Functions**

- Fully compliant with IEEE802.3u 100BASE-FX
- Supports auto-negotiation in the following operation: 100M / Full-duplex / Flow control
- IEEE 802.3x compliant Flow Control support for full-duplex

Connector: SC type

Distance: 15km

**LED Indicators**

<b>Link</b>	Off – No Link Solid Green – Link
<b>Active</b>	Off – No Activity Blinking Green – Activity

## DES-132T 2-port 1000BASE-T Module

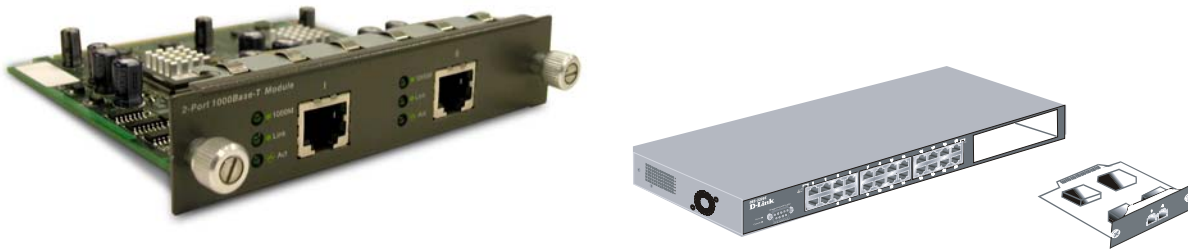

Figure 1 - 8. 1000BASE-T two-port module

### Port Functions

- 2 1000BASE-T Gigabit Ethernet ports
- Fully compliant with IEEE802.3 10BASE-T, IEEE802.3u 100BASE-TX, and IEEE802.3ab 1000BASE-T
- Supports auto-negotiation in the following operation: 10\*100/1000M / Full-duplex / Flow control
- IEEE 802.3x compliant Flow Control support for full-duplex

\* 10 Mbps not supported in firmware release 4.01

### LED Indicators

<b>Speed (1000M)</b>	Off – 10/100M Solid Green – 1000M
<b>Link</b>	Off – No Link Solid Green – Link
<b>Active</b>	Off – No Activity Blinking Green – Activity

### DES-132G 2-port 1000BASE-SX Gigabit Ethernet Module

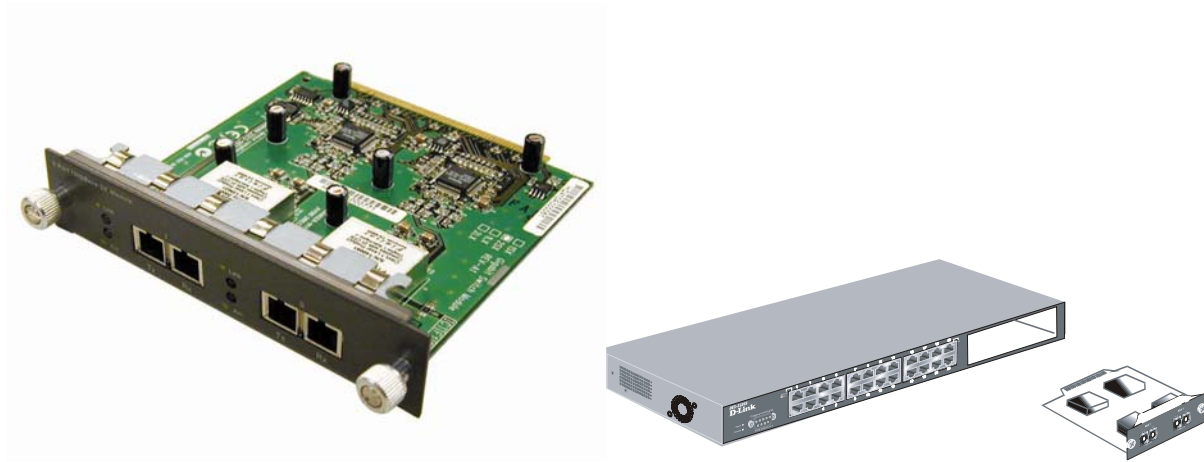

Figure 1 - 9. 1000BASE-SX two-port module

#### Port Functions

- 2 1000BASE-SX Gigabit Ethernet ports
- IEEE 802.3z 1000BASE-SX compliance
- Supports Full-duplex operations
- IEEE 802.3x compliant Flow Control support for full-duplex

Connector: SC Type

Distance: 550m

### DEM-320S 2-port 1000BASE-SX Gigabit Ethernet Module

#### Port Functions

- 2 1000BASE-SX Gigabit Ethernet ports
- IEEE 802.3z 1000BASE-SX compliance
- Supports Full-duplex operations
- IEEE 802.3x compliant Flow Control support for full-duplex

Connector: SC Type

Distance: 550m

#### LED Indicators

<b>Link</b>	Off – No Link Solid Green – Link
<b>Active</b>	Off – No Activity Blinking Green – Activity

**DES-132GL 2-port 1000BASE-LX Gigabit Ethernet Module**

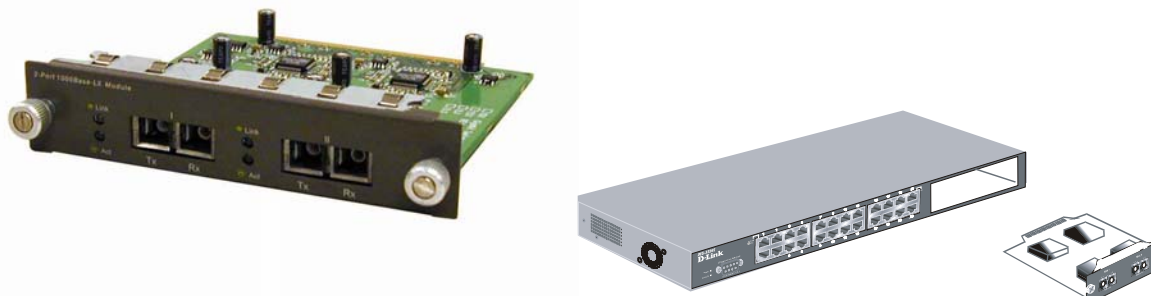

**Figure 1 - 10. 1000BASE-LX two-port module**

**Port Functions**

- 2 1000BASE-LX Gigabit Ethernet ports
- IEEE 802.3z 1000BASE-LX compliance
- Supports Full-duplex operations
- IEEE 802.3x compliant Flow Control support for full-duplex
- Supports multi-mode fiber optic cable connections of up to 550 meters or 5 km single-mode fiber-optic cable connections.

Connector: SC Type

Distance: 5km

**DEM-320L 2-port 1000BASE-LX Gigabit Ethernet Module**

**Port Functions**

- 2 1000BASE-LX Gigabit Ethernet ports
- IEEE 802.3z 1000BASE-LX compliance
- Supports Full-duplex operations
- IEEE 802.3x compliant Flow Control support for full duplex
- Supports single-mode fiber optic cable connections up to 550 meters or 5 km single-mode fiber optic connections.

The 1000BASE-SX module allows connections using multi-mode fiber optic cable in the following configurations:

	62.5µm	50µm
Unit: MHz*km	200	500
Operating distance Unit: meters	275	550
Channel insertion loss Unit: dB	2.53	3.43

Connector: SC Type

Distance: 10km (9/125um)

**LED Indicators**

- Link**            Off – No Link  
                       Solid Green – Link
- Active**         Off – No Activity  
                       Blinking Green – Activity

## DES-132GB 2-port GBIC-based Gigabit Ethernet Module

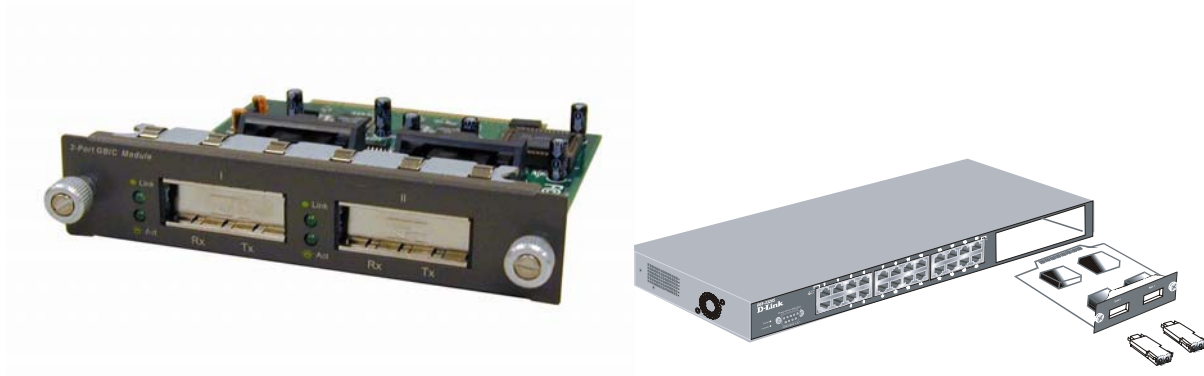

Figure 1 - 11. GBIC two-port module

### Port Functions

- 2 GBIC-based Gigabit Ethernet ports
- Allows multi-mode fiber optic connections of up to 550 m (SX and LX) and single-mode fiber optic connections of up to 5 km (LX only). GBIC modules are available in –SX and –LX fiber optic media.
- IEEE 802.3z compliance
- Supports full-duplex operations
- IEEE 802.3x compliant Flow Control support for full-duplex

## DEM-320GH 2-port GBIC-based Gigabit Ethernet Module

### Port Functions

- 2 GBIC-based Gigabit Ethernet ports
- Allows multi-mode fiber optic connections of up to 550 m (SX and LX) and single-mode fiber optic connections of up to 5 km (LX only). GBIC modules are available in –SX and –LX fiber optic media.
- IEEE 802.3z compliance
- Supports full-duplex operations
- IEEE 802.3x compliant Flow Control support for full-duplex

### LED Indicators

<b>Link</b>	Off – No Link Solid Green – Link
<b>Active</b>	Off – No Activity Blinking Green – Activity

**DES-332GS 1-port GBIC-Based Gigabit Ethernet Switch and stacking Module**

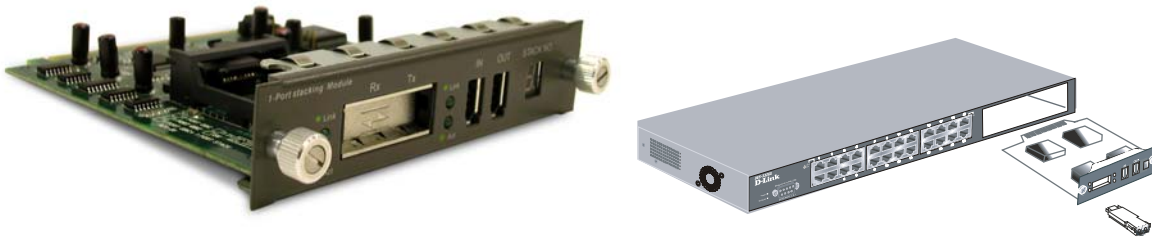

**Figure 1 - 12. Stacking Module with one GBIC port**

**Port Functions**

- 1 GBIC-Based Gigabit Ethernet port
- Allows multi-mode fiber optic connections of up to 550 m (SX and LX) and single-mode fiber optic connections of up to 5 km (LX only). GBIC modules are available in –SX and –LX fiber optic media.
- IEEE 802.3z 1000BASE-SX compliance
- Supports Full-duplex operations
- IEEE 802.3x compliant Flow Control support for full-duplex

**Stacking Port Function**

- 1 transmitting port and 1 receiving port
- IEEE1394.b compliance
- Forwarding rate up to 965Mbps

The stacking ports are marked **IN** and **OUT**. The IEEE 1394 compliant cable must be connected from an **IN** port on one Switch to an **OUT** port on the next Switch in the stack. The last two Switches (at the top and bottom of the stack) must also be connected from the **IN** port on one Switch to the **OUT** port on the other Switch. In this way, a loop is made such that all of the Switches in the Switch stack have the **IN** stacking port connected to another Switch’s **OUT** stacking port.

**DEM-320GS 1-port GBIC-Based Gigabit Ethernet Switch and stacking Module**

**Port Functions**

- 1 GBIC-Based Gigabit Ethernet port
- Allows multi-mode fiber optic connections of up to 550 m (SX and LX) and single-mode fiber optic connections of up to 5 km (LX only). GBIC modules are available in –SX and –LX fiber optic media.
- IEEE 802.3z 1000BASE-SX compliance
- Supports Full-duplex operations
- IEEE 802.3x compliant Flow Control support for full-duplex

**Stacking Port Function**

- 1 transmitting port and 1 receiving port
- IEEE1394.b compliance
- Forwarding rate up to 965Mbps

The optional Stacking Module allows up to eight DES-3326S Switches to be interconnected via their individual stacking modules. This forms an eight-Switch stack that can then be managed and configured as though the entire stack were a single Switch. The Switch stack is then accessed through a single IP address or alternatively, through the master Switch’s serial port (via the management station’s console and the Switch’s Command Line Interface).

**LED Indicators\***

- Link**                    Off – No Link  
                               Solid Green – Link
- Active**                Off – No Activity  
                               Blinking Green – Activity

\*See Stacking LED Indicators on for details on the stacking port display.

## Switch Stacking

The optional Stacking Module allows up to thirteen DES-3326S Switches to be interconnected via their individual Stacking Modules. This forms a thirteen-switch stack that can then be managed and configured as though the entire stack were a single switch. The switch stack is then accessed through a single IP address or alternatively, through the master switch's serial port (via the management station's console and the switch's Command Line Interface).

The stacking ports are marked **IN** and **OUT**. The IEEE 1394 compliant cable must be connected from an **IN** port on one switch to an **OUT** port on the next switch in the stack. In this way, a loop is made such that all of the switches in the switch stack have the **IN** stacking port connected to another switch's **OUT** stacking port. See Connecting Stacked Switch Groups on page 24 for an illustration of a properly connected stack.

Stack order can be automatically determined, the lowest MAC address is elected as the Master Switch and the remaining stack order depends on how the Switches are connected. However, it may be best to configure a Master for the group first using the CLI interface, and then connect the stack accordingly.



**NOTE:** Stacking mode is configured using the CLI command `config stacking mode`. The default settings allow the switch to function as a standalone device or as a member of a stacked group.



## Management Options

The system may be managed out-of-band through the console port on the front panel or in-band using Telnet, a web browser or SNMP-based management.

### Web-based Management Interface

After you have successfully installed the Switch, you can configure the Switch, monitor the LED panel, and display statistics graphically using a web browser, such as Netscape Navigator (version 6.2 and higher) or Microsoft® Internet Explorer (version 5.0).



**NOTE:** To access the Switch through a web browser, the computer running the web browser must have IP-based network access to the Switch.

### Command Line Console Interface through the Serial Port or Telnet

You can also connect a computer or terminal to the serial console port or use Telnet to access the Switch. The command-line-driven interface provides complete access to all Switch management features. For a full list of commands, see the Command Line Reference Manual, which is included on the documentation CD.

### SNMP-Based Management

You can manage the Switch with an SNMP-compatible console program. The Switch supports SNMP version 1.0, version 2.0 and version 3.0. The SNMP agent decodes the incoming SNMP messages and responds to requests with MIB objects stored in the database. The SNMP agent updates the MIB objects to generate statistics and counters.

The Switch supports a comprehensive set of MIB extensions:

- RFC 1643 Ether-like MIB
- RFC 1724 RIPv2 MIB
- RFC 1757 RMON
- RFC 1850 OSPF MIB
- RFC 1907 SNMPv2 MIB
- RFC 2021 RMON II MIB
- RFC 2096 IP-FORWARD MIB
- RFC 2233 IF-MIB
- RFC 2358 Ethernet-Link MIB
- RFC 2573 SNMP Notification and Target MIB
- RFC 2574 SNMP User-based SM MIB
- RFC 2575 SNMP View-based ACM MIB
- RFC 2674 802.1p and 802.1q Bridge MIB
- RFC 2737 Entity MIB
- RFC 2932 IPMROUTE STD MIB
- RFC 2933 IGMP MIB
- RFC 2934 PIM MIB
- IEEE8021-PAE 802.1x PAE MIB
- D-Link Enterprise MIB

## Chapter 2

# Installation

*Package Contents*

*Before You Connect to the Network*

*Connecting the Console Port*

*Password Protection*

*SNMP Settings*

*IP Address Assignment*

*Connecting Stacked Switch Groups*

*Configuring a Switch Group for Stacking*

*Connecting Devices to the Switch*

## Package Contents

Before you begin installing the Switch, confirm that your package contains the following items:

- One DES-3326S Layer 3 Switch
- Mounting kit: 2 mounting brackets and screws
- Four rubber feet with adhesive backing
- One AC power cord
- This Manual and CLI Reference on the documentation CD

## Before You Connect to the Network

Before you connect to the network, you must install the Switch on a flat surface or in a rack, set up a terminal emulation program, plug in the power cord, and then set up a password and IP address.



**NOTICE:** Do not connect the Switch to the network until you have established the correct IP settings, user accounts and proper stacking configuration (if the Switch is stacked).

## Connecting the Console Port

The Switch provides an RS-232 serial port that enables a connection to a computer or terminal for monitoring and configuring the Switch. This port is a female DB-9 connector, implemented as a Data Circuit-terminating Equipment (DCE) connection.

To use the console port, you need the following equipment:

- A terminal or a computer with both a serial port and the ability to emulate a terminal
- A null modem or crossover RS-232 cable with a female DB-9 connector for the console port on the Switch

To connect a terminal to the console port:

1. Connect the female connector of the RS-232 cable directly to the console port on the Switch, and tighten the captive retaining screws.
2. Connect the other end of the cable to a terminal or to the serial connector of a computer running terminal emulation software. Set the terminal emulation software as follows:
  - a. Select the appropriate serial port (COM port 1 or COM port 2).
  - b. Set the data rate to 9600 baud.
  - c. Set the data format to 8 data bits, 1 stop bit, and no parity.
  - d. Set flow control to `none`.
  - e. Under **Properties**, select **VT100 for Emulation** mode.
  - f. Select **Terminal keys** for **Function, Arrow, and Ctrl keys**. Ensure that you select **Terminal keys** (not Windows keys).



**NOTICE:** When you use HyperTerminal with the Microsoft® Windows® 2000 operating system, ensure that you have Windows 2000 Service Pack 2 or later installed. Windows 2000 Service Pack 2 allows you to use arrow keys in HyperTerminal's VT100 emulation. See [www.microsoft.com](http://www.microsoft.com) for information on Windows 2000 service packs.

- g. After you have correctly set up the terminal, plug the power cable into the power receptacle on the back of the Switch. The boot sequence appears in the terminal.
- h. After the boot sequence completes, the console login screen displays.
- i. If you have not logged into the command line interface (CLI) program, press the Enter key at the User name and password prompts. There is no default user name and password for the Switch, user names and passwords must first be created by the administrator. If you have previously set up user accounts, log in and continue to configure the Switch.
- j. Enter the commands to complete your desired tasks. Many commands require administrator-level access privileges. Read the next section for more information on setting up user accounts. See the *Command Line Reference* on the documentation CD for a list of all commands and additional information on using the CLI.
- k. When you have completed your tasks, exit the session with the **logout** command or close the emulator program.

## Password Protection

The DES-3326S does not have a default user name and password. One of the first tasks when settings up the Switch is to create user accounts. If you log in using a predefined administrator-level user name you have privileged access to the Switch's management software.

After your initial login, define new passwords for both default user names to prevent unauthorized access to the Switch, and record the passwords for future reference.

To create an administrator-level account for the Switch, do the following:

1. At the CLI login prompt, enter **create account admin** followed by the <user name> and press the Enter key.
2. You will be asked to provide a password. Type the <password> used for the administrator account being created and press the Enter key.
3. You will be prompted to enter the same password again to verify it. Type the same password and press the Enter key.
4. Successful creation of the new administrator account will be verified by a **Success** message.

User names and passwords can be up to 15 characters in length.



**NOTE:** Passwords are case sensitive.

The sample below illustrates a successful creation of a new administrator-level account with the user name "newmanager".

```

DES-3326S Fast Ethernet Switch Command Line Interface
                Firmware: Build 4.01-B12
                Copyright(C) 2000-2003 D-Link Corporation. All rights reserved.
UserName:
PassWord:

DES-3326S:4#create account admin newmanager
Command: create account admin newmanager

Enter a case-sensitive new password:*****
Enter the new password again for confirmation:*****
Success.

DES-3326S:4#_

```

**Figure 2 - 1. Create a new administrator account with CLI**



**NOTICE:** CLI configuration commands only modify the running configuration file and are not saved when the Switch is rebooted. To save all your configuration changes in nonvolatile storage, you must use the **save** command to copy the running configuration file to the startup configuration.

## IP Address Assignment

Each Switch must be assigned its own IP Address, which is used for communication with an SNMP network manager or other TCP/IP application (for example BOOTP, TFTP). The Switch's default IP address is 10.90.90.90. You can change the default Switch IP address to meet the specification of your networking address scheme.

The Switch is also assigned a unique MAC address by the factory. This MAC address cannot be changed, and can be found from the initial boot console screen – shown below.

```

Boot Procedure                                                    0.00.001
-----
Power On Self Test ..... 100 %
MAC Address   : 00-05-5D-17-FF-60
H/W Version  : 2B1
Please wait, loading Runtime image ..... 100 %_

```

**Figure 2 - 2. Boot Screen**

The Switch's MAC address can also be found from the Web management program on the Switch Information (Basic Settings) window on the Configuration menu.

The IP address for the Switch must be set before it can be managed with the Web-based manager. The Switch IP address can be automatically set using BOOTP or DHCP protocols, in which case the actual address assigned to the Switch must be known.

The IP address may be set using the Command Line Interface (CLI) over the console serial port as follows:

1. Starting at the command line prompt, enter the commands **config ipif System ipaddress xxx.xxx.xxx.xxx/yyy.yyy.yyy.yyy**. Where the **x**'s represent the IP address to be assigned to the IP interface named **System** and the **y**'s represent the corresponding subnet mask.
2. Alternatively, you can enter **config ipif System ipaddress xxx.xxx.xxx.xxx/z**. Where the **x**'s represent the IP address to be assigned to the IP interface named **System** and the **z** represents the corresponding number of subnets in CIDR notation.

The IP interface named **System** on the Switch can be assigned an IP address and subnet mask which can then be used to connect a management station to the Switch's Telnet or Web-based management agent.

```
DES-3326S Fast Ethernet Switch Command Line Interface
                          Firmware: Build 4.01-B12
                          Copyright(C) 2000-2003 D-Link Corporation. All rights reserved.
UserName:
PassWord:

DES-3326S:4#config ipif System ipaddress 10.1.1.100/8
Command: config ipif System ipaddress 10.1.1.100/8

Success.
```

**Figure 2 - 3. Assigning the Switch an IP Address**

In the above example, the Switch was assigned an IP address of 10.10.1.100 with a subnet mask of 255.0.0.0. The system message **Success** indicates that the command was executed successfully. The Switch can now be configured and managed via Telnet and the CLI or via the Web-based management.

## SNMP Settings

Simple Network Management Protocol (SNMP) is an OSI Layer 7 (Application Layer) designed specifically for managing and monitoring network devices. SNMP enables network management stations to read and modify the settings of gateways, routers, Switches, and other network devices. Use SNMP to configure system features for proper operation, monitor performance and detect potential problems in the Switch, Switch group or network.

Managed devices that support SNMP include software (referred to as an agent), which runs locally on the device. A defined set of variables (managed objects) is maintained by the SNMP agent and used to manage the device. These objects are defined in a Management Information Base (MIB), which provides a standard presentation of the information controlled by the on-board SNMP agent. SNMP defines both the format of the MIB specifications and the protocol used to access this information over the network.

The DES-3326S supports the SNMP versions 1, 2c, and 3. You can specify which version of the SNMP you want to use to monitor and control the Switch. The three versions of SNMP vary in the level of security provided between the management station and the network device.

In SNMP v.1 and v.2, user authentication is accomplished using 'community strings', which function like passwords. The remote user SNMP application and the Switch SNMP must use the same community string. SNMP packets from any station that has not been authenticated are ignored (dropped).

The default community strings for the Switch used for SNMP v.1 and v.2 management access are:

**public** - Allows authorized management stations to retrieve MIB objects.

**private** - Allows authorized management stations to retrieve and modify MIB objects.

SNMP v.3 uses a more sophisticated authentication process that is separated into two parts. The first part is to maintain a list of users and their attributes that are allowed to act as SNMP managers. The second part describes what each user on that list can do as an SNMP manager.

The Switch allows groups of users to be listed and configured with a shared set of privileges. The SNMP version may also be set for a listed group of SNMP managers. Thus, you may create a group of SNMP managers that are allowed to view read-only information or receive traps using SNMP v.1 while assigning a higher level of security to another group, granting read/write privileges using SNMP v.3.

Using SNMP v.3 individual users or groups of SNMP managers can be allowed to perform or be restricted from performing specific SNMP management functions. The functions allowed or restricted are defined using the Object Identifier (OID) associated with a specific MIB. An additional layer of security is available for SNMP v.3 in that SNMP messages may be encrypted. To read more about how to configure SNMP v.3 settings for the Switch read the next section, Management.

### Traps

Traps are messages that alert network personnel of events that occur on the Switch. The events can be as serious as a reboot (someone accidentally turned OFF the Switch), or less serious like a port status change. The Switch generates traps and sends them to the trap recipient (or network manager). Typical traps include trap messages for Authentication Failure or Topology Change.

### MIBs

Management and counter information are stored by the Switch in the Management Information Base (MIB). The Switch uses the standard MIB-II Management Information Base module. Consequently, values for MIB objects can be retrieved from any SNMP-based network management software. In addition to the standard MIB-II, the Switch also supports its own proprietary enterprise MIB as an extended Management Information Base. The proprietary MIB may also be retrieved by specifying the MIB Object Identifier. MIB values can be either read-only or read-write.

## Installing the Switch without the Rack

The Switch is supplied with rubber feet for stationing it on a flat surface and mounting brackets and screws for mounting the Switch in a rack. If you intend to use a stacked Switch arrangement, place the Master unit in the top position so that it may be easily identified.

1. Install the Switch on a level surface that can safely support the weight of the Switch and its attached cables. The Switch must have adequate space for ventilation and for accessing cable connectors.
2. Set the Switch on a flat surface and check for proper ventilation. Allow at least 5 cm (2 inches) on each side of the Switch and 15 cm (6 inches) at the back for the power cable.
3. Attach the rubber feet on the marked locations on the bottom of the chassis.
4. The rubber feet, although optional, are recommended to keep the unit from slipping.

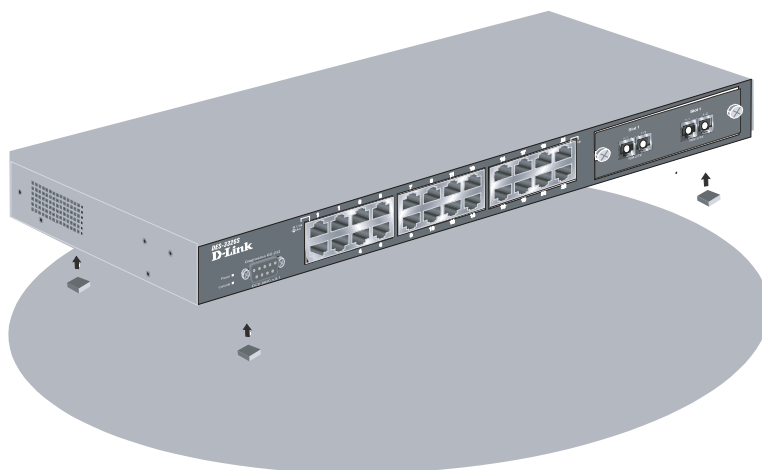

Figure 2-4. Install rubber feet for installations with or without a rack



## Installing the Switch in a Rack

You can install the Switch in most standard 19-inch (48.3-cm) racks. Refer to the illustrations below.

1. Use the supplied screws to attach a mounting bracket to each side of the Switch.
2. Align the holes in the mounting bracket with the holes in the rack.
3. Insert and tighten two screws through each of the mounting brackets.



Figure 2-5. Attach mounting brackets

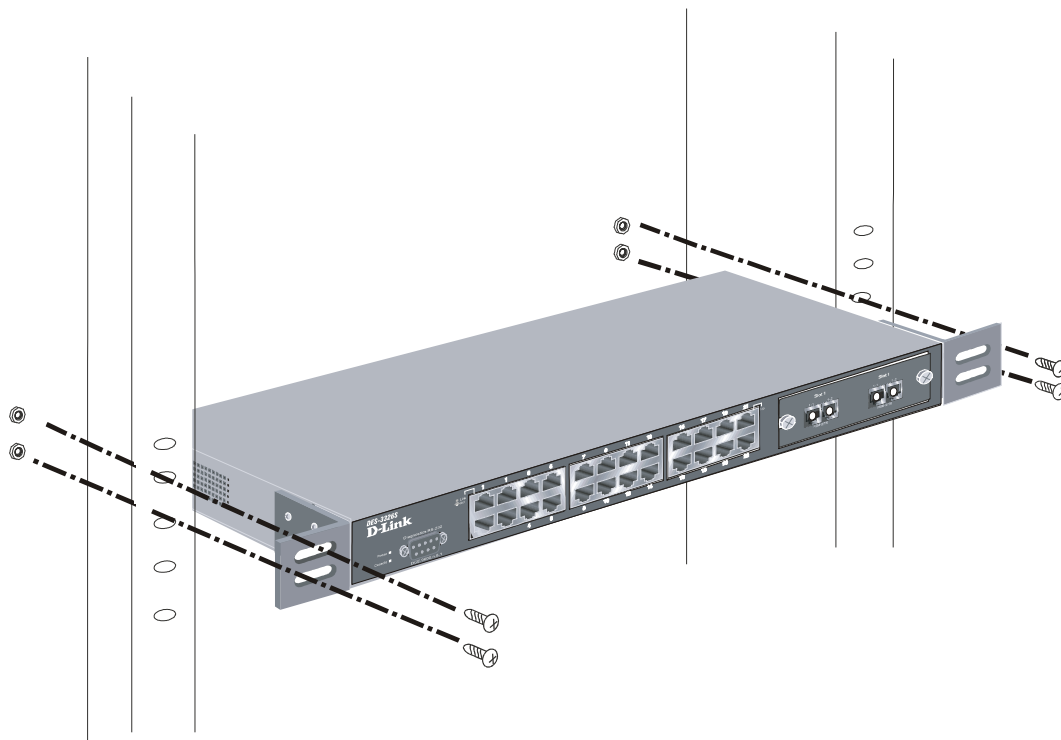

Figure 2-6. Install Switch in equipment rack

## Connecting Stacked Switch Groups

A total of up to thirteen DES-3326S Switches can be stacked, using the optional stacking module, into a Switch stack that can then be configured and managed as a single unit. The Web-based Management agent of the Master Switch can configure and manage all of the Switches in a Switch stack – using a single IP address (the IP address of the Master Switch).

The Command Line Interface (CLI) can also be used to manage and configure all of the Switches in a Switch stack – from the serial port on the Master Switch. The CLI can also be used to configure and manage the switch stack via the TELNET protocol – using a single IP address (the IP address of the Master Switch).



**NOTICE:** Do not connect the stacked Switch group to the network until you have properly configured all Switches for stacking. An improperly configured Switch stack can cause a broadcast storm.

### Stacking Connections with IEEE 1394 Cabling

The example below illustrates stacking connections for a six-switch stack.

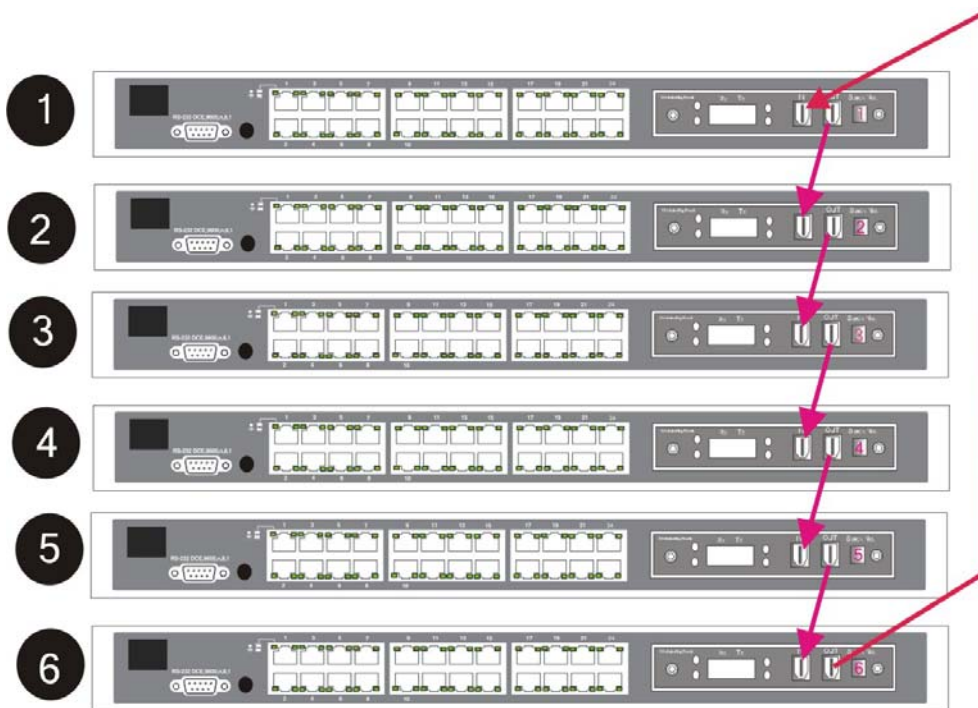

**Figure 2 - 7. Switch Stack connections between optional stacking modules**

The stacking ports are marked **IN** and **OUT**. The IEEE 1394 compliant cable must be connected from an **IN** port on one switch to an **OUT** port on the next switch in the stack. Connect the last Switch in the stack to the Master switch to complete the loop. This will create a ring topology for the stacked group. The logical stack order is determined by stacking connection in relation to the Master. The Number 2 Switch will be the Switch connected to the **OUT** port on the Master, the Number 3 Switch is connected to the **OUT** port on the Number 2 Switch, and so on.



**NOTICE:** If a link between stacked switches fails the stacked group must be connected to work around the failed link. Any change to the composition of a stacked switch group or any failure of a stacking port will trigger an automatic restart of the entire stack. Therefore, after making the necessary changes to the stacked group, restart the entire stack again so the new stacking relationship may be negotiated again. Read the CLI Reference for information on manual configuration of Switch Stacking Commands.

## Notes on Stacking Switches

By default, the Switch configuration settings allow it to operate as a standalone device, or in a stacked group. It is not necessary to change any settings for the Switch to function in either capacity. However, it is recommended that a Master Switch be manually designated for a stacked group when it is first set up.

Keep in mind the following guidelines when setting up a Switch stack:

- A Switch that is not connected to another DES-3326S through the stacking ports will operate as a standalone Switch even if the stacking mode is enabled as a Master or in Auto mode.
- In order to easily identify the Master Switch, place the designated Master unit at the top of the stack. Use the auto stacking mode for the remaining Switches. Stack order is determined by how the Switches are connected in relation to the Master.
- If a link between stacked switches fails the stacked group must be connected to work around the failed link. As with any changes in the composition of the stacked switch group, the new stacking relationship must be negotiated. Any change to the composition of a stacked switch group or any failure of a stacking port will cause the entire stack to restart and negotiate the new stacking composition.

The slave Switch units must meet the following criteria:

- All additional slave Switches must be the same model, that is (at the time of the writing of this manual), the slaves must be all DES-3326S Switches. The slave unit types cannot be mixed within a single stacked group.
- All Switches must have the same firmware version loaded to operate in a stacked group.
- A Master should be designated for the group. If the remaining Switches are using the default stacking mode configuration, the Master will be recognized and the stack order established automatically.

Stacking mode can be changed using the CLI. The possible stacking configuration modes are as follows:

**Disabled:** This forces the Switch to operate as a standalone device. In standalone mode the Switch functions as a standalone device even if a stacking module is installed. To force standalone operation it is necessary to use the CLI command **config stacking mode disable**. A Switch that has stacking mode disabled should never connect to another Switch through stacking ports. See below for notes on standalone operation.



**NOTICE:** Do not use stacking ports on a Switch that has the stacking mode disabled.

**Enabled:** Stacking mode is enabled by default. When enabled the Switch can operate as a standalone device or it can operate with other DES-3326S Switches in a properly connected stacked group. Stacking must be enabled for the Switch function in a stacked arrangement with other DES-3326S Switches. When stacking mode is enabled it must also be configured to function in auto, master or slave mode.

**Auto:** This is the default stacking mode setting for the DES-3326S. In auto stacking mode the Switch is eligible for stacking or it can operate as a standalone device. If a DES-3326S Switch stack is connected and all units are configured to operate in auto stacking mode, the master-slave relationships is determined automatically. However, as previously noted, it is better to manually designate a Switch (at the top of the stack) to be the Master Switch and restart the entire stack. See the instructions below for details on how to manually designate a Master.

**Master:** The auto mode described above may be overridden so that a properly connected Switch in a stack may be forced into master mode. Only one Switch in a stack may act as the master and all configuration settings for the stacked group - including stacking configuration - are saved in configuration files in the master Switch. The stack is managed as a single entity through the master. It may be convenient to place the master unit in the upper-most slot of a stacked group to visually distinguish it from the slave units. The master unit should be used to uplink the stack group to the backbone. If the master unit fails or is replaced for any reason, it is possible to load configuration files saved from the original master unit in order to continue operation with identical settings.

**Slave:** The auto mode may be overridden to force the Switch to operate in slave mode. When the Switch is in slave mode, it is ineligible to function as a master and all configuration, is done through the Master unit. A Master Switch must be properly connected to the stack for a Switch to operate in slave mode.

## Configuring a Switch Group for Stacking

In order to set up a stack of DES-3326S Switches it is only necessary to designate a single Switch as Master if all the Switches are using the default auto setting for the stacking mode configuration. Stacking mode may also be disabled for standalone operation, however it is not necessary to disable stacking to use the Switch as a standalone device. When the stacking mode is enabled, the options available for operation are **auto** (default), **master** and **slave**.

```
DES-3326S Fast Ethernet Switch Command Line Interface
                          Firmware: Build 4.01-B27
                          Copyright(C) 2000-2004 D-Link Corporation. All rights reserved.
UserName:
Password:

DES-3326S:4#config stacking mode enable
Command: config stacking mode enable

Next possible completions:
master          auto          slave

DES-3326S:4#_
```

**Figure 2 - 8. Stacking mode options when enabled**

To configure the DES-3326S to function in a stacked group as the Master, do the following:

1. At the CLI login prompt, enter **config stacking mode enable master** and press the **Enter** key.
2. You will be prompted to save the stacking mode configuration. Press the **Y** key (yes) to save the stacking mode configuration.

Successful configuration will be verified by a **Success** message. It takes a few seconds for the change to be saved and to take effect.



**NOTICE:** A Switch that has previously been operating as a standalone Switch maintains a configuration file used only for standalone operation. Therefore if a standalone Switch is later used in a stack, the standalone configuration file is NOT loaded upon restart. New configuration settings must be configured for any Switch that makes a transition from standalone operation to Master of a Switch stack.

```
DES-3326S Fast Ethernet Switch Command Line Interface
                          Firmware: Build 4.01-B27
                          Copyright(C) 2000-2004 D-Link Corporation. All rights reserved.
UserName:
Password:

DES-3326S:4#config stacking mode enable
Command: config stacking mode enable

Next possible completions:
master          auto          slave

DES-3326S:4#config stacking mode enable master
Command: config stacking mode enable master

Do you want to save the new system configuration to NV-RAM now?(y/n)
Saving all configurations to NV-RAM... Done.
Success.

DES-3326S:4#
```

**Figure 2 - 9. config stacking mode enable master**

The remaining slave units in the stack can be set to the default configuration to automatically recognize the presence of the Master. The stack order will likewise be determined automatically according to the physical stacking connection.

## Notes on Standalone Operation

The DES-3326S operates as a standalone Switch using the default configuration settings when it is not connected to another Switch through a stacking port. It may also be configured to disable stacking for the Switch, in which case, if a stacking module is installed, the stacking port should not be used.

Configuration settings for a standalone Switch are saved in a configuration file that is only used for standalone operation. This standalone configuration is used whenever the Switch is used as a standalone Switch, even if the stacking mode is enabled for Auto or Master. Likewise, a separate configuration file is used when a Switch is operating as a stacked unit. This is important if the stacking function of a Switch is changed from standalone operation. For example, if a standalone Switch is later used as a Master Switch for a stack, it will NOT load the previously created standalone configuration file. A Switch that makes a transition from standalone operation to Master, must be reconfigured with new IP settings and other settings.

### To Disable Stacking

If you prefer to disable stacking for a standalone Switch, use the CLI command **config stacking mode disable**. Once stacking mode has been disabled on a Switch, do not use the stacking ports (if there are any installed).

```
DES-3326S Fast Ethernet Switch Command Line Interface
                          Firmware: Build 4.01-B27
                          Copyright(C) 2000-2004 D-Link Corporation. All rights reserved.
UserName:
PassWord:

DES-3326S:4#config stacking mode disable
Command: config stacking mode disable

Do you want to save the new system configuration to NV-RAM now?(y/n)
Saving all configurations to NV-RAM... Done.
Success.

DES-3326S:4#_
```

Figure 2 - 10. config stacking mode disable

## Unit ID Display for Switches in a Switch Stack

The Stack ID 7-segment LED (as shown below) on the front panel of the stacking module displays the logical **STACK NO.** The Master Switch in the stack will display **STACK NO. 1**. The remaining slaves display the **STACK NO. 2** to **13** according to the position in the logical stack order.

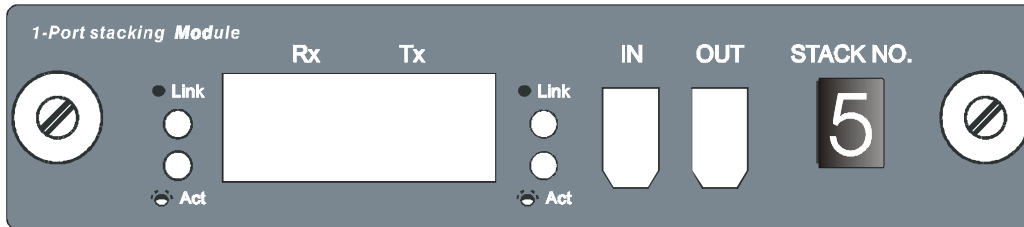

Figure 2 - 11. DES-3326S Stacking Module Front Panel

## Connecting Devices to the Switch

These connections can be accomplished at any port in either straight-through cable or a crossover cable because the switch supports Auto-MDIX function.



**NOTE:** Auto-MDIX function is not supported by the 100BASE-TX module.

- A 10BASE-T hub or switch can be connected to the switch via a two-pair Category 3, 4 or 5 UTP/STP cable.
- A 100BASE-TX hub or switch can be connected to the switch via a two-pair Category 5 UTP cable.
- A 1000BASE-T connections use two-pair Category 5e UTP cable.



**NOTICE:** Spanning Tree Protocol is disabled by default on the Switch. Keep this in mind when connecting the Switch to the network.

## **Switch Management**

***Before You Start***

***General Deployment Strategy***

***Web-based User Interface***

***Basic Setup***

***Switch Information***

***Switch IP Settings***

***User Accounts Management***

***Saving Changes***

***Factory Reset***

***Restart System***

All software function of the DES-3326S can managed, configured and monitored via the embedded web-based (HTML) interface. The Switch can be managed from remote stations anywhere on the network through a standard browser such as Netscape Navigator/Communicator or Microsoft Internet Explorer. The browser acts as a universal access tool and can communicate directly with the Switch using the HTTP protocol.

The web-based management module and the Console program (and Telnet) are different ways to access the same internal Switching software and configure it. Thus, all settings encountered in web-based management are the same as those found in the console program.

### **Before You Start**

The DES-3326S Layer 3 Switch supports a wide array of functions and gives great flexibility and increased network performance by eliminating the routing bottleneck between the WAN or Internet and the Intranet. Its function in a network can be thought of as a new generation of router that performs routing functions in hardware, rather than software. It is in effect, a router that also has numerous independent Ethernet collision domains – each of which can be assigned an IP subnet.

This flexibility and rich feature set requires a bit of thought to arrive at a deployment strategy that will maximize the potential of the DES-3326S Layer 3 Switch. Please read the portions of this manual pertaining to the functions you wish to perform with the Switch. It is especially important to map out VLANs and configuration of IP interfaces, and OSPF configuration in advance of actual configuration. For this reason, these subjects are presented in greater detail in the final two parts of this manual.



## General Deployment Strategy

1. Determine how the network would be best segmented. This is probably done using VLANs in an existing layer 2 Switched network.
2. Develop an IP addressing scheme. This involves allocating a block of IP addresses to each network segment. Each network subnet is then assigned a network address and a subnet mask. Background information regarding IP addresses is presented in Part IV of this guide.
3. Determine which network resources must be shared by the subnets. Shared resources may be connected directly to Layer 3 Switches. Static routes to each of the shared resources should be determined.
4. Determine how each subnet will communicate with the WAN or Internet. Again, static routes should be determined and default gateways identified.
5. Develop a security scheme. Some subnets on the network need more security or should be isolated from the other subnets. IP or MAC filtering can be used. Also, one or more VLANs on the Layer 3 Switch can be configured without an IP subnet – in which case, these VLANs will function as a layer 2 VLAN and would require an external router to connect to the rest of the network.
6. Develop a policy scheme. Some subnets will have a greater need for multicasting bandwidth, for example. A policy is a mechanism to alter the normal packet forwarding in a network device, and can be used to intelligently allocate bandwidth to time-critical applications such as the integration of voice, video, and data on the network.
7. Develop a redundancy scheme. Planning redundant links and routes to network critical resources can save valuable time in case of a link or device failure. The DES-3326S Spanning Tree function can be used to block the redundant link until it is needed.

### VLAN Setup

VLANs setup in Layer 3 Switching is more complicated than in conventional Layer 2 Switching environments. Be sure to carefully plan the VLAN/IP interface arrangement for the network before configuring the VLANs and IP interface associations.

Please read the material provided in later chapters about setting up VLANs in a Layer 3 Switch for more information.

### Defining Static Routes

Routes between the IP interfaces and a default gateway or other router with a WAN connection should be determined beforehand and entered into the static/default routing table on the DES-3326S.

Static route configuration and related topics are discussed at length in later chapters.

## Web-based User Interface

The user interface provides access to various Switch configuration and management screens, allows you to view performance statistics, and permits you to graphically monitor the system status.

### Areas of the User Interface

The figure below shows the user interface. The user interface is divided into 3 distinct areas as described in the table below.

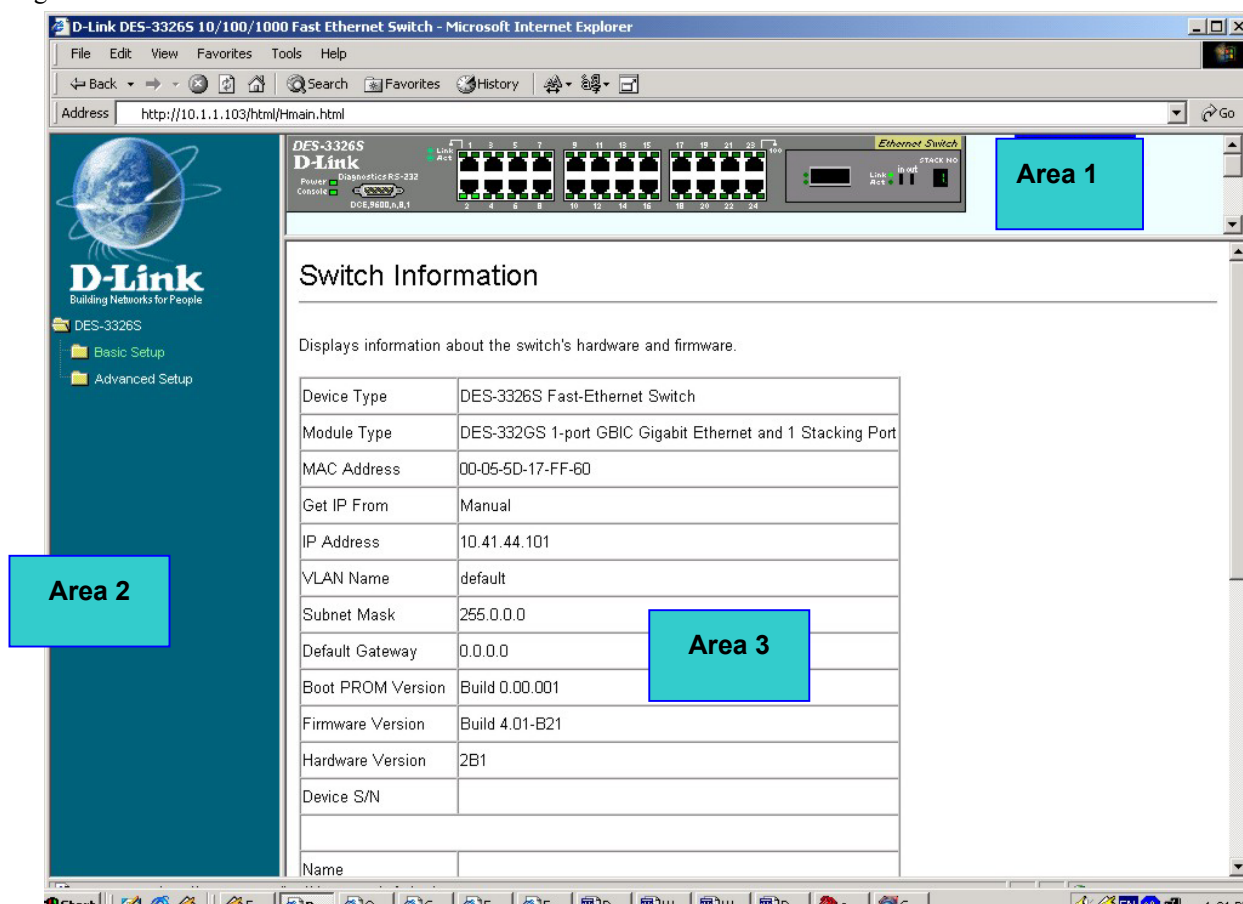

Figure 3- 1. Main Web-Manager window

Area	Function
1	Presents a graphical near real-time image of the front panel of the Switch. This area displays the Switch's ports and expansion modules. When the Switch is stacked a virtual representation of the Switch stack appears in the right hand portion. Click on the ports in the front panel to manage the port's configuration or view data for the port.
2	Select the menu or window to be displayed. The folder icons can be opened to display the hyperlinked menu buttons and subdirectories contained within them. Click the D-Link logo to go to the D-Link website.
3	Presents the information or menu selected for configuration or display.

## Login to Web Manager

To begin managing the Switch simply run the browser you have installed on your computer and point it to the IP address you have defined for the device. The URL in the address bar should read something like: `http://123.123.123.123`, where the numbers 123 represent the IP address of the Switch.



**NOTE:** The Factory default IP address for the Switch is 10.90.90.90.

In the Welcome page, click on the **Login** hyperlink; this opens a login screen. Enter a user name and password to access the Switch's management main page (pictured above). There is no user name or password configured for the Switch in the default settings, so if this is the first time logging in it is not necessary to enter these.



**NOTICE:** Any changes made to the Switch configuration during the current session must be saved in the **Save Changes** web menu (explained below) or use the command line interface (CLI) command **save**.

## Web Pages and Menus

Menus for configuration and information are organized in two folders or directories, Basic Setup and Advanced Setup. These folders contain all the menus and subdirectories used to configure, manage and view information for the DES-3326S.

The **Basic Setup** directory includes the **SNTP Settings**, **Network Management**, **Switch Utilities** and **Network Monitoring** subdirectories as well as the menus for **Switch Information**, **Basic Switch Setup** (includes IP settings), **Serial Port Settings**, **Port Configuration**, **Port Security Settings**, **Traffic Segmentation**, **User Accounts**, **Factory Reset**, **Save Changes** and **Restart System**.

**Advanced Setup** includes subdirectories for **Spanning Tree**, **MAC Notification**, **Forwarding**, **Configure QoS**, **VLAN Configuration**, **Link Aggregation**, **802.1x**, **System Log** and **Layer 3 IP Networking**. Other menus included are (Port) **Mirroring Configuration** and **Access Profile Mask Setup**.



**NOTE:** Configure the user name and password in the User Accounts menu before connecting the Switch to the greater network.

## Basic Setup

The subsections below describe how to change some of the basic settings for the Switch such as changing IP settings and assigning user names and passwords for management access privileges, as well as how to save the changes and restart the Switch. The menus to perform these tasks are located in the **Basic Setup** folder. The hyperlinked menu buttons in this folder include: **Switch Information**, **Basic Switch Setup**, **Serial Port Settings**, **Port Configurations**, **Port Security Settings**, **Traffic Segmentation Table**, **User Accounts**, **Factory Reset**, **Save Changes and Restart System**. Most of these menus and the subdirectories located in the Basic Setup folder are discussed in later chapters. The subdirectories include: **SNTP Settings**, **Network Management**, **Switch Utilities** and **Network Monitoring**.

### Switch Information

The first page displayed upon logging in presents the **System Information** menu. This page can be accessed at any time by clicking the **Switch Information** button in the **Basic Setup** folder.

The **System Information** page displays general information about the Switch including its MAC Address, Hardware Boot PROM and Firmware versions, and installed module information. To view the same information using the CLI interface use the command **show switch** (this will also display IP settings information).

Switch Information	
Displays information about the switch's hardware and firmware.	
Device Type	DES-3326S Fast-Ethernet Switch
Module Type	DES-332GS 1-port GBIC Gigabit Ethernet and 1 Stacking Port
MAC Address	00-05-5D-16-94-80
Get IP From	Manual
IP Address	10.41.44.3
VLAN Name	default
Subnet Mask	255.0.0.0
Default Gateway	0.0.0.0
Boot PROM Version	Build 0.00.001
Firmware Version	Build 4.01-B27
Hardware Version	2B1
Device S/N	
Name	
Location	
Contact	
Spanning Tree	Disabled
GVRP	Disabled
IGMP Snooping	Disabled
RIP	Disabled
DVMRP	Disabled
PIM-DM	Disabled
OSPF	Disabled
TELNET	Enabled (TCP 23)
WEB	Enabled (TCP 80)
RMON	Disabled

Figure 3- 2. Switch Information menu

## Switch IP Settings

Switch IP settings may initially be set using the console interface prior to connecting to it through the Ethernet. If the Switch IP address has not yet been changed, read the Introduction of the CLI Reference or read the instructions below on how to use the console port and CLI IP settings commands to establish IP settings for the Switch.

To change IP settings using the web manager you must access the **Basic Switch Setup** menu located in the **Basic Setup** folder.

**To configure the Switch's IP address:**

Open the **Basic Setup** folder and click the **Basic Switch Setup** menu button. The web manager will display the **Current Switch IP Settings** at the top of the menu interface. Use the IP settings fields under **New Switch IP Settings** to change the IP settings on the Switch. Follow the instructions below.

It is also possible to provide **Name**, **Location** and **Contact** information in this menu.

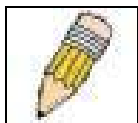

**NOTE:** the Switch's factory default IP address is 10.90.90.90 with a subnet mask of 255.0.0.0 and a default gateway of 0.0.0.0.

Basic Switch Setup	
Configure the switch's IP address and contact information.	
Current Switch IP Settings	
Get IP From	Manual
IP Address	10.42.73.10
Subnet Mask	255.0.0.0
Default Gateway	10.1.1.254
VLAN Name	default
New Switch IP Settings	
Get IP From	Manual
IP Address	10 . 42 . 73 . 10
Subnet Mask	255 . 0 . 0 . 0
Default Gateway	10 . 1 . 1 . 254
VLAN Name	default
Name	<input type="text"/>
Location	<input type="text"/>
Contact	<input type="text"/>
<input type="button" value="Apply"/>	

Figure 3- 3. Configure Switch IP Settings

**To manually assign the Switch's IP address, subnet mask, and default gateway address:**

1. Select **Manual** from the **Get IP From** drop-down menu.
2. Enter the appropriate IP address and subnet mask.

If you want to access the Switch from a different subnet from the one it is installed on, enter the IP address of the gateway. If you will manage the Switch from the subnet on which it is installed, you can leave the default address (0.0.0.0) in this field.

If no VLANs have been previously configured on the Switch, you can use the default VLAN ID (VID) 1. The default VLAN contains all of the Switch ports as members. If VLANs have been previously configured on the Switch, you will need to enter the VLAN ID of the VLAN that contains the port connected to the management station that will access the Switch. The Switch will allow management access from stations with the same VID listed here.

**To use the BOOTP or DHCP protocols to assign the Switch an IP address, subnet mask, and default gateway address:**

Use the **Get IP From:** <Manual> pull-down menu to choose from *BOOTP* or *DHCP*. This selects how the Switch will be assigned an IP address on the next reboot.

The Switch IP Settings options are:

Parameter	Description
<b>BOOTP</b>	The Switch will send out a BOOTP broadcast request when it is powered up. The BOOTP protocol allows IP addresses, network masks, and default gateways to be assigned by a central BOOTP server. If this option is set, the Switch will first look for a BOOTP server to provide it with this information before using the default or previously entered settings.
<b>DHCP</b>	The Switch will send out a DHCP broadcast request when it is powered up. The DHCP protocol allows IP addresses, network masks, and default gateways to be assigned by a DHCP server. If this option is set, the Switch will first look for a DHCP server to provide it with this information before using the default or previously entered settings.
<b>Manual</b>	Allows the entry of an IP address, Subnet Mask, and a Default Gateway for the Switch. These fields should be of the form xxx.xxx.xxx.xxx, where each xxx is a number (represented in decimal form) between 0 and 255. This address should be a unique address on the network assigned for use by the network administrator. The fields which require entries under this option are as follows:
<b>Subnet Mask</b>	A Bitmask that determines the extent of the subnet that the Switch is on. Should be of the form xxx.xxx.xxx.xxx, where each xxx is a number (represented in decimal) between 0 and 255. The value should be 255.0.0.0 for a Class A network, 255.255.0.0 for a Class B network, and 255.255.255.0 for a Class C network, but custom subnet masks are allowed.
<b>Default Gateway</b>	IP address that determines where packets with a destination address outside the current subnet should be sent. This is usually the address of a router or a host acting as an IP gateway. If your network is not part of an intranet, or you do not want the Switch to be accessible outside your local network, you can leave this field unchanged.

### Setting the Switch's IP Address using the Console Interface

Each Switch must be assigned its own IP Address, which is used for communication with an SNMP network manager or other TCP/IP application (for example BOOTP, TFTP). The Switch's default IP address is 10.90.90.90. You can change the default Switch IP address to meet the specification of your networking address scheme.

The IP address for the Switch must be set before it can be managed with the Web-based manager. The Switch IP address can be automatically set using BOOTP or DHCP protocols, in which case the actual address assigned to the Switch must be known.

The IP address may be set using the Command Line Interface (CLI) over the console serial port as follows:

Starting at the command line prompt, enter the commands **config ipif System ipaddress xxx.xxx.xxx.xxx/yyy.yyy.yyy.yyy**. Where the **x**'s represent the IP address to be assigned to the IP interface named **System** and the **y**'s represent the corresponding subnet mask.

Alternatively, you can enter **config ipif System ipaddress xxx.xxx.xxx.xxx/z**. Where the **x**'s represent the IP address to be assigned to the IP interface named **System** and the **z** represents the corresponding number of subnets in CIDR notation.

The IP interface named **System** on the Switch can be assigned an IP address and subnet mask which can then be used to connect a management station to the Switch's Telnet or Web-based management agent.

The system message **Success** indicates that the command was executed successfully. The Switch can now be configured and managed via Telnet and the CLI or via the Web-based management agent using the above IP address to connect to the Switch.

## User Accounts Management

Use the **User Accounts** table to control user privileges. To view existing User Accounts, open the **Basic Setup** folder and click on the **User Accounts** link. This will open the **User Accounts Table**, as shown below. If no user accounts have et been created, there will not be any listed here.

	Username	Access Level
⊙	Mike	Admin

**Figure 3- 4. User Accounts Table**

To add a new user, click on the **New** button. A new menu appears.

To delete an existing user account, select the Username and click on the **Delete** button. You will be prompted to confirm that you want to delete the account. Click **OK** to delete the account information and continue.

Username	Mike
New Password	*****
Confirm New Password	*****
Access Level	Admin ▾

Back Apply

**Figure 3- 5. User Accounts - Add**

Add a new user by typing in a **User Name**, and **New Password** and retype the same password in the **Confirm New Password**. Choose the level of privilege (**Admin** or **User**) from the **Access Level** drop-down menu. Click on the **Apply** button to create the new account. The new Username now appears in the User Accounts Table

To modify an existing user, select the Username listed in the User Accounts table and click on the **Edit** button. For an existing account, the Username may not be changed. If you wish to change the username you must delete the account and create a new one.

### User Accounts - Edit

Username	routergod
Old Password	<input type="text"/>
New Password	<input type="text"/>
Confirm New Password	<input type="text"/>
Access Level	Admin ▾

**Figure 3- 6. User Accounts - Edit**

To change the password, type in the **New Password** and retype it in the **Confirm New Password** entry field. Choose the level of privilege (**Admin** or **User**) from the **Access Level** drop-down menu.



## Admin and User Privileges

There are two levels of user privileges: **Admin** and **User**. Some menu selections available to users with **Admin** privileges may not be available to those with **User** privileges.

The following table summarizes the **Admin** and **User** privileges:

Management	Admin	User
<b>Configuration</b>	Yes	Read Only
<b>Network Monitoring</b>	Yes	Read Only
<b>Community Strings and Trap Stations</b>	Yes	Read Only
<b>Update Firmware and Configuration Files</b>	Yes	No
<b>System Utilities</b>	Yes	Ping Only
<b>Factory Reset</b>	Yes	No
<b>User Account Management</b>		
<b>Add/Update/Delete User Accounts</b>	Yes	No
<b>View User Accounts</b>	Yes	No

After establishing a User Account with **Admin**-level privileges, be sure to save the changes (see below).

## Saving Changes

Changes made to the Switch's configuration must be saved in order to retain them. Access the **Save Changes** menu located in the **Basic Setup** folder and click on **Save Configuration** button to save any changes made to the Switch configuration.

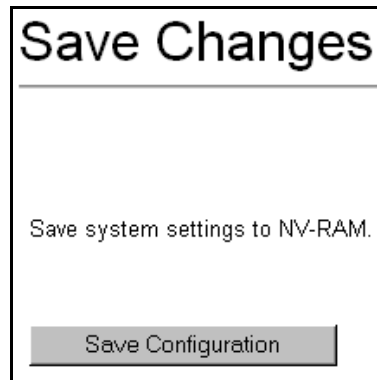

**Figure 3- 7. Save Configuration window**

The Switch has two levels of memory, normal RAM and non-volatile or NV-RAM. To save all the changes made in the current session to the Switch's flash memory, click the **Save Configuration** button. Click the **OK** button in the new dialog box that appears to continue. When this is done, the settings will be immediately applied to the Switching software in RAM, and will immediately take effect. Once the Switch configuration settings have been saved to NV-RAM, they become the default settings for the Switch. These settings will be used every time the Switch is rebooted. This is equivalent to implementing the **save** command using the CLI.

Some settings, though, require you to restart the Switch before they will take effect. Restarting the Switch erases all settings in RAM and reloads the stored settings from the NV-RAM. Thus, it is necessary to save all setting changes to NV-RAM before rebooting the Switch.

## Factory Reset

Click the **Factory Reset** link in the **Basic Setup** folder to bring up the reset menu.

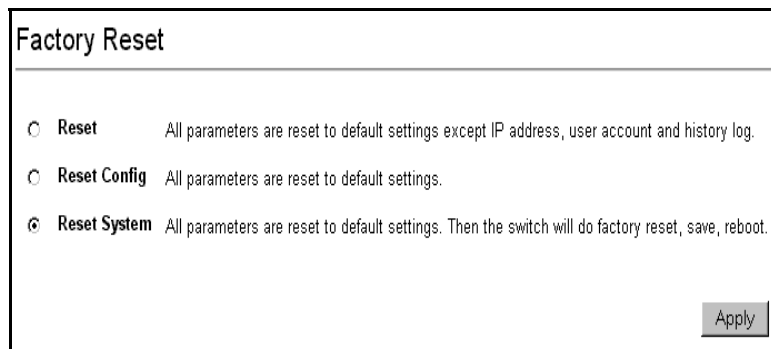

**Figure 3- 8. Factory Reset to Default Value**

The following options are available to perform a factory reset:

- **Reset** – If you select this option, the Switch's stacking mode, IP address, subnet mask, and default gateway settings do not change. All other configuration settings return to the factory default settings
- **Reset Config** – Choose this option to return all configuration settings to the factory default settings, but does not save the settings or reboot the Switch. If you select this option, all of the factory default settings are restored on the Switch including the IP address, user accounts, stacking mode (set to auto) and the switch history log. The switch will not reboot. New user accounts information and IP settings will need to be assigned.
- **Reset System** – all of the factory default settings are restored on the switch. The switch will reboot. New user accounts information and IP settings will need to be assigned.

Select the reset option you want to perform and click on the **Apply** button.

## Restart System

The following menu is used to restart the Switch. Access this menu by clicking on the **Restart System** link in the **Basic Setup** folder.

Click the **Yes** after **Do you want to save the settings?** to instruct the Switch to save the current configuration to non-volatile RAM before restarting the Switch.

Clicking the **No** option instructs the Switch not to save the current configuration before restarting the Switch. All of the configuration information entered from the last time **Save Changes** was executed will be lost.

Click the **Restart** button to restart the Switch.

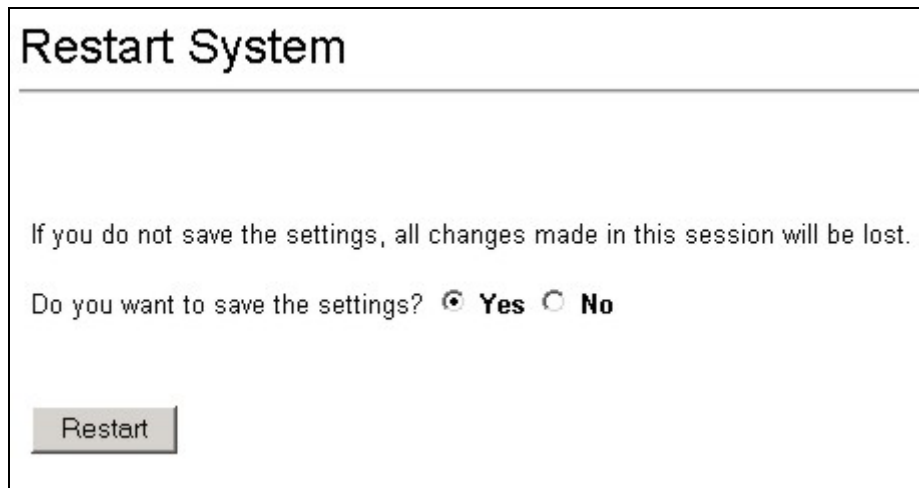

Restart System

---

If you do not save the settings, all changes made in this session will be lost.

Do you want to save the settings?  **Yes**  **No**

Restart

Figure 3- 9. Restart System



**NOTE:** Clicking **Yes** is equivalent to executing **Save Changes** and then restarting the Switch.

## Stacking Mode



**NOTE:** Stacking mode is configured using the CLI command **config stacking mode**. To view stacking and related information about switches in the stack use the CLI command **show stacking**.

The DES-3326S Switch can be used as a standalone Layer 3 Switch or it can be used in a stacked arrangement. There are two hardware requirements to use the Switch in a stacked group:

1. The proper module(s) must be installed. A stacking module must be installed in order to use the Switch in a stacked configuration. The DES-332GS stacking module is described on page 13.
2. Currently the firmware for the DES-3326S and DES-3326SR does not yet support stacking with the DGS-3312SR Layer 3 Switch or the DES-3226S Layer 2 Switch. Furthermore, the two models (DES-3326S and DES-3326SR) cannot be mixed in a stack as of this writing. Each stacked Switch group must be uniform in type, model and firmware. In other words, the stack must consist entirely of DES-3326S, or entirely of DES-3326SR Layer 3 Switches.

If the Switches in the stacked group meet these criteria and are properly connected, they may be stacked in groups of up to thirteen Switches.

Changes to a Switches stacking mode must be using the CLI interface. Please refer to the CLI Reference Manual or read

Configuring a Switch Group for Stacking on page 26 for a description of how to configure the stacking mode. The default settings allow the slave switches to automatically detect the presence of a Master Switch and determine the stacking order. Therefore it is only necessary to configure one Switch to be the Master if the remaining slaves are set to their default settings (**config stacking mode enable auto**). The CLI command to designate a Master is **config stacking mode enable master**.

The switch stack (up to 13 – total) is displayed in the upper right-hand corner of your web-browser. The icons are in the same order as their respective Unit numbers.

To view the stacking information, use the CLI command **show stacking**. The illustration below shows a typical Switch stack information display.

```
DES-3326S:4#  
DES-3326S:4#sh stack  
Command: show stacking  
  
ID  MAC Address      Port Range Mode      Version RPS Status Model Name  
-----  
*1  00-00-81-00-01-E0  1 - 26  AUTO      4.01-B27 Not Support DES-3326S  
2   00-36-57-01-00-00  27 - 52  AUTO      4.01-B27 Not Support DES-3326S  
3   00-00-81-05-02-80  53 - 78  AUTO      4.01-B27 Not Support DES-3326S  
  
Total Entries :3
```

These parameters are listed in the CLI display:

Parameter	Description
<b>ID</b>	This displays the Switch's order in the stack. The Switch with a Unit ID of 1 is the Master switch.
<b>MAC Address</b>	The MAC Address is the unique address of the switch assigned by the factory.
<b>Port Range</b>	This is the range of ports assigned to the corresponding Switch in the Switch stack. Notice in the example above, Switch number 2 (Unit ID 2) has a Start Port of 27 since there are twenty-six ports on the Master Switch. A third Switch is added to the stack, so the Start Port of Switch number 3 (Unit ID 3) becomes 54, and so on.
<b>Mode</b>	This displays the stacking mode configured for the Switch. The possible stacking modes are <i>Auto</i> , <i>Master</i> and <i>Slave</i> .
<b>Version</b>	The Version in this menu refers to the Switch firmware version.
<b>RPS Status</b>	Displays the status of an optional Redundant Power Supply for DES-3326SR.
<b>Model Name</b>	Displays the model name of the corresponding Switch in a stack.

---

## **Port Configuration**

*Configure Ports*

*Serial Port Settings*

*Port Security Settings*

*Traffic Segmentation*

This section contains information for configuring various attributes and properties for individual physical ports and port mirroring.

## Configure Ports

Click the **Port Configurations** link in the **Basic Setup** folder:

For stacked switch installations, it will be necessary to select the Unit (switch) according to its logical position in the stack.

### Port Configurations

Enable or disable individual ports and set their speed and duplex state.

Unit

**Figure 5- 1. Choose switch from stack**

Click the radio button on the far left to select the port you want to configure and click the **Edit** button. The basic settings for the Switch ports are summarized in the table below.

	Port	State	Setting	Connection	Learn
<input type="radio"/>	1	Enabled	Auto/Disabled	Link Down	Enabled
<input type="radio"/>	2	Enabled	Auto/Disabled	Link Down	Enabled
<input type="radio"/>	3	Enabled	Auto/Disabled	100M/Full/None	Enabled
<input type="radio"/>	4	Enabled	Auto/Disabled	Link Down	Enabled
<input type="radio"/>	5	Enabled	Auto/Disabled	Link Down	Enabled
<input type="radio"/>	6	Enabled	Auto/Disabled	Link Down	Enabled
<input type="radio"/>	7	Enabled	Auto/Disabled	Link Down	Enabled
<input type="radio"/>	8	Enabled	Auto/Disabled	Link Down	Enabled
<input type="radio"/>	9	Enabled	Auto/Disabled	Link Down	Enabled
<input type="radio"/>	10	Enabled	Auto/Disabled	Link Down	Enabled
<input type="radio"/>	11	Enabled	Auto/Disabled	Link Down	Enabled
<input type="radio"/>	12	Enabled	Auto/Disabled	Link Down	Enabled
<input type="radio"/>	13	Enabled	Auto/Disabled	Link Down	Enabled
<input type="radio"/>	14	Enabled	Auto/Disabled	Link Down	Enabled
<input type="radio"/>	15	Enabled	Auto/Disabled	Link Down	Enabled
<input type="radio"/>	16	Enabled	Auto/Disabled	Link Down	Enabled
<input type="radio"/>	17	Enabled	Auto/Disabled	Link Down	Enabled
<input type="radio"/>	18	Enabled	Auto/Disabled	Link Down	Enabled
<input type="radio"/>	19	Enabled	Auto/Disabled	Link Down	Enabled
<input type="radio"/>	20	Enabled	Auto/Disabled	Link Down	Enabled
<input type="radio"/>	21	Enabled	Auto/Disabled	Link Down	Enabled
<input type="radio"/>	22	Enabled	Auto/Disabled	Link Down	Enabled
<input type="radio"/>	23	Enabled	Auto/Disabled	Link Down	Enabled
<input type="radio"/>	24	Enabled	Auto/Disabled	Link Down	Enabled
<input type="radio"/>	25	Enabled	Auto/Disabled	Link Down	Enabled
<input type="radio"/>	26	Enabled	Auto/Disabled	Link Down	Enabled

**Figure 5- 2. Port Configurations**



Click on the port you want to configure on the **Port Configurations** menu and then click the **Edit** button. This will open the following dialog box:

**Figure 5-3. Port Configurations – Edit**

The **Unit** drop-down dialog box allows you to select different switches in a switch stack, if you have the optional stacking module installed and the switches in the stack are properly interconnected.

The **Port** pull-down menu allows different ports (on the currently selected Unit) to be selected for configuration. You can also select a range of ports (beginning with the Port selected above) to configure with the **Configure Ports from \_ to \_** pull-down menu.

The configurable parameters for ports include the following:

Parameter	Description
<b>State</b> <Enabled>	Toggle the <b>State</b> <Enabled> field to either enable or disable a given port.
<b>Speed/Duplex</b> <Auto>	Toggle the <b>Speed/Duplex</b> <Auto> field to either select the speed and duplex/half-duplex state of the port. Auto – auto-negotiation between 10 and 100 Mbps devices, full- or half-duplex. The Auto setting allows the port to automatically determine the fastest settings the device the port is connected to can handle, and then to use those settings. The other options are <i>100M/Full</i> , <i>100M/Half</i> , <i>10M/Full</i> , and <i>10M/Half</i> . There is no automatic adjustment of port settings with any option other than <i>Auto</i> .
<b>Flow Control</b>	Displays the flow control scheme used for the various port configurations. Ports configured for full-duplex use 802.3x flow control, half-duplex ports use backpressure flow control, and Auto ports use an automatic selection of the two. Select to turn Flow Control <i>On</i> or <i>Off</i> . The default is On.
<b>Learning</b>	Enable or disable MAC address learning for the selected ports. When <i>Enabled</i> , destination and source MAC addresses are automatically listed in the forwarding table. When learning is <i>Disabled</i> , MAC addresses must be manually entered into the forwarding table. This is sometimes done for reasons of security or efficiency. See the section titled <b>MAC Forwarding</b> for information on entering MAC addresses into the forwarding table.

## Serial Port Settings

The **Serial Port Settings** window allows the configuration of the switch's serial port. Click on the **Serial Port Settings** link from the **Basic Setup** folder.

Console Settings	
Baud Rate	9600
Data Bits	8
Parity Bits	None
Stop Bits	1
Auto Logout	Never

Apply

**Figure 5- 4. Serial Port Settings**

The following fields can then be set for the serial port:

Parameter	Description
<b>Baud Rate</b>	Set the serial bit rate used to communicate with a management station. The console baud rate is 9600 bits per second.
<b>Data Bits</b>	Displays the number of bits that make up a word when communicating with the management station. The console interface uses 8 data bits.
<b>Stop Bits</b>	Displays the number of bits used to indicate that a word has been completely transmitted. The console interface uses 1 stop bit.
<b>Auto-Logout</b>	This sets the time the interface can be idle before the switch automatically logs-out the user. The options are <i>2 mins</i> , <i>5 mins</i> , <i>10 mins</i> , <i>15 mins</i> , or <i>Never</i> .

### Port Security Settings

Port security settings instruct the Switch on how to handle MAC address table entries for each port. The Port Security Settings menu link is located in the Basic Setup folder.

For stacked Switches, select the Switch form the Unit drop-down menu and configure the port security for the Switch. Follow the instruction below for port security settings.

Click the selection button on the far left that corresponds to the port you want to configure and click the **Edit** button.

The Port Security Edit menu appears, notice that once this menu is available you may move to any port on any switch in the stack to configure security for that port. See the table below for a description of the Port Security Settings parameters.

Port Security Settings				
Unit <input type="text" value="6"/>				
<input type="button" value="Edit"/>				
	Port	Admin State	Maxium Learning Address	Lock Address Mode
<input type="radio"/>	1	Disabled	1	DeleteOnReset
<input type="radio"/>	2	Disabled	1	DeleteOnReset
<input type="radio"/>	3	Disabled	1	DeleteOnReset
<input type="radio"/>	4	Disabled	1	DeleteOnReset
<input type="radio"/>	5	Disabled	1	DeleteOnReset
<input type="radio"/>	6	Disabled	1	DeleteOnReset
<input type="radio"/>	7	Disabled	1	DeleteOnReset
<input type="radio"/>	8	Disabled	1	DeleteOnReset
<input type="radio"/>	9	Disabled	1	DeleteOnReset
<input type="radio"/>	10	Disabled	1	DeleteOnReset
<input type="radio"/>	11	Disabled	1	DeleteOnReset
<input type="radio"/>	12	Disabled	1	DeleteOnReset
<input type="radio"/>	13	Disabled	1	DeleteOnReset
<input type="radio"/>	14	Disabled	1	DeleteOnReset
<input type="radio"/>	15	Disabled	1	DeleteOnReset

Port Security Settings - Edit	
Unit <input type="text" value="6"/>	
Port	<input type="text" value="2"/>
Admin State	<input type="text" value="Disabled"/>
Maxium Learning Address	<input type="text" value="1"/>
Lock Address Mode	<input type="text" value="DeleteOnReset"/>
Configure Ports from 2 to	<input type="text" value="1"/>
<input type="button" value="Back"/> <input type="button" value="Apply"/>	

Figure 5- 5. Port Security Settings

Figure 5- 6. Configure Port Security

Configure the following parameters for Port Security:

Parameter	Description
<b>Admin State</b> <Disabled>	Toggle Admin State to either enable or disable port security for the port.
<b>Max Learning Address</b> <1 >	Select the maximum number of addresses that may be learned for the port. The port can be restricted to 10 or less MAC addresses that are allowed for dynamically learned MAC addresses in the forwarding table.
<b>Lock Address Mode</b> <Delete On Reset>	Select <i>Delete On Timeout</i> to clear dynamic entries for the ports on timeout of the Forwarding Data Base (FDB). Specify <i>Delete On Reset</i> to delete all FDB entries, including static entries upon system reset or rebooting. Specify <i>Permanent</i> to ensure that MAC addresses do not age out. MAC addresses retain locked status even if the Switch is restarted if Permanent is selected here.
<b>Configure Ports from</b> __ to __	Use this to specify a consecutively numbered group of ports on the switch for configuration.

## Traffic Segmentation

The traffic segmentation table is used to limit traffic flow from a single port to other ports on the switch. It cannot be used to segment traffic between switch units in a stack. For this it would be appropriate to use VLANs or a filtering method. This provides an additional tool to direct traffic flow without relying on the Master CPU.

Edit the Traffic Segmentation for each port with the Edit menu (below).

Click the selection button on the far left that corresponds to the port you want to configure and click the Edit button. This will open the following dialog box:

Traffic Segmentation Table	
<input type="button" value="Edit"/>	
Port	Port List 1 to 8 9 to 16 17 to 24 25 26
<input type="radio"/> 1	Unit 1 ***** -----* * *
<input type="radio"/> 2	Unit 1 ***** -----* * *
<input type="radio"/> 3	Unit 1 ***** -----* * *
<input type="radio"/> 4	Unit 1 ***** -----* * *
<input type="radio"/> 5	Unit 1 ***** -----* * *
<input type="radio"/> 6	Unit 1 ***** -----* * *
<input type="radio"/> 7	Unit 1 ***** -----* * *
<input type="radio"/> 8	Unit 1 ***** -----* * *
<input type="radio"/> 9	Unit 1 ***** -----* * *
<input type="radio"/> 10	Unit 1 ***** -----* * *
<input type="radio"/> 11	Unit 1 ***** -----* * *
<input type="radio"/> 12	Unit 1 ***** -----* * *
<input type="radio"/> 13	Unit 1 ***** -----* * *
<input type="radio"/> 14	Unit 1 ***** -----* * *
<input type="radio"/> 15	Unit 1 ***** -----* * *
<input type="radio"/> 16	Unit 1 ***** -----* * *
<input type="radio"/> 17	Unit 1 ***** -----* * *
<input type="radio"/> 18	Unit 1 ***** -----* * *
<input type="radio"/> 19	Unit 1 ***** -----* * *
<input type="radio"/> 20	Unit 1 ***** -----* * *
<input type="radio"/> 21	Unit 1 ***** -----* * *
<input type="radio"/> 22	Unit 1 ***** -----* * *
<input type="radio"/> 23	Unit 1 ***** -----* * *
<input type="radio"/> 24	Unit 1 ***** -----* * *
<input type="radio"/> 25	Unit 1 ***** -----* * *
<input type="radio"/> 26	Unit 1 ***** -----* * *

Traffic Segmentation Table - Edit	
Unit	1
Port	3
Port List	1 2 3 4 5 6 7 8 9 10 11 12 13 14 15 16 17 18 19 20 21 22 23 24 25 26
	<input checked="" type="checkbox"/> <input checked="" type="checkbox"/> <input checked="" type="checkbox"/> <input checked="" type="checkbox"/> <input checked="" type="checkbox"/> <input checked="" type="checkbox"/> <input checked="" type="checkbox"/> <input checked="" type="checkbox"/> <input checked="" type="checkbox"/> <input checked="" type="checkbox"/> <input checked="" type="checkbox"/> <input checked="" type="checkbox"/> <input checked="" type="checkbox"/> <input checked="" type="checkbox"/> <input checked="" type="checkbox"/> <input checked="" type="checkbox"/> <input checked="" type="checkbox"/> <input checked="" type="checkbox"/> <input checked="" type="checkbox"/> <input checked="" type="checkbox"/> <input checked="" type="checkbox"/> <input checked="" type="checkbox"/> <input checked="" type="checkbox"/> <input checked="" type="checkbox"/>
<input type="button" value="Back"/> <input type="button" value="Apply"/>	

Figure 5- 7. Traffic Segmentation – Edit

In the Edit menu, select the Forward Ports for the specified port. A Forward Port is a port that is allowed to receive transmissions for the specified port.

Traffic segmentation settings are applied to each Switch individually. There is no traffic segmentation between Switches in a stacked group. Although the same effect can be achieved using other mechanisms such as filtering or VLANs.

Figure 5- 8. Traffic Segmentation Table

To configure Traffic Segmentation for a port, select the ports from the Port List that are allowed to receive forwarded frames from the port that is being configured. Click the **Apply** button to add the ports to the forward list.

# Link Aggregation

## ***Configure Link Aggregation***

Link aggregation allows several ports to be grouped together and to act as a single link. This gives a bandwidth that is a multiple of a single link's bandwidth.

Link aggregation is most commonly used to link a bandwidth intensive network device or devices – such as a server – to the backbone of a network.

The switch allows the creation of up to 6 link aggregation groups, each group consisting of up to 8 links (ports). The aggregated links must be contiguous (they must have sequential port numbers) except the two (optional) Gigabit ports – which can only belong to a single link aggregation group. A link aggregation group may not cross an 8-port boundary, starting with port 1 (a group may not contain ports 8 and 9, for example) and all of the ports in the group must be members of the same VLAN. Further, the aggregated links must all be of the same speed and should be configured as full-duplex.

The configuration of the lowest numbered port in the group becomes the configuration for all of the ports in the aggregation group. This port is called the Master Port of the group, and all configuration options – including the VLAN configuration – that can be applied to the Master Port are applied to the entire link aggregation group.

Load balancing is automatically applied to the ports in the aggregated group, and a link failure within the group causes the network traffic to be directed to the remaining links in the group.

The Spanning Tree Protocol will treat a link aggregation group as a single link, on the switch level. On the port level, the STP will use the port parameters of the Master Port in the calculation of port cost and in determining the state of the link aggregation group. If two redundant link aggregation groups are configured on the switch, STP will block one entire group – the same way the Spanning Tree Protocol will block a single port that has a redundant link.

## Configure Link Aggregation

The Switch supports Link Aggregation Control Protocol and allows for a choice of the Link Aggregation Algorithm. The links to the menus used to set it up are located in the **Link Aggregation** subdirectory, in the **Advanced Settings** folder. Use the **Link Aggregation Algorithm** menu to instruct the Switch on what criteria is used to implement address-based load sharing. Use the **Link Aggregation** menu to set up the ports used for the link.

### Choose the Link Aggregation Algorithm

The Link Aggregation Algorithm is used to determine how load balancing is handled for an aggregated link. It is possible to configure which portion of data packets are examined in order to determine which port is used to transmit load-sharing data. This feature is only available using the address-based load-sharing algorithm.

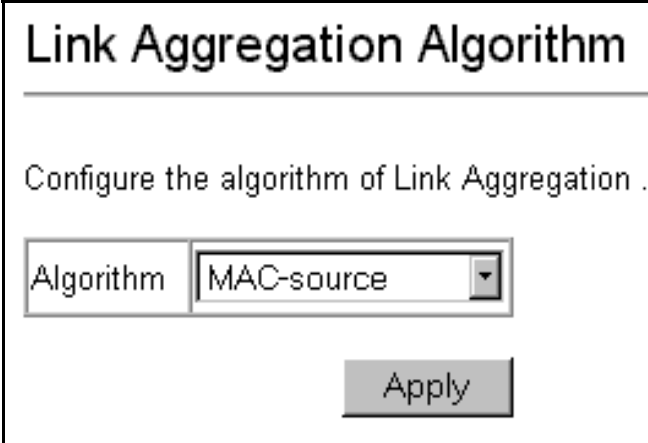

**Figure 6- 1. Link Aggregation Algorithm – Selection**

Select the packet examination criteria and click on the Apply button to make the change effective. The parameters used to instruct the Switch are described in the table below.

Parameter	Description
<b>Mac_source</b>	Indicates that the switch should examine the MAC source address.
<b>Mac_destination</b>	Indicates that the switch should examine the MAC destination address.
<b>Mac_source_dest</b>	Indicates that the switch should examine the MAC source and destination addresses.
<b>IP_source</b>	Indicates that the switch should examine the IP source address.
<b>IP_destination</b>	Indicates that the switch should examine the IP destination address.
<b>IP_source_dest</b>	Indicates that the switch should examine the IP source and destination addresses.

### Configure the Link Aggregation Groups

Follow the instructions below to set up Link Aggregation on the Switch.

*To configure a link aggregation group, click on the Link Aggregation link from the Advanced Setup folder:*

Link Aggregation							
Group several ports together so that they can act as a single port.							
<input type="button" value="New"/> <input type="button" value="Edit"/> <input type="button" value="Delete"/>							
	Group ID	Type	Master Port	Port Members	Active Members	Status	Flooding Port
				1 to 8 9 to 16 17 to 24 25 26	1 to 8 9 to 16 17 to 24 25 26		
<input type="radio"/>	1	LACP	Port 11	-----*****----- - -	----- - - - - - - - - - -	Enabled	-
<input type="radio"/>	2	LACP	Port 1	*-----***** *----- - -	----- - - - - - - - - - -	Enabled	-

**Figure 6- 2. Link Aggregation**

Any Link Aggregation groups configured will appear listed in the table. To remove a group, select the group from the table and click on the **Delete** button.

*To create a new Link Aggregation group, click the New button:*

Link Aggregation																																																					
Group ID	<input type="text" value="1"/>																																																				
Type	<input type="text" value="LACP"/>																																																				
Master Port	Unit: <input type="text" value="1"/> Port: <input type="text" value="1"/>																																																				
Status	<input type="text" value="Enabled"/>																																																				
Unit	<input type="text" value="1"/>																																																				
Port Member	<table border="0"> <tr> <td>1</td><td>2</td><td>3</td><td>4</td><td>5</td><td>6</td><td>7</td><td>8</td><td>9</td><td>10</td><td>11</td><td>12</td><td>13</td><td>14</td><td>15</td><td>16</td><td>17</td><td>18</td><td>19</td><td>20</td><td>21</td><td>22</td><td>23</td><td>24</td><td>25</td><td>26</td> </tr> <tr> <td><input type="checkbox"/></td><td><input type="checkbox"/></td><td><input type="checkbox"/></td><td><input type="checkbox"/></td><td><input type="checkbox"/></td><td><input type="checkbox"/></td><td><input type="checkbox"/></td><td><input type="checkbox"/></td><td><input type="checkbox"/></td><td><input type="checkbox"/></td><td><input type="checkbox"/></td><td><input type="checkbox"/></td><td><input type="checkbox"/></td><td><input type="checkbox"/></td><td><input type="checkbox"/></td><td><input type="checkbox"/></td><td><input type="checkbox"/></td><td><input type="checkbox"/></td><td><input type="checkbox"/></td><td><input type="checkbox"/></td><td><input type="checkbox"/></td><td><input type="checkbox"/></td><td><input type="checkbox"/></td><td><input type="checkbox"/></td><td><input type="checkbox"/></td><td><input type="checkbox"/></td> </tr> </table>	1	2	3	4	5	6	7	8	9	10	11	12	13	14	15	16	17	18	19	20	21	22	23	24	25	26	<input type="checkbox"/>	<input type="checkbox"/>	<input type="checkbox"/>	<input type="checkbox"/>	<input type="checkbox"/>	<input type="checkbox"/>	<input type="checkbox"/>	<input type="checkbox"/>	<input type="checkbox"/>	<input type="checkbox"/>	<input type="checkbox"/>	<input type="checkbox"/>	<input type="checkbox"/>	<input type="checkbox"/>	<input type="checkbox"/>	<input type="checkbox"/>	<input type="checkbox"/>	<input type="checkbox"/>	<input type="checkbox"/>	<input type="checkbox"/>	<input type="checkbox"/>	<input type="checkbox"/>	<input type="checkbox"/>	<input type="checkbox"/>	<input type="checkbox"/>	<input type="checkbox"/>
1	2	3	4	5	6	7	8	9	10	11	12	13	14	15	16	17	18	19	20	21	22	23	24	25	26																												
<input type="checkbox"/>	<input type="checkbox"/>	<input type="checkbox"/>	<input type="checkbox"/>	<input type="checkbox"/>	<input type="checkbox"/>	<input type="checkbox"/>	<input type="checkbox"/>	<input type="checkbox"/>	<input type="checkbox"/>	<input type="checkbox"/>	<input type="checkbox"/>	<input type="checkbox"/>	<input type="checkbox"/>	<input type="checkbox"/>	<input type="checkbox"/>	<input type="checkbox"/>	<input type="checkbox"/>	<input type="checkbox"/>	<input type="checkbox"/>	<input type="checkbox"/>	<input type="checkbox"/>	<input type="checkbox"/>	<input type="checkbox"/>	<input type="checkbox"/>	<input type="checkbox"/>																												
<input type="button" value="Back"/> <span style="float: right;"><input type="button" value="Apply"/></span>																																																					

**Figure 6- 3. Link Aggregation – New**

Click to select the ports in the group. Up to six ports may be selected for each group. Configure the parameters for the group and click on the **Apply** button to create the group. See the table below for a description of the parameters used for the Link Aggregation group.

To change an existing entry, select the group you want to configure and then click the **Edit** button:

Link Aggregation																																																					
Group ID	1																																																				
Type	LACP																																																				
Master Port	Unit: 1 Port: 2																																																				
Status	Enabled																																																				
Unit	1																																																				
Port Member	<table border="1"> <tr> <td>1</td><td>2</td><td>3</td><td>4</td><td>5</td><td>6</td><td>7</td><td>8</td><td>9</td><td>10</td><td>11</td><td>12</td><td>13</td><td>14</td><td>15</td><td>16</td><td>17</td><td>18</td><td>19</td><td>20</td><td>21</td><td>22</td><td>23</td><td>24</td><td>25</td><td>26</td> </tr> <tr> <td><input checked="" type="checkbox"/></td><td><input checked="" type="checkbox"/></td><td><input type="checkbox"/></td><td><input type="checkbox"/></td><td><input type="checkbox"/></td><td><input type="checkbox"/></td><td><input type="checkbox"/></td><td><input type="checkbox"/></td><td><input type="checkbox"/></td><td><input type="checkbox"/></td><td><input type="checkbox"/></td><td><input type="checkbox"/></td><td><input type="checkbox"/></td><td><input type="checkbox"/></td><td><input type="checkbox"/></td><td><input type="checkbox"/></td><td><input type="checkbox"/></td><td><input type="checkbox"/></td><td><input type="checkbox"/></td><td><input type="checkbox"/></td><td><input checked="" type="checkbox"/></td><td><input checked="" type="checkbox"/></td><td><input type="checkbox"/></td><td><input type="checkbox"/></td><td><input type="checkbox"/></td><td><input type="checkbox"/></td> </tr> </table>	1	2	3	4	5	6	7	8	9	10	11	12	13	14	15	16	17	18	19	20	21	22	23	24	25	26	<input checked="" type="checkbox"/>	<input checked="" type="checkbox"/>	<input type="checkbox"/>	<input type="checkbox"/>	<input type="checkbox"/>	<input type="checkbox"/>	<input type="checkbox"/>	<input type="checkbox"/>	<input type="checkbox"/>	<input type="checkbox"/>	<input type="checkbox"/>	<input type="checkbox"/>	<input type="checkbox"/>	<input type="checkbox"/>	<input type="checkbox"/>	<input type="checkbox"/>	<input type="checkbox"/>	<input type="checkbox"/>	<input type="checkbox"/>	<input type="checkbox"/>	<input checked="" type="checkbox"/>	<input checked="" type="checkbox"/>	<input type="checkbox"/>	<input type="checkbox"/>	<input type="checkbox"/>	<input type="checkbox"/>
1	2	3	4	5	6	7	8	9	10	11	12	13	14	15	16	17	18	19	20	21	22	23	24	25	26																												
<input checked="" type="checkbox"/>	<input checked="" type="checkbox"/>	<input type="checkbox"/>	<input type="checkbox"/>	<input type="checkbox"/>	<input type="checkbox"/>	<input type="checkbox"/>	<input type="checkbox"/>	<input type="checkbox"/>	<input type="checkbox"/>	<input type="checkbox"/>	<input type="checkbox"/>	<input type="checkbox"/>	<input type="checkbox"/>	<input type="checkbox"/>	<input type="checkbox"/>	<input type="checkbox"/>	<input type="checkbox"/>	<input type="checkbox"/>	<input type="checkbox"/>	<input checked="" type="checkbox"/>	<input checked="" type="checkbox"/>	<input type="checkbox"/>	<input type="checkbox"/>	<input type="checkbox"/>	<input type="checkbox"/>																												
<div style="display: flex; justify-content: space-between;"> <span>Back</span> <span>Apply</span> </div>																																																					

**Figure 6- 4. Link Aggregation – Edit**

Click to select the new ports in the group. To remove a port from the group, click the Port Member selection box so the check disappears. Up to six ports may be selected for each group. Ports that are not available for link aggregation have their selection box shaded. Configure the available parameters for the group and click on the **Apply** button to make the changes to the group. See the table below for a description of the parameters used for the Link Aggregation group. The Type and Group ID can be changed for an existing group.

The following fields can be configured for Link Aggregation:

Parameter	Description
<b>Group ID</b>	Allows the entry of a number used to identify the link aggregation group – when adding a new group. Displays the Group ID of the currently selected link aggregation group – when editing and existing entry.
<b>Type</b>	Select the type of link aggregation used for the group. If type is not specified the default type is Static. Aggregated ports may be either <i>LACP</i> or <i>Static</i> . LACP indicates the port group as LACP compliant so they can be connected to an LACP compliant device. Static trunk groups are not able to adjust dynamically and both devices connected to the static trunk group must be manually configured if the composition of the group is changed.
<b>Master Port &lt;1&gt;</b>	The Master port of link aggregation group.
<b>Unit</b>	Allows the selection of a particular switch in a switch stack, if you have the optional stacking module installed and have properly interconnected the switches in the switch stack.
<b>Port Member</b>	Allows the specification of the ports that will make up the link aggregation group.
<b>Status &lt;Disabled&gt;</b>	This field can be toggled between <i>Enabled</i> and <i>Disabled</i> . This is used to turn a link aggregation group on or off. This is useful for diagnostics, to quickly isolate a bandwidth intensive network device or to have an absolute backup link aggregation group that is not under automatic control.



## Chapter 7

### Port Mirroring

The Switch allows you to copy frames transmitted and received on a port and redirect the copies to another port. You can attach a monitoring device to the mirrored port, such as a sniffer or an RMON probe, to view details about the packets passing through the first port.

**To configure a port for port mirroring:**

Click the **Mirroring Configurations** link in the **Advanced Settings** folder to see the menu below.

#### Mirroring Configurations

Configure ports so that their traffic can be analyzed on the target port which has an analyzer attached.

Mirror Status: Disabled

Target Port Unit: 1 Port: 1

Unit	1	2	3	4	5	6	7	8	9	10	11	12	13	14	15	16	17	18	19	20	21	22	23	24	25	26
Mirrored Port																										
None	<input checked="" type="radio"/>	<input checked="" type="radio"/>	<input checked="" type="radio"/>	<input checked="" type="radio"/>	<input checked="" type="radio"/>	<input checked="" type="radio"/>	<input checked="" type="radio"/>	<input checked="" type="radio"/>	<input checked="" type="radio"/>	<input checked="" type="radio"/>	<input checked="" type="radio"/>	<input checked="" type="radio"/>	<input checked="" type="radio"/>	<input checked="" type="radio"/>	<input checked="" type="radio"/>	<input checked="" type="radio"/>	<input checked="" type="radio"/>	<input checked="" type="radio"/>	<input checked="" type="radio"/>	<input checked="" type="radio"/>	<input checked="" type="radio"/>	<input checked="" type="radio"/>	<input checked="" type="radio"/>	<input checked="" type="radio"/>	<input checked="" type="radio"/>	
Rx	<input type="radio"/>	<input type="radio"/>	<input type="radio"/>	<input type="radio"/>	<input type="radio"/>	<input type="radio"/>	<input type="radio"/>	<input type="radio"/>	<input type="radio"/>	<input type="radio"/>	<input type="radio"/>	<input type="radio"/>	<input type="radio"/>	<input type="radio"/>	<input type="radio"/>	<input type="radio"/>	<input type="radio"/>	<input type="radio"/>	<input type="radio"/>	<input type="radio"/>	<input type="radio"/>	<input type="radio"/>	<input type="radio"/>	<input type="radio"/>	<input type="radio"/>	
Tx	<input type="radio"/>	<input type="radio"/>	<input type="radio"/>	<input type="radio"/>	<input type="radio"/>	<input type="radio"/>	<input type="radio"/>	<input type="radio"/>	<input type="radio"/>	<input type="radio"/>	<input type="radio"/>	<input type="radio"/>	<input type="radio"/>	<input type="radio"/>	<input type="radio"/>	<input type="radio"/>	<input type="radio"/>	<input type="radio"/>	<input type="radio"/>	<input type="radio"/>	<input type="radio"/>	<input type="radio"/>	<input type="radio"/>	<input type="radio"/>	<input type="radio"/>	
Both	<input type="radio"/>	<input type="radio"/>	<input type="radio"/>	<input type="radio"/>	<input type="radio"/>	<input type="radio"/>	<input type="radio"/>	<input type="radio"/>	<input type="radio"/>	<input type="radio"/>	<input type="radio"/>	<input type="radio"/>	<input type="radio"/>	<input type="radio"/>	<input type="radio"/>	<input type="radio"/>	<input type="radio"/>	<input type="radio"/>	<input type="radio"/>	<input type="radio"/>	<input type="radio"/>	<input type="radio"/>	<input type="radio"/>	<input type="radio"/>	<input type="radio"/>	

Apply

**Figure 7- 1. Target Port Selection**

The target port is the port where information will be duplicated and sent for capture and network analysis. This is the port where a network analyzer would be attached to capture packets duplicated from the source port.

Up to 25 entries can be made to the port mirroring table, but it should be noted that a faster port (a 1000 Mbps Gigabit Ethernet port, for example) should not be mirrored to a slower port (one of the 24 100 Mbps Fast Ethernet port), because many packets will be dropped.

The following fields can be set:

Parameter	Description
Source Port	Allows the entry of the port number of the port to be mirrored. This port is the source of the packets to be duplicated and forwarded to the Target port.
Direction <Ingress>	This field can be toggled between <i>Either</i> , <i>Ingress</i> and <i>Egress</i> . <i>Ingress</i> mirrors only received packets, while <i>Egress</i> mirrors only transmitted packets.



**NOTE:** You cannot mirror a fast port onto a slower port. For example, if you try to mirror the traffic from a 100 Mbps port onto a 10 Mbps port, this can cause throughput problems. The port you are copying frames from should always support an equal or lower speed than the port to which you are sending the copies. Also note, the target port for the mirroring cannot be a member of a trunk group.

## Chapter 8

# MAC Forwarding

**Static Unicast Forwarding**

**Static Multicast Forwarding**

**Broadcast/Multicast Storm Control**

The Switch allows permanent or static entries into the forwarding database (FDB). These FDB entries are MAC addresses that will not age out. The menu links for **MAC Forwarding** configuration are found in a separate subdirectory in the **Forwarding** subdirectory in the **Advanced Setup** folder.

## MAC Address Aging Time

The **MAC Address Aging Time** specifies the length of time a learned MAC Address will remain in the forwarding table without being accessed (that is, how long a learned MAC Address is allowed to remain idle). The Aging Time can be set to any value between **10** and **1,000,000** seconds.

*To configure the MAC Address Aging Time, click on the Forwarding folder and then the MAC Forwarding folder, then click on the MAC Address Aging Time link:*

### MAC Address Aging Time

---

Set the time limit for how long a learned MAC address can remain in the table without being accessed.

MAC Address Aging Time ( 10 - 1000000 sec )

**Figure 8- 1. MAC Address Aging Time**

## Unicast MAC Address Forwarding

MAC addresses can be statically entered into the switch's MAC Address Forwarding Table. These addresses will never age out.

*To enter a MAC address into the switch's forwarding table, click on the Forwarding folder and then the MAC Forwarding folder and then click the Unicast MAC Address Setting:*

### Unicast MAC Address Settings

---

Configure how specific unicast MAC addresses are forwarded.

Total Entries: 1

	MAC Address	VLAN Name	Unit	Port	Type
C	aa-bb-cc-dd-ee-ff	default	1	1	Static

**Figure 8- 2. Unicast MAC Address Settings**

To add a new MAC address to the MAC Address Forwarding Table, click the New button:

Unicast MAC Address Settings - Add	
MAC Address	<input type="text"/>
VLAN Name	<input type="text"/>
Type	Static
Unit	1
Port	1
<input type="button" value="Back"/> <input type="button" value="Apply"/>	

Figure 8- 3. Unicast MAC Address Settings – Add

To edit an existing entry in the MAC address in the MAC Address Forwarding Table, click the Edit button:

Unicast MAC Address Settings - Edit	
MAC Address	aa-bb-cc-dd-ee-ff
VLAN Name	default
Type	Static
Unit	1
Port	1
<input type="button" value="Back"/> <input type="button" value="Apply"/>	

Figure 8- 4. Unicast MAC Address Settings – Edit

The following fields can be set:

Parameter	Description
<b>MAC Address</b>	Allows the entry of the MAC address of an end station that will be entered into the switch's static forwarding table when adding a new entry. Displays the currently selected MAC address when editing.
<b>VLAN Name</b>	Allows the entry of the VLAN Name of the VLAN the MAC address below is a member of – when editing. Displays the VLAN the currently selected MAC address is a member of – when editing an existing entry.
<b>Unit</b>	Allows the selection of a given switch from a switch stack – if you have the optional stacking module installed and have properly interconnected the switches in a switch stack.
<b>Port</b>	Allows the entry of the port number on which the MAC address entered above resides.

## Multicast MAC Address Forwarding

Multicast MAC addresses can be statically entered into the switch's MAC Address Forwarding Table. These addresses will never age out.

*To enter a Multicast MAC address into the switch's forwarding table, click on the Forwarding folder and then the MAC Forwarding folder and then click on the Multicast MAC Address Settings link:*

Multicast MAC Address Settings

Configure how specific multicast MAC addresses are forwarded.

Total Entries: 1

	MAC Address	VLAN Name	Port Map	
			1 to 8	9 to 16
<input type="checkbox"/>	01-00-5e-ff-dd-cc	default	Unit 1	-----

**Figure 8- 5. Multicast MAC Address Settings**

*To add a new multicast MAC address to the switch's forwarding table, click the New button:*

Multicast MAC Address Settings - Add

MAC Address

VLAN Name

Unit

State

Port	1	2	3	4	5	6	7	8	9	10	11	12	13	14	15	16	17	18	19	20	21	22	23	24	25	26
None	<input checked="" type="radio"/>	<input checked="" type="radio"/>	<input checked="" type="radio"/>	<input checked="" type="radio"/>	<input checked="" type="radio"/>	<input checked="" type="radio"/>	<input checked="" type="radio"/>	<input checked="" type="radio"/>	<input checked="" type="radio"/>	<input checked="" type="radio"/>	<input checked="" type="radio"/>	<input checked="" type="radio"/>	<input checked="" type="radio"/>	<input checked="" type="radio"/>	<input checked="" type="radio"/>	<input checked="" type="radio"/>	<input checked="" type="radio"/>	<input checked="" type="radio"/>	<input checked="" type="radio"/>	<input checked="" type="radio"/>	<input checked="" type="radio"/>	<input checked="" type="radio"/>	<input checked="" type="radio"/>	<input checked="" type="radio"/>	<input checked="" type="radio"/>	
Egress	<input type="radio"/>	<input type="radio"/>	<input type="radio"/>	<input type="radio"/>	<input type="radio"/>	<input type="radio"/>	<input type="radio"/>	<input type="radio"/>	<input type="radio"/>	<input type="radio"/>	<input type="radio"/>	<input type="radio"/>	<input type="radio"/>	<input type="radio"/>	<input type="radio"/>	<input type="radio"/>	<input type="radio"/>	<input type="radio"/>	<input type="radio"/>	<input type="radio"/>	<input type="radio"/>	<input type="radio"/>	<input type="radio"/>	<input type="radio"/>	<input type="radio"/>	
Forbidden	<input type="radio"/>	<input type="radio"/>	<input type="radio"/>	<input type="radio"/>	<input type="radio"/>	<input type="radio"/>	<input type="radio"/>	<input type="radio"/>	<input type="radio"/>	<input type="radio"/>	<input type="radio"/>	<input type="radio"/>	<input type="radio"/>	<input type="radio"/>	<input type="radio"/>	<input type="radio"/>	<input type="radio"/>	<input type="radio"/>	<input type="radio"/>	<input type="radio"/>	<input type="radio"/>	<input type="radio"/>	<input type="radio"/>	<input type="radio"/>	<input type="radio"/>	

**Figure 8- 6. Multicast MAC Address Settings – Add**

*To edit an existing entry to the switch's forwarding table, click the entry's corresponding click-box and then click the edit button:*

Multicast MAC Address Settings - Edit

MAC Address

VLAN Name

Unit

State

Port	1	2	3	4	5	6	7	8	9	10	11	12	13	14	15	16	17	18	19	20	21	22	23	24	25	26
None	<input checked="" type="radio"/>	<input checked="" type="radio"/>	<input checked="" type="radio"/>	<input checked="" type="radio"/>	<input checked="" type="radio"/>	<input checked="" type="radio"/>	<input checked="" type="radio"/>	<input checked="" type="radio"/>	<input checked="" type="radio"/>	<input checked="" type="radio"/>	<input checked="" type="radio"/>	<input checked="" type="radio"/>	<input checked="" type="radio"/>	<input checked="" type="radio"/>	<input checked="" type="radio"/>	<input checked="" type="radio"/>	<input checked="" type="radio"/>	<input checked="" type="radio"/>	<input checked="" type="radio"/>	<input checked="" type="radio"/>	<input checked="" type="radio"/>	<input checked="" type="radio"/>	<input checked="" type="radio"/>	<input checked="" type="radio"/>	<input checked="" type="radio"/>	
Egress	<input type="radio"/>	<input type="radio"/>	<input type="radio"/>	<input type="radio"/>	<input type="radio"/>	<input type="radio"/>	<input type="radio"/>	<input type="radio"/>	<input type="radio"/>	<input type="radio"/>	<input type="radio"/>	<input type="radio"/>	<input type="radio"/>	<input type="radio"/>	<input type="radio"/>	<input type="radio"/>	<input type="radio"/>	<input type="radio"/>	<input type="radio"/>	<input type="radio"/>	<input type="radio"/>	<input type="radio"/>	<input type="radio"/>	<input type="radio"/>	<input type="radio"/>	
Forbidden	<input type="radio"/>	<input type="radio"/>	<input type="radio"/>	<input type="radio"/>	<input type="radio"/>	<input type="radio"/>	<input type="radio"/>	<input type="radio"/>	<input type="radio"/>	<input type="radio"/>	<input type="radio"/>	<input type="radio"/>	<input type="radio"/>	<input type="radio"/>	<input type="radio"/>	<input type="radio"/>	<input type="radio"/>	<input type="radio"/>	<input type="radio"/>	<input type="radio"/>	<input type="radio"/>	<input type="radio"/>	<input type="radio"/>	<input type="radio"/>	<input type="radio"/>	

**Figure 8- 7. Multicast MAC Address Settings – Edit**

The following fields can be set:

Parameter	Description
<b>MAC Address:</b> [ ]	Allows the entry of the MAC address of an end station that will be entered into the switch's static forwarding table.
<b>VLAN Name</b>	Allows the entry of the VLAN name of the VLAN the MAC address below is a member of – when adding a new entry to the table. Displays the VLAN name of the VLAN the MAC address is a member of – when editing an existing entry.
<b>Port:</b> [ ]	Allows the entry of the port number on which the MAC address entered above resides.
<b>None</b>	Specifies the port as being none.
<b>Egress</b>	Specifies the port as being a source of multicast packets originating from the MAC address specified above.
<b>Forbidden</b>	Forbidden Non-Member - specifies the port as not being a member of the VLAN and that the port is forbidden from becoming a member of the VLAN dynamically.

## Broadcast/Multicast Storm Control

Broadcast and Multicast storms consist of broadcast or multicast packets that flood and/or are looped on a network causing noticeable performance degradation and, in extreme cases, network failure.

The DES-3326S allows some control over broadcast/multicast storms by setting thresholds on the number of broadcast/multicast packets received (in thousands of packets per second or Kpps), and then following a user-specified course of action when this threshold is exceeded.

### To configure Broadcast/Multicast storm control:

Click on the **Forwarding** folder, and then on the **MAC Forwarding** folder, and finally on the **Broadcast/Multicast Storm Control** link:

**Broadcast/Multicast Storm Control**

Configure thresholds for triggering storm control for broadcast and multicast packets.

Unit

	Upper Threshold (Kpps)	Broadcast Storm Mode	Multicast Storm Mode	Destination Lookup Fail
<b>Group 1 [1-8]</b>	<input type="text" value="128"/>	Disabled ▾	Disabled ▾	Disabled ▾
<b>Group 2 [9-16]</b>	<input type="text" value="128"/>	Disabled ▾	Disabled ▾	Disabled ▾
<b>Group 3 [17-24]</b>	<input type="text" value="128"/>	Disabled ▾	Disabled ▾	Disabled ▾
<b>Group 4 [25]</b>	<input type="text" value="128"/>	Disabled ▾	Disabled ▾	Disabled ▾
<b>Group 5 [26]</b>	<input type="text" value="128"/>	Disabled ▾	Disabled ▾	Disabled ▾

**Figure 8- 8. Broadcast/Multicast Storm Control**

Broadcast/Multicast storm control is applied to groups of ports on the DES-3326S. **Group 1** contains ports 1 through 8. **Group 2** contains ports 9 through 16. **Group 3** contains ports 17 through 24. **Group 4** and **Group 5** contain the ports on the optional plug-in module.

The **Upper Threshold (Kpps)** sets the rate of broadcast or multicast packets received on any of the ports in the corresponding port group that will trigger the action to be taken by the switch, as detailed below. A range of thousands of packets received per second (Kpps) between 0 and 255 can be specified.

When any one of the ports contained within a given port group receives more broadcast or multicast packets per second than is specified in the **Upper Threshold (Kpps)** field, the switch will take the actions specified in the **Broadcast Storm Mode**, **Multicast Storm Mode**, and the **Destination Lookup Fail** pull-down menus.

The **Broadcast Storm Mode** is **Enabled** or **Disabled** using the pull-down menu for the corresponding port group. When the **Broadcast Storm Mode** is enabled, and a port contained within the corresponding port group receives more broadcast packets

than specified in the **Upper Threshold (Kpps)** field, the switch will drop all broadcast packets received by any port in the port group until the rate of broadcast packets received by the port group falls.

The **Multicast Storm Mode** is **Enabled** or **Disabled** using the pull-down menu for the corresponding port group. When the **Multicast Storm Mode** is enabled, and a port contained within the corresponding port group receives more multicast packets than specified in the **Upper Threshold (Kpps)** field, the switch will drop all multicast packets received by any port in the port group until the rate of multicast packets received by the port group falls.

The **Destination Lookup Fail** is **Enabled** or **Disabled** using the pull-down menu for the corresponding port group. When the **Destination Lookup Fail** is enabled, and a port contained within the corresponding port group receives more destination lookup failed packets than specified in the **Upper Threshold (Kpps)** field, the switch will drop all destination lookup failed packets received by any port in the port group until the rate of destination lookup failed packets received by the port group falls.

# Spanning Tree Protocol

## 802.1w Rapid Spanning Tree Configure STP

The Switch supports 802.1d Spanning Tree Protocol (STP) and 802.1w Rapid Spanning Tree Protocol (RSTP). 802.1d STP will be familiar to most networking professionals. However, since 802.1w RSTP has been recently introduced to D-Link managed Ethernet Switches, a brief introduction to the technology is provided below followed by a description of how to set up 802.1d STP and 802.1w RSTP.

## 802.1w Rapid Spanning Tree

The Switch implements two versions of the Spanning Tree Protocol, the Rapid Spanning Tree Protocol (RSTP) as defined by the IEEE 802.1w specification and a version compatible with the IEEE 802.1d STP. RSTP can operate with legacy equipment implementing IEEE 802.1d, however the advantages of using RSTP will be lost.

The IEEE 802.1w Rapid Spanning Tree Protocol (RSTP) evolved from the 802.1d STP standard. RSTP was developed in order to overcome some limitations of STP that impede the function of some recent Switching innovations, in particular, certain Layer 3 function that are increasingly handled by Ethernet Switches. The basic function and much of the terminology is the same as STP. Most of the settings configured for STP are also used for RSTP. This section introduces some new Spanning Tree concepts and illustrates the main differences between the two protocols.

### Port Transition States

An essential difference between the two protocols is in the way ports transition to a forwarding state and the in the way this transition relates to the role of the port (forwarding or not forwarding) in the topology. RSTP combines the transition states disabled, blocking and listening used in 802.1d and creates a single state *Discarding*. In either case, ports do not forward packets; in the STP port transition states disabled, blocking or listening or in the RSTP port state discarding there is no functional difference, the port is not active in the network topology. The Comparing Port States table below compares how the two protocols differ regarding the port state transition.

Both protocols calculate a stable topology in the same way. Every segment will have a single path to the root bridge. All bridges listen for BPDU packets. However, BPDU packets are sent more frequently – with every Hello packet. BPDU packets are sent even if a BPDU packet was not received. Therefore, each link between bridges are sensitive to the status of the link. Ultimately this difference results faster detection of failed links, and thus faster topology adjustment. A drawback of 802.1d is this absence of immediate feedback from adjacent bridges.

**Table 1. Comparing Port States**

802.1d STP	802.1w RSTP	Forwarding?	Learning?
Disabled	Discarding	No	No
Blocking	Discarding	No	No
Listening	Discarding	No	No
Learning	Learning	No	Yes
Forwarding	Forwarding	Yes	Yes

RSTP is capable of more rapid transition to a forwarding state – it no longer relies on timer configurations – RSTP compliant bridges are sensitive to feedback from other RSTP compliant bridge links. Ports do not need to wait for the topology to stabilize before transitioning to a forwarding state. In order to allow this rapid transition, the protocol introduces two new variables: the edge port and the point-to-point (P2P) port.

### Edge Port

The edge port is a configurable designation used for a port that is directly connected to a segment where a loop cannot be created. An example would be a port connected directly to a single workstation. Ports that are designated as edge ports, transition to a forwarding state immediately without going through the listening and learning states. An edge port loses its status if it receives a BPDU packet, immediately becoming a normal spanning tree port.

### P2P Port

A P2P port is also capable of rapid transition. P2P ports may be used to connect to other bridges. Under RSTP, all ports operating in full-duplex mode are considered to be P2P ports, unless manually overridden through configuration.

### 802.1w/802.1d Compatibility

RSTP can interoperate with legacy equipment and is capable of automatically adjusting BPDU packets to 802.1d format when necessary. However, any segment using 802.1 STP will not benefit from the rapid transition and rapid topology change detection of RSTP. The protocol also provides for a variable used for migration in the event that legacy equipment on a segment is updated to use RSTP.

## Configure STP Switch Settings

Spanning Tree Protocol operates on two levels: on the switch level, the settings are globally implemented. On the port level, the settings are implemented on a per user-defined Group of ports basis.

Status	Disabled ▾
Max Age (6 - 40 sec)	20
Hello Time (1 - 10 sec)	2
Forward Delay (4 - 30 sec)	15
Priority (0 - 61440)	32768
STP Version	RSTP ▾
TX Hold Count (1 - 10)	3
Forwarding BPDU	Enabled ▾

Figure 9- 1. STP switch Settings



Configure the following STP Switch parameters and click the **Apply** button to implement them:

Parameter	Description
<b>Status</b> <Disabled>	This field can be toggled between <i>Enabled</i> and <i>Disabled</i> using the pull-down menu. This will enable or disable the Spanning Tree Protocol (STP), globally, for the switch.
<b>Max Age: (6 - 40 sec)</b> <20 >	The Max. Age can be set from 6 to 40 seconds. At the end of the Max. Age, if a BPDU has still not been received from the Root Bridge, your switch will start sending its own BPDU to all other switches for permission to become the Root Bridge. If it turns out that your switch has the lowest Bridge Identifier, it will become the Root Bridge.
<b>Hello Time: (1 - 10 sec)</b> < 2 >	The Hello Time can be set from 1 to 10 seconds. This is the interval between two transmissions of BPDU packets sent by the Root Bridge to tell all other switches that it is indeed the Root Bridge.
<b>Forward Delay: (4 - 30 sec)</b> <15 >	The Forward Delay can be from 4 to 30 seconds. This is the time any port on the switch spends in the listening state while moving from the blocking state to the forwarding state.
<b>Priority: (0 - 61440)</b> <32768>	A Priority for the switch can be set from 0 to 61440. This number is used in the voting process between switches on the network to determine which switch will be the root switch. A low number indicates a high priority, and a high probability that this switch will be elected as the root switch.
<b>STP Version</b> <RSTP >	Choose RSTP (default) or STP Compatibility. Both versions use STP parameters in the same way. RSTP is fully compatible with IEEE 802.1d STP and can function with legacy equipment.
<b>Tx Hold Count</b> <3 >	This is the maximum number of Hello packets transmitted per interval. The count can be specified from 1 to 10. The default value = 3.
<b>Forwarding BPDU</b> <Enabled >	This can enabled or disabled. When it is enabled it allows the forwarding of STP BPDU packets from other network devices when STP is disabled on the switch. The default is enabled.



**NOTE:** The Hello Time cannot be longer than the Max. Age. Otherwise, a configuration error will occur.

**Observe the following formulas when setting the above parameters:**

$$\text{Max. Age} \leq 2 \times (\text{Forward Delay} - 1 \text{ second})$$

$$\text{Max. Age} \geq 2 \times (\text{Hello Time} + 1 \text{ second})$$

## STP Port Settings

In addition to setting Spanning Tree parameters for use on the switch level, the switch allows for the configuration of groups of ports, each port-group of which will have its own spanning tree, and will require some of its own configuration settings. An STP Group will use the switch-level parameters entered above, with the addition of Port Priority and Port Cost.

An STP Group spanning tree works in the same way as the switch-level spanning tree, but the root bridge concept is replaced with a root port concept. A root port is a port of the group elected based on port priority and port cost, to be the connection to the network for the group. Redundant links will be blocked, just as redundant links are blocked on the switch level.

The STP on the switch level blocks redundant links between switches (and similar network devices). The port level STP will block redundant links within an STP Group.

Under most circumstances, an STP Group should correspond to a VLAN group of ports.

For stacked switch installations, first select the Unit to be configured.

STP Port Settings								
<input type="button" value="Edit"/>								
Port	State	Cost	Priority	Edge	P2P	Status	Role	
1	Enabled	*200000	128	No	Yes	Disabled	Disabled	
2	Enabled	*200000	128	No	Yes	Forwarding	NonStp	
3	Enabled	*200000	128	No	Yes	Disabled	Disabled	
4	Enabled	*200000	128	No	Yes	Disabled	Disabled	
5	Enabled	*200000	128	No	Yes	Disabled	Disabled	
6	Enabled	*200000	128	No	Yes	Disabled	Disabled	
7	Enabled	*200000	128	No	Yes	Disabled	Disabled	
8	Enabled	*200000	128	No	Yes	Disabled	Disabled	
9	Enabled	*200000	128	No	Yes	Disabled	Disabled	
10	Enabled	*200000	128	No	Yes	Disabled	Disabled	
11	Enabled	*200000	128	No	Yes	Disabled	Disabled	
12	Enabled	*200000	128	No	Yes	Disabled	Disabled	
13	Enabled	*200000	128	No	Yes	Disabled	Disabled	
14	Enabled	*200000	128	No	Yes	Disabled	Disabled	
15	Enabled	*200000	128	No	Yes	Disabled	Disabled	
16	Enabled	*200000	128	No	Yes	Disabled	Disabled	
17	Enabled	*200000	128	No	Yes	Disabled	Disabled	
18	Enabled	*200000	128	No	Yes	Disabled	Disabled	
19	Enabled	*200000	128	No	Yes	Disabled	Disabled	
20	Enabled	*200000	128	No	Yes	Disabled	Disabled	
21	Enabled	*200000	128	No	Yes	Disabled	Disabled	
22	Enabled	*200000	128	No	Yes	Disabled	Disabled	
23	Enabled	*200000	128	No	Yes	Forwarding	NonStp	
24	Enabled	*200000	128	No	Yes	Forwarding	NonStp	
25	Enabled	*200000	128	No	Yes	Disabled	Disabled	
26	Enabled	*200000	128	No	Yes	Disabled	Disabled	

Figure 9- 3. STP Port Settings

To change STP settings for a port or a group of ports on the same switch, select the first (lowest numbered) port from the list and click the **Edit** button, a separate menu will appear.

### STP Port Settings - Edit

Port	2
State	Enabled
Cost	200000 <input checked="" type="checkbox"/> Auto
Priority	128
Migration	No
Edge	No
P2P	Yes
Configure Ports from 2 to	1

Figure 9- 2. Edit STP Port Settings

The STP (RSTP) parameters in the STP Port Settings menu are described in the table below.

The following fields are configured in the STP Port Settings – Edit menu:

Parameter	Description
<b>Cost</b>	A Port Cost can be set from 1 to 200000000. The lower the number, the greater the probability the port will be chosen to forward packets. Default port cost: 100Mbps port = 200000 Gigabit ports = 20000
<b>Priority &lt;128&gt;</b>	A Port Priority can be from 0 to 240. The lower the number, the greater the probability the port will be chosen as the Root Port.
<b>Migration &lt;No&gt;</b>	Select Yes or No. Choosing Yes will enable the port to migrate from 802.1d STP status to 802.1w RSTP status. RSTP can coexist with standard STP, however the benefits of RSTP are not realized on a port where an 802.1d network connects to an 802.1w enabled network. Migration should be enabled (yes) on ports connected to network stations or segments that will be upgraded to 802.1w RSTP on all or some portion of the segment.
<b>Edge &lt;No&gt;</b>	Select True or False. Choosing true designates the port as an edge port. Edge ports cannot create loops, however an edge port can lose edge port status if a topology change creates a potential for a loop. An edge port normally should not receive BPDU packets. If a BPDU packet is received it automatically loses edge port status. False indicates the port does not have edge port status.
<b>P2P &lt;Yes&gt;</b>	Select True or False. Choosing true indicates a point-to-point (p2p) shared link. These are similar to edge ports however they are restricted in that a p2p port must operate in full-duplex. Like edge ports, p2p ports transition to a forwarding state rapidly thus benefiting from RSTP.
<b>Configure Ports from __ to __</b>	A consecutive groups of ports may be configured starting with the selected port.

## Quality of Service Configuration

### *Configure QoS Output Scheduling*

### *Configure 802.1p User Priority*

### *Configure Default Priority*

### *Configure Bandwidth*

The DES-3326S switch supports 802.1p priority queuing. The switch has 4 priority queues. These priority queues are numbered from 0 (Class 0) — the lowest priority queue — to 3 (Class 3) — the highest priority queue. The eight priority queues specified in IEEE 802.1p (p0 to p7) are mapped to the switch's priority queues as follows:

p1 and p2 are assigned to the switch's Class 0 queue.

p0 and p3 are assigned to the switch's Class 1 queue.

p4 and p5 are assigned to the switch's Class 2 queue.

p6 and p7 are assigned to the switch's Class 3 queue.

Priority scheduling is implemented using two types of methods, strict priority and round-robin priority. If no changes are made to the QoS priority scheduling settings the method used is strict priority.

For strict priority-based scheduling, packets residing in the higher priority queues are transmitted first. Only when these queues are empty, are packets of lower priority allowed to be transmitted. Higher priority packets always receive preference regardless of the amount of lower priority packets in the buffer and regardless of the time elapsed since any lower priority packets have been transmitted. By default the switch is configured to empty the buffer using strict priority.



**NOTICE:** The default QoS scheduling arrangement is a strict priority schedule. To customize scheduling to set up round-robin queue clearing, the MAX. Latency and MAX. Packets values need to be changed.

To use implement round-robin (weighted) priority, the switch's four priority queues can be configured to reduce the buffer in a round-robin fashion - beginning with the highest priority queue, and proceeding to the lowest priority queue before returning to the highest priority queue.

The weighted-priority based scheduling alleviates the main disadvantage of strict priority-based scheduling – in that lower priority queues get starved of bandwidth – by providing a minimum bandwidth to all queues for transmission. This is accomplished by configuring the maximum number of packets allowed to be transmitted from a given priority queue and the maximum amount of time a given priority queue will have to wait before being allowed to transmit its accumulated packets. This establishes a Class of Service (CoS) for each of the switch's four hardware priority queues.

The possible range for maximum packets is: 0 to 255 packets.

The possible range for maximum latency is: 0 to 255 (in increments of 16 microseconds each).

Remember that the DES-3326S has four priority queues (and thus four Classes of Service) for each port on the switch.

To configure QoS settings, open the **Configure QoS** subdirectory in the **Advanced Setup** folder, and then click on the link for the QoS setting you want to configure.

## Configure QoS Output Scheduling

Open the QoS Output Scheduling menu to adjust settings for the four QoS Classes. You may then change the Priority settings mapped to these Classes in the 802.1p User Priority setting menu (see below).

QoS Output Scheduling		
Class	MAX. Packets	MAX. Latency (*16 microseconds)
Class-0	<input type="text" value="0"/>	<input type="text" value="0"/>
Class-1	<input type="text" value="0"/>	<input type="text" value="0"/>
Class-2	<input type="text" value="0"/>	<input type="text" value="0"/>
Class-3	<input type="text" value="0"/>	<input type="text" value="0"/>

**Figure 10- 1. QoS Output Scheduling**

The MAX. Packets field specifies the number of packets that a queue will transmit before surrendering the transmit buffer to the next lower priority queue in a round-robin fashion. The default value of 0 combined with the default MAX. Latency value of 0 will enforce a strict scheduling for output queues. The maximum value for MAX. Packets is 255.

The MAX. Latency field specifies the maximum amount of time—in multiples of 16 microseconds—that a queue will have to wait before being given access to the transmit buffer. The MAX. Latency is a priority queue timer. When it expires, it overrides the round-robin queuing and gives the priority queue that it was set for access to the transmit buffer. The default value of 0 combined with the default MAX. Packets value of 0 will enforce a strict scheduling for output queues. The maximum value for MAX. Latency is 255.

Type in the values desired for scheduling and click on the **Apply** button to make the changes.



**NOTE:** There is a small amount of additional latency introduced because the priority queue that is transmitting at the time the MAX. Latency time expires will finish transmitting its current packet before giving up the transmit buffer.

## Configure 802.1p User Priority

Once you have assigned a maximum number of packets and a maximum latency to a given Class of Service on the switch, you can then assign this Class to each of the 8 levels of 802.1p priorities. Open the 802.1 User Priority configuration menu in the QoS subdirectory to see the menu below.

Priority	Class
Priority-0	Class-1
Priority-1	Class-0
Priority-2	Class-0
Priority-3	Class-1
Priority-4	Class-2
Priority-5	Class-2
Priority-6	Class-3
Priority 7	Class-3

Apply

Figure 10- 2. QoS Class of Traffic

Configure the Class-to-Priority mapping as you wish and click on the **Apply** button to make the change.

## Configure Default Priority

The default 802.1p priority to each port can be changed to suit conditions.

Click on the **802.1p Default Priority** link:

### 802.1p Default Priority

Select priority based on port or disable priority based on per port basis.

Unit

Port	Default Priority	Port	Default Priority
1	<input type="text" value="0"/>	14	<input type="text" value="0"/>
2	<input type="text" value="0"/>	15	<input type="text" value="0"/>
3	<input type="text" value="0"/>	16	<input type="text" value="0"/>
4	<input type="text" value="0"/>	17	<input type="text" value="0"/>
5	<input type="text" value="0"/>	18	<input type="text" value="0"/>
6	<input type="text" value="0"/>	19	<input type="text" value="0"/>
7	<input type="text" value="0"/>	20	<input type="text" value="0"/>
8	<input type="text" value="0"/>	21	<input type="text" value="0"/>
9	<input type="text" value="0"/>	22	<input type="text" value="0"/>
10	<input type="text" value="0"/>	23	<input type="text" value="0"/>
11	<input type="text" value="0"/>	24	<input type="text" value="0"/>
12	<input type="text" value="0"/>	25	<input type="text" value="0"/>
13	<input type="text" value="0"/>	26	<input type="text" value="0"/>

**Figure 10- 3. Priority Based on Port**

This window allows you to assign a default 802.1p priority to any given port on the switch. The priority queues are numbered from 0 – the lowest priority – to 7 – the highest priority.

Choose the priority level for the ports and click on the **Apply** button to make the change.

## Configure Bandwidth Control

The bandwidth control settings are used to place a ceiling on the transmitting and receiving data bit rates for any port.

To change the maximum allowed bandwidth for a given port:

Bandwidth Control Table			
<input type="button" value="Edit"/>			
	Port	RX Rate (MBits)	TX Rate (MBits)
<input type="radio"/>	1	No Limit	No Limit
<input type="radio"/>	2	No Limit	No Limit
<input type="radio"/>	3	No Limit	No Limit
<input type="radio"/>	4	No Limit	No Limit
<input type="radio"/>	5	No Limit	No Limit
<input type="radio"/>	6	No Limit	No Limit
<input type="radio"/>	7	No Limit	No Limit
<input type="radio"/>	8	No Limit	No Limit
<input type="radio"/>	9	No Limit	No Limit
<input type="radio"/>	10	No Limit	No Limit
<input type="radio"/>	11	No Limit	No Limit
<input type="radio"/>	12	No Limit	No Limit
<input type="radio"/>	13	No Limit	No Limit
<input type="radio"/>	14	No Limit	No Limit
<input type="radio"/>	15	No Limit	No Limit
<input type="radio"/>	16	No Limit	No Limit
<input type="radio"/>	17	No Limit	No Limit
<input type="radio"/>	18	No Limit	No Limit
<input type="radio"/>	19	No Limit	No Limit
<input type="radio"/>	20	No Limit	No Limit
<input type="radio"/>	21	No Limit	No Limit
<input type="radio"/>	22	No Limit	No Limit
<input type="radio"/>	23	No Limit	No Limit
<input type="radio"/>	24	No Limit	No Limit
<input type="radio"/>	25	No Limit	No Limit
<input type="radio"/>	26	No Limit	No Limit

Figure 10- 5. Bandwidth Control Table

Click the selection button in the far left column that corresponds to the port you want to configure and click the Edit button. A new dialog box used to edit bandwidth settings opens.

Bandwidth Control Table - Edit	
Port	12
RX Rate	<input type="text"/> MBits <input checked="" type="checkbox"/> No Limit
TX Rate	<input type="text"/> MBits <input checked="" type="checkbox"/> No Limit
<input type="button" value="Back"/> <input type="button" value="Apply"/>	

Figure 10- 4. Edit Port Bandwidth

To limit either the Rx or Tx rates, deselect the No Limit check box and type the desired rate. Rates can be expressed using whole numbers up to the maximum available rate for the port.

Click on the **Apply** button to put the bandwidth limits into effect.



# Chapter 11

## MAC Notification

### *MAC Notification Global Setting* *MAC Notification Port Settings*

MAC address notification is used to monitor MAC addresses as they are learned and entered into the Switch's MAC forwarding database.

#### MAC Notification Global Settings

MAC Notification Global Settings	
State	Disabled ▾
Interval (sec)	1
History Size	1
Apply	

**Figure 11- 1. MAC Notification Global Settings**

Configure the following MAC notification global settings:

Parameter	Description
<b>State</b>	Enable or Disable MAC notification switch wide form the pull-down menu.
<b>Interval</b>	This is the time in seconds between notifications.
<b>History Size</b>	This is maximum number of entries listed in the history log used for notification. Up to 500 entries can be specified.

### MAC Notification Port Settings

Enable or disable MAC notification for ports with the menu below.

**MAC Notification Port Settings**

	Port	State
<input type="radio"/>	1	Disabled
<input type="radio"/>	2	Disabled
<input type="radio"/>	3	Disabled
<input type="radio"/>	4	Disabled
<input type="radio"/>	5	Disabled
<input type="radio"/>	6	Disabled
<input type="radio"/>	7	Disabled
<input type="radio"/>	8	Disabled
<input type="radio"/>	9	Disabled
<input type="radio"/>	10	Disabled
<input type="radio"/>	11	Disabled
<input type="radio"/>	12	Disabled
<input type="radio"/>	13	Disabled
<input type="radio"/>	14	Disabled
<input type="radio"/>	15	Disabled
<input type="radio"/>	16	Disabled

**Figure 11- 2. MAC Notification Port Settings**

To change MAC Notification settings for a port or a group of ports on the same switch, select the first (lowest numbered) port from the list and click the Edit button, a separate menu will appear.

**MAC Notification Port Settings - Edit**

Port	1
State	Disabled
Configure Ports from 1 to	1

**Figure 11- 3. MAC Notification Port Settings - Edit**

Configure the following MAC notification global settings:

Parameter	Description
<b>Port</b>	Select the port or lowest number of the group of ports being configured.
<b>State</b>	Enable or Disable MAC notification for the port from the pull-down menu.
<b>Configure Ports from __ to __</b>	A consecutive groups of ports may be configured starting with the selected port.

## Chapter 12

### System Log

The menu links to set up a **System Log** are located in their own subdirectory in the **Advanced Settings** folder. The log may be configured and later disabled without losing the configuration using the System Log State menu.

#### Configure System Log State

To enable the System Log Server settings, select *Enabled* and click the **Apply** button in the System Log State menu. Any server settings that have been configured will be retained regardless of whether the system log is on or off.

**Figure 12- 1. System Log State menu**

	Index	Server IP	Severity	Facility	UDP Port	Status
<input type="radio"/>	1	10. 42. 2. 84	All	Local0	514	Enabled
<input type="radio"/>	2	10. 41. 44. 88	Warning	Local1	514	Enabled

**Figure 12- 2. System Log Server list**

The parameters configured for adding and editing System Log Server settings are the same. See the table below for a description.

**Figure 12- 3. System Log Server – Add**

Use the descriptions here as a guide to set up the System Log Server settings.

Parameter	Description
<b>Index</b>	Syslog server settings index (1-4).
<b>Server IP</b>	Type in the IP address of the Syslog server receiving the message.
<b>Severity</b>	Select the level of message sent, select: <i>Warning</i> , <i>Information</i> or <i>All</i> .
<b>Facility</b>	<p>Some of the operating system daemons and processes have been assigned Facility values. Processes and daemons that have not been explicitly assigned a Facility may use any of the "local use" facilities or they may use the "user-level" Facility. Those Facilities that have been designated are shown in the following: Bold font means the facility values the switch supports now.</p> <p>Numerical      Facility Code</p> <p>0            kernel messages</p> <p>1            user-level messages</p> <p>2            mail system</p> <p>3            system daemons</p> <p>4            security/authorization messages</p> <p>5            messages generated internally by syslog line printer subsystem</p> <p>7            network news subsystem</p> <p>8            UUCP subsystem</p> <p>9            clock daemon</p> <p>10           security/authorization messages</p> <p>11           FTP daemon</p> <p>12           NTP subsystem</p> <p>13           log audit</p> <p>14           log alert</p> <p>15           clock daemon</p> <p>16           local use 0 (local0)</p> <p>17           local use 1 (local1)</p> <p>18           local use 2 (local2)</p> <p>19           local use 3 (local3)</p> <p>20           local use 4 (local4)</p> <p>21           local use 5 (local5)</p> <p>22           local use 6 (local6)</p> <p>23           local use 7 (local7)</p>
<b>UDP Port</b>	Type the UDP port number used for sending Syslog messages. The default is 514.
<b>Status</b>	Choose Enabled or Disabled to activate or deactivate this

# Chapter 13

## SNTP Settings

The Simple Network Time Protocol (SNTP), an adaptation of the Network Time Protocol (NTP) is configured on the Switch using the following pages. The SNTP subdirectory in the Basic Setup contains the links to the menus used to configure SNTP.

### Current Time Settings

Use the current time settings to determine how system time will be kept. The table below describes the parameters used for setting SNTP.

#### Current Time Settings

---

Current Time Status

System Boot Time	0 days 00:00:00
Current Time	0 days 00:01:54
Time Source	System Clock

---

SNTP Settings

SNTP State	Disabled ▾
SNTP Primary Server	0.0.0.0
SNTP Secondary Server	0.0.0.0
SNTP Poll Interval in Seconds	720

---

Set Current Time

Year	▾
Month	▾
Day	▾
Time in HH MM SS	▾ ▾ ▾

**Figure 13- 1. Current Time Settings**

The following parameters can set or are displayed:

Parameter	Description
<b>Current Time</b>	Displays the current system time.
<b>Time Source</b>	Displays the time source for the system.
<b>SNTP State</b>	Use this pull-down menu to <b>Enable</b> or <b>Disable</b> SNTP.
<b>SNTP Primary Server</b>	This is the primary server the SNTP information will be taken from
<b>SNTP Secondary Server</b>	This is the secondary server the SNTP information will be taken from
<b>SNTP Poll Interval in Seconds</b>	This is the interval between requests for updated SNTP information.
<b>Year</b>	Enter the current year, if you want to update the system clock.
<b>Month</b>	Enter the current month, if you want to update the system clock.
<b>Day</b>	Enter the current day, if you want to update the system clock.
<b>Time in HH MM SS</b>	Enter the current time in hours, minutes, and seconds, if you want to update the system clock.

## Time Zone and DST

See the table below for a description of the Time Zone and DST parameters.

Time Zone and DST Settings	
Time Zone and DST Settings	
Daylight Saving Time State	Disabled
Daylight Saving Time Offset in Minutes	60
Time Zone Offset:from GMT in +/-HH:MM	- 06 00
Apply	
DST Repeating Settings	
From:Which Day	First
From:Day of Week	Sunday
From:Month	April
From:time in HH MM	00 00
To:Which Day	Last
To:Day of Week	Sunday
To:Month	October
To:time in HH MM	00 00
Apply	
DST Annual Settings	
From:Month	April
From:Day	29
From:time in HH MM	00 00
To:Month	October
To:Day	12
To:Time in HH MM	00 00
Apply	

**Figure 13- 2. Time Zone and DST Settings**

The following parameters can set:

Parameter	Description
<b>Daylight Saving Time State</b>	Use this pull-down menu to <i>Enable</i> or <i>Disable</i> the DST Settings.
<b>Daylight Saving Time Offset in Minutes</b>	Use this pull-down menu to specify the amount of time that will constitute your local DST offset – 30, 60, 90, or 120 minutes.
<b>Time Zone Offset from GMT in +/- HH:MM</b>	Use these pull-down menus to specify your local time zone's offset from Greenwich Mean Time (GMT.)
<b>DST Repeating Settings</b>	Repeating - Using repeating mode will enable DST seasonal time adjustment. Repeating mode requires that the DST beginning and ending date be specified using a formula. For example, specify to begin DST on Saturday during the second week of April and end DST on Sunday during the last week of October.
<b>From: Which Day</b>	Should be From: Which Week. Enter the week of the month that DST will start.
<b>From: Day of Week</b>	Enter the day of the week that DST will start on.
<b>From: Month</b>	Enter the month DST will start on.
<b>From: time in HH:MM</b>	Enter the time of day that DST will start on.
<b>To: Which Day</b>	Should be be To: Which Week. Enter the week of the month the DST will end.
<b>To: Day of Week</b>	Enter the day of the week that DST will end.
<b>To: Month</b>	Enter the month that DST will end.
<b>To: time in HH:MM</b>	Enter the time DST will end.
<b>Annual Settings</b>	Annual - Using annual mode will enable DST seasonal time adjustment. Annual mode requires that the DST beginning and ending date be specified concisely. For example, specify to begin DST on April 3 and end DST on October 14.
<b>From: Month</b>	Enter the month DST will start on, each year.
<b>From: Day</b>	Enter the day of the week DST will start on, each year.
<b>From: time in HH:MM</b>	Enter the time of day DST will start on, each year.
<b>To: Month</b>	Enter the month DST will end on, each year.
<b>To: Day</b>	Enter the day of the week DST will end on, each year.
<b>To: time in HH:MM</b>	Enter the time of day that DST will end on, each year.

## Security Management

### *Access Profile Configuration*

#### *CPU Interface Filtering*

#### *802.1X Port-based Network Access Control*

#### *802.1X Configuration*

Various security mechanisms are available with the DES-3326S including those discussed in this chapter. Other techniques are used to improve the security environment that are not included in this chapter but are discussed in other chapters. This chapter is dedicated to setting up Access Profiles and 802.1X configuration.

## Access Profile Configuration

Access profiles allow you to establish criteria to determine if the Switch will forward packets based on the information contained in each packet's header. These criteria can be specified on a basis of VLAN, MAC address or IP address. First, create the Access Profile Mask, then, define the rules used to allow access.

### Access Profile Mask

Creating an access profile is divided into two basic parts. The first is to specify which part or parts of a frame the switch will examine, such as the MAC source address or the IP destination address. The second part is entering the criteria the switch will use to determine what to do with the frame. The entire process is described below in two parts.

Access Profile Mask Setting			
Total Entries: 3			
<input type="button" value="New"/> <input type="button" value="Edit Rule"/> <input type="button" value="Delete"/>			
	Profile ID	Access Profile	Access Profile Mask
<input type="radio"/>	10	Ethernet	source mac 00-00-00-00-00-00 /
<input type="radio"/>	60	IP	source_ip_mask 255.255.255. 0 /
<input type="radio"/>	100	Ethernet	destination mac 00-00-00-00-00-00 /

Figure 14- 1. Access Profile Mask Setting Table

### *To create an Access Profile Mask:*

Click the **New** button in the Access Profile Mask Setting summary table page. A new menu is displayed. Use this to create an access profile and specify what criteria are used to examine frames. Once the profile has been created you can set up the rule applied to the profile as described later in this section.



There are two different menus used to create an access profile mask, one for IP based and another for Ethernet based masks.

**Ethernet-based Access Profile Mask:**

Select the *Ethernet* option from the Access Profile pull-down menu to view the following:

Access Profile Mask Setting - Add	
Profile ID	<input type="text"/> <input checked="" type="checkbox"/> Auto Assign
Access Profile	Ethernet
<input type="checkbox"/> VLAN	
<input type="checkbox"/> Source MAC Mask	<input type="text"/>
<input type="checkbox"/> Destination MAC Mask	<input type="text"/>
<input type="checkbox"/> 802.1p	
<input type="checkbox"/> Ethernet Type	
<input type="button" value="Back"/> <span style="float: right;"><input type="button" value="Apply"/></span>	

**Figure 14- 2. MAC Address Access Profile Mask Setting – Add**

Parameter	Description
<b>Profile ID</b>	Type in a unique identifier number for this profile set or allow an ID to be automatically assigned by checking the Auto Assign option. This value can be set from 1 – 255. The profile ID sets the relative priority for the profile and specifies an index number that will identify the access profile being created with this command. Priority is set relative to other profiles where the lowest profile ID has the highest priority.
<b>Access Profile</b>	Select profile based on Ethernet (MAC Address) or IP address. This will change the menu according to the requirements for the type of profile. Select Ethernet to instruct the switch to examine the layer 2 part of each packet header. Select IP to instruct the switch to examine the IP address in each frame's header.
<b>VLAN</b>	Selecting this option instructs the switch to examine the VLAN part of each packet header and use this as the, or part of the criterion for forwarding.
<b>Source MAC Mask</b>	Enter a MAC address mask for the source MAC address.
<b>Destination MAC Mask</b>	Destination MAC Mask - Enter a MAC address mask for the destination MAC address.
<b>802.1p</b>	Selecting this option instructs the switch to examine the 802.1p priority value of each packet header and use this as the, or part of the criterion for forwarding.
<b>Ethernet type</b>	Selecting this option instructs the Switch to examine the Ethernet type value in each frame's header.

Click **Apply** to set this entry in the Switch's memory.

**IP-based Access Profile Mask:**

Select the *IP* option from the Access Profile pull-down menu to view the following:

Access Profile Mask Setting - Add	
Profile ID	<input type="text"/> <input checked="" type="checkbox"/> Auto Assign
Access Profile	IP
<input type="checkbox"/> VLAN	
<input type="checkbox"/> Source IP Mask	<input type="text"/> . <input type="text"/> . <input type="text"/> . <input type="text"/>
<input type="checkbox"/> Destination IP Mask	<input type="text"/> . <input type="text"/> . <input type="text"/> . <input type="text"/>
<input type="checkbox"/> DSCP	
<input type="checkbox"/> Protocol	<input type="radio"/> ICMP: <input type="checkbox"/> Type <input type="checkbox"/> Code <input type="radio"/> IGMP: <input type="checkbox"/> Type <input type="radio"/> TCP: <input type="checkbox"/> Source Port Mask 0x <input type="text"/> <input type="checkbox"/> Destination Port Mask 0x <input type="text"/> <input type="checkbox"/> flag mask bit <input type="checkbox"/> urg <input type="checkbox"/> ack <input type="checkbox"/> psh <input type="checkbox"/> rst <input type="checkbox"/> syn <input type="checkbox"/> fin <input type="radio"/> UDP: <input type="checkbox"/> Source Port Mask 0x <input type="text"/> <input type="checkbox"/> Destination Port Mask 0x <input type="text"/> <input type="radio"/> Protocol ID: <input type="checkbox"/> User Mask 0x <input type="text"/>
<input type="button" value="Back"/> <span style="float: right;"><input type="button" value="Apply"/></span>	

**Figure 14- 3. IP Address Access Profile Mask – Add**

Parameter	Description
<b>Profile ID</b>	Type in a unique identifier number for this profile set or allow an ID to be automatically assigned by checking the Auto Assign option. This value can be set from 1 – 255. The profile ID sets the relative priority for the profile and specifies an index number that will identify the access profile being created with this command. Priority is set relative to other profiles where the lowest profile ID has the highest priority.
<b>Access Profile</b>	Select profile based on Ethernet (MAC Address) or IP address. This will change the menu according to the requirements for the type of profile. Select Ethernet to instruct the switch to examine the layer 2 part of each packet header. Select IP to instruct the switch to examine the IP address in each frame's header.
<b>VLAN</b>	Selecting this option instructs the switch to examine the VLAN part of each packet header and use this as the, or part of the criterion for forwarding.
<b>Source IP Mask</b>	Enter an IP address mask for the source IP address.
<b>Destination IP Mask</b>	Destination IP Mask - Enter an IP address mask for the destination MAC address.
<b>DSCP</b>	Selecting this option instructs the switch to examine the DiffServ Code part of each packet header and use this as the, or part of the criterion for forwarding.
<b>Protocol*</b> (for IP address Access Profiles only)	<p>Selecting this option instructs the switch to examine the protocol type value in each frame's header. You must then specify what protocol(s) to include according to the following guidelines:</p> <p>Select ICMP to instruct the switch to examine the Internet Control Message Protocol (ICMP) field in each frame's header.</p> <p>Select Type to further specify that the access profile will apply an ICMP type value, or specify Code to further specify that the access profile will apply an ICMP cod value.</p> <p>Select IGMP to instruct the switch to examine the Internet Group Management Protocol (ICMP) field in each frame's header.</p> <p>Select Type to further specify that the access profile will apply an IGMP type value</p> <p>Select TCP to use the TCP port number contained in an incoming packet as the forwarding criterion. Selecting TCP requires that you specify a source port mask and/or a destination port mask.</p> <p>Source Port Mask Ox - Specify a TCP port mask for the source port in hex form (hex 0x0-0xffff).</p> <p>Destination Port Mask Ox - Specify a TCP port mask for the destination port in hex form (hex 0x0-0xffff).</p> <p>Select UDP to use the UDP port number contained in an incoming packet as the forwarding criterion. Selecting UDP requires that you specify a source port mask and/or a destination port mask.</p> <p>Source Port Mask Ox - Specify a TCP port mask for the source port in hex form (hex 0x0-0xffff).</p> <p>Destination Port Mask Ox - Specify a TCP port mask for the destination port in hex form (hex 0x0-0xffff).</p>
*TCP flag mask parameter can be implemented using the CLI interface. This option is not available using the web interface.	

**To establish the rule for a previously created Access Profile Mask:**

Select the Access Profile from the Access Profile Mask Setting Table and click the **Edit Rule** button.

### Access Profile Rule Setting

Profile ID	10
Access Profile	Ethernet
Access Profile Mask	source mac 00-00-00-00-00-00 /

Total Entries: 0

Access Rule ID	Access Profile	Access Profile Rule	Priority	Replace DSCP	Mode

**Figure 14- 4. Access Profile Rule Setting**

To create a new rule set for the access profile click the **New** button. A new menu is displayed. To remove a previously created rule, select it and lick the **Delete** button.

### Access Profile Rule Setting - Add

Profile ID	10
Mode	<input checked="" type="radio"/> Permit <input type="radio"/> Deny
Access Rule ID	<input type="text"/>
Access Profile	Ethernet
Source MAC	<input type="text"/>
<input type="checkbox"/> priority <input type="text"/>	<input type="checkbox"/> replace_priority
<input type="checkbox"/> replace_dscp <input type="text"/>	

**Figure 14- 5. Add Access Profile Rule**

Configure the following Access Profile Rule – Ethernet settings:

Parameter	Description
<b>Profile ID</b>	This is the identifier number for this profile set.
<b>Access Rule ID</b>	Type in a unique identifier number for this access. This value can be set from 1 – 255.
<b>priority</b>	Select this option to instruct the switch to use the 802.1p priority value entered in the adjacent field for packets that meet the criteria. A number between 0 – lowest priority, and 7 – highest priority, can be entered.
<b>replace_priority</b>	Select this option to instruct the switch to replace the 802.1p value (in a packet that meets the selected criteria). In this way, packets meeting the criteria can have their priority handling modified for use within the switch, and then have a different priority value assigned when they leave the switch.
<b>replace_dscp:</b>	Select this option to instruct the switch to replace the DSCP value (in a packet that meets the selected criteria) with the value entered in the adjacent field.

---

The following window is used for the IP Rule configuration.

Access Profile Rule Setting - Add	
Profile ID	60
Mode	<input checked="" type="radio"/> Permit <input type="radio"/> Deny
Access Rule ID	<input type="text"/>
Access Profile	IP
Source IP	0 . 0 . 0 . 0
<input type="checkbox"/> priority	<input type="text"/> <input type="checkbox"/> replace_priority
<input type="checkbox"/> replace_dscp	<input type="text"/>
<input type="button" value="Back"/> <span style="float: right;"><input type="button" value="Apply"/></span>	

**Figure 14- 6. Access Profile Rule Configuration – IP**

Configure the following Access Profile Rule - IP settings:

Parameter	Description
<b>Permit/Deny</b>	Select Permit to specify that the packets that match the access profile are forwarded by the switch according to any additional rule added (see below). Select Deny to specify that packets that do not match the access profile are not forwarded by the switch and will be filtered.
<b>Access Rule ID</b>	Adds an additional rule to the above specified access profile. The value is used to index the rule created.
<b>Source IP</b>	Enter an IP address for the source IP address.
<b>Destination IP</b>	Destination IP - Enter an IP address for the destination IP address.
<b>priority</b>	Select this option to instruct the switch to use the 802.1p priority value entered in the adjacent field for packets that meet the criteria. A number between 0 – lowest priority, and 7 – highest priority, can be entered.
<b>replace_priority</b>	Select this option to instruct the switch to replace the 802.1p value (in a packet that meets the selected criteria). In this way, packets meeting the criteria can have their priority handling modified for use within the switch, and then have a different priority value assigned when they leave the switch.
<b>replace_dscp:</b>	Select this option to instruct the switch to replace the DSCP value (in a packet that meets the selected criteria) with the value entered in the adjacent field.

## CPU Interface Filtering

There are specific circumstances under which the ACL cannot filter a packet even when there is a condition match that should deny forwarding. This is a limitation that may arise if:

- the destination MAC is the same as the Switch (system) MAC
- a packet is directed to the system IP interface such as multicast IP packets or if the hardware IP routing table is full and Switch software routes the packet according to routing protocol.

In order to address this functional limitation of the chip set, an additional function, **CPU Interface Filtering**, has been added. CPU Filtering may be universally enabled or disabled. Setting up CPU Interface Filtering follows the same basic procedure as ACL configuration and requires some of the same input parameters.

CPU Interface Filtering is configured in a manner similar to creating an Access Profiles. First a mask is created to specify which part or parts of a frame the Switch will examine, such as the MAC source address or the IP destination address. Then rules are used to define criteria the Switch will use to determine what to do with the frame. The entire process is described below.

### CPU Interface Filtering State Settings

In the following window, the user may globally enable or disable the CPU Interface Filtering mechanism by using the pull-down menu to change the running state. To access this window, click **CPU Interface Filtering State** in the Advanced Setup directory folder. Choose **Enabled** to enable CPU packets to be scrutinized by the Switch and **Disabled** to disallow this scrutiny.



Figure 14- 7. CPU Interface Filtering State Settings window

## CPU Interface Filtering Mask

Creating an access profile is divided into two basic parts. The first is to specify which part or parts of a frame the switch will examine, such as the MAC source address or the IP destination address. The second part is entering the criteria the switch will use to determine what to do with the frame. The entire process is described below in two parts.

The **CPU Interface Filtering** table displays the CPU Interface Filtering (mask) entries created on the Switch. To create a new CPU Interface Filtering entry, click the **New** button. To change an existing entry or view the rules for an entry, select the **Profile ID** number and click the **Edit Rule** button.

CPU Interface Filtering			
Total Entries: 3			
<input type="button" value="New"/> <input type="button" value="Edit Rule"/> <input type="button" value="Delete"/>			
	Profile ID	Access Profile	Access Profile Mask
<input type="radio"/>	20	Ethernet	source mac 00-00-00-00-00-00 /
<input type="radio"/>	68	IP	source_ip_mask 255.255.255. 0 /
<input type="radio"/>	106	IP	destination_ip_mask 255. 0. 0. 0 /

Figure 14- 8. CPU Interface Filtering Table

### To create a CPU Interface Filtering Mask:

Click the **New** button in the CPU Interface Filtering table summary table page. A new menu is displayed. Use this to create a mask to specify what criteria are used to examine frames.

There are two different mask types for CPU Interface Filtering and therefore two different menus for creating the masks, one for IP based and another for Ethernet based masks.

### Ethernet-based CPU Interface Filtering Mask:

Select the *Ethernet* option from the Access Profile pull-down menu to view the following:

CPU Interface Filtering - Add	
Profile ID	<input type="text"/> <input checked="" type="checkbox"/> Auto Assign
Access Profile	Ethernet ▾
<input type="checkbox"/> VLAN	
<input type="checkbox"/> Source MAC Mask	<input type="text"/>
<input type="checkbox"/> Destination MAC Mask	<input type="text"/>
<input type="checkbox"/> 802.1p	
<input type="checkbox"/> Ethernet Type	
<input type="button" value="Back"/> <input type="button" value="Apply"/>	

Figure 14- 9. CPU Interface Filtering Configuration window – Ethernet



Parameter	Description
<b>Profile ID</b>	Type in a unique identifier number for this profile set or allow an ID to be automatically assigned by checking the Auto Assign option. This value can be set from 1 – 255. The profile ID sets the relative priority for the profile and specifies an index number that will identify the cpu access profile being created with this command. Priority is set relative to other profiles where the lowest profile ID has the highest priority.
<b>Access Profile</b>	Select profile based on Ethernet (MAC Address) or IP address. This will change the menu according to the requirements for the type of profile. Select Ethernet to instruct the switch to examine the layer 2 part of each packet header. Select IP to instruct the switch to examine the IP address in each frame's header.
<b>VLAN</b>	Selecting this option instructs the switch to examine the VLAN part of each packet header and use this as the, or part of the criterion for forwarding.
<b>Source MAC Mask</b>	Enter a MAC address mask for the source MAC address.
<b>Destination MAC Mask</b>	Destination MAC Mask - Enter a MAC address mask for the destination MAC address.
<b>802.1p</b>	Selecting this option instructs the switch to examine the 802.1p priority value of each packet header and use this as the, or part of the criterion for forwarding.
<b>Ethernet type</b>	Selecting this option instructs the Switch to examine the Ethernet type value in each frame's header.

Click **Apply** to set this entry in the Switch's memory.

**IP-based CPU Interface Filtering Mask:**

Select the *IP* option from the Access Profile pull-down menu to view the following:

The screenshot shows a configuration window titled "CPU Interface Filtering - Add". It contains the following fields and options:

- Profile ID:** A text input field with a checked "Auto Assign" checkbox.
- Access Profile:** A dropdown menu currently set to "IP".
- VLAN:** A checkbox that is currently unchecked.
- Source IP Mask:** A field with four sub-inputs for IP address masking.
- Destination IP Mask:** A field with four sub-inputs for IP address masking.
- DSCP:** A checkbox that is currently unchecked.
- Protocol:** A section with several sub-options:
  - ICMP:** Includes checkboxes for "Type" and "Code".
  - IGMP:** Includes a checkbox for "Type".
  - TCP:** Includes checkboxes for "Source Port Mask 0x" and "Destination Port Mask 0x", and a "flag mask bit" section with checkboxes for "urg", "ack", "psh", "rst", "syn", and "fin".
  - UDP:** Includes checkboxes for "Source Port Mask 0x" and "Destination Port Mask 0x".
  - Protocol ID:** Includes a checkbox for "User Mask 0x".

At the bottom of the window, there are "Back" and "Apply" buttons.

**Figure 14- 10. CPU Interface Filtering Configuration window- IP**

Parameter	Description
<b>Profile ID</b>	Type in a unique identifier number for this profile set or allow an ID to be automatically assigned by checking the Auto Assign option. This value can be set from 1 – 255. The profile ID sets the relative priority for the profile and specifies an index number that will identify the cpu access profile being created with this command. Priority is set relative to other profiles where the lowest profile ID has the highest priority.
<b>Access Profile</b>	Select profile based on Ethernet (MAC Address) or IP address. This will change the menu according to the requirements for the type of profile. Select Ethernet to instruct the switch to examine the layer 2 part of each packet header. Select IP to instruct the switch to examine the IP address in each frame's header.
<b>VLAN</b>	Selecting this option instructs the switch to examine the VLAN part of each packet header and use this as the, or part of the criterion for forwarding.
<b>Source IP Mask</b>	Enter an IP address mask for the source IP address.
<b>Destination IP Mask</b>	Destination IP Mask - Enter an IP address mask for the destination MAC address.
<b>DSCP</b>	Selecting this option instructs the switch to examine the DiffServ Code part of each packet header and use this as the, or part of the criterion for forwarding.
<b>Protocol*</b> (for IP address Access Profiles only)	<p>Selecting this option instructs the switch to examine the protocol type value in each frame's header. You must then specify what protocol(s) to include according to the following guidelines:</p> <p>Select ICMP to instruct the switch to examine the Internet Control Message Protocol (ICMP) field in each frame's header.</p> <p>Select Type to further specify that the access profile will apply an ICMP type value, or specify Code to further specify that the access profile will apply an ICMP cod value.</p> <p>Select IGMP to instruct the switch to examine the Internet Group Management Protocol (ICMP) field in each frame's header.</p> <p>Select Type to further specify that the access profile will apply an IGMP type value</p> <p>Select TCP to use the TCP port number contained in an incoming packet as the forwarding criterion. Selecting TCP requires that you specify a source port mask and/or a destination port mask.</p> <p>Source Port Mask Ox - Specify a TCP port mask for the source port in hex form (hex 0x0-0xffff).</p> <p>Destination Port Mask Ox - Specify a TCP port mask for the destination port in hex form (hex 0x0-0xffff).</p> <p>Select UDP to use the UDP port number contained in an incoming packet as the forwarding criterion. Selecting UDP requires that you specify a source port mask and/or a destination port mask.</p> <p>Source Port Mask Ox - Specify a TCP port mask for the source port in hex form (hex 0x0-0xffff).</p> <p>Destination Port Mask Ox - Specify a TCP port mask for the destination port in hex form (hex 0x0-0xffff).</p>
*TCP flag mask parameter can be implemented using the CLI interface. This option is not available using the web interface.	

To establish the rule for a previously created CPU Interface Filtering entry:

Open the CPU Interface Filtering table menu and click the **Edit Rule** button.

CPU Interface Rule Setting			
Profile ID	20		
Access Profile	Ethernet		
Access Profile Mask	source mac 00-00-00-00-00-00 /		
Total Entries: 0			
<input type="button" value="New"/> <input type="button" value="Delete"/>			
Access Rule ID	Access Profile	Access Profile Rule	Mode

Figure 14- 11. CPU Interface Filtering Table – Ethernet

To create a new rule set for an access profile click the **New** button. A new window is displayed. To remove a previously created rule, click the corresponding **Delete** button. The following window is used for the Ethernet Rule configuration.

CPU Interface Rule Setting - Add	
Profile ID	20
Mode	<input checked="" type="radio"/> Permit <input type="radio"/> Deny
Access Rule ID	<input type="text"/>
Access Profile	Ethernet
Source MAC	<input type="text"/>
<input type="button" value="Back"/> <input type="button" value="Apply"/>	

Figure 14- 12. CPU Interface Filtering Rule Configuration – Ethernet

Configure the following CPU Interface Filtering Rule - Ethernet settings:

Parameter	Description
<b>Permit/Deny</b>	Select Permit to specify that the packets that match the access profile are forwarded by the switch according to any additional rule added (see below). Select Deny to specify that packets that do not match the access profile are not forwarded by the switch and will be filtered.
<b>Access Rule ID</b>	Adds an additional rule to the above specified access profile. The value is used to index the rule created.
<b>Source MAC</b>	Enter an MAC address for the source MAC address.
<b>Destination MAC</b>	Destination MAC - Enter a MAC address for the destination MAC address.

The following window is used for the IP Rule configuration.

CPU Interface Rule Setting - Add	
Profile ID	68
Mode	<input checked="" type="radio"/> Permit <input type="radio"/> Deny
Access Rule ID	<input type="text"/>
Access Profile	IP
Source IP	<input type="text"/> . <input type="text"/> . <input type="text"/> . <input type="text"/>
	<input type="text"/>
<input type="button" value="Back"/> <span style="float: right;"><input type="button" value="Apply"/></span>	

**Figure 14- 13. CPU Interface Filtering Rule Configuration – IP**

Configure the following CPU Interface Filtering Rule - IP settings:

Parameter	Description
<b>Permit/Deny</b>	Select Permit to specify that the packets that match the access profile are forwarded by the switch according to any additional rule added (see below). Select Deny to specify that packets that do not match the access profile are not forwarded by the switch and will be filtered.
<b>Access Rule ID</b>	Adds an additional rule to the above specified access profile. The value is used to index the rule created.
<b>Source IP</b>	Enter an IP address for the source IP address.
<b>Destination IP</b>	Destination IP - Enter an IP address for the destination IP address.

## 802.1X Port-based Network Access Control

The Switch is an implementation of the server side of IEEE 802.1X-Port Based Network Access Control. Through this mechanism, users have to be authorized before being able to access the network. See the following figure:

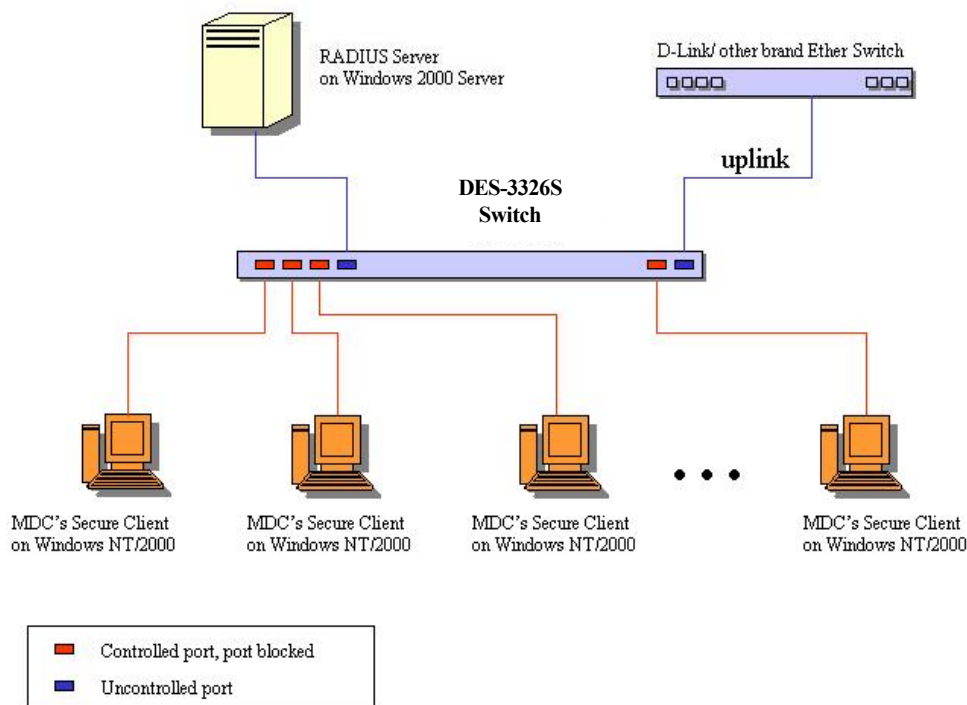

**Figure 14- 14. Typical 802.1X Configuration Prior to User Authentication**

Once the user is authenticated, the Switch unblocks the port that is connected to the user as shown in the next figure.

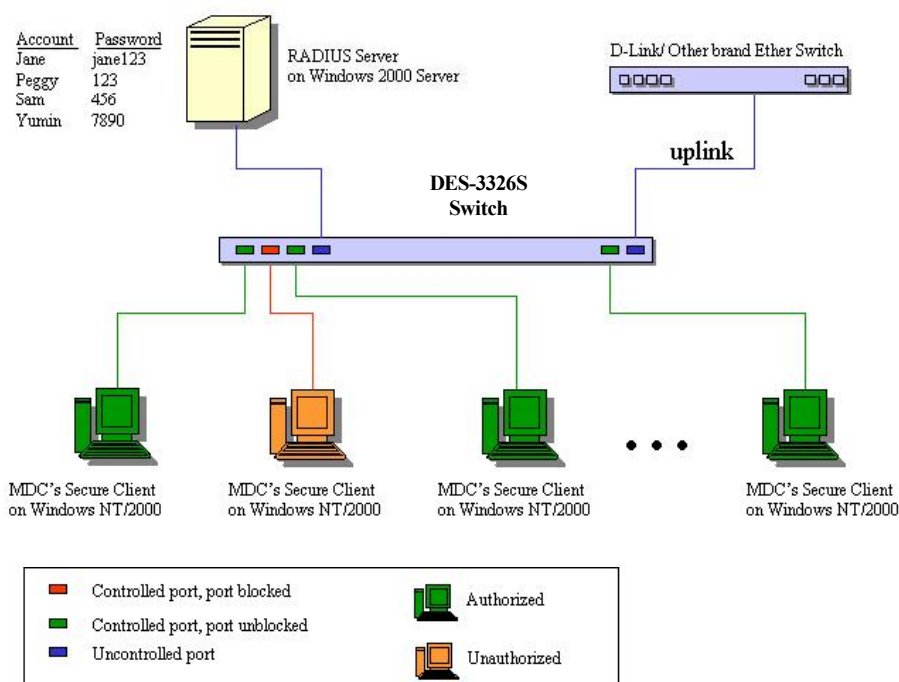

**Figure 14- 15. Typical 802.1X Configuration with User Authentication**

The user's information, including account number, password, and configuration details such as IP address and billing information, is stored in a centralized RADIUS server.

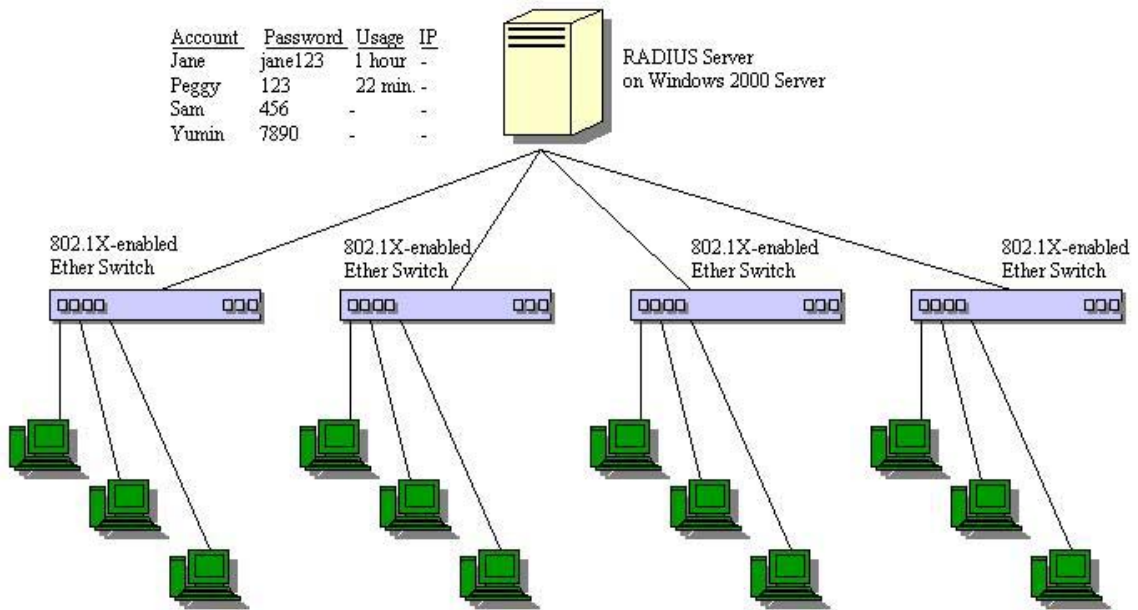

Figure 14- 16. Typical Configuration with 802.1X Fully Implemented

Table 2. Conformance to IEEE 802.1X Standards

State Machine Name
Port Timers state machine
Authenticator PAE state machine
The Authenticator Key Transmit state machine
Reauthentication Timer state machine
Backend Authentication state machine
Controlled Directions state machine
The Key Receive state machine

## 802.1X Configuration

The DES-3326S implements the server-side of the IEEE 802.1x Port-based Network Access Control. This mechanism is intended to allow only authorized users, or other network devices, access to network resources by establishing criteria for each port on the switch that a user or network device must meet before allowing that port to forward or receive frames.

IEEE 802.1X operation must be enabled on the switch before it will function. It will necessary to determine the whether to port-based or MAC-based 802.1x authorization (see below).

### 802.1X State

To use 802.1x on the switch, choose the type of authorization to use and click the Apply button.

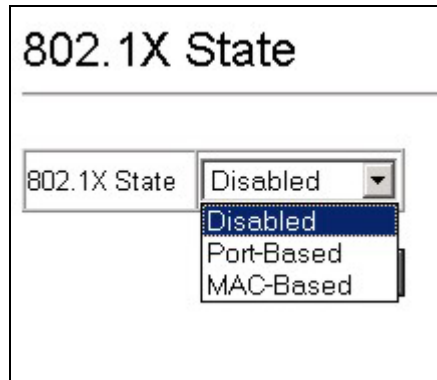

**Figure 14- 17. 802.1X State**

Port-based Authorization means that ports configured for 802.1x function (see 802.1X Port Settings) are initialized based on the port number only and subject to any authorization parameters as configured.

MAC-based Authorization means that ports configured for 802.1x function (see 802.1X Port Settings) are initialized based on port number and MAC address, then subject to any authorization parameters configured. Additional configuration is required to list the MAC address in the authorization list and to specify the port from which request is made (see Initialize Ports below).

### 802.1X Port Settings

Existing 802.1X port settings are displayed and can be configured using the menu below.

802.1X Port Settings														
802.1X State Disabled														
Edit														
Port	Capability	Port Status	Paee State	Backend State	AdminCtrlDir	OperCtrlDir	Port Control	QuietPeriod (sec)	TxPeriod (sec)	SuppTimeout (sec)	ServerTimeout (sec)	MaxReq	ReAuthPeriod (sec)	ReAuthenticate
C 1	None	Authorized	Force_Authorized	Success	Both	Both	Auto	60	30	30	30	2	3600	Disabled
C 2	None	Authorized	Force_Authorized	Success	Both	Both	Auto	60	30	30	30	2	3600	Disabled
C 3	None	Authorized	Force_Authorized	Success	Both	Both	Auto	60	30	30	30	2	3600	Disabled
C 4	None	Authorized	Force_Authorized	Success	Both	Both	Auto	60	30	30	30	2	3600	Disabled
C 5	None	Authorized	Force_Authorized	Success	Both	Both	Auto	60	30	30	30	2	3600	Disabled
C 6	None	Authorized	Force_Authorized	Success	Both	Both	Auto	60	30	30	30	2	3600	Disabled
C 7	None	Authorized	Force_Authorized	Success	Both	Both	Auto	60	30	30	30	2	3600	Disabled
C 8	Authenticator	Authorized	Force_Authorized	Success	Both	Both	Force_Authorized	60	30	30	30	2	3600	Disabled
C 9	None	Authorized	Force_Authorized	Success	Both	Both	Force_Unauthorized	60	30	30	30	2	3600	Disabled
C 10	None	Authorized	Force_Authorized	Success	Both	Both	Auto	60	30	30	30	2	3600	Disabled
C 11	None	Authorized	Force_Authorized	Success	Both	Both	Auto	60	30	30	30	2	3600	Disabled
C 12	None	Authorized	Force_Authorized	Success	Both	Both	Auto	60	30	30	30	2	3600	Disabled
C 13	None	Authorized	Force_Authorized	Success	Both	Both	Auto	60	30	30	30	2	3600	Disabled
C 14	None	Authorized	Force_Authorized	Success	Both	Both	Auto	60	30	30	30	2	3600	Disabled
C 15	None	Authorized	Force_Authorized	Success	Both	Both	Auto	60	30	30	30	2	3600	Disabled
C 16	None	Authorized	Force_Authorized	Success	Both	Both	Auto	60	30	30	30	2	3600	Disabled
C 17	None	Authorized	Force_Authorized	Success	Both	Both	Auto	60	30	30	30	2	3600	Disabled
C 18	None	Authorized	Force_Authorized	Success	Both	Both	Auto	60	30	30	30	2	3600	Disabled
C 19	None	Authorized	Force_Authorized	Success	Both	Both	Auto	60	30	30	30	2	3600	Disabled
C 20	None	Authorized	Force_Authorized	Success	Both	Both	Auto	60	30	30	30	2	3600	Disabled
C 21	None	Authorized	Force_Authorized	Success	Both	Both	Auto	60	30	30	30	2	3600	Disabled
C 22	None	Authorized	Force_Authorized	Success	Both	Both	Auto	60	30	30	30	2	3600	Disabled
C 23	None	Authorized	Force_Authorized	Success	Both	Both	Auto	60	30	30	30	2	3600	Disabled
C 24	None	Authorized	Force_Authorized	Success	Both	Both	Auto	60	30	30	30	2	3600	Disabled
C 25	None	Authorized	Force_Authorized	Success	Both	Both	Auto	60	30	30	30	2	3600	Disabled
C 26	None	Authorized	Force_Authorized	Success	Both	Both	Auto	60	30	30	30	2	3600	Disabled

Figure 14- 18. 802.1X Port Settings

Click the selection button on the far left that corresponds to the port you want to configure and click the Edit button, a separate menu will appear.

Parameter	Description
<b>Port status</b>	Lists the current status of port, Authorized or Unauthorized.
<b>PAE State</b>	Displays the administrative control over the port's authorization status. Force Authorized forces the Authenticator of the port to become Authorized. Force Unauthorized forces the port to become Unauthorized.
<b>Backend State</b>	Shows the current state of the Backend Authenticator.
<b>OperCtlState</b>	This displays whether a controlled Port that is unauthorized will exert control over communication in both receiving and transmitting directions, or just the receiving direction.



### 802.1X Port Settings - Edit

Port	1
AdminCtrlDir	Both
Port Control	Auto
TxPeriod (sec)	30
QuietPeriod (sec)	60
SuppTimeout (sec)	30
ServerTimeout (sec)	30
MaxReq	2
ReAuthPeriod (sec)	3600
ReAuthenticate	Disabled
Configure Ports from 1 to	1

Back
Apply

**Figure 14- 19. 802.1X Port Settings – Edit**

Configure the following 802.1x port settings:

Parameter	Description
<b>Port</b>	Port being configured for 802.1x settings.
<b>AdminCtrlDir</b>	From the pull-down menu, select whether a controlled Port that is unauthorized will exert control over communication in both receiving and transmitting directions, or just the receiving direction.
<b>Port Control</b>	From the pull-down menu, select Force Authorized, Force Unauthorized or Auto – Force Authorized forces the Authenticator of the port to become Authorized. Force Unauthorized forces the port to become Unauthorized.
<b>Quiet Period</b>	Select the time interval between authentication failure and the start of a new authentication attempt.
<b>Tx Period</b>	Select the time to wait for a response from a supplicant (user) to send EAP Request/Identity packets.
<b>Support Timeout</b>	Select the time to wait for a response from a supplicant (user) for all EAP packets, except for the Request/Identity packets.
<b>Server Timeout</b>	Select the length of time to wait for a response from a Radius server.
<b>MaxReq</b>	Select the maximum number of times to retry sending packets to the supplicant.
<b>ReAuthPeriod</b>	Select the time interval between successive re-authentications.
<b>ReAuthenticate</b>	Enable or disable reauthentication.

## Port Capability

### 802.1X Port Capability Setting

802.1X State	MAC-Based
Authentication Protocol	Radius_EAP

C	Port	Capability
<input type="radio"/>	1	Authenticator
<input type="radio"/>	2	Authenticator
<input type="radio"/>	3	None
<input type="radio"/>	4	None
<input type="radio"/>	5	None
<input type="radio"/>	6	None
<input type="radio"/>	7	None
<input type="radio"/>	8	None
<input type="radio"/>	9	None
<input type="radio"/>	10	None
<input type="radio"/>	11	None
<input type="radio"/>	12	None
<input type="radio"/>	15	None
<input type="radio"/>	16	None
<input type="radio"/>	17	None
<input type="radio"/>	18	None
<input type="radio"/>	19	None
<input type="radio"/>	20	None
<input type="radio"/>	21	None
<input type="radio"/>	22	None
<input type="radio"/>	23	None
<input type="radio"/>	24	None
<input type="radio"/>	25	None
<input type="radio"/>	26	None

Click the selection button on the far left that corresponds to the port you want to configure and click the Next button. This will open the Port Capability Settings - Edit menu

### 802.1X Port Capability Setting - Edit

Port

Capability

Configure Ports from 1 to

**Figure 14- 20. 802.1x Port Capability Settings - Edit**

**Figure 14- 21. 802.1x Port Capability Settings**

To configure 802.1x Port Capability for a port, select the port to be configured, and determine the (802.1x) port capability. Click the **Apply** button to configure the capability.

Parameter	Description
<b>Port</b>	Select the port or lowest number of the group of ports being configured.
<b>Capability</b>	Select the following: Authenticator – A user must pass the authentication process to gain access to the network. None – The port is not controlled by the 802.1x functions.
<b>Configure Ports from __ to</b>	A consecutive groups of ports may be configured starting with the selected port.

## Initialize Ports

Use this to initialize the 802.1x functions on specified ports or for specified MAC addresses operating from a specified range of ports.

**Figure 14- 22. Initialize Ports**

The Initialize Ports settings are as follows:

Parameter	Description
<b>Port</b>	Select the port or lowest number of the group of ports being configured.
<b>Configure Ports from __ to __</b>	A consecutive groups of ports may be configured starting with the selected port.
<b>MAC Address</b>	Specify the MAC address to add to the list for MAC based 802.1x initialization. Click the option box to insert a check mark before typing in the MAC address. This option can only be used if the authorization is MAC-based.

## Re-Authenticate Ports

802.1x ports must be periodically re-authenticated (when the re-authentication period lapses). Use this menu to determine if previously authenticated devices are re-authenticated based on either MAC address or port number.

**Figure 14- 23. Reauthenticate Ports**

The Reauthenticate Ports parameters are identical to the Initialize Ports parameters since they are basically doing the same thing.

Parameter	Description
<b>Port</b>	Select the port or lowest number of the group of ports being configured.
<b>Configure Ports from __ to</b> —	A consecutive groups of ports may be configured starting with the selected port.
<b>MAC Address</b>	Specify the MAC address to add to the list for re-authentication. Click the option box to insert a check mark before typing in the MAC address. This option can only be used if the authorization is MAC-based (see <b>802.1X State</b> ).

## Radius Server Settings

Use this menu to configure the settings the switch will use to communicate with a Radius server. To add Radius server settings click the **New** button, a separate configuration menu appears. To edit an existing Radius settings index, select it and click the edit button

Radius Server Settings

Total Entries: 1

	Index	IP Address	Key	AuthPortNumber	AcctPortNumber	Status
<input type="radio"/>	1	168.72.12.1	fy22lw67	1812	1813	Active

**Figure 14- 24. Radius Server Settings**

The parameters configured for adding and editing Radius settings are the same. See the table below for a description.

Radius Server Settings - Add

Index	<input type="text" value="1"/>
IP Address	<input type="text" value="0"/> <input type="text" value="0"/> <input type="text" value="0"/> <input type="text" value="0"/>
Key	<input type="text"/>
AuthPortNumber	<input type="text" value="1812"/>
AcctPortNumber	<input type="text" value="1813"/>

**Figure 14- 26. Radius Server – Add**

Radius Server Settings - Edit

Index	<input type="text" value="1"/>
IP Address	<input type="text" value="168"/> <input type="text" value="72"/> <input type="text" value="12"/> <input type="text" value="1"/>
Key	<input type="text" value="fy22lw67"/>
AuthPortNumber	<input type="text" value="1812"/>
AcctPortNumber	<input type="text" value="1813"/>

**Figure 14- 25. Edit Radius Server Settings**

Configure the following Radius server settings when adding or editing:

Parameter	Description
<b>Index</b>	Radius server settings index. (Not available in the Edit menu).
<b>IP Address</b>	Type in the IP address of the Radius server.
<b>Key</b>	Type the shared-secret key used by the Radius server and the switch. Up to 32 characters can be used.
<b>AuthPortNumber</b>	Type the UDP port number for authentication requests. The default is 1812.
<b>AcctPortNumber</b>	Type the UDP port number for accounting requests (if accounting server is being used). The default is 1813.

## **SNMP Network Management**

***SNMP View Table***

***SNMP Group Table***

***SNMP Community Table***

***SNMP Engine ID***

***SNMP Host Table***

***SNMP User Table***

***Security IP Management***

The DES-3326S incorporates a flexible SNMP management for the switching environment. SNMP management can be customized to suit the needs of the networks and the preferences of the network administrator. Use the SNMP V3 menus to select the SNMP version used for specific tasks.

### **SNMP Version**

The DES-3326S supports the Simple Network Management Protocol (SNMP) versions 1, 2c, and 3. The SNMP version used to monitor and control the switch can be specified by the administrator. The three versions of SNMP vary in the level of security provided between the management station and the network device.

SNMP settings are configured using the menus located on the SNMP V3 folder of the web manager. Workstations on the network that are allowed SNMP privileged access to the switch can be restricted with the Management Station IP Address menu.

## SNMP View Table

The SNMP View Table is used to assign views to community strings that define which MIB objects can be accessed by an SNMP manager.

SNMP View Table			
Total Entries: 10			
<input type="button" value="New"/> <input type="button" value="Delete"/>			
	View Name	Subtree	View Type
<input type="radio"/>	comview1	1.3.2.5.4.9	Included
<input type="radio"/>	newview1	1.3.2.4.4	Excluded
<input type="radio"/>	restricted	1.3.6.1.2.1.1	Included
<input type="radio"/>	restricted	1.3.6.1.2.1.11	Included
<input type="radio"/>	restricted	1.3.6.1.6.3.10.2.1	Included
<input type="radio"/>	restricted	1.3.6.1.6.3.11.2.1	Included
<input type="radio"/>	restricted	1.3.6.1.6.3.15.1.1	Included
<input type="radio"/>	CommunityView	1	Included
<input type="radio"/>	CommunityView	1.3.6.1.6.3	Excluded
<input type="radio"/>	CommunityView	1.3.6.1.6.3.1	Included

Figure 15- 2. SNMP View Table

To delete an existing View Table entry, click the selection button on the far left that corresponds to the port you want to configure and click the **Delete** button. To create a new entry, click the **New** button, a separate menu will appear.

SNMP View Table - Add	
View Name	<input type="text"/>
Subtree	<input type="text"/>
View Type	<input type="text" value="Included"/>
<input type="button" value="Back"/> <input type="button" value="Apply"/>	

Figure 15- 1. SNMP View Table – Add New

Parameter	Description
<b>View Name</b>	Type an alphanumeric string of up to 32 characters. This is used to identify the new SNMP view being created.
<b>Subtree</b>	Type the Object Identifier (OID) Subtree for the view. The OID identifies an object tree (MIB tree) that will be included or excluded from access by an SNMP manager.
<b>View Type</b>	Select <i>Included</i> to include this object in the list of objects that an SNMP manager can access. Select <i>Excluded</i> to exclude this object from the list of objects that an SNMP manager can access.

## SNMP Group Table

The SNMP Group created with this table maps SNMP users (identified in the SNMP User Table) to the views created in the previous menu.

SNMP Group Table

Total Entries: 5

	Group Name	Read View Name	Write View Name	Notify View Name	Security Model	Security Level
<input type="radio"/>	initial	restricted		restricted	SNMPv3	NoAuthNoPriv
<input type="radio"/>	ReadGroup	CommunityView		CommunityView	SNMPv1	NoAuthNoPriv
<input type="radio"/>	ReadGroup	CommunityView		CommunityView	SNMPv2	NoAuthNoPriv
<input type="radio"/>	WriteGroup	CommunityView	CommunityView	CommunityView	SNMPv1	NoAuthNoPriv
<input type="radio"/>	WriteGroup	CommunityView	CommunityView	CommunityView	SNMPv2	NoAuthNoPriv

Figure 15- 3. SNMP Group Table

To delete an existing entry, click the selection button on the far left that corresponds to the port you want to configure and click the **Delete** button. To create a new entry, click the **New** button, a separate menu will appear.

SNMP Group Table - Add

Group Name

Read View Name

Write View Name

Notify View Name

Security Model

Security Level

Figure 15- 4. SNMP Group – Add New

See the descriptions below for the SNMP Group Table parameters.



Parameter	Description
<b>Group Name</b>	Type an alphanumeric string of up to 32 characters. This is used to identify the new SNMP group of SNMP users.
<b>Read View Name</b>	This name is used to specify the SNMP group created can request SNMP messages.
<b>Write View Name</b>	Specify a SNMP group name for users that are allowed SNMP write privileges to the switch's SNMP agent.
<b>Notify View Name</b>	Specify a SNMP group name for users that can receive SNMP trap messages generated by the switch's SNMP agent.
<b>Security Model</b>	Use the pull-down menu to select the SNMP version. Select one of the following: <i>SNMPv1</i> – Specifies that SNMP version 1 will be used. <i>SNMPv2</i> – Specifies that SNMP version 2c will be used. The SNMP v2c supports both centralized and distributed network management strategies. It includes improvements in the Structure of Management Information (SMI) and adds some security features. <i>USM</i> – (User-based Security Module) Specifies that the SNMP version 3 will be used. SNMP v3 provides secure access to devices through a combination of authentication and encrypting packets over the network.
<b>Security Level</b>	Use the pull-down menu to select the SNMP version: <i>NoAuthNoPriv</i> – Specifies that there will be no authorization and no encryption of packets sent between the switch and a remote SNMP manager. <i>AuthNoPriv</i> – Specifies that authorization will be required, but there will be no encryption of packets sent between the switch and a remote SNMP manager. <i>AuthPriv</i> – Specifies that authorization will be required, and that packets sent between the switch and a remote SNMP manger will be encrypted.

## SNMP Community Table

Use this table to create an SNMP community string to define the relationship between the SNMP manager and an agent. The community string acts like a password to permit access to the agent on the switch. One or more of the following characteristics can be associated with the community string:

An Access List of IP addresses of SNMP managers that are permitted to use the community string to gain access to the switch's SNMP agent.

An MIB view that defines the subset of all MIB objects that will be accessible to the SNMP community.

Read/write or read-only level permission for the MIB objects accessible to the SNMP community

SNMP Community Table			
Total Entries: 2			
<input type="button" value="New"/>		<input type="button" value="Delete"/>	
	Community Name	View Name	Access Right
<input type="radio"/>	private	CommunityView	read_write
<input type="radio"/>	public	CommunityView	read_only

**Figure 15- 5. SNMP Community Table**

To delete an existing entry, click the selection button on the far left that corresponds to the port you want to configure and click the **Delete** button. To create a new entry, click the **New** button, a separate menu will appear. Configure the parameters as desired and click the **Apply** button to add the new string to the SNMP Community Table.

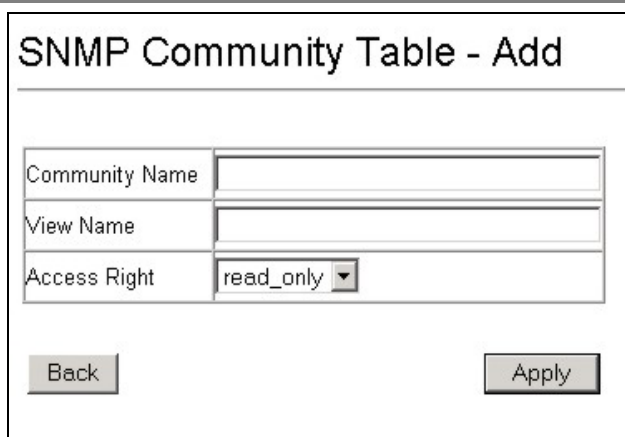

The image shows a web-based configuration form titled "SNMP Community Table - Add". It contains three input fields: "Community Name", "View Name", and "Access Right". The "Access Right" field is a dropdown menu currently set to "read\_only". Below the form are two buttons: "Back" and "Apply".

**Figure 15- 6. SNMP Community Table – Add**

Configure the following for the new SNMP Community entry:

Parameter	Description
<b>Community Name</b>	Type an alphanumeric string of up to 33 characters that is used to identify members of an SNMP community. This string is used like a password to give remote SNMP managers access to MIB objects in the switch's SNMP agent.
<b>View Name</b>	Type an alphanumeric string of up to 32 characters that is used to identify the group of MIB objects that a remote SNMP manager is allowed to access on the switch. The view name must exist in the SNMP View Table.
<b>Access Right</b>	Use the pull-down menu to select the access right: read_only – Specifies that SNMP community members using the community string created with this command can only read the contents of the MIBs on the switch. read_write – Specifies that SNMP community members using the community string created with this command can read from and write to the contents of the MIBs on the switch.

## SNMP Engine ID

The Engine ID is a unique identifier used for SNMP V3 implementations. This is an alphanumeric string used to identify the SNMP engine on the switch.

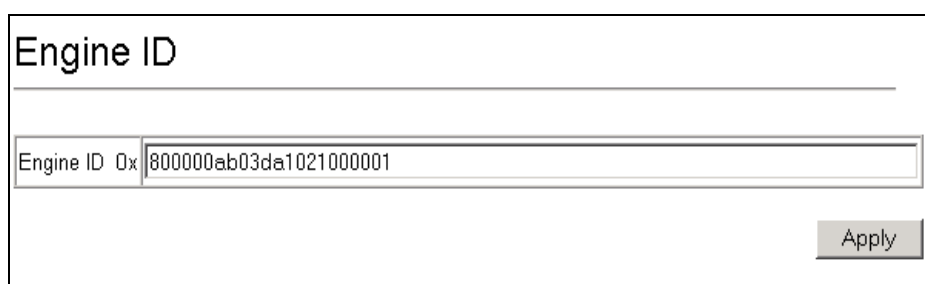

The image shows a web-based configuration form titled "Engine ID". It features a single text input field containing the hexadecimal string "800000ab03da1021000001". The label "Engine ID 0x" is positioned to the left of the input field. An "Apply" button is located at the bottom right of the form.

**Figure 15- 7. Engine ID**

To change the Engine ID, type the new Engine ID in the space provided and click the **Apply** button.

## SNMP Host Table

Use the SNMP Host Table to set up trap recipients.

	Host IP Address	SNMP Version	Community String / SNMPv3 User Name
<input type="radio"/>	0.0.0.0	V1	public

**Figure 15- 8. SNMP Host Table**

To delete an existing entry, click the selection button on the far left that corresponds to the port you want to configure and click the **Delete** button. To create a new entry, click the **New** button, a separate menu will appear.

**Figure 15- 9. SNMP Host Table – Add**

Parameter	Description
<b>IP Address</b>	Type the IP address of the remote management station that will serve as the SNMP host for the switch.
<b>SNMP Version</b>	From the pull-down menu select: V1 – To specifies that SNMP version 1 will be used. V2 – To specify that SNMP version 2 will be used. V3 – To specify that the SNMP version 3 will be used.
<b>Community String or SNMP V3 User Name</b>	Type in the community string or SNMP V3 user name as appropriate.

## SNMP User Table

Use the SNMP User Table to create a new SNMP user and add the user to an existing SNMP group or to a newly created group.

### SNMP User Table

---

Engine ID: 0x800000ab03da1021000001

Total Entries: 1

	User Name	Group Name	SNMP Version	Auth-Protocol	PrivProtocol
<input type="radio"/>	initial	initial	v3	None	None

**Figure 15- 10. SNMP User Table**

To delete an existing entry, click the selection button on the far left that corresponds to the port you want to configure and click the **Delete** button. To create a new entry, click the **New** button, a separate menu will appear.

### SNMP User Table - Add

---

Engine ID: 0x800000ab03000102030400

User Name	<input style="width: 90%;" type="text"/>	
Group Name	<input style="width: 90%;" type="text"/>	
SNMP Version	V1 <input type="button" value="v2"/> <input type="button" value="v3"/>	<input type="checkbox"/> encrypted
Auth-Protocol	MD5 <input type="button" value="SHA"/>	<input style="width: 80%;" type="text"/>
PrivProtocol	None <input type="button" value="AES"/>	<input style="width: 80%;" type="text"/>

**Figure 15- 11. SNMP User Table – Add**

See the table below for a description of the SNMP User Table parameters.

## Security IP Management

Management Stations IP Addresses designate stations that are allowed to make configuration changes to the Switch. This can be used in addition to standard SNMP security precautions (community strings). IP Management Stations may also be used with the more elaborate SNMP v3. SNMP Management configuration is presented in a separate chapter below.

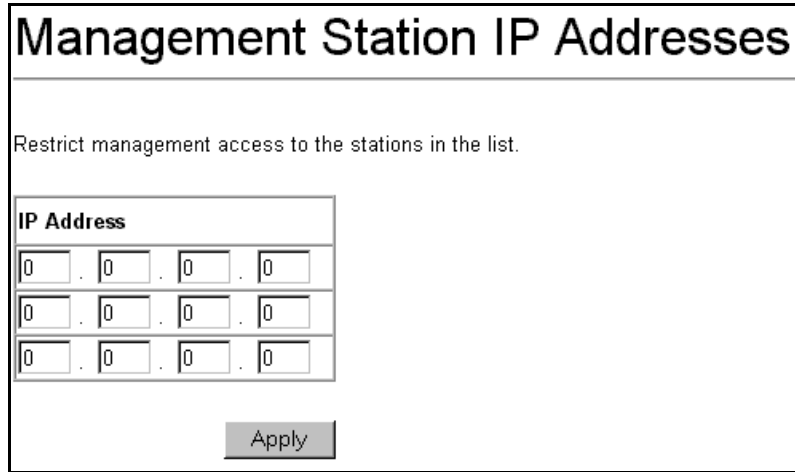

The image shows a web-based configuration form titled "Management Station IP Addresses". Below the title is a text instruction: "Restrict management access to the stations in the list." There is a table with three rows, each for entering an IP address. Each row has four input boxes for the octets, separated by dots. Below the table is an "Apply" button.

IP Address
<input type="text"/> . <input type="text"/> . <input type="text"/> . <input type="text"/>
<input type="text"/> . <input type="text"/> . <input type="text"/> . <input type="text"/>
<input type="text"/> . <input type="text"/> . <input type="text"/> . <input type="text"/>

Apply

**Figure 15- 12. Management IP Address Setup**

Select up to three management stations used to manage the Switch. If you choose to define one or more designated management stations, only the chosen stations, as defined by IP address, will be allowed management privilege through the web manager or Telnet session. To define a management station IP setting, type in the IP address in the area provided and click on the **Apply** button.

## **Network Monitoring and Statistics**

*Port Utilization Statistics*

*Port Packets Statistics*

*MAC Address Table*

*IP Address Table*

*Routing Table*

*ARP Table*

*OSPF Information*

*DVMRP Information*

*PIM Neighbor Address Table*

*GVRP Status*

*Router Ports*

*IGMP and IGMP Snooping Information*

*IP Multicast Forwarding Table*

*802.1X Authentication Status*

*Switch History*

The DES-3326S provides extensive network monitoring capabilities. The menus and subdirectories are located in the **Network Monitoring** folder in the **Basic Setup** folder.

## Port Utilization Statistics

**Port Utilization** can be viewed for individual ports using the **Line Chart** or you can opt to see all ports displayed in Port Utilization Table. These windows display the percentage of the total available bandwidth being used on the port.

To view port utilization statistics, open the **Network Monitoring** folder and the **Statistics** subdirectory. Click on either Port Utilization (Line Chart or Table) link:

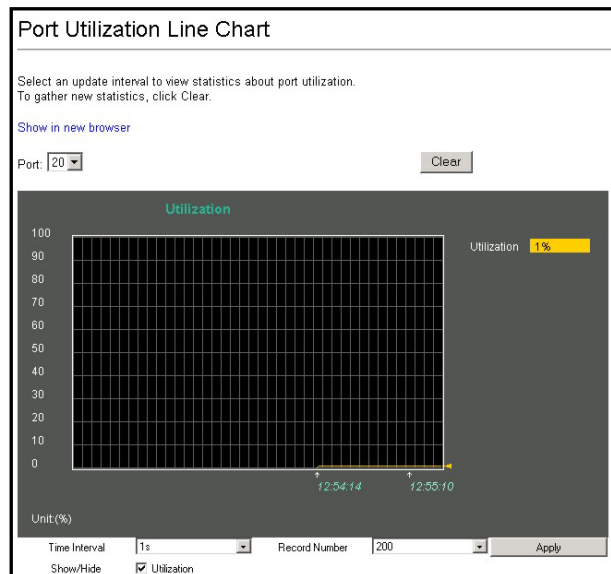

Figure 16- 1. Port Utilization Line Chart

Port	TX/sec	RX/sec	%Utilization
1	0	0	0
2	0	0	0
3	15	49	1
4	0	0	0
5	0	0	0
6	0	0	0
7	0	0	0
8	0	0	0
9	0	0	0
10	0	0	0
11	0	0	0
12	0	0	0
13	0	0	0
14	0	0	0
15	0	0	0
16	0	0	0
17	0	0	0
18	0	0	0
19	0	0	0
20	0	0	0
21	0	0	0
22	0	0	0
23	0	0	0
24	0	0	0
25	0	0	0
26	0	0	0

Figure 16- 2. Port Utilization Table

Select the desired port by clicking on the front panel display in the upper part of the web page or use the **Unit:** and **Port:** drop-down menus. The **Interval** field sets the interval at which the error statistics are updated.

The following field can be set:

Parameter	Description
<b>Unit</b>	Allows you to specify a Switch in a Switch stack using that Switch’s Unit ID.
<b>Port</b> (Line Chart only)	Allows you to specify a port to monitor – from the Switch selected above.
<b>Time Interval</b>	The time between updates received from the Switch, in seconds. Suspend stops the updates. The default is 1s.

## Port Packet Statistics

Packets statistics are viewed in the following menus:

### Port Packet Analysis

### Port Error Packets

### Port Packet Analysis

The **Port Packet Analysis** window displays the size of packets received or transmitted by a given switch port. In addition, statistics on the number and rate of unicast, multicast, and broadcast packets received by the switch are displayed.

To view an analysis of packets received or transmitted by a port, open the **Network Monitoring** folder and the **Statistics** subdirectory and click on the **Port Packet Analysis** link:

### Port Packet Analysis

Select a port and an update interval to view statistics about packet types and frames.  
To gather new statistics, click Clear.

[Show in new browser](#)

Unit:  Port:  Interval:

Frame Size	Frame Counts	Frames/sec	Packet Type	Total	Total/se
64	943192	48	RX Bytes	1007006387	4522
65-127	307197	9	RX Frames	2185487	50
128-255	108136	0	TX Bytes	8886597	22262
256-511	117813	7	TX Frames	26041	30
512-1023	282124	2			
1024-1518	453053	14			

Frame Type	Frame Counts	Frames/sec
Unicast RX	827850	25
Multicast RX	753319	4
Broadcast RX	604318	21

**Figure 16- 3. Port Packet Analysis**

Select the desired port by clicking on the front panel display in the upper part of the web page or use the **Unit:** and **Port:** drop-down menus. The **Interval** field sets the interval at which the error statistics are updated.



The packet analysis fields are described here:

Parameter	Description
<b>Update</b> <Suspend>	<b>Interval</b> The interval (in seconds) that the table is updated. The default is 2 seconds.
<b>Frames</b>	The number of packets (or frames) received or transmitted by the switch with the size, in octets, given by the column on the right.
<b>Frames/sec</b>	The number of packets (or frames) transmitted or received, per second, by the switch.
<b>Unicast RX</b>	Displays the number of unicast packets received by the switch in total number (Frames) and the rate (Frames/sec).
<b>Multicast RX</b>	Displays the number of multicast packets received by the switch in total number (Frames) and the rate (Frames/sec).
<b>Broadcast RX</b>	Displays the number of broadcast packets received by the switch in total number (Frames) and the rate (Frames/sec).
<b>RX Bytes</b>	Displays the number of bytes (octets) received by the switch in total number (Total), and rate (Total/sec).
<b>RX Frames</b>	Displays the number of packets (frames) received by the switch in total number (Total), and rate (Total/sec).
<b>TX Bytes</b>	Displays the number of bytes (octets) transmitted by the switch in total number (Total), and rate (Total/sec).
<b>TX Frames</b>	Displays the number of packets (frames) transmitted by the switch in total number (Total), and rate (Total/sec).

### Port Error Packets

The **Port Error Packets** window displays the packet errors that the switch can detect and displays the results on a per port basis.

To view the error statistics for a port, open the **Network Monitoring** folder and the **Statistics** subdirectory and click on the **Port Packet Analysis** link:

### Port Error Packets

Select a port and an update interval to view statistics about malformed and dropped packets.  
To gather new statistics, click Clear.

[Show in new browser](#)

Unit:  Port:  Interval:

RX Frames	TX Frames
CRC Error	0
Undersize	0
Oversize	0
Fragment	0
Jabber	0
Drop Packets	0
Excessive Deferral	0
CRC Error	0
Late Collision	0
Excessive Collision	0
Single Collision	0
Collision	0

**Figure 16- 4. Port Error Packet Statistics window**

Select the desired port by clicking on the front panel display in the upper part of the web page or use the **Unit:** and **Port:** drop-down menus. The **Interval** field sets the interval at which the error statistics are updated.

The following fields from above are described in more detail:

Parameter	Description
<b>Unit</b>	Allows the selection of a particular switch in a switch stack if you have installed the optional stacking module and have properly interconnected the switches.
<b>Port</b>	Allows the selection of a particular port on the switch.
<b>Update Interval</b> <Suspend>	The interval (in seconds) that the table is updated. The default is <i>Suspend</i> .
<b>RX Frames</b>	Received packets.
<b>CRC Error</b>	For 10 Mbps ports, the counter records CRC errors (FCS or alignment errors). For 100 Mbps ports, the counter records the sum of CRC errors and code errors (frames received with rxerror signal).
<b>Undersize</b>	The total number of frames received that were less than 64 octets long (excluding framing bits, but including FCS octets) and were otherwise well formed.
<b>Oversize</b>	The total number of frames received that were longer than 1518 octets (excluding framing bits, but including FCS octets) and were otherwise well formed.
<b>Fragment</b>	The total number of frames received that were less than 64 octets in length (excluding framing bits, but including FCS octets) and had either an FCS or an alignment error.
<b>Jabber</b>	The total number of frames received that were longer than 1518 octets (excluding framing bits, but including FCS octets), and had either an FCS or an alignment error.
<b>Drop Packets</b>	The total number of events in which packets were dropped due to a lack of resources.
<b>TX Frames</b>	Transmitted packets.
<b>Excessive Deferral</b>	The number of frames for which the first transmission attempt on a particular interface was delayed because the medium was busy.
<b>CRC Error</b>	For 10 Mbps ports, the counter records CRC errors (FCS or alignment errors). For 100 Mbps ports, the counter records the sum of CRC errors and code errors (frames received with rxerror signal).
<b>Late Collision</b>	Late Collisions. The number of times that a collision is detected later than 512 bit-times into the transmission of a packet.
<b>Excessive Collision</b>	Excessive Collisions. The number of frames for which transmission failed due to excessive collisions.
<b>Single Collision</b>	Single Collision Frames. The number of successfully transmitted frames for which transmission is inhibited by more than one collision.
<b>Collision</b>	An estimate of the total number of collisions on this network segment.

## MAC Address Table

This allows the switch's dynamic MAC address forwarding table to be viewed. When the switch learns an association between a MAC address and a port number, it makes an entry into its forwarding table. These entries are then used to forward packets through the switch.

To view MAC Address Table, open the **Network Monitoring** folder and the **Address Tables** subdirectory and click on the **MAC Address Table** link:

### MAC Address Table

To discover information about a MAC address, select a method for viewing MAC addresses, enter the required information, and click Browse.

**Browse Table By VLAN**

VLAN Name:

**Browse Table By MAC Address**

MAC Address:

**Browse Table By Port**

Unit:  Port:

VID	VLAN Name	MAC Address	Unit	Port	Type
1	default	00-00-22-22-22-52	1	3	Learned
1	default	00-00-e2-4f-57-03	1	3	Learned
1	default	00-00-e2-54-22-81	1	3	Learned
1	default	00-00-e2-6b-bc-f6	1	3	Learned
1	default	00-01-02-03-04-00	1	3	Learned
1	default	00-01-30-fa-5f-00	1	3	Learned
1	default	00-01-96-9c-06-00	1	3	Learned
1	default	00-04-76-61-14-66	1	3	Learned
1	default	00-05-5d-0a-c6-d6	1	3	Learned
1	default	00-05-5d-25-9b-26	1	3	Learned
1	default	00-05-5d-26-04-be	1	3	Learned
1	default	00-05-5d-ed-6f-83	1	3	Learned
1	default	00-05-5d-ed-84-ea	1	3	Learned
1	default	00-05-5d-ef-90-fd	1	3	Learned
1	default	00-05-5d-f6-9e-66	1	3	Learned
1	default	00-05-5d-f6-78-81	1	3	Learned
1	default	00-05-5d-f6-79-1c	1	3	Learned
1	default	00-05-5d-f6-96-27	1	3	Learned
1	default	00-05-5d-f6-96-f1	1	3	Learned
1	default	00-05-5d-f9-26-db	1	3	Learned

Total Addresses in Table: 289

**Figure 16- 5. Browse Address Table – sequential window**

The MAC Address Table can be browsed according to MAC address, VLAN or port.

## Routing Table

To view Routing Table, open the **Network Monitoring** folder and the **Address Tables** subdirectory and click on the **Routing Table** link:

### Routing Table

To find the route to a specific address, enter the IP address information and click Find.

Destination Address:  .  .  .

Mask:  .  .  .

Total Entries: 2

IP Address	Netmask	Gateway	Interface Name	Hops	Protocol
0.0.0.0	0.0.0.0	10.1.1.254	System	1	Default
10.0.0.0	255.0.0.0	0.0.0.0	System	1	Local

**Figure 16- 6. Routing Table**

Parameter	Description
<b>IP Address</b>	The IP address of the router.
<b>Netmask</b>	The subnet mask corresponding to the IP address above.
<b>Gateway</b>	The IP address of the gateway between the switch and this router.
<b>Interface Name</b>	The name of the IP interface on which this router resides.
<b>Hops</b>	The number of routers between the switch and this router.
<b>Protocol</b>	The routing protocol in use by this router.

## ARP Table

To view ARP Table, open the **Network Monitoring** folder and the **Address Tables** subdirectory and click on the **ARP Table** link:

### ARP Table

To find the MAC address that corresponds to an IP address, enter the interface and IP address information and click Find.

Interface Name:

IP Address:

Total Entries: 353

Interface Name	IP Address	MAC Address	Type
System	10.0.0.0	ff-ff-ff-ff-ff-ff	Local/Broadcast
System	10.1.1.1	00-50-ba-47-59-be	Dynamic
System	10.1.1.5	00-01-02-03-04-05	Dynamic
System	10.1.1.151	00-50-ba-70-d6-d0	Dynamic
System	10.1.1.152	00-13-00-00-00-01	Dynamic
System	10.1.1.155	00-50-ba-70-d6-9a	Dynamic
System	10.1.1.158	00-50-ba-15-a5-55	Dynamic
System	10.1.1.161	00-50-ba-70-e4-89	Dynamic
System	10.1.1.162	00-50-ba-70-e4-5a	Dynamic
System	10.1.1.163	00-50-ba-70-e4-55	Dynamic
System	10.1.1.164	00-50-ba-70-e4-65	Dynamic
System	10.1.1.166	00-50-ba-70-e4-58	Dynamic
System	10.1.1.167	00-50-ba-70-e4-45	Dynamic
System	10.1.1.168	00-50-ba-70-e4-57	Dynamic
System	10.1.1.169	00-50-ba-70-e4-4e	Dynamic
System	10.1.1.170	00-50-ba-70-e4-7a	Dynamic
System	10.1.1.171	00-50-ba-70-cc-19	Dynamic
System	10.1.1.172	00-50-ba-70-e4-49	Dynamic
System	10.1.1.173	00-50-ba-70-e4-6e	Dynamic
System	10.1.1.174	00-50-ba-70-e4-7e	Dynamic

[\[Next\]](#)

**Figure 16- 7. ARP Table**

Use the ARP Table to search for MAC addresses. Enter the **Interface Name** and **IP Address** and click on the **Find** button.

## OSPF Information

To view information relevant to OSPF operations, open the **Network Monitoring** and use the links located in the OSPF subdirectory. OSPF information can be viewed in the following menus:

**OSPF LSDB Table**

**OSPF Neighbor Table**

**OSPF Virtual Neighbor Table**

### OSPF Link State Database Table

The Switch maintains two OSPF Link State Databases (LSDB) – Internal and External. The Internal LSDB describes the Link State Advertisements (LSA) for OSPF Antonymous Systems (AS). The External LSDB describes the LSAA for those ASs not belonging to OSPF.

The internal OSPF Link State Database (LSDB) table can be viewed using the web-based manager.

The screenshot shows a web interface titled "OSPF LSDB Table". It contains the following elements:

- Area ID: [ ] . [ ] . [ ] . [ ]
- Advertise Router ID: [ ] . [ ] . [ ] . [ ]
- LSDB Type: ALL (dropdown menu)
- Browse button
- Total Entries: 0
- Table with columns: Area ID, LSDB Type, Adv. Router ID, Link State ID, Cost, Sequence

**Figure 16- 8. OSPF LSDB Table**

The following fields can be set or are displayed:

Parameter	Description
<b>Area ID</b>	Displays the OSPF Area ID.
<b>LSDB Type</b>	Displays which one of four types of link advertisements by which the current link was discovered by the Switch – Router link (RTRLINK), Network link (NETLINK), Summary link (Summary), Autonomous System link (ASSUMMARY).
<b>Adv Router ID</b>	Displays the Advertising Router's ID
<b>Link State ID</b>	This field identifies the portion of the Internet environment that is being described by the advertisement. The contents of this field depend on the advertisement's LS type. LS Type      Link State ID
	5      The destination network's IP address.
<b>Cost</b>	Displays the routing metric associated with the link.
<b>Sequence</b>	Displays a sequence number corresponding to number of times the current link has been advertised as changed.

**OSPF Neighbor Table**

OSPF Neighbor Table					
Total Entries: 0					
Neighbor ID	IP Address	Neighbor Options	Neighbor Priority	Neighbor State	State Changes

**Figure 16- 9. OSPF Neighbor Table**

The following fields are displayed.

Parameter	Description
<b>Neighbor ID</b>	The router ID of a neighboring router.
<b>IP Address</b>	The IP address of the neighboring router.
<b>Neighbor Options</b>	This field indicates whether the neighbor router can accept OSPF optional operation within its OSPF domain. For example, TOS routing.
<b>Neighbor Priority</b>	The priority value of the neighboring router.
<b>Neighbor State</b>	Indicates the relationship between the switch and the neighbor router.
<b>State Changes</b>	The number of times the neighbor router has changed state.

**OSPF Virtual Neighbor Table**

OSPF Virtual Neighbor Table					
Area ID: <input type="text"/> . <input type="text"/> . <input type="text"/> . <input type="text"/>					
Neighbor ID: <input type="text"/> . <input type="text"/> . <input type="text"/> . <input type="text"/> <input type="button" value="Browse"/>					
Total Entries: 0					
Transit Area ID	Virtual Neighbor ID	IP Address	Virtual Neighbor Options	Virtual Neighbor State	State Changes

**Figure 16- 10. OSPF Virtual Neighbor Table**

The following fields can be set or are displayed.

Parameter	Description
<b>Transit Area ID</b>	The area ID of the transit area that the virtual link resides on.
<b>Virtual Neighbor ID</b>	The router ID of the neighboring router via the virtual link.
<b>IP Address</b>	The IP address of the neighboring router.
<b>Virtual Neighbor Options</b>	This field indicates whether the neighbor router can accept OSPF optional operation within its OSPF domain. For example, TOS routing.
<b>Virtual Neighbor State</b>	Indicates the relationship between the switch and the neighbor router.
<b>State Changes</b>	The number of times the neighbor router has changed state.

## DVMRP Information

To view DVMRP information, open the **Network Monitoring** folder and use the links located in a separate DVMRP subdirectory. DVMRP information can be viewed in the following menus:

**DVMRP Routing Table**

**DVMRP Neighbor Address Table**

**DVMRP Next Hop Table**

### DVMRP Routing Table

### DVMRP Routing Table

---

To discover the route of a specific source, enter the IP information and click Find.

Source IP Address:  .  .  .

Source Mask:  .  .  .

Total Entries: 0

Source Address	Source Mask	Next Hop Router	Hop	Learned	Interface Name	Expire
----------------	-------------	-----------------	-----	---------	----------------	--------

**Figure 16- 11. DVMRP Routing Table**

The **Source Address** and **Source Mask** fields allow the entry of an IP address and corresponding subnet mask to search the table. Click **Find** and the DVMRP Routing table will be searched for the IP address and subnet mask above.

The following fields are displayed.

Parameter	Description
<b>Source Address</b>	The IP address of the DVMRP router.
<b>Source Mask</b>	The subnet mask corresponding to the IP address above.
<b>Next Hop Router</b>	The IP address of the next hop router.
<b>Hop</b>	The number of hops (routers) that are between the switch and the listed router.
<b>Learned</b>	Indicates whether this entry is dynamic (learned) or not.
<b>Interface Name</b>	The name of the IP interface the router resides on.
<b>Expire</b>	The total number of routers that the packets can cross.



**DVMRP Neighbor Address Table**

DVMRP Neighbor Address Table			
Total Entries: 0			
Interface	Neighbor Address	Generation ID	Expire Time

**Figure 16- 12. DVMRP Neighbor Table**

The following fields are displayed.

Parameter	Description
<b>Interface</b>	The name of the IP interface the router resides on.
<b>Neighbor Address</b>	IP address of the DVMRP neighbor.
<b>Generation ID</b>	Indicates if the neighbor supports generation ID.
<b>Expire Time</b>	Time in seconds until the DVMRP neighbor information expires.

**DVMRP Next Hop Table**

DVMRP Routing Next Hop Table			
Total Entries: 0			
Source IP Address	Source Mask	Interface Name	Type

**Figure 16- 13. DVMRP Next Hop Table**

The following fields are displayed.

Parameter	Description
<b>Source IP Address</b>	The network address which, when combined with the corresponding next hop Source Mask value, identifies the source for which this entry specifies a next hop on an outgoing interface.
<b>Source Mask</b>	The network mask which, when combined with the corresponding next hop Source value, identifies the source for which this entry specifies a next hop on an outgoing interface.
<b>Interface Name</b>	The name of the IP interface the router resides on.
<b>Type</b>	Type is 0, or leaf, if no downstream dependent neighbors exist on the outgoing virtual interface. Otherwise, type is branch.

## PIM Neighbor Address Table

Multicast routers use **Protocol Independent Multicast (PIM)** to determine which other multicast routers should receive multicast packets.

The **PIM Neighbor Address Table** contains information regarding each of a router's PIM neighbors. This screen may be found in the **Monitoring** folder under the heading **PIM Monitoring** and is a read-only screen.

PIM Neighbor Address Table		
Total Entries: 0		
Interface	Neighbor Address	Expire Time

Figure 16- 14. PIM Neighbor Address Table

The following fields are displayed.

Parameter	Description
<b>Interface</b>	The name of the IP interface the router resides on.
<b>Neighbor Address</b>	IP address of the PIM neighbor.
<b>Expire Time</b>	Time in seconds until the PIM neighbor information expires.

## GVRP Status

This allows the GVRP status for each of the switch's ports to be viewed by VLAN. The GVRP status screen displays the ports on the switch that are currently Egress or Untagged ports. To view GVRP Status, open the **Network Monitoring** folder and the **Status** subdirectory. Click on the **GVRP Status** link to see the following menu:

GVRP Status																																																							
Displays information about the Group VLAN Registration Protocol.																																																							
IEEE 802.1Q VLAN ID	1																																																						
Status	Permanent																																																						
Creation time since switch power up	07:27:56																																																						
Current Egress Ports	<table border="0"> <tr> <td></td> <td>1</td><td>2</td><td>3</td><td>4</td><td>5</td><td>6</td><td>7</td><td>8</td><td>9</td><td>10</td><td>11</td><td>12</td><td>13</td><td>14</td><td>15</td><td>16</td><td>17</td><td>18</td><td>19</td><td>20</td><td>21</td><td>22</td><td>23</td><td>24</td><td>25</td><td>26</td> </tr> <tr> <td>Unit 1</td> <td><input checked="" type="checkbox"/></td><td><input checked="" type="checkbox"/></td><td><input checked="" type="checkbox"/></td><td><input checked="" type="checkbox"/></td><td><input checked="" type="checkbox"/></td><td><input checked="" type="checkbox"/></td><td><input checked="" type="checkbox"/></td><td><input checked="" type="checkbox"/></td><td><input checked="" type="checkbox"/></td><td><input checked="" type="checkbox"/></td><td><input checked="" type="checkbox"/></td><td><input checked="" type="checkbox"/></td><td><input checked="" type="checkbox"/></td><td><input checked="" type="checkbox"/></td><td><input checked="" type="checkbox"/></td><td><input checked="" type="checkbox"/></td><td><input checked="" type="checkbox"/></td><td><input checked="" type="checkbox"/></td><td><input checked="" type="checkbox"/></td><td><input checked="" type="checkbox"/></td><td><input checked="" type="checkbox"/></td><td><input checked="" type="checkbox"/></td><td><input checked="" type="checkbox"/></td><td><input checked="" type="checkbox"/></td><td><input checked="" type="checkbox"/></td><td><input checked="" type="checkbox"/></td> </tr> </table>		1	2	3	4	5	6	7	8	9	10	11	12	13	14	15	16	17	18	19	20	21	22	23	24	25	26	Unit 1	<input checked="" type="checkbox"/>	<input checked="" type="checkbox"/>	<input checked="" type="checkbox"/>	<input checked="" type="checkbox"/>	<input checked="" type="checkbox"/>	<input checked="" type="checkbox"/>	<input checked="" type="checkbox"/>	<input checked="" type="checkbox"/>	<input checked="" type="checkbox"/>	<input checked="" type="checkbox"/>	<input checked="" type="checkbox"/>	<input checked="" type="checkbox"/>	<input checked="" type="checkbox"/>	<input checked="" type="checkbox"/>	<input checked="" type="checkbox"/>	<input checked="" type="checkbox"/>	<input checked="" type="checkbox"/>	<input checked="" type="checkbox"/>	<input checked="" type="checkbox"/>	<input checked="" type="checkbox"/>	<input checked="" type="checkbox"/>	<input checked="" type="checkbox"/>	<input checked="" type="checkbox"/>	<input checked="" type="checkbox"/>	<input checked="" type="checkbox"/>	<input checked="" type="checkbox"/>
	1	2	3	4	5	6	7	8	9	10	11	12	13	14	15	16	17	18	19	20	21	22	23	24	25	26																													
Unit 1	<input checked="" type="checkbox"/>	<input checked="" type="checkbox"/>	<input checked="" type="checkbox"/>	<input checked="" type="checkbox"/>	<input checked="" type="checkbox"/>	<input checked="" type="checkbox"/>	<input checked="" type="checkbox"/>	<input checked="" type="checkbox"/>	<input checked="" type="checkbox"/>	<input checked="" type="checkbox"/>	<input checked="" type="checkbox"/>	<input checked="" type="checkbox"/>	<input checked="" type="checkbox"/>	<input checked="" type="checkbox"/>	<input checked="" type="checkbox"/>	<input checked="" type="checkbox"/>	<input checked="" type="checkbox"/>	<input checked="" type="checkbox"/>	<input checked="" type="checkbox"/>	<input checked="" type="checkbox"/>	<input checked="" type="checkbox"/>	<input checked="" type="checkbox"/>	<input checked="" type="checkbox"/>	<input checked="" type="checkbox"/>	<input checked="" type="checkbox"/>	<input checked="" type="checkbox"/>																													
Current Untagged Ports	<table border="0"> <tr> <td></td> <td>1</td><td>2</td><td>3</td><td>4</td><td>5</td><td>6</td><td>7</td><td>8</td><td>9</td><td>10</td><td>11</td><td>12</td><td>13</td><td>14</td><td>15</td><td>16</td><td>17</td><td>18</td><td>19</td><td>20</td><td>21</td><td>22</td><td>23</td><td>24</td><td>25</td><td>26</td> </tr> <tr> <td>Unit 1</td> <td><input checked="" type="checkbox"/></td><td><input checked="" type="checkbox"/></td><td><input checked="" type="checkbox"/></td><td><input checked="" type="checkbox"/></td><td><input checked="" type="checkbox"/></td><td><input checked="" type="checkbox"/></td><td><input checked="" type="checkbox"/></td><td><input checked="" type="checkbox"/></td><td><input checked="" type="checkbox"/></td><td><input checked="" type="checkbox"/></td><td><input checked="" type="checkbox"/></td><td><input checked="" type="checkbox"/></td><td><input checked="" type="checkbox"/></td><td><input checked="" type="checkbox"/></td><td><input checked="" type="checkbox"/></td><td><input checked="" type="checkbox"/></td><td><input checked="" type="checkbox"/></td><td><input checked="" type="checkbox"/></td><td><input checked="" type="checkbox"/></td><td><input checked="" type="checkbox"/></td><td><input checked="" type="checkbox"/></td><td><input checked="" type="checkbox"/></td><td><input checked="" type="checkbox"/></td><td><input checked="" type="checkbox"/></td><td><input checked="" type="checkbox"/></td><td><input checked="" type="checkbox"/></td> </tr> </table>		1	2	3	4	5	6	7	8	9	10	11	12	13	14	15	16	17	18	19	20	21	22	23	24	25	26	Unit 1	<input checked="" type="checkbox"/>	<input checked="" type="checkbox"/>	<input checked="" type="checkbox"/>	<input checked="" type="checkbox"/>	<input checked="" type="checkbox"/>	<input checked="" type="checkbox"/>	<input checked="" type="checkbox"/>	<input checked="" type="checkbox"/>	<input checked="" type="checkbox"/>	<input checked="" type="checkbox"/>	<input checked="" type="checkbox"/>	<input checked="" type="checkbox"/>	<input checked="" type="checkbox"/>	<input checked="" type="checkbox"/>	<input checked="" type="checkbox"/>	<input checked="" type="checkbox"/>	<input checked="" type="checkbox"/>	<input checked="" type="checkbox"/>	<input checked="" type="checkbox"/>	<input checked="" type="checkbox"/>	<input checked="" type="checkbox"/>	<input checked="" type="checkbox"/>	<input checked="" type="checkbox"/>	<input checked="" type="checkbox"/>	<input checked="" type="checkbox"/>	<input checked="" type="checkbox"/>
	1	2	3	4	5	6	7	8	9	10	11	12	13	14	15	16	17	18	19	20	21	22	23	24	25	26																													
Unit 1	<input checked="" type="checkbox"/>	<input checked="" type="checkbox"/>	<input checked="" type="checkbox"/>	<input checked="" type="checkbox"/>	<input checked="" type="checkbox"/>	<input checked="" type="checkbox"/>	<input checked="" type="checkbox"/>	<input checked="" type="checkbox"/>	<input checked="" type="checkbox"/>	<input checked="" type="checkbox"/>	<input checked="" type="checkbox"/>	<input checked="" type="checkbox"/>	<input checked="" type="checkbox"/>	<input checked="" type="checkbox"/>	<input checked="" type="checkbox"/>	<input checked="" type="checkbox"/>	<input checked="" type="checkbox"/>	<input checked="" type="checkbox"/>	<input checked="" type="checkbox"/>	<input checked="" type="checkbox"/>	<input checked="" type="checkbox"/>	<input checked="" type="checkbox"/>	<input checked="" type="checkbox"/>	<input checked="" type="checkbox"/>	<input checked="" type="checkbox"/>	<input checked="" type="checkbox"/>																													
Number of IEEE 802.1Q VLANs: 1																																																							

Figure 16- 15. GVRP Status

## Router Ports

This displays which of the switch's ports are currently configured as router ports. A router port configured by a user (using the console or Web-based management interfaces) is displayed as a static router port, designated by **S**. A router port that is dynamically configured by the switch is designated by **D**.

To browse the Router Ports, open the **Network Monitoring** folder and the **Status** subdirectory. Click on the **Router Ports** link to see the following menu:

### Router Ports

---

Enter a VLAN name and click Find to discover which ports are routing UDP multicast packets.

VLAN Name:

S: Static router port    D: Dynamic router port

VLAN Name	Router Port
	1 to 8   9 to 16   17 to 24   25   26
default	Unit 1 ----- - -

**Figure 16- 16. Browse Router Port**

**S** signifies a static router port, configured by the user.

**D** signifies a dynamically assigned router port, configured by the switch.

## IGMP Snooping Group Table

This allows the Switch's IGMP Snooping table to be viewed. IGMP Snooping allows the switch to read the Multicast Group IP address and the corresponding MAC address from IGMP packets that pass through the Switch. You may specify a VLAN by name to view.

To browse the IGMP Snooping table, open the **Network Monitoring** folder and the **Status** subdirectory. Click on the **IGMP Snooping Group Table** link to see the following menu:

### IGMP Snooping Group Table

---

Enter a VLAN name and click Find to discover the IGMP groups on the VLAN.

VLAN Name:

Total Entries in the VLAN: 0

Multicast Group	MAC Address	Port Map	Reports
		1 to 8 9 to 16 17 to 24 25 26	

**Figure 16- 17. IGMP Snooping Group Table**

Specify the VLAN and click on the **Find** button. The following fields are displayed.

Parameter	Description
<b>Multicast Group</b>	The IP address of the multicast group.
<b>MAC Address</b>	The MAC address of the multicast group.
<b>Port Map</b>	These are the ports where the IGMP packets were snooped are displayed,
<b>Reports</b>	The total number of reports received for this group.

## IGMP Snooping Forwarding Table

This allows the switch's IGMP Snooping Forwarding table to be viewed. IGMP Snooping allows the switch to read the Multicast Group IP address and the corresponding Source IP address from IGMP packets that pass through the Switch. You may specify a VLAN by name to view.

To browse the IGMP Snooping Forwarding table, open the **Network Monitoring** folder and the **Status** subdirectory. Click on the **IGMP Snooping Forwarding Table** link to see the following menu:

### IGMP Snooping Forwarding Table

---

Enter a VLAN name and click Find to discover the IGMP snooping forwarding entries on the VLAN.

VLAN Name:

Total Entries in the VLAN: 0

Source IP	Multicast Group	Port Map
		1 to 8 9 to 16 17 to 24 25 26

**Figure 16- 18. IGMP Forwarding Table**

Specify the VLAN and click on the **Find** button. The following information is displayed in the IGMP Snooping Forwarding table:

Parameter	Description
<b>Source IP</b>	The IP address of the device sending the IGMP packets.
<b>Multicast Group</b>	The IP address of the multicast group.
<b>Port Map</b>	These are the ports where the IGMP packets were snooped are displayed.

## IGMP Group Table

To browse the IGMP Group table, open the **Network Monitoring** folder and the **Status** subdirectory. Click on the **IGMP Group Table** link to see the following menu:

### IGMP Group Table

To discover information about a specific IGMP group, enter the interface name and group IP address and click Find.

Interface Name:

Multicast Group:  .  .  .

Total Entries: 0

Interface Name	Multicast Group	Last Reporter IP	Querier IP	Expire
----------------	-----------------	------------------	------------	--------

**Figure 16- 19. IGMP Group Table**

Specify the Interface and Multicast Group IP address and click on the **Find** button. The following IGMP Group information is displayed:

Parameter	Description
<b>Interface Name</b>	The name of the IP interface the IGMP Group resides on.
<b>Multicast Group</b>	The IP address of the multicast group.
<b>Last Reporter IP</b>	The IP address of the last IGMP report sender.
<b>Querier IP</b>	The IP address of the IGMP querier.
<b>Expire</b>	The total number of hops (routers) packets are allowed to cross.

## IP Multicast Forwarding Table

To browse the IP Multicast Forwarding table, open the **Network Monitoring** folder and the **Status** subdirectory. Click on the **IP Multicast Forwarding Table** link to see the following menu:

### IP Multicast Forwarding Table

---

To discover information about a specific multicast group, enter the IP information and click Find.

Multicast Group:  .  .  .

Source IP:  .  .  .

Source Mask:  .  .  .

Total Entries: 0

Multicast Group	Source IP Address	Source Mask	Upstream Neighbor	Expire Time	Protocol

**Figure 16- 20. IP Multicast Forwarding Table**

Specify the Multicast Group IP address, Source IP address and Mask, and click on the **Find** button. The following Multicast Forwarding information is displayed:

Parameter	Description
<b>Multicast Group</b>	The IP address of the multicast group.
<b>Source IP Address</b>	The IP address of the multicast source.
<b>Source Mask</b>	The subnet mask corresponding to the IP address above.
<b>Upstream Neighbor</b>	The IP address of the next router on the path from the switch to the multicast source.
<b>Expire Time</b>	The number of hops (routers) the packets are allowed to cross.
<b>Protocol</b>	The routing protocol in use.

## 802.1X Authentication Status

The **802.1X Authentication Status** window displays if 802.1X is enabled or disabled. It can be globally enabled with the 802.1X State menu located in the 802.1X subdirectory of the Advanced Setup folder. The default settings for 802.1X Authentication is disabled.

### 802.1X Authentication Status

---

802.1X State Disabled

**Figure 16- 21. 802.1X Status**

## Switch History

This allows the Switch History Log to be viewed. The Switch records all traps, in sequence, that identify events on the switch. The time since the last cold start of the switch is also recorded.

The link to view **Switch History** is located in the **Status** subdirectory of the **Network Monitoring** folder.

Switch History		
Displays the log of switch events with the newest event at the top.		
Index	Time	Log Text
44	00000 days 00:01:52	Successful login through Web (Username: Anonymous)
43	00000 days 00:01:04	Successful login through Console (Username: Anonymous)
42	00000 days 00:00:39	System started up
41	00000 days 00:00:39	Spanning Tree Protocol is disabled
40	00000 days 00:00:04	Port 20 link up, 100Mbps FULL duplex
39	00000 days 00:11:46	Configuration saved to flash (Username: Anonymous)
38	00000 days 00:10:44	Successful login through Console (Username: Anonymous)
37	00000 days 00:10:43	Logout through Console (Username: Anonymous)
36	00000 days 00:09:02	Spanning Tree Protocol is disabled
35	00000 days 00:08:58	Configuration saved to flash (Username: Anonymous)
34	00000 days 00:08:36	Successful login through Console (Username: Anonymous)
33	00000 days 00:08:34	Logout through Console (Username: Anonymous)
32	00000 days 00:08:24	Spanning Tree Protocol is disabled
31	00000 days 00:07:44	Spanning Tree Protocol is disabled
30	00000 days 00:07:20	Configuration saved to flash (Username: Anonymous)
29	00000 days 00:06:45	Configuration saved to flash (Username: Anonymous)
28	00000 days 00:05:56	Successful login through Console (Username: Anonymous)
27	00000 days 00:05:53	Logout through Console (Username: Anonymous)
26	00000 days 00:04:48	Spanning Tree Protocol is disabled
25	00000 days 00:04:45	Configuration saved to flash (Username: Anonymous)

Clear Next

**Figure 16- 22. Switch History**

## Switch Utilities

**Download Firmware**

**Download Configuration File**

**Save Settings to TFTP Server**

**Save Switch History to TFTP Server**

**Ping Test**

**BOOTP/DHCP Relay**

**BOOTP/DHCP Relay Interface Configuration**

**DNS Relay**

**DNS Relay Interface Configuration**

## TFTP Services

Trivial File Transfer Protocol (TFTP) services allow the switch firmware to be upgraded by transferring a new firmware file from a TFTP server to the switch. A configuration file can also be loaded into the switch from a TFTP server, switch settings can be saved to the TFTP server, and a history log can be uploaded from the switch to the TFTP server.

### Download Firmware

To update the switch's firmware, click on the Basic Setup folder and then the switch Utilities folder and then the TFTP Services folder and finally click on the Download Firmware from TFTP Server link:

**Figure 17- 1. Download Firmware from Server**

Select which switch of a switch stack you want to update the firmware on. This allows the selection of a particular switch from a switch stack if you have installed the optional stacking module and have properly interconnected the switches.

Enter the IP address of the TFTP server in the **Server IP Address** field.

The TFTP server must be on the same IP subnet as the switch.

Enter the path and the filename to the firmware file on the TFTP server. Note that in the above example, the firmware file is in the root directory of the D drive of the TFTP server. The TFTP server must be running TFTP server software to perform the file transfer. TFTP server software is a part of many network management software packages – such as NetSight, or can be obtained as a separate program.

Click **Download** to record the IP address of the TFTP server. Use the **Save Settings** to enter the address into NV-RAM.

Click **Start** to initiate the file transfer.

### Download Configuration File

To download a configuration file for the switch's, click on the Basic Setup folder and then the switch Utilities folder and then the TFTP Services folder and finally click on the Download Configuration from TFTP Server link:



**Figure 17- 2. Use Configuration File on Server**

Enter the IP address of the TFTP server and specify the location of the switch configuration file on the TFTP server.

Click **Apply** to record the IP address of the TFTP server. Use **Save Changes** from the **Maintenance** menu to enter the address into NV-RAM

Click **Start** to initiate the file transfer.

### Save Settings to Server

To download a configuration file for the switch's, click on the Basic Setup folder and then the switch Utilities folder and then the TFTP Services folder and finally click on the Upload Settings to TFTP Server link:

**Figure 17- 3. Save Settings To TFTP Server**

Enter the IP address of the TFTP server and the path and filename of the settings file on the TFTP server and click **Apply**. Highlight **Start** to initiate the file transfer.

### Save History Log to Server

To download a configuration file for the switch's, click on the Basic Setup folder and then the switch Utilities folder and then the TFTP Services folder and finally click on the Upload history Log to TFTP Server link:

**Figure 17- 4. Save Switch History To TFTP Server**

Enter the IP address of the TFTP server and the path and filename for the history log on the TFTP server. Click **Apply** to make the changes current. Click **Start** to initiate the file transfer.

## Ping Test

Ping is a small program that sends data packets to the IP address you specify. The destination node then returns the packets to the switch. This is very useful to verify connectivity between the switch and other nodes on the network.

**Figure 17- 5. Ping Test Screen**

The **Infinite times** checkbox, in the **Number of Repetitions** field, tells ping to keep sending data packets to the specified IP address until the program is stopped.

## DHCP, BOOTP and DNS Relay

Use DHCP/BOOTP and DNS Relay configuration to allow the Switch to relay DHCP/BOOTP and DNS information packets to hosts that request them from sources outside the interface on which they reside.

### BOOTP/DHCP Relay

---

Enable BOOTP/DHCP relay so that BOOTP/DHCP messages are forwarded.

BOOTP/DHCP Relay Status	Disabled ▾
BOOTP Hops Count Limit	4
BOOTP/DHCP Relay Time Threshold (sec)	0

**Figure 17- 6. DHCP/BOOTP Relay**

The BOOTP Relay Information menu is used to enable BOOTP Relay and configure hops and time limit. Set the relay configuration as desired and click on the **Apply** button. These settings will be applied to all BOOTP/DHCP relays regardless of the destination or source.

The following fields can be set:

Parameter	Description
<b>BOOTP/DHCP Relay Status</b> <Disabled>	This field can be toggled between <i>Enabled</i> and <i>Disabled</i> using the pull-down menu. It is used to enable or disable the BOOTP/DHCP Relay service on the switch. The default is <i>Disabled</i> .
<b>BOOTP HOPS Count Limit</b> [4 ]	This field allows an entry between 1 and 16 to define the maximum number of router hops BOOTP messages can be forwarded across. The default hop count is 4.
<b>BOOTP/DHCP Relay Time Threshold</b> [0 ]	Allows an entry between 0 and 65535 seconds, and defines the maximum time limit for routing a BOOTP/DHCP packet. If a value of 0 is entered, the switch will not process the value in the seconds field of the BOOTP or DHCP packet. If a non-zero value is entered, the switch will use that value, along with the hop count to determine whether to forward a given BOOTP or DHCP packet.

### BOOTP/DHCP Relay Interface Configuration

To configure BOOTP relay for individual IP interfaces, use the DHCP/BOOTP Relay Settings menu.

BOOTP/DHCP Relay Interface Configurations

Specify which interfaces and servers should receive the forwarded messages.

Interface Name	Server 1	Server 2	Server 3	Server 4
----------------	----------	----------	----------	----------

Figure 17- 7. DHCP/BOOTP Relay Settings

To create a new relay configuration, enter the IP interface name you want to configure for DHCP relay and the IP address of the server. Click on the **New** button to enter the relay settings. Up to four servers can be entered for each IP interface.

BOOTP/DHCP Relay Interface Configurations - Add

Interface Name

BOOTP/DHCP Server

Figure 17- 8. BOOT/DHCP Relay Interface Configuration – Add

The information listed in the BOOTP Table is described as follows:

Parameter	Description
<b>Interface</b>	The name of the IP interface in which BOOTP relay is to be enabled.
<b>Server IP</b>	The IP address of the BOOTP or DHCP server.

## DNS Relay

To configure DNS Relay, click on the DNS Relay link:

### DNS Relay

Enable DNS relay so the DNS messages are forwarded.

DNS Relay State	Disabled ▾
Name Server [1]	0 . 0 . 0 . 0
Name Server [2]	0 . 0 . 0 . 0
DNS Relay Cache Status	Disabled ▾
DNS Relay Static Table Lookup Status	Disabled ▾

**Figure 17- 9. DNS Relay**

The DNS Relay Information menu is used to enable DNS Relay and configure IP addresses for available DNS servers. Set the relay configuration as desired and click on the **Apply** button.

The following fields can be set:

Parameter	Description
<b>DNS Relay State</b> <Disabled>	This field can be toggled between <i>Disabled</i> and <i>Enabled</i> using the pull-down menu, and is used to enable or disable the DNS Relay service on the switch.
<b>Name Server (1)</b> <0.0.0.0>	Allows the entry of the IP address of a primary domain name server (DNS).
<b>Name Server (2)</b> <0.0.0.0>	Allows the entry of the IP address of a secondary domain name server (DNS).
<b>DNSR Relay Cache Server Status</b> <Disabled>	This can be toggled between <i>Disabled</i> and <i>Enabled</i> . This determines if a DNS cache will be enabled on the switch.
<b>DNS Relay Static Table Lookup Status</b> <Disabled>	This field can be toggled using the pull-down menu between <i>Disabled</i> and <i>Enabled</i> . This determines if the static DNS table will be used or not.

### DNS Relay Interface Configuration

To configure permanent entries for the DNS Relay Static Table, use the DNS Relay Static Settings menu.

DNS Relay - Static Table Configurations

Specify which servers should receive the forwarded messages.

Total Entries: 0

Domain Name	IP Address	Status
-------------	------------	--------

Figure 17- 10. DNS Relay Static Table Configuration

To create a new DNS Relay Static entry, enter the Domain Name and the associated IP address. Click on the **New** button to enter the settings into the static table.

DNS Relay - Static Table Configurations - Add

Domain Name

IP Address  .  .  .

Figure 17- 11. DNS Relay Static Table Configuration – Add

The following fields can be set:

Parameter	Description
<b>Domain Name</b>	The domain name used for the static entry.
<b>IP Address</b> <0.0.0.0>	The IP address associated with the domain name.

# Chapter 18

## **VLANS AND IP INTERFACES**

VLANS can function somewhat differently in a Layer 3 Switch, that is when the VLANS are Layer 3-based, than if they are strictly based on Layer 2 information. Since IP Switching among VLANS may be unfamiliar to users who are otherwise well acquainted with conventional VLANS used in standard Ethernet Switches, some explanation of VLANS used in Layer 3 Switching is presented below. It is essential to fully grasp this difference to take advantage of the improved efficiency of Layer 3 Switching.

### **VLANS in Layer 2**

In normal 802.1Q VLAN implementation, packets cannot cross VLANS in a Switch that is limited to Layer 2 functions. If a member of one VLAN wants to connect to another VLAN, the link must be through an external router.

### **Layer 3-Based VLANS**

Layer 3-based VLANS use network-layer addresses (subnet address for TCP/IP) to determine VLAN membership. These VLANS are based on layer 3 information, however this does not constitute a 'routing' function.

The DES-3326S Switch allows an IP subnet to be configured for each 802.1Q VLAN that exists on the Switch. That is, a VLAN can be associated or attached to an IP subnet. This represents an improvement in performance since it bypasses any routing functions, packets transferred between subnets are reduced to a "hardware" decision.

Even though a Switch inspects a packet's IP address to determine VLAN membership, no route calculation is performed, the RIP protocol is not employed, and packets traversing the Switch are bridged using the Spanning Tree algorithm.

A Switch that implements layer 3 (or 'subnet') VLANS without performing any routing function between these VLANS is referred to as performing 'IP Switching'.

### **Planning VLAN Layout**

VLANS on the DES-3326S have considerably more functions and are more complex than on a traditional layer 2 Switch, and must therefore be laid-out and configured with a bit more forethought. VLANS with an IP interface assigned to them could be thought of as network links – not just as a collection of associated end users. Further, VLANS assigned an IP network address and subnet mask enables IP routing between them.

VLANS must be configured on the Switch before they can be assigned IP subnets. Furthermore, the static VLAN configuration is specified on a per port basis. On the DES-3326S a VLAN can consist of end-nodes – just like a traditional layer 2 Switch, but a VLAN can also consist of one or more Switches – each of which is connected to multiple end-nodes or network resources.

So, the IP subnets for a network must be determined first, and the VLANS configured on the Switch to accommodate the IP subnets. Finally, the IP subnets can be assigned to the VLANS.

### **Assigning IP Network Addresses and Subnet Masks to VLANS**

The DES-3326S allows the assignment of IP subnets to individual VLANS. This is the fundamental advantage of VLANS in IP Switching.

Developing an IP addressing scheme is a complex subject, but it is sufficient here to mention that the total number of anticipated end nodes – for each IP interface – must be accommodated with a unique IP address. It should be noted that the Switch regards a VLAN with an IP network address and corresponding subnet mask assigned as an IP interface.

## **Understanding 802.1Q VLANS**

This review of 802.1Q VLANS presents some basic background about how VLANS work according to the IEEE 802.1Q standard. VLANS operate according to the same rules regardless of whether the Switching environment is Layer 2 or Layer 3. The difference is primarily that in a Layer 3 Switch there is an added capability of unique association between a VLAN and an IP interface or subnet group.

A VLAN is a collection of end nodes grouped by logic rather than physical location. End nodes that frequently communicate with each other are assigned to the same VLAN, regardless of where they are located physically on the network. Logically, a

VLAN can be equated to a broadcast domain, because broadcast packets are forwarded only to members of the VLAN on which the broadcast was initiated.

### IEEE 802.1Q VLANs

**Some relevant terms:**

**Tagging** - The act of putting 802.1Q VLAN information into the header of a packet.

**Untagging** - The act of stripping 802.1Q VLAN information out of the packet header.

**Ingress port** - A port on a Switch where packets are flowing into the Switch and VLAN decisions must be made.

**Egress port** - A port on a Switch where packets are flowing out of the Switch, either to another Switch or to an end station, and tagging decisions must be made.

IEEE 802.1Q (tagged) VLANs are implemented on the DES-3326S Switch. 802.1Q VLANs require tagging, which enables the VLANs to span an entire network (assuming all Switches on the network are IEEE 802.1Q-compliant).

Any port can be configured as either *tagging* or *untagging*. The *untagging* feature of IEEE 802.1Q VLANs allow VLANs to work with legacy Switches that don't recognize VLAN tags in packet headers. The *tagging* feature allows VLANs to span multiple 802.1Q VLAN compliant Switches through a single physical connection and allows Spanning Tree to be enabled on all ports and work normally.

### 802.1Q VLAN Packet Forwarding

Packet forwarding decisions are made based upon the following three types of rules:

- Ingress rules – rules relevant to the classification of received frames belonging to a VLAN.
- Forwarding rules between ports – decides filter or forward the packet
- Egress rules – determines if the packet must be sent tagged or untagged.

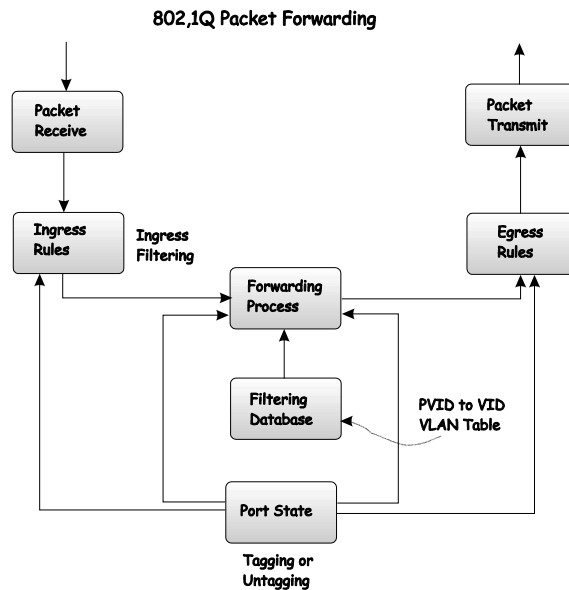

### 802.1Q VLAN Tags

The figure below shows the 802.1Q VLAN tag. There are four additional octets inserted after the source MAC address. Their presence is indicated by a value of 0x8100 in the EtherType field. When a packet's EtherType field is equal to 0x8100, the packet carries the IEEE 802.1Q/802.1p tag. The tag is contained in the following two octets and consists of 3 bits of user priority, 1 bit of Canonical Format Identifier (CFI – used for encapsulating Token Ring packets so they can be carried across Ethernet backbones) and 12 bits of VLAN ID (VID). The 3 bits of user priority are used by 802.1p. The VID is the VLAN identifier and is used by the 802.1Q standard. Because the VID is 12 bits long, 4094 unique VLANs can be identified.

The tag is inserted into the packet header making the entire packet longer by 4 octets. All of the information contained in the packet originally is retained.



IEEE 802.1Q Tag

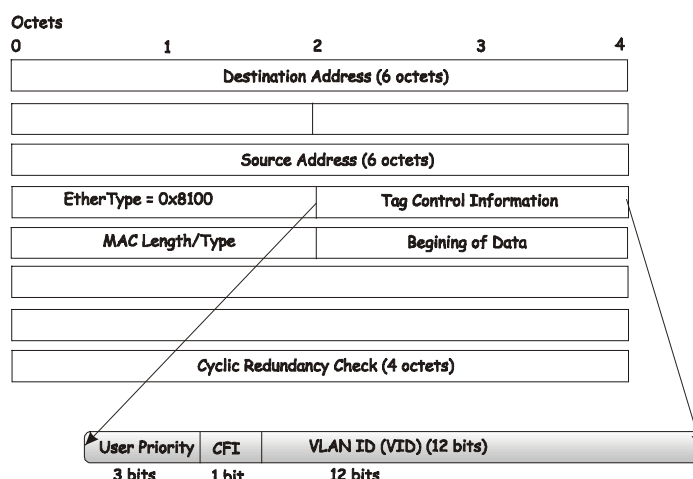

The EtherType and VLAN ID are inserted after the MAC source address, but before the original EtherType/Length or Logical Link Control. Because the packet is now a bit longer than it was originally, the Cyclic Redundancy Check (CRC) must be recalculated.

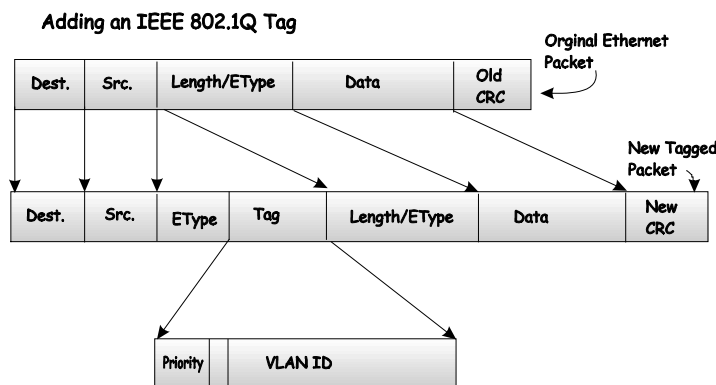

Port VLAN ID

Packets that are tagged (are carrying the 802.1Q VID information) can be transmitted from one 802.1Q compliant network device to another with the VLAN information intact. This allows 802.1Q VLANs to span network devices (and indeed, the entire network – if all network devices are 802.1Q compliant).

Unfortunately, not all network devices are 802.1Q compliant. These devices are referred to as *tag-unaware*. 802.1Q devices are referred to as *tag-aware*.

Prior to the adoption 802.1Q VLANs, port-based and MAC-based VLANs were in common use. These VLANs relied upon a Port VLAN ID (PVID) to forward packets. A packet received on a given port would be assigned that port’s PVID and then be forwarded to the port that corresponded to the packet’s destination address (found in the Switch’s forwarding table). If the PVID of the port that received the packet is different from the PVID of the port that is to transmit the packet, the Switch will drop the packet.

Within the Switch, different PVIDs mean different VLANs. (remember that two VLANs cannot communicate without an external router). So, VLAN identification based upon the PVIDs cannot create VLANs that extend outside a given Switch (or Switch stack).

Every physical port on a Switch has a PVID. 802.1Q ports are also assigned a PVID, for use within the Switch. If no VLANs are defined on the Switch, all ports are then assigned to a default VLAN with a PVID equal to 1. Untagged packets are assigned the PVID of the port on which they were received. Forwarding decisions are based upon this PVID, in so far as VLANs are concerned. Tagged packets are forwarded according to the VID contained within the tag. Tagged packets are also assigned a PVID, but the PVID is not used to make packet forwarding decisions, the VID is.

Tag-aware Switches must keep a table to relate PVIDs within the Switch to VIDs on the network. The Switch will compare the VID of a packet to be transmitted to the VID of the port that is to transmit the packet. If the two VIDs are different, the

Switch will drop the packet. Because of the existence of the PVID for untagged packets and the VID for tagged packets, tag-aware and tag-unaware network devices can coexist on the same network.

A Switch port can have only one PVID, but can have as many VIDs as the Switch has memory in its VLAN table to store them.

Because some devices on a network may be tag-unaware, a decision must be made at each port on a tag-aware device before packets are transmitted – should the packet to be transmitted have a tag or not? If the transmitting port is connected to a tag-unaware device, the packet should be untagged. If the transmitting port is connected to a tag-aware device, the packet should be tagged.

### Tagging and Untagging

Every port on an 802.1Q compliant Switch can be configured as *tagging* or *untagging*.

Ports with tagging enabled will put the VID number, priority and other VLAN information into the header of all packets that flow into and out of it. If a packet has previously been tagged, the port will not alter the packet, thus keeping the VLAN information intact. The VLAN information in the tag can then be used by other 802.1Q compliant devices on the network to make packet forwarding decisions.

Ports with untagging enabled will strip the 802.1Q tag from all packets that flow into and out of those ports. If the packet doesn't have an 802.1Q VLAN tag, the port will not alter the packet. Thus, all packets received by and forwarded by an untagging port will have no 802.1Q VLAN information. (Remember that the PVID is only used internally within the Switch). Untagging is used to send packets from an 802.1Q-compliant network device to a non-compliant network device.

### Ingress Filtering

A port on a Switch where packets are flowing into the Switch and VLAN decisions must be made is referred to as an *ingress port*. If ingress filtering is enabled for a port, the Switch will examine the VLAN information in the packet header (if present) and decide whether or not to forward the packet.

If the packet is tagged with VLAN information, the ingress port will first determine if the ingress port itself is a member of the tagged VLAN. If it is not, the packet will be dropped. If the ingress port is a member of the 802.1Q VLAN, the Switch then determines if the destination port is a member of the 802.1Q VLAN. If it is not, the packet is dropped. If the destination port is a member of the 802.1Q VLAN, the packet is forwarded and the destination port transmits it to its attached network segment.

If the packet is not tagged with VLAN information, the ingress port will tag the packet with its own PVID as a VID (if the port is a tagging port). The Switch then determines if the destination port is a member of the same VLAN (has the same VID) as the ingress port. If it does not, the packet is dropped. If it has the same VID, the packet is forwarded and the destination port transmits it on its attached network segment.

This process is referred to as *ingress filtering* and is used to conserve bandwidth within the Switch by dropping packets that are not on the same VLAN as the ingress port at the point of reception. This eliminates the subsequent processing of packets that will just be dropped by the destination port.

# Chapter 19

## Configure VLANs

### Configure 802.1Q Static VLANs

#### 802.1Q Port Settings

#### Switch GVRP

This chapter describes how to use the web manager to configure VLANs in the Switch. If you are not familiar with using VLANs on a Layer 3 Switch, it would be a good idea to read the previous section. All the menus needed to create and configure VLANs are located in their own subdirectory in the **Advanced Setup** folder.



**NOTE:** The Switch allows the assignment of an IP interface to each VLAN, in IP Routing mode. The VLANs must be configured prior to setting up the IP interfaces.

### Configure 802.1Q Static VLANs

The VLAN menu adds an entry to edit the VLAN definitions and to configure the port settings for IEEE 802.1Q VLAN support. Go to the **Advanced Setup** folder, open the **VLAN Configurations** subdirectory, and click the **802.1Q VLANs** link to open the following dialog box:

### 802.1Q VLANs

Configure 802.1Q VLANs by assigning ports a membership status.  
Tagged ports can belong to more than one 802.1Q VLAN.

Total Entries: 1

	VLAN ID (VID)	VLAN Name	Advertisement	Members					
				1	2	3	4	5	6
<input type="radio"/>	1	default	Enabled	Unit 1	UUUUUUUU	UUUUUUUU	UUUUUUUU	U	U

**Figure 19- 1. 802.1Q VLANs**

To delete an existing 802.1Q VLAN, click the corresponding click-box to the left of the VLAN you want to delete from the switch and then click the **Delete** button.

To create a new 802.1Q VLAN, click the **New** button and configure membership for the VLAN in the **802.1Q VLANs Add** menu.

## 802.1Q VLANs - Add

VLAN ID (VID)	<input type="text"/>	<input type="checkbox"/>	Auto Assign
VLAN Name	<input type="text"/>		
Advertisement	Enabled ▾		

Unit	1 ▾																										
Port	1	2	3	4	5	6	7	8	9	10	11	12	13	14	15	16	17	18	19	20	21	22	23	24	25	26	
Non-member	<input type="radio"/>	<input type="radio"/>	<input type="radio"/>	<input type="radio"/>	<input type="radio"/>	<input type="radio"/>	<input type="radio"/>	<input type="radio"/>	<input type="radio"/>	<input type="radio"/>	<input type="radio"/>	<input type="radio"/>	<input type="radio"/>	<input type="radio"/>	<input type="radio"/>	<input type="radio"/>	<input type="radio"/>	<input type="radio"/>	<input type="radio"/>	<input type="radio"/>	<input type="radio"/>	<input type="radio"/>	<input type="radio"/>	<input type="radio"/>	<input type="radio"/>	<input type="radio"/>	<input type="radio"/>
Tagged	<input type="radio"/>	<input type="radio"/>	<input type="radio"/>	<input type="radio"/>	<input type="radio"/>	<input type="radio"/>	<input type="radio"/>	<input type="radio"/>	<input type="radio"/>	<input type="radio"/>	<input type="radio"/>	<input type="radio"/>	<input type="radio"/>	<input type="radio"/>	<input type="radio"/>	<input type="radio"/>	<input type="radio"/>	<input type="radio"/>	<input type="radio"/>	<input type="radio"/>	<input type="radio"/>	<input type="radio"/>	<input type="radio"/>	<input type="radio"/>	<input type="radio"/>	<input type="radio"/>	<input type="radio"/>
Untagged	<input type="radio"/>	<input type="radio"/>	<input type="radio"/>	<input type="radio"/>	<input type="radio"/>	<input type="radio"/>	<input type="radio"/>	<input type="radio"/>	<input type="radio"/>	<input type="radio"/>	<input type="radio"/>	<input type="radio"/>	<input type="radio"/>	<input type="radio"/>	<input type="radio"/>	<input type="radio"/>	<input type="radio"/>	<input type="radio"/>	<input type="radio"/>	<input type="radio"/>	<input type="radio"/>	<input type="radio"/>	<input type="radio"/>	<input type="radio"/>	<input type="radio"/>	<input type="radio"/>	<input type="radio"/>
Forbidden	<input type="radio"/>	<input type="radio"/>	<input type="radio"/>	<input type="radio"/>	<input type="radio"/>	<input type="radio"/>	<input type="radio"/>	<input type="radio"/>	<input type="radio"/>	<input type="radio"/>	<input type="radio"/>	<input type="radio"/>	<input type="radio"/>	<input type="radio"/>	<input type="radio"/>	<input type="radio"/>	<input type="radio"/>	<input type="radio"/>	<input type="radio"/>	<input type="radio"/>	<input type="radio"/>	<input type="radio"/>	<input type="radio"/>	<input type="radio"/>	<input type="radio"/>	<input type="radio"/>	<input type="radio"/>

Back
Apply

**Figure 19- 2. 802.1Q Static VLANs Entry Settings – Add**

To edit an existing 802.1Q VLAN, click the corresponding click-box and then click the **Edit** button to open the following dialog box:

## 802.1Q VLANs - Edit

VLAN ID (VID)	1		
VLAN Name	default		
Advertisement	Enabled ▾		

Unit	1 ▾																										
Port	1	2	3	4	5	6	7	8	9	10	11	12	13	14	15	16	17	18	19	20	21	22	23	24	25	26	
Non-member	<input type="radio"/>	<input type="radio"/>	<input type="radio"/>	<input type="radio"/>	<input type="radio"/>	<input type="radio"/>	<input type="radio"/>	<input type="radio"/>	<input type="radio"/>	<input type="radio"/>	<input type="radio"/>	<input type="radio"/>	<input type="radio"/>	<input type="radio"/>	<input type="radio"/>	<input type="radio"/>	<input type="radio"/>	<input type="radio"/>	<input type="radio"/>	<input type="radio"/>	<input type="radio"/>	<input type="radio"/>	<input type="radio"/>	<input type="radio"/>	<input type="radio"/>	<input type="radio"/>	<input type="radio"/>
Tagged	<input type="radio"/>	<input type="radio"/>	<input type="radio"/>	<input type="radio"/>	<input type="radio"/>	<input type="radio"/>	<input type="radio"/>	<input type="radio"/>	<input type="radio"/>	<input type="radio"/>	<input type="radio"/>	<input type="radio"/>	<input type="radio"/>	<input type="radio"/>	<input type="radio"/>	<input type="radio"/>	<input type="radio"/>	<input type="radio"/>	<input type="radio"/>	<input type="radio"/>	<input type="radio"/>	<input type="radio"/>	<input type="radio"/>	<input type="radio"/>	<input type="radio"/>	<input type="radio"/>	<input type="radio"/>
Untagged	<input checked="" type="radio"/>	<input checked="" type="radio"/>	<input checked="" type="radio"/>	<input checked="" type="radio"/>	<input checked="" type="radio"/>	<input checked="" type="radio"/>	<input checked="" type="radio"/>	<input checked="" type="radio"/>	<input checked="" type="radio"/>	<input checked="" type="radio"/>	<input checked="" type="radio"/>	<input checked="" type="radio"/>	<input checked="" type="radio"/>	<input checked="" type="radio"/>	<input checked="" type="radio"/>	<input checked="" type="radio"/>	<input checked="" type="radio"/>	<input checked="" type="radio"/>	<input checked="" type="radio"/>	<input checked="" type="radio"/>	<input checked="" type="radio"/>	<input checked="" type="radio"/>	<input checked="" type="radio"/>	<input checked="" type="radio"/>	<input checked="" type="radio"/>	<input checked="" type="radio"/>	<input checked="" type="radio"/>
Forbidden	<input type="radio"/>	<input type="radio"/>	<input type="radio"/>	<input type="radio"/>	<input type="radio"/>	<input type="radio"/>	<input type="radio"/>	<input type="radio"/>	<input type="radio"/>	<input type="radio"/>	<input type="radio"/>	<input type="radio"/>	<input type="radio"/>	<input type="radio"/>	<input type="radio"/>	<input type="radio"/>	<input type="radio"/>	<input type="radio"/>	<input type="radio"/>	<input type="radio"/>	<input type="radio"/>	<input type="radio"/>	<input type="radio"/>	<input type="radio"/>	<input type="radio"/>	<input type="radio"/>	<input type="radio"/>

Back
Apply

**Figure 19- 3. 802.1Q Static VLANs Entry Settings – Edit**

See below for a description of VLAN parameters.

The following fields can then be set in either the **Add** or **Edit** dialog boxes:

Parameter	Description
<b>Unit</b>	Choose the Switch that the VLAN will be created on.
<b>VID (VLAN ID)</b>	Allows the entry of a VLAN ID in the Add dialog box, or displays the VLAN ID of an existing VLAN in the Edit dialog box. VLANs can be identified by either the VID or the VLAN name. The Auto Assign click box will instruct the switch to assign VLAN IDs – in ascending numerical order starting with 1 – to each VLAN as it is created.
<b>VLAN Name</b>	Allows the entry of a name for the new VLAN in the Add dialog box, or for editing the VLAN name in the Edit dialog box.
<b>Advertisement</b>	Advertising can be enabled or disabled using this pull-down menu. Advertising allows members to join this VLAN through GVRP.
<b>Port</b>	Allows an individual port to be specified as member of a VLAN.
<b>Tagged</b>	Allows an individual port to be specified as Tagging. A Check in the Tagged field specifies the port as a Tagging member of the VLAN. When an untagged packet is transmitted by the port, the packet header is changed to include the 32-bit tag associated with the VID (VLAN Identifier – see below). When a tagged packet exits the port, the packet header is unchanged.
<b>Untagged</b>	Allows an individual port to be specified as Untagged. When an untagged packet is transmitted by the port, the packet header remains unchanged. When a tagged packet exits the port, the tag is stripped and the packet is changed to an untagged packet.
<b>Egress</b>	Egress Member - specifies the port as being a static member of the VLAN. Egress Member Ports are ports that will be transmitting traffic for the VLAN. These ports can be either tagged or untagged.
<b>Forbidden</b>	Forbidden Non-Member - specifies the port as not being a member of the VLAN and that the port is forbidden from becoming a member of the VLAN dynamically.

## 802.1Q Port Settings

The **Port VLAN ID (PVID)** menu, shown below, allows you to determine whether the switch will share its VLAN configuration information with other GARP VLAN Registration Protocol (GVRP) enabled switches. In addition, **Ingress Checking** can be used to limit traffic by filtering incoming packets whose PVID does not match the PVID of the port.

**Port VLAN ID (PVID)**

Configure whether the switch can exchange VLAN configuration information with other GVRP enabled switches.

If the Enable Ingress Filtering parameter for a given Port is set, the Ingress rules shall discard any frame received on that Port whose VLAN classification does not include that Port in its Member set.

Port	PVID	GVRP	Ingress Checking
1	1	Disabled	Enabled
2	1	Disabled	Enabled
3	1	Disabled	Enabled
4	1	Disabled	Enabled
5	1	Disabled	Enabled
6	1	Disabled	Enabled
7	1	Disabled	Enabled
8	1	Disabled	Enabled
9	1	Disabled	Enabled
10	1	Disabled	Enabled
11	1	Disabled	Enabled
12	1	Disabled	Enabled
13	1	Disabled	Enabled
14	1	Disabled	Enabled
15	1	Disabled	Enabled
16	1	Disabled	Enabled
17	1	Disabled	Enabled
18	1	Disabled	Enabled
19	1	Disabled	Enabled
20	1	Disabled	Enabled
21	1	Disabled	Enabled
22	1	Disabled	Enabled
23	1	Disabled	Enabled
24	1	Disabled	Enabled
25	1	Disabled	Enabled
26	0	Enabled	Disabled

Apply

**Figure 19- 4. Port VLAN ID (PVID)**

The following fields can then be set:

Parameter	Description
<b>Unit</b>	Choose the Switch that the VLAN will be created on.
<b>PVID</b>	A Port VLAN Identifier is a classification mechanism that associates a port with a specific VLAN and is used to make forwarding decisions for untagged packets received by the port. For example, if port #2 is assigned a PVID of 3, then all untagged packets received on port #2 will be assigned to VLAN 3. This number is generally the same as the VID# number assigned to the port in the Edit 802.1Q VLANs menu above.
<b>GVRP &lt;Disabled&gt;</b>	The Group VLAN Registration Protocol (GVRP) enables the port to dynamically become a member of a VLAN.
<b>Ingress &lt;Enabled&gt;</b> <b>Checking</b>	This field can be toggled using the space bar between <i>Enabled</i> and <i>Disabled</i> . <i>Enabled</i> enables the port to compare the VID tag of an incoming packet with the PVID number assigned to the port. If the two are different, the port filters (drops) the packet. <i>Disabled</i> disables Ingress filtering.

## Switch GVRP

To enable GVRP for the Switch, access the **Switch GVRP** menu in the **VLAN Configurations** folder, select *Enabled* from the drop-down menu and click on the **Apply** button. GVRP may be disabled universally without changing any of the per-port GVRP settings so they do not have to be reconfigured if Switch GVRP is enabled later.

### Switch GVRP

---

Enable or disable ports from dynamically joining VLANs.  
When GVRP is disabled, only statically configured ports can be members of a VLAN.

Switch GVRP

**Figure 19- 5. – Switch GVRP**

# Chapter 20

## IP Interface Configuration

To configure IP interfaces, first set up VLANs, then access the **IP Interface Settings** menu located in the **Layer 3 - IP Networking** subdirectory of the **Advanced Setup** folder.

### Set Up IP Interfaces

Each VLAN must be configured prior to setting up the VLAN's corresponding IP interface.

An example is presented below:

**Table 3. VLAN Example – Assigned Ports**

VLAN Name	VID	Switch Ports
System (default)	1	5, 6, 7, 8, 21, 22, 23, 24
Engineer	2	9, 10, 11, 12
Marketing	3	13, 14, 15, 16
Finance	4	17, 18, 19, 20
Sales	5	1, 2, 3, 4
Backbone	6	25, 26

In this case, 6 IP interfaces are required, so a CIDR notation of 10.32.0.0/11 (or a 11-bit) addressing scheme will work. This addressing scheme will give a subnet mask of 11111111.11100000.00000000.00000000 (binary) or 255.224.0.0 (decimal).

Using a 10.xxx.xxx.xxx IP address notation, the above example would give 6 network addresses and 6 subnets.

Any IP address from the allowed range of IP addresses for each subnet can be chosen as an IP address for an IP interface on the switch.

For this example, we have chosen the next IP address above the network address for the IP interface's IP Address:

**Table 4. VLAN Example – Assigned IP Interfaces**

VLAN Name	VID	Network Number	IP Address
System (default)	1	10.32.0.0	10.32.0.1
Engineer	2	10.64.0.0	10.64.0.1
Marketing	3	10.96.0.0	10.96.0.1
Finance	4	10.128.0.0	10.128.0.1
Sales	5	10.160.0.0	10.160.0.1
Backbone	6	10.192.0.0	10.192.0.1

The 6 IP interfaces, each with an IP address (listed in the table above), and a subnet mask of 255.224.0.0 can be entered into the **Setup IP Interface** window.

To setup IP Interfaces on the switch:

Go to the **Advanced Setup** folder, and click on the **Layer 3 IP Networking** link, and then click on the **Setup IP Interfaces** link to open the following dialog box:



### IP Interface Settings

Configure an IP interface for each existing 802.1Q VLAN.

Total Entries: 1

	Interface Name	IP Address	Subnet Mask	VLAN Name	Active	Members
<input type="radio"/>	System	10.42.73.10	255.0.0.0	default	Yes	Unit 1 M

**Figure 20- 1. Setup IP Interface**

To setup an new IP interface, click the New button:

### IP Interface Settings - Add

Interface Name	<input style="width: 95%;" type="text"/>
IP Address	<input type="text" value="0"/> . <input type="text" value="0"/> . <input type="text" value="0"/> . <input type="text" value="0"/>
Subnet Mask	<input type="text" value="0"/> . <input type="text" value="0"/> . <input type="text" value="0"/> . <input type="text" value="0"/>
VLAN Name	<input style="width: 95%;" type="text"/>
Active	<input type="button" value="Yes"/> <input type="button" value="No"/>

Switch	<input type="button" value="1"/> <input type="button" value="2"/>
Port	<input type="text" value="1"/> <input type="text" value="2"/> <input type="text" value="3"/> <input type="text" value="4"/> <input type="text" value="5"/> <input type="text" value="6"/> <input type="text" value="7"/> <input type="text" value="8"/> <input type="text" value="9"/> <input type="text" value="10"/> <input type="text" value="11"/> <input type="text" value="12"/> <input type="text" value="13"/> <input type="text" value="14"/> <input type="text" value="15"/> <input type="text" value="16"/> <input type="text" value="17"/> <input type="text" value="18"/> <input type="text" value="19"/> <input type="text" value="20"/> <input type="text" value="21"/> <input type="text" value="22"/> <input type="text" value="23"/> <input type="text" value="24"/> <input type="text" value="25"/> <input type="text" value="26"/>
Member	<input type="checkbox"/> <input type="checkbox"/> <input type="checkbox"/> <input type="checkbox"/> <input type="checkbox"/> <input type="checkbox"/> <input type="checkbox"/> <input type="checkbox"/> <input type="checkbox"/> <input type="checkbox"/> <input type="checkbox"/> <input type="checkbox"/> <input type="checkbox"/> <input type="checkbox"/> <input type="checkbox"/> <input type="checkbox"/> <input type="checkbox"/> <input type="checkbox"/> <input type="checkbox"/> <input type="checkbox"/> <input type="checkbox"/> <input type="checkbox"/> <input type="checkbox"/> <input type="checkbox"/> <input type="checkbox"/> <input type="checkbox"/> <input type="checkbox"/>

**Figure 20- 2. Setup IP Interface – Add**

To edit an existing IP interface, click on the Edit button:

### IP Interface Settings - Edit

Interface Name	System
IP Address	10 . 42 . 73 . 10
Subnet Mask	255 . 0 . 0 . 0
VLAN Name	default
Active	Yes

Switch	1
Port	1 2 3 4 5 6 7 8 9 10 11 12 13 14 15 16 17 18 19 20 21 22 23 24 25 26
Member	<input checked="" type="checkbox"/> <input checked="" type="checkbox"/> <input checked="" type="checkbox"/> <input checked="" type="checkbox"/> <input checked="" type="checkbox"/> <input checked="" type="checkbox"/> <input checked="" type="checkbox"/> <input checked="" type="checkbox"/> <input checked="" type="checkbox"/> <input checked="" type="checkbox"/> <input checked="" type="checkbox"/> <input checked="" type="checkbox"/> <input checked="" type="checkbox"/> <input checked="" type="checkbox"/> <input checked="" type="checkbox"/> <input checked="" type="checkbox"/> <input checked="" type="checkbox"/> <input checked="" type="checkbox"/> <input checked="" type="checkbox"/> <input checked="" type="checkbox"/> <input checked="" type="checkbox"/> <input checked="" type="checkbox"/> <input checked="" type="checkbox"/> <input checked="" type="checkbox"/> <input checked="" type="checkbox"/>

Back
Apply

**Figure 20- 3. Setup IP Interface – Edit**

Choose a name for the interface to be added and enter it in the **Interface Name** field (if you are editing an IP Interface, the **Interface Name** will already be in the top field as seen in the window above). Enter the interface's IP address and subnet mask in the corresponding fields. Pull the **Active** pull-down menu to *Yes* and click **Apply** to enter to make the IP interface effective. Use the **Save Changes** dialog box from the **Basic Setup** folder to enter the changes into NV-RAM.

The following fields can be set:

Parameter	Description
<b>Interface Name</b>	This field displays the name for the IP interface. The default IP interface is named "System".
<b>IP Address</b>	Enter an IP address to be assigned to this IP interface.
<b>Subnet Mask</b>	Enter a subnet mask to be applied to this IP interface.
<b>VLAN Name</b>	Enter the VLAN Name for the VLAN the IP interface belongs to. The VLAN name must match the existing
<b>Active &lt;Yes&gt;</b>	This field is toggled between <i>Yes</i> and <i>No</i> using the space bar. This entry determines whether the interface will be active or not.
<b>Switch</b>	This drop-down menu allows the selection of an individual switch from a switch stack, if you have the optional stacking module and have properly interconnected the switches in the stack.
<b>Port/Member</b>	Specify which of the ports on the Switch will be a member of this VLAN.

# Multicast Routing Configuration

## ***Multicast Global Configurations***

### ***IGMP Snooping Settings***

### ***IGMP Interface Configurations***

### ***DVMRP Interface Configuration***

### ***PIM-DM Settings***

Controlling Multicast Routing on the Switch includes setting up IGMP for IP interfaces, PIM and DVMRP. This chapter describes how to set these up. For an explanation of how these protocols function, read Appendix C.

The functions supporting IP multicasting are added located in the **IP Multicast Routing Protocols** subdirectory in the **Layer 3 IP Networking** folder.

## **Multicast Global Configurations**

**IGMP Snooping**, **DVMRP**, and **PIM-DM** can be *enabled* or *disabled* on the switch without changing the individual protocol's configuration.

To enable or disable IGMP Snooping, DVMRP, and PIM-DM globally on the switch:

From the **Layer 3 IP Networking** folder, click on the **IP Multicast Routing Protocols** link and then click on the **Multicast Global Configurations** link to open the following dialog box:

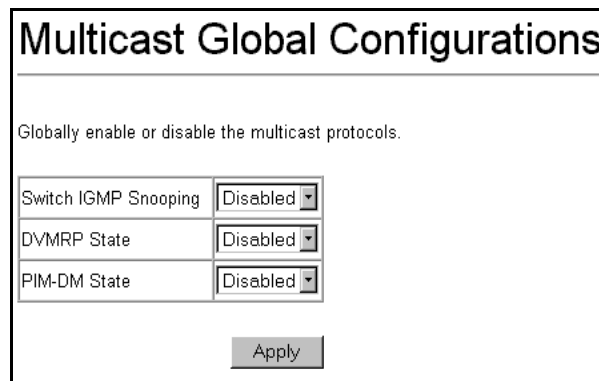

Multicast Global Configurations	
Globally enable or disable the multicast protocols.	
Switch IGMP Snooping	Disabled ▾
DVMRP State	Disabled ▾
PIM-DM State	Disabled ▾
Apply	

**Figure 21- 1. Multicast Global Configurations**

**IGMP Snooping**, **DVMRP**, and **PIM-DM** routing protocols can be individually enabled or disabled, globally on the switch – without changing the individual protocol's configuration from the above window.

## IGMP Snooping Settings

To configure IGMP Snooping, click the **IGMP Snooping Configurations** to open the following menu:

### IGMP Snooping Configurations

Configure Internet Group Management Protocol snooping for an existing VLAN.

VLAN Name	Query Interval	Max Response Time	Robustness Variable	Last Member Query Interval	Querier State
<input type="radio"/> default	125	10	2	1	Disabled

Querier Setting Behavior	Host Timeout	Host Leave Timer	Route Timeout	State
Non-Querier	260	2	260	Disabled

**Figure 21- 2. IGMP Snooping Configuration**

To edit an IGMP Snooping entry on the switch, select the entry on the IGMP Snooping Configurations screen and then click the **Edit** button:

### IGMP Snooping Configurations - Edit

VLAN Name	default
Query Interval (1 - 65535)	<input type="text" value="125"/>
Max Response (1 - 25)	<input type="text" value="10"/>
Robustness Variable (1 - 255)	<input type="text" value="2"/>
Last Member Query Interval (1 - 25)	<input type="text" value="1"/>
Querier State	Disabled ▾
Host Timeout (1 - 16711450)	<input type="text" value="260"/>
Host Leave Timer (0 - 16711450)	<input type="text" value="2"/>
Route Timeout (1 - 16711450)	<input type="text" value="260"/>
State	Disabled ▾

**Figure 21- 3. IGMP Snooping Configuration**

The following fields can be set:

Parameter	Description
<b>VLAN Name</b>	Allows the entry of the name of the VLAN for which IGMP Snooping is to be configured.
<b>Query Interval</b>	Allows the entry of a value between 1 and 65500 seconds, with a default of 125 seconds. This specifies the length of time between sending IGMP queries.
<b>Max Response</b>	Sets the maximum amount of time allowed before sending an IGMP response report. A value between 1 and 25 seconds can be entered, with a default of 10 seconds.
<b>Robustness Variable</b>	A tuning variable to allow for sub-networks that are expected to lose a large number of packets. A value between 2 and 255 can be entered, with larger values being specified for sub-networks that are expected to lose larger numbers of packets.
<b>Last Member Query Interval</b>	Specifies the maximum amount of time between group-specific query messages, including those sent in response to leave group messages. The default is 1 second.
<b>Querier State</b>	This field can be switched using the pull-down menu between <i>Disabled</i> and <i>Enabled</i> .
<b>Host Timeout</b>	Specifies the maximum amount of time a host can be a member of a multicast group without the switch receiving a host membership report. The default is 260 seconds.
<b>Host Leave Timer</b>	Specifies the maximum amount of time between the switch receiving a leave group message from a host, and the switch issuing a group membership query. If the switch does not receive a response from the group membership query before the Host Leave Timer expires, the host address is deleted from the switch's forwarding table. The default is 2 seconds.
<b>Route Timeout</b>	Specifies the maximum amount of time a route will remain in the switch's forwarding table without receiving a membership report. The default is 260 seconds.
<b>State &lt;Disabled&gt;</b>	This field can be switched using the pull-down menu between <i>Disabled</i> and <i>Enabled</i> . This is used to enable or disable IGMP Snooping for the specified VLAN.

## IGMP Interface Configuration

IGMP for IP interfaces function the same way they do for individual ports or VLANs in Layer 2. Most of the parameters are the same as well, except instead of configuring for VLANs you are setting up IGMP for different subnets (IP interfaces).

To configure an IGMP Interface on the switch, click on the IGMP Interface Configuration link under the IP Multicast Routing Protocols folder:

### IGMP Interface Configuration

Configure Internet Group Management Protocol for an existing IP interface.

	Interface Name	IP Address	Version	Query	Max Response	Robustness Var	State
<input type="radio"/>	System	10.42.73.10	2	125	10	2	Disabled

**Figure 21- 4. IGMP Interface Setup**

The Internet Group Multicasting Protocol (IGMP) can be configured on the switch on a per-IP interface basis. Each IP interface configured on the switch is displayed in the above **IGMP Interface Configuration** dialog box. To configure IGMP for a particular interface, click the corresponding click-box for that IP interface and click the **Edit** button. This will open the following dialog box:

### IGMP Interface Configuration - Edit

Interface Name	System
IP Address	10.42.73.10
Version	2
Query Interval (1 - 65535)	125
Max Response Time (1 - 25)	10
Robustness Variable (1 - 255)	2
State	Disabled

**Figure 21- 5. IGMP Interface Configuration – Edit**

This dialog box allows the configuration of IGMP for each IP interface configured on the switch. IGMP can be configured as Version 1 or 2 by toggling the **Version** field using the pull-down menu. The length of time between queries can be varied by entering a value between 1 and 65,500 seconds in the **Query Interval** field. The maximum length of time between the receipt of a query and the sending of an IGMP response report can be varied by entering a value in the **Max Response Time** field.



**NOTE:** The **Robustness Variable** field allows IGMP to be ‘tuned’ for sub-networks that are expected to lose many packets. A high value (max. 255) for the robustness variable will help compensate for ‘lossy’ sub-networks. A low value (min. 2) should be used for less ‘lossy’ sub-networks.

The following fields can be set for IGMP Interfaces:

Parameter	Description
<b>Interface Name</b> <System>	Displays the name of the IP interface that is to be configured for IGMP. This must be a previously configured IP interface.
<b>IP Address</b>	Displays the IP address corresponding to the IP interface name above.
<b>Version</b> <2>	Enter the IGMP version (1 or 2) that will be used to interpret IGMP queries on the interface.
<b>Query Interval</b> <125>	Allows the entry of a value between 1 and 65535 seconds, with a default of 125 seconds. This specifies the length of time between sending IGMP queries.
<b>Max Response Time</b> <10>	Sets the maximum amount of time allowed before sending an IGMP response report. A value between 1 and 25 seconds can be entered, with a default of 10 seconds.
<b>Robustness Variable</b> <2>	A tuning variable to allow for subnetworks that are expected to lose a large number of packets. A value between 2 and 255 can be entered, with larger values being specified for subnetworks that are expected to lose larger numbers of packets.

---

## DVMRP Interface Configuration

To configure DVMRP for an IP interface, Click the DVMRP Interface Configurations link from the IP Multicast Routing Protocols folder:

### DVMRP Interface Configuration

Configure the Distance Vector Multicast Routing Protocol for an existing IP interface.

	Interface Name	IP Address	Neighbor Timeout Interval	Probe Interval	Metric	State
<input type="radio"/>	System	10.42.73.10	35	10	1	Disabled

Figure 21- 6. DVMRP Interface Configuration

### DVMRP Interface Configuration - Edit

Interface Name	System
IP Address	10.42.73.10
Neighbor Timeout Interval (1 - 65535 sec.)	<input style="width: 50px;" type="text" value="35"/>
Probe Interval (1 - 65535 sec.)	<input style="width: 50px;" type="text" value="10"/>
Metric (1 - 31)	<input style="width: 50px;" type="text" value="1"/>
State	<input style="width: 50px;" type="text" value="Disabled"/>

Figure 21- 7. DVMRP Interface Configuration – Edit

This menu allows the Distance-Vector Multicast Routing Protocol to be configured for each IP interface defined on the switch. The Distance Vector Multicast Routing Protocol (**DVMRP**) is a hop-based method of building multicast delivery trees from multicast sources to all nodes of a network. Because the delivery trees are ‘pruned’ and ‘shortest path’, DVMRP is relatively efficient. Because multicast group membership information is forwarded by a distance-vector algorithm, propagation is slow. DVMRP is optimized for high delay (high latency) relatively low bandwidth networks, and can be considered as a ‘best-effort’ multicasting protocol.

DVMRP resembles the Routing Information Protocol (RIP), but is extended for multicast delivery. It relies upon RIP hop counts to calculate ‘shortest paths’ back to the source of a multicast message, but defines a ‘route cost’ to calculate which branches of a multicast delivery tree should be ‘pruned’ – once the delivery tree is established.

When a sender initiates a multicast, DVMRP initially assumes that all users on the network will want to receive the multicast message. When an adjacent router receives the message, it checks its unicast routing table to determine the interface that gives the shortest path (lowest cost) back to the source. If the multicast was received over the shortest path, then the adjacent router enters the information into its tables and forwards the message. If the message is not received on the shortest path back to the source, the message is dropped.

Route cost is a relative number that is used by DVMRP to calculate which branches of a multicast delivery tree should be ‘pruned’. The ‘cost’ is relative to other costs assigned to other DVMRP routes throughout the network.

The higher the route cost, the lower the probability that the current route will be chosen to be an active branch of the multicast delivery tree (not ‘pruned’) – if there is an alternative route.



The following fields for DVMRP can be set:

Parameter	Description
<b>Interface Name</b> <System>	Displays the name of the IP interface for which DVMRP is to be configured. This must be a previously defined IP interface.
<b>IP Address</b>	Displays the IP address corresponding to the IP Interface name entered above.
<b>Probe Interval</b> <10>	This field allows an entry between 0 and 65,535 seconds and defines the interval between 'probes'. The default is 10.
<b>Neighbor Timeout Interval</b> <35>	This field allows an entry between 1 and 65,535 seconds and defines the time period for DVMRP will hold Neighbor Router reports before issuing poison route messages. The default is 35 seconds.
<b>Metric</b> <1>	This field allows an entry between 1 and 31 and defines the route cost for the IP interface. The DVMRP route cost is a relative number that represents the real cost of using this route in the construction of a multicast delivery tree. It is similar to, but not defined as, the hop count in RIP. The default cost is 1.
<b>State</b> <Disabled>	This field can be toggled between <i>Enabled</i> and <i>Disabled</i> and enables or disables DVMRP for the IP interface. The default is <i>Disabled</i> .

## PIM-DM Settings

For a description of how Protocol Independent Multicast-Dense Mode (PIM-DM) functions, please read Appendix C.

The PIM-DM settings menu links are located in the **PIM-DM** subdirectory located in the **Layer 3 IP Networking** configuration folder.

The Protocol Independent Multicast – Dense Mode (PIM-DM) protocol should be used in networks with a low delay (low latency) and high bandwidth as PIM-DM is optimized to guarantee delivery of multicast packets, not to reduce overhead.

The PIM-DM multicast routing protocol assumes that all downstream routers want to receive multicast messages and relies upon explicit prune messages from downstream routers to remove branches from the multicast delivery tree that do not contain multicast group members.

PIM-DM has no explicit 'join' messages. It relies upon periodic flooding of multicast messages to all interfaces and then either waiting for a timer to expire (the **Join/Prune Interval**) or for the downstream routers to transmit explicit 'prune' messages indicating that there are no multicast members on their respective branches. PIM-DM then removes these branches ('prunes' them) from the multicast delivery tree.

Because a member of a pruned branch of a multicast delivery tree may want to join a multicast delivery group (at some point in the future), the protocol periodically removes the 'prune' information from its database and floods multicast messages to all interfaces on that branch. The interval for removing 'prune' information is the **Join/Prune Interval**.

To configure PIMDM for an IP interface, click the PIMDM Interface Configuration link under the IP Multicast Routing Protocols folder:

### PIM-DM Interface Configurations

Configure the Protocol Independent Multicast - Dense Mode protocol for an existing IP interface.

	Interface Name	IP Address	Hello Interval	Join/Prune Interval	State
<input type="radio"/>	System	10.42.73.10	30	60	Disabled

**Figure 21- 8. PIM-DM Interface Configuration**

The Protocol Independent Multicast – Dense Mode (PIM-DM) protocol can be individually configured for each IP interface on the switch. The **PIM-DM Interface Configurations** dialog box will display all of the IP interfaces currently configured on the switch.

To configure PIM-DM for a given IP Interface, click the corresponding click-box and then click the Edit button:

### PIM-DM Interface Configurations - Edit

Interface Name	System
IP Address	10.42.73.10
Hello Interval (1 - 18724 sec.)	<input type="text" value="30"/>
Join-Prune Interval (1 - 18724 sec.)	<input type="text" value="60"/>
State	Disable ▾

**Figure 21- 9. PIM-DM Interface Configuration – Edit**

Configure these parameters for PIM-DM interfaces:

Parameter	Description
<b>Interface Name</b>	Allows the entry of the name of the IP interface for which PIM-DM is to be configured. This must be a previously defined IP interface.
<b>IP Address</b>	Displays the IP address for the IP interface named above.
<b>Hello Interval &lt;30&gt;</b>	This field allows an entry of between 0 and 18724 seconds and determines the interval between sending Hello packets to other routers on the network. The default is 30 seconds.
<b>Join/Prune Interval &lt;60 &gt;</b>	This field allows an entry of between 0 and 18724 seconds. This interval also determines the time interval the router uses to automatically remove prune information from a branch of a multicast delivery tree and begin to flood multicast messages to all branches of that delivery tree. These two actions are equivalent. The default is 60 seconds.
<b>State &lt;Disabled&gt;</b>	This field can be toggled between <i>Enabled</i> and <i>Disabled</i> using the pull-down menu, and is used to enable or disable PIM-DM for the IP interface. The default is <i>Disabled</i> .

## Static Route, Static ARP and RIP Configuration

### Configure Static Routes

### Configure Static ARP

### Routing Information Protocol (RIP) Configuration

This chapter describes how to configure static routes, create permanent entries for the ARP table, and set up RIP. For more information on static routes (IP routing) ARP and RIP, please read Appendix C.

## Configure Static Routes

Entries into the Switch's forwarding table can be made using both MAC addresses and IP addresses. Static IP forwarding is accomplished by the entry of an IP address into the switch's Static IP Routing table. Static routes that have been previously configured appear in the Static/Default Route Settings table.

To enter an IP address into the Switch's IP Forwarding Table, open the **Forwarding Folder** and then the **IP Forwarding** folder, and then click the **Static/Default Routes** link:

	IP Address	Subnet Mask	Gateway IP	Metric	BackUp State
<input type="radio"/>	10.0.0.0	255.0.0.0	10.254.254.252	1	Primary

Figure 22- 1. Static/Default Routes

To delete an existing static/default route, select the route and then click the **Delete** button.

To add a new static/default route, click the **New** button:

IP Address	0	.	0	.	0	.	0
Subnet Mask	0	.	0	.	0	.	0
Gateway IP	0	.	0	.	0	.	0
Metric	1						
BackUp State	Primary						

Figure 22- 2. Static/Default Routes – Add

The following fields can be set:

Parameter	Description
<b>IP Address</b> <0.0.0.0>	Allows the entry of an IP address that will be a static entry into the Switch's Routing Table.
<b>Subnet Mask</b> <0.0.0.0>	Allows the entry of a subnet mask corresponding to the IP address above.
<b>Gateway IP</b> <0.0.0.0>	Allows the entry of an IP address of a gateway for the IP address above.
<b>Metric</b> <1 >	Allows the entry of a routing protocol metric representing the number of routers between the Switch and the IP address above.
<b>Backup Status</b>	Specify the route as <i>Primary</i> or <i>Backup</i> . If a single IP route is used, it is unnecessary to change this. Designate a backup route if an alternate route is desired. A backup IP route is sometimes called "floating static route".

## Configure Static ARP

To make a static ARP entry, click the IP Forwarding folder and then the Static ARP link:

Figure 22- 3. Static ARP

To delete an existing static ARP entry, click corresponding click-box and then click the **Delete** button.

To add a new static ARP entry, click the **New** button:

Figure 22- 4. Static ARP – Add

The following fields can be set:

Parameter	Description
IP Address	The IP address of the ARP entry.
MAC Address	The MAC address of the ARP entry.

## Routing Information Protocol (RIP) Configuration

To setup RIP for the IP interfaces configured in the Switch, open the RIP folder and click on the RIP Global Setting link. Use the RIP Global Setting menu to first enable RIP and then configure RIP settings for the individual IP interfaces. To enable RIP, select *Enabled* from the drop-down RIP State menu and click the **Apply** button. RIP can be disabled or enabled without changing any of the RIP IP interfaces settings using this menu.

**Figure 22- 5. RIP Status**

RIP settings are configured for each IP interface on the Switch. Click the RIP Interface Settings link in the RIP folder. The menu appears in table form listing settings for IP interfaces currently on the Switch. To configure RIP settings for an individual interface, click on the hyperlinked name of the interface.

	Interface Name	IP Address	Tx Mode	Rx Mode	Auth.	State
<a href="#">C</a>	System	10. 42. 41. 111	Disabled	Disabled	Disabled	Disabled

**Figure 22- 6. RIP Interface Settings**

Click the name of the interface you want to setup for RIP to the following menu:

Interface Name	System
IP Address	10 . 42 . 41 . 111
Tx Mode	Disabled
Rx Mode	Disabled
Authentication	Disabled
Password	
State	Disabled

**Figure 22- 7. Setup RIP – Edit**

Refer to the table below for a description of the available parameters for RIP interface settings. To return to the RIP Interface Settings table, click the [Show All RIP Interface Settings](#) link.

The following RIP settings can be applied to each IP interface:

Parameter	Description
<b>Interface Name</b>	The name of the IP interface on which RIP is to be setup. This interface must be previously configured on the Switch.
<b>TX Mode &lt;Disabled&gt;</b>	Toggle among <i>Disabled</i> , <i>V1 Only</i> , <i>V1 Compatible</i> , and <i>V2 Only</i> . This entry specifies which version of the RIP protocol will be used to transmit RIP packets. <i>Disabled</i> prevents the transmission of RIP packets.
<b>RX Mode &lt;Disabled&gt;</b>	Toggle among <i>Disabled</i> , <i>V1 Only</i> , <i>V2 Only</i> , and <i>V1 or V2</i> . This entry specifies which version of the RIP protocol will be used to interpret received RIP packets. <i>Disabled</i> prevents the reception of RIP packets.
<b>Password</b>	A password to be used to authenticate communication between routers on the network.
<b>Authentication</b>	Toggle between <i>Disabled</i> and <i>Enabled</i> to specify that routers on the network should use the Password above to authenticate router table exchanges.
<b>State</b>	Toggle between <i>Disable</i> and <i>Enable</i> to disable or enable this RIP interface on the Switch.

## Introduction to OSPF

The Open Shortest Path First (OSPF) routing protocol that uses a *link-state* algorithm to determine routes to network destinations. A “link” is an interface on a router and the “state” is a description of that interface and its relationship to neighboring routers. The state contains information such as the IP address, subnet mask, type of network the interface is attached to, other routers attached to the network, etc. The collection of link-states are then collected in a link-state database that is maintained by routers running OSPF.

OSPF specifies how routers will communicate to maintain their link-state database and defines several concepts about the topology of networks that use OSPF.

To limit the extent of link-state update traffic between routers, OSPF defines the concept of *Area*. All routers within an area share the exact same link-state database, and a change to this database on one router triggers an update to the link-state database of all other routers in that area. Routers that have interfaces connected to more than one area are called *Border Routers* and take the responsibility of distributing routing information between areas.

One area is defined as *Area 0* or the *Backbone*. This area is central to the rest of the network in that all other areas have a connection (through a router) to the backbone. Only routers have connections to the backbone and OSPF is structured such that routing information changes in other areas will be introduced into the backbone, and then propagated to the rest of the network.

When constructing a network to use OSPF, it is generally advisable to begin with the backbone (area 0) and work outward.

### The Link-State Algorithm

An OSPF router uses a link-state algorithm to build a shortest path tree to all destinations known to the router. The following is a simplified description of the algorithm's steps:

1. When OSPF is started, or when a change in the routing information changes, the router generates a link-state advertisement. This advertisement is a specially formatted packet that contains information about all the link-states on the router.
2. This link-state advertisement is flooded to all router in the area. Each router that receives the link-state advertisement will store the advertisement and then forward a copy to other routers.
3. When the link-state database of each router is updated, the individual routers will calculate a Shortest Path Tree to all destinations – with the individual router as the root. The IP routing table will then be made up of the destination address, associated cost, and the address of the next hop to reach each destination.
4. Once the link-state databases are updated, Shortest Path Trees calculated, and the IP routing tables written – if there are no subsequent changes in the OSPF network (such as a network link going down) there is very little OSPF traffic.

### The Shortest Path Algorithm

The Shortest Path to a destination is calculated using the Dijkstra algorithm. Each router is places at the root of a tree and then calculates the shortest path to each destination based on the cumulative cost to reach that destination over multiple possible routes. Each router will then have its own Shortest Path Tree (from the perspective of its location in the network area) even though every router in the area will have and use the exact same link-state database.

The following sections describe the information used to build the Shortest Path Tree.

### OSPF Cost

Each OSPF interface has an associated cost (also called “metric”) that is representative of the overhead required to send packets over that interface. This cost is inversely proportional to the bandwidth of the interface (i.e. a higher bandwidth interface has a lower cost). There is then a higher cost (and longer time delays) in sending packets over a 56 Kbps dial-up connection than over a 10 Mbps Ethernet connection. The formula used to calculate the OSPF cost is as follows:

$$\text{Cost} = 100,000,000 / \text{bandwidth in bps}$$

As an example, the cost of a 10 Mbps Ethernet line will be 10 and the cost to cross a 1.544 Mbps T1 line will be 64.

### Shortest Path Tree

To build Router A’s shortest path tree for the network diagramed below, Router A is put at the root of the tree and the smallest cost link to each destination network is calculated.

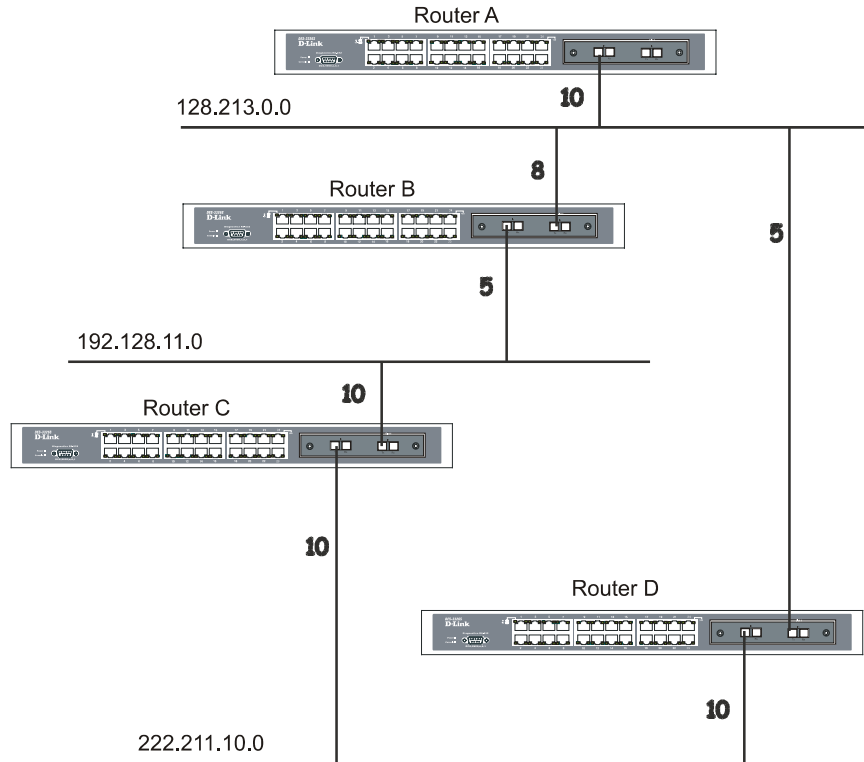
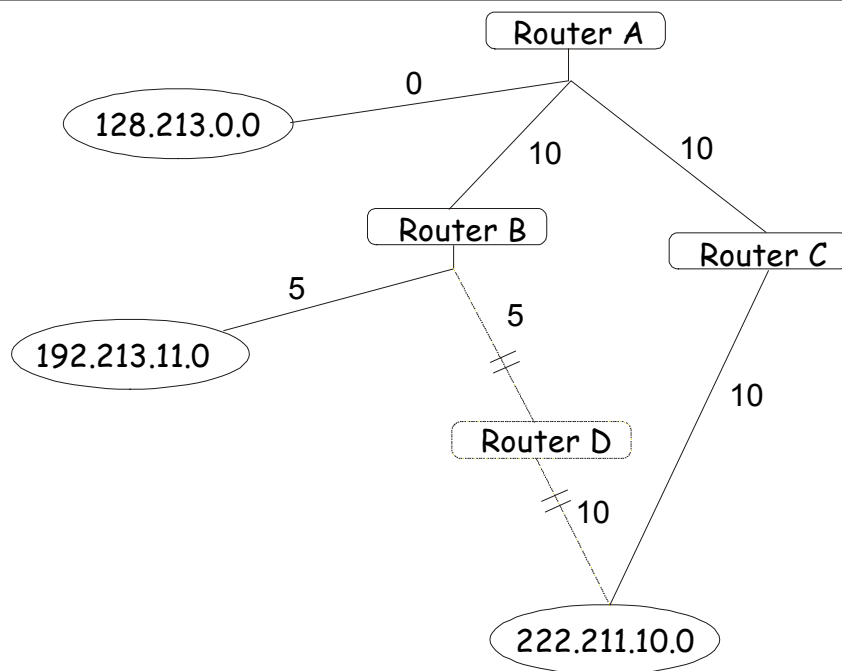

Figure 23- 1. Constructing a Shortest Path Tree





**Figure 23- 2. Constructing a Shortest Path Tree**

The diagram above shows the network from the viewpoint of Router A. Router A can reach 192.213.11.0 through Router B with a cost of  $10+5=15$ . Router A can reach 222.211.10.0 through Router C with a cost of  $10+10=20$ . Router A can also reach 222.211.10.0 through Router B and Router D with a cost of  $10+5+10=25$ , but the cost is higher than the route through Router C. This higher-cost route will not be included in the Router A's shortest path tree. The resulting tree will look like this:

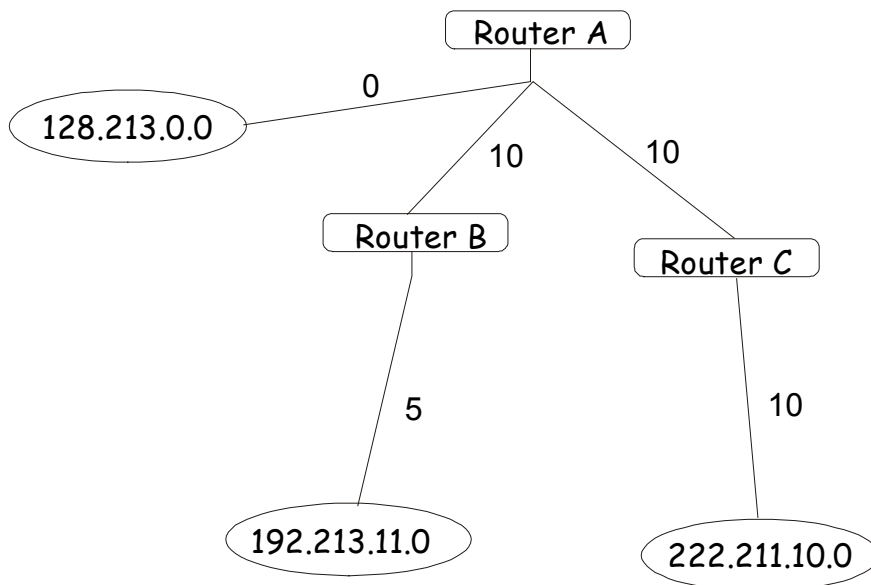

**Figure 23- 3. Constructing a Shortest Path Tree - Completed**

Note that this shortest path tree is only from the viewpoint of Router A. The cost of the link from Router B to Router A, for instance is not important to constructing Router A's shortest path tree, but is very important when Router B is constructing its shortest path tree.

Note also that directly connected networks are reached at a cost of 0, while other networks are reached at the cost calculated in the shortest path tree.

Router A can now build its routing table using the network addresses and costs calculated in building the above shortest path tree.

## **Areas and Border Routers**

OSPF link-state updates are forwarded to other routers by flooding to all routers on the network. OSPF uses the concept of areas to define where on the network routers that need to receive particular link-state updates are located. This helps ensure that routing updates are not flooded throughout the entire network and to reduce the amount of bandwidth consumed by updating the various router's routing tables.

Areas establish boundaries beyond which link-state updates do not need to be flooded. So the exchange of link-state updates and the calculation of the shortest path tree are limited to the area that the router is connected to.

Routers that have connections to more than one area are called Border Routers (BR). The Border Routers have the responsibility of distributing necessary routing information and changes between areas.

Areas are specific to the router interface. A router that has all of its interfaces in the same area is called an Internal Router. A router that has interfaces in multiple areas is called a Border Router. Routers that act as gateways to other networks (possibly using other routing protocols) are called Autonomous System Border Routers (ASBRs).

## **Link-State Packets**

There are different types of link-state packets, four are illustrated below:

- Router Link-State Updates – these describe a router's links to destinations within an area.
- Summary Link-State Updates – issued by Border Routers and describe links to networks outside the area but within the Autonomous System (AS).
- Network Link-State Updates – issued by multi-access areas that have more than one attached router. One router is elected as the Designated Router (DR) and this router issues the network link-state updates describing every router on the segment.
- External Link-State Updates – issued by an Autonomous System Border Router and describes routes to destinations outside the AS or a default route to the outside AS.

The format of these link-state updates are described in more detail below.

Router link-state updates are flooded to all routers in the current area. These updates describe the destinations reachable through all of the router's interfaces.

Summary link-state updates are generated by Border Routers to distribute routing information about other networks within the AS. Normally, all Summary link-state updates are forwarded to the backbone (area 0) and are then forwarded to all other areas in the network. Border Routers also have the responsibility of distributing routing information from the Autonomous System Border Router in order for routers in the network to get and maintain routes to other Autonomous Systems.

Network link-state updates are generated by a router elected as the Designated Router on a multi-access segment (with more than one attached router). These updates describe all of the routers on the segment and their network connections.

External link-state updates carry routing information to networks outside the Autonomous System. The Autonomous System Border Router is responsible for generating and distributing these updates.

## **OSPF Authentication**

OSPF packets can be authenticated as coming from trusted routers by the use of predefined passwords. The default for routers is to use not authentication.

There are two other authentication methods – simple password authentication (key) and Message Digest authentication (MD-5).

### **Message Digest Authentication (MD-5)**

MD-5 authentication is a cryptographic method. A key and a key-ID are configured on each router. The router then uses an algorithm to generate a mathematical “message digest” that is derived from the OSPF packet, the key and the key-ID. This message digest (a number) is then appended to the packet. The key is not exchanged over the wire and a non-decreasing sequence number is included to prevent replay attacks.

### **Simple Password Authentication**

A password (or key) can be configured on a per-area basis. Routers in the same area that participate in the routing domain must be configured with the same key. This method is possibly vulnerable to passive attacks where a link analyzer is used to obtain the password.

## **The Backbone and Area 0**

OSPF limits the number of link-state updates required between routers by defining areas within which a given router operates. When more than one area is configured, one area is designated as area 0 – also called the backbone.

The backbone is at the center of all other areas – all areas of the network have a physical (or virtual) connection to the backbone through a router. OSPF allows routing information to be distributed by forwarding it into area 0, from which the information can be forwarded to all other areas (and all other routers) on the network.

In situations where an area is required, but is not possible to provide a physical connection to the backbone, a virtual link can be configured.

### **Virtual Links**

Virtual links accomplish two purposes:

1. Linking an area that does not have a physical connection to the backbone.
2. Patching the backbone in case there is a discontinuity in area 0.

### **Areas Not Physically Connected to Area 0**

All areas of an OSPF network should have a physical connection to the backbone, but in some cases it is not possible to physically connect a remote area to the backbone. In these cases, a virtual link is configured to connect the remote area to the backbone. A virtual path is a logical path between two border routers that have a common area, with one border router connected to the backbone.

### **Partitioning the Backbone**

OSPF also allows virtual links to be configured to connect the parts of the backbone that are discontinuous. This is the equivalent to linking different area 0s together using a logical path between each area 0. Virtual links can also be added for redundancy to protect against a router failure. A virtual link is configured between two border routers that both have a connection to their respective area 0s.

## Neighbors

Routers that are connected to the same area or segment become neighbors in that area. Neighbors are elected via the Hello protocol. IP multicast is used to send out Hello packets to other routers on the segment. Routers become neighbors when they see themselves listed in a Hello packet sent by another router on the same segment. In this way, two-way communication is guaranteed to be possible between any two neighbor routers.

Any two routers must meet the following conditions before they become neighbors:

- **Area ID** – two routers having a common segment – their interfaces have to belong to the same area on that segment. Of course, the interfaces should belong to the same subnet and have the same subnet mask.
- **Authentication** – OSPF allows for the configuration of a password for a specific area. Two routers on the same segment and belonging to the same area must also have the same OSPF password before they can become neighbors.
- **Hello and Dead Intervals** – The Hello interval specifies the length of time, in seconds, between the hello packets that a router sends on an OSPF interface. The dead interval is the number of seconds that a router's Hello packets have not been seen before its neighbors declare the OSPF router down. OSPF routers exchange Hello packets on each segment in order to acknowledge each other's existence on a segment and to elect a Designated Router on multi-access segments. OSPF requires these intervals to be exactly the same between any two neighbors. If any of these intervals are different, these routers will not become neighbors on a particular segment.
- **Stub Area Flag** – any two routers also have to have the same stub area flag in their Hello packets in order to become neighbors.

## Adjacencies

Adjacent routers go beyond the simple Hello exchange and participate in the link-state database exchange process. OSPF elects one router as the Designated Router (DR) and a second router as the Backup Designated Router (BDR) on each multi-access segment (the BDR is a backup in case of a DR failure). All other routers on the segment will then contact the DR for link-state database updates and exchanges. This limits the bandwidth required for link-state database updates.

## Designated Router Election

The election of the DR and BDR is accomplished using the Hello protocol. The router with the highest OSPF priority on a given multi-access segment will be com the DR for that segment. In case of a tie, the router with the highest Router ID wins. The default OSPF priority is 1. A priority of zero indicates a router that can not be elected as the DR.

## Building Adjacency

Two routers undergo a multi-step process in building the adjacency relationship. The following is a simplified description of the steps required:

- **Down** – No information has been received from any router on the segment.
- **Attempt** – On non-broadcast multi-access networks (such as Frame Relay or X.25), this state indicates that no recent information has been received from the neighbor. An effort should be made to contact the neighbor by sending Hello packets at the reduced rate set by the Poll Interval.
- **Init** – The interface has detected a Hello packet coming from a neighbor but bi-directional communication has not yet been established.
- **Two-way** – Bi-directional communication with a neighbor has been established. The router has seen its address in the Hello packets coming from a neighbor. At the end of this stage the DR and BDR election would have been done. At the end of the Two-way stage, routers will decide whether to proceed in building an adjacency or not. The decision is based on whether one of the routers is a DR or a BDR or the link is a point-to-point or virtual link.
- **Exstart** – (Exchange Start) Routers establish the initial sequence number that is going to be used in the information exchange packets. The sequence number insures that routers always get the most recent information. One router will become the primary and the other will become secondary. The primary router will poll the secondary for information.
- **Exchange** – Routers will describe their entire link-state database by sending database description packets.
- **Loading** – The routers are finalizing the information exchange. Routers have link-state request list and a link-state retransmission list. Any information that looks incomplete or outdated will be put on the request list. Any update that is sent will be put on the retransmission list until it gets acknowledged.
- **Full** – The adjacency is now complete. The neighboring routers are fully adjacent. Adjacent routers will have the same link-state database.

## Adjacencies on Point-to-Point Interfaces

OSPF Routers that are linked using point-to-point interfaces (such as serial links) will always form adjacencies. The concepts of DR and BDR are unnecessary.

## OSPF Packet Formats

All OSPF packet types begin with a standard 24 byte header and there are five packet types. The header is described first, and each packet type is described in a subsequent section.

All OSPF packets (except for Hello packets) forward link-state advertisements. Link-State Update packets, for example, flood advertisements throughout the OSPF routing domain.

- OSPF packet header
- Hello packet
- Database Description packet
- Link-State Request packet
- The Link-State Update packet
- Link-State Acknowledgment packet

## The OSPF Packet Header

Every OSPF packet is preceded by a common 24 byte header. This header contains the information necessary for a receiving router to determine if the packet should be accepted for further processing.

The format of the OSPP packet header is shown below:

OSPF Packet Header

Octets				
0	1	2	3	4
Version No.	Type		Packet Length	
Router ID				
Area ID				
Checksum		Authentication Type		
Authentication				
Authentication				

Table 5. OSPF Packet Header

Field	Description
<b>Version No.</b>	The OSPF version number
<b>Type</b>	The OSPF packet type. The OSPF packet types are as follows: Type Description Hello Database Description Link-State Request Link-State Update Link-State Acknowledgment
<b>Packet Length</b>	The length of the packet in bytes. This length includes the 24 byte header.
<b>Router ID</b>	The Router ID of the packet's source.
<b>Area ID</b>	A 32-bit number identifying the area that this packet belongs to. All OSPF packets are associated with a single area. Packets traversing a virtual link are assigned the backbone Area ID of 0.0.0.0
<b>Checksum</b>	A standard IP checksum that includes all of the packet's contents except for the 64-bit authentication field.
<b>Authentication Type</b>	The type of authentication to be used for the packet.
<b>Authentication</b>	A 64-bit field used by the authentication scheme.

**The Hello Packet**

Hello packets are OSPF packet type 1. They are sent periodically on all interfaces, including virtual links, in order to establish and maintain neighbor relationships. In addition, Hello Packets are multicast on those physical networks having a multicast or broadcast capability, enabling dynamic discovery of neighboring routers.

All routers connected to a common network must agree on certain parameters such as the Network Mask, the Hello Interval, and the Router Dead Interval. These parameters are included in hello packets, so that differences can inhibit the forming of neighbor relationships. A detailed explanation of the receive processing for Hello packets, so that differences can inhibit the forming of neighbor relationships.

The format of the Hello packet is shown below:

## Hello Packet

Octets				
0	1	2	3	4
Version No.	1	Packet Length		
Router ID				
Area ID				
Checksum		Authentication Type		
Authentication				
Authentication				
Network Mask				
Hello Interval		Options	Router Priority	
Router Dead Interval				
Designated Router				
Backup Designated Router				
Neighbor				

Table 6. Hello Packet

Field	Description
<b>Network Mask</b>	The network mask associated with this interface.
<b>Options</b>	The optional capabilities supported by the router.
<b>Hello Interval</b>	The number of seconds between this router's Hello packets.
<b>Router Priority</b>	This router's Router Priority. The Router Priority is used in the election of the DR and BDR. If this field is set to 0, the router is ineligible to become the DR or the BDR.
<b>Router Dead Interval</b>	The number of seconds that must pass before declaring a silent router as down.
<b>Designated Router</b>	The identity of the DR for this network, in the view of the advertising router. The DR is identified here by its IP interface address on the network.
<b>Backup Designated Router</b>	The identity of the Backup Designated Router (BDR) for this network. The BDR is identified here by its IP interface address on the network. This field is set to 0.0.0.0 if there is no BDR.
<b>Field</b>	Description
<b>Neighbor</b>	The Router Ids of each router from whom valid Hello packets have been seen within the Router Dead Interval on the network.

## The Database Description Packet

Database Description packets are OSPF packet type 2. These packets are exchanged when an adjacency is being initialized. They describe the contents of the topological database. Multiple packets may be used to describe the database. For this purpose a poll-response procedure is used. One of the routers is designated to be master, the other a slave. The master sends Database Description packets (polls) which are acknowledged by Database Description packets sent by the slave (responses). The responses are linked to the polls via the packets' DD sequence numbers.

Database Description Packet

Octets			
0	1	2	3 4
Version No.	2	Packet Length	
Router ID			
Area ID			
Checksum		Authentication Type	
Authentication			
Authentication			
Reserved	I M MS	Reserved	Options
DD Sequence No.			
Link-State Advertisement Header ...			

Table 7. Database Description Packet

Field	Description
<b>Options</b>	The optional capabilities supported by the router.
<b>I – bit</b>	The Initial bit. When set to 1, this packet is the first in the sequence of Database Description packets.
<b>M – bit</b>	The More bit. When set to 1, this indicates that more Database Description packets will follow.
<b>MS – bit</b>	The Master Slave bit. When set to 1, this indicates that the router is the master during the Database Exchange process. A zero indicates the opposite.
<b>DD Sequence Number</b>	User to sequence the collection of Database Description Packets. The initial value (indicated by the Initial bit being set) should be unique. The DD sequence number then increments until the complete database description has been sent.

The rest of the packet consists of a list of the topological database’s pieces. Each link state advertisement in the database is described by its link state advertisement header.

**The Link-State Request Packet**

Link-State Request packets are OSPF packet type 3. After exchanging Database Description packets with a neighboring router, a router may find that parts of its topological database are out of date. The Link-State Request packet is used to request the pieces of the neighbor’s database that are more up to date. Multiple Link-State Request packets may need to be used. The sending of Link-State Request packets is the last step in bringing up an adjacency.

A router that sends a Link-State Request packet has in mind the precise instance of the database pieces it is requesting, defined by LS sequence number, LS checksum, and LS age, although these fields are not specified in the Link-State Request packet itself. The router may receive even more recent instances in response.

The format of the Link-State Request packet is shown below:



### Link-State Request Packet

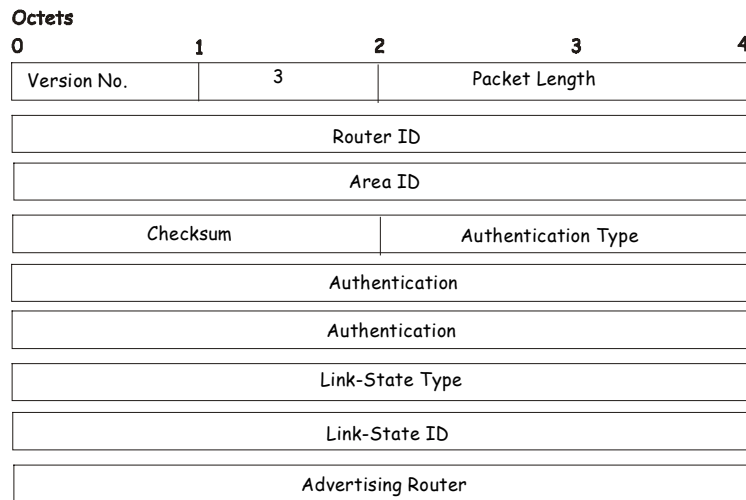

Each advertisement requested is specified by its Link-State Type, Link-State ID, and Advertising Router. This uniquely identifies the advertisement, but not its instance. Link-State Request packets are understood to be requests for the most recent instance.

### The Link-State Update Packet

Link-State Update packets are OSPF packet type 4. These packets implement the flooding of link-state advertisements. Each Link-State Update packet carries a collection of link-state advertisements one hop further from its origin. Several link-state advertisements may be included in a single packet.

Link-State Update packets are multicast on those physical networks that support multicast/broadcast. In order to make the flooding procedure reliable, flooded advertisements are acknowledged in Link-State Acknowledgment packets. If retransmission of certain advertisements is necessary, the retransmitted advertisements are always carried by unicast Link-State Update packets.

The format of the Link-State Update packet is shown below:

### Link-State Update Packet

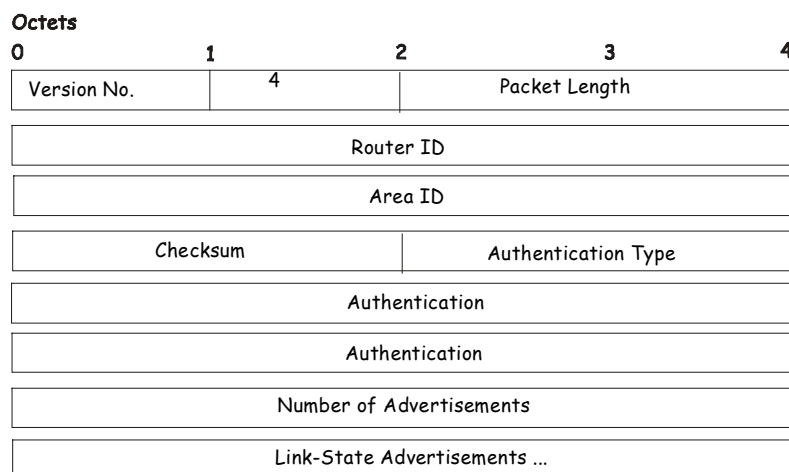

The body of the Link-State Update packet consists of a list of link-state advertisements. Each advertisement begins with a common 20-byte header, the link-state advertisement header. Otherwise, the format of each of the five types of link-state advertisements is different.

## The Link-State Acknowledgment Packet

Link-State Acknowledgment packets are OSPF packet type 5. To make the folding of link-state advertisements reliable, flooded advertisements are explicitly acknowledged. This acknowledgment is accomplished through the sending and receiving of Link-State Acknowledgment packets. Multiple link-state advertisements can be acknowledged in a single Link-State Acknowledgment packet.

Depending on the state of the sending interface and the source of the advertisements being acknowledged, a Link-State Acknowledgment packet is sent either to the multicast address AllSPFRouters, to the multicast address AllDRouters, or as a unicast packet.

The format of this packet is similar to that of the Data Description packet. The body of both packets is simply a list of link-state advertisement headers.

The format of the Link-State Acknowledgment packet is shown below:

### Link-State Acknowledgment Packet

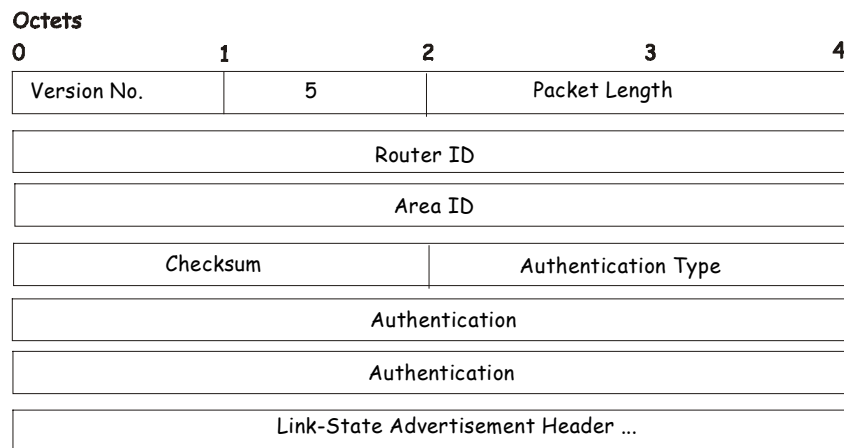

Each acknowledged link-state advertisement is described by its link-state advertisement header. It contains all the information required to uniquely identify both the advertisement and the advertisement's current instance.

### Link-State Advertisement Formats

There are five distinct types of link-state advertisements. Each link-state advertisement begins with a standard 20-byte link-state advertisement header. Succeeding sections then diagram the separate link-state advertisement types.

Each link-state advertisement describes a piece of the OSPF routing domain. Every router originates a router links advertisement. In addition, whenever the router is elected as the Designated Router, it originates a network links advertisement. Other types of link-state advertisements may also be originated. The flooding algorithm is reliable, ensuring that all routers have the same collection of link-state advertisements. The collection of advertisements is called the link-state (or topological) database.

From the link-state database, each router constructs a shortest path tree with itself as root. This yields a routing table.

There are four types of link state advertisements, each using a common link state header. These are:

- Router Links Advertisements
- Network Links Advertisements
- Summary Link Advertisements
- Autonomous System Link Advertisements

### The Link State Advertisement Header

All link state advertisements begin with a common 20-byte header. This header contains enough information to uniquely identify the advertisements (Link State Type, Link State ID, and Advertising Router). Multiple instances of the link state advertisement may exist in the routing domain at the same time. It is then necessary to determine which instance is more

recent. This is accomplished by examining the link state age, link state sequence number and link state checksum fields that are also contained in the link state advertisement header.

The format of the Link State Advertisement Header is shown below:

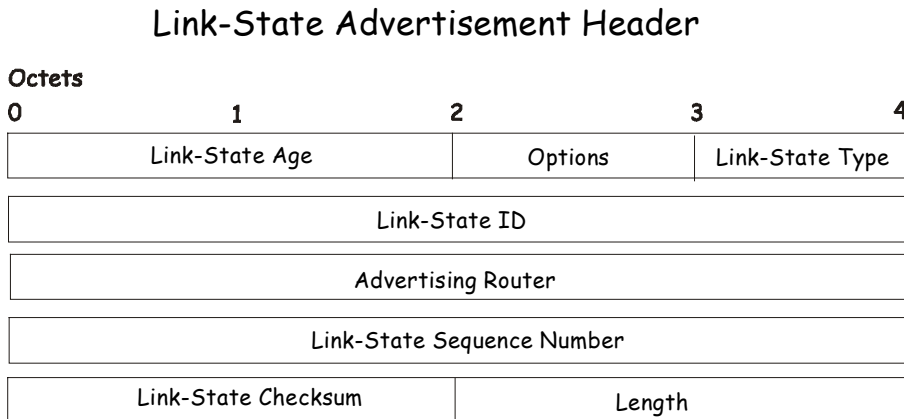

**Table 8. Link-State Advertisement Header**

Field	Description												
<b>Link State Age</b>	The time in seconds since the link state advertisement was originated.												
<b>Options</b>	The optional capabilities supported by the described portion of the routing domain.												
<b>Link State Type</b>	The type of the link state advertisement. Each link state type has a separate advertisement format. The link state types are as follows: <table style="width: 100%; border-collapse: collapse;"> <tr> <td style="width: 10%;">Type</td> <td>Description</td> </tr> <tr> <td>1</td> <td>Router Links</td> </tr> <tr> <td></td> <td>Network Links</td> </tr> <tr> <td></td> <td>Summary Link (IP Network)</td> </tr> <tr> <td></td> <td>Summary Link (ASBR)</td> </tr> <tr> <td></td> <td>AS External Link</td> </tr> </table>	Type	Description	1	Router Links		Network Links		Summary Link (IP Network)		Summary Link (ASBR)		AS External Link
Type	Description												
1	Router Links												
	Network Links												
	Summary Link (IP Network)												
	Summary Link (ASBR)												
	AS External Link												
<b>Link State ID</b>	This field identifies the portion of the internet environment that is being described by the advertisement. The contents of this field depend on the advertisement's Link State Type.												
<b>Advertising Router</b>	The Router ID of the router that originated the Link State Advertisement. For example, in network links advertisements this field is set to the Router ID of the network's Designated Router.												
<b>Link State Sequence Number</b>	Detects old or duplicate link state advertisements. Successive instances of a link state advertisement are given successive Link State Sequence numbers.												
<b>Link State Checksum</b>	The Fletcher checksum of the complete contents of the link state advertisement, including the link state advertisement header by excepting the Link State Age field.												
<b>Length</b>	The length in bytes of the link state advertisement. This includes the 20-byte link state advertisement header.												

### Router Links Advertisements

Router links advertisements are type 1 link state advertisements. Each router in an area originates a routers links advertisement. The advertisement describes the state and cost of the router’s links to the area. All of the router’s links to the area must be described in a single router links advertisement.

The format of the Router Links Advertisement is shown below:

**Routers Links Advertisements**

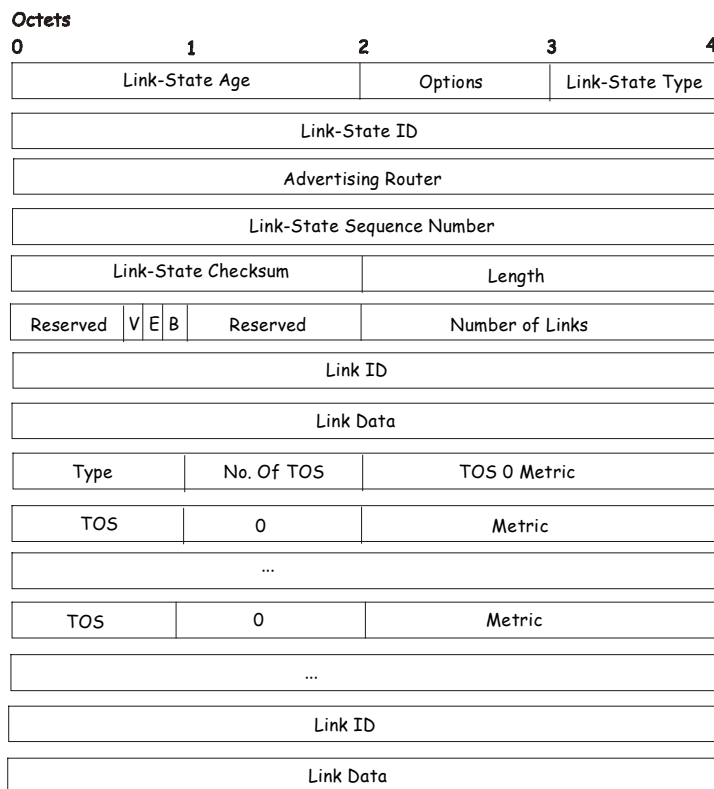

In router links advertisements, the Link State ID field is set to the router’s OSPF Router ID. The T – bit is set in the advertisement’s Option field if and only if the router is able to calculate a separate set of routes for each IP Type of Service (TOS). Router links advertisements are flooded throughout a single area only.

**Table 9. Routers Links Advertisement**

Field	Description
<b>V – bit</b>	When set, the router is an endpoint of an active virtual link that is using the described area as a Transit area (V is for Virtual link endpoint).
<b>E – bit</b>	When set, the router is an Autonomous System (AS) boundary router (E is for External).
<b>B – bit</b>	When set, the router is an area border router (B is for Border).
<b>Number of Links</b>	The number of router links described by this advertisement. This must be the total collection of router links to the area.

The following fields are used to describe each router link. Each router link is typed. The Type field indicates the kind of link being described. It may be a link to a transit network, to another router or to a stub network. The values of all the other fields describing a router link depend on the link’s Type. For example, each link has an associated 32-bit data field. For links to stub networks this field specifies the network’s IP address mask. For other link types the Link Data specifies the router’s associated IP interface address.

**Table 10. Routers Links Advertisements**

Field	Description
<b>Type</b>	<p>A quick classification of the router link. One of the following:</p> <p>Type Description</p> <p>Point-to-point connection to another router.</p> <p>Connection to a transit network.</p> <p>Connection to a stub network.</p> <p>Virtual link.</p>
<b>Link ID</b>	<p>Identifies the object that this router link connects to. Value depends on the link's Type. When connecting to an object that also originates a link state advertisement (i.e. another router or a transit network) the Link ID is equal to the neighboring advertisement's Link State ID. This provides the key for looking up an advertisement in the link state database.</p> <p>Type Link ID</p> <p>Neighboring router's Router ID.</p> <p>IP address of Designated Router.</p> <p>IP network/subnet number.</p> <p>Neighboring router's Router ID</p>
<b>Link Data</b>	<p>Contents again depend on the link's Type field. For connections to stub networks, it specifies the network's IP address mask. For unnumbered point-to-point connection, it specifies the interface's MIB-II ifIndex value. For other link types it specifies the router's associated IP interface address. This latter piece of information is needed during the routing table build process, when calculating the IP address of the next hop.</p>
<b>No. of TOS</b>	<p>The number of different Type of Service (TOS) metrics given for this link, not counting the required metric for TOS 0. If no additional TOS metrics are given, this field should be set to 0.</p>
<b>TOS 0 Metric</b>	<p>The cost of using this router link for TOS 0.</p>
<b>Field</b>	<b>Description</b>
<b>TOS</b>	IP Type of Service that this metric refers to.
<b>Metric</b>	The cost of using this outbound router link, for traffic of the specified TOS.

For each link, separate metrics may be specified for each Type of Service (TOS). The metric for TOS 0 must always be included, and was discussed above. Metrics for non-zero TOS are described below. Note that the cost for non-zero TOS values that are not specified defaults to the TOS 0 cost. Metrics must be listed in order of increasing TOS encoding. For example, the metric for TOS 16 must always follow the metric for TOS 8 when both are specified.

## Network Links Advertisements

Network links advertisements are Type 2 link state advertisements. A network links advertisement is originated for each transit network in the area. A transit network is a multi-access network that has more than one attached router. The network links advertisement is originated by the network's Designated router. The advertisement describes all routers attached to the network, including the Designated Router itself. The advertisement's Link State ID field lists the IP interface address of the Designated Router.

The distance from the network to all attached routers is zero, for all TOS. This is why the TOS and metric fields need not be specified in the network links advertisement.

The format of the Network Links Advertisement is shown below:

### Network Link Advertisements

Octets	0	1	2	3	4
	Link-State Age		Options	2	
	Link-State ID				
	Advertising Router				
	Link-State Sequence Number				
	Link-State Checksum		Length		
	Network Mask				
	Attached Router				

**Table 11. Network Link Advertisement**

Field	Description
<b>Network Mask</b>	The IP address mask for the network.
<b>Attached Router</b>	The Router Ids of each of the routers attached to the network. Only those routers that are fully adjacent to the Designated Router (DR) are listed. The DR includes itself in this list.

## Summary Link Advertisements

Summary link advertisements are Type 3 and 4 link state advertisements. These advertisements are originated by Area Border routers. A separate summary link advertisement is made for each destination known to the router, that belongs to the Autonomous System (AS), yet is outside the area.

Type 3 link state advertisements are used when the destination is an IP network. In this case the advertisement's Link State ID field is an IP network number. When the destination is an AS boundary router, a Type 4 advertisement is used, and the Link State ID field is the AS boundary router's OSPF Router ID. Other than the difference in the Link State ID field, the format of Type 3 and 4 link state advertisements is identical.

## Summary Link Advertisements

Octets				
0	1	2	3	4
Link-State Age		Options		2
Link-State ID				
Advertising Router				
Link-State Sequence Number				
Link-State Checksum			Length	
Network Mask				
TOS		Metric		

For stub area, Type 3 summary link advertisements can also be used to describe a default route on a per-area basis. Default summary routes are used in stub area instead of flooding a complete set of external routes. When describing a default summary route, the advertisement's Link State ID is always set to the Default Destination – 0.0.0.0, and the Network Mask is set to 0.0.0.0.

Separate costs may be advertised for each IP Type of Service. Note that the cost for TOS 0 must be included, and is always listed first. If the T-bit is reset in the advertisement's Option field, only a route for TOS 0 is described by the advertisement. Otherwise, routes for the other TOS values are also described. If a cost for a certain TOS is not included, its cost defaults to that specified for TOS 0.

**Table 12. Summary Link Advertisement**

Field	Description
<b>Network Mask</b>	For Type 3 link state advertisements, this indicates the destination network's IP address mask. For example, when advertising the location of a class A network the value 0xff000000
<b>TOS</b>	The Type of Service that the following cost is relevant to.
<b>Metric</b>	The cost of this route. Expressed in the same units as the interface costs in the router links advertisements.

### Autonomous Systems External Link Advertisements

Autonomous Systems (AS) link advertisements are Type 5 link state advertisements. These advertisements are originated by AS boundary routers. A separate advertisement is made for each destination known to the router, that is external to the AS.

AS external link advertisements usually describe a particular external destination. For these advertisements the Link State ID field specifies an IP network number. AS external link advertisements are also used to describe a default route. Default routes are used when no specific route exists to the destination. When describing a default route, the Link Stat ID is always set the Default Destination address (0.0.0.0) and the Network Mask is set to 0.0.0.0.

The format of the AS External Link Advertisement is shown below:

AS External Link Advertisements

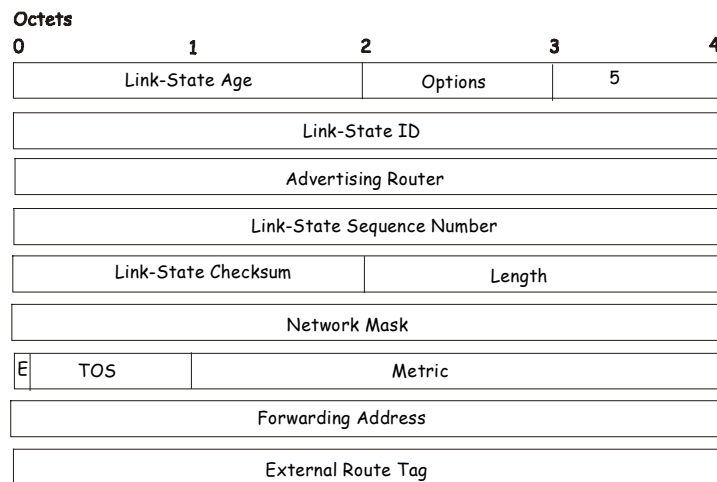

Table 13. AS External System Advertisement

Field	Description
<b>Network Mask</b>	The IP address mask for the advertised destination.
<b>E – bit</b>	The type of external metric. If the E – bit is set, the metric specified is a Type 2 external metric. This means the metric is considered larger than any link state path. If the E – bit is zero, the specified metric is a Type 1 external metric. This means that is comparable directly to the link state metric.
<b>Forwarding Address</b>	Data traffic for the advertised destination will be forwarded to this address. If the Forwarding Address is set to 0.0.0.0, data traffic will be forwarded instead to the advertisement’s originator.
<b>TOS</b>	The Type of Service that the following cost is relevant to.
<b>Metric</b>	The cost of this route. The interpretation of this metric depends on the external type indication (the E – bit above).
<b>External Route Tag</b>	A 32-bit field attached to each external route. This is not used by the OSPF protocol itself.



## **Configure OSPF**

*MD5 Key Table Configuration*

*Configure OSPF Settings*

*OSPF Area Setting*

*OSPF Interface Configuration*

*OSPF Virtual Interface Settings*

*Area Aggregation Configuration*

*OSPF Host Route Settings*

*Route Redistribution Settings*

This chapter describes how to configure OSPF settings for the Switch. If you are not familiar with the basic concepts associated of OSPF protocol, please read the preceding chapter

## MD5 Key Table Configuration

MD5 authentication is used to identify trusted routers sending OSPF packets. By default no authentication is used for OSPF so it is not necessary to configure any MD5 keys to use OSPF. MD5 authentication can be set up at any time, before or after you have configured OSPF settings. The link for MD5 Key configuration is located in the Configuration folder.

The **MD5 Key Table Configuration** menu allows the entry of a 16 character Message Digest – version 5 (MD5) key which can be used to authenticate every packet exchanged between OSPF routers. It is used as a security mechanism to limit the exchange of network topology information to the OSPF routing domain.

MD5 Keys created here are entered in when setting up OSPF interfaces. Please read the description in the section below about OSPF Interface Settings.

To configure an MD5 Key, click the **MD5 Key Table Configuration** link to open the following menu:

MD5 Key Table Configuration	
<input type="button" value="New"/> <input type="button" value="Edit"/> <input type="button" value="Delete"/>	
Key ID	Key
1	aabbccddeeff

Figure 24- 1. MD5 Key Table Configuration

To add an MD5 key to the table, click the New button:

MD5 Key Table Configuration - Add	
Key ID	<input type="text"/>
Key	<input type="text"/>
<input type="button" value="Back"/> <input type="button" value="Apply"/>	

Figure 24- 2. MD5 Key Table – Add

To edit an entry in the MD5 key table, select the key from the MD5 Key Table Configuration screen, and click the Edit button:

MD5 Key Table Configuration - Edit	
Key ID	1
Key	aabbccddeeff
<input type="button" value="Back"/> <input type="button" value="Apply"/>	

Figure 24- 3. MD5 Key Table – Edit

The following fields can be set:

Parameter	Description
<b>Key ID</b>	A number from 1 to 255 used to identify the MD5 Key.
<b>Key</b>	A alphanumeric string of between 1 and 16 case-sensitive characters used to generate the Message Digest which is in turn, used to authenticate OSPF packets within the OSPF routing domain.

## Configure OSPF Settings

All the links for OSPF configuration menus are contained within a subdirectory of the Layer 3 IP Networking subdirectory (located in the Configuration folder). The OSPF tables used to monitor OSPF information can be accessed using the links located in the OSPF subdirectory located in the Layer 3 subdirectory of the Monitoring folder. OSPF tables are discussed following this section's discussion of OSPF configuration.

### Global OSPF Settings

The **OSPF General Setting** menu allows OSPF to be enabled or disabled on the Switch – without changing the Switch's OSPF configuration.

From the Layer 3 IP Networking folder, open the OSPF folder and click on the OSPF General Setting link. To enable OSPF, first supply an **OSPF Rout ID** (see below), select *Enabled* from the **State** drop-down menu and click the **Apply** button.

OSPF General Setup	
OSPF Route ID	<input type="text" value="0"/> <input type="text" value="0"/> <input type="text" value="0"/> <input type="text" value="0"/>
Current Route ID	10. 42. 41.111
State	Disabled ▾
Apply	

Figure 24- 4. General Setup for OSPF

The following parameters are used for general OSPF configuration:

Parameter	Description
<b>OSPF Route ID</b>	A 32-bit number (in the same format as an IP address – xxx.xxx.xxx.xxx) that uniquely identifies the Switch in the OSPF domain. It is common to assign the highest IP address assigned to the Switch (router). In this case, it would be 10.255.255.255, but any unique 32-bit number will do. If 0.0.0.0 is entered, the highest IP address assigned to the Switch will become the OSPF Route ID.
<b>Current Route ID</b>	Displays the OSPF Route ID currently in use by the Switch. This Route ID is displayed as a convenience to the user when changing the Switch's OSPF Route ID.
<b>State</b>	Allows OSPF to be enabled or disabled globally on the Switch without changing the OSPF configuration.

## OSPF Area Setting

This menu allows the configuration of OSPF Area IDs and to designate these areas as either **Normal** or **Stub**. Normal OSPF areas allow Link-State Database (LSDB) advertisements of routes to networks that are external to the area, Stub areas do not allow the LSDB advertisement of external routes. Stub areas use a default summary external route (0.0.0.0 or Area 0) to reach external destinations.

To set up an OSPF Area configuration click the OSPF Area Settings link to open the following dialog box:

	Area ID	Type	Stub Import Summary LSA	Stub Default Cost
<input type="radio"/>	0.0.0.0	Normal	None	None

Figure 24- 5. OSPF Area Setting

The first OSPF Area Setting screen displays a summary of all of the OSPF areas defined on the switch. OSPF areas can be added, edited, or deleted from this screen.

To add an OSPF area to the switch, click on the New button:

Figure 24- 6. OSPF Area Setting – Add

To edit an existing OSPF area definition, select the area from the OSPF Area Setting screen, and then click the Edit button:

Figure 24- 7. OSPF Area Setting – Edit

The following fields can be set or are displayed:

Parameter	Description
<b>Area ID</b>	A 32-bit number in the form of an IP address (xxx.xxx.xxx.xxx) that uniquely identifies the OSPF area in the OSPF domain.
<b>Type</b>	This field can be toggled between Normal and Stub using the space bar. When it is toggled to Stub, additional fields appear – Stub Import Summary LSA, and Default Cost.
<b>Stub Import Summary LSA</b>	Displays whether or not the selected Area will allow Summary Link-State Advertisements (Summary LSAs) to be imported into the area from other areas.
<b>Default Cost</b>	Displays the default cost for the route to the stub of between 0 and 65,535. The default is 0.

## OSPF Interface Configuration

To set up OSPF interfaces, click the OSPF Interface Settings link to view OSPF settings for existing IP interfaces. If there are no IP interfaces configured (besides the default System interface), only the System interface settings will appear listed.

To configure an OSPF Interface, click on the OSPF Interface Configuration link:

OSPF Interface Configuration									
		<input type="button" value="Edit"/>		<input type="button" value="Monitor"/>					
	Name	Interface IP Address	Area ID	Priority	Hello Time	Dead Time	Auth. Type	State	Metric
<input type="radio"/>	System	10.42.73.10	0.0.0.0	1	10	40	None	Disabled	1

Figure 24- 8. OSPF Interface Configuration

All of the IP Interfaces currently configured on the switch will be displayed. Select the IP interface you want to configure OSPF for, and then click the **Edit** button. This will open the following dialog box:

OSPF Interface Configuration - Edit	
Interface Name	System
Area ID	<input type="text" value="0"/> . <input type="text" value="0"/> . <input type="text" value="0"/> . <input type="text" value="0"/>
Router Priority	<input type="text" value="1"/>
Hello Interval	<input type="text" value="10"/>
Dead Interval	<input type="text" value="40"/>
State	<input type="text" value="Disabled"/>
Auth. Type	<input type="text" value="None"/>
Metric	<input type="text" value="1"/>
<input type="button" value="Back"/> <span style="float: right;"><input type="button" value="Apply"/></span>	

Figure 24- 9. OSPF Interface Configuration

Some OSPF interface settings require previously configured OSPF settings. Read the descriptions below for details.

The following fields can then be configured for the OSPF interface:

Parameter	Description
<b>Interface Name</b>	Displays the of an IP interface previously configured on the Switch.
<b>Area ID</b>	Allows the entry of an OSPF Area ID configured above.
<b>Router Priority</b>	Allows the entry of a number between 0 and 255 representing the OSPF priority of the selected area. If a Router Priority of 0 is selected, the Switch cannot be elected as the Designated Router for the network.
<b>Hello Interval</b>	Allows the specification of the interval between the transmission of OSPF Hello packets, in seconds. Between 5 and 65535 seconds can be specified. The Hello Interval, Dead Interval, Authorization Type, and Authorization Key should be the same for all routers on the same network.
<b>Dead Interval</b>	Allows the specification of the length of time between the receipt of Hello packets from a neighbor router before the selected area declares that router down. An interval between 5 and 65535 seconds can be specified. The Dead Interval must be evenly divisible by the Hello Interval.
<b>State</b>	Allows the OSPF interface to be disabled for the selected area without changing the configuration for that area.
<b>Auth Type</b>	This field can be toggled between None, Simple, and MD5 using the space bar. This allows a choice of authorization schemes for OSPF packets that may be exchanged over the OSPF routing domain. None specifies no authorization. Simple uses a simple password to determine if the packets are from an authorized OSPF router. When Simple is selected, the Auth Key:[ ] field allows the entry of a 8 character password that must be the same as a password configured on a neighbor OSPF router. MD5 uses a cryptographic key entered in the MD5 Key Table Configuration menu. When MD5 is selected, the Auth Key ID:[ ] field allows the specification of the Key ID as defined in the MD5 configuration above. This must be the same MD5 Key as used by the neighboring router.
<b>Metric</b>	This field allows the entry of a number between 1 and 65,535 that is representative of the OSPF cost of reaching the selected OSPF interface. The default metric is 1.

## OSPF Virtual Interface Settings

Click the OSPF Virtual Interface Settings link to view the current OSPF virtual interface settings. There are not virtual interface settings configured by default, so the first time this table is viewed there will be not interfaces listed. A new menu appears (see below).

To setup an OSPF Virtual Interface on the switch, click the Virtual Interface Configuration link under the OSPF folder:

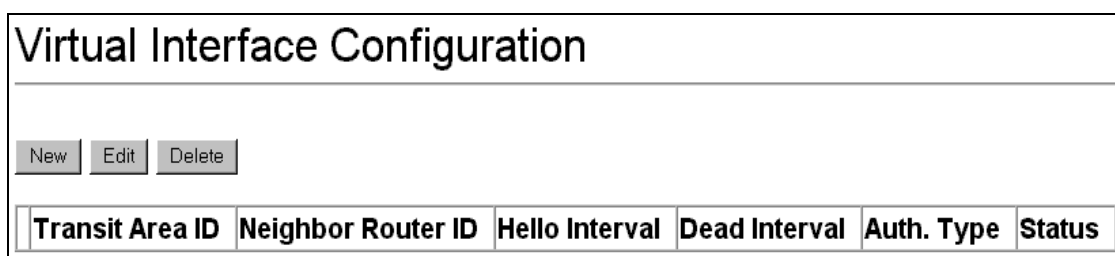

Figure 24- 10. Virtual Interface Configuration

To add a new OSPF virtual interface configuration set to the table, click the **New** button.

Virtual Interface Configuration - Add	
Transit Area ID	0 . 0 . 0 . 0
Neighbor Router ID	0 . 0 . 0 . 0
Hello Interval	10
Dead Interval	60
Auth. Type	None
<div style="display: flex; justify-content: space-between;"> <span>Back</span> <span>Apply</span> </div>	

**Figure 24- 11. Virtual Interface Configuration – Add**

Configure the following parameters if you are adding or changing an OSPF Virtual Interface:

Parameter	Description
<b>Transit Area ID</b>	Allows the entry of an OSPF Area ID – previously defined on the Switch – that allows a remote area to communicate with the backbone (area 0). A Transit Area cannot be a Stub Area or a Backbone Area.
<b>Neighbor Router</b>	The OSPF router ID for the remote router. This is a 32-bit number in the form of an IP address (xxx.xxx.xxx.xxx) that uniquely identifies the remote area's Area Border Router.
<b>Hello Interval</b>	Specify the interval between the transmission of OSPF Hello packets, in seconds. Enter a value between 1 and 65535 seconds. The Hello Interval, Dead Interval, Authorization Type, and Authorization Key should have identical settings for all routers on the same network.
<b>Dead Interval</b>	Specify the length of time between (receiving) Hello packets from a neighbor router before the selected area declares that router down. Again, all routers on the network should use the same setting.
<b>Auth Type</b>	If using authorization for OSPF routers, select the type being used. MD5 key authorization must be set up in the MD5 Key Settings menu.
<b>Password/Auth. Key ID</b>	Enter a case-sensitive password for simple authorization or enter the MD5 key you set in the MD5 Key settings menu.



**NOTE:** For OSPF to function properly some settings should be identical on all participating OSPF devices. These settings include the Hello Interval and Dead Interval. For networks using authorization for OSPF devices, they Authorization Type and Password or Key used must likewise be identical.

## Area Aggregation Configuration

Area Aggregation allows all of the routing information that may be contained within an area to be aggregated into a summary LSDB advertisement of just the network address and subnet mask. This allows for a reduction in the volume of LSDB advertisement traffic as well as a reduction in the memory overhead in the Switch used to maintain routing tables.

Click the OSPF Area Aggregation Settings link to view the current settings. There are no aggregation settings configured by default, so there will not be any listed the first accessing the menu.

To configure OSPF Area Aggregation on the switch, click the **Area Aggregation Configuration** link in the OSPF folder:

Area ID	Network Number	Network Mask	Advertisement	LSDB Type
---------	----------------	--------------	---------------	-----------

Figure 24- 12. OSPF Aggregation Configuration

To add an OSPF Area Aggregation entry on the switch, click the New button:

Area ID	<input type="text"/>	<input type="text"/>	<input type="text"/>	<input type="text"/>
Network Number	<input type="text"/>	<input type="text"/>	<input type="text"/>	<input type="text"/>
Network Mask	<input type="text"/>	<input type="text"/>	<input type="text"/>	<input type="text"/>
LSDB Type	Summary ▾			
Advertisement	Yes ▾			

Back Apply

Figure 24- 13. OSPF Aggregation Configuration – Add

Specify the OSPF Aggregation settings and click the **Apply** button to add or change the settings.

The following settings for OSPF Area Aggregation can be set or are displayed::

Parameter	Description
<b>Area ID</b>	Allows the entry the OSPF Area ID for which the routing information will be aggregated. This Area ID must be previously defined on the Switch.
<b>Network Number</b>	Sometimes called the Network Address. The 32-bit number in the form of an IP address that uniquely identifies the network that corresponds to the OSPF Area above.
<b>Network Mask</b>	The subnet mask used for the OSPF Area.
<b>LSDB Type</b>	Specify the type of address aggregation. Choose <i>Summary</i> or <i>NSSA-Ext</i> .
<b>Advertisement</b>	Select <i>Enabled</i> or <i>Disabled</i> to determine whether the selected OSPF Area will advertise it's summary LSDB (Network-Number and Network-Mask).



## OSPF Host Route Settings

OSPF host routes work in a way analogous to RIP, only this is used to share OSPF information with other OSPF routers. This is used to work around problems that might prevent OSPF information sharing between routers.

To configure OSPF host routes, click the **OSPF Host Route Settings** link. To add a new OSPF Route, click the **New** button. Configure the setting in the menu that appears.

Figure 24- 14. OSPF Host Route Settings

To add a OSPF Host Route on the switch, click the New button:

Figure 24- 15. OSPF Host Route Settings – Add

Specify the host route settings and click the **Apply** button to add or change the settings. The new settings will appear listed in the OSPF Host Route Settings list.

The following fields for OSPF host route can be set or are displayed::

Parameter	Description
<b>Host Address</b>	The IP address of the OSPF host.
<b>Metric</b>	A value between 1 and 65,535 that will be advertised for the route.
<b>Area ID</b>	A 32-bit number in the form of an IP address (xxx.xxx.xxx.xxx) that uniquely identifies the OSPF area in the OSPF domain.

## Route Redistribution Settings

Route redistribution allows routers on the network – that are running different routing protocols – to exchange routing information. This is accomplished by comparing the routes stored in the various router's routing tables and assigning appropriate metrics. This information is then exchanged among the various routers according to the individual routers current routing protocol. The DES-3326S can redistribute routing information between the OSPF and RIP routing protocols to all routers on the network that are running OSPF or RIP. Routing information entered into the Static Routing Table on the local DES-3326Ss Switch is also redistributed.

To configure Route Redistribution on the switch, click on the **Route Redistribution** link in the Layer 3 IP Network folder.

Route Redistribution Settings				
<input type="button" value="New"/> <input type="button" value="Edit"/> <input type="button" value="Delete"/>				
	Source Protocol	Destination Protocol	Type	Metric
<input type="radio"/>	RIP	OSPF	Type-2	2

Figure 24- 16. Route Redistribution Settings

To add a Route Redistribution setting on the switch, click the New button:

Route Redistribution Settings - Add	
Source Protocol	<input type="text" value="RIP"/>
Destination Protocol	<input type="text" value="RIP"/>
Type	<input type="text"/>
Metric	<input type="text"/>
<input type="button" value="Back"/> <input type="button" value="Apply"/>	

Figure 24- 17. Route Redistribution Settings – Add

To edit an existing Route Redistribution entry on the switch, select the entry from the Route Redistribution screen and click on the **Edit** button:

**Figure 24- 18. Route Redistribution – Edit**

Refer to the table below for descriptions of the Router Redistribution Table settings:

Parameter	Description
<b>Src Protocol</b>	Allows the selection of the protocol of the source device. Available choices are RIP, OSPF, or Static.
<b>Dest Protocol</b>	Allows the selection of the protocol of the destination device. Available choices are RIP and OSPF.
<b>Type</b>	Allows the selection of one of two methods for calculating the metric value. Type-1 calculates the metric (for RIP to OSPF) by adding the destination's interface cost to the metric entered in the Metric field. Type-2 uses the metric entered in the Metric field without change. This field applies only when the destination field is OSPF.
<b>Metric</b>	Allows the entry of an interface cost.

# Appendix A

## Technical Specifications

### General

<b>Standard</b>	IEEE 802.3 10BASE-T Ethernet IEEE 802.3u 100BASE-TX Fast Ethernet IEEE 802.3ab 1000BASE-T Gigabit Ethernet IEEE 802.3z 1000BASE-X Ethernet IEEE 802.1 P/Q VLAN IEEE 802.3x Full-duplex Flow Control	
<b>Protocols</b>	CSMA/CD	
<b>Data Transfer Rates:</b>	Half-duplex	Full-duplex
<b>Ethernet</b>	10 Mbps	20Mbps
<b>Fast Ethernet</b>	100Mbps	200Mbps
<b>Gigabit Ethernet</b>	N/A	2000Mbps
<b>Topology</b>	Star	
<b>Network Cables</b>	UTP Cat.5 for 100Mbps UTP Cat.3, 4, 5 for 10Mbps	
<b>Fiber Optic</b>	EIA/TIA-568 100-ohm screened twisted-pair (STP)(100m) IEC 793-2:1992 Type A1a - 50/125um multimode Type A1b - 62.5/125um multimode Both types use SC optical connector	
<b>Ports</b>	24 x 10/100 Mbps NWay ports 2 Gigabit Ethernet (optional)	

### Performance

<b>Transmission Method:</b>	Store-and-forward
<b>Packet Buffer Memory:</b>	8 MB per device
<b>Filtering Address Table:</b>	8 K MAC address per device
<b>Packet Filtering/ Forwarding Rate:</b>	Full-wire speed for all connections. 148,800 pps per port (for 100Mbps) 1,488,000 pps per port (for 1000Mbps)
<b>MAC Address Learning:</b>	Automatic update.
<b>Forwarding Table Age Time:</b>	Max age: 10 - 1000000 seconds. Default = 300.

**Physical & Environmental**

<b>AC inputs:</b>	100 - 240 VAC, 50/60 Hz (internal universal power supply)
<b>Power Consumption:</b>	29 watts maximum
<b>DC fans:</b>	2 built-in 40 x 40 x10 mm fan
<b>Operating Temperature:</b>	0 to 50 degrees Celsius (32 to 122 degrees Fahrenheit)
<b>Storage Temperature:</b>	-25 to 55 degrees Celsius (-13 to 131 degrees Fahrenheit)
<b>Humidity:</b>	Operating: 5% to 95% RH, non-condensing Storage: 0% to 95% RH, non-condensing
<b>Dimensions:</b>	441 mm x 210 mm x 43 mm (17.36 x 8.26 x 1.69 inches) 1UHeight, 19 inch rack-mount width
<b>Weight:</b>	2.5 kg (5.5 lbs.)
<b>EMI:</b>	FCC Class A, CE Mark, C-Tick
<b>Safety:</b>	CSA International

# Appendix B

## Network Addressing and Protocols

This appendix provides background information pertaining to Layer 3 IP networking including IP addressing, network protocols and the composition of packet headers.

### IP Addressing and Subnetting

This section gives basic information needed to configure your Layer 3 Switch for IP routing. The information includes how IP addresses are broken down and how subnetting works. You will learn how to assign each interface on the router an IP address with a unique subnet.

#### Definitions

- **IP Address** – the unique number ID assigned to each host or interface on a network. IP addresses have the form xxx.xxx.xxx.xxx.
- **Subnet** – a portion of a network sharing a particular network address.
- **Subnet mask** – a 32-bit number used to describe which portion of a Network Address refers to the subnet and which portion refers to the host. Subnet masks have the form xxx.xxx.xxx.xxx.
- **Interface** – a network connection
- **IP Interface** – another name for subnet.
- **Network Address** – the resulting 32-bit number from a bitwise logical AND operation performed between an IP address and a subnet mask.
- **Subnet Address** – another name for network address.

## IP Addresses

The Internet Protocol (IP) was designed for routing data between network sites. Later, it was adapted for routing between networks (referred to as “subnets”) within a site. The IP defines a way of generating a unique number that can be assigned each network in the internet and each of the computers on each of those networks. This number is called the IP address.

IP addresses use a “dotted decimal” notation. Here are some examples of IP addresses written in this format:

1. **210.202.204.205**
2. **189.21.241.56**
3. **125.87.0.1**

This allows IP address to be written in a string of 4 decimal (base 10) numbers. Computers can only understand binary (base 2) numbers, and these binary numbers are usually grouped together in bytes, or eight bits. (A bit is a binary digit – either a “1” or a “0”). The dots (periods) simply make the IP address easier to read. A computer sees an IP address not as four decimal numbers, but as a long string of binary digits (32 binary digits or 32 bits, IP addresses are 32-bit addresses).

The three IP addresses in the example above, written in binary form are:

1. **11010010.11001010.11001100.11001101**
2. **10111101.00010101.11110001.00111000**
3. **01111101.01010111.00000000.00000001**

The dots are included to make the numbers easier to read.

Eight binary bits are called a 'byte' or an 'octet'. An octet can represent any decimal value between '0' (00000000) and '255' (11111111). IP addresses, represented in decimal form, are four numbers whose value is between '0' to '255'. The total range of IP addresses are then:

**Lowest possible IP address - 0.0.0.0**  
**Highest possible IP address - 255.255.255.255**

To convert decimal numbers to 8-bit binary numbers (and vice-versa), you can use the following chart:

### Binary to Decimal Conversion

Binary Octet Digit	$2^7$	$2^6$	$2^5$	$2^4$	$2^3$	$2^2$	$2^1$	$2^0$
Decimal Equivalent	128	64	32	16	8	4	2	1
Binary Number $128+64+32+16+8+4+2+1=$ 255	1	1	1	1	1	1	1	1

Each digit in an 8-bit binary number (an octet) represents a power of two. The left-most digit represents 2 raised to the 7<sup>th</sup> power ( $2 \times 2 \times 2 \times 2 \times 2 \times 2 \times 2 = 128$ ) while the right-most digit represents 2 raised to the 0<sup>th</sup> power (any number raised to the 0<sup>th</sup> power is equal to one, by definition).

IP addresses actually consist of two parts, one identifying the network and one identifying the destination (node) within the network.

The IP address discussed above is one part and a second number called the Subnet mask is the other part. To make this a bit more confusing, the subnet mask has the same numerical form as an IP address.

### Address Classes

Address classes refer to the range of numbers in the subnet mask. Grouping the subnet masks into classes makes the task of dividing a network into subnets a bit easier.

There are 5 address classes. The first 4 bits in the IP address determine which class the IP address falls in.

- **Class A addresses begin with 0xxx, or 1 to 126 decimal.**
- **Class B addresses begin with 10xx, or 128 to 191 decimal.**
- **Class C addresses begin with 110x, or 192 to 223 decimal.**
- **Class D addresses begin with 1110, or 224 to 239 decimal.**
- **Class E addresses begin with 1111, or 240 to 254 decimal.**

Addresses beginning with 01111111, or 127 decimal, are reserved. They are used for internal testing on a local machine (called loopback). The address 127.0.0.1 can always be pinged from a local node because it forms a loopback and points back to the same node.

Class D addresses are reserved for multicasting.

Class E Addresses are reserved for future use. They are not used for node addresses.

The part of the IP address that belongs to the network is the part that is 'hidden' by the '1's in the subnet mask. This can be seen below:

- **Class A NETWORK.node.node.node**
- **Class B NETWORK.NETWORK.node.node**
- **Class C NETWORK.NETWORK.NETWORK.node**

For example, the IP address 10.42.73.210 is a Class A address, so the Network part of the address (called the *Network Address*) is the first octet (10.x.x.x). The node part of the address is the last three octets (x.42.73.210).

To specify the network address for a given IP address, the node part is set to all "0"s. In our example, 10.0.0.0 specifies the network address for 10.42.73.210. When the node part is set to all "1"s, the address specifies a broadcast address. So, 10.255.255.255 is the broadcast address for the network 10.0.0.0.





<b>Class A Subnet Masks</b>					
<b># of Bits</b>	<b>Subnet Mask</b>	<b>CIDR Notation</b>	<b># of Subnets</b>	<b># of Hosts</b>	<b>Total Hosts</b>
2	255.192.0.0	/10	2	4194302	8388604
3	255.224.0.0	/11	6	2097150	12582900
4	255.240.0.0	/12	14	1048574	14680036
5	255.248.0.0	/13	30	524286	15728580
6	255.252.0.0	/14	62	262142	16252804
7	255.254.0.0	/15	126	131070	16514820
8	255.255.0.0	/16	254	65534	16645636
9	255.255.128.0	/17	510	32766	16710660
10	255.255.192.0	/18	1022	16382	16742404
11	255.255.224.0	/19	2046	8190	16756740
12	255.255.240.0	/20	4094	4094	16760836
13	255.255.248.0	/21	8190	2046	16756740
14	255.255.252.0	/22	16382	1022	16742404
15	255.255.254.0	/23	32766	510	16710660
16	255.255.255.0	/24	65534	254	16645636
17	255.255.255.128	/25	131070	126	16514820
18	255.255.255.192	/26	262142	62	16252804
19	255.255.255.224	/27	525286	30	15728580
20	255.255.255.240	/28	1048574	14	14680036
21	255.255.255.248	/29	2097150	6	12582900
22	255.255.255.252	/30	4194302	2	8388604

<b>Class B Subnet Masks</b>					
<b># of Bits</b>	<b>Subnet Mask</b>	<b>CIDR Notation</b>	<b># of Subnets</b>	<b># of Hosts</b>	<b>Total Hosts</b>
2	255.255.192	/18	2	16382	32764
3	255.255.224.0	/19	6	8190	49140
4	255.255.240.0	/20	14	4094	57316
5	255.255.248.0	/21	30	2046	61380
6	255.255.252.0	/22	62	1022	63364
7	255.255.254.0	/23	126	510	64260
8	255.255.255.0	/24	254	254	64516
9	255.255.255.128	/25	510	126	64260
10	255.255.255.192	/26	1022	62	63364
11	255.255.255.224	/27	2046	30	61380
12	255.255.255.240	/28	4094	14	57316
13	255.255.255.248	/29	8190	6	49140
14	255.255.255.252	/30	16382	2	32764

<b>Class C Subnet Masks</b>					
<b># of Bits</b>	<b>Subnet Mask</b>	<b>CIDR Notation</b>	<b># of Subnets</b>	<b># of Hosts</b>	<b>Total Hosts</b>
2	255.255.255.192	/26	2	62	124
3	255.255.255.224	/27	6	30	180
4	255.255.255.240	/28	14	14	196
5	255.255.255.248	/29	30	6	180
6	255.255.255.252	/30	62	2	124

## Internet Protocols

This is a brief introduction to the suite of Internet Protocols frequently referred to as TCP/IP. It is intended to give the reader a reasonable understanding of the available facilities and some familiarity with terminology. It is not intended to be a complete description.

### Protocol Layering

The Internet Protocol (IP) divides the tasks necessary to route and forward packets across networks by using a layered approach. Each layer has clearly defined tasks, protocol, and interfaces for communicating with adjacent layers, but the exact way these tasks are accomplished is left to individual software designers. The Open Systems Interconnect (OSI) seven-layer model has been adopted as the reference for the description of modern networking, including the Internet.

A diagram of the OSI model is shown below (note that this is not a complete listing of the protocols contained within each layer of the model):

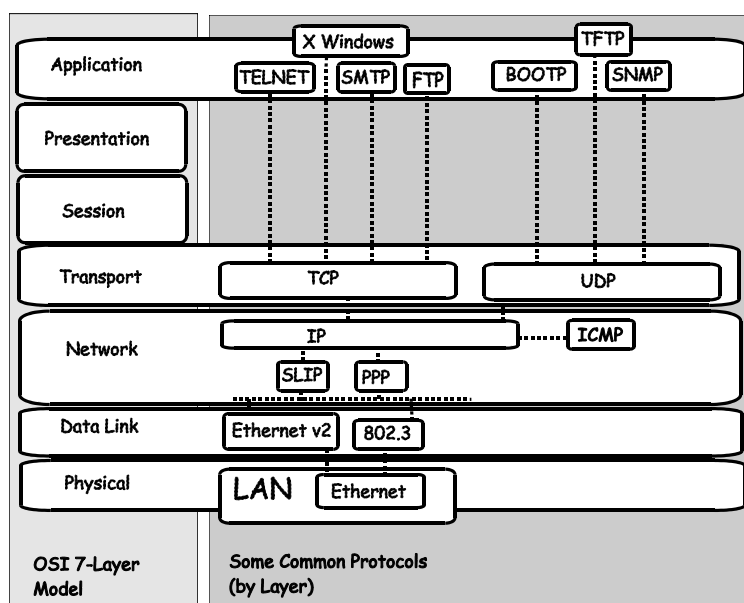

**Figure B- 1. OSI Seven Layer Network Model**

Each layer is a distinct set of programs executing a distinct set of protocols designed to accomplish some necessary tasks. They are separated from the other layers within the same system or network, but must communicate and interoperate. This requires very well-defined and well-known methods for transferring messages and data. This is accomplished through the protocol stack.

Protocol layering is simply a tool for visualizing the organization of the necessary software and hardware in a network. In this view, Layer 2 represents Switching and Layer 3 represents routing. Protocol layering is actually a set of guidelines used in writing programs and designing hardware that delegate network functions and allow the layers to communicate. How these layers communicate within a stack (for example, within a given computer) is left to the operating system programmers.

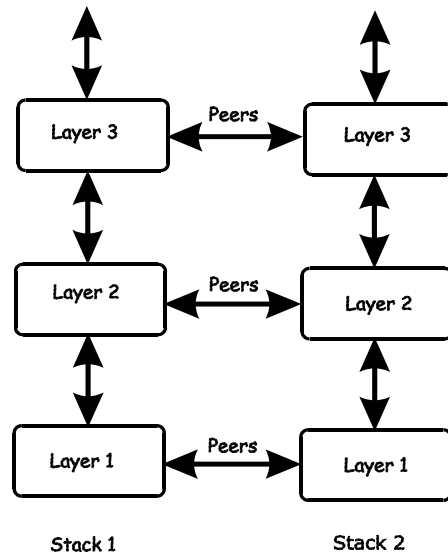

**Figure B- 2. The Protocol Stack**

Between two protocol stacks, members of the same layer are known as peers and communicate by well-known (open and published) protocols. Within a protocol stack, adjacent

layers communicate by an internal interface. This interface is usually not publicly documented and is frequently proprietary. It has some of the same characteristics of a protocol and two stacks from the same software vendor may communicate in the same way. Two stacks from different software vendors (or different products from the same vendor) may communicate in completely different ways. As long as peers can communicate and interoperate, this has no impact on the functioning of the network.

The communication between layers within a given protocol stack can be both different from a second stack and proprietary, but communication between peers on the same OSI layer is open and consistent.

A brief description of the most commonly used functional layers is helpful to understand the scope of how protocol layering works.

### Layer 1

This is referred to as the physical layer. It handles the electrical connections and signaling required to make a physical link from one point in the network to another. It is on this layer that the unique Media Access Control (MAC) address is defined.

### Layer 2

This layer, commonly called the Switching layer, allows end station addressing and the establishment of connections between them.

Layer 2 Switching forwards packets based on the unique MAC address of each end station and offers high-performance, dedicated-bandwidth of Fast or Gigabit Ethernet within the network.

Layer 2 does not ordinarily extend beyond the intranet. To connect to the Internet usually requires a router and a modem or other device to connect to an Internet Service Provider's WAN. These are Layer 3 functions.

### Layer 3

Commonly referred to as the routing layer, this layer provides logical partitioning of networks (subnetting), scalability, security, and Quality of Service (QoS).

The backbone of the Internet is built using Layer 3 functions. IP is the premier Layer 3 protocol.

IP is itself, only one protocol in the IP protocol suite. More extensive capabilities are found in the other protocols of the IP suite. For example; the Domain Name System (DNS) associates IP addresses with text names, the Dynamic Host Configuration Protocol (DHCP) eases the administration of IP addresses, and routing protocols such as the Routing Information Protocol (RIP), the Open Shortest Path First (OSPF), and the Border Gateway Protocol (BGP) enable Layer 3 devices to direct data traffic to the intended destination. IP security allows for authentication and encryption. IP not only allows for user-to-user communication, but also for transmission from point-to-multipoint (known as IP multicasting).

## Layer 4

This layer, known as the transport layer, establishes the communication path between user applications and the network infrastructure and defines the method of communicating. TCP and UDP are well-known protocols in the transport layer. TCP is a “connection-oriented” protocol, and requires the establishment of parameters for transmission prior to the exchange of data. Web technology is based on TCP. UDP is “connectionless” and requires no connection setup. This is important for multicast traffic, which cannot tolerate the overhead and latency of TCP. TCP and UDP also differ in the amount of error recovery provided and whether or not it is visible to the user application. Both TCP and UDP are layered on IP, which has minimal error recovery and detection. TCP forces retransmission of data that was lost by the lower layers, UDP does not.

## Layer 7

This layer, known as the application layer, provides access to either the end user application software such as a database. Users communicate with the application, which in turn delivers data to the transport layer. Applications do not usually communicate directly with lower layers. They are written to use a specific communication library, like the popular WinSock library.

Software developers must decide what type of transport mechanism is necessary. For example, Web access requires reliable, error-free access and would demand TCP, Multimedia, on the other hand, requires low overhead and latency and commonly uses UDP.

## TCP/IP

The TCP/IP protocol suite is a set of protocols that allow computers to share resources across a network. TCP and IP are only two of the Internet suite of protocols, but they are the best known and it has become common to refer the entire family of Internet protocols as TCP/IP.

TCP/IP is a layered set of protocols. An example, such as sending e-mail, can illustrate this. There is first a protocol for sending and receiving e-mail. This protocol defines a set of commands to identify the sender, the recipient, and the content of the e-mail. The e-mail protocol will not handle the actual communication between the two computers, this is done by TCP/IP. TCP/IP handles the actual sending and receiving of the packets that make up the e-mail exchange.

TCP makes sure the e-mail commands and messages are received by the appropriate computers. It keeps track of what is sent and what is received, and retransmits any packets that are lost or dropped. TCP also handles the division of large messages into several Ethernet packets, and makes sure these packets are received and reassembled in the correct order.

Because these functions are required by a large number of applications, they are grouped into a single protocol, rather than being the part of the specifications for just sending e-mail. TCP is then a library of routines that application software can use when reliable network communications are required.

IP is also a library of routines, but with a more general set of functions. IP handles the routing of packets from the source to the destination. This may require the packets to traverse many different networks. IP can route packets through the necessary gateways and provides the functions required for any user on one network to communicate with any user on another connected network.

The communication interface between TCP and IP is relatively simple. When IP received a packet, it does not know how this packet is related to others it has sent (or received) or even which connection the packet is part of. IP only knows the address of the source and the destination of the packet, and it makes its best effort to deliver the packet to its destination.

The information required for IP to do its job is contained in a series of octets added to the beginning of the packet called headers. A header contains a few octets of data added to the packet by the protocol in order to keep track of it.

Other protocols on other network devices can add and extract their own headers to and from packets as they cross networks. This is analogous to putting data into an envelope and sending the envelope to a higher-level protocol, and having the higher-level protocol put the entire envelope into its own, larger envelope. This process is referred to as encapsulation.

Many levels of encapsulation are required for a packet to cross the Internet.

## Packet Headers

### TCP

Most data transmissions are much longer than a single packet. The data must then be divided up among a series of packets. These packets must be transmitted, received and then reassembled into the original data. TCP handles these functions.

TCP must know how large a packet the network can process. To do this, the TCP protocols at each end of a connection state how large a packet they can handle and the smaller of the two is selected.

The TCP header contains at least 20 octets. The source and destination TCP port numbers are the most important fields. These specify the connection between two TCP protocols on two network devices.

The header also contains a sequence number that is used to ensure the packets are received in the correct order. The packets are not numbered, but rather the octets the packets contain are. If there are 100 octets of data in each packet, the first packet is numbered 0, the second 100, the third 200, etc.

To insure that the data in a packet is received uncorrupted, TCP adds the binary value of all the octets in the packet and writes the sum in the checksum field. The receiving TCP recalculates the checksum and if the numbers are different, the packet is dropped.

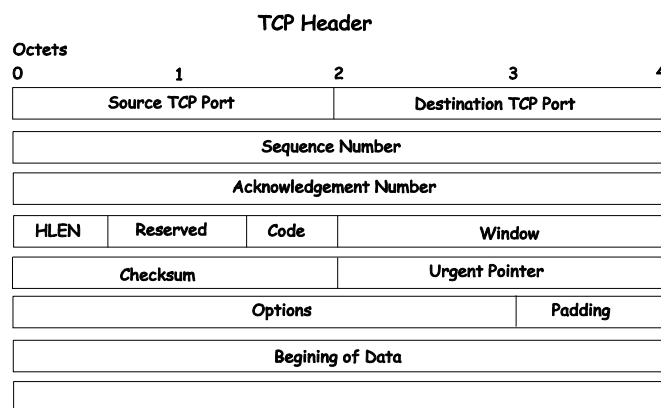

When packets have been successfully received, TCP sends an acknowledgement. This is simply a packet that has the acknowledgement number field filled in.

An acknowledgement number of 1000 indicates that all of the data up to octet 1000 has been received. If the transmitting TCP does not receive an acknowledgement in a reasonable amount of time, the data is resent.

The window field controls the amount of data being sent at any one time. It would require too much time and overhead to acknowledge each packet received. Each end of the TCP connection declares how much data it is able to receive at any one time by writing this number of octets in the window field.

The transmitting TCP decrements the number in the window field and when it reaches zero, the transmitting TCP stops sending data. When the receiving TCP can accept more data, it increases the number in the window field. In practice, a single packet can acknowledge the receipt of data and give permission for more data to be sent.

## IP

TCP sends its packets to IP with the source and destination IP addresses. IP is only concerned with these IP addresses. It is not concerned with the contents of the packet or the TCP header.

IP finds a route for the packet to get to the other end of the TCP connection. IP adds its own header to the packet to accomplish this.

The IP header contains the source and destination addresses, the protocol number, and another checksum.

The protocol number tells the receiving IP which protocol to give the packet to. Although most IP traffic uses TCP, other protocols can be used (such as UDP).

The checksum is used by the receiving IP in the same way as the TCP checksum.

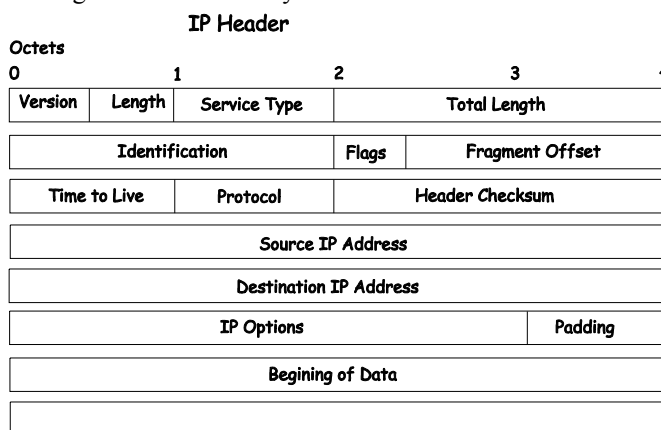

The flags and fragment offset are used to keep track of packets that must be divided among several smaller packets to cross networks for which they are too large.

The Time-to-Live (TTL) is the number of gateways the packet is allowed to cross between the source and destination. This number is decremented by one when the packet crosses a gateway and when the TTL reaches zero, the packet is dropped. This helps reduce network traffic if a loop develops.

### Ethernet

Every active Ethernet device has its own Ethernet address (commonly called the MAC address) assigned to it by the manufacturer. Ethernet uses 48 bit addresses.

The Ethernet header is 14 octets that include the source and destination MAC address and a type code.

There is no relationship between the MAC address of a network node and its IP address. There must be a database of Ethernet addresses and their corresponding IP addresses.

Different protocol families can be in use on the same network. The type code field allows each protocol family to have its own entry.

A checksum is calculated and when the packet is received, the checksum is recalculated. If the two checksums are different, the packet is dropped.

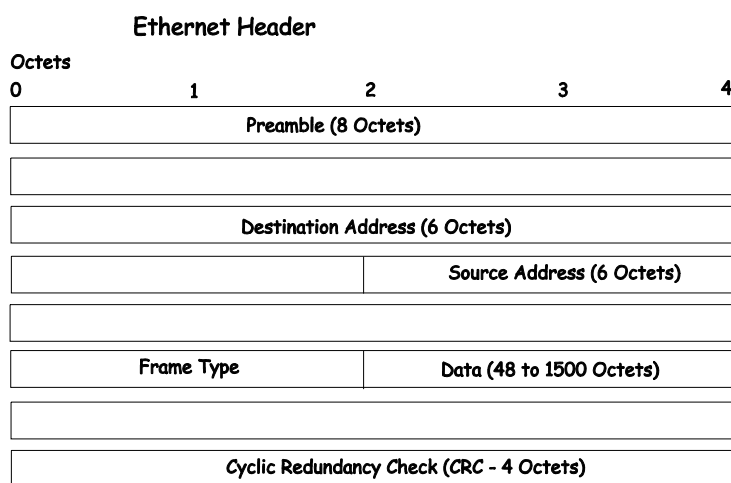

When a packet is received, the headers are removed. The Ethernet Network Interface Card (NIC) removes the Ethernet header and checks the checksum. It then looks at the type code. If the type code is for IP, the packet is given to IP. IP then removes the IP header and looks at its protocol field. If the protocol field is TCP, the packet is sent to TCP. TCP then looks at the sequence number and uses this number and other data from the headers to reassemble the data into the original file.

## TCP and UDP Well-Known Ports

Application protocols run ‘on top of’ TCP/IP. When an application wants to send data or a message, it gives the data to TCP. Because TCP and IP take care of the networking details, the application can look at the network connection as a simple data stream.

To transfer a file across a network using the File Transfer Protocol (FTP), a connection must first be established. The computer requesting the file transfer must connect specifically to the FTP server on the computer that has the file.

This is accomplished using sockets. A socket is a pair of TCP port numbers used to establish a connection from one computer to another. TCP uses these port numbers to keep track of connections. Specific port numbers are assigned to applications that wait for requests. These port numbers are referred to as ‘well-known’ ports.

TCP will open a connection to the FTP server using some random port number, 1234 for example, on the local computer. TCP will specify port 21 for the FTP server. Port 21 is the well-known port number for FTP servers. Note that there are two different FTP programs running in this example – an FTP client that requests the file to be transferred, and an FTP server that sends the file to the FTP client. The FTP server accepts commands from the client, so the FTP client must know how to connect to the server (must know the TCP port number) in order to send commands. The FTP Server can use any TCP port number to send the file, so long as it is sent as part of the connection setup.

A TCP connection is then described by a set of four numbers – the IP address and TCP port number for the local computer, and the IP address and TCP port number for the remote computer. The IP address is in the IP header and the TCP port number is in the TCP header.

No two TCP connection can have the same set of numbers, but only one number needs to be different. It is possible, for example, for two users to send files to the same destination at the same time. This could give the following connection numbers:

	Internet addresses	TCP ports
Connection 1	10.42.73.23, 10.128.12.1	1234, 21
Connection 2	10.42.73.23, 10.128.12.1	1235, 21

The same computers are making the connections, so the IP addresses are the same. Both computers are using the same well-known TCP port for the FTP server. The local FTP clients are using different TCP port numbers.

FTP transfers actually involve two different connections. The connection begins by the FTP sending commands to send a particular file. Once the commands are sent, a second connection is opened for the actual data transfer. Although it is possible to send data on the same connection, it is very convenient for the FTP client to be able to continue to send commands (such as ‘stop sending this file’).

## UDP and ICMP

There are many applications that do not require long messages that cannot fit into a single packet. Looking up computer names is an example. Users wanting to make connections to other computers will usually use a name rather than the computer’s IP or MAC address. The user’s computer must be able to determine the remote computer’s address before a connection can be made. A designated computer on the network will contain a database of computer names and their corresponding IP and MAC addresses. The user’s computer will send a query to the name database computer, and the database computer will send a response. Both the query and the response are very short. There is no need to divide the query or response between multiple packets, so the complexity of TCP is not required. If there is no response to the query after a period of time, the query can simply be resent.

The User Datagram Protocol (UDP) is designed for communications that do not require division among multiple packets and subsequent reassembly. UDP does not keep track of what is sent.

UDP uses port numbers in a way that is directly analogous to TCP. There are well-known UDP port numbers for servers that use UDP.



### UDP Header

Octets	0	1	2	3	4
	Source UDP Port		Destination UDP Port		
	UDP Message Length		UDP Checksum		
	Beginning of Data				

The UDP header is shorter than a TCP header. UDP also uses a checksum to verify that data is received uncorrupted.

The Internet Control Message Protocol (ICMP) is also a simplified protocol used for error messages and messages used by TCP/IP. ICMP, like UDP, processes messages that will fit into a single packet. ICMP does not, however use ports because its messages are processed by the network software.

## The Domain Name System

Computer users usually prefer to use text names for computers they may want to open a connection with. Computers themselves, require 32 bit IP addresses. Somewhere, a database of network devices' text names and their corresponding IP addresses must be maintained.

The Domain Name System (DNS) is used to map names to IP addresses throughout the Internet and has been adapted for use within intranets.

For two DNS servers to communicate across different subnets, the **DNS Relay** of the DES-3326S must be used. The DNS servers are identified by IP addresses.

### Mapping Domain Names to Addresses

Name-to-address translation is performed by a program called a Name server. The client program is called a Name resolver. A Name resolver may need to contact several Name servers to translate a name to an address.

The Domain Name System (DNS) servers are organized in a somewhat hierarchical fashion. A single server often holds names for a single network, which is connected to a root DNS server – usually maintained by an ISP.

### Domain Name Resolution

The domain name system can be used by contacting the name servers one at a time, or by asking the domain name system to do the complete name translation. The client makes a query containing the name, the type of answer required, and a code specifying whether the domain name system should do the entire name translation, or simply return the address of the next DNS server if the server receiving the query cannot resolve the name.

When a DNS server receives a query, it checks to see if the name is in its subdomain. If it is, the server translates the name and appends the answer to the query, and sends it back to the client. If the DNS server cannot translate the name, it determines what type of name resolution the client requested. A complete translation is called recursive resolution and requires the server to contact other DNS servers until the name is resolved. Iterative resolution specifies that if the DNS server cannot supply an answer, it returns the address of the next DNS server the client should contact.

Each client must be able to contact at least one DNS server, and each DNS server must be able to contact at least one root server.

The address of the machine that supplies domain name service is often supplied by a DHCP or BOOTP server, or can be entered manually and configured into the operating system at startup.

## DHCP Servers

The Dynamic Host Configuration Protocol (DHCP) is used to dynamically assign a TCP/IP network configuration to network devices and computers on the network. It also ensures that IP address conflicts do not occur.

IP addresses are assigned from a pool of free addresses. Each IP address assigned has a 'lease' and a 'lease expiration period'. The lease must be periodically renewed. If the lease expires, the IP address is returned to the pool of available IP addresses.

Usually, it is a network policy to assign the same IP address to a given network device or computer each time.

If the IP address lease expires, the network device sends a message to the DHCP server requesting a lease renewal. The DHCP server can send an acknowledgement containing a new lease and updated configuration information.

If an IP address lease cannot be renewed, the network device or computer sends a request to all local DHCP servers attempting to renew the lease. If the DHCP returns a negative acknowledgement, the network device must release its TCP/IP configuration and reinitialize.

When a new TCP/IP configuration is received from a DHCP server, the network device checks for a possible IP address conflict by sending an Address Resolution Protocol (ARP) request that contains its new IP address.

For two DHCP servers to communicate across different subnets, the **BOOTP/DHCP Relay** of the DES-3326S must be used. The DHCP servers are identified by IP addresses.

## Appendix C

# IP Routing, Multicasting, Multicast Routing and Routing Protocols

IP handles the task of determining how packets will get from their source to their destination. This process is referred to as routing.

For IP to work, the local system must be attached to a network. It is safe to assume that any system on this network can send packets to any other system, but when packets must cross other networks to reach a destination on a remote network, these packets must be handled by gateways (also called routers).

Gateways connect a network with one or more other networks. Gateways can be a computer with two network interfaces or a specialized device with multiple network interfaces. The device is designed to forward packets from one network to another.

IP routing is based on the network address of the destination IP address. Each computer has a table of network addresses. For each network address, a corresponding gateway is listed. This is the gateway to use to communicate with that network. The gateway does not have to be directly connected to the remote network, it simply needs to be the first place to go on the way to the remote network.

Before a local computer sends a packet, it first determines whether the destination address is on the local network. If it is, the packet can be sent directly to the remote device. If it is not, the local computer looks for the network address of the destination and the corresponding gateway address. The packet is then sent to the gateway leading to the remote network. There is often only one gateway on a network.

A single gateway is usually defined as a default gateway, if that gateway connects the local network to a backbone network or to the Internet. This default gateway is also used whenever no specific route is found for a packet, or when there are several gateways on a network.

Local computers can use default gateways, but the gateways themselves need a more complete routing table to be able to forward packets correctly. A protocol is required for the gateways to be able to communicate between themselves and to keep their routing tables updated.

### Packet Fragmentation and Reassembly

TCP/IP can be used with many different types of networks, but not all network types can handle the same length packets.

When IP is transmitting large files, large packets are much more efficient than small ones. It is preferable to use the largest possible packet size, but still be able to cross networks that require smaller packets.

To do this, IP can 'negotiate' packet size between the local and remote ends of a connection. When an IP connection is first made, the IPs at both ends of the connection state the largest packet they can handle. The smaller of the two is selected.

When a IP connection crosses multiple networks, it is possible that one of the intermediate networks has a smaller packet size limit than the local or remote network. IP is not able to determine the maximum packet size across all of the networks that may make up the route for a connection. IP has, therefore, a method to divide packets into multiple, smaller packets to cross such networks. This division of large packets into smaller packets is referred to as fragmentation.

A field in the TCP header indicates that a packet has been fragmented, and other information aids in the reassembly of the packets into the original data.

Gateways that connect networks of different packet size limits split the large packets into smaller ones and forward the smaller packets on their attached networks.

## **ARP**

The Address Resolution Protocol (ARP) determines the MAC address and IP address correspondence for a network device.

A local computer will maintain an ARP cache which is a table of MAC addresses and the corresponding IP addresses. Before a connection with another computer is made, the local computer first checks its ARP cache to determine whether the remote computer has an entry. If it does, the local computer reads the remote computer's MAC address and writes it into the destination field of the packets to be sent.

If the remote computer does not have an ARP cache entry, the local computer must send an ARP request and wait for a reply.

When the local computer receives the ARP reply packet, the local ARP reads the IP MAC address pair, and then checks the ARP cache for this entry. If there is an entry, it is updated with the new information. If there is no entry, a new entry is made.

There are two possible cases when an ARP packet is received by a local computer. First, the local computer is the target of the request. If it is, the local ARP replies by sending its MAC IP address pair back to the requesting system. Second, if the local computer is not the target of the request, the packet is dropped.

## Multicasting

Multicasting is a group of protocols and tools that enable a single source point to send packets to groups of multiple destination points with persistent connections that last for some amount of time. The main advantage to multicasting is a decrease in the network load compared to broadcasting.

### Multicast Groups

Class D IP addresses are assigned to a group of network devices that comprise a multicast group. The four most significant four bits of a Class D address are set to “1110”. The following 28 bits is referred to as the ‘multicast group ID’. Some of the range of Class D addresses are registered with the Internet Assigned Numbers Authority (IANA) for special purposes. For example, the block of multicast addresses ranging from 224.0.0.1 to 224.0.0.225 is reserved for use by routing protocols and some other low-level topology discovery and maintenance protocols.

#### IP Multicast Address Format



Some of the reserved IP multicast addresses are as follows:

### Reserved Multicast Address Assignment

Address	Assignment
224.0.0.0	Base Address (reserved)
224.0.0.1	All Systems on this subnet
224.0.0.2	All Routers on this subnet
224.0.0.3	Unassigned
224.0.0.4	DVMRP Routers
224.0.0.5	OSPF IGP Routers
224.0.0.6	OSPF IGP Designated Routers
224.0.0.7	ST Routers
224.0.0.8	ST Hosts
224.0.0.9	All RIP2 Routers
224.0.0.10	All IGRP Routers
224.0.0.11	Mobile Agents
224.0.0.12	DHCP Servers and Relay Agents
224.0.0.13	All PIM Routers
224.0.0.14	RSVP Encapsulation
224.0.0.15	All CBT Routers
224.0.0.16	Designated Sbm
224.0.0.17	All Sbms
224.0.0.18	VRRP
224.0.0.19	Unassigned
through	
224.0.0.225	
224.0.0.21	DVMRP on MOSPF

## Internet Group Management Protocol (IGMP)

End users that want to receive multicast packets must be able to inform nearby routers that they want to become a multicast group member of the group these packets are being sent to. The Internet Group Management Protocol (IGMP) is used by multicast routers to maintain multicast group membership. IGMP is also used to coordinate between multiple multicast routers that may be present on a network by electing one of the multicast routers as the ‘querier’. This router then keep track of the membership of multicast groups that have active members on the network. IGMP is used to determine whether the router should forward multicast packets it receives to the subnetworks it is attached to or not. A multicast router that has received a multicast packet will check to determine if there is at least one member of a multicast group that has requested to receive multicast packets from this source. If there is one member, the packet is forwarded. If there are no members, the packet is dropped.

### IGMP Versions 1 and 2

Users that want to receive multicast packets need to be able to join and leave multicast groups. This is accomplished using IGMP.

#### IGMP Message Format

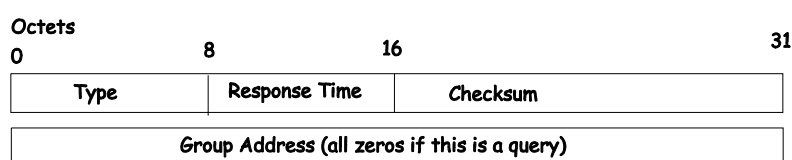

The IGMP Type codes are shown below:

#### IGMP Type Codes

Type	Meaning
0x11	Membership Query (if Group Address is 0.0.0.0)
0x11	Specific Group Membership Query (if Group Address is Present)
0x16	Membership Report (version 2)
0x17	Leave a Group (version 2)
0x12	Membership Report (version 1)

Multicast routers use IGMP to manage multicast group memberships:

- An IGMP “report” is sent by a user’s computer to join a group
- IGMP version 1 does not have an explicit ‘leave’ message. Group members have an expiration timer, and if this timer expires before a query response is returned, the member is dropped from the group.
- IGMP version 2 introduces an explicit “leave” report. When a user wants to leave a group, this report is sent to the multicast router (for IGMP version 2).
- Multicast routers send IGMP queries (to the all-hosts group address: 224.0.0.1) periodically to see whether any group members exist on their subnetworks. If there is no response from a particular group, the router assumes that there are no group members on the network, and multicast packets are not forwarded.

The TTL field of query messages is set to 1 so that the queries do not get forwarded to other subnetworks.

IGMP version 2 introduces a few extensions to IGMP version 1 such as, the election of a single multicast querier for each network, explicit ‘leave’ reports, and queries that are specific to a particular multicast group.

The router with the lowest IP address is elected as the querier. The explicit group leave message is added to decrease latency, and routers can ask for membership reports from a particular multicast group ID.

The transition states a host will go through to join or leave a multicast group are shown in the diagram below.

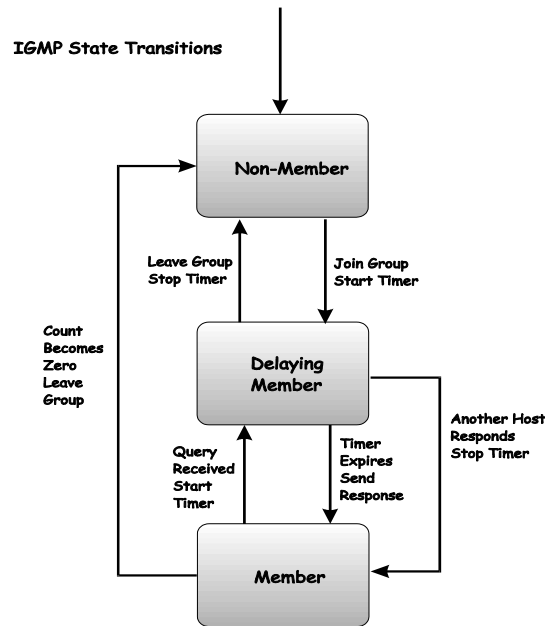

## Multicast Routing Algorithms

*An algorithm is not a program. An algorithm is a statement of how a problem can be solved. A program is written to implement an algorithm.*

Multicast packets are delivered by constructing multicast trees where the multicast router is the trunk, the branches are the various subnetworks that may be present, and the leaves are end recipients of the multicast packets. Several algorithms have been developed to construct these trees and to prune branches that have no active multicast group members.

## Flooding

The simplest algorithm for the delivery of multicast packets is for the multicast router to forward a multicast packet to all interfaces. This is referred to as flooding. An equally simple refinement of flooding is to have the router check to determine if a given multicast packet has been received before (in a certain amount of time). If it has, then the packet does not need to be forwarded at all and can be dropped. If the packet is being received for the first time, it should be flooded to all interface, except the interface on which it was received. This will ensure that all routers on the network will receive at least one copy of the multicast packet.

There are some obvious disadvantages to this simple algorithm. Flooding duplicates a lot of packets and uses a lot of network bandwidth. A multicast router must also keep a record of the multicast packets it has received (for a period of time) to determine if a given packet has been previously received. So flooding uses a lot of router memory.

## Multicast Spanning Trees

A multicast delivery tree that spans the entire network with a single active link between routers (or subnetwork) is called a multicast spanning tree. Links (or branches) are chosen such that there is only one active path between any two routers. When a router receives a multicast packet, it forwards the packet on all links except the one on which it was received. This guarantees that all routers in the network will receive a copy of the packet. The only information the router needs to store is whether a link is a part of the spanning tree (leads to a router) or not.

Multicast spanning trees do not use group membership information when deciding to forward or drop a given multicast packet.

## Reverse Path Broadcasting (RPB)

The Reverse Path Broadcasting (RPB) algorithm is an enhancement of the multicast spanning tree algorithm. RPB constructs a spanning tree for each multicast source. When the router receives a multicast packet, it then checks to determine

if the packet was received on the shortest path back from the router to the source. If the packet was received on the shortest path back to the source, the packet is forwarded on all links except the link on which the packet was received. If the packet was not received on the shortest link back to the source, the packet is dropped.

If a link-state routing protocol is in use, RPB on a local router can determine if the path from the source through the local router to an immediately neighboring router. If it is not, the packet will be dropped at the next router and the packet should not be forwarded.

If a distance-vector routing protocol is in use, a neighboring router can either advertise its previous hop for the source as part of its routing update messages. This will 'poison-reverse' the route (or have the local router prune the branch from the multicast source to the neighboring router because the neighboring router has a better route from the source to the next router or subnetwork).

Since multicast packets are forwarded through the shortest route between source and destination, RPB is fast. A given router also does not need information about the entire spanning tree, nor does it need a mechanism to stop the forwarding of packets.

RPB does not use multicast group membership information in its forwarding decisions.

### **Reverse Path Multicasting (RPM)**

Reverse Path Multicasting (RPM) introduces an enhancement to RPB – an explicit method to prune branches of the spanning tree that have no active multicast group members for the source. RPM constructs a tree that spans only subnetworks with multicast group member and routers along the shortest path between the source and the destinations.

When a multicast router receives a multicast packet, it is forwarded using the RPB constructed spanning tree. Subsequent routers in the tree that have no active path to another router are referred to as leaf routers. If the multicast packet is forwarded to a leaf router that has no active multicast group members for the source, the leaf router will send a prune message to the previous router. This will remove the leaf router's branch from the spanning tree, and no more multicast packets (from that source) will be forwarded to it. Prune messages have a TTL equal to one, so they can be sent only one hop (one router) back toward the source. If the previous router receives prune messages from all of its branch and leaf routers, the previous router will then send its own prune message back one router toward the multicast source, and the process will repeat. In this way, multicast group membership information can be used to prune the spanning tree between a given multicast source and the corresponding multicast group.

Since the membership of any given multicast group can change and the network topology can also change, RPM periodically removes all of the prune information it has gathered from its memory, and the entire process repeats. This gives all subsequent routers on the network a chance to receive multicast packets from all multicast sources on the network. It also gives all users a chance to join a given multicast group.

## **Multicast Routing Protocols**

This section contains an overview of two multicast routing protocols – Distance Vector Multicast Routing Protocol (DVMRP), and Protocol Independent Multicast-Dense Mode

(PIM-DM). The most commonly used routing protocol (not a multicast routing protocol), the Routing Information Protocol, is discussed in a later section.

### **Distance Vector Multicast Routing Protocol (DVMRP)**

The Distance Vector Multicast Routing Protocol (DVMRP) was derived from the Routing Information Protocol (RIP) with the introduction of multicast delivery trees constructed from information about the 'distance' from the local router back toward the multicast source. DVMRP uses an RPM algorithm to construct its multicast delivery trees.

The first multicast packet received by a multicast router using DVMRP is flooded to all interfaces except the one on which the packet was received. Subsequent prune messages are used to prune branches of the delivery tree that are either not on the shortest path back to the multicast source, or that have no active multicast group members. A 'graft' message is added that allows a previously pruned branch of the multicast delivery tree to be reactivated. This allows for lower latency when a leaf router adds a new member to a multicast membership group. Graft messages are forwarded one hop (one router) back at a time toward a multicast source until they reach a router that is on an active branch of the multicast delivery tree.

If there is more than one multicast router on a network, the one that has the shortest path back to the multicast source is elected to forward multicast packets from that source. All other routers will discard multicast packets from that source. If



two multicast routers on a network have the same distance back to a multicast source, the router with the lowest IP address is elected.

DVMRP also supports tunnel interfaces, where two multicast routers are connected through a router that cannot process multicast packets. This allows multicast packets to cross networks with routers that are not multicast-aware.

### **Protocol-Independent Multicast – Dense Mode**

There are two protocols in Protocol Independent Multicast (PIM), Protocol Independent Multicast-Dense Mode (PIM-DM) which is used when the multicast destinations are closely spaced, and Protocol Independent Multicast-Sparse Mode (PIM-SM) which is used when the multicast destinations are spaced further apart. PIM-DM is most commonly implemented in an intranetwork (LAN) where the distance between users is minimal.

## **Routing Protocols**

### **Routing Information Protocol (RIP)**

The Routing Information Protocol is a distance-vector routing protocol. There are two types of network devices running RIP – active and passive. Active devices advertise their routes to others through RIP messages, while passive devices listen to these messages. Both active and passive routers update their routing tables based upon RIP messages that active routers exchange. Only routers can run RIP in the active mode.

Every 30 seconds, a router running RIP broadcasts a routing update containing a set of pairs of network addresses and a distance (represented by the number of hops or routers between the advertising router and the remote network). So, the vector is the network address and the distance is measured by the number of routers between the local router and the remote network.

RIP measures distance by an integer count of the number of hops from one network to another. A router is one hop from a directly connected network, two hops from a network that can be reached through a router, etc. The more routers between a source and a destination, the greater the RIP distance (or hop count).

There are a few rules to the routing table update process that help to improve performance and stability. A router will not replace a route with a newly learned one if the new route has the same hop count (sometimes referred to as ‘cost’). So learned routes are retained until a new route with a lower hop count is learned.

When learned routes are entered into the routing table, a timer is started. This timer is restarted every time this route is advertised. If the route is not advertised for a period of time (usually 180 seconds), the route is removed from the routing table.

RIP does not have an explicit method to detect routing loops. Many RIP implementations include an authorization mechanism (a password) to prevent a router from learning erroneous routes from unauthorized routers.

To maximize stability, the hop count RIP uses to measure distance must have a low maximum value. Infinity (that is, the network is unreachable) is defined as 16 hops. In other words, if a network is more than 16 routers from the source, the local router will consider the network unreachable.

RIP can also be slow to converge (to remove inconsistent, unreachable or looped routes from the routing table) because RIP messages propagate relatively slowly through a network.

Slow convergence can be solved by using split horizon update, where a router does not propagate information about a route back to the interface on which it was received. This reduces the probability of forming transient routing loops.

Hold down can be used to force a router to ignore new route updates for a period of time (usually 60 seconds) after a new route update has been received. This allows all routers on the network to receive the message.

A router can ‘poison reverse’ a route by adding an infinite (16) hop count to a route’s advertisement. This is usually used in conjunction with triggered updates, which force a router to send an immediate broadcast when an update of an unreachable network is received.

### **RIP Version 1 Message Format**

There are two types of RIP messages: routing information messages and information requests. The same format is used by both types.

RIP Version 1 Message Format				
Octets	1	2	3	4
0	Command	Version	Must be all zeros	
Family of Source Network		Must be all zeros		
IP Address of Source				
Must be all zeros				
Must be all zeros				
Distance to Source Network				
Family of Destination Network		Must be all zeros		
IP Address of Destination				
Must be all zeros				
Must be all zeros				
Distance to Destination Network				

The COMMAND field specifies an operation according the following table:

#### RIP Command Codes

Command	Meaning
1	Request for partial or full routing information
2	Response containing network-distance pairs from sender's routing table
3	Turn on trace mode (obsolete)
4	Turn off trace mode (obsolete)
5	Reserved for Sun Microsystem's internal use
9	Update Request
10	Update Response
11	Update Acknowledgement

The field VERSION contains the protocol version number (1 in this case), and is used by the receiver to verify which version of RIP the packet was sent.

#### RIP 1 Message

RIP is not limited to TCP/IP. Its address format can support up to 14 octets (when using IP, the remaining 10 octets must be zeros). Other network protocol suites can be specified in the Family of Source Network field (IP has a value of 2). This will determine how the address field is interpreted.

RIP specifies that the IP address 0.0.0.0 denotes a default route.

The distances, measured in router hops are entered in the Distance to Source Network, and Distance to Destination Network fields.

#### RIP 1 Route Interpretation

RIP was designed to be used with classed address schemes, and does not include an explicit subnet mask. An extension to version 1 does allow routers to exchange subnetted addresses, but only if the subnet mask used by the network is the same as the subnet mask used by the address. This means the RIP version 1 cannot be used to propagate classless addresses.

Routers running RIP version 1 must send different update messages for each IP interface to which it is connected. Interfaces that use the same subnet mask as the router's network can contain subnetted routes, other interfaces cannot. The router will then advertise only a single route to the network.

### RIP Version 2 Extensions

RIP version 2 includes an explicit subnet mask entry, so RIP version 2 can be used to propagate variable length subnet addresses or CIDR classless addresses. RIP version 2 also adds an explicit next hop entry, which speeds convergence and helps prevent the formation of routing loops.

### RIP2 Message Format

The message format used with RIP2 is an extension of the RIP1 format:

<b>RIP Version 2 Message Format</b>					
Octets	0	1	2	3	4
	Command	Version	Must be all zeros		
	Family of Source Network		Route Tag for Source Network		
	IP Address of Source				
	Subnet Mask for Source				
	Next Hop for Source Network				
	Distance to Source Network				
	Family of Destination Network		Route Tag for Destination Network		
	IP Address of Destination				
	Subnet Mask for Destination				
	Next Hop for Destination Network				
	Distance to Destination Network				

RIP version 2 also adds a 16-bit route tag that is retained and sent with router updates. It can be used to identify the origin of the route.

Because the version number in RIP2 occupies the same octet as in RIP1, both versions of the protocols can be used on a given router simultaneously without interference.

## Glossary

**100BASE-FX:** 100Mbps Ethernet implementation over fiber.

**100BASE-TX:** 100Mbps Ethernet implementation over Category 5 and Type 1 Twisted Pair cabling.

**10BASE-T:** The IEEE 802.3 specification for Ethernet over Unshielded Twisted Pair (UTP) cabling.

**ageing:** The automatic removal of dynamic entries from the Switch Database which have timed-out and are no longer valid.

**ATM:** Asynchronous Transfer Mode. A connection oriented transmission protocol based on fixed length cells (packets). ATM is designed to carry a complete range of user traffic, including voice, data, and video signals.

**auto-negotiation:** A feature on a port that allows it to advertise its capabilities for speed, duplex, and flow control. When connected to an end station that also supports auto-negotiation, the link can self-detect its optimum operating setup.

**backbone port:** A port that does not learn device addresses, and which receives all frames with an unknown address. Backbone ports are normally used to connect the Switch to the backbone of your network. Note that backbone ports were formerly known as designated downlink ports.

**Backbone:** The part of a network used as the primary path for transporting traffic between network segments.

**bandwidth:** Information capacity, measured in bits per second, that a channel can transmit. The bandwidth of Ethernet is 10Mbps, the bandwidth of Fast Ethernet is 100Mbps.

**BOOTP:** The BOOTP protocol allows you to automatically map an IP address to a given MAC address each time a device is started. In addition, the protocol can assign the subnet mask and default gateway to a device.

**bridge:** A device that interconnects local or remote networks no matter what higher level protocols are involved. Bridges form a single logical network, centralizing network administration.

**broadcast:** A message sent to all destination devices on the network.

**broadcast storm:** Multiple simultaneous broadcasts that typically absorb available network bandwidth and can cause network failure.

**console port:** The port on the Switch accepting a terminal or modem connector. It changes the parallel arrangement of data within computers to the serial form used on data transmission links. This port is most often used for dedicated local management.

**CSMA/CD:** Channel access method used by Ethernet and IEEE 802.3 standards in which devices transmit only after finding the data channel clear for some period of time. When two devices transmit simultaneously, a collision occurs and the colliding devices delay their retransmissions for a random amount of time.

**data center switching:** The point of aggregation within a corporate network where a switch provides high-performance access to server farms, a high-speed backbone connection, and a control point for network management and security.

**edge port:** A configurable designation for RSTP operations. It defines a port that is directly connected to a segment where a loop cannot exist. For example, a port connected to a server with a single Ethernet connection. Edge ports transition to a forwarding state more quickly where RSTP is used.

**Ethernet:** A LAN specification developed jointly by Xerox, Intel, and Digital Equipment Corporation. Ethernet networks operate at 10Mbps using CSMA/CD to run over cabling.

**Fast Ethernet:** 100Mbps technology based on the Ethernet/CD network access method.

**Flow Control:** (IEEE 802.3z) A means of holding packets back at the transmit port of the connected end station. Prevents packet loss at a congested switch port.

**forwarding:** The process of sending a packet toward its destination by an internetworking device.

**full-duplex:** A system that allows packets to be transmitted and received at the same time and, in effect, doubles the potential throughput of a link.

**half-duplex:** A system that allows packets to be transmitted and received, but not at the same time. Contrast with *full-duplex*.

**IP address:** Internet Protocol address. A unique identifier for a device attached to a network using TCP/IP. The address is written as four octets separated with full-stops (periods), and is made up of a network section, an optional subnet section, and a host section.

**IPX:** Internetwork Packet Exchange. A protocol allowing communication in a NetWare network.

**LAN:** Local Area Network. A network of connected computing resources (such as PCs, printers, servers) covering a relatively small geographic area (usually not larger than a floor or building). Characterized by high data rates and low error rates.

**latency:** The delay between the time a device receives a packet and the time the packet is forwarded out of the destination port.

**line speed:** See *baud rate*.

**main port:** The port in a resilient link that carries data traffic in normal operating conditions.

**MDI:** Medium Dependent Interface. An Ethernet port connection where the transmitter of one device is connected to the receiver of another device.

**MDI-X:** Medium Dependent Interface Cross-over. An Ethernet port connection where the internal transmit and receive lines are crossed.

**MIB:** Management Information Base. Stores a device's management characteristics and parameters. MIBs are used by the Simple Network Management Protocol (SNMP) to contain attributes of their managed systems. The Switch contains its own internal MIB.

**multicast:** Single packets copied to a specific subset of network addresses. These addresses are specified in the destination-address field of the packet.

**protocol:** A set of rules for communication between devices on a network. The rules dictate format, timing, sequencing, and error control.

**RJ-45:** Standard 8-wire connectors for IEEE 802.3 10BASE-T networks.

**RMON:** Remote Monitoring. Subset of SNMP MIB II that allows monitoring and management capabilities by addressing up to ten different groups of information.

**RPS:** Redundant Power System. A device that provides a backup source of power when connected to the Switch.

**RSTP:** Rapid Spanning Tree Protocol as defined by IEEE 802.1w.

**server farm:** A cluster of servers in a centralized location serving a large user population.

**SLIP:** Serial Line Internet Protocol. A protocol that allows IP to run over a serial line connection.

**SNMP:** Simple Network Management Protocol. A protocol originally designed to be used in managing TCP/IP internets. SNMP is presently implemented on a wide range of computers and networking equipment and may be used to manage many aspects of network and end station operation.

**Spanning Tree Protocol:** (STP) A bridge-based system for providing fault tolerance on networks. STP works by allowing you to implement parallel paths for network traffic, and ensure that redundant paths are disabled when the main paths are operational and enabled if the main paths fail. The IEEE standard 802.1d describes how the protocol.

**stack:** A group of network devices that are integrated to form a single logical device.

**switch:** A device which filters, forwards, and floods packets based on the packet's destination address. The switch learns the addresses associated with each switch port and builds tables based on this information to be used for the switching decision.

**TCP/IP:** A layered set of communications protocols providing Telnet terminal emulation, FTP file transfer, and other services for communication among a wide range of computer equipment.

**Telnet:** A TCP/IP application protocol that provides virtual terminal service, letting a user log in to another computer system and access a host as if the user were connected directly to the host.

**TFTP:** Trivial File Transfer Protocol. Allows you to transfer files (such as software upgrades) from a remote device using your switch's local management capabilities.

**UDP:** User Datagram Protocol. An Internet standard protocol that allows an application program on one device to send a datagram to an application program on another device.

**VLAN:** Virtual LAN. A group of location- and topology-independent devices that communicate as if they are on a common physical LAN.

**VT100:** A type of terminal that uses ASCII characters. VT100 screens have a text-based appearance.

## LIMITED WARRANTY

D-Link provides this limited warranty for its product only to the person or entity who originally purchased the product from D-Link or its authorized reseller or distributor. D-Link would fulfill the warranty obligation according to the local warranty policy in which you purchased our products.

**Limited Hardware Warranty:** D-Link warrants that the hardware portion of the D-Link products described below (“Hardware”) will be free from material defects in workmanship and materials from the date of original retail purchase of the Hardware, for the period set forth below applicable to the product type (“Warranty Period”) if the Hardware is used and serviced in accordance with applicable documentation; provided that a completed Registration Card is returned to an Authorized D-Link Service Office within ninety (90) days after the date of original retail purchase of the Hardware. If a completed Registration Card is not received by an authorized D-Link Service Office within such ninety (90) period, then the Warranty Period shall be ninety (90) days from the date of purchase.

<i>Product Type</i>	<i>Warranty Period</i>
Product (including Power Supplies and Fans)	One (1) Year
Spare parts and pare kits	Ninety (90) days

D-Link’s sole obligation shall be to repair or replace the defective Hardware at no charge to the original owner. Such repair or replacement will be rendered by D-Link at an Authorized D-Link Service Office. The replacement Hardware need not be new or of an identical make, model or part; D-Link may in its discretion may replace the defective Hardware (or any part thereof) with any reconditioned product that D-Link reasonably determines is substantially equivalent (or superior) in all material respects to the defective Hardware. The Warranty Period shall extend for an additional ninety (90) days after any repaired or replaced Hardware is delivered. If a material defect is incapable of correction, or if D-Link determines in its sole discretion that it is not practical to repair or replace the defective Hardware, the price paid by the original purchaser for the defective Hardware will be refunded by D-Link upon return to D-Link of the defective Hardware. All Hardware (or part thereof) that is replaced by D-Link, or for which the purchase price is refunded, shall become the property of D-Link upon replacement or refund.

**Limited Software Warranty:** D-Link warrants that the software portion of the product (“Software”) will substantially conform to D-Link’s then current functional specifications for the Software, as set forth in the applicable documentation, from the date of original delivery of the Software for a period of ninety (90) days (“Warranty Period”), if the Software is properly installed on approved hardware and operated as contemplated in its documentation. D-Link further warrants that, during the Warranty Period, the magnetic media on which D-Link delivers the Software will be free of physical defects. D-Link’s sole obligation shall be to replace the non-conforming Software (or defective media) with software that substantially conforms to D-Link’s functional specifications for the Software. Except as otherwise agreed by D-Link in writing, the replacement Software is provided only to the original licensee, and is subject to the terms and conditions of the license granted by D-Link for the Software. The Warranty Period shall extend for an additional ninety (90) days after any replacement Software is delivered. If a material non-conformance is incapable of correction, or if D-Link determines in its sole discretion that it is not practical to replace the non-conforming Software, the price paid by the original licensee for the non-conforming Software will be refunded by D-Link; provided that the non-conforming Software (and all copies thereof) is first returned to D-Link. The license granted respecting any Software for which a refund is given automatically terminates.

***What You Must Do For Warranty Service:***

**Registration Card.** The Registration Card provided at the back of this manual must be completed and returned to an Authorized D-Link Service Office for each D-Link product within ninety (90) days after the product is purchased and/or licensed. The addresses/telephone/fax list of the nearest Authorized D-Link Service Office is provided in the back of this manual. FAILURE TO PROPERLY COMPLETE AND TIMELY RETURN THE REGISTRATION CARD MAY AFFECT THE WARRANTY FOR THIS PRODUCT.

**Submitting A Claim.** Any claim under this limited warranty must be submitted in writing before the end of the Warranty Period to an Authorized D-Link Service Office. The claim must include a written description of the Hardware defect or Software nonconformance in sufficient detail to allow D-Link to confirm the same. The original product owner must obtain a Return Material Authorization (RMA) number from the Authorized D-Link Service Office and, if requested, provide written proof of purchase of the product (such as a copy of the dated purchase invoice for the product) before the warranty service is provided. After an RMA number is issued, the defective product must be packaged securely in the original or other suitable shipping package to ensure that it will not be damaged in transit, and the RMA number must be prominently marked on the outside of the package. The packaged product shall be insured and shipped to Authorized D-Link Service Office with all shipping costs prepaid. D-Link may reject or return any product that is not packaged and shipped in strict compliance with the foregoing requirements, or for which an RMA number is not visible from the outside of the package. The product owner agrees to pay D-Link's reasonable handling and return shipping charges for any product that is not packaged and shipped in accordance with the foregoing requirements, or that is determined by D-Link not to be defective or non-conforming.

***What Is Not Covered:***

This limited warranty provided by D-Link does not cover:

Products that have been subjected to abuse, accident, alteration, modification, tampering, negligence, misuse, faulty installation, lack of reasonable care, repair or service in any way that is not contemplated in the documentation for the product, or if the model or serial number has been altered, tampered with, defaced or removed;

Initial installation, installation and removal of the product for repair, and shipping costs;

Operational adjustments covered in the operating manual for the product, and normal maintenance;

Damage that occurs in shipment, due to act of God, failures due to power surge, and cosmetic damage;

and Any hardware, software, firmware or other products or services provided by anyone other than D-Link.

***Disclaimer of Other Warranties:*** EXCEPT FOR THE LIMITED WARRANTY SPECIFIED HEREIN, THE PRODUCT IS PROVIDED "AS-IS" WITHOUT ANY WARRANTY OF ANY KIND INCLUDING, WITHOUT LIMITATION, ANY WARRANTY OF MERCHANTABILITY, FITNESS FOR A PARTICULAR PURPOSE AND NON-INFRINGEMENT. IF ANY IMPLIED WARRANTY CANNOT BE DISCLAIMED IN ANY TERRITORY WHERE A PRODUCT IS SOLD, THE DURATION OF SUCH IMPLIED WARRANTY SHALL BE LIMITED TO NINETY (90) DAYS. EXCEPT AS EXPRESSLY COVERED UNDER THE LIMITED WARRANTY PROVIDED HEREIN, THE ENTIRE RISK AS TO THE QUALITY, SELECTION AND PERFORMANCE OF THE PRODUCT IS WITH THE PURCHASER OF THE PRODUCT.

**Limitation of Liability:** TO THE MAXIMUM EXTENT PERMITTED BY LAW, D-LINK IS NOT LIABLE UNDER ANY CONTRACT, NEGLIGENCE, STRICT LIABILITY OR OTHER LEGAL OR EQUITABLE THEORY FOR ANY LOSS OF USE OF THE PRODUCT, INCONVENIENCE OR DAMAGES OF ANY CHARACTER, WHETHER DIRECT, SPECIAL, INCIDENTAL OR CONSEQUENTIAL (INCLUDING, BUT NOT LIMITED TO, DAMAGES FOR LOSS OF GOODWILL, WORK STOPPAGE, COMPUTER FAILURE OR MALFUNCTION, LOSS OF INFORMATION OR DATA CONTAINED IN, STORED ON, OR INTEGRATED WITH ANY PRODUCT RETURNED TO D-LINK FOR WARRANTY SERVICE) RESULTING FROM THE USE OF THE PRODUCT, RELATING TO WARRANTY SERVICE, OR ARISING OUT OF ANY BREACH OF THIS LIMITED WARRANTY, EVEN IF D-LINK HAS BEEN ADVISED OF THE POSSIBILITY OF SUCH DAMAGES. THE SOLE REMEDY FOR A BREACH OF THE FOREGOING LIMITED WARRANTY IS REPAIR, REPLACEMENT OR REFUND OF THE DEFECTIVE OR NON-CONFORMING PRODUCT.

**GOVERNING LAW:** This Limited Warranty shall be governed by the laws of the state of California.

Some states do not allow exclusion or limitation of incidental or consequential damages, or limitations on how long an implied warranty lasts, so the foregoing limitations and exclusions may not apply. This limited warranty provides specific legal rights and the product owner may also have other rights which vary from state to state.

#### **Trademarks**

Copyright 2005 D-Link Corporation. Contents subject to change without prior notice. D-Link is a registered trademark of D-Link Corporation/D-Link Systems, Inc. All other trademarks belong to their respective proprietors.

#### **Copyright Statement**

No part of this publication may be reproduced in any form or by any means or used to make any derivative such as translation, transformation, or adaptation without permission from D-Link Corporation/D-Link Systems Inc., as stipulated by the United States Copyright Act of 1976.

## **FCC Warning**

This equipment has been tested and found to comply with the limits for a Class A digital device, pursuant to Part 15 of the FCC Rules. These limits are designed to provide reasonable protection against harmful interference when the equipment is operated in a commercial environment. This equipment generates, uses, and can radiate radio frequency energy and, if not installed and used in accordance with this manual, may cause harmful interference to radio communications. Operation of this equipment in a residential area is likely to cause harmful interference in which case the user will be required to correct the interference at his own expense.





## Limited Warranty (USA Only)

Subject to the terms and conditions set forth herein, D-Link Systems, Inc. ("D-Link") provides this Limited Warranty:

Only to the person or entity that originally purchased the product from D-Link or its authorized reseller or distributor, and

Only for products purchased and delivered within the fifty states of the United States, the District of Columbia, U.S. Possessions or Protectorates, U.S. Military Installations, or addresses with an APO or FPO.

**Limited Warranty:** D-Link warrants that the hardware portion of the D-Link product described below ("Hardware") will be free from material defects in workmanship and materials under normal use from the date of original retail purchase of the product, for the period set forth below ("Warranty Period"), except as otherwise stated herein.

Limited Lifetime Warranty for the product is defined as follows:

- Hardware: For as long as the original customer/end user owns the product, or five (5) years after product discontinuance, whichever occurs first (excluding power supplies and fans)
- Power supplies and fans: Three (3) Year
- Spare parts and spare kits: Ninety (90) days

The customer's sole and exclusive remedy and the entire liability of D-Link and its suppliers under this Limited Warranty will be, at D-Link's option, to repair or replace the defective Hardware during the Warranty Period at no charge to the original owner or to refund the actual purchase price paid. Any repair or replacement will be rendered by D-Link at an Authorized D-Link Service Office. The replacement hardware need not be new or have an identical make, model or part. D-Link may, at its option, replace the defective Hardware or any part thereof with any reconditioned product that D-Link reasonably determines is substantially equivalent (or superior) in all material respects to the defective Hardware. Repaired or replacement hardware will be warranted for the remainder of the original Warranty Period or ninety (90) days, whichever is longer, and is subject to the same limitations and exclusions. If a material defect is incapable of correction, or if D-Link determines that it is not practical to repair or replace the defective Hardware, the actual price paid by the original purchaser for the defective Hardware will be refunded by D-Link upon return to D-Link of the defective Hardware. All Hardware or part thereof that is replaced by D-Link, or for which the purchase price is refunded, shall become the property of D-Link upon replacement or refund.

**Limited Software Warranty:** D-Link warrants that the software portion of the product ("Software") will substantially conform to D-Link's then current functional specifications for the Software, as set forth in the applicable documentation, from the date of original retail purchase of the Software for a period of ninety (90) days ("Software Warranty Period"), provided that the Software is properly installed on approved hardware and operated as contemplated in its documentation. D-Link further warrants that, during the Software Warranty Period, the magnetic media on which D-Link delivers the Software will be free of physical defects. The customer's sole and exclusive remedy and the entire liability of D-Link and its suppliers under this Limited Warranty will be, at D-Link's option, to replace the non-conforming Software (or defective media) with software that substantially conforms to D-Link's functional specifications for the Software or to refund the portion of the actual purchase price paid that is attributable to the Software. Except as otherwise agreed by D-Link in writing, the replacement Software is provided only to the original licensee, and is subject to the terms and conditions of the license granted by D-Link for the Software. Replacement Software will be warranted for the remainder of the original Warranty Period and is subject to the same limitations and exclusions. If a material non-conformance is incapable of correction, or if D-Link determines in its sole discretion that it is not practical to replace the non-conforming Software, the price paid by the original licensee for the non-conforming Software will be refunded by D-Link; provided that the non-conforming Software (and all copies thereof) is first returned to D-Link. The license granted respecting any Software for which a refund is given automatically terminates.

**Non-Applicability of Warranty:** The Limited Warranty provided hereunder for Hardware and Software portions of D-Link's products will not be applied to and does not cover any refurbished product and any product purchased through the inventory clearance or liquidation sale or other sales in which D-Link, the sellers, or the liquidators expressly disclaim their warranty obligation pertaining to the product and in that case, the product is being sold "As-Is" without any warranty whatsoever including, without limitation, the Limited Warranty as described herein, notwithstanding anything stated herein to the contrary.

**Submitting A Claim:** The customer shall return the product to the original purchase point based on its return policy. In case the return policy period has expired and the product is within warranty, the customer shall submit a claim to D-Link as outlined below:

- The customer must submit with the product as part of the claim a written description of the Hardware defect or Software nonconformance in sufficient detail to allow D-Link to confirm the same, along with proof of purchase of the product (such as a copy of the dated purchase invoice for the product) if the product is not registered.
- The customer must obtain a Case ID Number from D-Link Technical Support at 1-877-453-5465, who will attempt to assist the customer in resolving any suspected defects with the product. If the product is considered defective, the customer must obtain a Return Material Authorization (“RMA”) number by completing the RMA form and entering the assigned Case ID Number at <https://rma.dlink.com/>.
- After an RMA number is issued, the defective product must be packaged securely in the original or other suitable shipping package to ensure that it will not be damaged in transit, and the RMA number must be prominently marked on the outside of the package. Do not include any manuals or accessories in the shipping package. D-Link will only replace the defective portion of the product and will not ship back any accessories.
- The customer is responsible for all in-bound shipping charges to D-Link. No Cash on Delivery (“COD”) is allowed. Products sent COD will either be rejected by D-Link or become the property of D-Link. Products shall be fully insured by the customer and shipped to **D-Link Systems, Inc., 17595 Mt. Herrmann, Fountain Valley, CA 92708**. D-Link will not be held responsible for any packages that are lost in transit to D-Link. The repaired or replaced packages will be shipped to the customer via UPS Ground or any common carrier selected by D-Link. Return shipping charges shall be prepaid by D-Link if you use an address in the United States, otherwise we will ship the product to you freight collect. Expedited shipping is available upon request and provided shipping charges are prepaid by the customer.

D-Link may reject or return any product that is not packaged and shipped in strict compliance with the foregoing requirements, or for which an RMA number is not visible from the outside of the package. The product owner agrees to pay D-Link’s reasonable handling and return shipping charges for any product that is not packaged and shipped in accordance with the foregoing requirements, or that is determined by D-Link not to be defective or non-conforming.

**What Is Not Covered:** The Limited Warranty provided herein by D-Link does not cover: Products that, in D-Link’s judgment, have been subjected to abuse, accident, alteration, modification, tampering, negligence, misuse, faulty installation, lack of reasonable care, repair or service in any way that is not contemplated in the documentation for the product, or if the model or serial number has been altered, tampered with, defaced or removed; Initial installation, installation and removal of the product for repair, and shipping costs; Operational adjustments covered in the operating manual for the product, and normal maintenance; Damage that occurs in shipment, due to act of God, failures due to power surge, and cosmetic damage; Any hardware, software, firmware or other products or services provided by anyone other than D-Link; and Products that have been purchased from inventory clearance or liquidation sales or other sales in which D-Link, the sellers, or the liquidators expressly disclaim their warranty obligation pertaining to the product. While necessary maintenance or repairs on your Product can be performed by any company, we recommend that you use only an Authorized D-Link Service Office. Improper or incorrectly performed maintenance or repair voids this Limited Warranty.

**Disclaimer of Other Warranties:** EXCEPT FOR THE LIMITED WARRANTY SPECIFIED HEREIN, THE PRODUCT IS PROVIDED “AS-IS” WITHOUT ANY WARRANTY OF ANY KIND WHATSOEVER INCLUDING, WITHOUT LIMITATION, ANY WARRANTY OF MERCHANTABILITY, FITNESS FOR A PARTICULAR PURPOSE AND NON-INFRINGEMENT. IF ANY IMPLIED WARRANTY CANNOT BE DISCLAIMED IN ANY TERRITORY WHERE A PRODUCT IS SOLD, THE DURATION OF SUCH IMPLIED WARRANTY SHALL BE LIMITED TO NINETY (90) DAYS. EXCEPT AS EXPRESSLY COVERED UNDER THE LIMITED WARRANTY PROVIDED HEREIN, THE ENTIRE RISK AS TO THE QUALITY, SELECTION AND PERFORMANCE OF THE PRODUCT IS WITH THE PURCHASER OF THE PRODUCT.

**Limitation of Liability:** TO THE MAXIMUM EXTENT PERMITTED BY LAW, D-LINK IS NOT LIABLE UNDER ANY CONTRACT, NEGLIGENCE, STRICT LIABILITY OR OTHER LEGAL OR EQUITABLE THEORY FOR ANY LOSS OF USE OF THE PRODUCT, INCONVENIENCE OR DAMAGES OF ANY CHARACTER, WHETHER DIRECT, SPECIAL, INCIDENTAL OR CONSEQUENTIAL (INCLUDING, BUT NOT LIMITED TO, DAMAGES FOR LOSS OF GOODWILL, LOSS OF REVENUE OR PROFIT, WORK STOPPAGE, COMPUTER FAILURE OR MALFUNCTION, FAILURE OF OTHER EQUIPMENT OR COMPUTER PROGRAMS TO WHICH D-LINK'S PRODUCT IS CONNECTED WITH, LOSS OF INFORMATION OR DATA CONTAINED IN, STORED ON, OR INTEGRATED WITH ANY PRODUCT RETURNED TO D-LINK FOR WARRANTY SERVICE) RESULTING FROM THE USE OF THE PRODUCT, RELATING TO WARRANTY SERVICE, OR ARISING OUT OF ANY BREACH OF THIS LIMITED WARRANTY, EVEN IF D-LINK HAS BEEN ADVISED OF THE POSSIBILITY OF SUCH DAMAGES. THE SOLE REMEDY FOR A BREACH OF THE FOREGOING LIMITED WARRANTY IS REPAIR, REPLACEMENT OR REFUND OF THE DEFECTIVE OR NON-CONFORMING PRODUCT. THE MAXIMUM LIABILITY OF D-LINK UNDER THIS WARRANTY IS LIMITED TO THE PURCHASE PRICE OF THE PRODUCT COVERED BY THE WARRANTY. THE FOREGOING EXPRESS WRITTEN WARRANTIES AND REMEDIES ARE EXCLUSIVE AND ARE IN LIEU OF ANY OTHER WARRANTIES OR REMEDIES, EXPRESS, IMPLIED OR STATUTORY.

**Governing Law:** This Limited Warranty shall be governed by the laws of the State of California. Some states do not allow exclusion or limitation of incidental or consequential damages, or limitations on how long an implied warranty lasts, so the foregoing limitations and exclusions may not apply. This Limited Warranty provides specific legal rights and you may also have other rights which vary from state to state.

**Trademarks:** D-Link is a registered trademark of D-Link Systems, Inc. Other trademarks or registered trademarks are the property of their respective owners.

**Copyright Statement:** No part of this publication or documentation accompanying this product may be reproduced in any form or by any means or used to make any derivative such as translation, transformation, or adaptation without permission from D-Link Corporation/D-Link Systems, Inc., as stipulated by the United States Copyright Act of 1976 and any amendments thereto. Contents are subject to change without prior notice. Copyright 2005 by D-Link Corporation/D-Link Systems, Inc. All rights reserved.

**CE Mark Warning:** This is a Class A product. In a residential environment, this product may cause radio interference, in which case the user may be required to take adequate measures.

**FCC Statement:** This equipment has been tested and found to comply with the limits for a Class A digital device, pursuant to part 15 of the FCC Rules. These limits are designed to provide reasonable protection against harmful interference in a commercial installation. This equipment generates, uses, and can radiate radio frequency energy and, if not installed and used in accordance with the instructions, may cause harmful interference to radio communication. However, there is no guarantee that interference will not occur in a particular installation. Operation of this equipment in a residential environment is likely to cause harmful interference to radio or television reception. If this equipment does cause harmful interference to radio or television reception, which can be determined by turning the equipment off and on, the user is encouraged to try to correct the interference by one or more of the following measures:

- Reorient or relocate the receiving antenna.
- Increase the separation between the equipment and receiver.
- Connect the equipment into an outlet on a circuit different from that to which the receiver is connected.
- Consult the dealer or an experienced radio/TV technician for help.

**For detailed warranty information applicable to products purchased outside the United States, please contact the corresponding local D-Link office.**

## **Product Registration**

*Register online your D-Link product at <http://support.dlink.com/register/>*

*Product registration is entirely voluntary and failure to complete or return this form will not diminish your warranty rights.*

# D-Link Europe Limited Product Warranty

## General Terms

The Limited Product Warranty set forth below is given by D-LINK (Europe) Ltd. (herein referred to as "D-LINK"). This Limited Product Warranty is only effective upon presentation of the proof of purchase. Upon further request by D-LINK, this warranty card has to be presented, too.

EXCEPT AS EXPRESSLY SET FORTH IN THIS LIMITED WARRANTY, D-LINK MAKES NO OTHER WARRANTIES, EXPRESS OR IMPLIED, INCLUDING ANY IMPLIED WARRANTIES OF MERCHANTABILITY AND FITNESS FOR A PARTICULAR PURPOSE. D-LINK EXPRESSLY DISCLAIMS ALL WARRANTIES NOT STATED IN THIS LIMITED WARRANTY. ANY IMPLIED WARRANTIES THAT MAY BE IMPOSED BY LAW ARE LIMITED IN DURATION TO THE LIMITED WARRANTY PERIOD. SOME STATES OR COUNTRIES DO NOT ALLOW A LIMITATION ON HOW LONG AN IMPLIED WARRANTY LASTS OR THE EXCLUSION OR LIMITATION OF INCIDENTAL OR CONSEQUENTIAL DAMAGES FOR CONSUMER PRODUCTS. IN SUCH STATES OR COUNTRIES, SOME EXCLUSIONS OR LIMITATIONS OF THIS LIMITED WARRANTY MAY NOT APPLY TO YOU. THIS LIMITED WARRANTY GIVES YOU SPECIFIC LEGAL RIGHTS. YOU MAY ALSO HAVE OTHER RIGHTS THAT MAY VARY FROM STATE TO STATE OR FROM COUNTRY TO COUNTRY. YOU ARE ADVISED TO CONSULT APPLICABLE STATE OR COUNTRY LAWS FOR

A FULL DETERMINATION OF YOUR RIGHTS.

This limited warranty applies to D-LINK branded hardware products (collectively referred to in this limited warranty as "D-LINK Hardware Products") sold by from D-LINK (Europe) Ltd., its worldwide subsidiaries, affiliates, authorized resellers, or country distributors (collectively referred to in this limited warranty as "D-LINK") with this limited warranty. The Term "D-LINK Hardware Product" is limited to the hardware components and all its internal components including firmware. The term "D-LINK Hardware Product" DOES NOT include any software applications or programs.

### Geographical Scope of the Limited Product Warranty

This Limited Product Warranty is applicable in all European Countries as listed in the addendum "European Countries for D-LINK Limited Product Warranty". The term "European Countries" in this D-LINK Limited Product Warranty only include the countries as listed in this addendum. The Limited Product Warranty will be honored in any country where D-LINK or its authorized service providers offer warranty service subject to the terms and conditions set forth in this Limited Product Warranty. However, warranty service availability and response times may vary from country to country and may also be subject to registration requirements.

### Limitation of Product Warranty

D-LINK warrants that the products described below under normal use are free from material defects in materials and workmanship during the Limited Product Warranty Period set forth below ("Limited Product Warranty Period"), if the product is used and serviced in accordance with the user manual and other documentation provided to the purchaser at the time of purchase (or as amended from time to time). D-LINK does not warrant that the products will operate uninterrupted or error-free or that all deficiencies, errors, defects or non-conformities will be corrected.

This warranty shall not apply to problems resulting from: (a) unauthorised alterations or attachments; (b) negligence, abuse or misuse, including failure to operate the product in accordance with specifications or interface requirements; (c) improper handling; (d) failure of goods or services not obtained from D-LINK or not subject to a then-effective D-LINK warranty or maintenance agreement; (e) improper use or storage; or (f) fire, water, acts of God or other catastrophic events. This warranty shall also not apply to any particular product if any D-LINK serial number has been removed or defaced in any way.

D-LINK IS NOT RESPONSIBLE FOR DAMAGE THAT OCCURS AS A RESULT OF YOUR FAILURE TO FOLLOW THE INSTRUCTIONS FOR THE D-LINK HARDWARE PRODUCT.

### Limited Product Warranty Period

The Limited Product Warranty Period starts on the date of purchase from D-LINK. Your dated sales or delivery receipt, showing the date of purchase of the product, is your proof of the purchase date. You may be required to provide proof of purchase as a condition of receiving warranty service. You are entitled to warranty service according to the terms and conditions of this document if a repair to your D-LINK branded hardware is required within the Limited Product Warranty Period.

This Limited Product Warranty extends only to the original end-user purchaser of this D-LINK Hardware Product and is not transferable to anyone who obtains ownership of the D-LINK Hardware Product from the original end-user purchaser.

Product Type	Product Warranty Period
Managed Switches (i.e. switches with built in SNMP agent)(including modules and management software)	Five (5) years
All other products	Two (2) years
Spare parts (i.e. External Power Adapters, Fans)	One (1) year

The warranty periods listed above are effective in respect of all D-LINK products sold in European Countries by D-LINK or one of its authorized resellers or distributors from 1st of January 2004. All products sold in European Countries by D-LINK or one of its authorized resellers or distributors before 1st January 2004 carry 5 years warranty, except power supplies, fans and accessories that are provided with 2 year warranty.

## *D-Link DES-3326S Layer 3 Switch*

---

The warranty period stated in this card supersedes and replaces the warranty period as stated in the user's manual or in the purchase contract for the relevant products. For the avoidance of doubt, if you have purchased the relevant D-LINK product as a consumer your statutory rights remain unaffected.

## **Performance of the Limited Product Warranty**

If a product defect occurs, D-LINK's sole obligation shall be to repair or replace any defective product free of charge to the original purchaser provided it is returned to an Authorized D-LINK Service Center during the warranty period. Such repair or replacement will be rendered by D-LINK at an Authorized D-LINK Service Center. All component parts or hardware products removed under this limited warranty become the property of D-LINK. The replacement part or product takes on the remaining limited warranty status of the removed part or product. The replacement product need not be new or of an identical make, model or part; D-LINK may in its discretion replace the defective product (or any part thereof) with any reconditioned equivalent (or superior) product in all material respects to the defective product. Proof of purchase may be required by D-LINK.

## **Warrantor**

D-Link (Europe) Ltd.  
4th Floor, Merit House  
Edgware Road  
Colindale  
London NW9 5 AB  
United Kingdom

Telephone: +44-020-8731-5555

Facsimile: +44-020-8731-5511

[www.dlink.co.uk](http://www.dlink.co.uk)

## D-Link Europe Limited Produktgarantie

### Allgemeine Bedingungen

Die hierin beschriebene eingeschränkte Garantie wird durch D-LINK (Europe) Ltd. gewährt (im Folgenden: „D-LINK“). Diese eingeschränkte Garantie setzt voraus, dass der Kauf des Produkts nachgewiesen wird. Auf Verlangen von D-LINK muss auch dieser Garantieschein vorgelegt werden.

AUSSER IN DEM HIER AUSDRÜCKLICH BESCHRIEBENEN UMFANG GEWÄHRT D-LINK KEINE WEITEREN GARANTIE, WEDER AUSDRÜCKLICH NOCH STILLSCHWEIGEND. INSBESONDERE WIRD NICHT STILLSCHWEIGEND EINE GARANTIE FÜR DIE ALLGEMEINE GEBRAUCHSTAUGLICHKEIT ODER DIE EIGNUNG FÜR EINEN BESTIMMTEN ZWECK ERKLÄRT. D-LINK LEHNT AUSDRÜCKLICH JEDE GARANTIE AB, DIE ÜBER DIESE EINGESCHRÄNKTE GARANTIE HINAUSGEHT. JEDE GESETZLICH ANGEORDNETE GARANTIE IST AUF DIE LAUFZEIT DER EINGESCHRÄNKTEN GARANTIE BESCHRÄNKT. IN EINIGEN STAATEN ODER LÄNDERN IST DIE ZEITLICHE BESCHRÄNKUNG EINER STILLSCHWEIGEND ERKLÄRTEN GARANTIE SOWIE AUSSCHLUSS ODER BESCHRÄNKUNG VON SCHADENERSATZ FÜR NEBEN- ODER FOLGESCHÄDEN BEIM VERBRAUCHSGÜTERKAUF UNTERSAGT. SOWEIT SIE IN SOLCHEN STAATEN ODER LÄNDERN LEBEN, ENTFALTEN MÖGLICHERWEISE EINIGE AUSSCHLÜSSE ODER EINSCHRÄNKUNGEN DIESER EINGESCHRÄNKTEN GARANTIE GEGENÜBER IHNEN KEINE WIRKUNG. DIESE EINGESCHRÄNKTE GARANTIE GEWÄHRT IHNEN SPEZIFISCHE RECHTE. DARÜBER HINAUS STEHEN IHNEN MÖGLICHERWEISE NOCH WEITERE RECHTE ZU, DIE SICH JEDOCH VON STAAT ZU STAAT ODER VON LAND ZU LAND UNTERSCHIEDEN KÖNNEN. UM DEN UMFANG IHRER RECHTE ZU BESTIMMEN, WIRD IHNEN EMPFOHLEN, DIE ANWENDBAREN GESETZE DES JEWEILIGEN STAATES ODER LANDES ZU RATE ZU ZIEHEN.

Diese eingeschränkte Garantie ist auf Hardware-Produkte der Marke D-LINK (insgesamt im Folgenden: „D-LINK Hardware-Produkte“) anwendbar, die von D-LINK (Europe) Ltd. oder dessen weltweiten Filialen, Tochtergesellschaften, Fachhändlern oder Länderdistributoren (insgesamt im Folgenden: „D-LINK“) mit dieser eingeschränkten Garantie verkauft wurden. Der Begriff „D-LINK Hardware-Produkte“ beinhaltet nur Hardwarekomponenten und deren Bestandteile einschließlich Firmware. Der Begriff „D-LINK Hardware-Produkte“ umfasst KEINE Software-Anwendungen oder -programme.

### Räumlicher Geltungsbereich der eingeschränkten Garantie

Diese eingeschränkte Garantie gilt für alle genannten europäischen Staaten gemäß dem Anhang „Eingeschränkte Garantie von D-LINK in europäischen Staaten“. Im Rahmen dieser eingeschränkten Garantie sind mit dem Begriff „europäische Staaten“ nur die im Anhang genannten Staaten gemeint. Die eingeschränkte Garantie findet überall Anwendung, wo D-LINK oder dessen autorisierte Servicepartner Garantiedienste gemäß den Bestimmungen dieser eingeschränkten Garantie erbringen. Gleichwohl kann sich die Verfügbarkeit von Garantiediensten und die Bearbeitungszeit von Land zu Land unterscheiden und von Registrierungsanforderungen abhängig sein.

### Einschränkung der Garantie

D-LINK gewährleistet, dass die nachstehend aufgeführten Produkte bei gewöhnlicher Verwendung für die unten angegebene Laufzeit der eingeschränkten Garantie („Garantielaufzeit“) frei von wesentlichen Verarbeitungs- und Materialfehlern sind. Voraussetzung hierfür ist jedoch, dass das Produkt entsprechend dem Benutzerhandbuch und den weiteren Dokumentationen, die der Benutzer beim Kauf (oder später) erhalten hat, genutzt und gewartet wird. D-LINK garantiert nicht, dass die Produkte störungs- oder fehlerfrei arbeiten oder dass alle Mängel, Fehler, Defekte oder Kompatibilitätsstörungen beseitigt werden können.

Diese Garantie gilt nicht für Probleme wegen: (a) unerlaubter Veränderung oder Hinzufügung, (b) Fahrlässigkeit, Missbrauch oder Zweckentfremdung, einschließlich des Gebrauchs des Produkts entgegen den Spezifikationen oder den durch Schnittstellen gegebenen Vorgaben, (c) fehlerhafter Bedienung, (d) Versagen von Produkten oder Diensten, die nicht von D-LINK stammen oder nicht Gegenstand einer zum maßgeblichen Zeitpunkt gültigen Garantie- oder Wartungsvereinbarung sind, (e) Fehlgebrauch oder fehlerhafter Lagerung oder (f) Feuer, Wasser, höherer Gewalt oder anderer Katastrophen. Diese Garantie gilt ebenfalls nicht für Produkte, bei denen eine D-LINK-Seriennummer entfernt oder auf sonstige Weise unkenntlich gemacht wurde.

D-LINK STEHT NICHT FÜR SCHÄDEN EIN, DIE DADURCH ENTSTEHEN, DASS DIE ANLEITUNG FÜR DAS D-LINK HARDWARE-PRODUKT NICHT BEFOLGT WIRD.

### Laufzeit der eingeschränkten Garantie

Die Laufzeit der eingeschränkten Garantie beginnt mit dem Zeitpunkt, zu dem das Produkt von D-LINK gekauft wurde. Als Nachweis für den Zeitpunkt des Kaufs gilt der datierte Kauf- oder Lieferbeleg. Es kann von Ihnen verlangt werden, dass Sie zur Inanspruchnahme von Garantiediensten den Kauf des Produkts nachweisen. Wenn Ihre Hardware-Produkte der Marke D-LINK innerhalb der Laufzeit der eingeschränkten Garantie eine Reparatur benötigen, so sind Sie berechtigt, gemäß den Bedingungen dieser eingeschränkten Garantie Garantiedienste in Anspruch zu nehmen.

Diese eingeschränkte Garantie gilt nur für diejenigen, der das D-LINK Hardware-Produkt ursprünglich als originärer Endbenutzer gekauft hat. Sie ist nicht auf Dritte übertragbar, die das D-LINK-Produkt von dem ursprünglichen originären Endbenutzer erworben haben.

Produkttyp	Gewährleistungslaufzeit
Verwaltete Switches (d. h. Switches mit eingebauten SNMP-Agents) (einschließlich Modulen und Verwaltungssoftware)	Fünf (5) Jahre
Alle weiteren Produkte	Zwei (2) Jahre
Ersatzteile (z.B. externe Netzteile, Lüfter)	Ein (1) Jahr

Die oben aufgeführten Garantielaufzeiten gelten für alle D-LINK-Produkte, die in europäischen Staaten ab dem 1. Januar 2004 von D-LINK oder einem autorisierten Fachhändler oder Distributor verkauft werden. Alle vor dem 1. Januar 2004 von D-LINK oder einem autorisierten Vertragshändler oder Distributor verkauften Produkte haben eine Gewährleistung von 5 Jahren; ausgenommen sind Netzteile, Lüfter und Zubehör, diese haben eine Garantie von 2 Jahren.

Die durch diesen Garantieschein festgelegte Garantielaufzeit tritt an die Stelle der im Benutzerhandbuch oder im Kaufvertrag für das jeweilige Produkt angegebenen Laufzeit. Sollten Sie das betreffende D-LINK-Produkt als Verbraucher erworben haben, so sei klargestellt, dass Ihre gesetzlichen Rechte hiervon unberührt bleiben.



## **Leistungsumfang der eingeschränkten Garantie**

Bei Auftreten eines Produktfehlers besteht die einzige Verpflichtung von D-LINK darin, dem ursprünglichen Käufer das defekte Produkt kostenlos zu reparieren oder es auszutauschen. Voraussetzung hierfür ist, dass das Produkt während der Garantielaufzeit einem autorisierten D-LINK-Servicecenter übergeben wird. Reparatur oder Austausch werden von D-LINK durch ein autorisiertes D-LINK-Servicecenter durchgeführt. Bauteile oder Hardware-Produkte, die gemäß dieser eingeschränkten Garantie entfernt werden, gehen in das Eigentum von D-LINK über. Die verbliebene eingeschränkte Garantie des entfernten Teils oder Produkts wird auf das Ersatzteil oder -produkt übertragen. Das Austauschprodukt muss weder neu sein noch dem defekten Produkt ganz oder in Teilen entsprechen. D-LINK darf dieses nach eigenem Ermessen gegen ein entsprechendes wiederaufbereitetes Produkt austauschen, welches dem defekten Produkt im Wesentlichen entspricht (oder höherwertig ist). D-LINK kann verlangen, dass der Kauf des Produkts nachgewiesen wird.

DIE VORSTEHENDE GARANTIE WURDE IN DIE DEUTSCHE SPRACHE AUS DEM ENGLISCHEN ÜBERSETZT. BEI ABWEICHUNGEN ZWISCHEN DER ENGLISCHEN VERSION UND DER DEUTSCHEN ÜBERSETZUNG GELTEN DIE BESTIMMUNGEN DER ENGLISCHEN VERSION.

## **Garantiegeber**

D-Link (Europe) Ltd.  
4th Floor, Merit House  
Edgware Road  
Colindale  
London NW9 5 AB  
Vereinigtes Königreich

Telefon: +44-020-8731-5555

Fax: +44-020-8731-5511

[www.dlink.com](http://www.dlink.com)

## D-Link Europe a limité la garantie des produits

### Conditions Générales

La Garantie Produit Limitée énoncée ci-dessous émane de D-LINK (Europe) Ltd. (ci-après « D-LINK »). Cette Garantie Produit Limitée n'est valable que sur présentation de la preuve d'achat. D-LINK peut également exiger la présentation du présent bon de garantie.

SAUF INDICATION EXPLICITE DES PRESENTES, D-LINK NE FOURNIT AUCUNE AUTRE GARANTIE, EXPLICITE OU IMPLICITE, Y COMPRIS UNE GARANTIE IMPLICITE DE VALEUR MARCHANDE OU D'ADAPTATION DU PRODUIT A UN USAGE PRECIS. D-LINK DECLINE EXPLICITEMENT TOUTE GARANTIE NON ENONCEE DANS LES PRESENTES. TOUTE GARANTIE IMPLICITE IMPOSEE PAR LA LOI, LE CAS ECHEANT, EST LIMITEE DANS SA DUREE A CELLE DE LA GARANTIE LIMITEE. CERTAINS ETATS OU PAYS NE PERMETTENT PAS DE LIMITER LA DUREE DE LA GARANTIE IMPLICITE OU INTERDISENT D'EXCLURE OU DE LIMITER LA COUVERTURE DES DOMMAGES DIRECTS OU INDIRECTS OCCASIONNES AUX PRODUITS GRAND PUBLIC. DANS LES ETATS OU PAYS EN QUESTION, CERTAINES EXCLUSIONS OU LIMITATIONS DE LA PRESENTE GARANTIE PEUVENT NE PAS S'APPLIQUER A VOTRE CAS. LA PRESENTE GARANTIE LIMITEE VOUS OCTROIE CERTAINS DROITS LEGAUX SPECIFIQUES. VOUS POUVEZ EGALEMENT BENEFICIER D'AUTRES DROITS VARIABLES D'UN ETAT OU D'UN PAYS A L'AUTRE. NOUS VOUS RECOMMANDONS DE CONSULTER LA LEGISLATION EN VIGUEUR DANS VOTRE LIEU DE RESIDENCE POUR CONNAITRE L'ETENDUE DE VOS DROITS.

La présente garantie limitée s'applique aux produits matériels commercialisés sous la marque D-LINK (collectivement ici « les Produits Matériels D-LINK ») vendus par D-LINK (Europe) Ltd., ses filiales, sociétés affiliées, revendeurs agréés ou distributeurs locaux à travers le monde (collectivement ici « D-LINK ») avec la présente garantie limitée. Le terme de « Produit Matériel D-LINK » se limite aux composants matériels et à l'ensemble de leurs composants internes, notamment le firmware. Le terme de « Produit Matériel D-LINK » N'englobe PAS les applications ou programmes logiciels.

### Etendue géographique de la Garantie Produit Limitée

La présente Garantie Produit Limitée s'applique à tous les pays européens figurant dans l'annexe « Pays européens où s'applique la Garantie Produit Limitée D-LINK ». Le terme de « pays européens » utilisé dans la présente Garantie Produit Limitée D-LINK englobe uniquement les pays figurant dans la liste en annexe. La Garantie Produit Limitée sera honorée dans tout pays où D-LINK ou ses prestataires agréés proposent le service de garantie, sous réserve des modalités énoncées dans la présente Garantie Produit Limitée. Cependant, la disponibilité du service de garantie et les temps de réponse varient d'un pays à l'autre et peuvent également être assujettis à un enregistrement.

### Limitation de la Garantie Produit

D-LINK garantit que les produits décrits ci-dessous, dans le cadre d'une utilisation normale, sont dénués de défauts conséquents, tant au niveau de leurs composants matériels que de leur fabrication, et ce pendant toute la Période de Garantie Produit Limitée indiquée ci-dessous (« Période de Garantie Produit Limitée »), sous réserve qu'ils soient utilisés et entretenus conformément au manuel utilisateur et aux autres documents remis au client lors de l'achat (ou amendés de temps à autre). D-LINK ne garantit pas le fonctionnement ininterrompu ou sans erreur de ses produits. D-LINK ne s'engage pas non plus à corriger tous les défauts, erreurs ou non conformités.

La présente garantie ne s'applique pas aux problèmes qui sont la conséquence : (a) d'altérations ou d'ajouts non autorisés ; (b) d'une négligence, d'un abus ou d'une mauvaise utilisation, notamment une utilisation du produit non conforme à ses spécifications ou aux interfaces requises ; (c) d'une mauvaise manipulation ; (d) d'une panne de biens ou de services acquis auprès d'une société tierce (non D-LINK) ou qui ne font pas l'objet d'un contrat D-LINK de garantie ou de maintenance en bonne et due forme ; (e) d'une mauvaise utilisation ou d'un rangement dans des conditions inadaptées ; ou (f) du feu, de l'eau, d'une catastrophe naturelle ou autre. La présente garantie ne s'applique pas non plus à un produit dont le numéro de série D-LINK aurait été retiré ou altéré de quelque manière que ce soit.

D-LINK N'EST NULLEMENT RESPONSABLE DE DOMMAGES RESULTANT DE VOTRE INOBSERVATION DES INSTRUCTIONS FOURNIES POUR L'UTILISATION DE SON PRODUIT MATERIEL.

### Période de Garantie Produit Limitée

La Période de Garantie Produit Limitée court à compter de la date d'achat auprès de D-LINK. La date de votre reçu ou bon de livraison correspond à la date d'achat du produit et constitue la date de votre preuve d'achat. Il est possible que le service de garantie ne vous soit accordé que sur production de votre preuve d'achat. Vous avez droit à un service de garantie conforme aux modalités énoncées dans les présentes dès lors que votre matériel de marque D-LINK nécessite une réparation pendant la Période de Garantie Produit Limitée.

La présente Garantie Produit Limitée s'applique uniquement à l'acheteur utilisateur final initial du Produit Matériel D-LINK. Elle est non cessible à quiconque se procure le Produit Matériel D-LINK auprès de l'acheteur utilisateur final initial.

Type de produit	Période de Garantie
Switches gérés (switches comportant un agent SNMP intégré)(y compris modules et logiciels de gestion)	Cinq (5) ans
Tous autres produits	Deux (2) ans
Pièces détachées (adaptateurs d'alimentation externes, ventilateurs)	Un (1) an

Les périodes de garantie indiquées ci-dessus s'appliquent à tous les produits D-LINK vendus depuis le 1er janvier 2004 dans les pays européens par D-LINK ou l'un de ses revendeurs ou distributeurs agréés. Tous les produits vendus avant le 1er janvier 2004 dans les pays européens par D-LINK ou l'un de ses revendeurs ou distributeurs agréés bénéficient d'une garantie de 5 ans, excepté les fournitures électriques, ventilateurs et accessoires, qui sont couverts par une garantie de 2 ans.

La période de garantie indiquée sur ce bon annule et remplace celle qui figure dans le manuel utilisateur ou dans le contrat d'achat des produits considérés. Pour éviter le doute, si vous avez acheté votre produit D-LINK en tant que consommateur, vos droits légaux demeurent inchangés.

## **Exécution de la Garantie Produit Limitée**

En cas de défaut ou d'erreur d'un produit, l'unique obligation de D-LINK se limite à la réparation ou au remplacement gratuit du produit défectueux, au bénéfice de l'acheteur initial, sous réserve que le produit soit rapporté à un Centre de Service Agréé D-LINK pendant la période de garantie. D-LINK assure la réparation ou le remplacement dans un Centre de Service Agréé D-LINK. Les composants, pièces ou produits retirés dans le cadre de cette garantie limitée deviennent propriété de D-LINK. La pièce ou le produit de remplacement est couvert par la garantie limitée de la pièce ou du produit d'origine pendant la période restante. Le produit de remplacement n'est pas nécessairement neuf, ni d'une marque ou d'un modèle identique ; D-LINK peut décider, de manière discrétionnaire, de remplacer le produit défectueux (ou ses pièces) par un équivalent (ou un article supérieur) reconditionné ayant toutes les fonctionnalités du produit défectueux. D-LINK peut exiger la preuve d'achat.

## **Garant**

D-Link (Europe) Ltd.  
4th Floor, Merit House  
Edgware Road  
Colindale  
London NW9 5 AB  
Royaume-Uni

Tél : +44-020-8731-5555

Fax : +44-020-8731-5511

[www.dlink.co.uk](http://www.dlink.co.uk)

## Garantía limitada del producto D-LINK Europa

### Condiciones generales

Esta garantía la ofrece D-LINK (Europe) Ltd. (en este documento, "D-LINK"). La garantía limitada del producto sólo es válida si se acompaña del comprobante de la compra. También deberá presentarse la tarjeta de garantía si D-LINK lo solicita.

EXCEPTO EN LO EXPRESAMENTE INDICADO EN ESTA GARANTÍA LIMITADA, D-LINK NO CONCEDE OTRAS GARANTÍAS, NI EXPLÍCITAS NI IMPLÍCITAS, INCLUIDAS LAS GARANTÍAS IMPLÍCITAS DE COMERCIABILIDAD Y APTITUD A UN FIN DETERMINADO. D-LINK RECHAZA EXPLÍCITAMENTE CUALQUIER GARANTÍA QUE NO FIGURE EN ESTA GARANTÍA LIMITADA. LA DURACIÓN DE CUALQUIER GARANTÍA IMPLÍCITA QUE PUEDA SER IMPUESTA POR LEY QUEDA LIMITADA AL PERÍODO DE LA GARANTÍA LIMITADA. ALGUNOS ESTADOS O PAÍSES NO PERMITEN QUE EN LA GARANTÍA LIMITADA DE PRODUCTOS DE CONSUMO SE RESTRINJA LA DURACIÓN TEMPORAL, NI QUE SE EXCLUYAN O LIMITEN LOS DAÑOS INCIDENTALES O RESULTANTES PARA EL CONSUMIDOR DE LOS PRODUCTOS. EN ESTOS ESTADOS O PAÍSES, A USTED NO LE PUEDEN APLICAR ALGUNAS EXCLUSIONES O LIMITACIONES DE LA GARANTÍA LIMITADA. ESTA GARANTÍA LIMITADA LE CONCEDE DETERMINADOS DERECHOS. PUEDE, TAMBIÉN, TENER OTROS DERECHOS, QUE PUEDEN SER DISTINTOS DE UN ESTADO A OTRO O DE UN PAÍS A OTRO. SE RECOMIENDA QUE CONSULTE LAS LEYES PERTINENTES DE UN ESTADO O PAÍS A FIN DE QUE CONOZCA SUS DERECHOS.

Esta garantía limitada se aplica a los productos de hardware de la marca D-LINK (llamados en esta guía "Productos de hardware D-LINK") comprados a D-LINK (Europe) Ltd., a sus filiales en el mundo, a sus proveedores autorizados o a sus distribuidores locales (llamados en este documento "D-LINK") con esta garantía limitada. El término "producto de hardware D-LINK" se restringe a los componentes de hardware y a los componentes internos de estos, incluyendo el firmware. El término "producto de hardware D-LINK" NO incluye ni las aplicaciones ni los programas de software.

### Cobertura geográfica de la garantía limitada del producto

Esta garantía limitada del producto es válida en todos los países europeos que figuran en el apéndice "Países europeos de la garantía limitada del producto D-LINK". En esta garantía limitada del producto D-Link, el término "países europeos" sólo incluye los países que figuran en el apéndice. La garantía limitada del producto será válida en cualquier país en el que D-LINK o sus proveedores autorizados de servicios ofrezcan un servicio de garantía sujeto a los términos y condiciones recogidos en esta garantía limitada del producto. Sin embargo, la disponibilidad del servicio de garantía, así como el tiempo de respuesta, pueden variar de un país a otro y pueden estar sujetos a requisitos de registro.

### Limitación de la garantía del producto

D-LINK garantiza que los productos descritos más adelante están libres de defectos de fabricación y materiales, en condiciones normales de uso, a lo largo del período de la garantía limitada del producto que se indica en este documento ("período de la garantía limitada del producto"), si el producto se ha utilizado y mantenido conforme a lo recogido en el manual del usuario o en otra documentación que se haya proporcionado al comprador en el momento de la compra (o que se haya corregido). D-LINK no garantiza que los productos funcionarán sin interrupciones o sin errores, ni que se corregirán todas las deficiencias, errores, defectos o disconformidades.

Esta garantía no cubre problemas derivados de: (a) modificaciones o conexiones no autorizadas; (b) negligencia, abuso o mal uso, incluyendo el incumplimiento de las especificaciones y de los requisitos de la interfaz en el funcionamiento del producto; (c) manejo incorrecto; (d) errores en artículos o servicios ajenos a D-LINK o no sujetos a una garantía o un contrato de mantenimiento vigentes de D-LINK; (e) uso o almacenamiento incorrecto; o (f) fuego, agua, casos fortuitos u otros hechos catastróficos. Esta garantía tampoco es válida para aquellos productos a los que se haya eliminado o alterado de algún modo el número de serie D-LINK.

D-LINK NO SE RESPONSABILIZA DE LOS DAÑOS CAUSADOS COMO CONSECUENCIA DEL INCUMPLIMIENTO DE LAS INSTRUCCIONES DEL PRODUCTO DE HARDWARE D-LINK.

### Período de la garantía limitada del producto

El período de la garantía limitada del producto se inicia en la fecha en que se realizó la compra a D-LINK. Para el comprador, el comprobante de la fecha de la compra es el recibo de la venta o de la entrega, en el que figura la fecha de la compra del producto. Puede ser necesario tener que presentar el comprobante de la compra a fin de que se preste el servicio de garantía. El comprador tiene derecho al servicio de garantía conforme a los términos y condiciones de este documento, si requiere una reparación del hardware de la marca D-LINK dentro del período de garantía limitada del producto.

Esta garantía limitada del producto cubre sólo al originario comprador-usuario final de este producto de hardware D-LINK, y no es transferible a otras personas que reciban el producto de hardware D-LINK del originario comprador-usuario final.

Tipo de producto	Período de garantía del producto
Conmutadores gestionados (p. ej., conmutadores con agente SNMP integrado) (incluyendo módulos y software de gestión)	Cinco (5) años
Resto de productos	Dos (2) años
Piezas de repuesto (p. ej., adaptadores de alimentación externos, ventiladores)	Un (1) año

Estos períodos de garantía están en vigor para todos los productos D-LINK que hayan sido comprados en países europeos a D-LINK o a alguno de sus proveedores o distribuidores autorizados a partir del 1 de enero del 2004. Todos los productos comprados en países europeos a D-LINK o a uno de sus proveedores o distribuidores autorizados antes del 1 de enero del 2004 cuentan con 5 años de garantía, excepto las fuentes de alimentación, los ventiladores y los accesorios, que cuentan con 2 años de garantía.

El período de garantía que figura en esta tarjeta sustituye y reemplaza al período de garantía que consta en el manual del usuario o en el contrato de compra de los productos correspondientes. Para evitar dudas: si usted ha comprado el producto D-LINK correspondiente como consumidor, sus derechos legales no se ven afectados.

## **Uso de la garantía limitada del producto**

Si un producto presenta algún defecto, la obligación exclusiva de D-LINK será reparar o reemplazar, sin coste alguno para el comprador originario, cualquier producto defectuoso siempre y cuando éste sea entregado en un centro autorizado de servicio D-LINK durante el periodo de garantía. D-LINK realizará la reparación o sustitución para un centro autorizado de servicio D-LINK. Todos los productos de hardware o componentes que se eliminen bajo esta garantía limitada serán propiedad de D-LINK. La parte o el producto de repuesto adquiere, para el resto de la garantía limitada, el estatus de parte o producto eliminado. El producto de repuesto no ha de ser nuevo o de la misma marca, modelo o parte; D-LINK puede sustituir a discreción el producto defectuoso (o cualquier parte) con un producto equivalente reacondicionado (o superior) en cualquier material respecto al producto defectuoso. D-LINK puede pedir el comprobante de compra.

## **Garante**

D-Link (Europe) Ltd.  
4th Floor, Merit House  
Edgware Road  
Colindale  
London NW9 5 AB  
United Kingdom

Teléfono: +44-020-8731-5555

Fax: +44-020-8731-5511

[www.dlink.co.uk](http://www.dlink.co.uk)

## D-Link Europe Termini di Garanzia dei Prodotti

### Generalità

La presente Garanzia viene fornita da D-LINK (Europe) Ltd. (di seguito denominata "D-LINK"). Essa viene riconosciuta solo se accompagnata dalla prova di acquisto. D-LINK può richiedere anche l'esibizione della presente cartolina di garanzia.

SALVO QUANTO ESPRESSAMENTE STABILITO NELLA PRESENTE GARANZIA LIMITATA, D-LINK NON FORNISCE NESSUN'ALTRA GARANZIA NE' ESPRESSA NE' IMPLICITA, COMPRESSE EVENTUALI GARANZIE DI COMMERCIALIZZABILITÀ O DI IDONEITÀ PER UN PARTICOLARE SCOPO. D-LINK NEGA ESPRESSAMENTE QUALUNQUE ALTRA GARANZIA CHE NON RIENTRI NELLA PRESENTE GARANZIA LIMITATA. QUALSIASI GARANZIA IMPLICITA, CHE DOVESSE ESSERE IMPOSTA PER LEGGE, SARÀ CIRCOSCRITTA ALLA DURATA DELLA PRESENTE GARANZIA. ALCUNI PAESI VIETANO QUALSIASI LIMITAZIONE DEL PERIODO DI VALIDITÀ DELLE GARANZIE IMPLICITE OPPURE L'ESCLUSIONE O LA LIMITAZIONE DEI DANNI INCIDENTALI O CONSEGUENZIALI PER I PRODOTTI. IN TALI PAESI, EVENTUALI ESCLUSIONI O LIMITAZIONI DELLA PRESENTE GARANZIA NON POTRANNO APPLICARSI AL VOSTRO CASO. LA PRESENTE GARANZIA VI CONFERISCE DIRITTI LEGALI SPECIFICI. INOLTRE POTRETE GODERE DI ULTERIORI DIRITTI CHE POSSONO VARIARE A SECONDA DEL PAESE. SIETE INVITATI A CONSULTARE LE LEGGI APPLICABILI DEL VOSTRO PAESE AL FINE DI DETERMINARE CON PRECISIONE I VOSTRI DIRITTI.

La presente garanzia trova applicazione su tutti i prodotti hardware recanti il marchio D-LINK (di seguito denominati collettivamente "Prodotti hardware D-LINK") venduti da D-LINK (Europe) Ltd., dalle sue controllate, dalle sue affiliate, dai rivenditori autorizzati o dai distributori nazionali (di seguito denominati collettivamente "D-LINK"), accompagnati dalla presente garanzia limitata. Il termine "Prodotto hardware D-LINK" si riferisce esclusivamente ai componenti hardware e a tutte le parti interne compreso il firmware. Il termine "Prodotto hardware D-LINK" NON comprende eventuali applicazioni o programmi software.

### Ambito geografico della Garanzia limitata

La presente Garanzia è estesa a tutti i Paesi europei elencati nell'appendice "Paesi europei - Garanzia limitata dei prodotti D-LINK". Il termine "Paesi europei" si riferisce esclusivamente ai paesi nominati in questa appendice. La Garanzia verrà riconosciuta in tutti i paesi nei quali D-LINK o i suoi Centri di Assistenza autorizzati offrono assistenza conformemente alle condizioni e ai termini stabiliti nella presente Garanzia. Tuttavia, la disponibilità all'assistenza e i tempi di intervento variano da paese a paese e possono essere soggetti a eventuali requisiti di registrazione.

### Limitazione della Garanzia

D-LINK garantisce che i prodotti sotto descritti in condizioni di normale utilizzo non presentano difetti di fabbricazione o vizi di materiale durante il Periodo di garanzia sotto specificato ("Periodo di garanzia"), a condizione che vengano utilizzati e sottoposti a manutenzione in conformità con il manuale d'uso e con ogni altra documentazione fornita all'acquirente all'atto dell'acquisto (e relativi emendamenti). D-LINK non garantisce che il funzionamento del prodotto sarà ininterrotto o esente da errori né tanto meno che tutti gli eventuali errori, carenze, difetti o non conformità potranno essere corretti.

La presente garanzia non copre eventuali problemi derivanti da: (a) alterazioni o aggiunte non autorizzate; (b) negligenza, abuso o utilizzo improprio, compresa l'incapacità di far funzionare il prodotto in conformità con le specifiche e i requisiti di connessione; (c) movimentazione impropria; (d) guasto di prodotti o servizi non forniti da D-LINK o non soggetti a una garanzia successiva di D-LINK o a un accordo di manutenzione; (e) impiego o conservazione impropri; (f) incendio, inondazione, cause di forza maggiore o altro evento catastrofico accidentale. La presente garanzia non si applica altresì ad alcun prodotto particolare qualora il numero di serie di D-LINK sia stato rimosso o reso illeggibile in altro modo.

D-LINK DECLINA OGNI RESPONSABILITÀ PER EVENTUALI DANNI RISULTANTI DAL MANCATO RISPETTO DELLE ISTRUZIONI RELATIVE AL PRODOTTO HARDWARE D-LINK.

### Periodo di garanzia

Il Periodo di garanzia ha decorrenza dalla data dell'acquisto presso D-LINK. Prova della data di acquisto è il documento fiscale (scontrino fiscale o ricevuta) recante la data di acquisto del prodotto. Per avere diritto alla garanzia può esservi richiesto di esibire la prova di acquisto. Potete beneficiare delle prestazioni di assistenza previste dalla garanzia in conformità con i termini e le condizioni di cui sotto nel momento in cui il Vostro prodotto hardware D-LINK necessita di una riparazione durante il Periodo di garanzia.

La presente Garanzia si applica esclusivamente al primo acquirente del Prodotto hardware D-LINK e non può essere trasferita a terzi che abbiano ottenuto la proprietà del Prodotto hardware D-LINK dal primo acquirente.

Tipo di prodotto	Periodo di garanzia
Switch (solo switch dotati di agente SNMP incorporato) (inclusi moduli e software di gestione)	5 (cinque) anni
Tutti gli altri prodotti	2 (due) anni
Pezzi di ricambio (es. adattatori esterni di potenza, alimentatori esterni, ventole)	1 (un) anno

Il periodo di garanzia sopra specificato relativamente a tutti i prodotti D-LINK venduti nei Paesi europei da D-LINK o da qualsiasi suo rivenditore o distributore autorizzato decorre dal 1° gennaio 2004. Tutti i prodotti venduti nei Paesi europei da D-LINK o da uno qualsiasi dei suoi rivenditori o distributori autorizzati prima del 1° gennaio 2004 sono coperti da una garanzia di 5 anni fatto salvo per alimentatori, ventole e accessori che hanno 2 anni di garanzia.

Il periodo di garanzia qui menzionato sostituisce qualsiasi altro periodo di garanzia definito nel manuale d'uso o nel contratto di acquisto del prodotto. Se avete acquistato un prodotto D-LINK in qualità di consumatore i Vostri diritti rimangono invariati.

## **Prestazioni della Garanzia limitata**

Qualora comparisse un difetto o una non conformità, D-LINK avrà l'unico obbligo di riparare o sostituire il prodotto non conforme senza alcun costo per l'acquirente a condizione che il prodotto venga restituito a un Centro di Assistenza autorizzato D-LINK entro il periodo di garanzia. La riparazione o la sostituzione verranno eseguite da D-LINK presso un Centro di Assistenza autorizzato D-LINK. Tutti i componenti o i prodotti hardware rimossi conformemente ai termini e alle condizioni della presente garanzia divengono di proprietà di D-LINK. Il pezzo o il prodotto in sostituzione beneficerà della garanzia per il tempo residuo della parte o del prodotto originale. Il prodotto in sostituzione non deve necessariamente essere nuovo o di identica fattura, modello o composizione; D-LINK può a sua discrezione sostituire il prodotto non conforme (o qualsiasi parte di esso) con un prodotto che risulti essere equivalente (o di valore superiore) al prodotto non conforme. D-LINK può richiedere che venga esibita la prova di acquisto.

## **Garante**

D-Link (Europe) Ltd.  
4th Floor, Merit House  
Edgware Road  
Colindale  
Londra NW9 5 AB  
Regno Unito

Telefono: +44-020-8731-5555

Fax: +44-020-8731-5511

[www.dlink.co.uk](http://www.dlink.co.uk)

## International Offices

U.S.A  
17595 Mt. Herrmann Street  
Fountain Valley, CA. 92708  
TEL: 714-885-6000  
Fax 866-743-4905  
URL: www.dlink.com

Canada  
2180 Winston Park Drive  
Oakville, Ontario, L6H 5W1  
Canada  
TEL: 1-905-8295033  
FAX: 1-905-8295223  
URL: www.dlink.ca

Europe (U. K.)  
4th Floor, Merit House  
Edgware Road, Colindale  
London NW9 5AB  
U.K.  
TEL: 44-20-8731-5555  
FAX: 44-20-8731-5511  
URL: www.dlink.co.uk

Germany  
Schwalbacher Strasse 74  
D-65760 Eschborn  
Germany  
TEL: 49-6196-77990  
FAX: 49-6196-7799300  
URL: www.dlink.de

France  
Le Florilege #.2, Allee de la  
Fresnerie  
78330 Fontenay le Fleury  
France  
TEL: 33-1-30238688  
FAX: 33-1-30238689  
URL: www.dlink-france.fr

Netherlands  
Weena 290  
3012 NJ Rotterdam  
Netherlands  
Tel: +31-10-282-1445  
Fax: +31-10-282-1331  
URL: www.dlink-benelux.com

Belgium  
Rue des Colonies 11  
B-1000 Brussels  
Belgium  
Tel: +32(0)2 517 7111  
Fax: +32(0)2 517 6500  
URL: www.dlink-benelux.com

Italy  
Via Nino Bonnet n. 6/b  
20154 – Milano,  
Italy  
TEL: 39-02-2900-0676  
FAX: 39-02-2900-1723  
URL: www.dlink.it

Sweden  
P.O. Box 15036, S-167 15 Bromma  
Sweden  
TEL: 46-(0)8564-61900  
FAX: 46-(0)8564-61901  
URL: www.dlink.se

Denmark  
Naverland 2, DK-2600  
Glostrup, Copenhagen,  
TEL: 45-43-969040  
FAX: 45-43-424347  
URL: www.dlink.dk

Norway  
Karihaugveien 89  
1086 Oslo  
Norway  
TEL: 47-23-897189  
FAX: 47-22-309085  
URL: www.dlink.no

Finland  
Latokartanontie 7A  
FIN-00700 HELSINKI  
Finland  
TEL : +358-10 309 8840  
FAX: +358-10 309 8841  
URL: www.dlink.fi

Iberia  
C/Sabino De Arana,  
56 Bajos  
08028 Barcelona  
TEL: 34 93 4090770  
FAX: 34 93 4910795  
URL: www.dlinkiberia.es

Singapore  
1 International Business Park  
#03-12 The Synergy  
Singapore 609917  
TEL: 65-6774-6233  
FAX: 65-6774-6322  
URL: www.dlink-intl.com

Australia  
1 Giffnock Avenue,  
North Ryde, NSW 2113  
Australia  
TEL: 61-2-8899-1800  
FAX: 61-2-8899-1868  
URL: www.dlink.com.au

India  
D-Link House, Kurla Bandra  
Complex Road,  
Off CST Road, Santacruz (East),  
Mumbai - 400098.  
India  
TEL: 91-022-26526696/56902210  
FAX: 91-022-26528914  
URL: www.dlink.co.in

Middle East (Dubai)  
P.O.Box: 500376  
Office No.:103, Building:3  
Dubai Internet City  
Dubai, United Arab Emirates  
Tel:+971-4-3916480  
Fax:+971-4-3908881  
URL: www.dlink-me.com

Turkey  
Regus Offices  
Beybi Giz Plaza, Ayazaga Mah.  
Meydan Sok. No:28  
Maslak 34396, Istanbul-Turkiye  
TEL: +90 212 335 2553  
FAX: +90 212 335 2500  
URL: www.dlink.com.tr

Egypt  
19 El-Shahed Helmy, El Masri  
Al-Maza, Heliopolis  
Cairo,Egypt.  
TEL:+202 414 4295  
FAX:+202 415 6704  
URL: www.dlink-me.com

Israel  
11 Hamanofim Street  
Ackerstein Towers, Regus Business  
Center  
P.O.B 2148, Hertzelia-Pituach  
46120.  
Israel  
TEL: +972-9-9715700  
FAX: +972-9-9715601  
URL: www.dlink.co.il

LatinAmerica  
Isidora Goyechea 2934 of 702,  
Las Condes  
Santiago – Chile S.A.  
TEL: 56-2-232-3185  
FAX: 56-2-232-0923  
URL: www.dlink.cl

Brasil  
Av das Nacoes Unidas,  
11857 - 14 - andar - cj 141/142  
Brooklin Novo  
Sao Paulo - SP - Brazil  
CEP 04578-000  
TEL: +55 11 55039320  
FAX: +55 11 55039322  
URL: www.dlinkbrasil.com.br

South Africa  
Einstein Park II  
Block B  
102-106 Witch-Hazel Avenue  
Highveld Technopark  
Centurion  
Gauteng  
Republic of South Africa  
TEL: 27-12-665-2165  
FAX: 27-12-665-2186  
URL: www.d-link.co.za

Russia  
Grafsky per., 14, floor 6  
Moscow  
129626 Russia  
TEL: 7-095-744-0099  
FAX: 7-095-744-0099 #350  
URL: www.dlink.ru

China  
No.202,C1 Building, Huitong  
Office Park,  
No.71, Jianguo Road, Chaoyang  
District, Beijing,  
100025, China.  
TEL +86-10-58635800  
FAX: +86-10-58635799  
URL: www.dlink.com.cn

Taiwan  
2F, No. 119, Pao-Chung Rd.  
Hsin-Tien, Taipei  
Taiwan  
TEL: 886-2-2910-2626  
FAX: 886-2-2910-1515  
URL: www.dlinktw.com.tw

Headquarters  
2F, No. 233-2, Pao-Chiao Rd.  
Hsin-Tien, Taipei  
Taiwan  
TEL: 886-2-2916-1600  
FAX: 886-2-2914-6299



# Registration Card

## All Countries and Regions Excluding USA

*Print, type or use block letters.*

Your name: Mr./Ms \_\_\_\_\_

Organization: \_\_\_\_\_ Dept. \_\_\_\_\_

Your title at organization: \_\_\_\_\_

Telephone: \_\_\_\_\_ Fax: \_\_\_\_\_

Organization's full address: \_\_\_\_\_

\_\_\_\_\_

Country: \_\_\_\_\_

Date of purchase (Month/Day/Year): \_\_\_\_\_

Product Model	Product Serial No.	* Product installed in type of computer (e.g., Compaq 486)	* Product installed in computer serial No.

(\* Applies to adapters only)

*Product was purchased from:*

Reseller's name: \_\_\_\_\_

Telephone: \_\_\_\_\_ Fax: \_\_\_\_\_

Reseller's full address: \_\_\_\_\_

\_\_\_\_\_

\_\_\_\_\_

**Answers to the following questions help us to support your product:**

**1. Where and how will the product primarily be used?**

- Home Office Travel Company Business Home Business Personal Use

**2. How many employees work at installation site?**

- 1 employee 2-9 10-49 50-99 100-499 500-999 1000 or more

**3. What network protocol(s) does your organization use ?**

- XNS/IPX TCP/IP DECnet Others \_\_\_\_\_

**4. What network operating system(s) does your organization use ?**

- D-Link LANsmart Novell NetWare NetWare Lite SCO Unix/Xenix PC NFS 3Com 3+Open  
Banyan Vines DECnet Pathwork Windows NT Windows NTAS Windows '95  
Others \_\_\_\_\_

**5. What network management program does your organization use ?**

- D-View HP OpenView/Windows HP OpenView/Unix SunNet Manager Novell NMS  
NetView 6000 Others \_\_\_\_\_

**6. What network medium/media does your organization use ?**

- Fiber-optics Thick coax Ethernet Thin coax Ethernet 10BASE-T UTP/STP  
100BASE-TX 100BASE-T4 100VGAnyLAN Others \_\_\_\_\_

**7. What applications are used on your network?**

- Desktop publishing Spreadsheet Word processing CAD/CAM  
Database management Accounting Others \_\_\_\_\_

**8. What category best describes your company?**

- Aerospace Engineering Education Finance Hospital Legal Insurance/Real Estate Manufacturing  
Retail/Chainstore/Wholesale Government Transportation/Utilities/Communication VAR  
System house/company Other \_\_\_\_\_

**9. Would you recommend your D-Link product to a friend?**

- Yes No Don't know yet

**10. Your comments on this product?**

\_\_\_\_\_

\_\_\_\_\_

PLEASE  
PLACE STAMP  
HERE

**TO:**

\_\_\_\_\_  
\_\_\_\_\_  
\_\_\_\_\_

**D-Link®**