

DCS-6110

Fixed Dome Network Camera

User Manual

Business Class Networking

Table of Contents

Product Overview	4	Dynamic DNS.....	43
Package Contents	4	Image Setup.....	44
System Requirements	4	Audio and Video.....	45
Introduction.....	5	Motion Detection.....	46
Features.....	6	Time and Date	49
Hardware Overview	8	Event Setup.....	50
Connections.....	8	Add Server	52
LEDs	9	Add Media.....	53
Hardware Installation.....	10	Add Event.....	56
Network Deployment.....	11	Add Recording	57
Software Installation	12	Access List.....	59
Configuration	15	DI and DO	60
Setup Wizard Configuration.....	15	Maintenance	60
Adjusting the lens.....	23	Device Management.....	60
Attaching the Enclosure.....	24	Backup and Restore	61
Web-based Configuration Utility.....	25	Firmware Update.....	62
Live Video.....	26	Status	63
Camera.....	26	Device Info	63
Snapshot.....	27	Logs.....	64
Client Setup.....	28	Help.....	65
Setup.....	29	D-ViewCam Installation.....	66
Wizard.....	29	Add a Camera	69
Internet Connection Setup Wizard.....	29	Frequently Asked Questions	74
Motion Detection Setup Wizard.....	34	Networking Basics	77
Network Setup	37		

Check your IP address.....	77
Statically Assign an IP address.....	78
Reset and Restore	79
External I/O Port.....	80
Technical Specifications	81

Package Contents

- D-Link DCS-6110 Fixed Dome Network Camera
- CAT5 Ethernet Cable
- Power Adapter
- Dome Enclosure
- Ring Enclosure
- Screw Driver
- Screws
- I/O Connector
- Alignment Paper
- Manual and Software on CD
- Quick Install Guide

Note: Using a power supply with a different voltage than the one included with your product will cause damage and void the warranty for this product.

If any of the above items are missing, please contact your reseller.



System Requirements

- Windows® XP or Windows Vista™
- At least 256MB of memory (512MB recommended)
- An available Ethernet connection
- Internet Explorer 6.x or higher Internet Web Browser
- VGA card resolution: 800x600 or above
- CPU: 1.7GHz or above processor (2.8GHz plus processor with 512MB memory and a 32MB video card is required for multiple camera viewing and recording in IP surveillance program)

Introduction

DCS-6110 fixed dome network camera is cost-effective and an ideal security solution providing high quality real-time videos in MPEG-4 and JPEG compression for small to medium-sized businesses, office and homes. The DCS-6110 features 3G mobile video support, enabling you to view a live video feed from your camera on a compatible 3G mobile phone or PDA anywhere in your 3G coverage area. The 3G mobile video support allows you to monitor a remote location without using a computer or an internet connection. In addition supports dual stream output for simultaneous live monitoring and high resolution recording. D-ViewCam software is also included to manage up to 32 cameras simultaneously from your computer, send automated e-mail alerts, and record video to your hard drive when motion is detected. The DCS-6110 is a deluxe-size dome network camera, giving you a more professional look to your business or location making it an excellent choice for home and business surveillance.

Note: *Use of video equipment for recording the image of a person without their knowledge and consent is prohibited in certain states or jurisdictions. Nothing herein represents a warranty or representation that the D-Link product provided herein is suitable for the end-user's intended use under the applicable laws of his or her state. D-Link disclaims any liability whatsoever for any end-user use of the D-Link product, which fails to comply with applicable state, local, or federal laws.*

Features

- **Powerful Surveillance** - DCS-6110 targets entry level market. The VGA Progressive CMOS technology delivers exceptional picture quality. Use D-Link's SoC (system-on-chip) products to provide high quality real-time video compression in MPEG-4 and Motion JPEG formats. DCS-6110 supports simultaneous dual-streaming for live monitoring and recording. With the free-bundled 32-channel recording software, the DCS-6110 is an ideal solution for high quality viewing and reliable recording.
- **Sharp Image Monitoring From Different Angles** - The DCS-6110 is recommended for indoor ceiling mounting, and thus prevents possible damage that maybe caused by a burglar. This network camera has a built-in three axis mechanism for wall mount installation. The DCS-6110 provides high quality real-time videos in MPEG-4 and JPEG compression with VGA/QVGA/QQVGA resolution. It is suitable for narrow space surveillance, like an elevator.
- **View Live Video from a 3G Mobile Phone** - The live camera feed of the camera can be pulled from the 3G cellular network by using a compatible cell phone or PDA with a 3G video player. Anywhere within the 3GPP service area, users are offered a flexible and convenient way to remotely monitor a home or office in real time.
- **Wired PoE Access** - For effective surveillance in and around a building, this camera comes with a built-in 802.3af compliant Power Over Ethernet (PoE) module, which eases the installation process and also gives you the freedom to place the camera where it's needed. In addition, the 10/100BASE-TX Ethernet port is also provided for convenient connection to an Ethernet network or to a broadband Internet via a gateway router.
- **Smart & Easy To Use** - The software allows you to view up to 32 cameras on a single computer screen at one central location. Users can set up automated e-mail alerts to be instantly informed of unusual activities. Fixed dome cameras usually uses fixed focus lens, but the DCS-6110 also has a vari-focal lens. Vari-focal lens provides easier installation process because the board lens of dome camera is not like CS/C mount lens, it is not changeable. Drop ceiling bracket is another alternative option for an installation method. In addition, this network camera supports the Universal Plug-n-Play feature, which allows computers running on Windows 2000/XP/Vista to automatically recognize the camera and adds it to the network. Sign up with one of the free Dynamic DNS services available on the web, to assign a name and domain to the camera (e.g.mycamera.dlinkdns.com). This allows users to remotely access the camera without having to remember the IP address.

- **Supports a Variety of Protocols** - The DCS-6110 supports a wide variety of protocols such as RTSP, FTP, SMTP, NTP and HTTP. In addition, supports UPnP and DDNS. DDNS allows your camera to be accessed using a static host name rather than an IP address. UPnP allows Windows XP users to install the camera with a single mouse click.
- **Web Configuration** - Using a Web browser, administrators can configure and manage the network camera directly from its own Web page via the Intranet or the Internet. Up to 20 user names and passwords are permitted, with privilege settings controlled by the administrator.
- **Connection to External Devices** - Supporting auxiliary Input/Output connectors, you can connect the Network Camera to a variety of external devices such as IR-sensors, switches and alarm relays. Combined with programmable alarming equipment, you can develop a variety of security applications that are triggered on alarm-based events. The Network Camera provides an industry standard in/out external connector for connectivity.

Note: *Use of audio or video equipment for recording the image or voice of a person without their knowledge and consent is prohibited in certain states or jurisdictions. Nothing herein represents a warranty or representation that the D-Link product provided herein is suitable for the end-user's intended use under the applicable laws of his or her state. D-Link disclaims any liability whatsoever for any end-user use of the D-Link product, which fails to comply with applicable state, local, or federal laws.*

Hardware Overview

Connections



DC Power Connector

The DC power input connector is located on the side panel of the DCS-6110 labeled 12VDC with a single socket to supply power to the network camera.

Ethernet Cable Connector (PoE)

The network camera's side panel features an RJ-45 connector for connections to 10Base-T Ethernet cabling or 100Base-TX Fast Ethernet cabling. This network port supports the NWay protocol, allowing this network camera to automatically detect or negotiate the transmission speed of the network. The Ethernet port can also be used to power the camera by using a PoE switch.

Reset Button

Reset is initiated when the reset button is pressed once and held until the power LED flashes through its cycle twice.

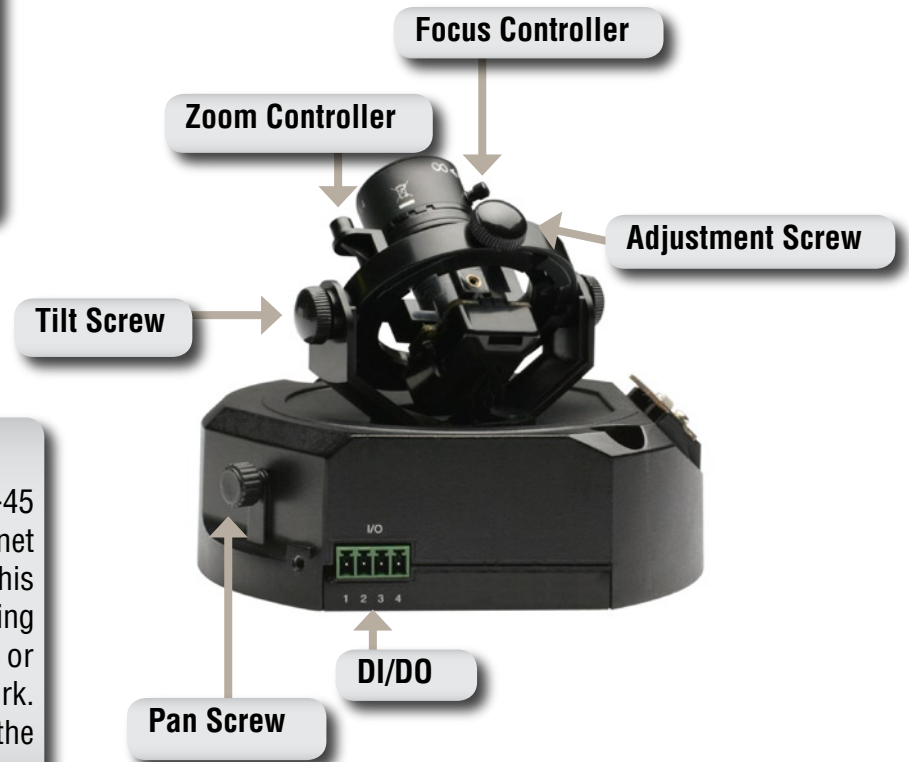

Focus Controller

Zoom Controller

Adjustment Screw

Tilt Screw

Pan Screw

DI/DO

Hardware Overview

LEDs



Hardware Installation

When Mounting to a Ceiling

Find a suitable place to install the camera using the installment stencil. Place the camera at the desired operating location and insert the screws through the two holes located at the base of the camera. Use screwdriver to tighten and secure.

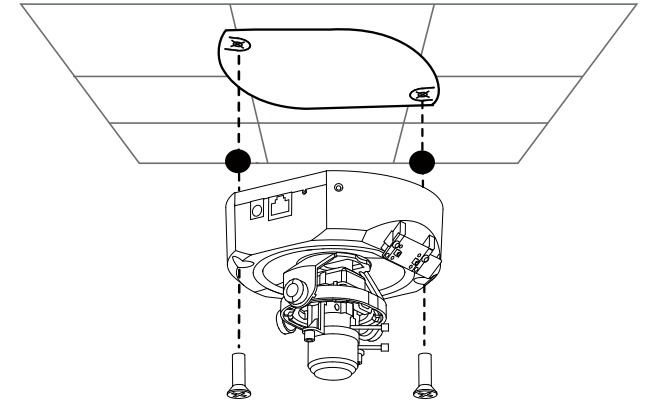

When Mounting to a Wall

Find a suitable place to install the camera by using the installment stencil to find a desired operating location on the wall. Drill two pilot holes where the holes of the installment stencil are located. Insert the supplied plastic anchors into the drilled holes, and align the holes at the base of the camera with the plastic anchors. Once aligned, insert the provided screws through the holes with screwdriver to tighten and secure.

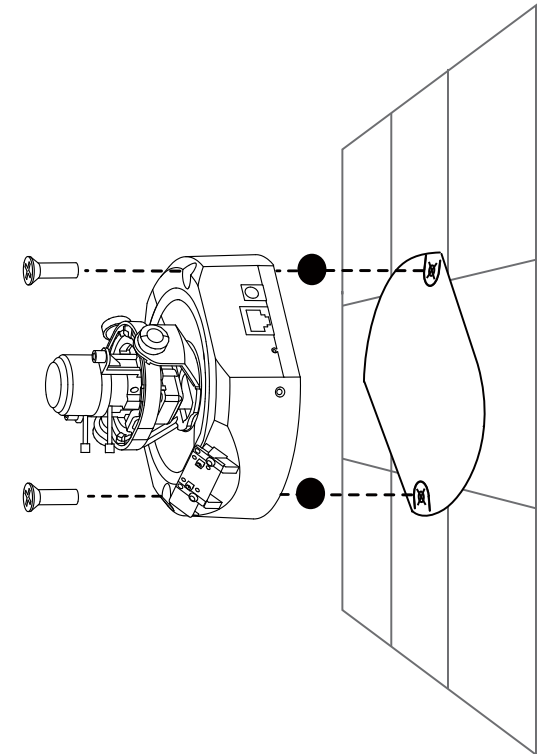

Network Deployment

General Connection (without PoE)

Connect the network camera to a hub via Ethernet cable.
Connect the supplied power cable from the camera to a power outlet.

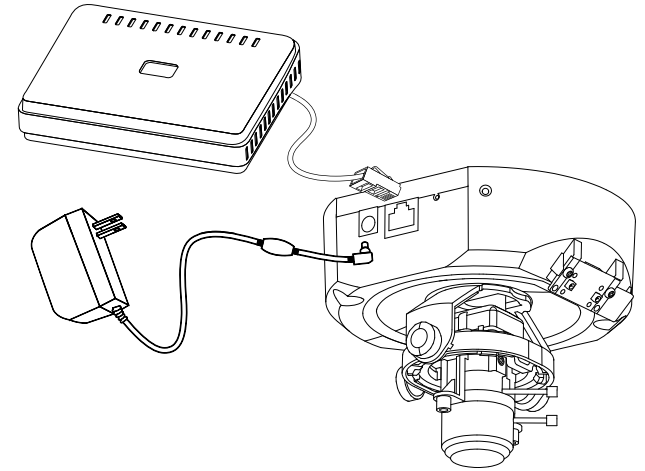

Connection with a PoE Hub/Switch

If using a PoE hub/switch, connect the network camera to the hub/switch via Ethernet cable, which will provide transmission for both power and data over a single cable.

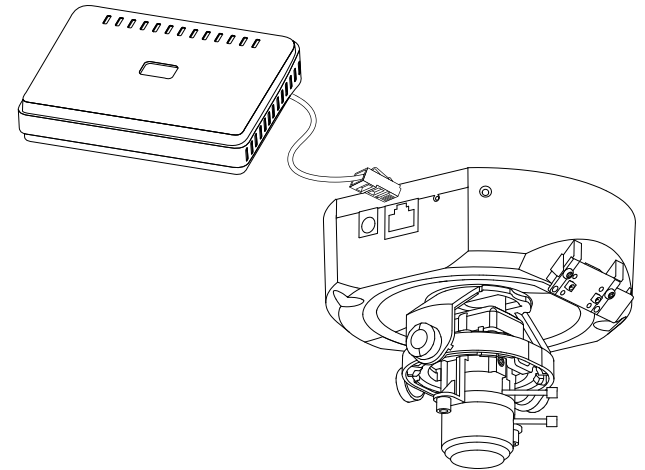

Software Installation

Turn on the computer and insert the D-Link DCS-6110 Autorun CD into the CD-ROM drive. The following step-by-step instructions displayed are shown when using Windows Vista operating system. The steps and screens are similar when using other Windows operating systems.

Click on **Installation Wizard** to begin software installation.



The Installation Setup Wizard window will pop up. Click **Next** to continue.



Click **Next**

Click **I Agree** to accept the License Agreement.

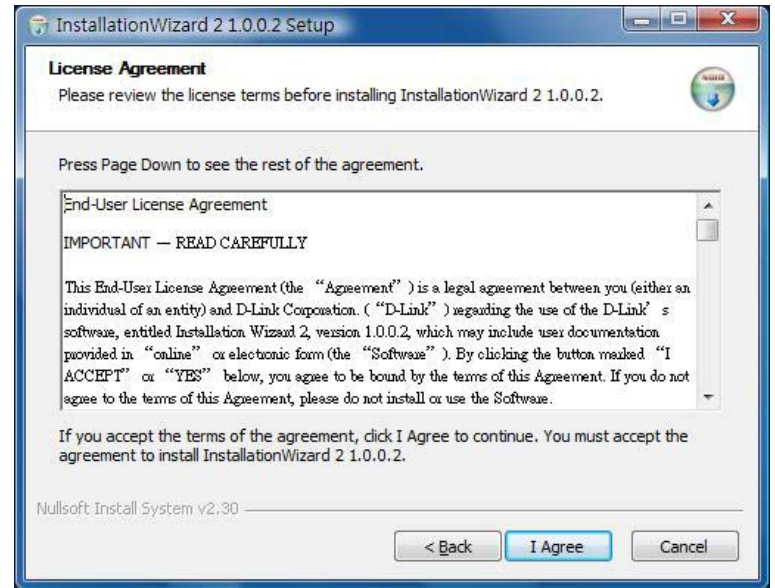

Click **I Agree**

Click the **Browse** button if you would like to change the destination of installation, otherwise click **Install** to continue.

Note: Installation may take several minutes to complete.

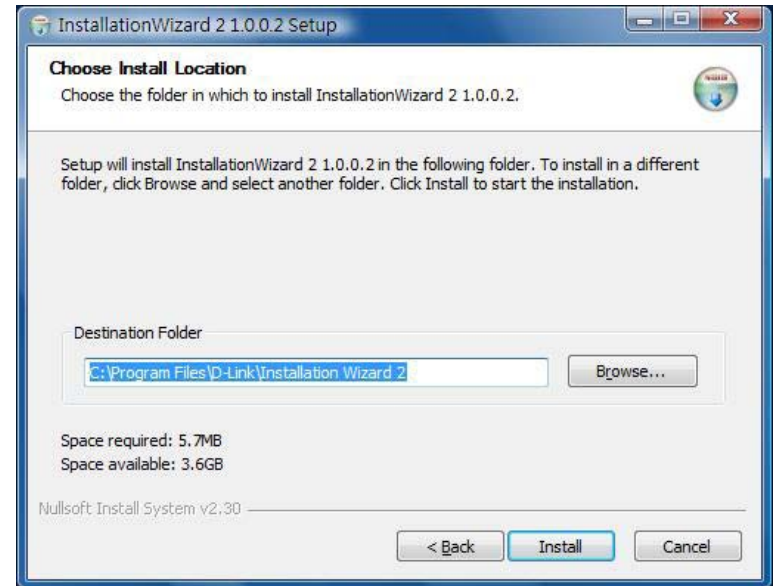

Click **Install**

To start the installation click **Install**.

Note: *The installation may take several minutes to complete.*

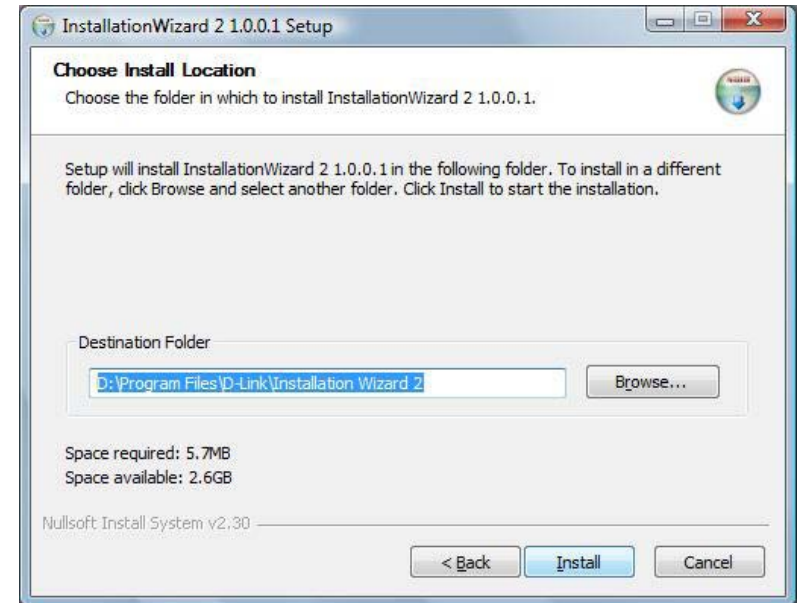

Click **Finish** to complete installation and the D-Link Installation Wizard window will pop up for camera configuration.

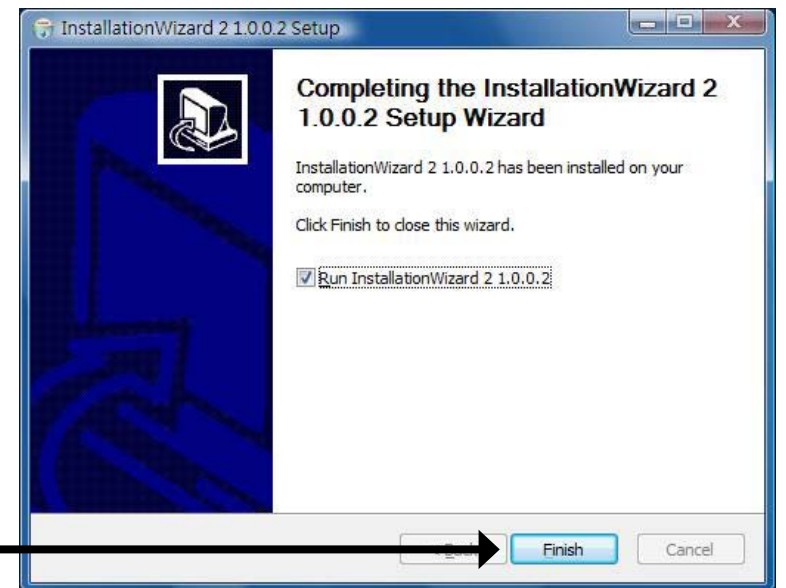

Click **Finish**

Configuring Your Camera with the Installation Wizard

If the **D-Link Installation Wizard** window does not pop up after completion of software installation, click on the icon that was created in your Windows Start Menu.

The Installation Wizard will appear and show the MAC address and IP address of the DCS-6110, which may appear to be different from the actual address depending on what your device is connected to. If you have a DHCP server on your network, there will be a valid IP address displayed here.

Note: A DHCP server is a device that supplies the same IP address.

To begin setup, single-click on the DCS-6110 located in the camera list and click **Manual Setup** located on the left of the Installation Wizard.

Click **Manual Setup**

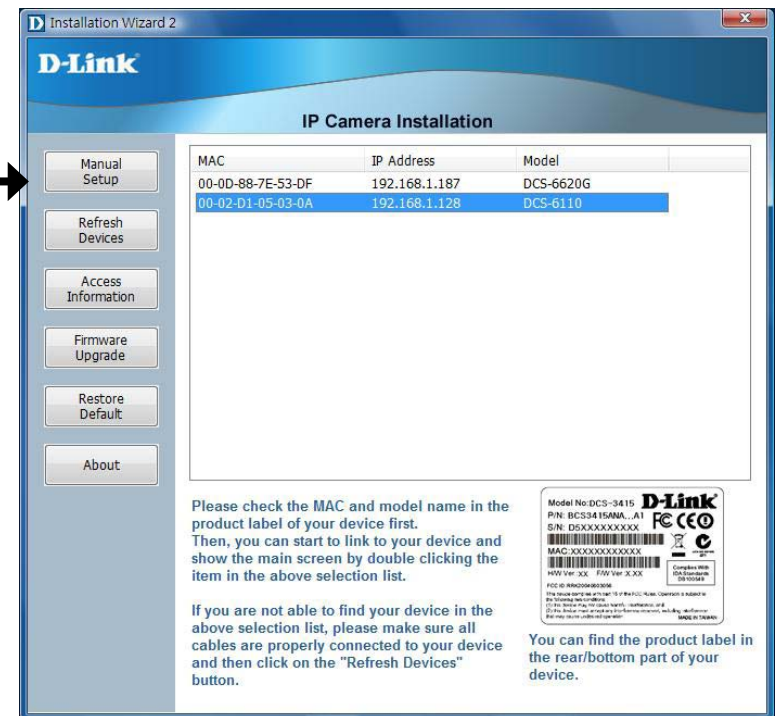

Enter a password, and confirm the password for the admin ID and click **Next**.

Note: The default administrator username is set to admin and the password may be left blank. The password can be changed after installation.

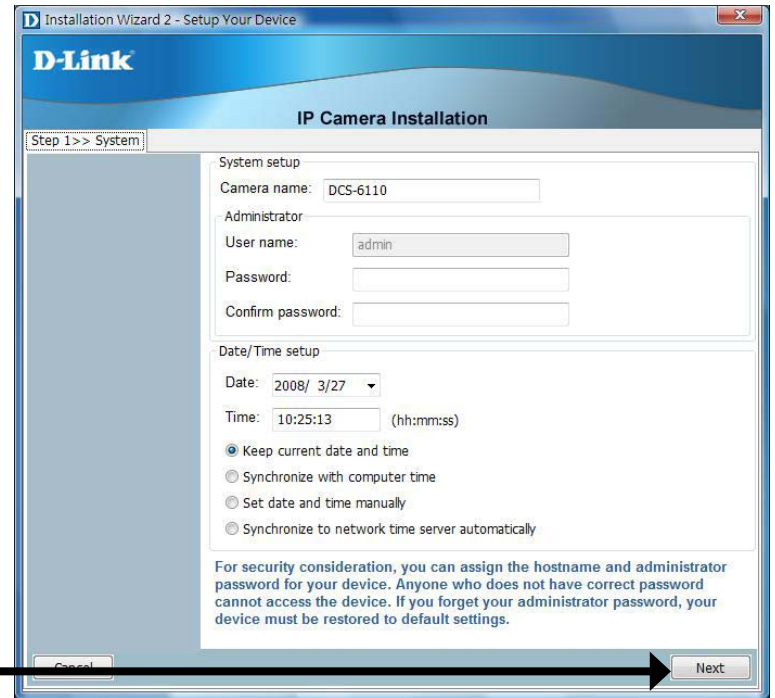

Click **Next**

PPPoE Setup

The **Network Type** screen displays will pop up to ask if you want to setup a PPPoE for the device. Click **No** for quick setup and skip to the next page .

Note: *By using PPPoE, users can virtually dial from one machine to another over an Ethernet network, establish a point to point connection between them and then securely transport data packets over the connection.*

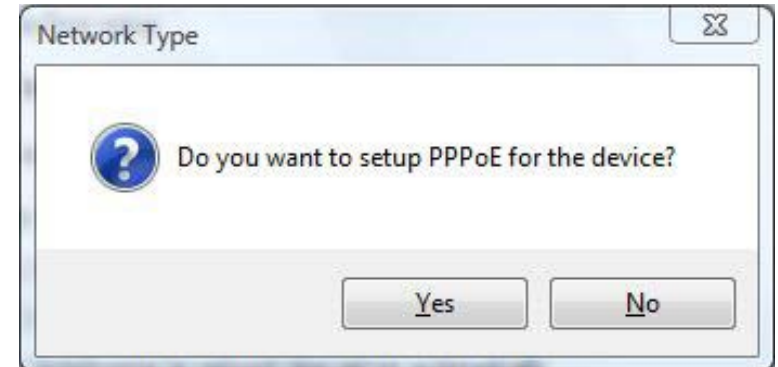

The **PPPoE Setting** screen displays. Enter the username and password provided by your ISP to connect to the Internet by PPPoE.

Click **Next** and skip to the setup screen as seen in page 19.

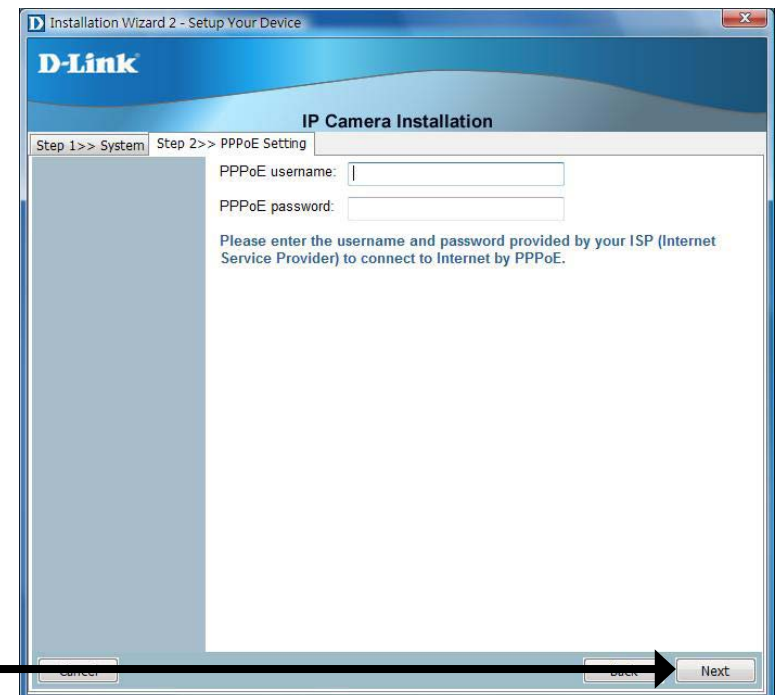

Click **Next**

Check the **Get IP by DHCP Server automatically** box to obtain a new IP address every time the camera starts up. Click **Next** to continue.

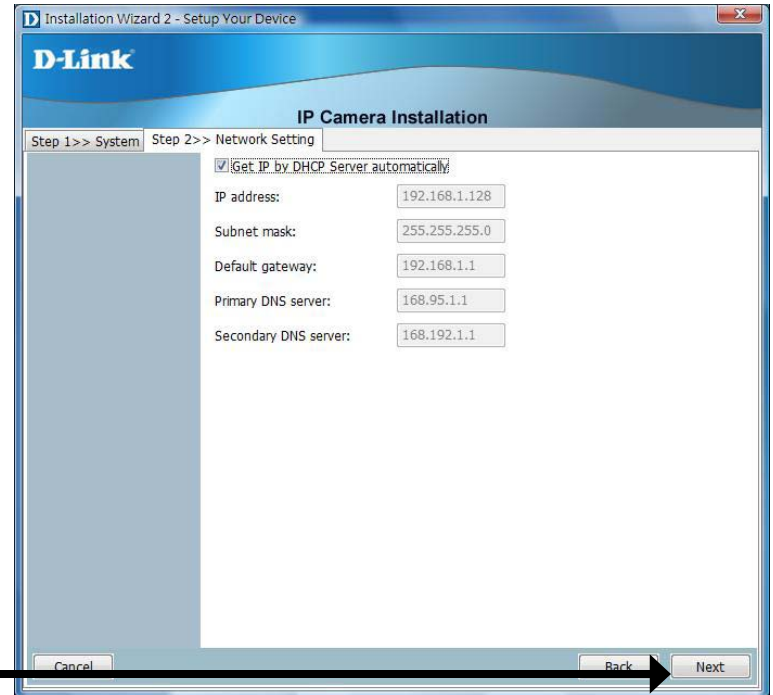

Click **Next**

Select **UPnP Port Forwarding** if your router supports this function. If not, choose **Manual** to manually enter your port numbers. Click **Next** to continue.

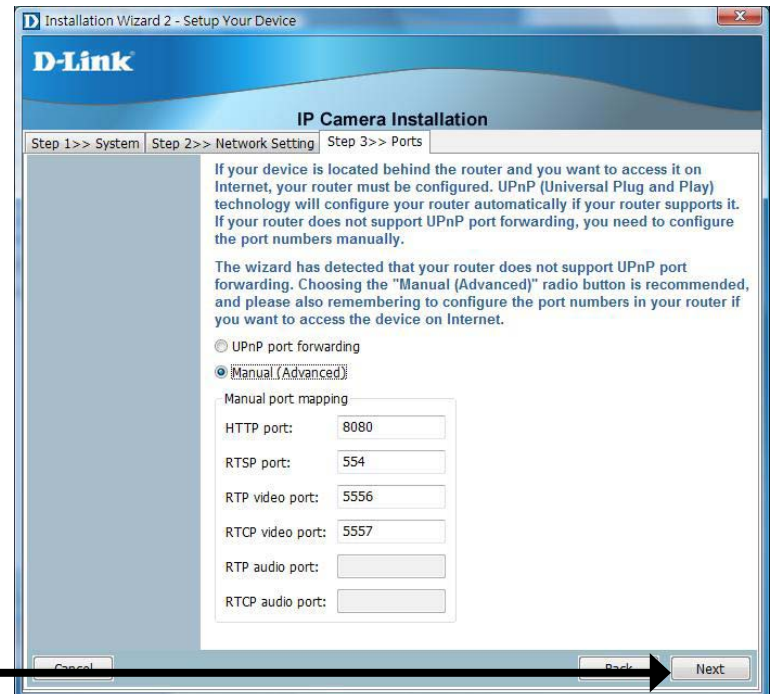

Click **Next**

Click **Next** to continue.

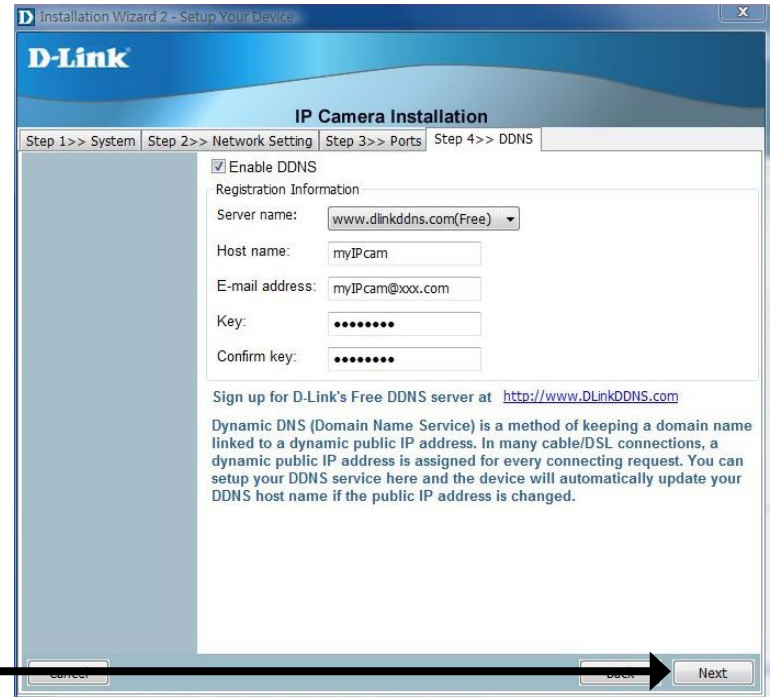

Click **Next**

A window will pop up asking you if you want to access the DCS-6110 via mobile phone. Clicking **Yes** will set the video resolution to 176x144.



Click **Apply** to apply the settings listed in the window to the device. Application may take a few minutes to process.

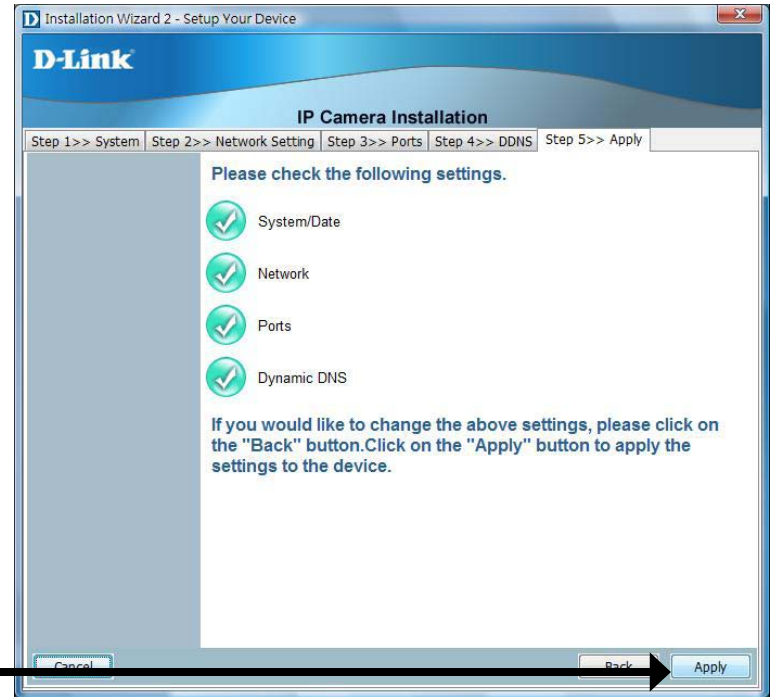

Click **Apply**

A window will pop up to confirm application was successful. Click **OK** to continue.

A new window will pop up displaying the lists to access your device, click **Add to my favorite** to save the address then click **Exit** to complete installation.

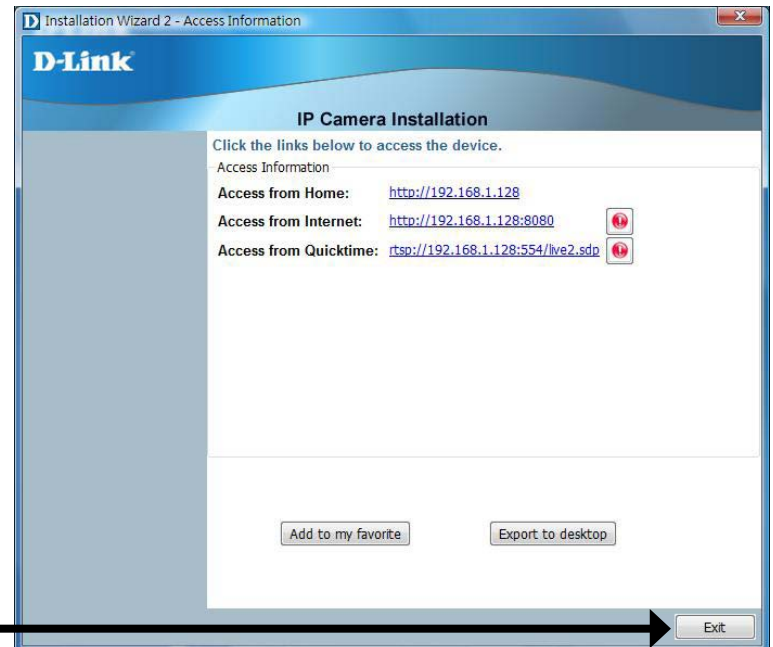

Click **Exit**

Double-click **DCS-6110** in the Installation Wizard window to launch the camera's web configuration.

Note: Please see the user manual for more information.

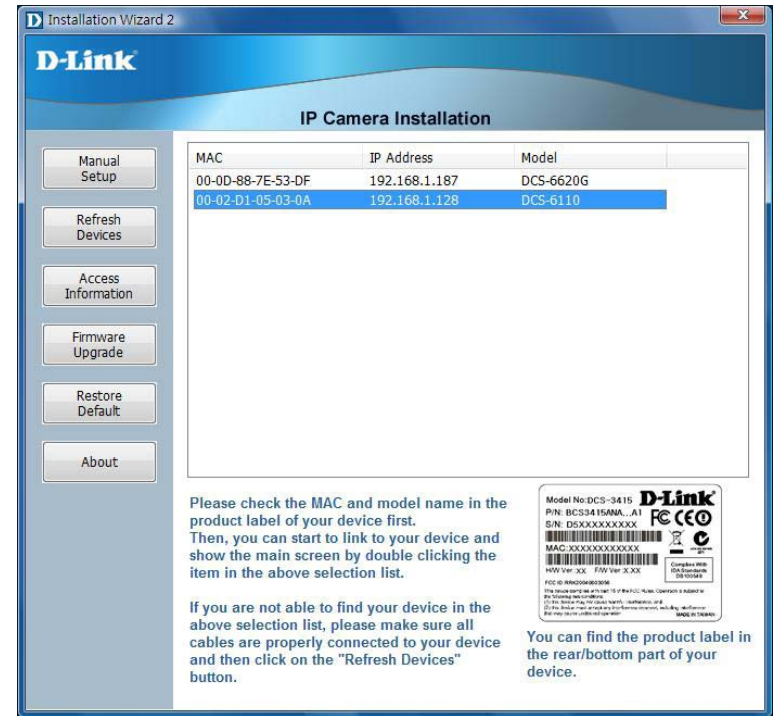

Enter **admin** as the default username and leave the password blank. Click **OK** to continue.



This section shows your camera's live video. You can control your settings using the buttons below. For more information on using the web configuration, please refer to the user manual.

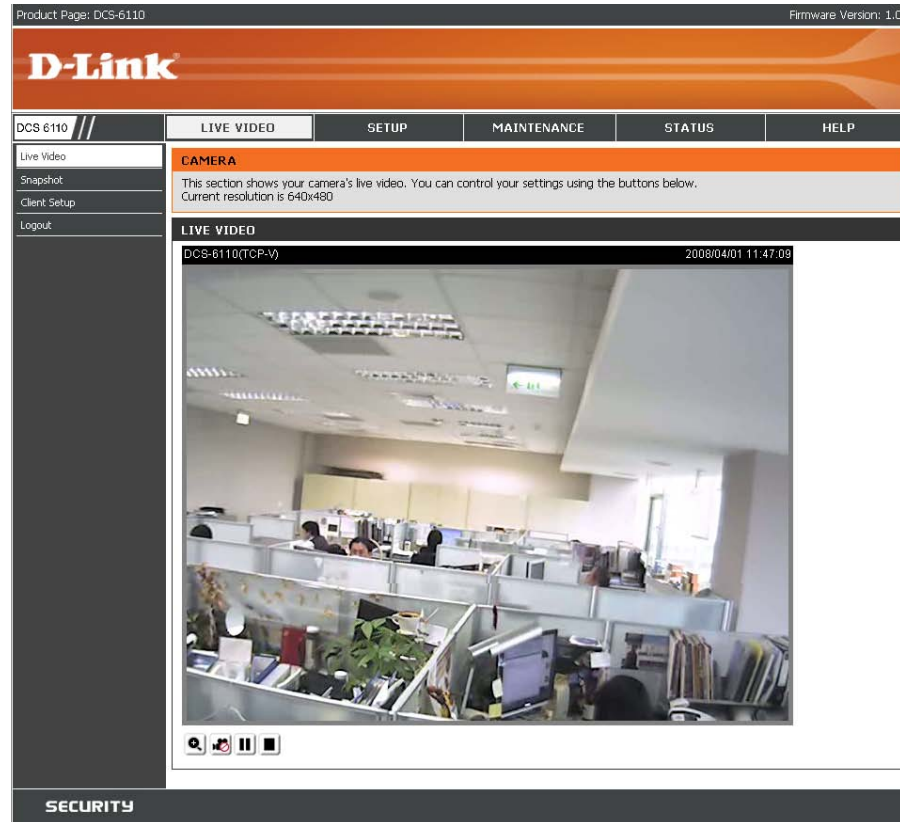

Adjusting the Lens

Based on the live image retrieved from the camera, adjust the camera lens by performing the following procedures:

Adjusting the Viewing Angle

Loosen the pan screw and turn the lens module left and right until the desired position is achieved; tighten the pan screw when completed.

Loosen the tilt screws on both sides of the camera, and turn the lens module up and down until the desired position is achieved; tighten the tilt screws once completed.

Loosen the image adjustment screw and turn the lens to adjust the network camera's image until the desired orientation is achieved, tighten the image adjustment screw once completed.

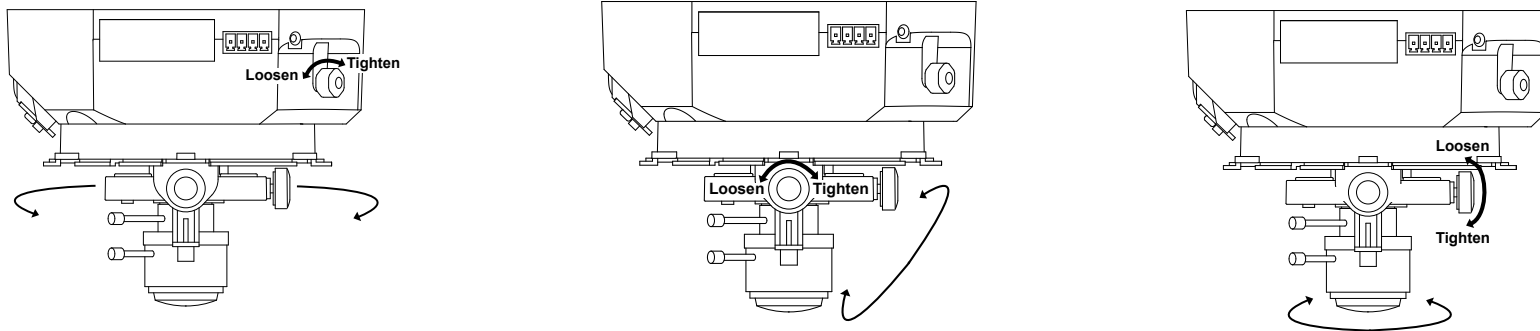

Adjusting Zoom and Focus

Loosen the zoom controller and adjust the zoom factor by moving the controller left and right until the desired range is achieved; tighten the zoom controller once completed.

Loosen the focus controller and adjust the focus range by moving the controller left and right until the image is clear; tighten the focus controller once completed.

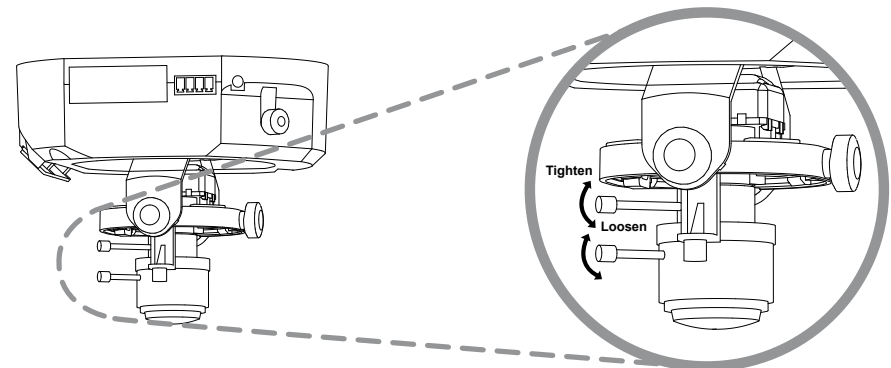

Attaching the Enclosure

Once the lens is properly adjusted, rearrange the light shield so that it will not obstruct the lens during surveillance.

Place the dome enclosure over the network camera so that the LED sticker on the dome enclosure is properly aligned with the camera's LED. Insert the supplied screws into the two holes located at the base of the dome enclosure, tighten until secure.

Place the ring enclosure over the dome enclosure. Once placed, gently turn the ring enclosure clockwise until it locks and is securely attached to the dome enclosure.

Note: When attaching the ring enclosure, be sure to first align the line on the ring enclosure with the triangle on the dome enclosure. When attachment is successful, the line on the ring enclosure will be aligned with the line on the dome enclosure.

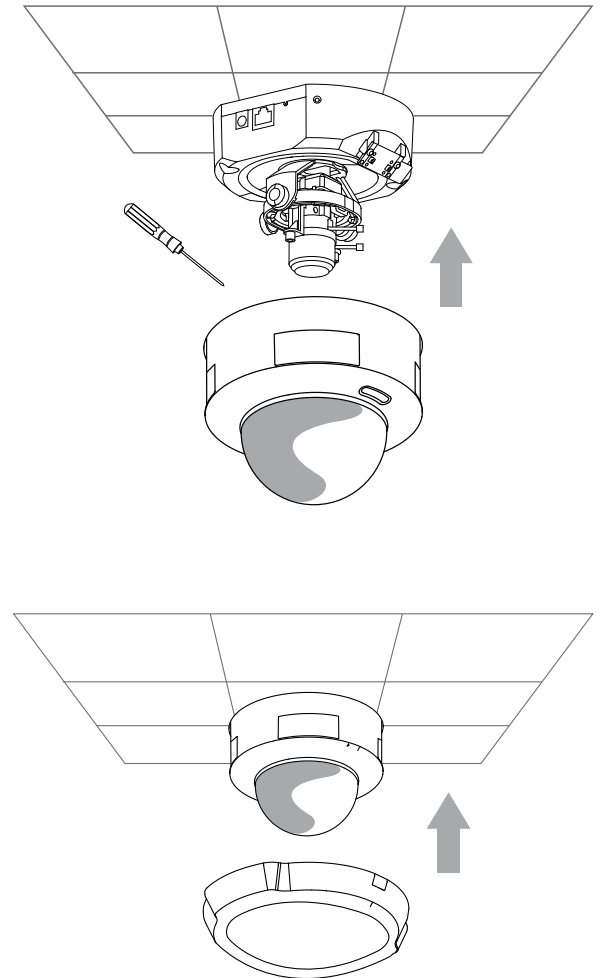

Web-based Configuration Utility

This section will show you how to configure your new D-Link Network Camera using the Web-based Configuration Utility.

To access the configuration utility, open a web-browser such as Internet Explorer and enter the IP address of your Network Camera (<http://192.168.0.120>)

Note: In the example, this address is 192.168.0.120. Your address may differ.

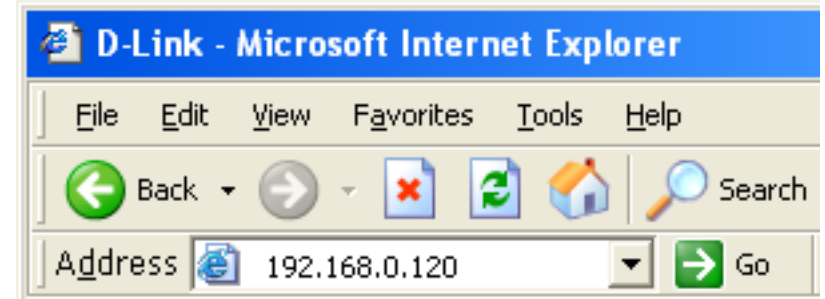

Type **Admin** in the user name field and leave the password blank by default.

Note: You may refer to page 51 to change the password for your admin account.



Click **OK**

Live Video Camera

This section shows your camera's live video. You can control your settings using the buttons below.

Zoom: “-” zooms out, and “+” zooms in

MP4 Recording: Starts and stops MP4 recording

Pause: To pause live video

Stop: Stops streaming

The screenshot displays the D-Link DCS-6110 web interface. At the top, it shows 'Product Page: DCS-6110' and 'Firmware Version: 1.00'. The D-Link logo is prominently displayed. Below the logo is a navigation menu with tabs for 'DCS 6110 //', 'LIVE VIDEO', 'SETUP', 'MAINTENANCE', 'STATUS', and 'HELP'. The 'LIVE VIDEO' tab is selected. On the left side, there is a sidebar menu with options: 'Live Video', 'Snapshot', 'Client Setup', and 'Logout'. The main content area is titled 'CAMERA' and contains the text: 'This section shows your camera's live video. You can control your settings using the buttons below. Current resolution is 640x480'. Below this is a 'LIVE VIDEO' section featuring a video feed from 'DCS-6110(TCP-V)' with a timestamp of '2008/04/01 11:47:09'. The video shows an office interior with cubicles and people working. At the bottom of the video feed, there are control icons for zoom, pan, and other functions. The word 'SECURITY' is visible at the bottom of the interface.

Snapshot

This section shows a snapshot image from your camera's live video.

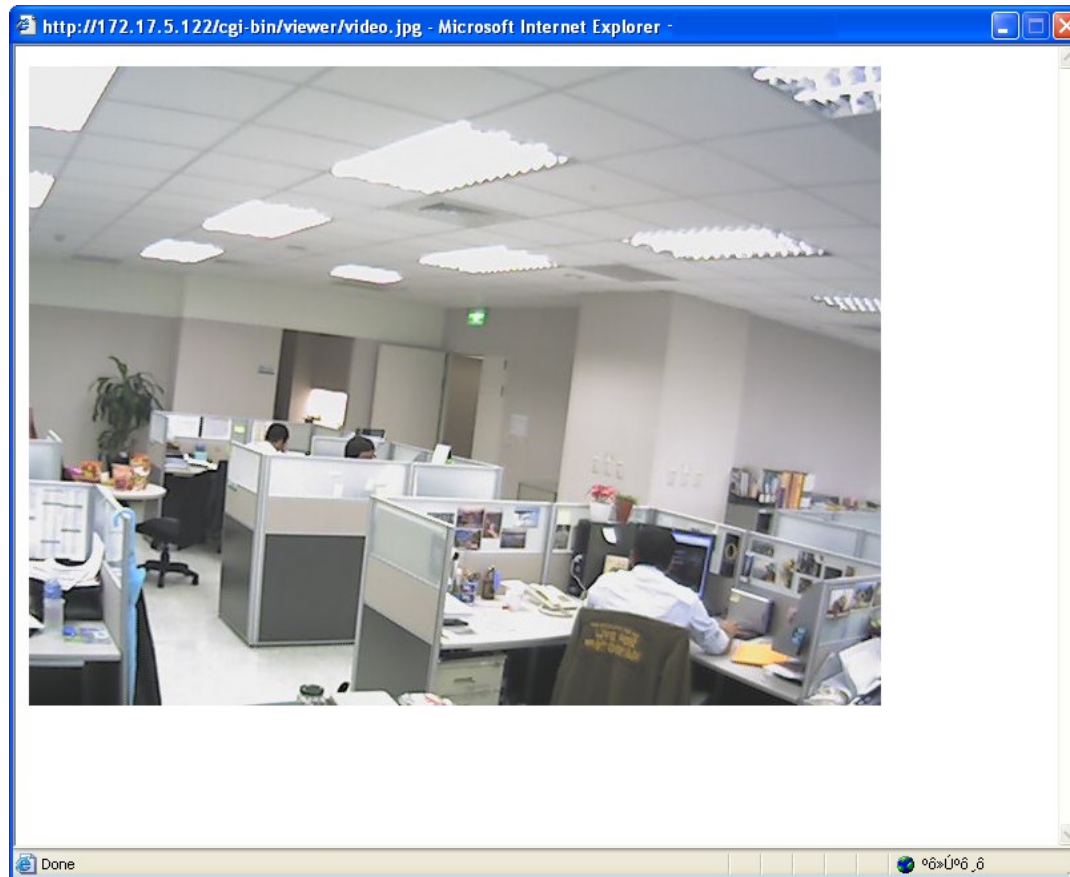

Client Setup

You may configure and select the setting for your media streaming and recording

Stream Options: You can select which video stream profile to use.

Protocol Options: There are 4 protocols for you to choose for the video streaming.

UDP Protocol: This is recommended because it is an ideal protocol for transmitting real-time audio and video data, which can tolerate some lost packets.

UDP Unicast: Will stream to a single computer.

UDP Multicast Will stream to multiple computers using multicast.

TCP: Provides higher quality video streaming than UDP does. It provides error correction and guarantees packet to be delivered to client. However, transmission speed will be reduced.

HTTP Protocol: Offers the highest image and video quality. However, packet losses will diminish image quality when bandwidth becomes restricted. If the network is protected by a firewall and it opens HTTP port (80) only, HTTP protocol must be selected. this mode, audio is disabled and only video can be viewed. UDP connections will not be available to remote users if all four ports have not been forwarded (as shown on page 32). Only the HTTP port must be forwarded for remote users to make an HTTP connection (video only).

Record Options: Allows the user to specify a destination folder and prefix filename for the recorded video.

Product Page: DCS-6110 Firmware Version: 1.00

D-Link

DCS 6110 // LIVE VIDEO SETUP MAINTENANCE STATUS HELP

Live Video
Snapshot
Client Setup
Logout

CONNECTION TYPE
Here you can configure the audio and video settings as well as the type of connection your camera uses when viewing it on a network.
Save Settings Don't Save Settings

STREAM OPTIONS
 Stream1
 Stream2

PROTOCOL OPTIONS
 UDP unicast
 UDP multicast
 TCP
 HTTP

RECORD OPTIONS
Folder: c:\Record Browse...
File Name Prefix: CLIP
 Add date and time suffix to file name
Save Settings Don't Save Settings

Helpful Hints..

Stream Options - This camera can send 2 streams simultaneously, it can have different configuration for each stream, you can find stream setup at the Setup/Video and Audio setup page.

Media Options -
• Video and Audio: Stream Video and Audio data at the same time with synchronization.
• Video only: Stream video data only.
• Audio only: Stream Audio data only.

Protocol Options -
• UDP Protocol: This allows quality real-time performance for audio and video. Some packets may be lost due to network burst traffic and images may be obscured.
• TCP Protocol: Packet loss is less likely to occur and video displays are more accurate.

Record Option -
• Folder: Select target record folder. Default folder is C:\Record, if this folder doesn't exist, system will create it when first recording. If this folder is invalid, it will cause recording fail. It can assign a network folder.
• File name prefix: Add every recorded file with this file name prefix.
• Add date and time suffix to file name: If checked every file name will distinguished by recording date and time. If no date and time suffix assign, system will use serial number for file name.

Setup Wizard

To quickly configure your network camera, click **Internet Connection Setup Wizard** or click **Manual Internet Connection Setup** to manually configure your network camera.

To quickly configure your network camera's motion detection settings, click **Motion Detection Setup Wizard** and skip to page 29. If you want to enter your settings without running the wizard, click **Manual Motion Detection Setup** and skip to page 39.



Internet Connection Setup Wizard

This wizard will guide you through a step-by-step process to configure your new D-Link Camera and connect the camera to the internet. Click **Next** to continue.

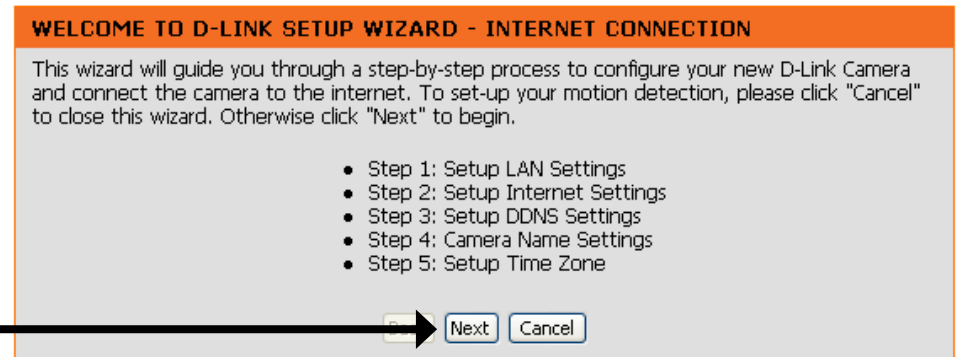

Click **Next**

Select **DHCP** if you are unsure which settings to pick. Click **Next** to continue and skip to page 27.

STEP 1: SETUP LAN SETTINGS

Please select whether your camera will connect to the Internet with a DHCP connection or Static IP address. If your camera is connected to a router, or you are unsure which settings to pick, D-Link recommends that you keep the default selection of DHCP connection. Otherwise, click on Static IP address to manually assign and IP address before clicking on the Next button.

DHCP
 PPPoE
 Static IP Client

IP address: 192.168.0.100
Subnet mask: 255.255.255.0
Default Gateway: 192.168.0.1
Primary DNS: 192.168.0.1
Secondary DNS:

Back Next Cancel

Click **Next**



Select **PPPoE** if the camera is directly connected to the Internet through a DSL modem, and the ISP (Internet Service Provider) requires you to use PPPoE for the Internet connection. Click **Next** to continue and skip to Step 2 on page 26.

STEP 1: SETUP LAN SETTINGS

Please select whether your camera will connect to the Internet with a DHCP connection or Static IP address. If your camera is connected to a router, or you are unsure which settings to pick, D-Link recommends that you keep the default selection of DHCP connection. Otherwise, click on Static IP address to manually assign and IP address before clicking on the Next button.

DHCP
 PPPoE
 Static IP Client

IP address: 192.168.0.100
Subnet mask: 255.255.255.0
Default Gateway: 192.168.0.1
Primary DNS: 192.168.0.1
Secondary DNS:

Back Next Cancel

Click **Next**



Select **Static IP** if your Internet Service Provider has provided you with connection settings, or you wish to set a static address within your home network. Click **Next** to continue.

STEP 1: SETUP LAN SETTINGS

Please select whether your camera will connect to the Internet with a DHCP connection or Static IP address. If your camera is connected to a router, or you are unsure which settings to pick, D-Link recommends that you keep the default selection of DHCP connection. Otherwise, click on Static IP address to manually assign an IP address before clicking on the Next button.

DHCP
 PPPoE
 Static IP Client

IP address	<input type="text" value="192.168.0.100"/>
Subnet mask	<input type="text" value="255.255.255.0"/>
Default Gateway	<input type="text" value="192.168.0.1"/>
Primary DNS	<input type="text" value="192.168.0.1"/>
Secondary DNS	<input type="text"/>

Click **Next**



If you have selected PPPoE, enter your username and password. Click **Next** to continue.

STEP 2: SETUP INTERNET SETTINGS

Please enter your ISP Username and Password. This will be the case if your ISP uses PPPoE. Contact your ISP if you are unsure.

User name	<input type="text"/>
Password	<input type="text"/>
Confirm password	<input type="text"/>

Click **Next**



If you have a Dynamic DNS account and would like the camera to update your IP address automatically, enable DDNS and enter your host information. Click **Next** to continue.

STEP 3: SETUP DDNS SETTINGS

If you have a Dynamic DNS account and would like the camera to update your IP address automatically, enable DDNS and enter in your host information below. Please click on the Next button to continue.

Enable DDNS

Server name

Host name

User name

Password

Confirm password

Click **Next**



Enter a name for your camera and click **Next** to continue.

STEP 4: SERVER NAME SETTINGS

D-Link recommends that you rename your camera for easy accessibility. You can then identify and connect your camera via this name. Please click on Next button.

Camera Name

Click **Next**



Configure the correct time to ensure that all events will be triggered, captured and scheduled at the right time. Click **Next** to continue.

STEP 5: SETUP TIME ZONE

Please configure the correct time to ensure that all events triggered, captured and scheduled at the correct time and day and then click on the Next button.

Current Time 07 Jan 2008 01:35:53

Time Zone

Enable Daylight Saving

Daylight Saving Dates

	Month	Week	Day of Week	Time
DST Start	<input type="text" value="Oct"/>	<input type="text" value="2nd"/>	<input type="text" value="Sun"/>	<input type="text" value="1 am"/>
DST End	<input type="text" value="Mar"/>	<input type="text" value="1st"/>	<input type="text" value="Sat"/>	<input type="text" value="1 am"/>

Click **Next**



If you have selected **DHCP**, you will see a summary of your camera's settings. Please note down all this information as you will need it for accessing your camera within the network. Click **Apply** to save your settings.

STEP 6: SETUP COMPLETE

Below you should see a summary of your camera settings. Click back to review or modify settings. Click Restart to apply the settings below. Please note these settings as you will require this information when accessing your camera on the network or via your web browser.

IP address:	DHCP
Camera Name:	DC55610
Time Zone:	-8
DDNS:	OFF
PPPoE:	OFF

Click **Apply**

If you have selected **PPPoE**, you will see a summary of your camera's settings. Please note down all this information as you will need it for accessing your camera within the network. Click **Apply** to save your settings.

STEP 6: SETUP COMPLETE

Below you should see a summary of your camera settings. Click back to review or modify settings. Click Restart to apply the settings below. Please note these settings as you will require this information when accessing your camera on the network or via your web browser.

IP address:	PPPoE
Camera Name:	DC55610
Time Zone:	-8
DDNS:	OFF
PPPoE:	ON

Click **Apply**

If you selected **Static IP**, you will see a summary of your camera's settings. Please note down all this information as you will need it for accessing your camera within the network. Click **Apply** to save your settings.

STEP 6: SETUP COMPLETE

Below you should see a summary of your camera settings. Click back to review or modify settings. Click Restart to apply the settings below. Please note these settings as you will require this information when accessing your camera on the network or via your web browser.

IP address:	192.168.0.100
Camera Name:	DC55610
Time Zone:	-8
DDNS:	OFF
PPPoE:	OFF

Click **Apply**

Motion Detection Setup Wizard

This wizard will guide you through a step-by-step process to configure your new D-Link Camera motion detection functions. Click **Next** to continue.

WELCOME TO D-LINK SETUP WIZARD - MOTION DETECTION

This wizard will guide you through a step-by-step process to configure your camera's motion detection functions. To setup the internet connection settings, please click "Cancel" to close this wizard. Otherwise click "Next" to begin.

- Step 1: Specify motion detection Area Settings
- Step 2: Motion Detection Schedule
- Step 3: Alerts and Notifications

Click **Next**

Next Cancel

This section will allow you to enable or disable motion detection as well as control the sensitivity or your camera's ability to detect movement. Specify the window area, window name and sensitivity of detection as well as the type of recording (either snapshot or video clip). Then, click **Next** to continue.

STEP 1: SPECIFY MOTION DETECTION AREA SETTINGS

This section will allow you to enable or disable motion detection as well as control the sensitivity of your camera's ability to detect movement. Please specify the window area, window name and sensitivity of detection before clicking on the Next button.

Enable motion detection Snapshot Video Clip

DCS5610(TCP-AV) 2008/01/07 01:57:28



Window Name:

Sensitivity:

 0%

Percentage:

 0%

New

Save

Back Next Cancel

Click **Next**

This section will allow you to specify the time and date your camera records motion.

Note: Recording camera footage will take up space on your hard drive. It is recommended that you have sufficient disk space for **Always** function.

Click **Next**

STEP 2: MOTION DETECTION SCHEDULE

This section allows you to specify the time and dates that your camera records motion. Please note that recorded camera footage will take up space on your hard drive. It is therefore recommended that you have sufficient disk space for 'Always' function.

Sun Mon Tue Wed Thu Fri Sat

Time Always

From 00 to 24 to 00

Back Next Cancel

This step allows you to specify how you will receive the events notification of your camera, either via using email or FTP. You will need to enter all the relevant information for your email account or FTP settings. Then, click **Next** to continue.

Click **Next**

STEP 3: ALERTS AND NOTIFICATION

This final step allows you to specify how you receive notification of camera events. Choose between an email notification or alternatively you can setup an FTP Notification. You will need your email account settings or FTP details. If you are unsure of this information, please contact your ISP. Once you have entered this information, please click on the Next button.

Do not notify me

Notify me by E-mail

User name

Password

SMTP(mail) Server

Return E-mail Address

Recipient email address

Notify me by FTP

User name

Password

Server address

Remote folder name

Server port

Passive mode

Back Next Cancel

You have completed the Motion Detection Wizard. Click **Apply** to save your settings.

STEP 4: SETUP COMPLETE

You have completed your camera setup. Please click the Back button if you want to review or modify your settings or click on the Apply button to save and apply your settings.

Motion Detection:	Disable
Event:	Take Snapshot
Schedule Day:	Sun, Mon, Tue, Wed, Thu, Fri, Sat
Schedule Time:	Always
Alerts and Notification:	Do not notify me

Click **Apply**



Network Setup

LAN Settings: Settings for your local area network.

DHCP: Select this connection if you have a DHCP server running on your network and would like a dynamic IP address to be updated to your camera automatically.

Static IP Client: You may obtain a static or fixed IP address and other network information from your network administrator for your camera. A static IP address will ease you for accessing your camera in the future.

IP Address: The fixed IP address.

Subnet Mask: The default value is “255.255.255.0.” Used to determine if the destination is in the same subnet.

Default Gateway: The gateway used to forward frames to destinations in a different subnet. Invalid gateway settings may cause the failure of transmissions to a different subnet.

Primary DNS: Primary domain name server that translates names to IP addresses.

Secondary DNS: Secondary domain name server to backup the primary one.

Enable UPnP Presentation: Allows a user to find, view and control this camera via a presentation page or “Network Neighborhood” without configuration.

How does UPnP work?

UPnP™ networking technology provides automatic IP configuration and dynamic discovery of devices added to a network. Services and capabilities offered by networked devices, such as printing and file sharing, are available among each other without bothersome network configuration. In the case of Network Cameras, you will see Network Camera shortcuts at My Network Places.

Product Page: DCS-6110 **Firmware Version:** 1.00

D-Link

DCS-6110 // **LIVE VIDEO** **SETUP** MAINTENANCE STATUS HELP

NETWORK SETUP
You can configure your LAN and internet settings from here.

LAN SETTINGS

DHCP
 Static IP Client

IP address: 172.17.0.79
Subnet mask: 255.255.255.0
Default router: 172.17.0.254
Primary DNS: 192.168.168.210
Secondary DNS: 192.168.168.250

Enable UPnP presentation
 Enable UPnP port forwarding
Error: Router does not support UPnP port forwarding.

PPPoE SETTINGS

Enable Disable

User name: default
Password: *****
Confirm password: *****
Connect Status: none

HTTP

Authentication: basic
HTTP port: 80
Secondary HTTP port: 8080
Access name for stream1: video.mjpg
Access name for stream2: video2.mjpg

FTP

FTP port: 21

RTSP STREAMING

Authentication: Disable
Access name for stream1: live.sdp
Access name for stream2: live2.sdp
RTSP port: 554
RTSP port for video: 5556
RTP port for video: 5557

Enable multicast for stream 1
Multicast group address: 239.128.1.99
Multicast video port: 5560
Multicast RTP video port: 5561
Multicast TTL[1-255]: 15

Enable multicast for stream 2
Multicast group address: 239.128.1.100
Multicast video port: 5564
Multicast RTP video port: 5565
Multicast TTL[1-255]: 15

Helpful Hints...

Select "DHCP Connection" if you are running a DHCP server on your network and would like an IP address assigned by your IP camera.

Port Detail Settings allow you to specify the ports that you reserve for HTTP and RTSP Streaming.

HTTP Port is the port you allocate in order to connect to the IP camera via a standard web browser.

RTSP Port is the port you allocate in order to connect to streaming mobile devices such as mobile phone or PDA.

RTSP streaming: "Authentication" if enable authentication, you will need below "access name" for RTSP connection. For example, if authentication is enable, you can connect like: RTSP://camera ip/: if authentication is enable, you need connect camera RTSP stream like: RTSP://camera ip/live.sdp. live.sdp is default access name, you can rename at below options.

Multicast group address: An IP Multicast group address is used by sources (the camera) and the receivers(the client connection) to send and receive content. Sources use the group address in the IP destination address in their data packets. Receivers use the group address to inform the network that they are interested in receiving packets sent to that group. For example, if some content is associated with group 229.1.1.1, the source will send data packets destined to 229.1.1.1. Receivers for that content will inform the network that they are interested in receiving data packets sent to the group 229.1.1.1. The receiver "port" 229.1.1.1. The Multicast address ranges from 224.0.0.0 to 239.255.255.255, equivalently, 224.0.0.0/4.

"Multicast video port" Set a port for multicast video, please choose between 1024 and 65534.

"Multicast RTP video port" Set a port for multicast video, please choose between 1024 and 65534.

"Multicast audio port" Set a port for multicast audio, please choose between 1024 and 65534.

"Multicast RTP audio port" Set a port for multicast audio, please choose between 1024 and 65534.

"Multicast TTL" Set a Time to live(TTL) value for multicast packet, please choose between 1 and 255.

SECURITY

Enabling UPnP port forwarding allows the Network Camera to open secondary HTTP port on the router, not HTTP port, meaning that you have to add the secondary HTTP port number behind the Network Camera's public address in order to access the Network Camera from the Internet. For example, when the HTTP port is set to 80 and the secondary HTTP port is set to 8080, refer to the list below for the Network Camera's IP address.

From the Internet	In a local area network
http://203.67.124.123:8080	http://192.168.4.160 or http://192.168.4.160:8080

If the PPPoE settings are incorrectly configured or the Internet access is not working, restore the Network Camera to factory default. After the Network Camera is reset to factory default, it is accessible in a local area network.

Enable UPnP Port

Forwarding: Enables the camera to add the port forwarding entry into the router automatically when this option is enabled.

PPPoE Settings: Enable this setting if your ISP (DSL service) is using PPPoE. You may already have both **Username** and **Password** given by your ISP, or you may check with your ISP. The **Connect Status** will be determined automatically by the system.

HTTP: You may configure two HTTP ports for your camera. HTTP ports allow you to connect to the camera via a standard web browser. These ports can be set to a number other than the default TCP ports 80 and 8080. A corresponding port must be opened on the router. For example, if the port is changed to 1010, users must type in the web browser "http://192.168.0.100:1010" instead of "http://192.168.0.100".

Authentication: Choose either **Basic** where the password is not encrypted, or **Digest** where the password is encrypted during the transmission to the web server.

Basic authentication: When selected, the password is sent in plain text format; there can be potential risks of being intercepted.

Digest authentication: When selected, user credentials are encrypted in MD5 algorithm and thus provide better protection against unauthorized accesses.

HTTP Port: The default value is 80.

Secondary HTTP The default value is 8080.

Port: After you have enabled the **Authentication**, you will need to configure and use the access name to access your video file. For example, **http://camera ip/video.mjpg** (video.mjpg is the **Access name**, you can modify it here)

Access name for stream1: The default name is video.mjpg.

Access name for stream2: The default name is video2.mjpg.

Access name for stream 1 / Access name for stream 2 : The access name is used to differentiate the streaming source. When using Mozilla Firefox or Netscape to access the Network Camera, and the video mode is set to JPEG, users will receive continuous JPEG pictures. This technology, known as "server push", allows the Network Camera to feed live pictures to Mozilla Firefox and Netscape. Use `http://<ip address>:<http port>/<access name for stream1 or stream2>` to make connection.

For example, when the access name for stream 1 is set to video.mjpg:

- 1 : Launch Mozilla Firefox or Netscape.
- 2 : Type the URL command in the address field. Press Enter.
- 3 : The JPEG images will be displayed in your web browser.

FTP Port: Default port is 21. If you want to change the port number, you will need to specify the port when connecting to the FTP server. For example `FTP://68.5.1.81:60` (if you use port 60 for your FTP server)

RTSP Streaming: This setting enables you to connect to a camera by using streaming mobile device(s), such as a mobile phone or PDA.

Authentication: Choose either **Basic** where the password is not encrypted, or **Digest** where the password is encrypted during the transmission to the web server. After you have enabled the **Authentication**, you will need to configure and use the access name to access your video file. **RTSP://camera ip/live.sdp** (live.sdp is the default access name, you can modify it here)

Access name for stream1: The default name is live.sdp.

Access name for stream2: The default name is live2.sdp.

The accessibility of the RTSP streaming for the three authentication modes are listed in the following table.

	Quick Time player	Real Player	VLC media player	mpegable Player	pvPlayer
Disable	0	0	0	0	0
Basic	0	0	X	X	X
Digest	0	X	X	X	X

0 indicates that the authentication mode is supported by the RTSP player.

X indicates that the authentication mode is NOT supported by the RTSP player.

Access name for stream 1 / Access name for stream 2 : The access name is used to differentiate the streaming source. When using a RTSP player to access the Network Camera, and the video mode is set to MPEG-4, use the following RTSP URL command to request a transmission of streaming data.

rtsp://<ip address>:<rtsp port>/<access name for stream1 or stream2>

For example, when the access name for stream 1 is set to live.sdp:

- 1 : Launch a RTSP player.
- 2 : Choose File > Open URL. This opens the URL dialog box.
- 3 : Type the URL command in the text box.

For example:

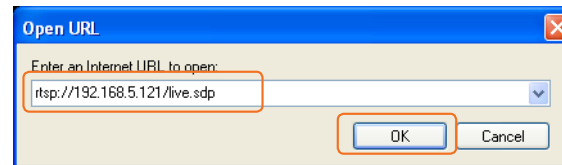

- 4 : The live video will be displayed in your player.



RTSP port: The port number that you use for RSTP streaming, the default port number is 554. **RTP** (Real Time Protocol) **Port** is used to streaming audio and video while **RTCP** (Real Time Control Protocol) port is used to monitor QoS of RTP stream.

Note: *RTP video port and RTP audio port must be an “even” number. The numbers of RTCP video port and RTCP audio port must equal to the numbers of RTP video port and RTP audio port, plus one repetitively*

RTP port for video: Default port number is 5556.

RTCP port for video: Default port number is 5557.

You may choose to enable multicast for your camera audio and video streaming so that your **cameras (sources)** and the **receivers (clients)** can establish the connection to send and receive contents.

Multicast group address: An IP Multicast group address is used to send and receive content. Sources use this group address as the destination address while sending their data packets. Receivers use this group address to inform the network that they are interested in receiving packets sent to that group.

For example, if some content is associated with group 239.1.1.1, the source will send data packets destined to 239.1.1.1. Receivers for that content will inform the network that they are interested in receiving data packets sent to the group 239.1.1.1. The receiver “joins” 239.1.1.1. The Multicast address ranges from 224.0.0.0 to 239.255.255.255, or, equivalently, 224.0.0.0/4

Multicast video port: Default port number is 5560, or please choose between 1024 and 65534.

Multicast RTCP

video port: Default port number is 5561, or please choose between 1024 and 65534.

Multicast RTCP

audio port: Default port number is 5563, or please choose between 1024 and 65534.

Multicast TTL

{1~255}: Set a Time to Live(TTL) value for multicast packet, please choose between 1 and 255.

Unicast video transmission delivers a stream through point-to-point transmission; multicast, on the other hand, sends a stream to the multicast group address and allows multiple clients to acquire the stream by requesting a copy from the Multicast group address.

The five ports can be changed between 1025 and 65535. The multicast RTP port must be an even number and the multicast RTCP port is multicast RTP port number plus one, and thus always be odd. When the multicast RTP port changes, the multicast RTCP port will change accordingly.

Dynamic DNS

DDNS (Dynamic Domain Name Server) will hold a DNS host name and synchronize the public IP address of the modem when it has been modified. The username and password are required when using the DDNS service.

Enable DDNS: Click to enable the DDNS function.

Server Name: Select your Dynamic DNS provider from the pull down menu.

Host Name: Enter the host name of the DDNS server.

Username: Enter your username or e-mail used to connect to the DDNS

Password: Enter your password used to connect to the DDNS server.

Status: Indicate the connection status, automatically determined by the system.

The screenshot shows the D-Link DCS-6110 web interface. At the top, it displays 'Product Page: DCS-6110' and 'Firmware Version: 1.00'. The D-Link logo is prominent. Below the logo is a navigation bar with tabs for 'LIVE VIDEO', 'SETUP', 'MAINTENANCE', 'STATUS', and 'HELP'. The 'SETUP' tab is selected. On the left, a sidebar menu lists various setup options: Wizard, Network Setup, Dynamic DNS (selected), Image Setup, Video, Motion Detection, Time and Date, Event Setup, Access List, DI and DO, and Logout. The main content area is titled 'DDNS' and contains the following text: 'The Dynamic DNS feature allows you to host a server (Web, FTP, Game Server, etc...) using a domain name that you have purchased (http://www.whateveryournameis.com) with your dynamically assigned IP address. Most broadband Internet Service Providers assign dynamic (changing) IP addresses. Using a DDNS service provider, your friends can enter your host name to connect to your game server no matter what your IP address is.' Below this text is a link to 'Sign up for D-Link's Free DDNS service at: www.DLinkDDNS.com' and two buttons: 'Save Settings' and 'Don't Save Settings'. The 'DDNS SETTING' section includes a checked 'Enable DDNS' checkbox, a 'Server name' dropdown menu set to 'www.dlinkddns.com(Free)', a 'Host name' text field with 'default', a 'User name' text field, a 'Password' text field with masked characters, a 'Confirm password' text field with masked characters, and a 'Status' dropdown menu set to 'Disconnect'. At the bottom of this section are 'Save Settings' and 'Don't Save Settings' buttons. On the right side of the interface, there is a 'Helpful Hints...' section with text explaining the utility of Dynamic DNS for DSL or Cable service providers.

Image Setup

You may configure the color, brightness, and orientation settings of the video image. Preview of the image will be shown in the window of Live Video. Click **Save Settings** to save your changes.

Color: Select either for **Color** or **B/W (black and white, monochrome)** video display.

Power line frequency: You may need to choose 50 or 60 Hz frequency; and nonetheless maintain the system operation at a basic 50 Hz frequency.

Video orientation: Two options. **Flip** will vertically rotate the video while **Mirror** will horizontally rotate the video. You may check both options if the camera is being installed upside down.

White balance: Choose either Auto or Fix white balance.

Brightness: It has eleven levels ranged from -5 to +5 for you to choose.

Overlay title and time stamp on video: Select to add a date and time stamp directly on the video.

The screenshot displays the D-Link DCS-6110 web interface. At the top, it shows 'Product Page: DCS-6110' and 'Firmware Version: 1.00'. The main header is 'D-Link'. Below this is a navigation bar with tabs for 'LIVE VIDEO', 'SETUP', 'MAINTENANCE', 'STATUS', and 'HELP'. The 'SETUP' tab is active, and the 'IMAGE SETUP' sub-tab is selected. A note states: 'Note: If parameters are changed without saving, they will be effective until the next system power up.' Below the note are 'Save Settings' and 'Don't Save Settings' buttons. The 'LIVE VIDEO' section shows a video preview window with the title 'DCS-6110(TCP-V)' and a timestamp '2008/04/07 14:11:34'. The 'IMAGE SETTINGS' panel includes the following options:

- Color: A dropdown menu set to 'Color'.
- Power line frequency: A dropdown menu set to '60 Hz'.
- Video orientation: Two checkboxes, 'Flip' and 'Mirror', both of which are unchecked.
- White balance: A dropdown menu set to 'Auto'.
- Brightness: A dropdown menu set to '+0'.
- Overlay title and time stamp on video: An unchecked checkbox.

 At the bottom of the settings panel are 'Save Settings' and 'Don't Save Settings' buttons. On the right side of the interface, there is a 'Helpful Hints..' section with the following text:

- Flip image:** This will flip the image vertically.
- Power line frequency:** You may need to choose 50 or 60 Hz frequency; and nonetheless maintain the system operation at a basic 50 Hz frequency.
- White balance:** Choose either Auto or Fix white balance.
- Mirror:** This will flip the image horizontally in such a way that your left side will be on the left side of the screen and vice versa.
- Color:** Select either for Color or B/W (black and white, monochrome) video display.
- Brightness:** field has eleven levels ranged from -5 to +5.
- Overlay title and time stamp on video:** Print date/time information on left top of video.

 The bottom of the page features a 'SECURITY' banner.

Video

Two different settings for two video streams (stream 1 and stream 2) can be configured here. You may configure one setting for computer display and the other one for mobile display.

Mode: It can be either JPEG or MPEG4. In JPEG mode, the video frames are independent. However, MPEG4 consumes much less network bandwidth than JPEG.

Frame Size: Frame Size: Three options exist for the sizes of the video display. You can select between **176x144**, **352x240**, or **640x480**. It is recommended using 176x144 for mobile viewing and 640x480 for computer viewing.

Maximum frame rate: 1 is the minimum value while 30 is the maximum value. It is recommended choosing 30 for computer viewing and 5 for mobile viewing.

Video quality: This limits the maximal refresh frame rate, which can be combined with the “**Fixed quality**” to optimize the bandwidth utilization and video quality. If the User wants to fix the bandwidth utilization regardless of the video quality, choose “**Constant bit rate**” and select the desired bandwidth.

The screenshot shows the D-Link DCS-6110 web interface. The top navigation bar includes 'LIVE VIDEO', 'SETUP', 'MAINTENANCE', 'STATUS', and 'HELP'. The 'SETUP' tab is active, and the 'VIDEO' section is selected in the left sidebar. The main content area is titled 'VIDEO' and contains the following settings:

- VIDEO QUALITY SETTINGS FOR STREAM1:**
 - Mode: MPEG-4
 - Frame size: 640x480
 - Maximum frame rate: 30 fps
 - Video quality:
 - Constant bit rate: 512 Kbps
 - Fixed quality: Good
- VIDEO QUALITY SETTINGS FOR STREAM2:**
 - Mode: MPEG-4
 - Frame size: 640x480
 - Maximum frame rate: 5 fps
 - Video quality:
 - Constant bit rate: 40 kbps
 - Fixed quality: Good

Buttons for 'Save Settings' and 'Don't Save Settings' are present for both stream configurations. On the right side of the interface, there is a 'Helpful Hints..' section with the following text:

Higher frame size, frame rate and bit rate gives better video quality. At the same time, it requires more network bandwidth.

For best viewing results on a mobile phone, we suggest setting the Frame Rate to 5fps and the Bit Rate to 20 kbps.

Mode: It can be either JPEG or MPEG4. In JPEG mode, the video frames are independent. However, MPEG4 consumes much less network bandwidth than JPEG.

Frame Size: Three options exist for the sizes of the video display. It is recommended using 176x144 for mobile viewing and 640x480 for computer viewing.

Video Quality: This limits the maximal refresh frame rate, which can be combined with the “Fixed quality” to optimize the bandwidth utilization and video quality. If the User wants to fix the bandwidth utilization regardless of the video quality, choose “Constant bit rate” and select the desired bandwidth.

Motion Detection

Enabling Motion Detection will allow up to three windows that can be created with different settings for monitoring. This allows your camera to serve as a security device that will record when motion is detected.

Enable motion detection: Check this option to turn on the motion detection.

Window name: Create your own name for the monitored area/ window. It will show at the top of the motion window.

Sensitivity: Set the measurable difference between two sequential images that would indicate motion.

Percentage: Set the amount of motion in the window being monitored that is required to initiate a motion detected alert. If this is set to 100%, this means that motion is detected within the whole window to trigger a snapshot.
Note: Setting a higher sensitivity and a lower percentage will make any motion more easily.

New: Click to add a new window. A maximum of three motion windows can be opened simultaneously. Use your mouse to drag the window frame to re-size or the title bar to move. Clicking on the 'x' at the upper right corner of the window will close the window.

Save: Save the related settings of that window.

The screenshot shows the D-Link DCS-6110 web interface. At the top, it displays 'Product Page: DCS-6110' and 'Firmware Version: 1.00'. The main header features the D-Link logo and a navigation bar with tabs for 'LIVE VIDEO', 'SETUP', 'MAINTENANCE', 'STATUS', and 'HELP'. The 'SETUP' tab is active, showing a sidebar menu with options like 'Wizard', 'Network Setup', 'Dynamic DNS', 'Image Setup', 'Video', 'Motion Detection', 'Time and Date', 'Event Setup', 'Access List', 'DI and DO', and 'Logout'. The 'Motion Detection' section is expanded, displaying a 'MOTION DETECTION' header with a note: 'In order to use motion detection you must first check the Enable Motion Detection checkbox. A maximum of 3 windows can be created each with their own separate Sensitivity ranges.' Below this is the 'MOTION SETTINGS' section, which includes a checkbox for 'Enable motion detection' (which is currently unchecked). To the right of the checkbox is a 'Helpful Hints..' section with text explaining 'Sensitivity' and 'Percentage'. The 'Sensitivity' section states: 'Sensitivity - Sets the sensitivity for motion detection. Red bars on the Sensitivity Bar indicate the level of sensitivity for motion detection. As motion is detected the level will rise depending on the frequency of the movement.' The 'Percentage' section states: 'Percentage - Adjusting the percentage allows you to set a requirement on how much of the motion window must be filled by movement. Example: If you set this to 50%, then the selected window must be half filled by a moving object before it triggers motion detection.' The 'MOTION SETTINGS' section also includes a video preview window showing a live feed of an office interior, with a timestamp 'DCS-6110(TCP-V) 2008/04/07 14:25:49'. Below the video are input fields for 'Window Name:', 'Sensitivity:' (with a slider set to 0%), and 'Percentage:' (with a slider set to 0%). There are also 'New' and 'Save' buttons at the bottom of the settings area.

To enable motion detection, follow the steps below:

1. Click **New** to add a new motion detection window.
2. Enter a name in the **Window Name** field.
3. Define the sensitivity to moving objects and the space ratio of all alerted pixels by moving the **Sensitivity** and **Percentage** slide bar.
4. Click **Save** to apply the changes.
5. Select **Enable motion detection** to activate motion detection.

Note: Drag and drop to resize the window and click X to close the window.

The Percentage Indicator will rise or fall depending on the image variation. When motions are detected by the Network Camera and are judged to exceed the defined threshold, a red bar rises. Meanwhile, the motion detection window will be outlined in red. Photos or videos can be captured instantly and configured to send to the remote server (Email, FTP) by utilizing this feature as a trigger source.

A green bar indicates that even though motions are detected, the event will not be triggered because the image variations are still falling under the defined threshold.

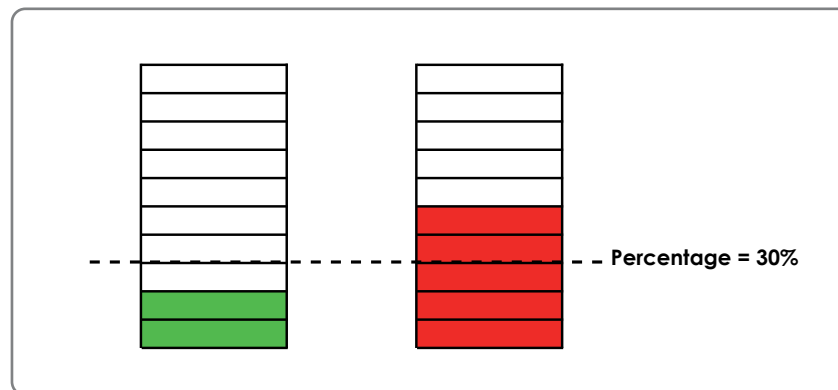

How does motion detection work?

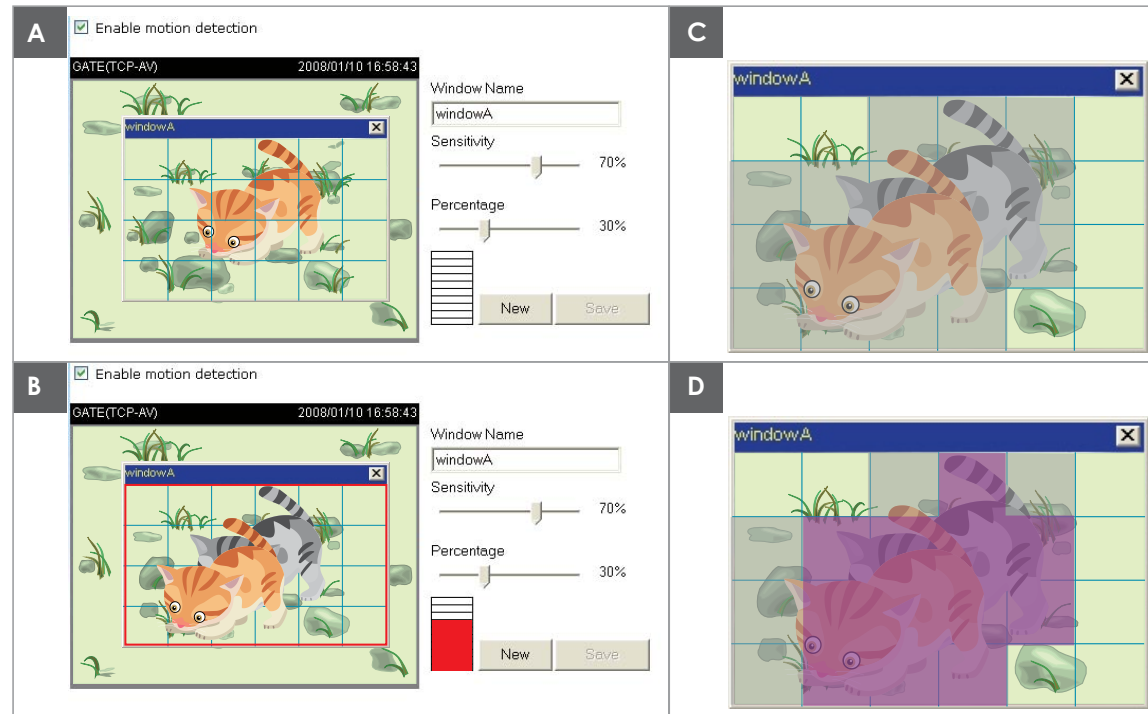

There are two parameters for setting the motion detection: Sensitivity and Percentage. In the illustration above, frame A and frame B are two sequential images. Pixel differences between the two frames are detected and highlighted in gray (frame C), and will be compared with the sensitivity setting. Sensitivity is a value that expresses the sensitivity to moving objects. Higher sensitivity settings are expected to sense a slight movement while smaller sensitivity settings tend to neglect it. When the sensitivity is set to 70%, the Network Camera defines the pixels in the purple areas as “alerted pixels” (frame D). Percentage is a value that expresses the proportion of “alerted pixels” to all pixels in the motion detection window. In this case, 50% of pixels are identified as “alerted pixels”. When the percentage is set to 30%, the motions are judged to exceed the defined threshold; therefore, the motion window will be outlined in red.

For applications that require higher security management, it is suggested to set higher sensitivity settings and smaller percentage values.

Time and Date

From this section, you may automatically or manually configure, update and maintain the internal system clock for your camera.

Current Server Time: Will be determined by the system.

Time Zone: Select your time zone from the drop-down menu.

Enable Daylight Saving: Select this to enable the daylight saving time (DST). During DST, the system clock moves one hour ahead.

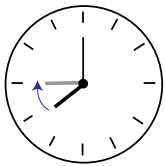

Note: To utilize this feature, ensure to set the time zone of your network camera. Then starting and ending time of the DST is displayed upon selecting the option.

Daylight Saving Dates: You may configure the daylight saving date and time.

Automatic Time Configuration: Enable this feature to obtain time configuration automatically from NTP server.

NTP Server: Network Time Protocol (NTP) synchronizes the DCS-6110 with an Internet time server. Choose the one that is closest to your location.

Update Interval: The time interval for updating the time information from NTP server.

Set the date and time manually: This option allows you to set the time and date manually.

Copy Your Computer's Time Settings: This will synchronize the time information from your PC.

Product Page: DCS-6110 Firmware Version: 1.00

D-Link

DCS 6110 // LIVE VIDEO SETUP MAINTENANCE STATUS HELP

Wizard
Network Setup
Dynamic DNS
Image Setup
Video
Motion Detection
Time and Date
Event Setup
Access List
DI and DO
Logout

TIME AND DATE

The Time Configuration option allows you to configure, update, and maintain the correct time on the internal system clock. From this section you can set the time zone that you are in and set the NTP (Network Time Protocol) Server. Daylight Saving can also be configured to automatically adjust the time when needed.

Save Settings Don't Save Settings

TIME CONFIGURATION

Current Server Time: 07 Apr 2008 17:13:18
Time Zone: GMT-08:00 Las Vegas, San Francisco, Vancouver
Enable Daylight Saving:
Daylight Saving Dates:
DST Start: Jan 1st Fri 12 am
DST End: Jan 1st Fri 12 am

AUTOMATIC TIME CONFIGURATION

Enable Disable
NTP server: << Select NTP Server >>
Update interval: One hour

SET THE DATE AND TIME MANUALLY

Year: 2008 Month: 04 Day: 07
Hour: 17 Minute: 13 Second: 51
Copy Your Computer's Time Settings

Save Settings Don't Save Settings

Helpful Hints..

Good timekeeping is important for accurate logs and scheduled firewall rules.

Time Zone: Select your time zone from the drop-down menu.

Enable Daylight Saving: Select this to enable the daylight saving time.

Daylight Saving Dates: You may configure the daylight saving date and time.

Automatic Time Configuration: Enable this feature to obtain time configuration automatically from NTP server.

NTP Server: Network Time Protocol (NTP) synchronizes the IP camera with an Internet time server. Choose the one that is closest to your location.

Update Interval: The time interval for updating the time information from NTP server.

Copy Your Computer's Time Settings: Set the date and time manually: This option allows you to set the time and date manually.

This will synchronize the time information from your PC.

Event Setup

There are three sections in **Event Setup** page.

They are:

- Event
- Server
- Media

1. To add a new item - event, server or media click **Add**. A pop-up will appear and update the fields accordingly.

2. To delete the selected item from the pull-down menu of event, server or media click **Delete**.

3. Click on the item name to pop up a window for modifying.
Note: You can add up to three events, five servers and five media fields.

Product Page: DCS-6110 Firmware Version: 1.00

D-Link

DCS 6110 // LIVE VIDEO **SETUP** MAINTENANCE STATUS HELP

Wizard
 Network Setup
 Dynamic DNS
 Image Setup
 Video
 Motion Detection
 Time and Date
Event Setup
 Access List
 DI and DO
 Logout

EVENT SETUP

There are four sections in Event Setup page. They are event, server, media and recording. Click Add to pop a window to add a new item of event, server, media or recording. Click Delete to delete the selected item from event, server, media or recording. Click on the item name to pop a window to edit it. There can be at most three events and two recording. There can be at most five server and five media configurations.

SERVER

Name	Type	Address/Location
Server1	email	
NAS	ns	\\172.17.5.169\

[Add](#) | [Server1](#) | [Delete](#)

MEDIA

Media freespace: 7200KB

Name	Type
Snapshot	snapshot

[Add](#) | [Snapshot](#) | [Delete](#)

EVENT

Name	Status	Sun	Mon	Tue	Wed	Thu	Fri	Sat	Time	Trigger
Motion Detection	ON	V	V	V	V	V	V	V	00:00~24:00	motion

[Add](#) | [Motion Detection](#) | [Delete](#)

RECORDING

Name	Status	Sun	Mon	Tue	Wed	Thu	Fri	Sat	Time	Source	Destination
Test	ON	V	V	V	V	V	V	V	00:00~24:00	stream1	NAS

[Add](#) | [Test](#) | [Delete](#)

Helpful Hints..

Suggest setting server and media first before setting event. The servers and media which selected in event list are not be able to modify or delete. Please remove them first from the event if you want to delete or modify them. Recommend using different media in different event to make use all media be produced and received correctly. If using the same media in different events and the events trigger almost simultaneously, the servers in the second triggered event will not receive any media; there would be only notifications.

Recording Add/Delete :
 You can add and delete the recording entry here.
 Please make sure you already set the "Server" entry in the "Event Setup".

SECURITY

Application

A typical application is that when a motion is detected, the DCS-6110 Network Camera sends buffered images to a FTP server or via e-mail as notifications. For example, as seen in the illustration below, an event can be triggered by many sources, such as motion detection or external digital input devices. When an event is triggered, you can specify what kind of action will be performed. You can configure the Network Camera to send snapshots or videos to your email address or FTP site.

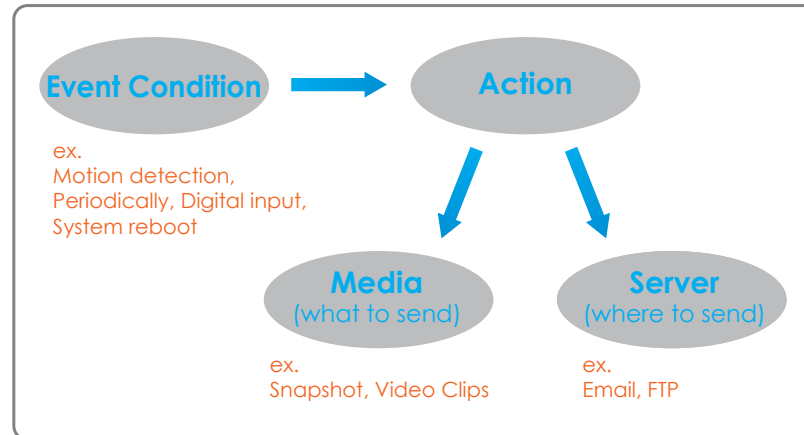

To start plotting an event, it is suggested to configure server and media columns first so that the Network Camera will know what action shall be performed when a trigger is activated.

Add Server

Up to 5 servers, where will store the media with its own settings can be created and configured here.

Server Name: Unique name of your server.

Email: Select this to enable and apply your email account setting for your camera.

FTP: Select this to access a granted folder on the external FTP server.

HTTP: Select this to use a web server to store the media.

Network Storage: Only one network storage is supported.

Product Page: DCS-6110 Firmware Version: 1.00

D-Link

DCS 6110 // LIVE VIDEO SETUP MAINTENANCE STATUS HELP

Wizard
Network Setup
Dynamic DNS
Image Setup
Video
Motion Detection
Time and Date
Event Setup
Access List
DI and DO
Logout

SERVER
You can set at most 5 different servers here for different event.
Test Save Settings Don't Save Settings

SERVER TYPE

Server name: NAS

Email
 Sender email address: test@abc.com
 Recipient E-mail Address: test2@abc.com
 Server address: mail.abc.com
 Server port: 25
 User name: Test
 Password: ****

FTP
 Server address:
 Server port: 21
 User name:
 Password:
 Remote folder name:
 Passive mode

HTTP
 URL: http://
 User name:
 Password:
 Network storage
 Network storage location:
 (for example: \\my_nas\disk\folder)
 Workgroup:
 User name:
 Password:
 Primary WINS server:
 Secondary WINS server:
 Test Save Settings Don't Save Settings

Helpful Hints..
 "Server name" The unique name for server.
 There are four kinds of servers supported. They are email server, FTP server, HTTP server and network storage.
 Email server:
 "Sender email address" The email address of the sender.
 "Recipient email address" The email address of the recipient.
 FTP server:
 "Remote folder name" Granted folder on the external FTP server. The string must conform to that of the external FTP server. Some FTP servers cannot accept preceding slash symbol before the path without virtual path mapping. Refer to the instructions for the external FTP server for details. The folder privilege must be open for upload.
 "Passive Mode" Check it to enable passive mode in transmission.
 HTTP server:
 "URL" The URL to upload the media.
 Network storage: Only one network storage is supported.
 "Network storage location" The path to upload the media.
 "Workgroup" The workgroup for network storage.

SECURITY

Add Media

Up to 5 media for recording with its own settings can be created and configured here. There are three types of media, **Snapshot**, **Video Clip** and **System Log**.

Media Name: The unique name for media.

Snapshot: Select this feature to enable camera to take snapshot.

Source: The source of stream, stream1 or stream2.

Send pre-event image(s) [0~7]: The number of pre-event images.

Send post-event image(s) [0~7]: The number of post-event images. Refer page 48 for more information.

File name prefix: The prefix name will be added on the file name of the snapshot images.

Add date and time suffix to file name: Check it to add timing information as file name suffix. Refer page 48 for more information.

Video clip: Select this feature to enable camera to take video clip.

Source: The source of stream, stream1 or stream2.

Pre-event recording: The interval of pre-event recording in seconds.

Maximum duration: The maximal recording file duration in seconds. Refer page 48 for more information.

Maximum file size: The maximal file size would be generated.

File name prefix: The prefix name will be added on the file name of the video clip. Refer page 48 for more information.

System log: Select this feature to enable camera to display system log.

Product Page: DCS-6110 Firmware Version: 1.00

D-Link

DCS 6110 // LIVE VIDEO SETUP MAINTENANCE STATUS HELP

Wizard
Network Setup
Dynamic DNS
Image Setup
Video
Motion Detection
Time and Date
Event Setup
Access List
DI and DO
Logout

MEDIA

You can set at most 5 different media here for different event.

Save Settings Don't Save Settings

MEDIA TYPE

Media name: [Snapshot]

Snapshot

Source: [Stream1]

Send [1] pre-event image(s) [0~7]

Send [1] post-event image(s) [0~7]

File Name Prefix: []

Add date and time suffix to file name

Video Clip

Source: [Stream1]

Pre-event recording: [0] seconds [0~9]

Maximum duration: [5] seconds [1~10]

Maximum file size: [500] kbytes [50~800]

File Name Prefix: []

System log

Save Settings Don't Save Settings

Helpful Hints...

"Media name" The unique name for media. There are three kinds of media. They are snapshot, video clip and system log.

Snapshot:

"Source" The source of stream, stream1 or stream2.

"Send Pre-event images" The number of pre-event images.

"Send Post-event images" The number of post-event images.

"File name prefix" The prefix name will be added on the file name of the snapshot images.

"Add date and time suffix to file name" Check it to add timing information as file name suffix.

Video clip:

"Source" The source of stream, stream1 or stream2.

"Pre-event recording" The interval of pre-event recording in seconds. There are two limitations for video clip file.

"Maximum duration" The maximal recording file duration in seconds.

"Maximum file size" The maximal file size would be generated.

"File name prefix" The prefix name will be added on the file name of the video clip.

Add Media...contd

Send post-event image (s) [0~7]

Specify to capture the number of images after a trigger is activated. A maximum of seven images can be generated.

For example:

If both the Send pre-event images and Send post-event images are set to seven, a total of 15 images are generated after a trigger is activated.

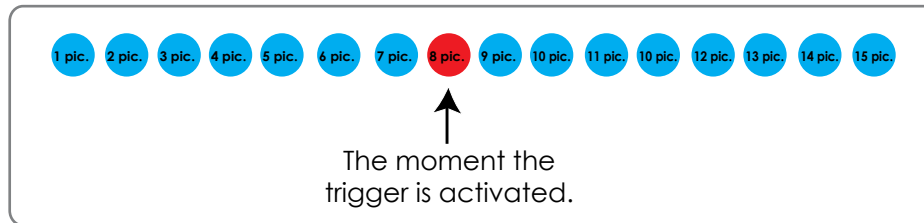

Add date and time suffix to file name

Select this option to add date and time to the file name suffix.

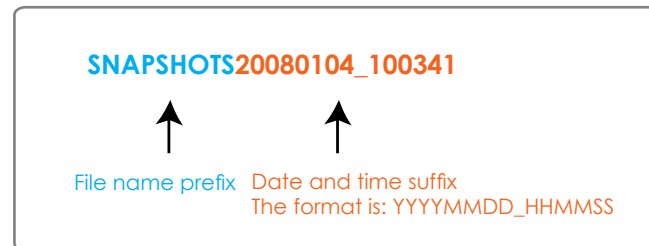

Maximum duration

Specify the maximal recording duration in seconds. You can set up to ten seconds.

For example:

If the Pre-event recording is set to five seconds and the Maximum duration is set to ten seconds, the Network Camera continues to record for another four seconds after a trigger is activated.

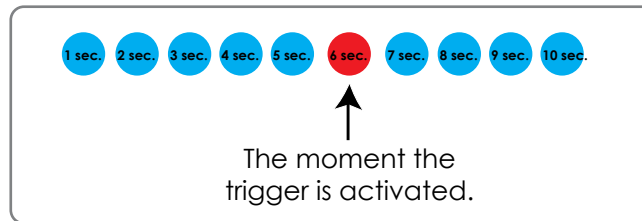

File name prefix

Enter the text that will be added at the beginning of the file name.



Add Event

Up to 3 events with its own settings can be created and configured here. Meanwhile, you can schedule the events here.

Event name: Unique name for the event.

Enable this event: Select this to activate this event.

Priority: Set the priority for this event and the event with higher priority will be executed first.

Delay: The delay time before checking next event. It is being used for both events of motion detection and digital input trigger.

Trigger: The input type that triggers the event.

Video motion detection: Motion is detected during live video monitoring. Select the windows that need to be monitored.

Periodic: The event is triggered in specified intervals. The unit of trigger interval is minute.

Digital input: External trigger input to the camera.

System boot: The event is triggered when the system boot up.

Time: Either “Always” or input the time interval.

Trigger D/O: Check it to trigger digital output for specific seconds when event is triggered. The default actions are triggering the D/O and storing the media on a CF card.

Move to preset location: If there is a server(s), user can select the available server(s) from **Move to preset location**.

Product Page: DCS-6110 Firmware Version: 1.00

D-Link

DCS 6110 // LIVE VIDEO SETUP MAINTENANCE STATUS HELP

EVENT

You can set at most 3 events like motion detection or digital input trigger here and arrange the detection schedule at the same time.

Save Settings Don't Save Settings

EVENT

Event name: Motion Detection

Enable this event

Priority: normal

Delay for 10 seconds before detecting next event. [For motion detection and digital input]

TRIGGER

Video motion detection
Detect motion in Test
Note: Please configure [Motion Detection](#) first

Periodic
Trigger every 1 minutes

Digital input

System boot

EVENT SCHEDULE

Sun Mon Tue Wed Thu Fri Sat

Time

Always

From 00:00 to 24:00

ACTION

Trigger D/O for 1 seconds

Server1
Attached media: Snapshot

NAS
Attached media: Snapshot

Save Settings Don't Save Settings

Helpful Hints..

Priority: The event with higher priority will be executed first.

Delay second(s) before detecting next event: The delay to check next event. It is used in motion detection and digital input trigger type.

There are four kinds of trigger supported.

Video motion detection: Select the windows which need to be monitored.

Periodic: The event is triggered in specified intervals. The unit of trigger interval is minute.

Digital input: The event is triggered when the DI status changed by external device.

System boot: The event is triggered when the system boot up.

Sun ~ Sat: Select the days of the week to perform the event.

Time: show "Always" or input the time interval.

The default action are triggering DO and storing media on CF card. If there are servers configured, the user can select them from "Server name", too.

Trigger DO: Check it to trigger digital output for specific seconds when event is triggered.

SECURITY

Add Recording

Here you can configure and schedule the recording settings.

Recording entry name: The unique name of the entry.

Enable this recording: Select this to enable the recording function.

Priority: Set the priority for this entry and the entry with higher priority will be executed first.

Source: The source of stream.

Recording schedule: Scheduling the recording entry.

Recording settings: Configuring the setting for the recording.

Destination: Select the folder where will store the recording file.

Total cycling recording size: Please input a HDD memory volume between 1MB and 200GB for recording space. The recording data will replace the oldest one when total recording size exceeds this value. For example, if each recording file is 6MB, and the total cycling recording size 600MB, then camera will recording 100 files to the specified location (folder). And then the camera will delete the oldest file and create new file for cycling recording. Please notice that if the HDD empty space is not enough, the recording will stop. Before you setup this option please make sure you HDD have enough space and it is better not to save other files in the same folder as recording files.

Size of each file for recording: File size for each recording file. You may input the value in the range of 200-6000.

File Name Prefix: The prefix name will be added on the file name of the recording file(s).

Product Page: DCS-6110 Firmware Version: 1.00

D-Link

DCS 6110 // LIVE VIDEO SETUP MAINTENANCE STATUS HELP

RECORDING

You can setup schedule recording to network storage with your specify week day and time period.

Save Settings Don't Save Settings

RECORDING

Recording entry name: Test

Enable this recording

Priority: normal

Source: Stream1

RECORDING SCHEDULE

Sun Mon Tue Wed Thu Fri Sat

Time

Always

From 00:00 to 24:00

RECORDING SETTINGS

Destination: NAS

Total cycling recording size: 1000 kbytes [1000~200000000]

Size of each file for recording: 200 kbytes [200~6000]

File Name Prefix:

Save Settings Don't Save Settings

Helpful Hints..

Recording : Enable this option if you want to upload the recording to a shared folder on the network.

Recording schedule : Select the day(s) according to when you want the camera to make a video clip.

Always : This enables the camera to make video clips continuously.

From : The time range specified for the video clip.

Destination : Please input the network path of your network storage, it will like "\\DNS\IPC\Record". If the network storage need authentication, please enter your user name and password here.

Total cycling recording size : Please input a HDD memory volume for recording space. The recording data will replace the oldest one when total recording size exceeds this value. Please notice that if the HDD empty space is not enough, the recording will stop. Before you setup this option please make sure you HDD have enough space and it is better not to save other files in the same folder as recording files.

Access List

Here you can configure the access permissions for each user.

Allow list: The list of IP addresses that have the access right to the camera.

Start IP address: The starting IP Address of the devices (such as a computer) that have permission to access the video of the camera. Click Add to save the changes made.
Note: A total of ten lists can be configured for both columns.

End IP address: The ending IP Address of the devices (such as a computer) that have permission to access the video of the camera.

Delete allow list: Remove the customized setting from the Allow List.

Deny list: The list of IP addresses that have no access right to the camera.

Delete deny list: Remove the customized setting from the Delete List.

For example:

When the range of allowed list is set from 1.1.1.0 to 192.255.255.255 and the range of denied list is set from 1.1.1.0 to 170.255.255.255, Only users' IP located between 171.0.0.0 and 192.25.25.25 can access the Network Camera.

Product Page: DCS-6110 Firmware Version: 1.00

D-Link

DCS 6110 // LIVE VIDEO SETUP MAINTENANCE STATUS HELP

ACCESS LIST
Here you can set access permissions for users to view your DCS-6110.

ALLOW LIST

Start IP address

End IP address

Delete allow list

DENY LIST

Start IP address

End IP address

Delete deny list

Helpful Hints...

Allow List:
"Start IP Address" The starting IP Address of the devices (such as a computer) that have permission to access the video of the camera.
"End IP Address" The ending IP Address of the devices (such as a computer) that have permission to access the video of the camera.
"Delete Allow List" Remove the customized setting from the Allow List.

Deny List:
"Start IP Address" The starting IP Address of the devices (such as a computer) that don't have permission to access the video of the camera.
"End IP Address" The ending IP Address of the devices (such as a computer) that don't have permission to access the video of the camera.
"Delete Deny List"

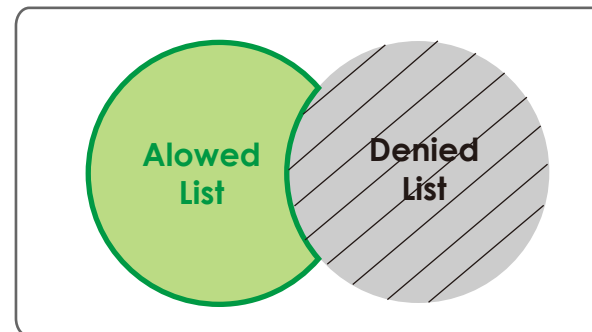

DI and DO

The I/O connector provides the physical interface for digital output (DO) and digital input (DI) that is used for connecting such external alarm devices as IR-Sensors and alarm relays to the network camera.

DI and DO: Setting for both Digital input signal and digital output signal can be configured here.

Digital input trigger condition: Please select from “**High**” or “**Low**” for digital input trigger condition. When external device connect to the digital input pins, the state of the voltage will be monitored. (Max. Input 500mA, 12Vdc)

Digital output: Select **Grounded** or **Open** to define normal status of the digital output. The camera will show whether the trigger is activated or not.

Product Page: DCS-6110 Firmware Version: 1.00

D-Link

DCS 6110 // LIVE VIDEO SETUP MAINTENANCE STATUS HELP

Wizard
Network Setup
Dynamic DNS
Image Setup
Video
Motion Detection
Time and Date
Event Setup
Access List
DI and DO
Logout

DI AND DO

The I/O connector provides the physical interface for digital output (DO) and digital input (DI) that is used for connecting a diversity of external alarm devices to the PTZ IP camera such as IR-Sensors and alarm relays.

The digital input is used for connecting external alarm devices and once triggered images will be taken and e-mailed.

Save Settings Don't Save Settings

DI AND DO

Digital input trigger condition: High, current status is normal

Digital output: normal status is Open, current status is normal

Helpful Hints..

The IP camera provides a general I/O terminal block with one digital input and one relay switch for device control. Pin 3 and pin 4 can be connected to an external sensor and the state of voltage will be monitored from the initial state 'LOW'. The relay switch of pin 1 and pin 2 can be used to turn on or off the external device. Please refer to manual for detail connection diagram.

Maintenance

Device Management

You can modify both camera's name and administrator's password of your camera, as well as add more user accounts for accessing the camera.

Admin password setup: Modify a password for the administrator's account.

Add user account: Add new user account.

Username: The username for the new account.

Password: The password for the new account.

Privilege: The access right for the new user.

Manage user: Managing the accounts for the existing users.

Authentication: The access right for the existing users.

Camera Name: Create a unique name for your camera and you can access the camera using this name in your web-browser. For example: `http://DCS-6110` (By default).

Product Page: DCS-6110 Firmware Version: 1.00

D-Link

DCS 6110 //	LIVE VIDEO	SETUP	MAINTENANCE	STATUS	HELP
Device Management Backup and Restore Firmware Update Logout	DEVICE MANAGEMENT				Helpful Hints.. For security reasons, it is recommended that you change the Login Name and Password for the Administrator accounts. Be sure to write down the new Login Names and Passwords to avoid having to reset the camera in the event that they are forgotten. Add user account: Add new user account. Username: The username for the new account. Password: The password for the new account. Privilege: The access right for the new user. Administrator can configure all the setup. Operator can use PTZ function and set preset position but can not enter setup page. Viewer can only view the video and audio. Manage user: Managing the accounts for the existing users. Authentication: The access right for the existing users. Camera name: You can access this device by using the name in your web-browser. For example: By default you can enter <code>http://DCS_6110</code> .
You can change to camera's administrative password as well as adding more user accounts for accessing the camera.					
ADMIN PASSWORD SETUP					
Password: <input type="password" value="....."/> Retype password: <input type="password" value="....."/> <input type="button" value="Save"/>					
ADD USER ACCOUNT					
User name: <input type="text" value="xyz"/> Password: <input type="password" value="...."/> Confirm password: <input type="password" value="...."/> Privilege: <input checked="" type="radio"/> Administrator <input type="radio"/> Normal User <input type="radio"/> Guest <input type="button" value="Add"/>					
MANAGE USER					
User name: <input type="text" value="abc"/> User password: <input type="password" value="...."/> Authentication: <input checked="" type="radio"/> Administrator <input type="radio"/> Normal User <input type="radio"/> Guest <input type="button" value="Modify"/> <input type="button" value="Delete"/>					
SERVER SETTING					
Camera Name: <input type="text" value="DCS-6110"/> <input type="button" value="Save"/>					

SECURITY

Backup and Restore

You can turn off the front panel LED, restore factory default settings and reboot the camera.

Turn off the LED indicator: Check this option to turn off the LED next to the lens. This will prevent anyone from observing the operation of the network camera.

Restore: Click the button will reset the camera back to its factory default settings. This will remove all the configuration settings that were made previously.

Reboot: Click the button will restart the camera.

Product Page: DCS-6110 Firmware Version: 1.00

D-Link

DCS 6110 // LIVE VIDEO SETUP MAINTENANCE STATUS HELP

Device Management
Backup and Restore
Firmware Update
Logout

BACKUP AND RESTORE
You can turn off the front panel LED, restore to factory default and reboot the camera.

SYSTEM
 Turn off the LED indicator

RESTORE
Restore all settings to factory default except settings in "Network type".

REBOOT
Reboot the system

Helpful Hints..
"Turn off the front panel LED" Check this option to turn off the LED next to the lens. This will prevent anyone from observing the operation of the IP Camera.
"Restore to Factory Default" This option will reset the camera back to its factory default settings. This will remove all the configuration settings that were made previously.
"Reboot" This option will restart the camera.

Firmware Update

Your current firmware version and date will be displayed on your screen. You may go to the D-Link Support page to check for the latest firmware version available.

To upgrade the firmware on your DCS-6110, please download and save the latest firmware version from the D-Link Support page to your local hard drive. Locate the file on your local hard drive by clicking the **Browse** button. Then, open the file and click the **“Upload”** button to start the firmware upgrade.

Current firmware version: It will be automatically determined and displayed by the system.

Current firmware date: It will be automatically determined and displayed by the system.

File Path: Locate the file (upgraded firmware) on your hard drive using the browse feature.

Upload: Start uploading and upgrading the new firmware to your camera.

Product Page: DCS-6110 Firmware Version: 1.00

D-Link

DCS 6110 // LIVE VIDEO SETUP MAINTENANCE STATUS HELP

Device Management
Backup and Restore
Firmware Update
Logout

FIRMWARE UPDATE

A new firmware upgrade may be available for your "DCS-6110". It is recommended to keep your "DCS-6110" firmware up-to-date to maintain and improve the functionality and performance of your internet camera. Click here [D-Link Support Page](#) to check for the latest firmware version available.

To upgrade the firmware on your "DCS-6110", please download and save the latest firmware version from the D-Link Support Page to your local hard drive. Locate the file on your local hard drive by clicking the Browse button. Once you have found and opened the file using the browse button, click the "Upload" button to start the firmware upgrade.

FIRMWARE INFORMATION

Current Firmware Version:	1.00
Current Firmware Date:	27 Mar 2008

FIRMWARE UPGRADE

File Path:

Helpful Hints..

Firmware updates are released periodically to improve the functionality of your IP camera and also to add new features. If you run into a problem with a specific feature of the IP camera, check our support site by clicking on the [Support](#) link on our support site link and see if an updated firmware is available for your IP camera.

Status

Device Info

This page displays all the details information about your device and network connection.

Product Page: DCS-6110 Firmware Version: 1.00

D-Link

DCS 6110 // LIVE VIDEO SETUP MAINTENANCE **STATUS** HELP

Device Info
Logs
Logout

DEVICE INFO
All of your network connection details are displayed on this page. The firmware version is also displayed here.

BASIC INFORMATION

Camera Name:	DCS-6110
Date and Time:	08 Apr 2008 17:40:09
Firmware Version:	1.00, 27 Mar 2008
IP address:	172.17.5.79
Subnet mask:	255.255.255.0
Default router:	172.17.5.254
Primary DNS:	192.168.168.210
Secondary DNS:	192.168.168.250
PPPoE:	OFF
DDNS:	ON

Helpful Hints..
All of your WAN and LAN connection details are displayed here.

Logs

This page displays the log information of your camera. You can configure a remote log server so that you can view your log details remotely.

Enable remote log: Enabling this feature so that the camera can send camera log files to a remote server.

Log server settings: Configure the setting for the log server.

IP Address: The IP address of the remote server.

Port: The port number of the remote log server. The default port is 514.

Save: Save the setting.

Current Log: The system log file that displayed by the system. The content of the file reveals useful information about camera configuration and connectivity status after the camera boots up.

Product Page: DCS-6110 Firmware Version: 1.00

D-Link

DCS 6110 // LIVE VIDEO SETUP MAINTENANCE STATUS HELP

Device Info
Logs
Logout

LOG
View a summary of device information here.

REMOTE LOG

Enable remote log

Log server settings:

IP address:

Port:

CURRENT LOG

```
Apr 8 10:25:10 syslogd 1.4.1: restart.
Apr 8 10:25:15 [UPnPIGDCP]: Search IGD failed (ffffff)
Apr 8 10:25:16 [DRM Service]: Starting DRM service.
Apr 8 10:25:25 [SYS]: Serial number = 001CF078A470
Apr 8 10:25:25 [SYS]: System starts at Tue Apr 8 10:25:25 UTC 2008
Apr 8 10:25:25 [NET]: Primary DNS = 192.168.168.250
Apr 8 10:25:25 [NET]: Secondary DNS = 192.168.168.250
Apr 8 10:25:26 [SYS]: Recording entry 0 stop
Apr 8 10:25:26 [SYS]: Recording entry 1 stop
Apr 8 10:25:27 [EVENT MGR]: reload config file
Apr 8 10:25:28 [DDNSC]: Username or email is empty
Apr 8 10:25:28 init: ^MStarting pid 608, console /dev/ttyS0: '/sbin/getty'
Apr 8 10:32:16 [RTSP SERVER]: Start one session, IP=172.17.5.147
Apr 8 10:32:26 [RTSP SERVER]: Stop one session, IP=172.17.5.147
Apr 8 11:04:21 [EVENT MGR]: reload config file
Apr 8 15:09:17 [RTSP SERVER]: Start one session, IP=172.17.5.147
Apr 8 15:09:18 [RTSP SERVER]: Stop one session, IP=172.17.5.147
Apr 8 15:50:52 automount[2634]: mount(generic): failed to mount //172.17.5.169/ (type smbfs) on /mnt/auto/i1
Apr 8 15:51:35 [SYS]: Recording entry 0 stop
Apr 8 15:51:36 [EVENT MGR]: reload config file
Apr 8 15:51:43 automount[2716]: mount(generic): failed to mount //172.17.5.169/ (type smbfs) on /mnt/auto/i1
Apr 8 15:51:50 automount[2719]: mount(generic): failed to mount //172.17.5.169/ (type smbfs) on /mnt/auto/i1
Apr 8 15:51:57 automount[2722]: mount(generic): failed to mount //172.17.5.169/ (type smbfs) on /mnt/auto/i1
```

Helpful Hints..

"Enable remote log" checked can send log message to remote log server.

"IP address" remote log server IP.

"Port" the default port is 514, if you need specify port, please use port number between 1024 to 65535.

check the log frequently to detect unauthorized network usage.

Help

Product Page: DCS-6110 Firmware Version: 1.00



DCS 6110 //	LIVE VIDEO	SETUP	MAINTENANCE	STATUS	HELP
<ul style="list-style-type: none"> Menu Live Video Setup Maintenance Status Logout 	<div style="background-color: #e67e22; color: white; padding: 2px;">SUPPORT MENU</div> <ul style="list-style-type: none"> Live Video Setup Maintenance Status <div style="background-color: #34495e; color: white; padding: 2px;">LIVE VIDEO</div> <ul style="list-style-type: none"> Camera Snapshot Client Settings Logout <div style="background-color: #34495e; color: white; padding: 2px;">SETUP</div> <ul style="list-style-type: none"> Wizard Network Setup Dynamic DNS Image Setup Audio and Video Motion Detection Time and Date Event Setup Access List DI and DO <div style="background-color: #34495e; color: white; padding: 2px;">MAINTENANCE</div> <ul style="list-style-type: none"> Admin System Firmware Update <div style="background-color: #34495e; color: white; padding: 2px;">STATUS</div> <ul style="list-style-type: none"> Device Info Logs 				<p>Helpful Hints...</p>
SECURITY					

D-ViewCam Installation

D-ViewCam software is included for the administrator to manage up to 32 D-Link network cameras remotely. The administrator can use the software to configure the advanced settings for the camera. D-ViewCam is a complete management tool and includes all configurative settings.

Insert the CD-ROM into the CD-ROM drive. A menu screen will appear as shown below.

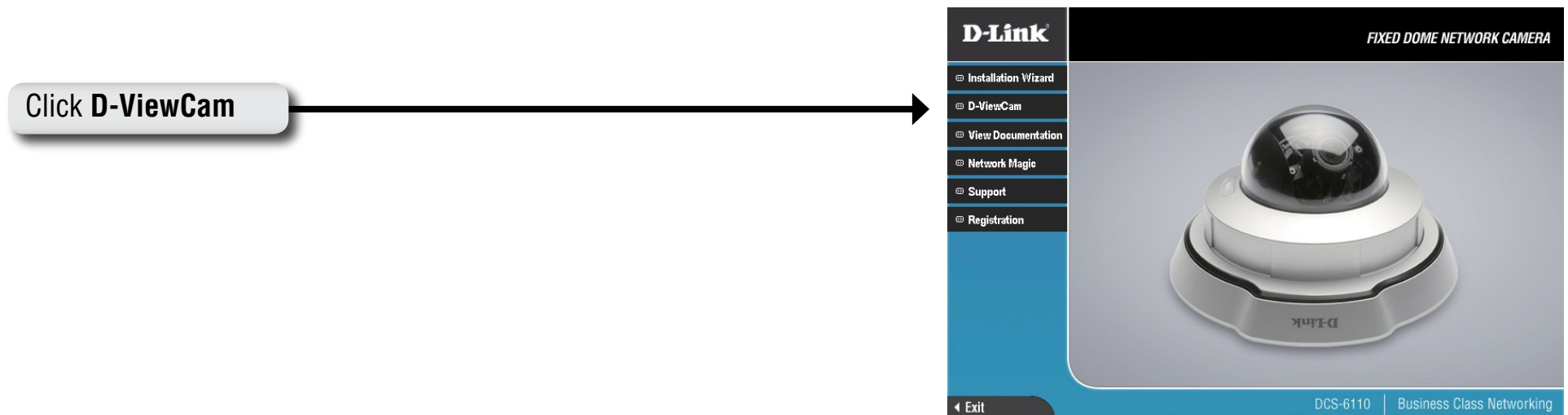

D-ViewCam provides English, Traditional Chinese and Simplified Chinese language versions. Select a language version and click OK to continue.

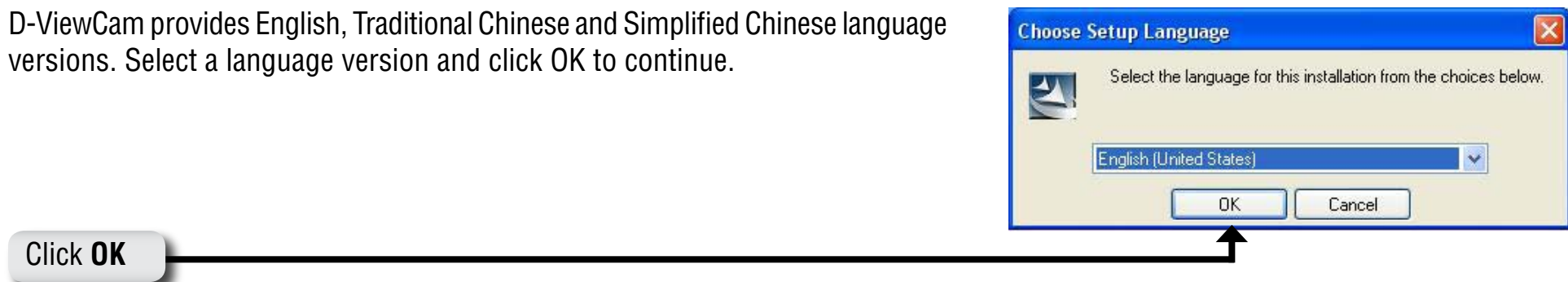

Click **Next** to continue.



Click **Next**

Click **Browse** if you would like to choose a specific folder for the installation, otherwise click **Next** to continue.

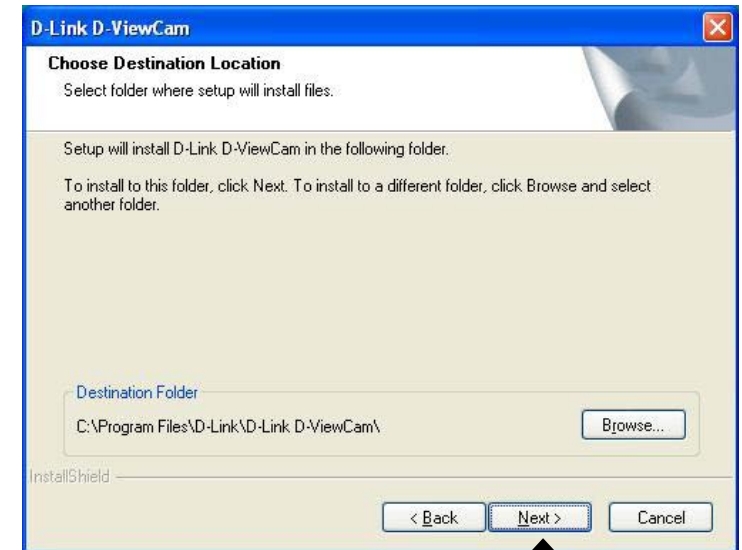

Click **Next**

Click **Next** to start the installation.

Note: The D-ViewCam installation process may take several minutes to complete.

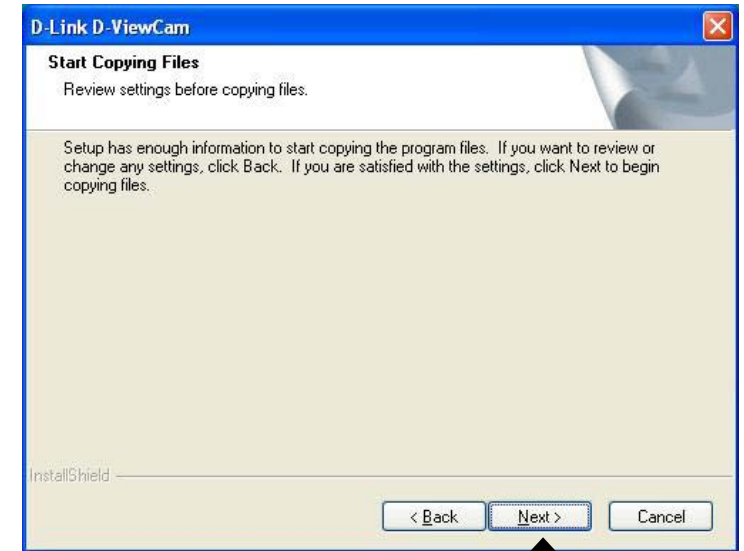

Click **Next**

Click **Finish** to complete the installation.

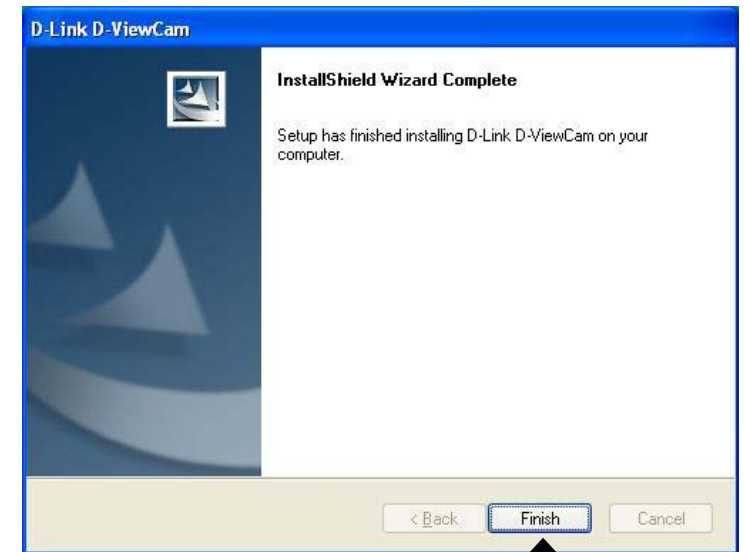

Click **Finish**

Add a Camera

This section will show you how to start and add a camera to the D-ViewCam system.

To start D-ViewCam, select **Start > All Programs > D-Link > D-Link D-ViewCam**.



Enter **admin** as the default username and leave the password blank. Click / OK to log into the system and access the Add Camera Wizard.

Note: Please refer to page 48 in the D-ViewCam user manual to change your password.



Welcome to the Add Camera Wizard. Use this wizard to add your cameras to the D-ViewCam system.

Note: Use the left or right arrow to navigate the wizard.

Click  / **Next** to continue.

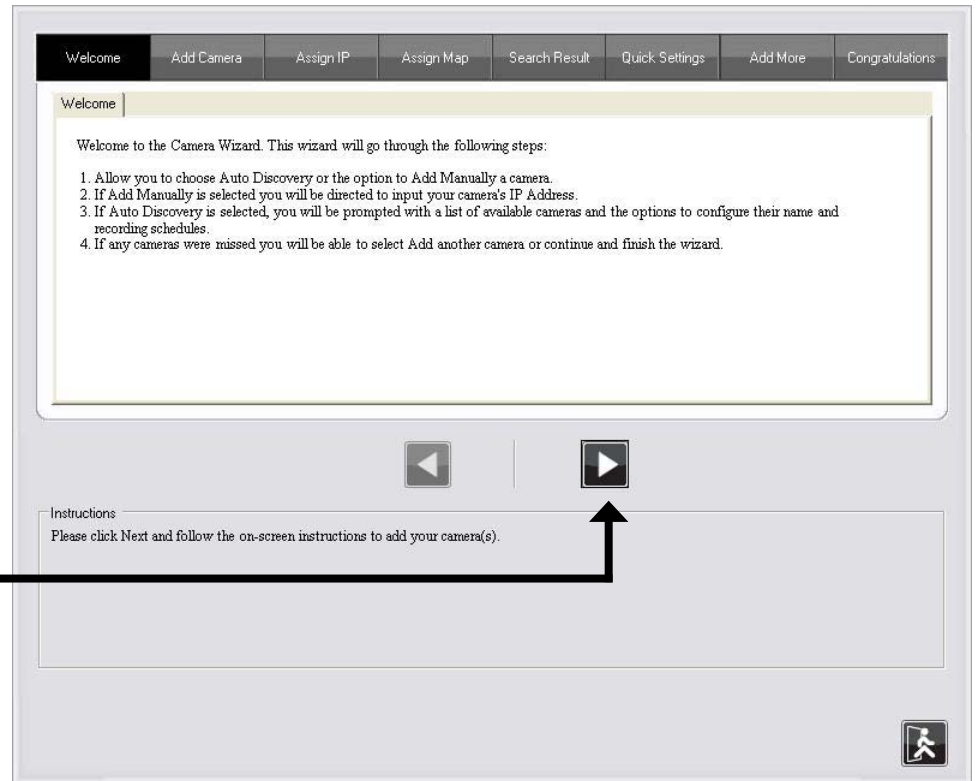

Click **Next**

Choose which method to add your camera(s). You can choose **Auto Discovery** to automatically search for your camera(s), or choose **Add Manually** to add your camera(s) via the camera's IP address. Click **Next** to continue.

If you choose **Auto Discovery**, the system will search all cameras that are located on the same LAN with same subnet. The system will place all the cameras at the default map called My Map. Click **Next** to continue.

If you choose **Add Manually**, you will need to enter the IP address of the camera(s). Click **Next** to continue.

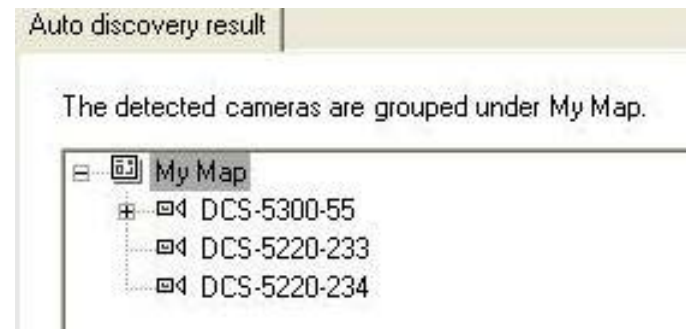
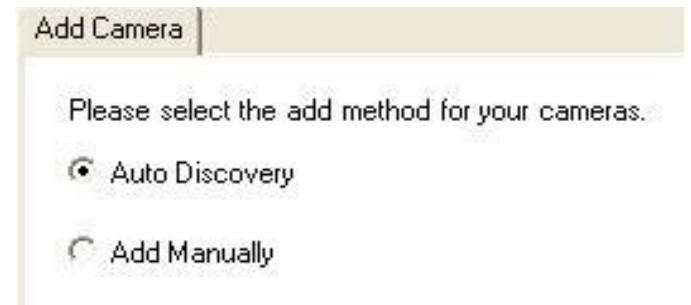

D-ViewCam shows the detected network camera(s) information. You can choose and schedule the recording for each camera.

- **24/7 Continuous Recording:** Continuously records surveillance 24 hours a day, 7 days a week.
- **24/7 Motion Detection Recording:** Continuously monitors, but only records surveillance when motion is detected.
- **Office Hours Only:** Continuously monitors during office hours (8:00AM to 6:00PM), and only records when motion is detected.
- **Non-Office Hours Only:** Continuously monitors during non-office hours (6:00PM to 8:00AM), and only records when motion is detected.

Note: Excluding 24/7 Continuous Recording, all other schedule recording modes can only record when motion is detected. Please refer to the user manual for more information.

Click **Next** to continue.

Quick Settings

The discovered cameras information showed as below:

Camera Name	Model	Schedule Recording Type	Status	IP Address	MAC Address
DCS-5300-55	DCS-5300	None	Active	10.129.1.55	000D887D6DC4
DCS-5220-233	DCS-5220	None	Active	10.129.1.233	001346DC3BC3
DCS-5220-234	DCS-5220	None	Active	10.129.1.234	001346DC3BEB

Select **Yes** to add other camera(s), or select **No** if you have no additional camera(s) to add. Click **Next** to continue.



The **Add Camera wizard** is now complete. Click **Close** to access the D-ViewCam's main screen.



Your D-ViewCam Installation is Complete!

Note: Please refer to the *D-ViewCam user manual* for information about using *D-ViewCam*.

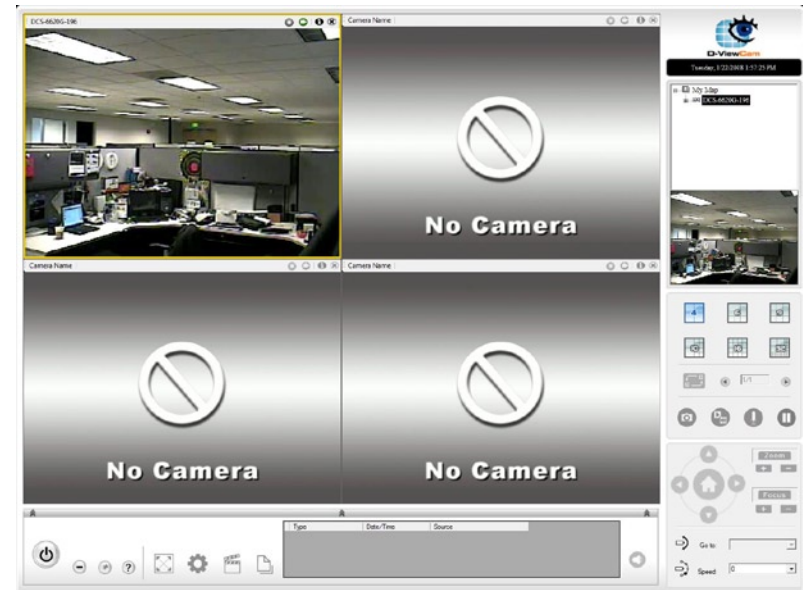

Frequently Asked Questions

This chapter provides solutions to problems that may occur during the installation and operation of the DCS-6110. Read the following descriptions if you are having any problems.

Note: *The examples below are illustrated in Windows XP. If you have a different operating system, the screenshots on your computer will look similar to the following examples.*

Fixed Dome Network Camera Features

1. What is a Fixed Dome Network Camera?

The Fixed Dome Network Camera is a stand-alone system connecting directly to an Ethernet or Fast Ethernet network. The Fixed Dome Network Camera differs from a conventional PC Camera because it has an integrated system with built-in CPU and web-based solutions, providing a low cost solution that can transmit high quality video images for monitoring. The Fixed Dome Network Camera can be remotely managed, accessed and controlled from any PC/Notebook over an Intranet or Internet using a web browser.

2. What is the maximum number of users that can access DCS-6110 simultaneously?

The maximum number of users that can log onto the Fixed Dome Network Camera at the same time is 10. Please keep in mind the overall performance of the transmission speed will be reduced if many users have logged on to the camera simultaneously.

There is no limited user when multicast-enabled router is used. This helps to reduce the network transmission load.

Note that to utilize this feature; the Network Camera must be configured to enable multicast streaming at the same time. For more information, see RTSP Streaming on page 41.

3. What algorithm is used to compress the digital image?

The Fixed Dome Network Camera utilizes MPEG-4 simple profile or MJPEG Mode image compression technology providing high quality images. MJPEG is a standard for image compression and it can be applied to various web browsers and application software without installing any extra software

4. Can I capture still images from the Fixed Dome Network Camera?

Yes you can capture still images using the snapshot function.

Fixed Dome Network Camera Installation

1. Can the Network Camera be used outdoors?

The Fixed Dome Network Camera is not weatherproof. It needs to be equipped with a weatherproof case for outdoor use but it is not recommended.

2. When physically connecting the Fixed Dome Network Camera to a network, what network cabling is required?

The Fixed Dome Network Camera uses Category 5 UTP cable allowing 10 Base-T and 100 Base-T networking solutions.

3. Can the Fixed Dome Network Camera be setup as a PC-cam on a computer?

No, the Fixed Dome Network Camera is used only on an Ethernet or Fast Ethernet network. The D-Link DSB-C110, DSB-C310, can be used as a PC Camera (Webcam).

4. Can the Fixed Dome Network Camera be connected to the network if it consists only of private IP addresses?

The Fixed Dome Network Camera can be connected to a LAN with private IP addresses.

5. Can the Fixed Dome Network Camera be installed and work if a firewall exists on the network?

If a firewall exists on the network, port 80 is open for ordinary data communication. The DCS-6110 uses port 5002 for streaming audio and port 5003 for streaming video. These ports (or the ports you have specified in the Setup Tab in the Configuration screen) need to be opened on the firewall.

6. Why am I unable to access the Fixed Dome Network Camera from a web browser?

If a router or firewall is used on the network, the correct ports for the DCS-6110 may not be configured on the router or firewall. To correct the problem, you need to determine if the DCS-6110 is behind a router or firewall and if the router or firewall is properly configured for the ports the DCS-6110 is using. Refer to Page 28 for help in opening the correct ports on a router or firewall for use with the DCS-6110. Other possible problems might be due to the network cable. Try replacing your network cable. Test the network

interface of the product by connecting a local computer to the unit, utilizing a Ethernet crossover cable. If the problem is not solved, the Fixed Dome Network Camera might be faulty.

7. Why does the Fixed Dome Network Camera work locally but not externally?

- This might be caused by network firewall protection. The setting of the firewall may need to be changed in order for the Fixed Dome Network Camera to be accessible outside of your local LAN. Check with the Network Administrator for your network.
- Make sure that your Fixed Dome Network Camera isn't conflicting with any Web server you may have running on your network.
- The default router setting might be a possible reason. Check that the configuration of the router settings allows the Fixed Dome Network Camera to be accessed outside of your local LAN.

8. I connected the Fixed Dome Network Camera directly to a computer with a cross-over Ethernet cable and received a Windows error upon running the installation Wizard?

- This Windows error will occur if the Fixed Dome Network Camera is connected to a computer that is not properly configured with a valid IP address. Turn off DHCP from the Network Settings in Windows and configure the computer with a valid IP address or connect the camera to a router with DHCP enabled.
- This error can also occur if the Installation Wizard icon is clicked on more than once from the setup wizard.

9. Noisy images occur. How can I solve the problem?

The video images might be noisy if the Fixed Dome Network Camera is used in a very low light environment. To solve this issue you need more lighting.

10. The images appear to be of poor quality, how can I improve the image quality?

- Make sure that your computer's display properties are set above 256 colors. Using 16 or 256 colors on your computer will produce dithering artifacts in the image, making the image appear to be of poor quality.
- The configuration on the Fixed Dome Network Camera image display is incorrect. Through the Setup>Image Setup section of the Web management you need to adjust the image related parameters such as brightness, white balance and power line frequency for fluorescent light.

Networking Basics

Check your IP address

After you install your new D-Link adapter, by default, the TCP/IP settings should be set to obtain an IP address from a DHCP server (i.e. wireless router) automatically. To verify your IP address, please follow the steps below.

Click on **Start > Run**. In the run box type **cmd** and click **OK**.

At the prompt, type **ipconfig** and press **Enter**.

This will display the IP address, subnet mask, and the default gateway of your adapter.

If the address is 0.0.0.0, check your adapter installation, security settings, and the settings on your access point. Some firewall software programs may block a DHCP request on newly installed adapters.

If you are connecting to a wireless network at a hotspot (e.g. hotel, coffee shop, airport), please contact an employee or administrator to verify their wireless network settings.

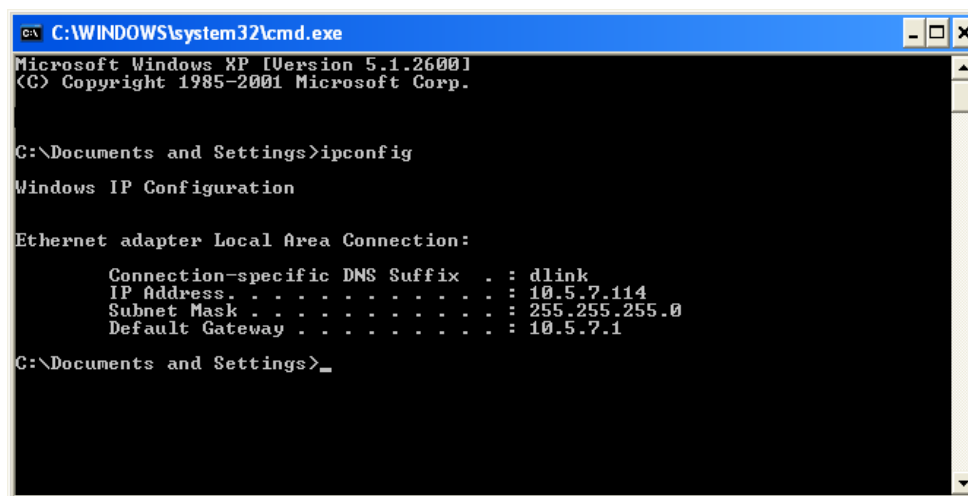

```
C:\WINDOWS\system32\cmd.exe
Microsoft Windows XP [Version 5.1.2600]
(C) Copyright 1985-2001 Microsoft Corp.

C:\Documents and Settings>ipconfig

Windows IP Configuration

Ethernet adapter Local Area Connection:

    Connection-specific DNS Suffix  . : dlink
    IP Address . . . . . : 10.5.7.114
    Subnet Mask . . . . . : 255.255.255.0
    Default Gateway . . . . . : 10.5.7.1

C:\Documents and Settings>_
```

Statically Assign an IP address

If you are not using a DHCP capable gateway/access point, or you need to assign a static IP address, please follow the steps below:

Step 1

Windows® XP - Click on **Start > Control Panel > Network Connections**.

Windows® 2000 - From the desktop, right-click **My Network Places > Properties**.

Step 2

Right-click on the **Local Area Connection** which represents your D-Link network adapter and select **Properties**.

Step 3

Highlight **Internet Protocol (TCP/IP)** and click **Properties**.

Step 4

Click **Use the following IP address** and enter an IP address that is on the same subnet as your network or the LAN IP address on your access point.

Example: If the network camera's LAN IP address is 192.168.0.1, make your IP address 192.168.0.X where X is a number between 2 and 99. Make sure that the number you choose is not in use on the network. Set Default Gateway the same as the LAN IP address of your access point (192.168.0.1).

Set Primary DNS the same as the LAN IP address of your access point (192.168.0.1). The Secondary DNS is not needed or you may enter a DNS server from your ISP.

Step 5

Click **OK** twice to save your settings.

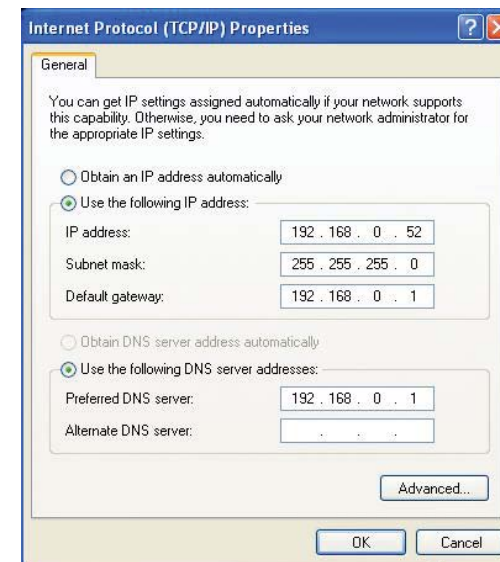

Reset and Restore

There is a button hidden in the pinhole beside the Ethernet socket. It is used to **reset** the system or **restore** the factory default settings. Sometimes resetting the **DCS-6110** will return the system back to a normal state. If the system still has problems after reset, restore the factory settings and install again:

- RESET:**
1. Lightly insert a paper clip (or a similar sized tool) into the reset hole on the back of the camera, press lightly and then release the button.
 2. The LED on the front of the camera will begin blinking red and green.
 3. When the LED stops the blinking the reset has completed.
- RESTORE:**
1. Insert the paperclip or other tool and press on the button continuously.
 2. Wait for the LED on the front of the camera to blink red and green and hold the button for 30 seconds.
 3. Withdraw the tool after the second cycle of the LED blinking and a factory restore has been completed.



External I/O Port

DI/DO Diagram

Pin 1~4 are used to connect with digital input and digital output devices. Refer to the following illustration for connection method.

The **DCS-6110** provides a general I/O terminal block with one digital input and one relay switch for device control. The relay switch of pin 1 and pin 2 can be used to turn on or off the external device. Pin 3 and pin 4 can be connected to an external sensor and the state of voltage will be monitored from the initial state 'LOW'.

The I/O connector provides the physical interface for digital output (DO) and digital input (DI) that is used for connecting a diversity of external alarm devices to the Network Camera such as IR-Sensors and alarm relays.

I/O Terminal Block:

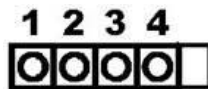

External I/O Port

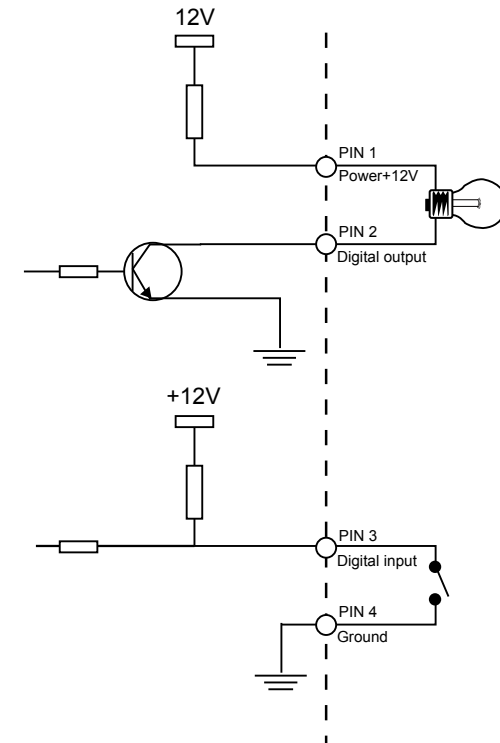

- 1 Power
- 2 Digital Output
- 3 Digital input(DI+)
- 4 Ground(DI-)

The digital input is used for connecting external alarm devices and once triggered images will be taken and e-mailed.

Technical Specifications

NETWORK PROTOCOL SUPPORT

- + TCP/IP, RTSP, RTP, RTCP, HTTP, SMTP, FTP, NTP, DNS, DHCP, UPnP, DDNS, PPPoE, ICMP, Samba client, IP Filtering, 3GPP

BUILT-IN NETWORK INTERFACES

- + 10/100BASE-TX Ethernet port

VIDEO ALGORITHM SUPPORT

- + JPEG for still image
- + MPEG4/MJPEG dual format compression

VIDEO RESOLUTION

- + Up to 30fps at 176 x 144
- + Up to 30fps at 320 x 240
- + Up to 30fps at 640 x 480

VIDEO FEATURES

- + Adjustable image size and quality
- + Time stamp and text overlays
- + 3 configurable motion detection windows
- + Flip & mirror

VIDEO BIT RATE

20K to 4M

CAMERA SPECIFICATIONS

- + VGA Progressive CMOS Sensor
- + 1.5 Lux @ F1.4
- + Electronic rolling shutter
- + 3.7-12mm vari-focal lens, F1.4-F2.8

LAN

- + IEEE 802.3 compliance
- + IEEE 802.3u compliance
- + Support Full-Duplex operations
- + 802.3x Flow Control support for Full-Duplex mode
- + Supported IEEE 802.3af standard (PoE)

PHYSICAL & ENVIRONMENTAL

DIAGNOSTIC LED

- 2 color LED
- 3-AXIS ANGLE
- X : 350°, Y : 45°, Z : 350°

POWER INPUT

100-240VAC, 50/60Hz

POWER CONSUMPTION

Max 3.6 W

DIMENSIONS

194 (W) X 180 (D) X 107 (H) (mm)

WEIGHT

630 gm

SECURITY

- + Administrator and user group protected
- + Password authentication

SURVEILLANCE SOFTWARE FUNCTIONS

- + Remote management/control of up to 32 cameras
- + Viewing of up to 32 cameras on one screen
- + Supports all management functions provided in web interface
- + Scheduled motion triggered, or manual recording options

REMOTE MANAGEMENT

- + Configuration accessible via web browser
- + Take snapshots/video clips and save to local hard drive or NAS via web browser

SURVEILLANCE

(Motion detection weekly schedule)

- + Upload snapshots/video clips via email
- + Upload snapshots/video clips via FTP

SYSTEM REQUIREMENTS

- + Operating System: Microsoft Windows 2000, XP, Vista
- + Browser: Internet Explorer, Firefox, Netscape, Mozilla, Opera browser

SUPPORTED PDA, MOBILE PHONES & SOFTWARE

Handsets with 3GPP player

- + Packet Video Player 3.0
- + QuickTime 6.5
- + Real Player 10.5
- + Windows 2000, XP

OPERATION TEMPERATURE

0° to 40° C (32° to 104° F)

STORAGE TEMPERATURE

-20° to 70° C (-4° to 158° F)

HUMIDITY

20% to 80% non-condensing

EMISSION (EMI), SAFETY & OTHER CERTIFICATIONS

- + FCC
- + CE
- + C-Tick

PACKAGE INCLUDES

- + DCS-6110 camera
- + External power adapter
- + Cat5 Ethernet cable
- + Quick Installation Guide
- + Master CD

¹ The mobile device must have 3G support and subscribe to 3G service from the phone service provider.

The playback device must be equipped with 3G video playback such as RealPlayer™ or PacketVideo™.