



User Manual

Full HD Mini Fixed Dome Network Camera

DCS-6210

Preface

D-Link reserves the right to revise this publication and to make changes in the content hereof without obligation to notify any person or organization of such revisions or changes. Information in this document may become obsolete as our services and websites develop and change. Please refer to the www.mydlink.com website for the most current information.

Manual Revisions

Revision	Date	Description
1.0	October 11, 2012	DCS-6210 Revision A1 with firmware version 1.00
1.1	November 08, 2012	DCS-6210 Revision A1 with power consumption revise

Trademarks

D-Link and the D-Link logo are trademarks or registered trademarks of D-Link Corporation or its subsidiaries in the United States or other countries. All other company or product names mentioned herein are trademarks or registered trademarks of their respective companies.

Copyright © 2012 D-Link Corporation.

All rights reserved. This publication may not be reproduced, in whole or in part, without prior expressed written permission from D-Link Corporation.

Table of Contents

Product Overview.....	4	Audio and Video.....	37
Package Contents.....	4	Preset.....	39
Introduction.....	5	Motion Detection	41
System Requirements	5	Time and Date.....	42
Features.....	6	Event Setup.....	43
Hardware Overview	7	SD Card.....	51
Outside	7	HTTPS.....	52
Internal	8	Access List.....	53
Installing or Removing an SD Card.....	9	Maintenance.....	54
Camera Installation Wizard	10	Device Management	54
Manual Hardware Installation.....	17	System	55
Adjusting the Camera	19	Firmware Upgrade.....	56
Mounting the Camera.....	20	Status	57
Configuration	22	Device Info	57
Using the Configuration Interface.....	22	Logs	58
Live Video	23	Help.....	59
Setup.....	25	Technical Specifications.....	60
Setup Wizard	25	Safety Statements	62
Network Setup.....	31		
Dynamic DNS	34		
Image Setup	35		

Product Overview

Package Contents



DCS-6210 Full HD Mini Fixed Dome Network Camera



CAT5 Ethernet cable



Power adapter



CD-ROM with User Manual and software



Quick Installation Guide



Alignment Sticker



Screwdriver and screws for installation



Weatherproofing rubber screw coverings



If any of the above items are missing, please contact your reseller.

Note: Using a power supply with a different voltage than the one included with your product will cause damage and void the warranty for this product.

Introduction

Congratulations on your purchase of the DCS-6210 Full HD Mini Fixed Dome Network Camera. The DCS-6210 is a versatile and unique solution for your small office or home. Unlike a standard webcam, the DCS-6210 is a complete system with a built-in CPU and web server that transmits high quality video images for security and outdoor surveillance. The DCS-6210 can be accessed remotely, and controlled from any PC/Notebook over your local network or through the Internet via a web browser. The simple installation and intuitive web-based interface offer easy integration with your Ethernet/Fast Ethernet network. The DCS-6210 vandal-proof housing and Power over Ethernet make it an ideal solution for a complete and cost-effective surveillance solution with an easy clutter-free installation. The remote monitoring, infrared, motion detection and event notifications features enable you be truly responsive to your surveillance deployment.

System Requirements

- Computer with Microsoft Windows® 7, Vista®, or XP (for CD-ROM Setup Wizard), Mac OS or Linux
- PC with 1.3GHz or above; at least 128MB RAM
- Internet Explorer 7 or above , Firefox 3.5 or above, Safari 4 and Chrome 8.0 or above
- Existing 10/100 Ethernet-based network or 802.11n wireless network
- A MicroSD memory card (optional) is required for recording to onboard storage. SDHC Class 6 or above is recommended.
- Broadband Internet connection

Features

Simple to Use

The DCS-6210 is a stand-alone system with a built-in CPU, requiring no special hardware or software. The DCS-6210 supports both ActiveX mode for Internet Explorer and Java mode for other browsers such as Firefox® and Safari®.

Supports a Variety of Platforms

Supporting TCP/IP networking, HTTP, and other Internet related protocols. The DCS-6210 can also be integrated easily into other Internet/Intranet applications because of its standards-based features. The DCS-6210 offers Ethernet/Fast Ethernet connectivity, making the DCS-6210 easy to integrate into your existing network environment. The DCS-6210 works with a 10Mbps Ethernet based network or 100Mbps Fast Ethernet based network for traditional wired environments.

Web Configuration

Using a standard Web browser, administrators can configure and manage the Network Camera directly from its own Web page via Intranet or Internet. This means you can access your DCS-6210 anytime, anywhere in the world.

IK10 Vandal-proof & IP66 Weather-proof Housing

The DCS-6210 uses IK10 vandal-proof and IP66 weatherproof housing, allowing you to rest assured that in the toughest of conditions, it will continue to provide round-the-clock surveillance at vandal-prone locations such as transportation hubs, schools, or correctional facilities both in all weathers.

Broad Range of Applications

With today's high-speed Internet services, the Network Camera can provide the ideal solution for delivering live video images over the Intranet and Internet for remote monitoring. The Network Camera allows remote access using a Web browser for live image viewing, and allows the administrator to manage and control the Network Camera anytime, anywhere in the world. Many applications exist, including industrial and public monitoring of homes, offices, banks, hospitals, child-care centers, and amusement parks.

Remote Monitoring Utility

The D-ViewCam application adds enhanced features and functionality for the Network Camera and allows administrators to configure and access the Network Camera from a remote site via Intranet or Internet. Other features include image monitoring, recording images to a hard drive, viewing up to 32 cameras on one screen, and taking snapshots.

PoE (Power over Ethernet) for Flexible Installation

The DCS-6210 can draw all the power it needs from a powered Ethernet port meaning installation is simple and clutter free.

Hardware Overview

Outside



1	Cable Harness	The cable harness retains the individual cables for easier manipulation
2	Ethernet Port	Connects to an RJ45 Ethernet cable or PoE cable to connect to your network
3	Reset Button	Press and hold the recessed button for 10 seconds to reset the camera
4	Power Connector	Power receptor for the provided power adapter
5	Microphone	Built in microphone records audio of the surrounding area
6	Camera Lens	Full HD Fixed Lens records video of the surrounding area
7	Camera Cover	Remove the cover to adjust the Camera Lens and access the Micro SD Card slot

Internal

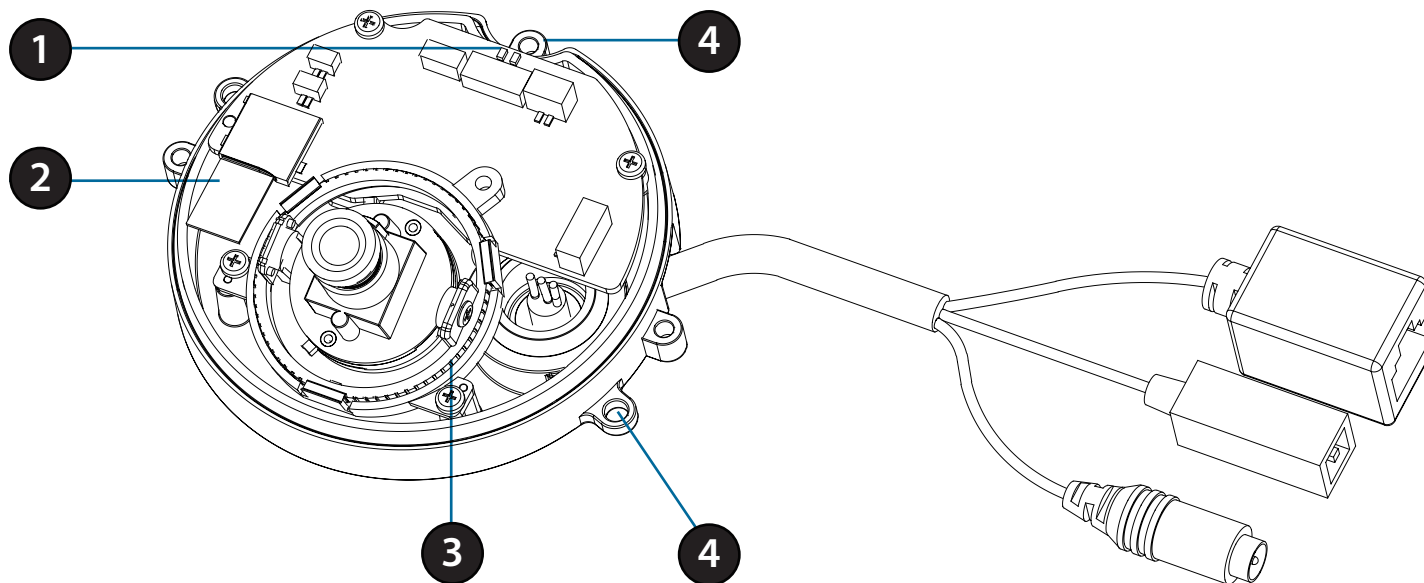

You can access the inside of the DCS-6210 by loosening the 3 security screws, then lifting the cover off of the camera.

1	LED	Power and network indicator.
2	SD/SDHC Card Slot	Insert an SD/SDHC card for storing internal recorded images and video.
3	Adjustable Lens Seat	Adjustable triple ring lens mount.
4	Mounting Screw Hole	Guide to assist correct casing alignment with the cable channel.

Installing or Removing an SD Card

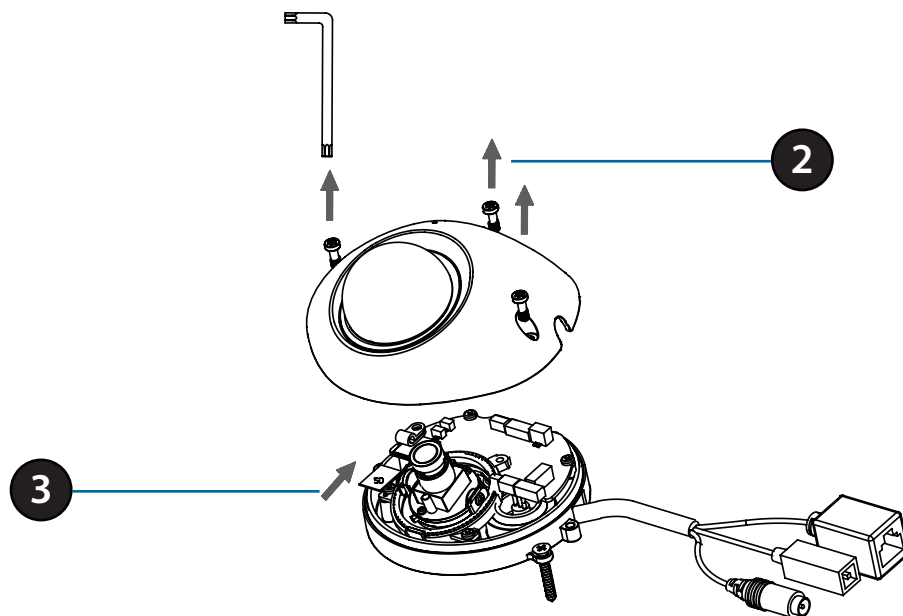

Step 1:

Place the camera face down on a non-slip flat surface.

Step 2:

Open the camera enclosure by loosening the 3 screws. Lift the dome off the base of the camera.

Step 3:

Push the SD card into the camera with the gold contacts oriented towards the base of the camera. To eject the SD card, push the SD card into the slot.

Step 4:

Replace the dome enclosure ensuring a tight fit.

Note: To ensure that the camera stays weatherproof, users are advised to ensure that the weatherproof sheath is secured firmly in place.

Camera Installation Wizard

Insert the DCS-6210 CD into your computer's CD-ROM drive to begin the installation. If the Autorun function on your computer is disabled, or if the D-Link Launcher fails to start automatically, click Start > Run. Type D:\autorun.exe, where D: represents the drive letter of your CD-ROM drive.

The CD-ROM will open the Camera Installation Wizard. Simply click **Setup Wizard** to go through the Installation Wizard, which will guide you through the installation process from connecting your hardware to configuring your camera.



Section 2: Installation

After clicking Setup Wizard, the following window will open.

Click **Next** to continue.

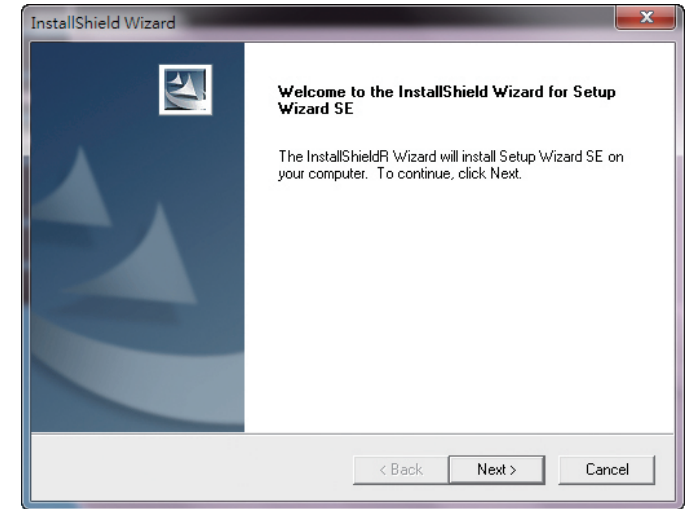

Click **Yes** to accept the License Agreement.

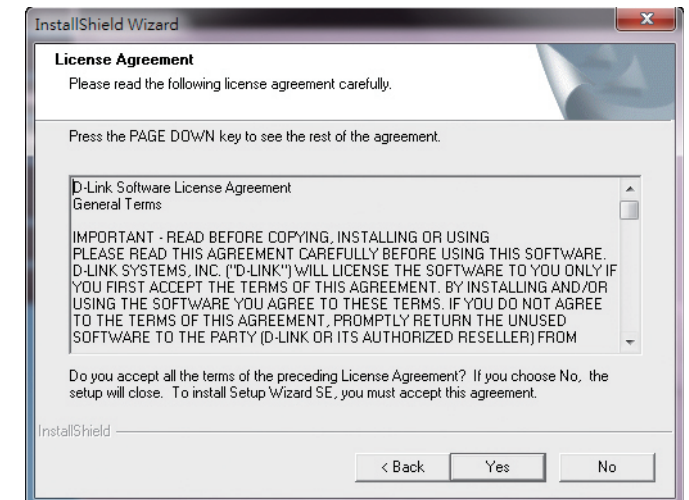

Section 2: Installation

To start the installation process, click **Next**.

Note: The installation may take several minutes to finish.

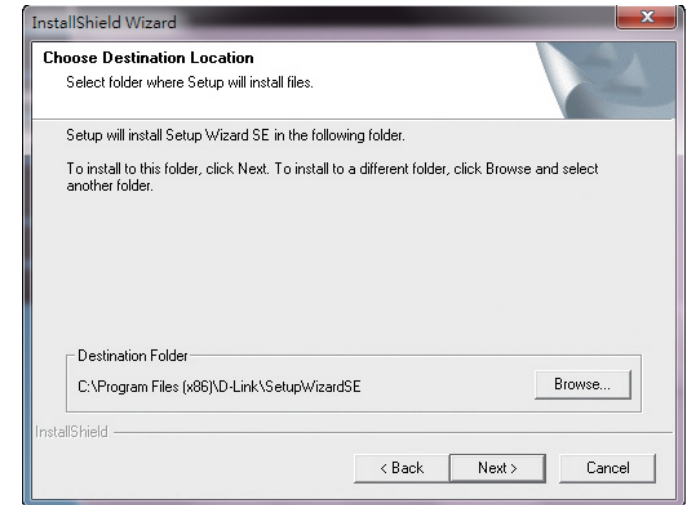

Click **Finish** to complete the installation.

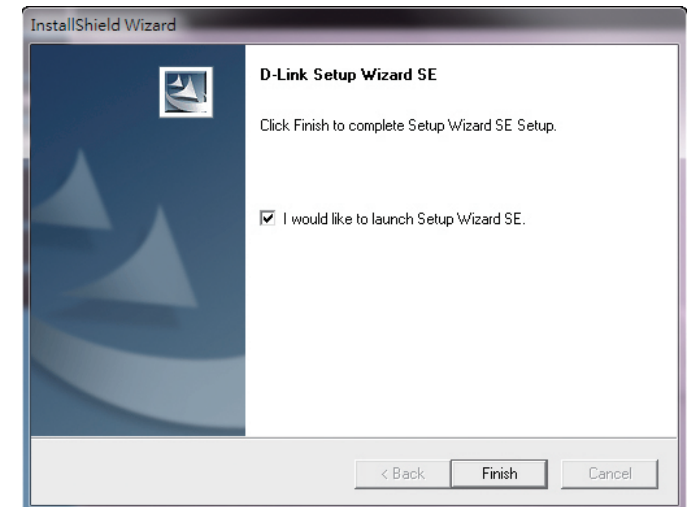

Section 2: Installation

Click on the **D-Link Setup Wizard SE** icon that was created in your Windows Start menu.

Start > D-Link > Setup Wizard SE

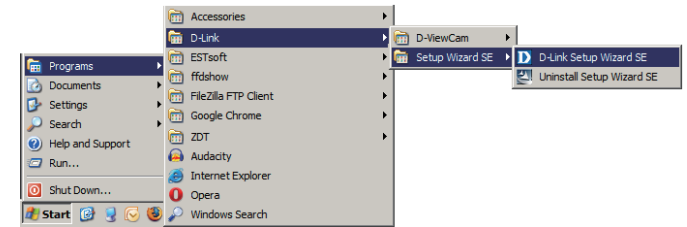

The Setup Wizard will appear and display the MAC address and IP address of your camera(s). If you have a DHCP server on your network, a valid IP Address will be displayed. If your network does not use a DHCP server, the network camera's default static IP **192.168.0.20** will be displayed.

Click the **Wizard** button to continue.



Section 2: Installation

Enter the Admin ID and password. When logging in for the first time, the default Admin ID is **admin** with the password left blank.

Click **Next**, to proceed to the next page.



The screenshot shows the 'Set up an Admin ID and Password to secure your camera' screen. It features two columns of input fields. The first column has 'Admin ID' and 'Password' fields. The second column has 'New ID', 'New Password', and 'Reconfirm' fields. Each of these second-column fields has a 'Change' checkbox to its left. At the bottom right, there are three buttons: 'Back' (left arrow), 'Next' (right arrow), and 'Exit' (stop sign).

Select DHCP if your camera obtains an IP address automatically when it boots up. Select static IP if the camera will use the same IP address each time it is started.

Click **Next**, to proceed to the next page.



The screenshot shows the 'Set IP Address' screen. It has two radio buttons: 'DHCP' (selected) and 'Static IP'. Below the radio buttons are several input fields for network configuration: 'IP Address' (192.168.1.185), 'Subnet Mask' (255.255.255.0), 'Default Gateway' (192.168.1.1), 'Primary DNS' (192.168.1.1), and 'Secondary DNS' (192.168.1.1). At the bottom right, there are three buttons: 'Back' (left arrow), 'Next' (right arrow), and 'Exit' (stop sign).

Section 2: Installation

Take a moment to confirm your settings and click **Restart**.

The screenshot shows the completion screen of the D-Link SECURICAM Network Setup Wizard. The interface includes the D-Link logo and the text 'SECURICAM Network'. Below this, there are several input fields for configuration details:

Admin ID	admin
Password	
IP Address	192.168.0.102
Subnet Mask	255.255.255.0
Primary DNS	192.168.0.1
Secondary DNS	192.168.0.1

Below the input fields, a message states: "The Setup Wizard has completed. Click on 'Back' to modify your settings. Click 'Restart' to save your current settings and reboot the Internet Camera." At the bottom right, there are two buttons: "Back" (with a left-pointing arrow) and "Restart" (with a circular arrow).

Click on the **D-Link Setup Wizard SE** icon that was created in your Windows Start menu.

Start > D-Link > Setup Wizard SE

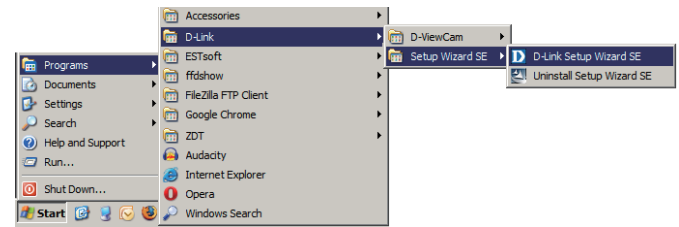

Select the camera and click the button labeled "**Link**" to access the web configuration.

The Setup Wizard will automatically open your web browser to the IP address of the camera.

The screenshot shows the camera selection screen of the D-Link SECURICAM Network Setup Wizard. On the left side, there are five buttons: "Wizard", "Search", "Link", "About", and "Exit". On the right side, there is a table with three columns: "MAC Address", "Current IP Address", and "Device Name".

MAC Address	Current IP Address	Device Name
1c.af.f7.02.b8.a4	172.17.5.173	DCS-1100
00.0c.0c.62.10.bb	172.17.5.114	DCS-6210
f0.7d.68.01.2a.22	172.17.5.167	DCS-930L
f0.7d.68.01.2a.7a	172.17.5.79	DCS-930L

Section 2: Installation

Enter **admin** as the default username and leave the password blank. Click **OK** to continue.



This section shows your camera's live video. You can select your video profile and view or operate the camera. For additional information about web configuration "Configuration" on page 22.

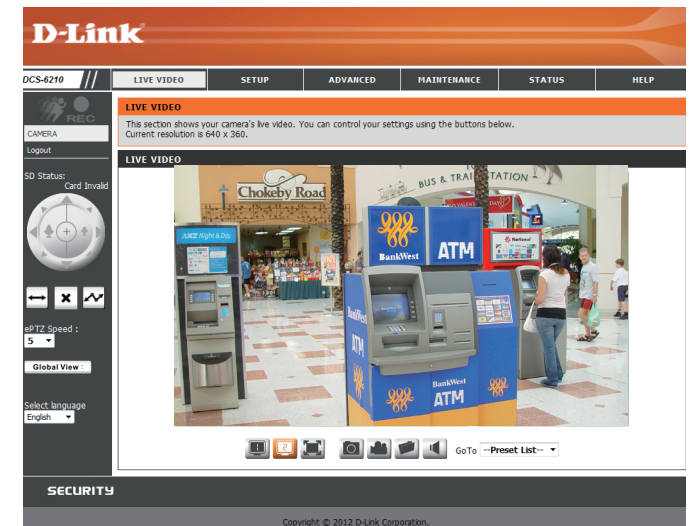

Manual Hardware Installation

If you wish to set up your camera without using the Camera Setup Wizard, please follow these steps.

General connection with 12 V DC Power Adaptor

Step 1

Place the camera on a non-slip surface.

Using the provided Ethernet cable connect the provided Ethernet cable to the Ethernet port on the Cable harness

Step 2

Connect the other end of the Ethernet cable your network..

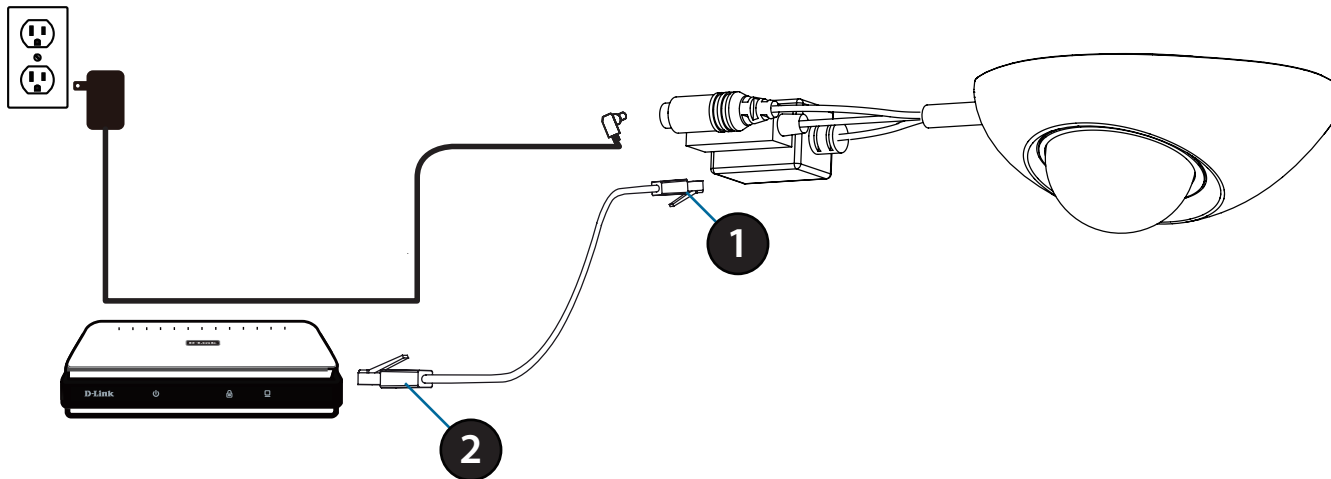

Connection using PoE

Step 1

If you are using a PoE hub, connect the IP camera to the hub via an Ethernet cable, which will provide transmission of both power and data over a single cable.

Step 2

Connect the other end of the Ethernet cable your network..

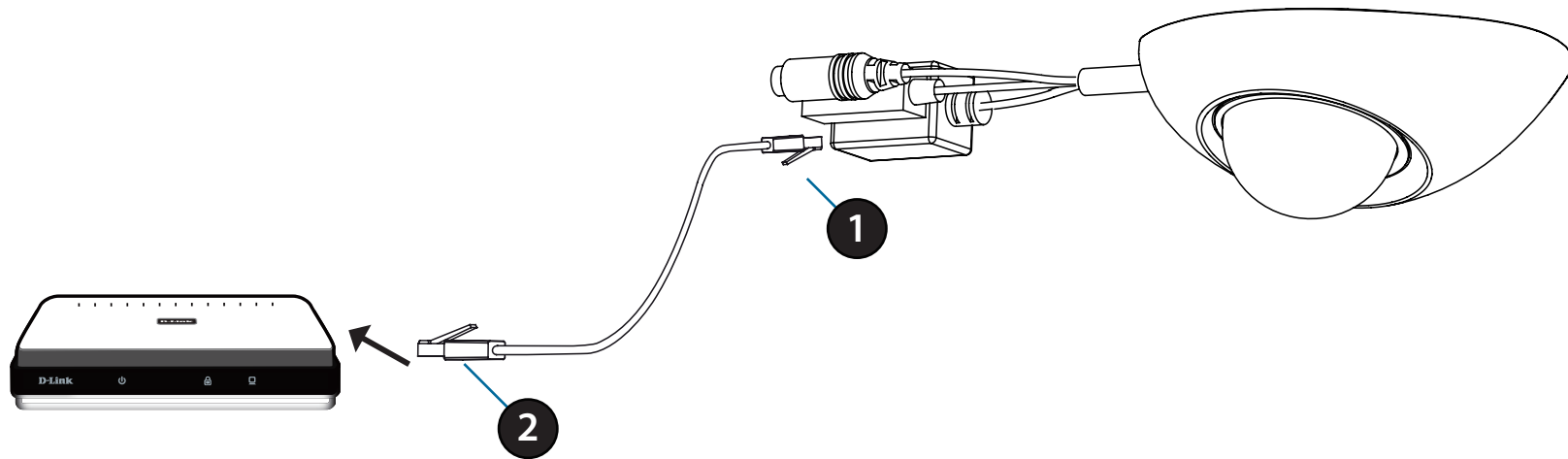

Adjusting the Camera

The DCS-6210 can be focused by adjusting the lens.

Step 1

Place the camera on a non-slip surface.

Step 2

Remove the cover by following the steps outlined in "Installing or Removing an SD Card" on page 9.

Step 3

Adjust the Viewing Angle of the 3-axis Mechanism by turning the lens module left and right until the desired position is achieved.

Step 4

Turn the lens up and down until the desired position is achieved.

Step 5

Turn the lens to adjust the IP camera's image until the desired orientation is achieved.

Step 6

Seat the cover and fasten the three security screws.

Step 7

Insert the weatherproof rubber screw coverings over the screws ensuring a tight seal.

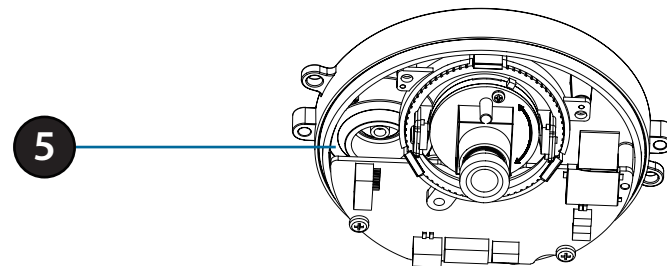
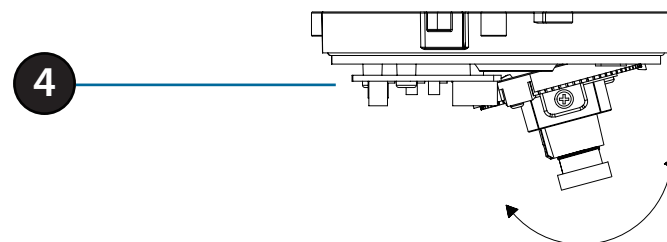
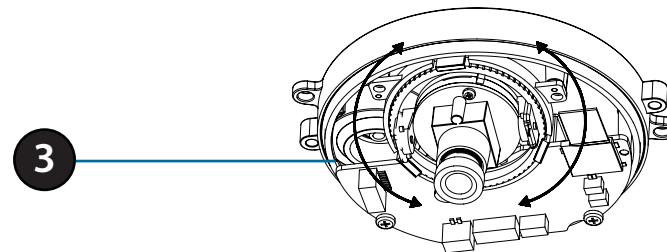

Mounting the Camera

The DCS-6210 is suitable for mounting to a ceiling or wall.

Step 1

Position the alignment sticker in the desired location for the camera.

Step 2

Use a 6mm drill bit to make required holes approximately 25mm deep.

Step 3

Insert wall anchors.

Step 4

Affix the DCS-6210 base using the screws provided.

Step 5

Adjust the Lens. For detailed instructions on adjusting the lens see "Adjusting the Camera" on page 19

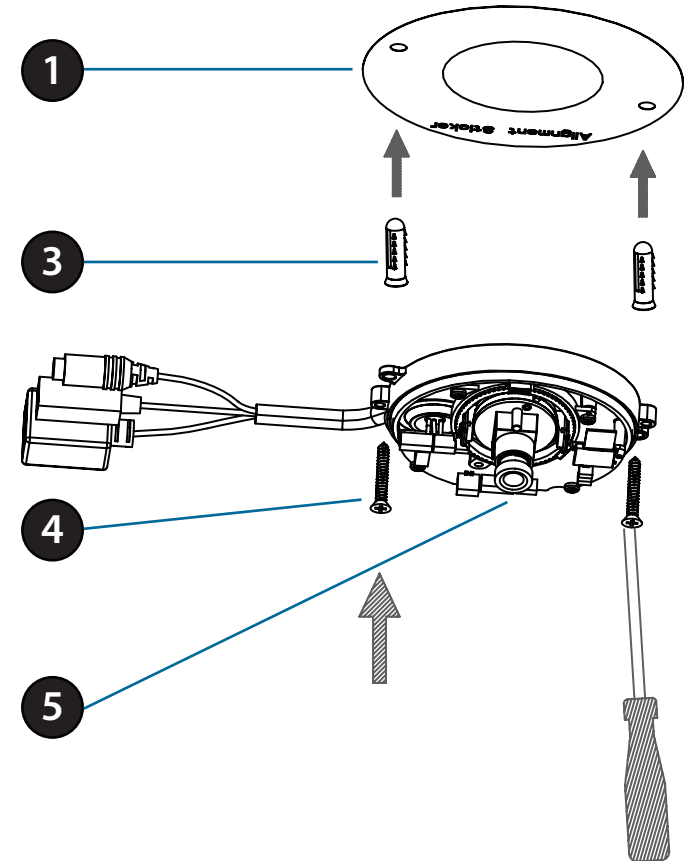

Step 6

Affix the DCS-6210 dome using the screws provided.

Step 7

Insert the weatherproof rubber screw coverings over the screws ensuring a tight seal.

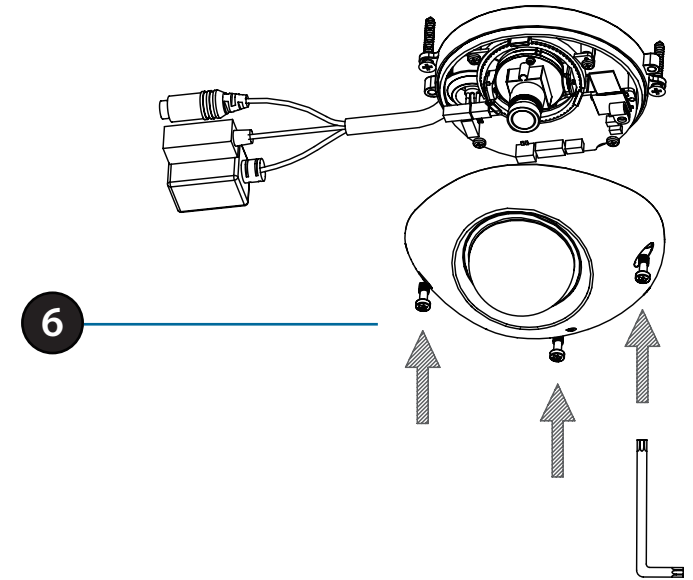

Note: When mounting ensure the camera is oriented with the cables positioned to the bottom of the device.

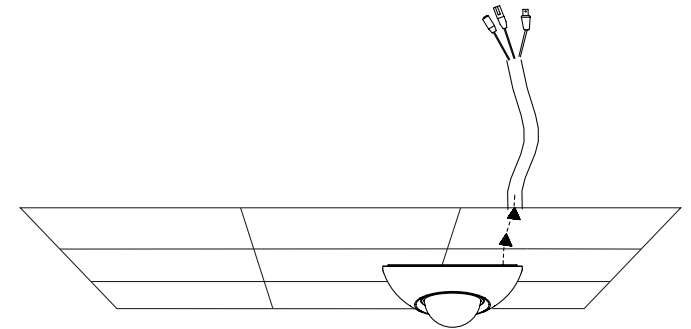

Configuration

Using the Configuration Interface

After completing the Camera Installation Wizard, you are ready to use your camera. The camera's built-in Web configuration utility is designed to allow you to easily access and configure your DCS-6210. At the end of the wizard, click **Go To Camera**, or enter the IP address of your camera into a web browser, such as Mozilla Firefox. To log in, use the User name **admin** and the password you created in the Installation Wizard. If you did not create a password, the default password is blank. After entering your password, click **OK**.

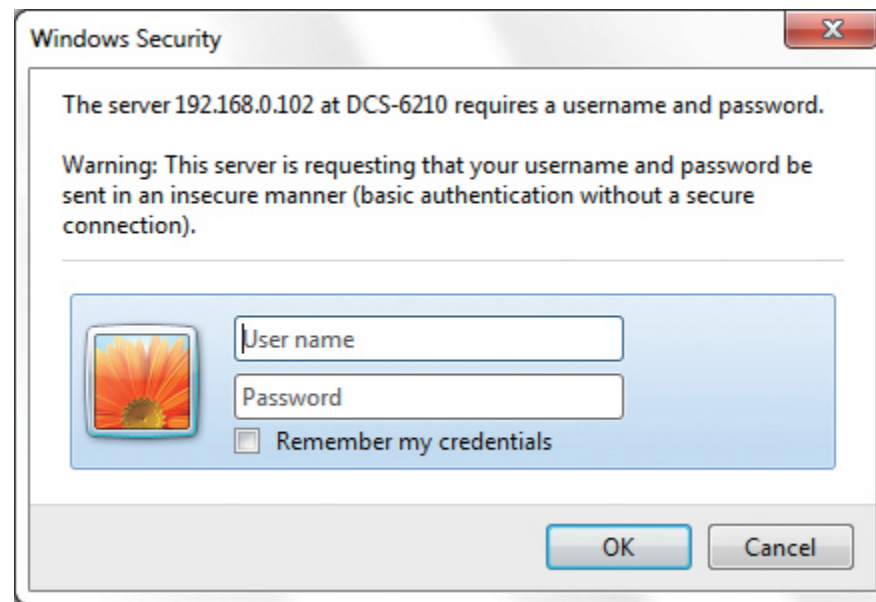







Live Video

This section shows your camera's live video. You may select any of the available icons listed below to operate the camera. You may also select your language using the drop-down menu on the left side of the screen.

You can zoom in and out on the live video image using your mouse. Right-click to zoom out or left-click to zoom in on the image.

SD Status: This option displays the status of the SD card. If no SD card has been inserted, this screen will display the message "Card Invalid."

	Motion Trigger Indicator	This indicator will change color when a trigger event occurs. Note: The video motion feature for your camera must be enabled.
	Recording Indicator	When a recording is in progress, this indicator will change color.
	Control Pad	This control pad can be used to electronically pan, tilt, and zoom (ePTZ) within the camera's predefined view area, if one has been defined.
	Auto Pan	Starts the automatic panning function. The ROI will pan from back and forth within the FOV
	Stop	Stops the camera ePTZ motion
	Preset Path	Starts the camera's motion along the predefined path



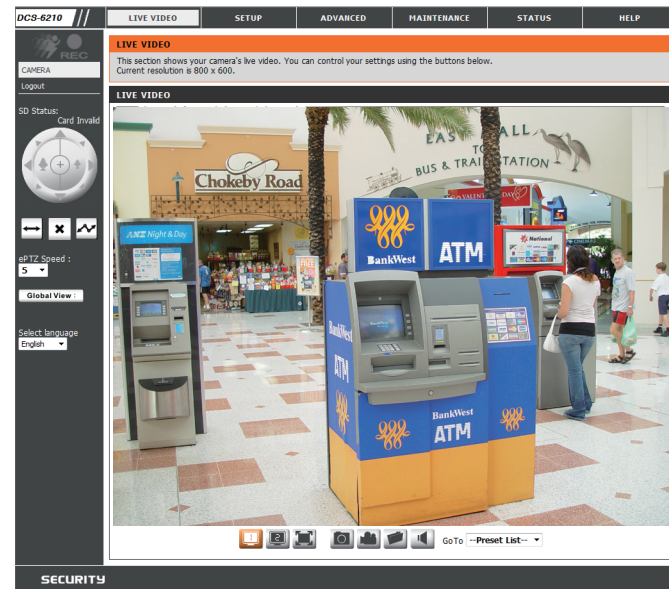





ePTZ Speed: You may select a value between 0 and 64. 0 is the slowest and 64 is the fastest.



Section 4: Configuration

Global View: This window indicates the total field of view (FOV) of the camera. The red box indicates the visible region of interest (ROI).

Language: You may select the interface language using this menu.

- | | |
|--|--|
|  Video Profile 1 |  Take a Snapshot |
|  Video Profile 2 |  Record a Video Clip |
|  Video Profile 3 |  Set a Storage Folder |
|  Full screen mode |  Listen/Stop Audio In (from microphone) |

Go To: If any presets have been defined, selecting a preset from this list will (**Preset List**) display it.



Setup Setup Wizard

To configure your Network Camera, click **Internet Connection Setup Wizard**. Alternatively, you may click **Manual Internet Connection Setup** to manually configure your Network Camera and skip to "Network Setup" on page 31.

To quickly configure your Network Camera's motion detection settings, click **Motion Detection Setup Wizard**. If you want to enter your settings without running the wizard, click **Manual Motion Detection Setup** and skip to "Motion Detection" on page 41.

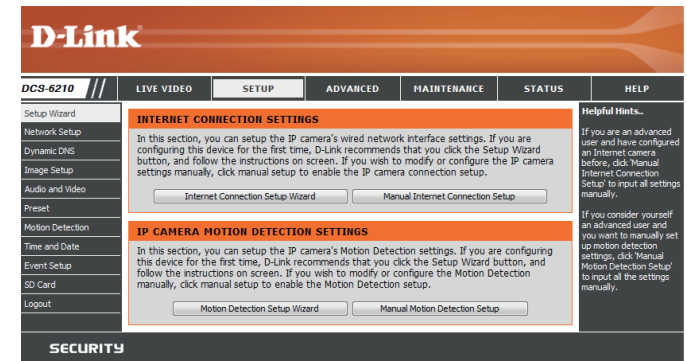

Internet Connection Setup Wizard

This wizard will guide you through a step-by-step process to configure your new D-Link Camera and connect the camera to the internet. Click **Next** to continue.

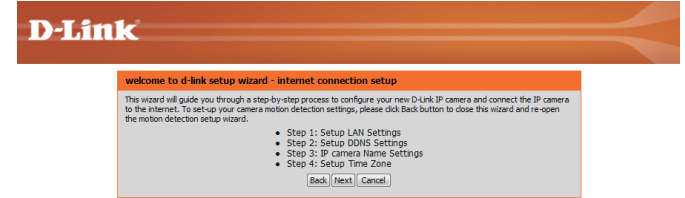

Note: Select DHCP if you are unsure of which settings to choose.

Click **Next** to continue.

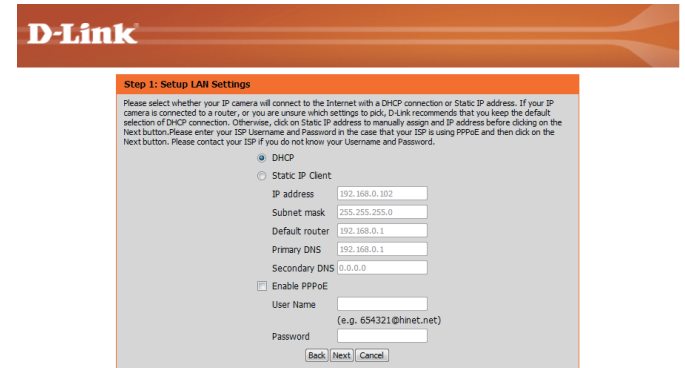

Section 4: Configuration

Select **Static IP** if your Internet Service Provider has provided you with connection settings, or if you wish to set a static address within your home network. Enter the correct configuration information and click **Next** to continue.

If you are using PPPoE, select **Enable PPPoE** and enter your user name and password, otherwise click **Next** to continue.

If you have a Dynamic DNS account and would like the camera to update your IP address automatically, Select **Enable DDNS** and enter your host information. Click **Next** to continue.

Enter a name for your camera and click **Next** to continue.

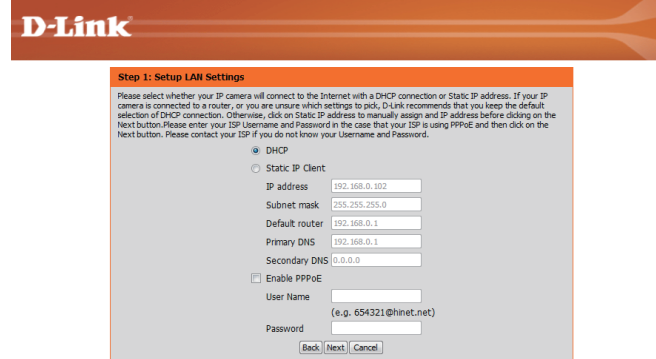

D-Link

Step 1: Setup LAN Settings

Please select whether your IP camera will connect to the Internet with a DHCP connection or Static IP address. If your IP camera is connected to a router, or you are unsure which settings to pick, D-Link recommends that you keep the default selection of DHCP connection. Otherwise, click on Static IP address to manually assign an IP address before clicking on the Next button. Please enter your ISP Username and Password in the case that your ISP is using PPPoE and then click on the Next button. Please contact your ISP if you do not know your Username and Password.

DHCP

Static IP Client

IP address

Subnet mask

Default router

Primary DNS

Secondary DNS

Enable PPPoE

User Name

Password

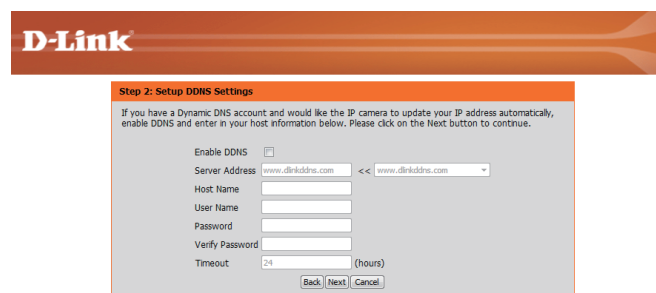

D-Link

Step 2: Setup DDNS Settings

If you have a Dynamic DNS account and would like the IP camera to update your IP address automatically, enable DDNS and enter in your host information below. Please click on the Next button to continue.

Enable DDNS

Server Address <<

Host Name

User Name

Password

Verify Password

Timeout (hours)



D-Link

Step 3: IP camera Name Settings

D-Link recommends that you rename your IP camera for easy accessibility. You can then identify and connect to your IP camera via this name. Please assign a name of your choice before clicking on the Next button.

IP camera Name

Section 4: Configuration

Configure the correct time to ensure that all events will be triggered as scheduled. Click **Next** to continue.

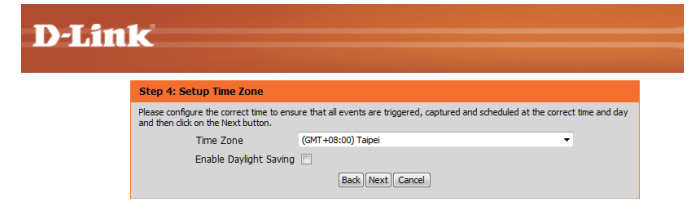

Confirm the settings are correct and click **Apply** to save them..

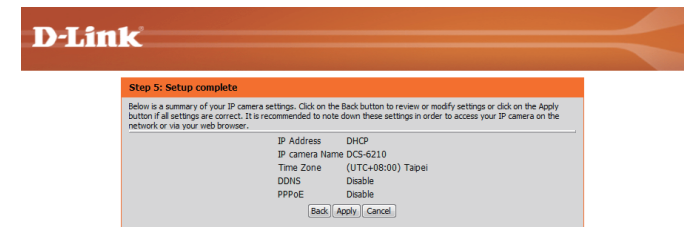

The settings will be saved to the DCS-6210 and the camera will restart.

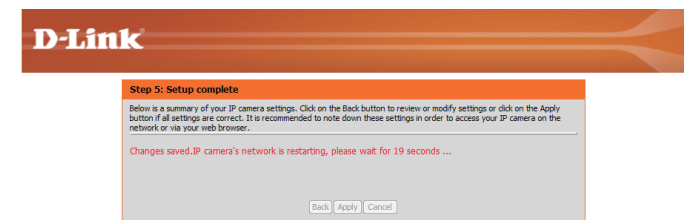

Motion Detection Setup Wizard

This wizard will guide you through a step-by-step process to configure your camera's motion detection functions.

Click **Next** to continue.

Step 1

This step will allow you to enable or disable motion detection, specify the detection sensitivity, and adjust the camera's ability to detect movement.

You may specify whether the camera should capture a snapshot or a video clip when motion is detected.

Please see the **Motion Detection** section on "Motion Detection" on page 41 for information about how to configure motion detection.

Step 2

This step allows you to enable motion detection based on a customized schedule. Specify the day and hours. You may also choose to always record whenever motion is detected.

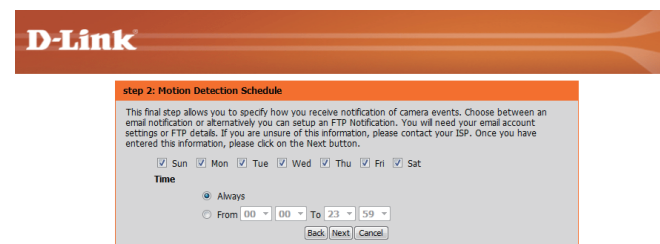
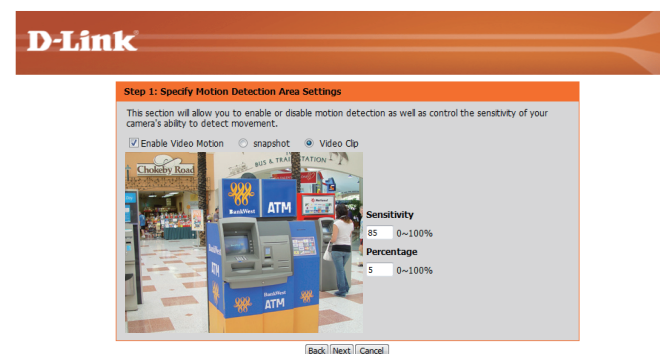
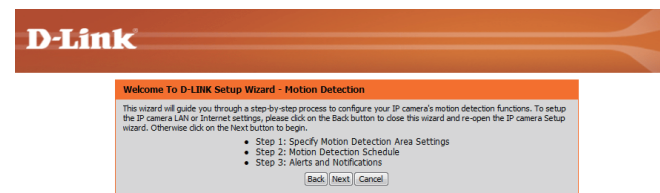

Step 3

This step allows you to specify how you will receive event notifications from your camera. You may choose not to receive notifications, or to receive notifications via e-mail or FTP.

Please enter the relevant information for your e-mail or FTP account.

Click **Next** to continue.

The screenshot shows the 'Step 3: Alerts and Notification' configuration screen. It features a D-Link logo at the top. Below the title, there is a paragraph of instructions: 'This final step allows you to specify how you receive notification of camera events. Choose between an email notification or alternatively you can setup an FTP Notification. You will need your email account settings or FTP details. If you are unsure of this information, please contact your ISP. Once you have entered this information, please click on the Next button.' There are two radio button options: 'Do not notify me' (unselected) and 'Email' (selected). Under the 'Email' option, there are input fields for 'Sender email address', 'Recipient email address', 'Server address', 'User name', 'Password', and 'Port' (with '25' entered). Under the 'FTP' option, there are input fields for 'Server address', 'Port' (with '21' entered), 'User name', 'Password', and 'Remote folder name'. At the bottom right, there are 'Back', 'Next', and 'Cancel' buttons.

Step 4

You have completed the Motion Detection Wizard.

Please verify your settings and click **Apply** to save them.

The screenshot shows the 'Step 4: Setup Complete' screen. It features a D-Link logo at the top. Below the title, there is a paragraph of instructions: 'You have completed your IP camera setup. Please click the Back button if you want to review or modify your settings or click on the Apply button to save and apply your settings.' A summary of settings is displayed: 'Motion Detection : Enable', 'EVENT : Video Clip', 'Schedule Day : Sun , Mon , Tue , Wed , Thu , Fri , Sat ,', 'Schedule Time : Always', and 'Alerts and Notification : Email'. At the bottom, there are 'Back', 'Apply', and 'Cancel' buttons.

Please wait a few moments while the camera saves your settings and restarts.

The screenshot shows the 'Step 4: Setup Complete' screen, identical to the previous one, but with a red message at the top: 'Changes saved. IP camera's network is restarting, please wait for 6 seconds ...'. At the bottom, there are 'Back', 'Apply', and 'Cancel' buttons.

Network Setup

Use this section to configure the network connections for your camera. All relevant information must be entered accurately. After making any changes, click the **Save Settings** button to save your changes.

LAN Settings: This section lets you configure settings for your local area network.

DHCP: Select this connection if you have a DHCP server running on your network and would like your camera to obtain an IP address automatically.

If you choose DHCP, you do not need to fill out the IP address settings.

Static IP Client: You may obtain a static or fixed IP address and other network information from your network administrator for your camera. A static IP address may simplify access to your camera in the future.

IP Address: Enter the fixed IP address in this field.

Subnet Mask: This number is used to determine if the destination is in the same subnet. The default value is 255.255.255.0.

Default Gateway: The gateway used to forward frames to destinations in a different subnet. Invalid gateway settings may cause the failure of transmissions to a different subnet.

Primary DNS: The primary domain name server translates names to IP addresses.

Secondary DNS: The secondary DNS acts as a backup to the primary DNS.

D-Link

DCS-6210 // LIVE VIDEO SETUP ADVANCED MAINTENANCE STATUS HELP

Setup Wizard
Network Setup
Dynamic DNS
Image Setup
Audio and Video
Preset
Motion Detection
Time and Date
Event Setup
SD Card
Logout

NETWORK SETUP
You can configure your LAN and Internet settings here.
Save Settings Don't Save Settings

LAN SETTINGS

DHCP
 Static IP Client

IP address: 192.168.0.102
Subnet mask: 255.255.255.0
Default router: 192.168.0.1
Primary DNS: 192.168.0.1
Secondary DNS: 0.0.0.0

Enable UPnP presentation
 Enable UPnP port forwarding
Forwarding Port: 1024 (Text)
Forwarding Status: UPnP forwarding is inactive

PPPOE SETTINGS

Enable Disable
User Name:
Password:
Confirm password:
PPPOE Status: PPPOE is inactive.

HTTP

HTTP port: 80
Access name for stream1: video1.mjpg
Access name for stream2: video2.mjpg

HTTPS

HTTPS port: 443

RTSP

Authentication: Disable
RTSP port: 554
Access name for stream1: live1.sdp
Access name for stream2: live2.sdp

CoS SETTINGS

Enable CoS
VLAN ID: 1 [0-4095]
Live video: 0
Live audio: 0
Event/Alarm: 0
Management: 0

Helpful Hints..

Select DHCP Connection if you are running a DHCP server on your network and would like an IP address assigned to your IP camera automatically.

UPnP: Enabling UPnP settings will allow you to configure your IP camera as an UPnP device in the network.

PPPOE Setting: If you use the IP camera to connect directly to the Internet, you will need to enter the username and password which were given to you when you set up your account with your Internet Service Provider. If the camera is behind a router or a gateway, you do not need to configure this setting.

HTTP: HTTP Port is the port you allocate in order to connect to the IP camera via a standard web browser.

HTTPS: HTTPS Port in a IP camera connect it with a PC via a secure web browser.

RTSP: RTSP Port is the port you allocate in order to connect to a IP camera by using streaming mobile device(s), such as a mobile phone or PDA.

CoS (Class of Service): Coarsely-grained traffic control based on the L2 protocol. Class of Service technologies do not guarantee a level of service in terms of bandwidth and delivery time, they offer a "best-effort".

QoS (Quality of Service): Finely-grained traffic control, a resource reservation control mechanism. Quality of service guarantees are important if the network capacity is insufficient, especially for real-time streaming multimedia applications.

Enable IPv6: Select this option and click Save to enable IPv6 setting. Please note that this only works if your network environment and hardware equipment support IPv6. The browser should be Microsoft @ Internet Explorer 6.5, Mozilla Firefox 3.0 or above.

Enable UPnP Presentation: Enabling this setting allows your camera to be configured as a UPnP device on your network.

Enable UPnP Port Forwarding: Enabling this setting allows the camera to add port forwarding entries into the router automatically on a UPnP capable network.

Enable PPPoE: Enable this setting if your network uses PPPoE.

User Name / Password: Enter the username and password for your PPPoE account. Re-enter your password in the Confirm Password field. You may obtain this information from your ISP.

HTTP Port: The default port number is 80.

Access Name for Stream 1~3: The default name is video#.mjpg, where # is the number of the stream.

HTTPS Port: You may use a PC with a secure browser to connect to the HTTPS port of the camera. The default port number is 443.

RTSP Port: The port number that you use for RTSP streaming to mobile devices, such as mobile phones or PDAs. The default port number is 554. You may specify the address of a particular stream. For instance, live1.sdp can be accessed at `rtsp://x.x.x.x/video1.sdp` where the x.x.x.x represents the ip address of your camera.

The screenshot displays the configuration web interface for a camera, organized into several sections:

- PPPOE SETTINGS:** Includes radio buttons for 'Enable' and 'Disable' (selected), fields for 'User Name', 'Password', and 'Confirm password', and a 'PPPoE Status' field showing 'PPPoE is inactive'.
- HTTP:** Features a 'HTTP port' dropdown set to '80' and two 'Access name' fields: 'video1.mjpg' and 'video2.mjpg'.
- HTTPS:** Features an 'HTTPS port' dropdown set to '443'.
- RTSP:** Includes an 'Authentication' dropdown set to 'Disable', an 'RTSP port' dropdown set to '554', and two 'Access name' fields: 'live1.sdp' and 'live2.sdp'.
- CoS SETTINGS:** Includes an 'Enable CoS' checkbox (checked) and a 'VLAN ID' dropdown set to '1'. Below are 'Live video', 'Live audio', 'Event/Alarm', and 'Management' dropdowns, all set to '0'.
- QoS SETTINGS:** Includes an 'Enable QoS' checkbox (checked) and 'Live video', 'Live audio', 'Event/Alarm', and 'Management' dropdowns, all set to '0'.
- IPv6:** Includes an 'Enable IPv6' checkbox (checked), an 'IPv6 Information' button, and a 'Manually setup the IP address' section with fields for 'Optional IP address / Prefix length' (set to /64), 'Optional default router', and 'Optional primary DNS'.
- MULTICAST:** Contains two sections for 'Enable multicast for stream 1' and 'stream 2'. Each section lists 'Multicast group address', 'Multicast video port', 'Multicast RTP video port', 'Multicast audio port', 'Multicast RTP audio port', and 'Multicast TTL [1~255]' with corresponding input fields.

On the right side of the interface, there are several informational text blocks:

- HTTP:** HTTP Port is the port you allocate in order to connect to the IP camera via a standard web browser.
- HTTPS:** HTTPS Port is a IP camera connects it with a PC via a secure web browser.
- RTSP:** RTSP Port is the port you allocate in order to connect to a IP camera by using streaming mobile devices, such as a mobile phone or PDA.
- CoS (Class of Service):** Coarsely-grained traffic control based on the IP protocol. Class of Service technologies do not guarantee a level of service in terms of bandwidth and delivery time, they offer a "best-effort".
- QoS (Quality of Service):** Finely-grained traffic control, a resource reservation control mechanism. Quality of service guarantees are important if the network capacity is insufficient, especially for real-time streaming multimedia applications.
- Enable IPv6:** Select this option and click Save to enable IPv6 setting. Please note that this only works if your network environment and hardware equipment support IPv6. The browser should be Microsoft @ Internet Explorer 6.5, Mozilla Firefox 3.0 or above. When IPv6 is enabled, by default, the network camera will listen to router advertisements and be assigned a link-local IPv6 address accordingly.
- IPv6 Information:** Click this button to obtain the IPv6 information. If your IPv6 setting are successful, the IPv6 address list will be listed in the pop-up window. Please follow the steps below to link to an IPv6 address: 1) Open your web browser. 2) Enter the link-global or link-local IPv6 address in the address bar of your web browser. 3) Press enter on the keyboard or click Refresh button to refresh the webpage.
- Manually setup the IP address:** Select this option to manually configure IPv6 setting if your network environment does not have DHCPv6 server and advertisement-enabled routers.
- Multicast:** Click the items to display the detailed configuration information. Select the Always multicast option to enable multicast for stream 1 ~ 3. Unicast video transmission delivers a stream through point-to-point transmission, multicast, on the other hand, sends a stream to the multicast group address and allows multiple clients to acquire

Enable CoS: Enabling the Class of Service setting implements a best-effort policy without making any bandwidth reservations.

Enable QoS: Enabling QoS allows you to specify a traffic priority policy to ensure a consistent Quality of Service during busy periods. If the Network Camera is connected to a router that itself implements QoS, the router's settings will override the QoS settings of the camera.

Enable IPv6: Enable the IPV6 setting to use the IPV6 protocol. Enabling the option allows you to manually set up the address, specify an optional IP address, specify an optional router and an optional primary DNS.

Enable Multicast for stream The DCS-6210 allows you to multicast each of the available streams via group address and specify the TTL value for each stream. Enter the port and TTL settings you wish to use if you do not want to use the defaults.

The screenshot displays the configuration web interface for the DCS-6210, organized into several sections:

- PPPOE SETTINGS:** Includes options for Enable/Disable, User Name, Password, Confirm password, and PPPoE Status (currently inactive).
- HTTP:** Configures HTTP port (80) and access names for stream1 (video1.mjpg) and stream2 (video2.mjpg).
- HTTPS:** Configures HTTPS port (443).
- RTSP:** Configures Authentication (Disable), RTSP port (554), and access names for stream1 (live1.sdp) and stream2 (live2.sdp).
- CoS SETTINGS:** Features an 'Enable CoS' checkbox and dropdowns for VLAN ID (1), Live video (0), Live audio (0), Event/Alarm (0), and Management (0).
- QoS SETTINGS:** Features an 'Enable QoS' checkbox and dropdowns for Live video (0), Live audio (0), Event/Alarm (0), and Management (0).
- IPv6:** Includes an 'Enable IPv6' checkbox, an 'IPv6 Information' button, and fields for manually setting the IP address, optional default router, and optional primary DNS.
- MULTICAST:** Configures multicast settings for two streams. Stream 1 includes fields for Multicast group address (239.1.1.1), video port (6550), RTP video port (6551), audio port (6552), RTP audio port (6553), and TTL (64). Stream 2 includes fields for Multicast group address (239.1.1.2), video port (6554), RTP video port (6555), audio port (6556), RTP audio port (6557), and TTL (64).

At the bottom, there are 'Save Settings' and 'Don't Save Settings' buttons.

HTTP: HTTP port is the port you allocate in order to connect to the IP camera via a standard web browser.

HTTPS: HTTPS Port is a IP camera connects it with a PC via a secure web browser.

RTSP: RTSP Port is the port you allocate in order to connect to a IP camera by using streaming mobile devices), such as a mobile phone or PDA.

CoS (Class of Service): Coarsely-grained traffic control based on the IP protocol. Class of Service technologies do not guarantee a level of service in terms of bandwidth and delivery time, they offer a "best-effort".

QoS (Quality of Service): Finely-grained traffic control, a resource reservation control mechanism. Quality of service guarantees are important if the network capacity is insufficient, especially for real-time streaming multimedia applications.

Enable IPv6: Select this option and click Save to enable IPv6 setting. Please note that this only works if your network environment and hardware equipment support IPv6. The browser should be Microsoft @ Internet Explorer 6.5, Mozilla Firefox 3.0 or above. When IPv6 is enabled, by default, the Network Camera will listen to router advertisements and be assigned a link-local IPv6 address accordingly.

IPv6 Information: Click this button to obtain the IPv6 information. If your IPv6 setting are successful, the IPv6 address list will be listed in the pop-up window. Please follow the steps below to link to an IPv6 address:
 1) Open your web browser.
 2) Enter the link-global or link-local IPv6 address in the address bar of your web browser.
 3) Press Enter on the keyboard or click Refresh button to refresh the webpage.

Manually setup the IP address: Select this option to manually configure IPv6 setting if your network environment does not have DHCPv6 server and advertisements-enabled routers.

Multicast: Click the items to display the detailed configuration information. Select the Always multicast option to enable multicast for stream 1 ~ 3. Unicast video transmission delivers a stream through point-to-point transmission, multicast, on the other hand, sends a stream to the multicast group address and allows multiple clients to acquire the stream at the same time by requesting a copy from the multicast group address. Therefore,

Dynamic DNS

DDNS (Dynamic Domain Name Server) will hold a DNS host name and synchronize the public IP address of the modem when it has been modified. A user name and password are required when using the DDNS service. After making any changes, click the **Save Settings** button to save your changes.

Enable DDNS: Select this checkbox to enable the DDNS function.

Server Address: Select your Dynamic DNS provider from the pull down menu or enter the server address manually.

Host Name: Enter the host name of the DDNS server.

User Name: Enter the user name or e-mail used to connect to your DDNS account.

Password: Enter the password used to connect to your DDNS server account.

Timeout: Enter the DNS timeout values you wish to use.

Status: Indicates the connection status, which is automatically determined by the system.

The screenshot shows the D-Link DCS-6210 web interface. The top navigation bar includes 'LIVE VIDEO', 'SETUP', 'ADVANCED', 'MAINTENANCE', 'STATUS', and 'HELP'. The 'SETUP' menu is expanded, showing options like 'Setup Wizard', 'Network Setup', 'Dynamic DNS', 'Image Setup', 'Audio and Video', 'Preset', 'Motion Detection', 'Time and Date', 'Event Setup', 'SD Card', and 'Logout'. The 'Dynamic DNS' page is active, displaying a 'DYNAMIC DNS' section with an explanatory text and a 'Sign up for D-Link's Free DDNS service at www.DLinkDDNS.com' link. Below this is the 'DYNAMIC DNS SETTING' section, which includes a checkbox for 'Enable DDNS', a 'Server Address' field with a dropdown menu, 'Host Name', 'User Name', 'Password', 'Verify Password' fields, a 'Timeout' field set to '24' hours, and a 'Status' field set to 'Inactive'. 'Save Settings' and 'Don't Save Settings' buttons are present at the bottom of the settings section. A 'Helpful Hints...' sidebar on the right provides additional information about DDNS.

Image Setup

In this section, you may configure the video image settings for your camera. A preview of the image will be shown in Live Video.

Enable Privacy Mask: The Privacy Mask setting allows you to specify up to 3 rectangular areas on the camera's image to be blocked/excluded from recordings and snapshots.

You may click and drag the mouse cursor over the camera image to draw a mask area. Right clicking on the camera image brings up the following menu options:

Disable All: Disables all mask areas

Enable All: Enables all mask areas

Reset All: Clears all mask areas.

Anti Flicker: If the video flickers, try enabling this setting.

Mirror: This will mirror the image horizontally.

Flip: This will flip the image vertically. When turning Flip on, you may want to consider turning Mirror on as well.

Power Line: Select the frequency used by your power lines to avoid interference or distortion.

White Balance: Use the drop-down box to change white balance settings to help balance colors for different environments. You can choose from Auto, Outdoor, Indoor, Fluorescent, and Push Hold.

D-Link

DCS-6210 // LIVE VIDEO SETUP ADVANCED MAINTENANCE STATUS HELP

IMAGE SETUP
Changes to your IP camera settings are made immediately.

PRIVACY MASK AREA OF VIDEO SETTING

Enable Privacy Mask Setting



- Privacy mask: mask 3 privacy area(s) on video.
- Click the right mouse button on the video control to show the popmenu.
- Press the left mouse button, drag and drop to set the privacy area.
- Privacy area can be enabled or disabled.
- After you finish all privacy mask settings, click the Save button.

Helpful Hints...

Privacy Mask: Click the attached box to activate this function. Now use your mouse to draw a rectangle covering the area you want hidden. Click the box again to deactivate the function.

Anti Flicker: This feature will help to offset the interference of the lighting system and avoid the image flicker issue. ONLY use this option when it is necessary.

Mirror: This function horizontally reverses your images 180 degrees.

Flip: This function vertically reverses your images 180 degrees.

BLC Back Light Compensation: When an object is in front of bright light it is difficult for IP camera to capture the image clearly. Selecting this option can allow objects to become clearer when exposed to bright light.

Power Lines: This setting is used to remove 50/60 Hz flicker.

White Balance: White Balance - Is the process of removing unrealistic color casts, so that objects which appear white in person are rendered white in your photo.

Exposure Mode: Exposure is the total amount of light allowed to fall on the image sensor during the process of

IMAGE SETTINGS

Anti Flicker On Off

Mirror On Off

Flip On Off

BLC On Off

Power Line 60 Hz 50 Hz

White Balance

Exposure Mode Max Gain dB

Denoise

Brightness

Saturation

Sharpness

Exposure Mode: Changes the exposure mode. Use the drop-down box to set the camera for Indoor, Outdoor, or Night environments, or to Moving to capture moving objects. The Low Noise option will focus on creating a high-quality picture without noise. You can also create 3 different custom exposure modes. The Max Gain setting will allow you to control the maximum amount of gain to apply to brighten the picture.

Denoise: This setting controls the amount of noise reduction that will be applied to the picture.

Brightness: Adjust this setting to compensate for backlit subjects.

Saturation: This setting controls the amount of coloration, from grayscale to fully saturated.

Sharpness: Specify a value from 0 to 8 to specify how much sharpening to apply to the image.

Reset Default: Click this button to reset the image to factory default settings.

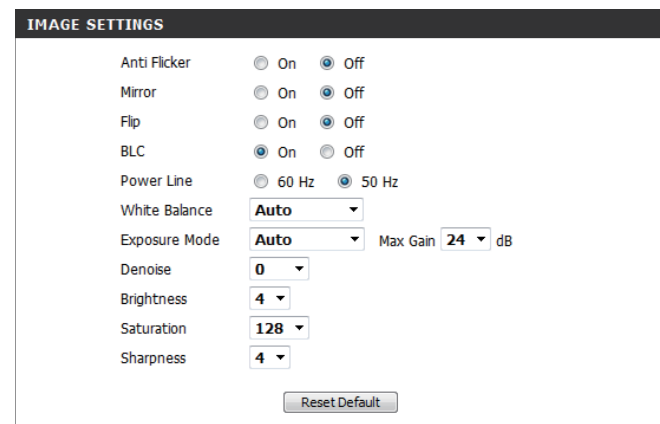

The screenshot displays the 'IMAGE SETTINGS' menu with the following options and values:

Setting	Value
Anti Flicker	<input type="radio"/> On <input checked="" type="radio"/> Off
Mirror	<input type="radio"/> On <input checked="" type="radio"/> Off
Flip	<input type="radio"/> On <input checked="" type="radio"/> Off
BLC	<input checked="" type="radio"/> On <input type="radio"/> Off
Power Line	<input type="radio"/> 60 Hz <input checked="" type="radio"/> 50 Hz
White Balance	Auto
Exposure Mode	Auto
Max Gain	24 dB
Denoise	0
Brightness	4
Saturation	128
Sharpness	4

A 'Reset Default' button is located at the bottom right of the settings panel.

Audio and Video

You may configure up to 3 video profiles with different settings for your camera. Hence, you may set up different profiles for your computer and mobile display. In addition, you may also configure the two-way audio settings for your camera. After making any changes, click the **Save Settings** button to save your changes.

Aspect ratio: Set the aspect ratio of the video to 4:3 standard or 16:9 widescreen.

Mode: Set the video codec to be used to JPEG, MPEG-4, or H.264.

Frame size: Frame size determines the total capture resolution, and View window area determines the Live Video viewing window size. If the Frame size is larger than the Live Video size, you can use the ePTZ controls to look around.

16:9 - 1920 x 1080, 1280 x 720, 800 x 450, 640 x 360,
480 x 270, 320 x 176, 176 x 144

4:3 - 1440 x 1080, 1280 x 960, 1024 x 768, 800 x 600,
640 x 480, 320 x 240, 176 x 144

Note: If your View window area is the same as your Frame size, you will not be able to use the ePTZ function.

Maximum frame rate: A higher frame rate provides smoother motion for videos, and requires more bandwidth. Lower frame rates will result in stuttering motion, and requires less bandwidth.

The screenshot shows the D-Link DCS-6210 web interface. The main navigation tabs are LIVE VIDEO, SETUP, ADVANCED, MAINTENANCE, STATUS, and HELP. The left sidebar contains a menu with options like Setup Wizard, Network Setup, Dynamic DNS, Image Setup, Audio and Video, Preset, Motion Detection, Time and Date, Event Setup, SD Card, and Logout. The main content area is titled 'AUDIO AND VIDEO' and contains the following settings:

- VIDEO SETTINGS:**
 - Number of active profiles: 2
 - Aspect ratio: 4:3 (Warning: Change the aspect ratio will clear the settings of privacy mask and preset and motion detection.)
- VIDEO PROFILE 1:**
 - Mode: H.264
 - Frame size: 800x600
 - View window area: 800x600
 - Maximum frame rate: 15
 - Video quality: Constant bit rate (2M) / Fixed quality (Excellent)
- VIDEO PROFILE 2:**
 - Mode: JPEG
 - Frame size: 640x480
 - View window area: 640x480
 - Maximum frame rate: 25
 - Video quality: Excellent
- AUDIO SETTINGS:**
 - Encoding: 6.711
 - Audio in off:
 - Audio in gain level: 20dB

Buttons for 'Save Settings' and 'Don't Save Settings' are located at the bottom of the configuration area. A 'Helpful Hints...' sidebar on the right provides additional information about frame rates, aspect ratios, and video quality.

Video Quality: This limits the maximum frame rate, which can be combined with the "Fixed quality" option to optimize the bandwidth utilization and video quality. If fixed bandwidth utilization is desired regardless of the video quality, choose "Constant bit rate" and select the desired bandwidth.

Constant bit rate: The bps will affect the bit rate of the video recorded by the camera. Higher bit rates result in higher video quality.

Fixed quality: Select the image quality level for the camera to try to maintain. High quality levels will result in increased bit rates.

Encoding Select the audio encoding codec to fine tune bandwidth usage, storage and recording quality.

Audio in off: Selecting this checkbox will mute incoming audio.

Audio in gain level: This setting controls the amount of gain applied to incoming audio to increase its volume.



Preset

This screen allows you to set preset points for the ePTZ function of the camera, which allows you to look around the camera's viewable area by using a zoomed view. Presets allow you to quickly go to and view a specific part of the area your camera is covering, and you can create preset sequences, which will automatically change the camera's view between the different presets according to a defined order and timing you can set.

Note: If your View window area is the same as your Frame size, you will not be able to use the ePTZ function.

Video Profile: This selects which video profile to use.

ePTZ Speed: You may select a value between 1 and 10. 1 is the slowest and 10 is the fastest.

Arrow Buttons and Home Button: Use these buttons to move to a specific part of the viewing area, which you can then set as a preset. Click the Home button to return to the center of the viewing area.

Input Preset Name: Enter the name of the preset you want to create, then click the **Add** button to make a new preset. If an existing preset has been selected from the Preset List, you can change its name by typing in a new name, then clicking the **Rename** button.

Preset List: Click this drop-down box to see a list of all the presets that have been created. You can select one, then click the **GoTo** button to change the displayed camera view to the preset. Clicking the **Remove** button will delete the currently selected preset.

Preset Sequence: This section allows you to create a preset sequence, which automatically moves the camera's view between a set of preset views.

Preset List: To add a preset to the sequence, select it from the drop-down box at the bottom of this window, set the **Dwell time** to determine how long the camera view will stay at that preset, then click the **Add** button. The preset name will appear in the list, followed by the dwell time to view that preset for.

You can rearrange your presets in the sequence by selecting a preset in the sequence, then clicking the arrow buttons to move it higher or lower in the current sequence.

Clicking the trash can button will remove the currently selected preset from the sequence.

If you want to change the dwell time for a preset, select it from the list, enter a new dwell time, then click the **Update** button.

The screenshot displays two main sections of the configuration interface:

- PRESET:** This section includes an "Input Preset Name" field with an "Add" button and a "Rename" button. Below it is a "Preset List" dropdown menu with a "GoTo" button and a "Remove" button. A red note indicates "Support(0-9,A-Z,a-z,-,*,/,_)".
- PRESET SEQUENCE:** This section shows a "Preset Name : Dwell time" label above a large empty box. To the right of the box are three vertical arrow buttons: an up arrow, a trash can icon, and a down arrow. Below the box is a "Preset List" dropdown menu with an "Add" button, and a "Dwell time : 10" input field with an "Update" button. A red note indicates "Second(s)[3-30]".

Motion Detection

Enabling Video Motion will allow your camera to use the motion detection feature. You may draw a finite motion area that will be used for monitoring. After making any changes, click the **Save Settings** button to save your changes.

Enable Video Motion: Select this box to enable the motion detection feature of your camera.

Sensitivity: Specifies the measurable difference between two sequential images that would indicate motion. Please enter a value between 0 and 100.

Percentage: Specifies the amount of motion in the window being monitored that is required to initiate an alert. If this is set to 100%, motion is detected within the whole window will trigger a snapshot.

Draw Motion Area: Draw the motion detection area by dragging your mouse in the window (indicated by the red square).

Erase Motion Area: To erase a motion detection area, simply click on the red square that you wish to remove.

Right clicking on the camera image brings up the following menu options:

Select All: Draws a motion detection area over the entire screen.

Clear All: Clears any motion detection areas that have been drawn.

Restore: Restores the previously specified motion detection areas.

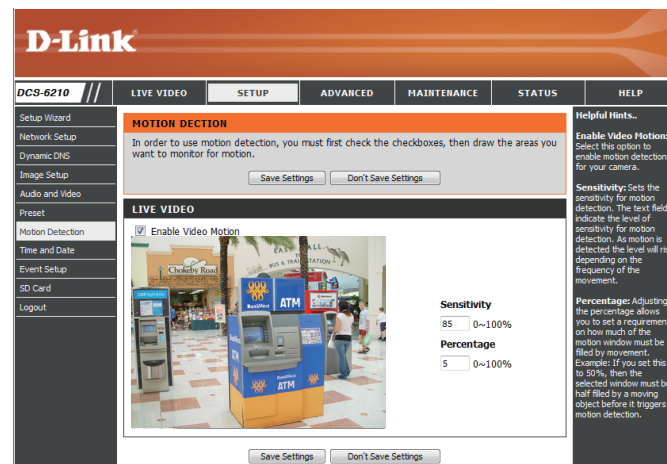

Time and Date

This section allows you to automatically or manually configure, update, and maintain the internal system clock for your camera. After making any changes, click the **Save Settings** button to save your changes.

Time Zone: Select your time zone from the drop-down menu.

Enable Daylight Saving: Select this to enable Daylight Saving Time.

Auto Daylight Saving: Select this option to allow your camera to configure the Daylight Saving settings automatically.

Set Date and Time Manually: Selecting this option allows you to configure the Daylight Saving date and time manually.

Offset: Sets the amount of time to be added or removed when Daylight Saving is enabled.

Synchronize with NTP Server: Enable this feature to obtain time automatically from an NTP server.

NTP Server: Network Time Protocol (NTP) synchronizes the DCS-6210 with an Internet time server. Choose the one that is closest to your location.

Set the Date and Time Manually: This option allows you to set the time and date manually.

Copy Your Computer's Time Settings: This will synchronize the time information from your PC.

D-Link

DCS-6210 // LIVE VIDEO SETUP ADVANCED MAINTENANCE STATUS HELP

TIME AND DATE
You can set the current time for the IP camera.
Save Settings Don't Save Settings

TIME CONFIGURATION

Time Zone (UTC+08:00) Taipei

Enable Daylight Saving

Auto Daylight Saving

Set date and time manually

Offset: +2:00

Start time: Month 5, Week 1, Day of week Sunday, Hour 00, Minutes 00

End time: Month 10, Week 1, Day of week Sunday, Hour 00, Minutes 00

AUTOMATIC TIME CONFIGURATION

Synchronize with NTP Server

NTP Server: ntp.dlink.com.tw << Select NTP Server >>

SET DATE AND TIME MANUALLY

Set date and time manually

Year: 2011, Month: 1, Day: 25, Hour: 23, Minute: 9, Second: 14

Copy Your Computer's Time Settings

Save Settings Don't Save Settings

Helpful Hints...

Good timekeeping is important for accurate logs and scheduled retrieval rules.

Time Zone: Select your time zone from the drop-down menu.

Enable Daylight Saving: Select this to enable the daylight saving time.

Auto Daylight Saving: When you select it, the clock is automatically adjusted according to the daylight saving time of the selected time zone.

Offset: Select the time offset, if your location observes daylight saving time.

Synchronize with NTP Server: With the option selected, the camera will synchronize the time settings with the NTP server over the Internet whenever the camera starts up. If the timeserver cannot be reached, no time settings will be applied.

NTP Server: Network Time Protocol (NTP) synchronizes the IP camera with an Internet time server. Choose the one that is closest to your location.

Copy Your Computer's Time Settings: This will synchronize the time information from your PC.

Event Setup

In a typical application, when motion is detected, the DCS-6210 sends images to a FTP server or via e-mail as notifications. As shown in the illustration below, an event can be triggered by many sources, such as motion detection. When an event is triggered, a specified action will be performed. You can configure the Network Camera to send snapshots or videos to your e-mail address or FTP site.

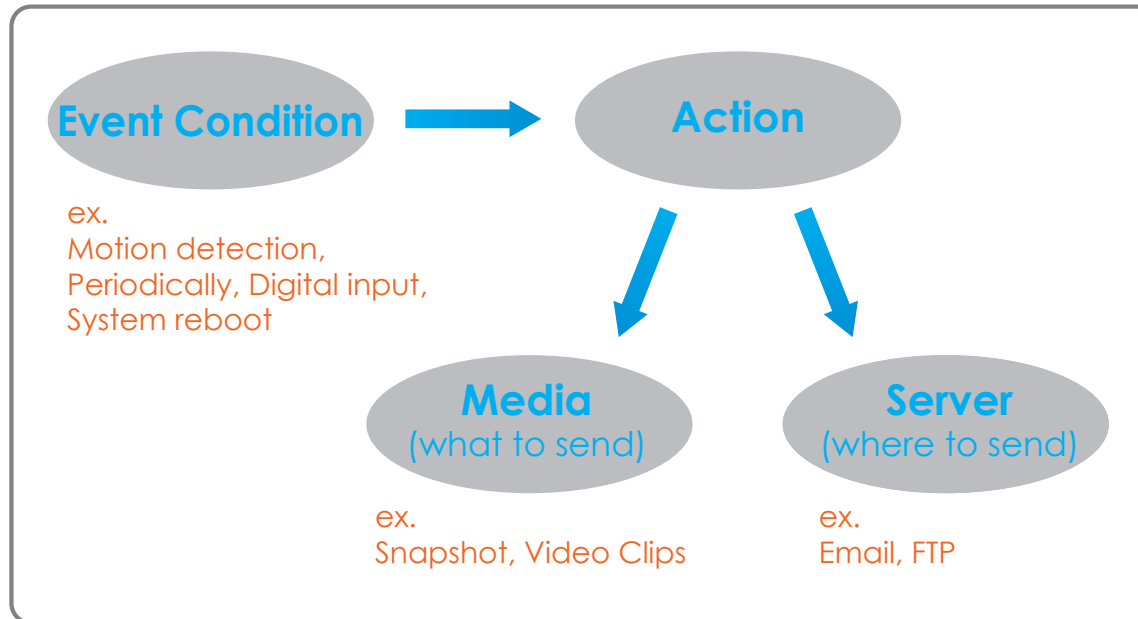

To start plotting an event, it is suggested to configure server and media columns first so that the Network Camera will know what action shall be performed when a trigger is activated.

The Event Setup page includes 4 different sections.

- Event
- Server
- Media
- Recording

1. To add a new item - "event, server or media," click **Add**. A screen will appear and allow you to update the fields accordingly.
2. To delete the selected item from the pull-down menu of event, server or media, click **Delete**.
3. Click on the item name to pop up a window for modifying.

D-Link

DCS-6210 // LIVE VIDEO SETUP ADVANCED MAINTENANCE STATUS HELP

Setup Wizard
Network Setup
Dynamic DNS
Image Setup
Audio and Video
Preset
Motion Detection
Time and Date
Event Setup
SD Card
Logout

EVENT SETUP

There are four sections in Event Setup page. They are event, server, media and recording. Click Add to pop a window to add a new item of event, server, media or recording. Click Delete to delete the selected item from event, server, media or recording. Click on the item name to pop a window to edit it. There can be at most 3 events and 2 recording. There can be at most 5 server and 5 media configurations.

SERVER

Name	Type	Address/Location
Add		Delete

MEDIA

Media freespace: 6700KB

Name	Type	Source
Add		Delete

EVENT

Name	Status	Sun	Mon	Tue	Wed	Thu	Fri	Sat	Time	Trigger
Add										Delete

RECORDING

Name	Status	Sun	Mon	Tue	Wed	Thu	Fri	Sat	Time	Source	Destination
Add											Delete

Helpful Hints...

Suggest setting server and media first before setting event. The servers and media which selected in event list are not able to modify or delete. Please remove them first from the event if you want to delete or modify them. Recommend using different media in different event to make use all media be produced and received correctly. If using the same media in different events and the events trigger almost simultaneously, the servers in the second triggered event will not receive any media; there would be only notifications.

Add Server

You can configure up to 5 servers to save snapshots and/or video to. After making any changes, click the **Save Settings** button to save your changes.

Server Name: Enter the unique name of your server.

E-mail: Enter the configuration for the target e-mail server account.

FTP: Enter the configuration for the target FTP server account.

Network Storage: Specify a network storage device. Only one network storage device is supported.

SD Card: Use the camera's onboard SD card storage.

D-Link

DCS-6210 // LIVE VIDEO SETUP ADVANCED MAINTENANCE STATUS HELP

SERVER

You can set at most 5 different servers here for different event.

[Test] [Save Settings] [Don't Save Settings]

SERVER TYPE

Server Name:

Email

Sender email address

Recipient email address

Server address

User name

Password

Port

This server requires a secure connection (Start TLS)

FTP

Server address

Port

User name

Password

Remote folder name

Passive mode

Network storage

Network storage location

(for example: \\my_nas(disk)/folder)

Workgroup

User name

Password

Primary WINS server

SD Card

[Test] [Save Settings] [Don't Save Settings]

Helpful Hints...

"Server name" The unique name for server. There are four kinds of servers supported. They are email server, FTP server, HTTP server and network storage.

Email server: "Sender email address" The email address of the sender. "Recipient email address" The email address of the recipient.

FTP server: "Remote folder name" Granted folder on the external FTP server. The string must conform to that of the external FTP server. Some FTP servers cannot accept preceding slash symbol before the path without virtual path mapping. Refer to the instructions for the external FTP server for details. The folder privilege must be open for upload. "Passive Mode" Check it to enable passive mode in transmission.

Network storage: Only one network storage is supported. "Network storage location" The path to upload the media. "Workgroup" The workgroup for network storage.

SD card: Use the SD card for recording media.

SECURITY

Add Media

There are three types of media, **Snapshot**, **Video Clip**, and **System Log**. After making any changes, click the **Save Settings** button to save your changes.

Media Name: Enter a unique name for media type you want to create.

Snapshot: Select this option to set the media type to snapshots.

Source: Set the video profile to use as the media source. Refer to **"Audio and Video" on page 37** for more information on video profiles.

Send pre-event image(s) [0~4]: Set the number of pre-event images to take. Pre-event images are images taken before the main event snapshot is taken.

Send post-event image(s) [0~7]: Set the number of post-event images to take. Post-event images are images taken after the main event snapshot is taken. You can set up to 7 post-event images to be taken.

File name prefix: The prefix name will be added on the file name.

Add date and time suffix to file name: Check it to add timing information as file name suffix.

Helpful Hints...
"Media name" The unique name for media. There are three kinds of media. They are snapshot, video clip and system log.
Snapshot:
"Source" The source of profile, profile1 or profile2.
"Send Pre-event images" The number of pre-event images.
"Send Post-event images" The number of post-event images.
"File name prefix" The prefix name will be added on the file name of the snapshot images.
"Add date and time suffix to file name" Check it to add timing information as file name suffix.
Video clip:
"Source" The source of profile, profile1 or profile2.
"Pre-event recording" The interval of pre-event recording in seconds. There are two limitations for video clip file.
"Maximum duration" The maximal recording file duration in seconds.

Video clip: Select this option to set the media type to video clips.

Source: Set the video profile to use as the media source. Refer to "Audio and Video" on page 37 for more information on video profiles.

Pre-event recording: This sets how many seconds to record before the main event video clip starts. You can record up to 4 seconds of pre-event video.

Maximum duration: Set the maximum length of video to record for your video clips.

Maximum file size: Set the maximum file size to record for your video clips.

File name prefix: This is the prefix that will be added to the filename of saved video clips.

System log: Select this option to set the media type to system logs. This will save the event to the camera system log, but will not record any snapshots or video.

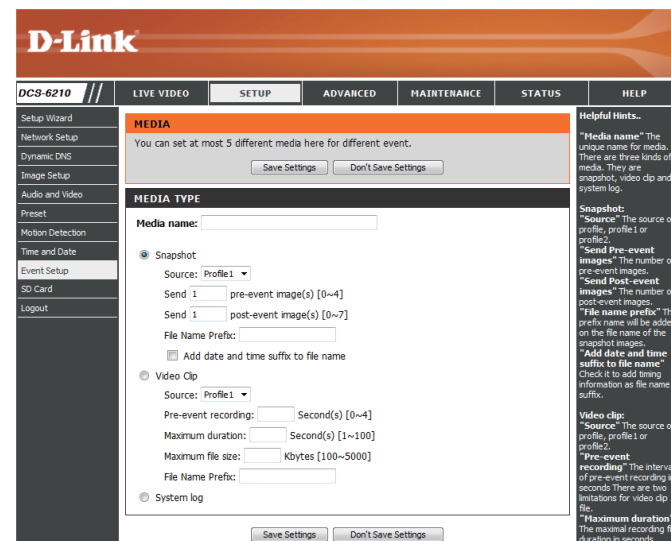

Add Event

Create and schedule up to 2 events with their own settings here. After making any changes, click the **Save Settings** button to save your changes.

Event name: Enter a name for the event.

Enable this event: Select this box to activate this event.

Priority: Set the priority for this event. The event with higher priority will be executed first.

Delay: Select the delay time before checking the next event. It is being used for both events of motion detection and digital input trigger.

Trigger: Specify the input type that triggers the event.

Video Motion Detection: Motion is detected during live video monitoring. Select the windows that need to be monitored.

Periodic: The event is triggered in specified intervals. The trigger interval unit is in minutes.

System Boot: Triggers an event when the system boots up.

Network Lost: Triggers an event when the network connection is lost.

Time: Select **Always** or enter the time interval.

Add Recording

Here you can configure and schedule the recording settings. After making any changes, click the **Save Settings** button to save your changes.

Recording entry name: The unique name of the entry.

Enable this recording: Select this to enable the recording function.

Priority: Set the priority for this entry. The entry with a higher priority value will be executed first.

Source: The source of the stream.

Recording schedule: Scheduling the recording entry.

Recording settings: Configuring the setting for the recording.

Destination: Select the folder where the recording file will be stored.

Total cycling recording size: Please input a HDD volume between 1MB and 2TB for recording space. The recording data will replace the oldest record when the total recording size exceeds this value. For example, if each recording file is 6MB, and the total cyclical recording size is 600MB, then the camera will record 100 files in the specified location (folder) and then will delete the oldest file and create new file for cyclical recording.

Please note that if the free HDD space is not enough, the recording will stop. Before you set up this option please make sure your HDD has enough space, and it is better to not save other files in the same folder as recording files.

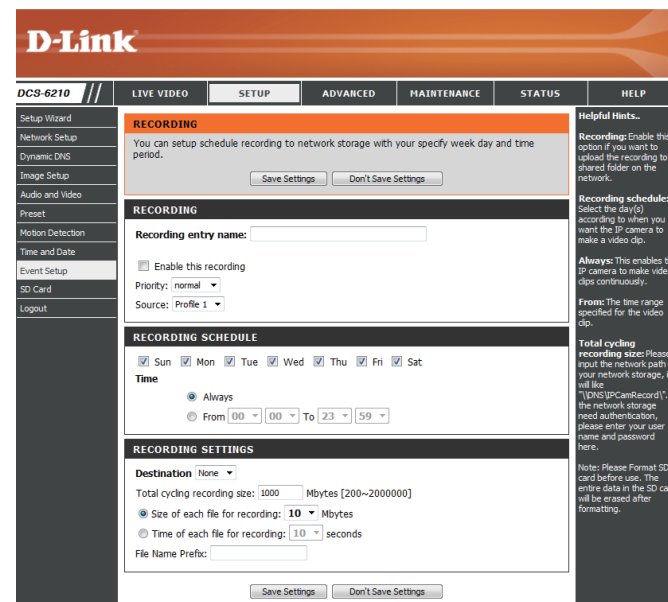

Size of each file for recording: If this is selected, files will be separated based on the file size you specify.

Time of each file for recording: If this is selected, files will be separated based on the maximum length you specify.

File Name Prefix: The prefix name will be added on the file name of the recording file(s).

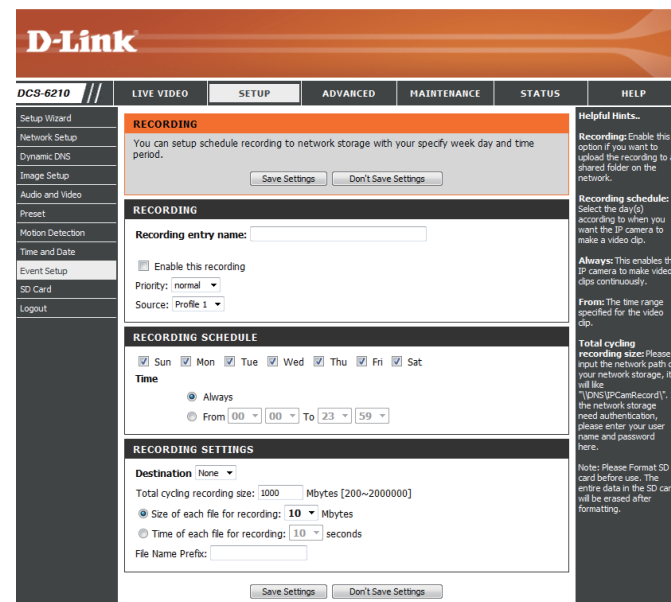

SD Card

Here you may browse and manage the recorded files which are stored on the SD card.

Format SD Card: Click this icon to automatically format the SD card and create "picture" & "video" folders.

View Recorded Picture: If the picture files are stored on the SD card, click on the picture folder and choose the picture file you would like to view.

Playback Recorded Video: If video files are stored on the SD card, click on the video folder and choose the video file you would like to view.

Refresh: Reloads the file and folder information from the SD card.

The screenshot shows the D-Link DCS-6210 web interface. The main content area is titled "SD CARD" and contains the following information:

SD Card: / SD Status: Ready

Files per Page: 10 Refresh 1 of 1

Delete	File	Num of files	Size
<input type="checkbox"/>	Video	3	
<input type="checkbox"/>	Picture	0	

Format SD Card Total:1976528KB, Used:1976528KB, Free:0KB

OK

The sidebar on the right contains "Helpful Hints..." with instructions on how to format the SD card, view recorded pictures, and playback recorded videos.

HTTPS

This page allows you to install and activate an HTTPS certificate for secure access to your camera. After making any changes, click the **Save Settings** button to save your changes.

Enable HTTPS Secure Connection: Enable the HTTPS service.

Create Certificate Method: Choose the way the certificate should be created. Three options are available:

Create a self-signed certificate automatically
Create a self-signed certificate manually
Create a certificate request and install

Status: Displays the status of the certificate.

Note: The certificate cannot be removed while the HTTPS is still enabled. To remove the certificate, you must first uncheck **Enable HTTPS secure connection**.

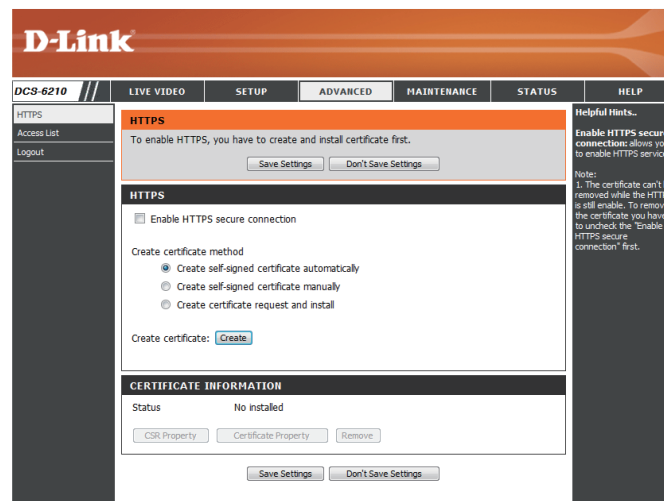

Access List

Here you can set access permissions for users to view your DCS-6210.

Allow list: The list of IP addresses that have the access right to the camera.

Start IP address: The starting IP Address of the devices (such as a computer) that have permission to access the video of the camera. Click **Add** to save the changes made.

Note: A total of seven lists can be configured for both columns.

End IP address: The ending IP Address of the devices (such as a computer) that have permission to access the video of the camera.

Delete allow list: Remove the customized setting from the Allow List.

Deny list: The list of IP addresses that have no access rights to the camera.

Delete deny list: Remove the customized setting from the Delete List.

For example:

When the range of the Allowed List is set from 1.1.1.0 to 192.255.255.255 and the range of the Denied List is set from 1.1.1.0 to 170.255.255.255. Only users with IPs located between 171.0.0.0 and 192.255.255.255 can access the Network Camera.

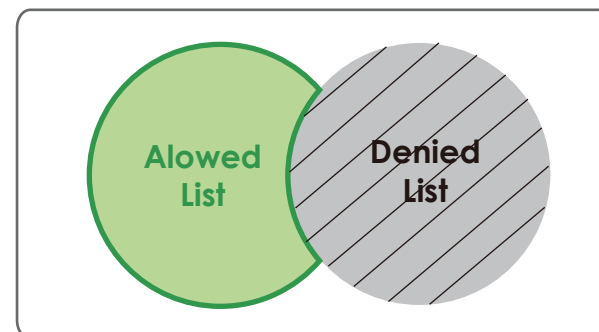
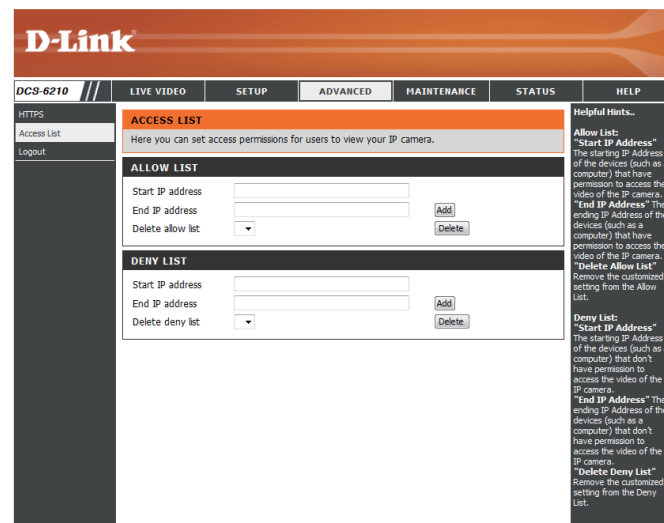

Maintenance

Device Management

You may modify the name and administrator's password of your camera, as well as add and manage the user accounts for accessing the camera. You may also use this section to create a unique name and configure the OSD settings for your camera.

Admin Password Setting: Set a new password for the administrator's account.

Add User Account: Add new user account.

User Name: The user name for the new account.

Password: The password for the new account.

User List: All the existing user accounts will be displayed here. You may delete accounts included in the list, but you may want to reserve at least one as a guest account.

Camera Name: Create a unique name for your camera that will be added to the file name prefix when creating a snapshot or a video clip.

Enable OSD: Select this option to enable the On-Screen Display feature for your camera.

Label: Enter a label for the camera, which will be shown on the OSD when it is enabled.

Show Time: Select this option to enable the time-stamp display on the video screen.

The screenshot shows the D-Link web interface for the DCS-6210 camera. The 'MAINTENANCE' tab is selected in the top navigation bar. The 'ADMIN' section is active, showing the following options:

- ADMIN PASSWORD SETTING:** Fields for 'New Password' (63 characters maximum) and 'Retype Password' (63 characters maximum) with a 'Save' button.
- ADD USER ACCOUNT:** Fields for 'User Name' (20 users maximum), 'New Password' (63 characters maximum), and 'Retype Password' (63 characters maximum) with an 'Add' button.
- USER LIST:** A dropdown menu for 'User Name' and a 'Delete' button.
- DEVICE SETTING:** Fields for 'IP camera Name' (DCS-6210, 63 characters maximum), 'Label' (DCS-6210, 63 characters maximum), and 'Show time' (checked) with a 'Save' button.

On the right side, there is a 'Helpful Hints...' section with text: 'Enabling OSD, the IP camera name and time will be displayed on the video screen for the user. For security purposes, it is recommended that you change the password for your administrator account. Be sure to write down the new password to avoid having to reset the IP camera in the event that it is forgotten.'

System

In this section, you may backup, restore and reset the camera configuration, or reboot the camera.

Save To Local Hard Drive: You may save your current camera configuration as a file on your computer.

Local From Local Hard Drive: Locate a pre-saved configuration by clicking **Browse** and then restore the pre-defined settings to your camera by clicking **Load Configuration**.

Restore to Factory Default: You may reset your camera and restore the factory settings by clicking **Restore Factory Defaults**.

Reboot Device: This will restart your camera.

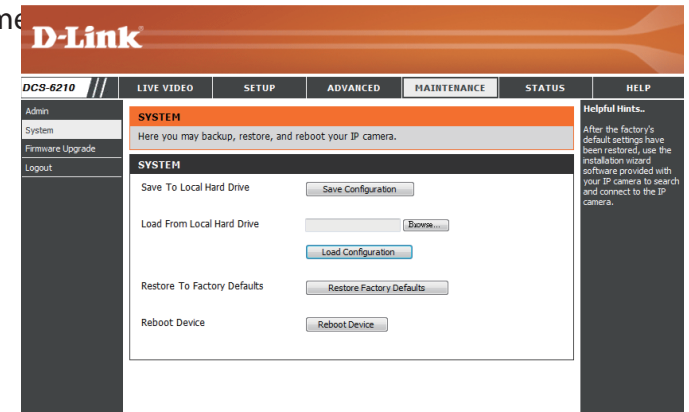

Firmware Upgrade

The camera's current firmware version will be displayed on this screen. You may visit the D-Link Support Website to check for the latest available firmware version.

To upgrade the firmware on your DCS-6210, please download and save the latest firmware version from the D-Link Support Page to your local hard drive. Locate the file on your local hard drive by clicking the **Browse** button. Select the file and click the **Upload** button to start upgrading the firmware.

Current Firmware Version: Displays the detected firmware version.

Current Product Name: Displays the camera model name.

File Path: Locate the file (upgraded firmware) on your hard drive by clicking **Browse**.

Upload: Uploads the new firmware to your camera.

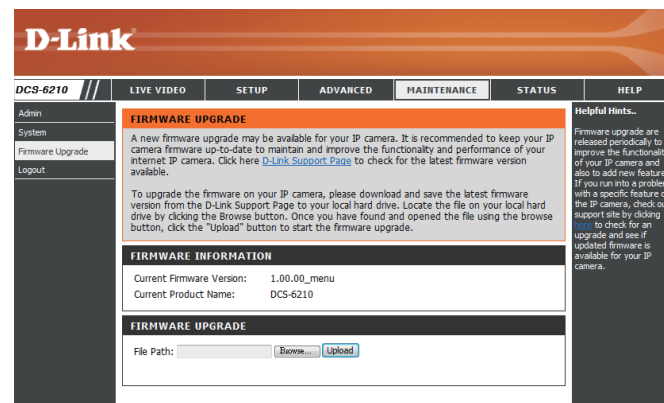

Status

Device Info

This page displays detailed information about your device and network connection.

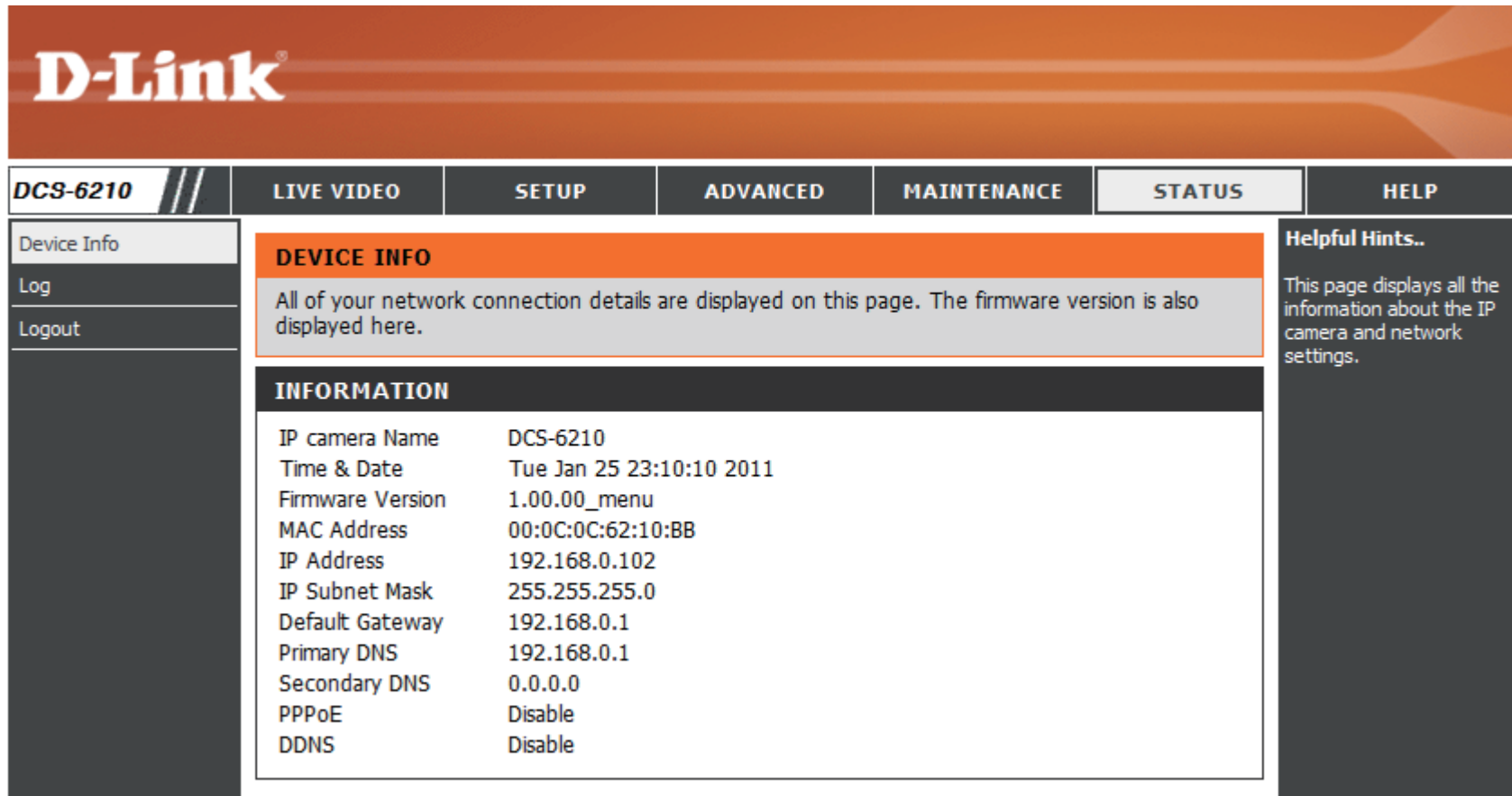

D-Link

DCS-6210 // LIVE VIDEO SETUP ADVANCED MAINTENANCE STATUS HELP

Device Info
Log
Logout

DEVICE INFO

All of your network connection details are displayed on this page. The firmware version is also displayed here.

INFORMATION

IP camera Name	DCS-6210
Time & Date	Tue Jan 25 23:10:10 2011
Firmware Version	1.00.00_menu
MAC Address	00:0C:0C:62:10:BB
IP Address	192.168.0.102
IP Subnet Mask	255.255.255.0
Default Gateway	192.168.0.1
Primary DNS	192.168.0.1
Secondary DNS	0.0.0.0
PPPoE	Disable
DDNS	Disable

Helpful Hints..

This page displays all the information about the IP camera and network settings.

Logs

This page displays the log information of your camera. You may download the information by clicking **Download**. You may also click **Clear** to delete the saved log information.

D-Link

DCS-6210 // LIVE VIDEO SETUP ADVANCED MAINTENANCE STATUS HELP

Device Info
Log
Logout

SYSTEM LOG
The system log records IP camera events that have occurred.

CURRENT LOG

1. 2011-01-25 23:06:28 admin LOGIN OK FROM 192.168.0.100
2. 2011-01-25 21:35:00 IP CAMERA ACQUIRE DHCP IP 192.168.0.102
3. 2011-01-25 21:34:59 NETWORK RECONNECT
4. 2011-01-25 21:13:37 NETWORK LOSS
5. 2011-01-25 21:13:36 SYSTEM BOOTING
6. 2011-01-25 03:29:29 admin LOGIN OK FROM 192.168.0.100
7. 2011-01-25 03:29:20 SD CARD INITIALIZES FAILED
8. 2011-01-25 01:33:11 admin LOGIN OK FROM 192.168.0.100
9. 2011-01-25 01:30:45 IP CAMERA ACQUIRE DHCP IP 192.168.0.102
10. 2011-01-25 01:30:44 NETWORK RECONNECT
11. 2011-01-22 00:38:27 NETWORK LOSS
12. 2011-01-21 19:57:18 admin LOGIN OK FROM 192.168.0.100
13. 2011-01-14 23:18:46 admin LOGIN OK FROM 192.168.0.100
14. 2011-01-14 23:17:37 IP CAMERA ACQUIRE DHCP IP 192.168.0.102
15. 2011-01-14 23:17:34 SYSTEM BOOTING
16. 2011-01-14 23:05:44 admin LOGIN OK FROM 192.168.0.100
17. 2011-01-12 02:22:09 admin FROM 192.168.0.100 SET VIDEO CODEC Need Reset
18. 2011-01-12 02:22:09 admin FROM 192.168.0.100 SET PROFILE 1 Viewer window area 800x600
19. 2011-01-12 02:22:09 admin FROM 192.168.0.100 SET PROFILE 1 Frame Size 800x600
20. 2011-01-12 02:21:55 admin FROM 192.168.0.100 SET VIDEO CODEC Need Reset

Helpful Hints..
You can save the log to your local hard IP camera by clicking the Download button, and you can clear the log by clicking on the Clear button.

First Page Previous 20 Next 20

Help

This page provides helpful information regarding camera operation.

The screenshot shows the D-Link DCS-6210 web interface. At the top is the D-Link logo. Below it is a navigation bar with tabs for LIVE VIDEO, SETUP, ADVANCED, MAINTENANCE, STATUS, and HELP. The HELP tab is selected. On the left is a sidebar with 'Help' and 'Logout' links. The main content area is titled 'HELP' and contains a list of links for each menu item: LIVE VIDEO (Camera), SETUP (Setup Wizard, Network Setup, Dynamic DNS, Image Setup, Audio and Video, Preset, Motion Detection, Time and Date, Event Setup, SD Card), ADVANCED (HTTPS, Access List), MAINTENANCE (Admin, System, Firmware Upgrade), and STATUS (Device Info, Log). At the bottom of the page is a 'SECURITY' section.

Technical Specifications

Camera		
Camera Hardware Profile	<ul style="list-style-type: none"> • 1/2.7" 2 Megapixel progressive CMOS sensor • Fixed Lens, focal length 4.3 mm, aperture F2.0 • 10x digital zoom 	<ul style="list-style-type: none"> • Angle of view: <ul style="list-style-type: none"> • (H) 79 ° • (V) 43 ° • (D) 90 °
Camera Housing	<ul style="list-style-type: none"> • IP-66 weather-proof compliant 	<ul style="list-style-type: none"> • IK-10 vandal-proof compliant
Image Features	<ul style="list-style-type: none"> • Configurable image size, quality, frame rate, and bit rate • Time stamp and text overlays • Configurable motion detection windows 	<ul style="list-style-type: none"> • Configurable privacy mask zones • Configurable white balance, brightness, saturation, contrast, sharpness, and BLC
Video Compression	<ul style="list-style-type: none"> • Simultaneous H.264/MPEG-4/MJPEG format compression • H.264/MPEG-4 multicast streaming 	<ul style="list-style-type: none"> • JPEG for still images
Video Resolution	<ul style="list-style-type: none"> • 16:9 - 1920 x 1080 (upto 15 fps) 1280 x 800, 1280 x 720, 800 x 450, 640 x 360, 480 x 270, 320 x 176, 176 x 144 up to 30 fps recording1 	<ul style="list-style-type: none"> • 4:3 - 1440 x 1080 (up to 25 fps) 1024 x 768, 800 x 600, 640 x 480, 480 x 360, 320 x 240, 176 x 144 up to 30 fps recording1
Audio Support	<ul style="list-style-type: none"> • G.726 	<ul style="list-style-type: none"> • G.711
External Device Interfaces	<ul style="list-style-type: none"> • 10/100 BASE-TX Fast Ethernet port • Supports 802.3af PoE 	<ul style="list-style-type: none"> • MicroSD/SDHC card slot
Network		
Network Protocols	<ul style="list-style-type: none"> • IPv6 • IPv4 • TCP/IP • UDP • ICMP • DHCP client • NTP client (D-Link) • DNS client • DDNS client (D-Link) • SMTP client • FTP client 	<ul style="list-style-type: none"> • HTTP / HTTPS • Samba client • PPPoE • UPnP port forwarding • RTP / RTSP/ RTCP • IP filtering • QoS • CoS • Multicast • IGMP • ONVIF compliant
Security	<ul style="list-style-type: none"> • Administrator and user group protection • Password authentication 	<ul style="list-style-type: none"> • HTTP and RTSP digest encryption

Appendix A: Technical Specifications

System Management		
System Requirements for Web Interface	<ul style="list-style-type: none"> • Browser: Internet Explorer, Firefox, Safari, Chrome 	
Event Management	<ul style="list-style-type: none"> • Motion detection • Event notification and uploading of snapshots/video clips via e-mail or FTP 	<ul style="list-style-type: none"> • Supports multiple SMTP and FTP servers • Multiple event notifications • Multiple recording methods for easy backup
Remote Management	<ul style="list-style-type: none"> • Take snapshots/video clips and save to local hard drive or NAS via web browser 	<ul style="list-style-type: none"> • Configuration interface accessible via web browser
D-ViewCam™ System Requirements	<ul style="list-style-type: none"> • Operating System: Microsoft Windows 7/Vista/XP • Web Browser: Internet Explorer 7 or higher 	<ul style="list-style-type: none"> • Protocol: Standard TCP/IP
D-ViewCam™ Software Functions	<ul style="list-style-type: none"> • Remote management/control of up to 32 cameras • Viewing of up to 32 cameras on one screen • Scheduled motion triggered, or manual recording options 	<ul style="list-style-type: none"> • Supports all management functions in web interface
Physical		
Weight	<ul style="list-style-type: none"> • 412.2 g ± 5% 	
Power Consumption	<ul style="list-style-type: none"> • 8.6 watts ± 5% 	
Temperature	<ul style="list-style-type: none"> • Operating: -25 to 50 °C (-22 to 122 °F) 	<ul style="list-style-type: none"> • Storage: -20 to 70 °C (-4 to 158 °F)
Humidity	<ul style="list-style-type: none"> • Operating: 20% to 80% non-condensing 	<ul style="list-style-type: none"> • Storage: 5% to 95% non-condensing
Certifications	<ul style="list-style-type: none"> • CE • CE LVD 	<ul style="list-style-type: none"> • FCC • C-Tick
Dimensions	<p>The image contains two technical drawings of the D-ViewCam camera. The left drawing is a side view showing a height of 96.09 mm, a top width of 51.59 mm, and a bottom width of 22.64 mm. The right drawing is a front view showing a top width of 115.52 mm and a height of 106.75 mm. The front view also shows a central lens and two screws on the sides.</p>	

Safety Statements

CE Mark Warning:

This is a Class B product. In a domestic environment, this product may cause radio interference, in which case the user may be required to take adequate measures.

FCC Statement:

This equipment has been tested and found to comply with the limits for a Class B digital device, pursuant to part 15 of the FCC Rules. These limits are designed to provide reasonable protection against harmful interference in a residential installation. This equipment generates, uses, and can radiate radio frequency energy and, if not installed and used in accordance with the instructions, may cause harmful interference to radio communication. However, there is no guarantee that interference will not occur in a particular installation. If this equipment does cause harmful interference to radio or television reception, which can be determined by turning the equipment off and on, the user is encouraged to try to correct the interference by one or more of the following measures:

- Reorient or relocate the receiving antenna.
- Increase the separation between the equipment and receiver.
- Connect the equipment into an outlet on a circuit different from that to which the receiver is connected.
- Consult the dealer or an experienced radio/TV technician for help.

FCC Caution:

Any changes or modifications not expressly approved by the party responsible for compliance could void the user's authority to operate this equipment.

This device complies with Part 15 of the FCC Rules. Operation is subject to the following two conditions:

(1) This device may not cause harmful interference, and (2) this device must accept any interference received, including interference that may cause undesired operation.

IMPORTANT NOTICE:

FCC Radiation Exposure Statement:

This equipment complies with FCC radiation exposure limits set forth for an uncontrolled environment. This equipment should be installed and operated with minimum distance 20cm between the radiator & your body. This transmitter must not be co-located or operating in conjunction with any other antenna or transmitter.

The availability of some specific channels and/or operational frequency bands are country dependent and are firmware programmed at the factory to match the intended destination. The firmware setting is not accessible by the end user.

For detailed warranty information applicable to products purchased outside the United States, please contact the corresponding local D-Link office.

Industry Canada Notice:

This device complies with RSS-210 of the Industry Canada Rules. Operation is subject to the following two conditions:

(1) This device may not cause harmful interference, and (2) this device must accept any interference received, including interference that may cause undesired operation.

IMPORTANT NOTE:

Radiation Exposure Statement:

This equipment complies with IC radiation exposure limits set forth for an uncontrolled environment. This equipment should be installed and operated with minimum distance 20cm between the radiator & your body.