

D-Link[®]

1000BASE-TX to 1000BASE-SX/LX Media Converter

User's Guide



RECYCLABLE

19071001TSC6002
Rev.1.00

TABLE OF CONTENTS

TABLE OF CONTENTS	2
INTRODUCTION.....	3
ABOUT MEDIA CONVERTER	3
PRODUCT FEATURES	4
INSTALLATION	5
SELECTING A SITE FOR THE EQUIPMENT	5
CONNECTING TO POWER.....	5
INSTALLING IN A CHASSIS	5
MONITORING THE CONVERTER THROUGH MANAGEMENT MODULE	6
LED INDICATOR.....	7
LINK PASS THROUGH FUNCTION	7
SWITCH	9
SPECIFICATIONS	10

INTRODUCTION

Thank you for choosing the 1000Base Gigabit Ethernet Media Converter, The Converter introduced here provides one channel media conversion between 1000BASE-TX and 1000BASE-FX.

About Media Converter

Media Converter is a network technology specified by IEEE 802.3ab and IEEE 802.3z 1000BASE-TX/FX standards.

PRODUCT FEATURES

- Hot-swappable when used with a chassis
- One-channel media conversion between 1000BASE-TX and 1000BASE-FX
- Fiber media allows: multi-mode fiber and single-mode fiber using SC connector
- Link Pass Through function
- Auto negotiation of duplex mode on TX port
- Auto MDI/MDI-X for TX port
- Full wire-speed forwarding rate
- Front panel status LEDs
- Used as a stand-alone device or with a chassis
- Hot-swappable when used with a chassis

INSTALLATION

This chapter gives step-by-step installation instructions for the Converter.

Selecting a Site for the Equipment

As with any electric device, you should place the equipment where it will not be subjected to extreme temperatures, humidity, or electromagnetic interference. Specifically, the site you select should meet the following requirements:

1. The ambient temperature should be between 32 and 104 degrees Fahrenheit (0 to 40 degrees Celsius).
2. The relative humidity should be less than 90 percent, non-condensing.
3. Surrounding electrical devices should not exceed the electromagnetic field (RFC) standards for IEC 801-3, Level 2 (3V/M) field strength.
4. Make sure that the equipment receives adequate ventilation. Do not block the ventilation holes on each side of the switch or the fan exhaust port on the side or rear of the equipment.
5. The power outlet should be within 1.8 meters of the switch.

Connecting to Power

1. This Converter is a plug-and-play device.
2. Connect the supplied AC to DC power adaptor with a power voltage of 7.5Vdc/1.5Amp to the DC-Jack on the converter, and then attach the plug into a standard AC outlet.

Installing in a Chassis

The Converter can be fit into any of the expansion slots on a special designed chassis.

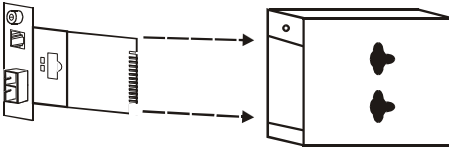

- First, install the converter onto a carrier supplied with the chassis:

Step 1- Unscrew and pull out the media converter board.

Step 2- Plug in the media board to any of the vacant slot.

Step 3- Fit the converter onto the carrier and use the screw to secure it.

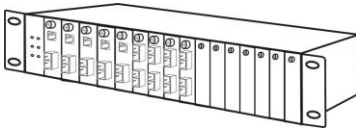

Monitoring the Converter through Management Module

There is a **management module** that can control this media converter through the **chassis system**, this media converter can be controlled through Web Browser, SNMP and terminal emulation program.

The **management module** will detect the default reset on the DIP switches and display out the status, also the **management module** can control the function through the **chassis system**.

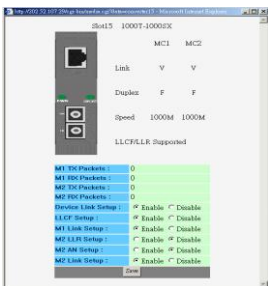

NOTE: To control the function in a working station, need to collocate together with optional Chassis System and Management Module.

LED Indicator

The LED indicators give you instant feedback on status of the converter:

PWR   LINK/ACT

LEDs	State	Indication
Power (PWR)	Lights on	Power on
	Lights off	Power off
Link and Activity (LINK/ACT)	Lights on	Linking
	Lights Blinking	Data transmitting and receiving
	Lights off	Not Linking

Link Pass Through Function

LLCF (Link Loss Carry Forward)

When a device connected to the converter and the TP line loss the link, the converter's fiber will disconnect the link of transmit, so that the other ends will know that there is a linkage error on this end. And when the Fiber line loss the link, the converter's TP will disconnected, and the other end will know that there is linkage problem exist.

There is a default LLCF setting on this converter.

The table below shows how LLCF function is working:

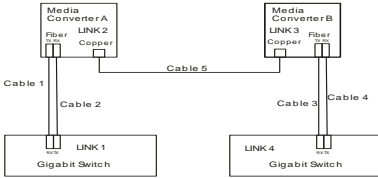

Link Status	Link 1	Link 2	Link 3	Link 4
Disconnect				
Cable 1	Off	On	On	On
Cable 2	Off	Off	Off	Off
Cable 3	On	On	On	Off
Cable 4	Off	Off	Off	Off
Cable 5	Off	Off	Off	Off

LLR (Link Loss Return)

When a device connected to the converter and the fiber line loss the link, the converter's fiber will disconnect the link of transmit.

There is a switch to enable or disable the function of the media converter.

The table below shows how LLR function is working:

Media Converter	LLR	Auto-Negotiation
A	ON	OFF
B	OFF	OFF

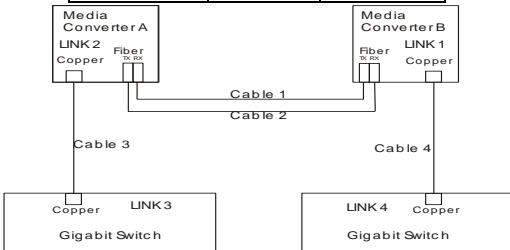

Link Status	Link 1	Link 2	Link 3	Link 4
Disconnect				
Cable 1	Off	Off	Off	Off
Cable 2	Off	On	On	Off
Cable 3	Off	Off	Off	Off
Cable 4	Off	Off	Off	Off

NOTE: If connecting two converters with LLR function in both end, it is recommended that the monitor end converter had to turn off the LLR function, and turn on the LLR function of the remote end converter.

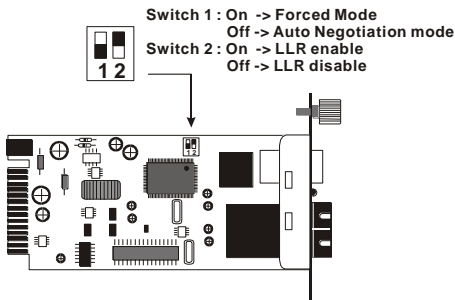

Switch

There is a two pin DIP switch on the module which define as switch 1 and switch 2:

Switch 1: Fiber mode switch

When the switch was turned to “On”, it means that the fiber was turned to forced mode, and “Off” for auto-negotiation mode.

Note: Be sure the opposite end is using the same setting (forced or Auto-negotiation). And when using two converters at the same time, the two converters MUST set to forced mode.

Switch 2: LLR

When the switch was turned to “On”, it means that the LLR was enabled and “Off” for disabled.

Note: When using two converters, don't enable the both device's LLR function at the same time.

SPECIFICATIONS

Standards:	IEEE802.3ab 1000BASE-TX IEEE802.3z 1000BASE-SX/LX
Data Transfer Rate:	1488000pps for 1000Mbps
Duplex Mode:	Full Duplex Mode
LED indicators:	PWR, LNK/ACT
Cable	1000BASE-T -- 4 pair Cat. 5, EIA/TIA-568 100-ohm screened twisted-pair (STP), up to 100m 1000BASE-SX -- 62.5/125 μ m multi-mode fiber optic cable, up to 220m 50/125 μ m multi-mode fiber optic cable, up to 550m 1000BASE-LX -- 62.5/125 μ m multi-mode fiber optic cable, up to 550m 10/125 μ m single-mode fiber optic cable, DMC-810SC up to 10km DMC-880SC up to 80km
Dimensions	L120 x W88 x H25 mm
Weight	305 g
Power	External power adaptor 7.5V 1.5A
Media Interface:	RJ-45, SC
EMI Compatibility:	FCC Class B CE Certification, Class B VCCI Class B
Temperature:	Storage: -10°C ~ 70°C Operating: 0°C ~ 40°C
Humidity:	10% ~90% non-condensing
Power Consumption:	5.5 Watts (maximum)