

D-Link[®]
Building Networks for People

Quick Installation Guide AirPremier N PoE Access Point

This document will guide you through the basic installation process for your new D-Link Wireless N Access Point.

DAP-2360



Quick Installation Guide
Installationsanleitung
Guide d'installation
Guía de instalación
Guida di Installazione

Documentation also available on
CD and via the D-Link Website

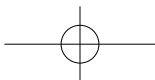

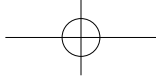

DAP-2360 Quick Install Guide

This installation guide provides basic instructions for installing the DAP-2360 Wireless Access Point on your network. For additional information about how to use the Access Point, please see the User's Manual which is available on the CD included in this package or from the D-Link support website.

System Requirements

Minimum System Requirements:

- CD-ROM Drive
- Computers with Windows®, Macintosh®, or Linux-based operating systems
- Installed Ethernet Adapter
- Internet Explorer version 7.0 or Firefox 3.0 and above

1. Package Contents

- DAP-2360 802.11n Access Point
- Manual and Software on CD-ROM
- Power Adapter
- Mounting Plate
- Ethernet Cable

If any of the above items are missing, please contact your reseller.

Safety Notice:

Installation and servicing should be done by certified technicians so as to conform to all local codes and prevent voiding your warranty.

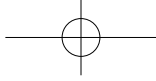

2. Hardware Overview

LAN - Solid light when the Ethernet port is connected to a working port, such as a router or switch. The light will blink when there is traffic through LAN port.

2.4 GHz - When lit, the access point is operating at 2.4GHz. This light will blink when there is wireless traffic.

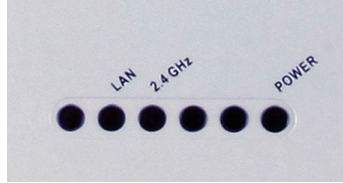

POWER - The light will blink during boot up. Once solid, the access point is ready.

3. Hardware Installation

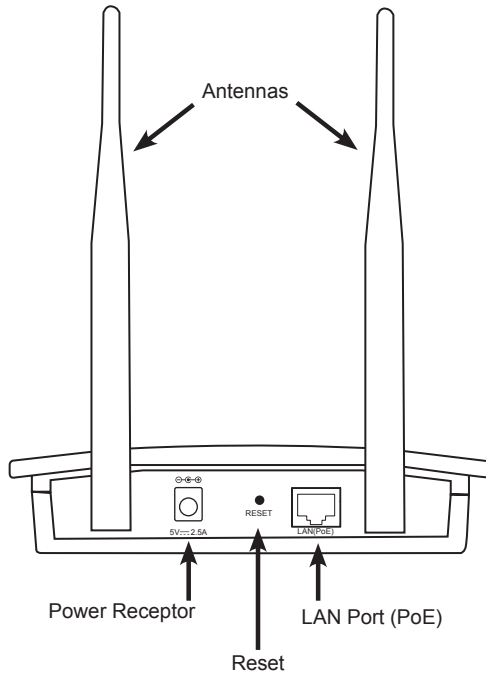

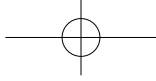

To power the access point, you can use one of the following methods:

1. Use the supplied power adapter
2. Connect one end of your Ethernet cable into the LAN (PoE) port on the DAP-2360 and the other end into one port on a PoE switch.

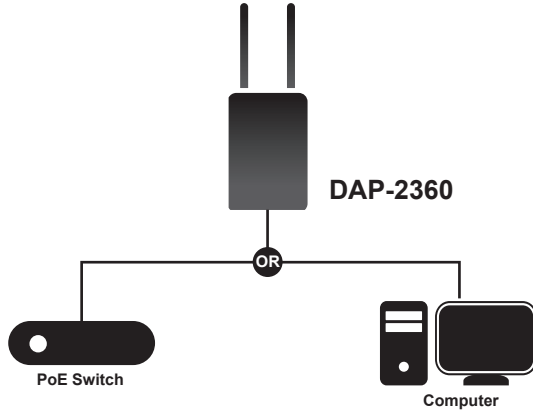

To setup and manage the DAP-2360 from a computer, use one of the following methods:

1. Connect a straight through Ethernet cable between the access point and your computer.
2. Connect the access point to a switch or router and use a computer from a computer that is also connected to that switch or router.
3. Please start your web browser program, type the IP address of the device (<http://192.168.0.50>) and press Enter. Make sure that the IP addresses of the device and your computer are in the same subnet. Then, refer to the Manual for configuration.

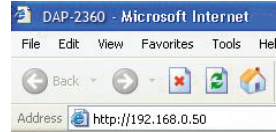

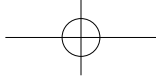

4. Mounting Plate Assembly

Step 1: Insert provided wall anchors in the wall where the mounting plate will be attached.

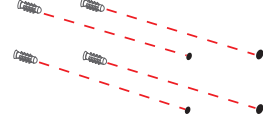

Step 2: Use the provided screws to secure the mounting plate on the wall.

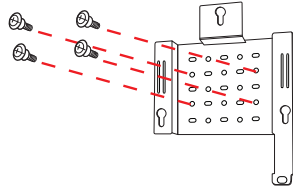

Step 3: Attach the remaining screws securely to the back of the DAP-2360.

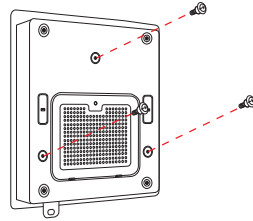

Step 4: Attach the DAP-2360 to the mounting plate.

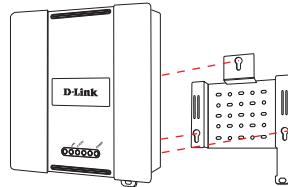

Step 5: Slide the DAP-2360 down into the grooves on the mounting plate to secure it to the plate.

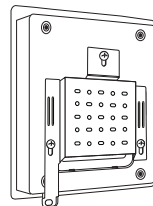

5. Your Setup is Complete

When you have completed the steps in this Installation Guide and configured your for your network, your network should look similar to this:

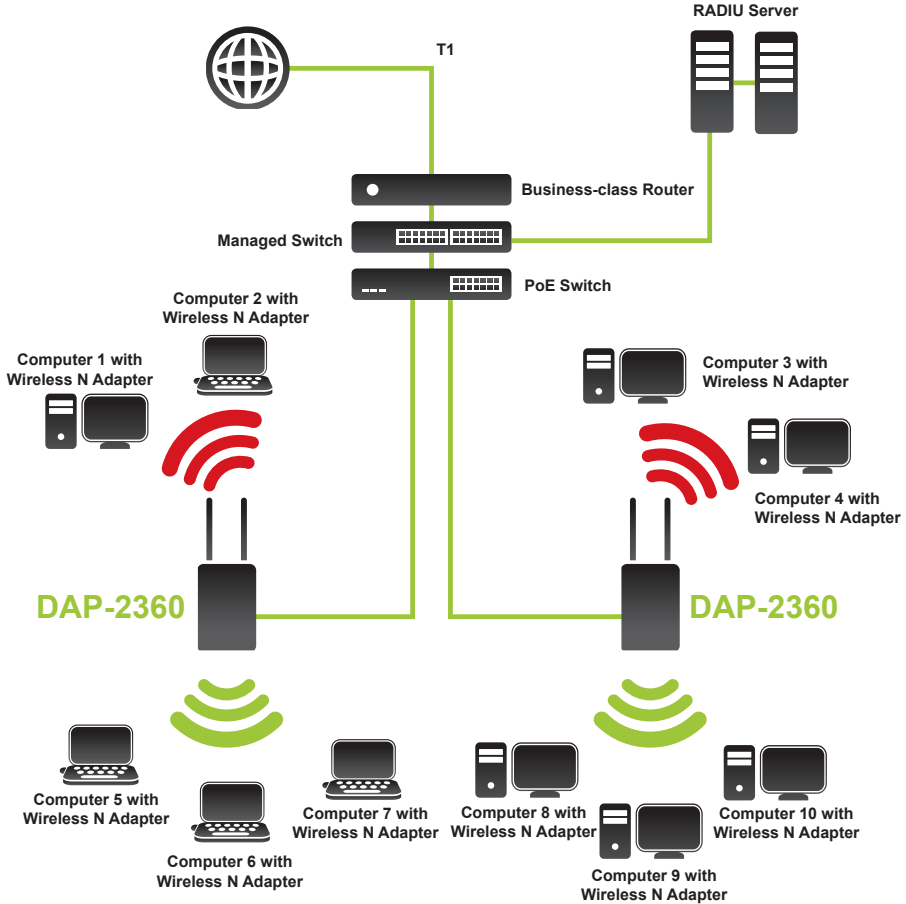

* Maximum Wireless signal rate derived from IEEE 802.11n specifications. Actual data throughput will vary. Network conditions and environmental factors, including volume of network traffic, building materials and construction, and network overhead lower actual data throughput rate.

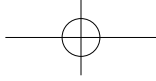

TECHNICAL SUPPORT

United Kingdom (Mon-Fri) website: <http://www.dlink.co.uk> FTP: <ftp://ftp.dlink.co.uk>
Home Wireless/Broadband 0871 873 3000 (9.00am–06.00pm, Sat 10.00am-02.00pm)
Managed, Smart, & Wireless Switches, or Firewalls 0871 873 0909 (09.00am- 05.30pm)
(BT 10ppm, other carriers may vary.)

Ireland (Mon-Fri)

All Products 1890 886 899 (09.00am-06.00pm, Sat 10.00am-02.00pm)
Phone rates: €0.05ppm peak, €0.045ppm off peak times

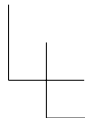
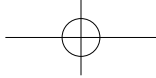

DAP-2360

Schnellinstallationsanleitung

DEUTSCH

Diese Installationsanleitung bietet Ihnen grundlegende Anleitungen zur Installation des DAP-2360 Wireless Access Point in Ihrem Netzwerk. Zusätzliche Informationen zur Verwendung des Access Point finden Sie im Benutzerhandbuch, das Ihnen auf der CD, die diesem Paket beiliegt, oder über die D-Link Support-Website zur Verfügung steht.

Systemanforderungen

Mindestsystemanforderungen:

- CD-ROM-Laufwerk
- Computer mit Windows®, Macintosh® oder Linux-basierten Betriebssystemen
- Installierter Ethernet-Adapter
- Internet Explorer Version 7.0 oder Firefox 3.0 und höher

1. Packungsinhalt

- DAP-2360 802.11n Access Point
- CD-ROM mit Software und Handbuch
- Netzteil (Stromadapter)
- Montageplatte
- Ethernetkabel

Sollte einer der oben aufgeführten Artikel fehlen, wenden Sie sich bitte an Ihren Fachhändler.

Sicherheitshinweis:

Installation und Wartungsarbeiten sollten nur von zertifizierten Technikern vorgenommen werden, zu jeder Zeit allen örtlich geltenden Richtlinien und Anforderungen entsprechen sowie verhindern, dass Ihr Garantieanspruch erlischt.

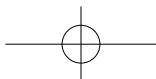

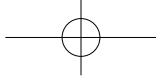

2. Hardware-Überblick

LAN – Leuchtet durchgehend, wenn der Ethernet-Port an einen ordnungsgemäß funktionierenden Port, wie etwa einen Router oder Switch, angeschlossen ist. Das Licht blinkt bei Datenverkehr über den LAN-Port.

2,4 GHz – Leuchtet, wenn der Access Point im 2,4-GHz-Bereich betrieben wird. Dieses Licht blinkt bei drahtlosem Datenverkehr.

POWER – Das Licht blinkt während des Hochfahrens. Sobald es durchgehend leuchtet, ist der Access Point betriebsbereit.

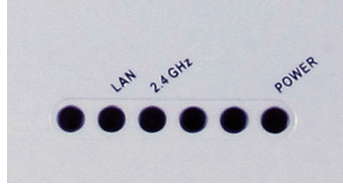

DEUTSCH

3. Hardware-Installation

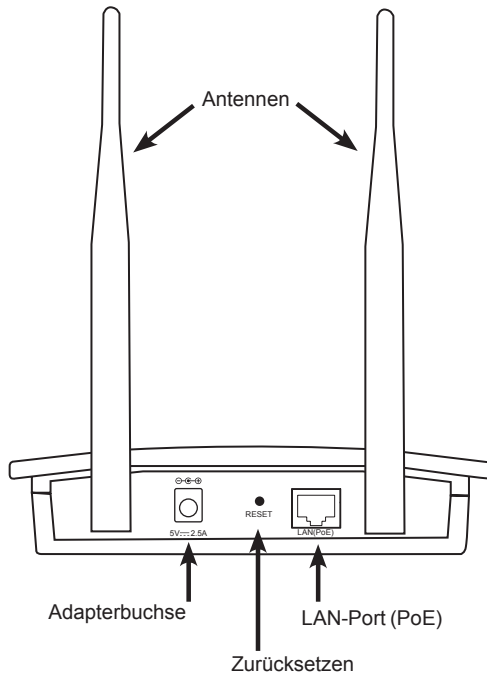

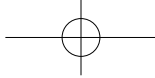

Zur Stromversorgung des Access Point wählen Sie eine der folgenden Optionen:

1. Verwenden Sie das mitgelieferte Netzteil (den Stromadapter).
2. Schließen Sie ein Ende Ihres Ethernetkabels an den LAN (PoE)-Port am DAP-2360 und das andere Ende an einen Port auf einem PoE-Switch an.

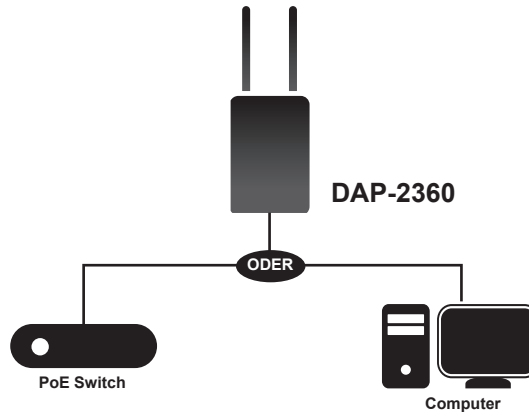

Zum Konfigurieren und Verwalten des DAP-2360 von einem Computer aus haben Sie zwei Möglichkeiten:

1. Verwenden Sie ein gerades Ethernetkabel (auch Straight-Through-Kabel genannt) zwischen dem Access Point und Ihrem Computer.
2. Schließen Sie den Access Point an einen Switch oder Router an und verwenden Sie einen Computer, der ebenfalls an diesen Switch bzw. Router angeschlossen ist.
3. Starten Sie Ihren Webbrowser, geben Sie die IP-Adresse des Geräts (<http://192.168.0.50>) ein und drücken Sie auf die Eingabetaste. Vergewissern Sie sich, dass sich die IP-Adressen des Geräts und Ihr Computer im gleichen Subnetz befinden. Alle weiteren Informationen zur Konfiguration finden Sie im Handbuch.



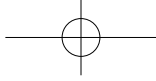

4. Befestigung der Montageplatte

Schritt 1: Bringen Sie die mitgelieferten Dübel in der Wand an, wo die Montageplatte befestigt werden soll.

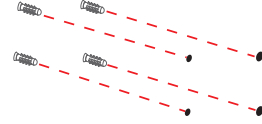

Schritt 2: Befestigen Sie die Montageplatte mit den mitgelieferten Schrauben an der Wand.

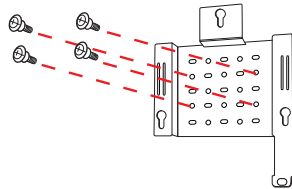

Schritt 3: Drehen Sie die restlichen Schrauben fest in die Rückseite des DAP-2360 ein.

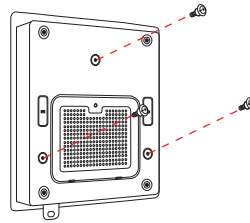

Schritt 4: Setzen Sie den DAP-2360 auf die Montageplatte.

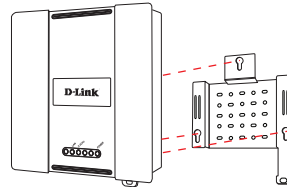

Schritt 5: Schieben Sie den DAP-2360 nach unten in die Rillen auf der Montageplatte, um es an der Platte zu befestigen.

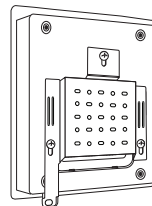

DEUTSCH

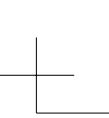
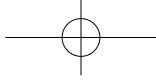

5. Ihr Setup ist abgeschlossen

Nach Durchführung der Schritte in dieser Installationsanleitung und der Konfiguration Ihres Netzwerkes sollte Ihr Netzwerk in etwa wie folgt aussehen:

DEUTSCH

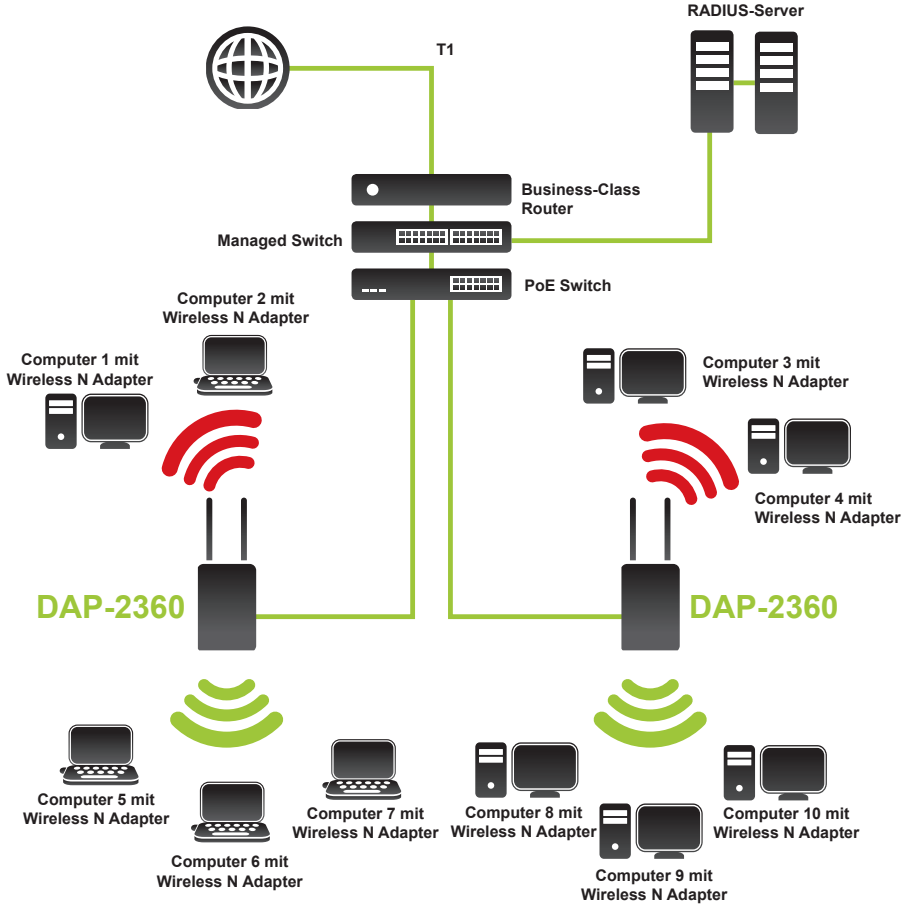

*Max. drahtlose Signalrate leitet sich aus den Spezifikationen der Standards IEEE 802.11n ab. Der tatsächliche Datendurchsatz schwankt. Netzwerkbedingungen und Umgebungsfaktoren, einschließlich Datenverkehr im Netz, Baumaterialien und Gebäudekonstruktionen sowie Netzwerk-Overhead senken die tatsächliche Datendurchsatzrate.

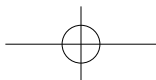

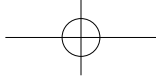

DEUTSCH

TECHNISCHE UNTERSTÜTZUNG

Deutschland: Web: <http://www.dlink.de>

Telefon: +49(0)1805 2787 0,14 € pro Minute Zeiten: Mo. –Fr. 09:00 – 17:30 Uhr

Österreich: Web: <http://www.dlink.at>

Telefon: +43(0)820 480084 0,116 € pro Minute Zeiten: Mo. –Fr. 09:00 – 17:30 Uhr

Schweiz: Web: <http://www.dlink.ch>

Telefon: +41(0)848 331100 0,08 CHF pro Minute Zeiten: Mo. –Fr. 09:00 – 17:30 Uhr

* Gebühren aus Mobilnetzen und von anderen Providern können abweichen.

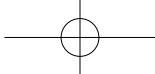

Guide d'installation rapide du DAP-2360

Ce guide d'installation fournit des instructions élémentaires qui vous aideront à installer le point d'accès sans fil DAP-2360 sur votre réseau. Pour obtenir des informations complémentaires sur l'utilisation du point d'accès, consultez le Manuel d'utilisation, disponible sur le CD joint à ce coffret, ou sur le site Web d'assistance D-Link.

Configuration système requise

FRANÇAIS

Configuration minimale requise :

- Lecteur de CD-ROM
- Ordinateur avec système d'exploitation Windows®, Macintosh® ou Linux
- Adaptateur Ethernet installé
- Internet Explorer 7,0 ou Firefox 3,0 et versions ultérieures

1. Contenu de la boîte

- Point d'accès DAP-2360 802.11n
- Manuel et logiciel sur CD-ROM
- Adaptateur secteur
- Plaque de montage
- Câble Ethernet

Contactez votre revendeur s'il manque l'un des éléments ci-dessus.

Remarque de sécurité :

L'installation et l'entretien doivent être réalisés par des techniciens qualifiés afin d'être conformes à tous les codes locaux et d'éviter d'annuler votre garantie.

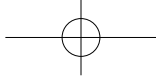

2. Description du matériel

LAN : ce voyant s'allume si le port Ethernet est connecté à un port actif, tel qu'un routeur ou un commutateur. Il clignote en cas de trafic sur le port LAN.

2.4 GHz : ce voyant s'allume si le point d'accès fonctionne à 2,4 GHz. Il clignote en cas de trafic sans fil.

POWER : ce voyant clignote pendant le démarrage. Il reste allumé quand le point d'accès est prêt.



3. Installation du matériel

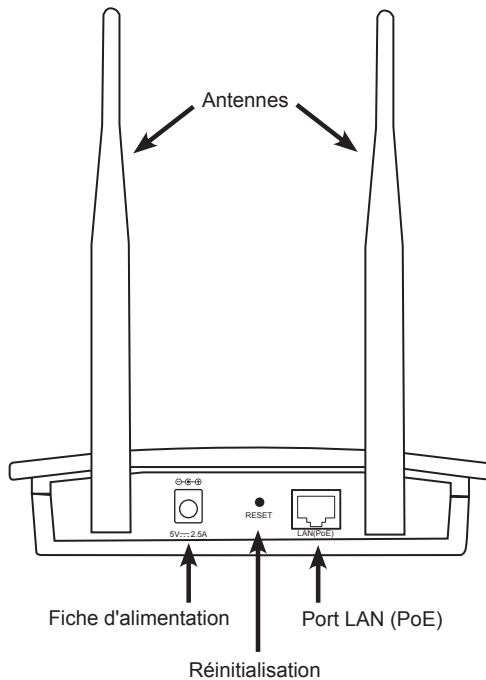

FRANÇAIS

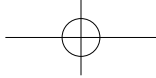

Pour alimenter le point d'accès, vous pouvez procéder de l'une des façons suivantes :

1. Utilisez l'adaptateur secteur fourni.
2. Brancher une extrémité du câble Ethernet au port LAN (PoE) du DAP-2360 et l'autre extrémité au port d'un commutateur PoE.

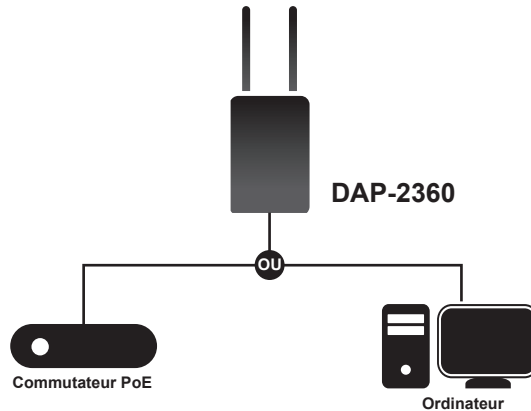

Pour configurer et gérer le DAP-2360 depuis un ordinateur, procédez de l'une des façons suivantes :

1. Branchez un câble Ethernet droit entre le point d'accès et votre ordinateur.
2. Connectez le point d'accès à un commutateur ou à un routeur et utilisez un ordinateur qui est également connecté à ce commutateur ou à ce routeur.
3. Démarrez votre navigateur Web, tapez l'adresse IP du périphérique ((<http://192.168.0.50>), puis appuyez sur Entrée. Assurez-vous que l'adresse IP de votre périphérique et que celle de votre ordinateur sont dans le même sous-réseau. Consultez ensuite le manuel pour effectuer la configuration.



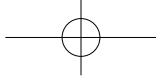

4. Fixation de la plaque de montage

Étape 1 : Mettez en place les chevilles murales fournies à l'endroit où vous souhaitez fixer la plaque de montage.

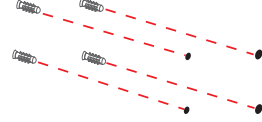

Étape 2 : Utilisez les vis fournies pour fixer la plaque de montage au mur.

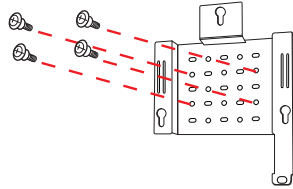

Étape 3 : Vissez les vis restantes à l'arrière du DAP-2360.

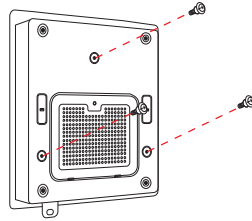

Étape 4 : Fixez le DAP-2360 à la plaque de montage.

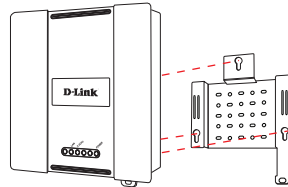

Étape 5 : Faites coulisser le DAP-2360 dans les rainures de la plaque de montage pour le fixer à la plaque.

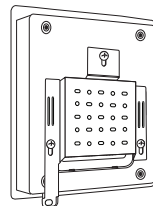

FRANÇAIS

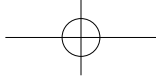

2. Configuration terminée

Après avoir suivi les étapes du guide d'installation et configuré votre réseau, ce dernier doit ressembler à cela :

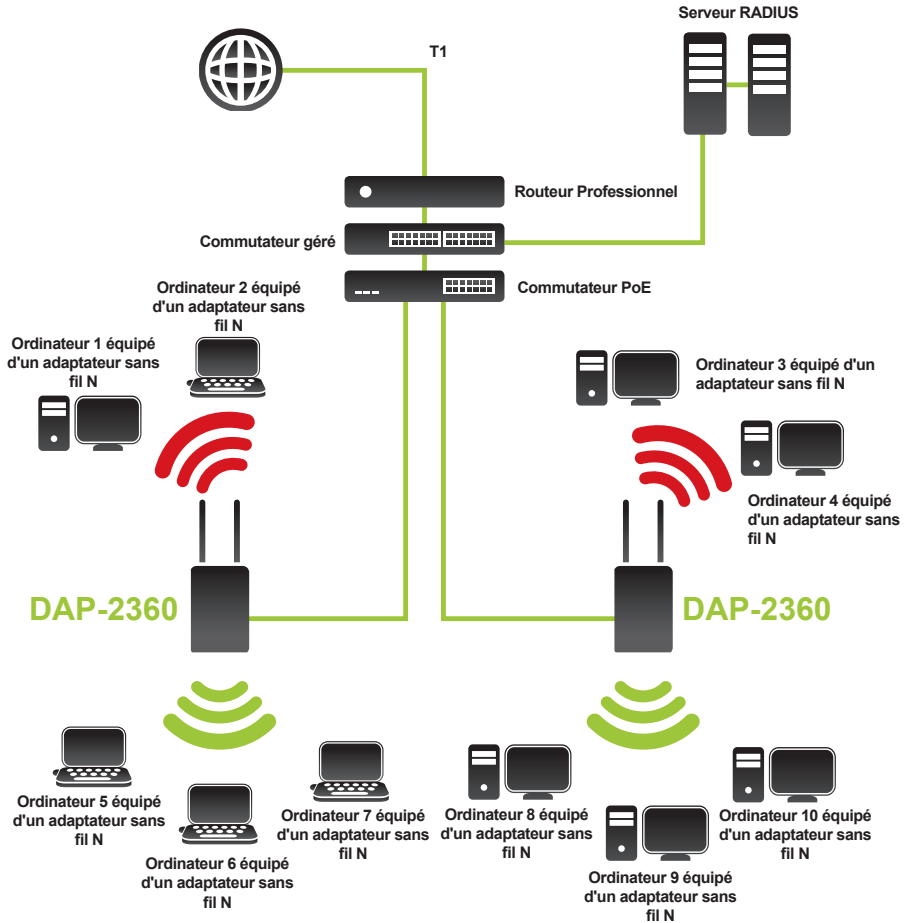

*Débit maximum du signal sans fil provenant des caractéristiques 802.11n de la norme IEEE. Le débit de transmission réel des données peut varier. Le surdébit, ainsi que les conditions du réseau et les facteurs environnementaux, dont l'importance du trafic réseau, les matériaux de construction et la structure, peuvent avoir des conséquences négatives sur le débit de transmission réel des données.

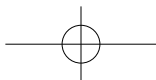

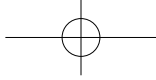

FRANÇAIS

ASSISTANCE TECHNIQUE

Assistance technique D-Link sur internet : <http://www.dlink.fr>
Assistance technique D-Link par téléphone : 0820 0803 03
0.12 € TTC/min depuis un poste fixe
Du lundi au vendredi de 9h à 19h (hors jours fériés)

D-Link DAP-2360 Quick Install Guide

19

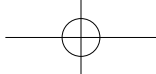

Guía de instalación rápida de DAP-2360

Esta guía de instalación proporciona instrucciones básicas para la instalación del punto de acceso inalámbrico DAP-2360 en su red. Para obtener información adicional acerca de cómo utilizar el punto de acceso, consulte el Manual del usuario disponible en el CD incluido en el paquete o en el sitio web de asistencia de D-Link.

Requisitos del sistema

Requisitos mínimos del sistema:

- Unidad de CD-ROM
- Ordenadores con sistemas operativos basados en Windows®, Macintosh® o Linux
- Adaptador Ethernet instalado
- Internet Explorer versión 7.0 o Firefox 3.0 y superior

1. ¿Qué contiene la caja?

- Punto de acceso DAP-2360 802.11n
- Manual y software en CD-ROM
- Adaptador de alimentación
- Placa de montaje
- Cable Ethernet

Si falta cualquiera de los componentes anteriores, póngase en contacto con el proveedor.

Aviso de seguridad:

La instalación y el mantenimiento deben realizarlo técnicos cualificados con el fin de cumplir con todos los códigos locales y evitar la anulación de la garantía.

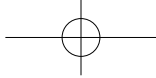

2. Descripción general del hardware

LAN - Luz fija cuando el puerto Ethernet está conectado a un puerto en funcionamiento, como un router o un conmutador. La luz parpadeará cuando exista tráfico a través del puerto de LAN.

2,4 GHz - Cuando está encendido, el punto de acceso funciona a 2,4 GHz. Esta luz parpadeará cuando exista tráfico inalámbrico.

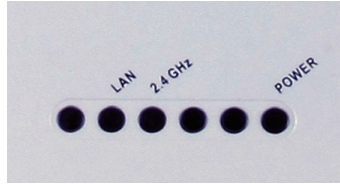

ALIMENTACIÓN - La luz parpadeará durante el proceso de arranque. Cuando está fija, el punto de acceso está preparado.

3. Instalación del hardware

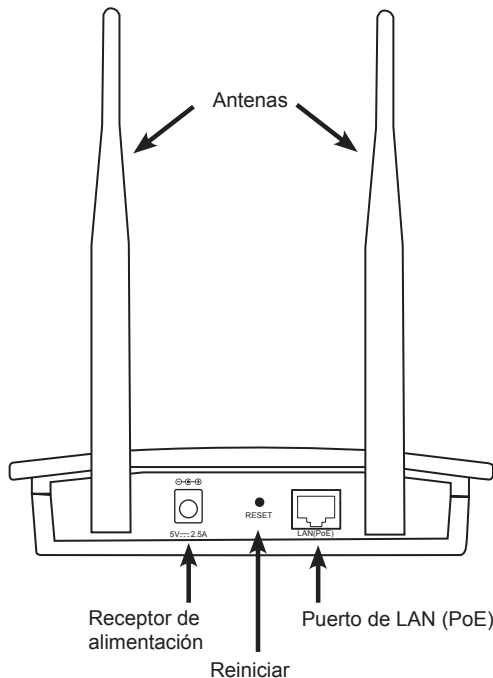

ESPAÑOL

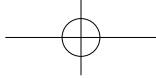

Para alimentar el punto de acceso, puede utilizar uno de los métodos siguientes:

1. Utilizar el adaptador de alimentación suministrado
2. Conectar un extremo del cable Ethernet al puerto de la LAN (PoE) en el DAP-2360 y el otro extremo a un puerto en un conmutador PoE.

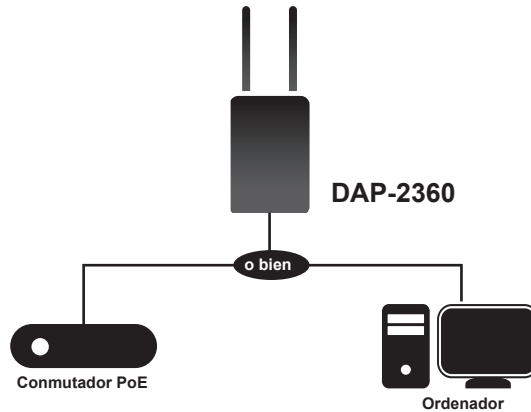

ESPAÑOL

Para instalar y gestionar el DAP-2360 desde un ordenador, utilice uno de los métodos siguientes:

1. Conectar un cable Ethernet directo entre el punto de acceso y su ordenador.
2. Conectar el punto de acceso a un conmutador o un router y utilizar un ordenador que esté también conectado a ese conmutador o router.
3. Inicie el programa del explorador de web, escriba la dirección IP del dispositivo (<http://192.168.0.50>) y pulse Intro. Asegúrese de que las direcciones IP del dispositivo y del ordenador estén en la misma subred. A continuación, consulte el Manual para realizar la configuración.



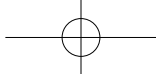

4. Ensamblar en la placa de montaje

Paso 1: Inserte los anclajes de pared suministrados en la pared en la que se va a fijar la placa de montaje.

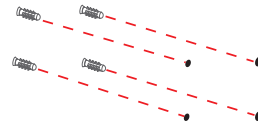

Paso 2: Utilice los tornillos suministrados para fijar la placa de montaje en la pared.

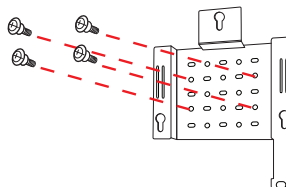

Paso 3: Fije firmemente el resto de los tornillos a la parte posterior del DAP-2360.

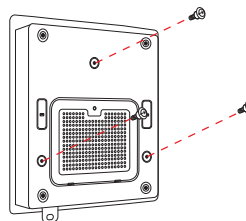

Paso 4: Acople el DAP-2360 a la placa de montaje.

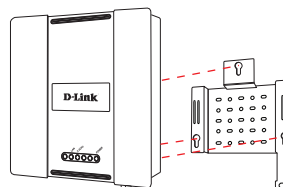

Paso 5: Deslice hacia abajo el DAP-2360 por las bahías de la placa de montaje para fijarlo a la placa.

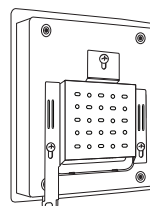

ESPAÑOL

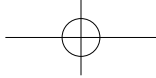

5. Su instalación se ha finalizado

Cuando haya completado los pasos de esta Guía de instalación y haya configurado el equipo para su red, la red tendrá un aspecto parecido al siguiente:

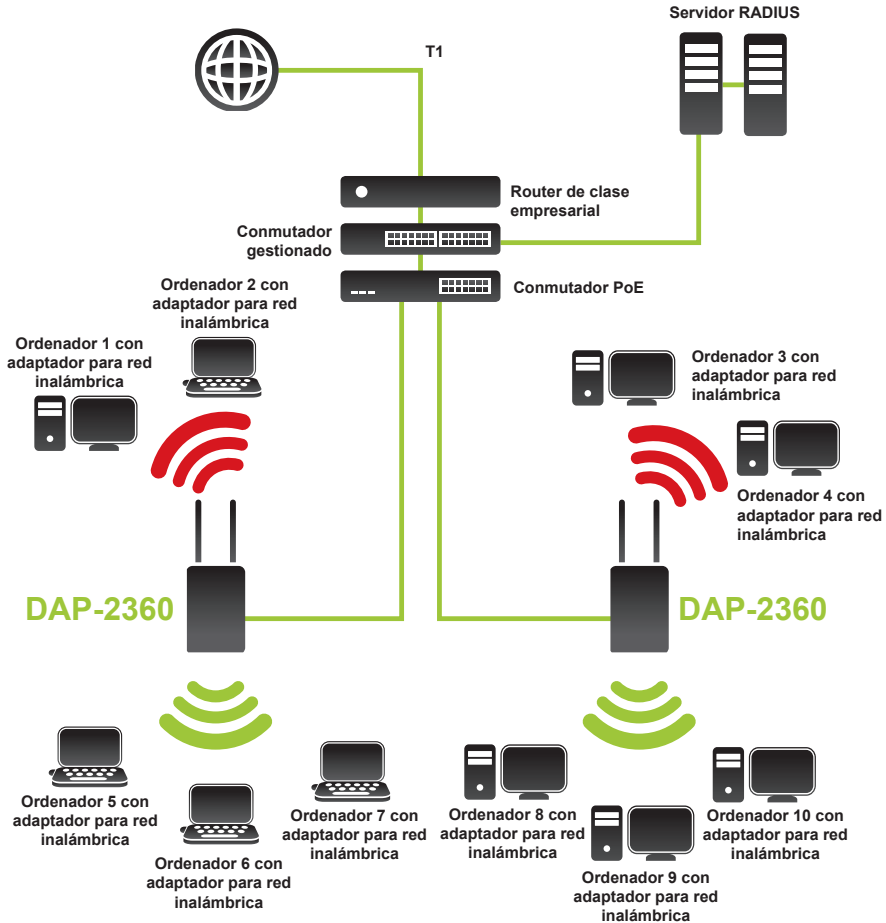

* Frecuencia de señal inalámbrica máxima según las especificaciones de la norma IEEE 802.11n. El rendimiento real de datos puede variar. Las condiciones de red y los factores ambientales, incluido el volumen de tráfico de la red, los materiales y la construcción y la carga de la red reducen la tasa de rendimiento real de los datos.

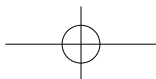

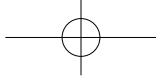

ESPAÑOL

ASISTENCIA TÉCNICA

<http://www.dlink.es>

Asistencia Técnica Telefónica de D-Link: +34 902 30 45 45 0,067 €/min

De Lunes a Viernes de 9:00 a 19:00

D-Link DAP-2360 Quick Install Guide

25

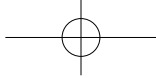

Guida di installazione rapida di DAP-2360

In questa guida di installazione sono riportate le istruzioni di base per installare il punto di accesso wireless DAP-2360 Wireless Access Point in rete. Per ulteriori informazioni sull'utilizzo del punto di accesso, consultare il manuale utente disponibile sul CD incluso nella confezione o scaricabile dal sito Web di supporto di D-Link.

Requisiti di sistema

Requisiti minimi di sistema:

- Unità CD-ROM
- Computer dotati di sistema operativo Windows®, Macintosh® o Linux
- Scheda Ethernet installata
- Internet Explorer versione 7.0 o Firefox 3.0 e versioni successive

1. Contenuto della confezione

- DAP-2360 802.11n Access Point
- Manuale e software su CD-ROM
- Alimentatore
- Piastra di montaggio
- Cavo Ethernet

Se uno o più degli articoli sopra elencati risultano mancanti, rivolgersi al rivenditore.

Nota relativa alla sicurezza:

Per evitare di invalidare la garanzia, l'installazione e le riparazioni devono essere effettuate da tecnici qualificati in conformità alle normative locali.

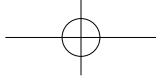

2. Panoramica hardware

LAN - La spia è fissa quando la porta Ethernet è collegata a una porta funzionante, ad esempio un router o uno switch. La spia lampeggia in presenza di traffico gestito tramite la porta LAN.

2.4 GHz - Quando è accesa, la spia indica che il punto di accesso opera a 2,4 GHz. La spia lampeggia in presenza di traffico wireless.

POWER - La spia lampeggia all'accensione. Quando è fissa, indica che il punto di accesso è pronto per l'uso.



3. Installazione dell'hardware

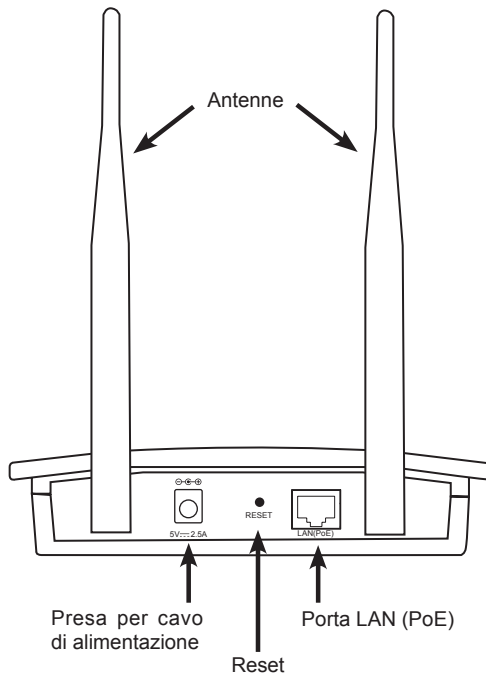

ITALIANO

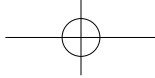

Per attivare il punto di accesso, è possibile utilizzare uno dei seguenti metodi:

1. Utilizzare l'alimentatore fornito in dotazione
2. Collegare un'estremità del cavo Ethernet alla porta LAN (PoE) sul DAP-2360 e l'altra estremità a una porta di uno switch PoE.

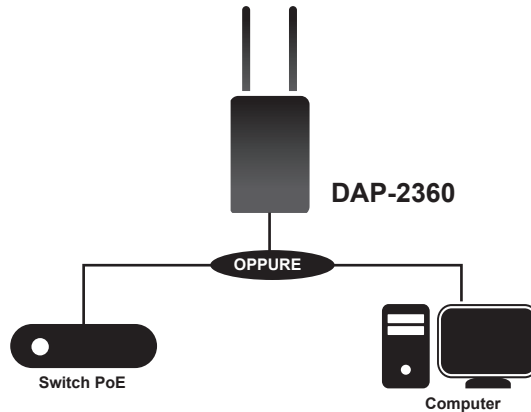

ITALIANO

Per configurare e gestire il dispositivo DAP-2360 da un computer, utilizzare uno dei seguenti metodi:

1. Collegare un cavo dritto (straight through) Ethernet tra il punto di accesso e il computer.
2. Collegare il punto di accesso a uno switch o a un router e utilizzare un computer collegato allo stesso switch o router.
3. Avviare il browser Internet, immettere l'indirizzo IP del dispositivo (<http://192.168.0.50>) e premere Invio. Assicurarsi che gli indirizzi IP del dispositivo e quello del computer in uso si trovino nella stessa subnet. Quindi consultare il Manuale per la configurazione.



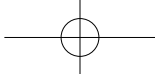

4. Assemblaggio della piastra di montaggio

Passo 1: Inserire i tasselli forniti nella parete in cui si intende installare la piastra di montaggio.

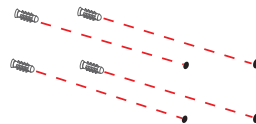

Passo 2: Utilizzare le viti fornite per fissare la piastra di montaggio alla parete.

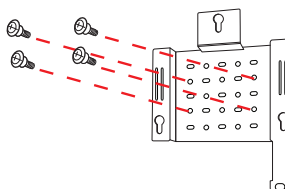

Passo 3: Fissare le viti rimanenti sul retro del dispositivo DAP-2360.

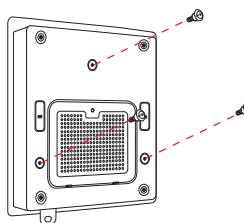

Passo 4: Fissare il dispositivo DAP-2360 alla piastra di montaggio.

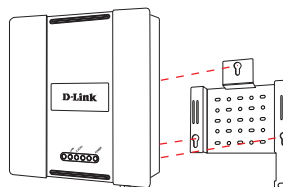

Passo 5: Far scorrere il dispositivo DAP-2360 verso il basso nelle scanalature presenti sulla piastra di montaggio per fissarlo.

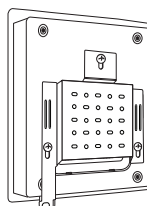

ITALIANO

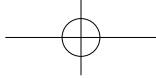

5. Installazione completata

Dopo aver completato le operazioni descritte nella presente Guida di installazione e aver configurato il punto di accesso per la rete, la rete in uso sarà simile alla seguente:

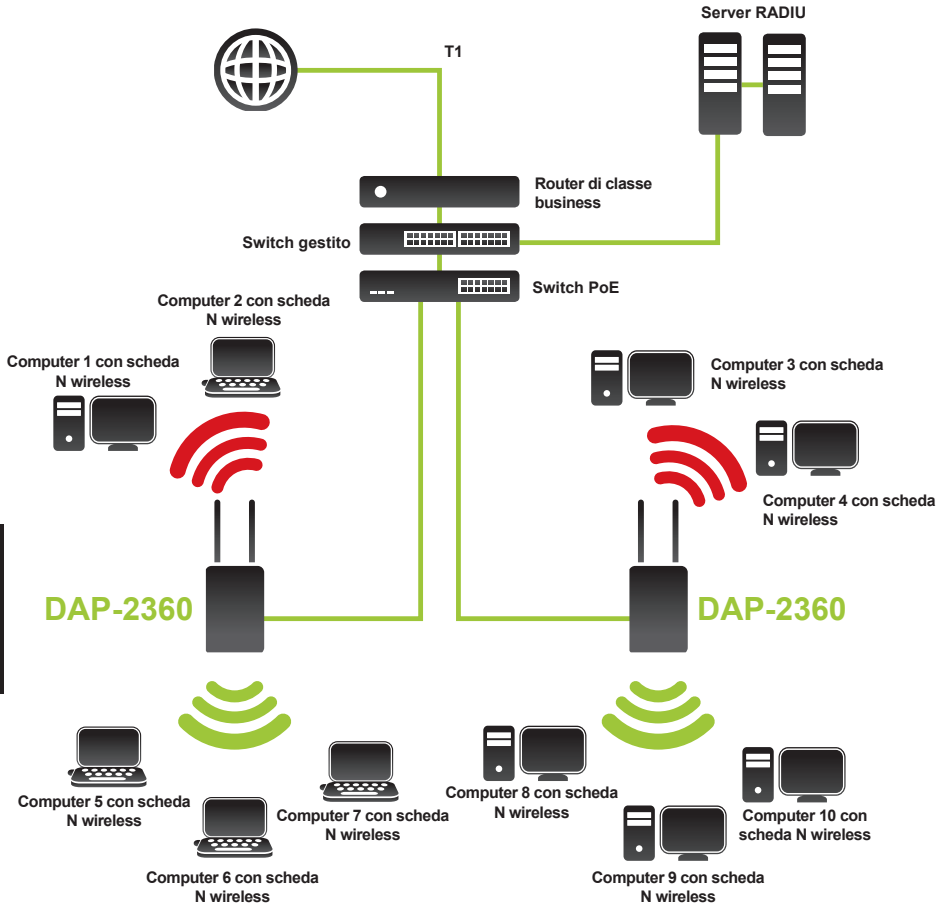

ITALIANO

* Velocità massima del segnale wireless derivata dalle specifiche IEEE 802.11n. La velocità effettiva di trasferimento dati potrebbe variare. Le condizioni della rete e fattori ambientali, tra cui il volume del traffico di rete, i materiali e la struttura dell'edificio, nonché il sovraccarico della rete, possono infatti ridurre la velocità effettiva di trasferimento dei dati.

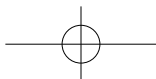

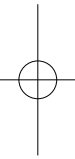
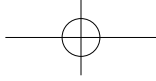

reda

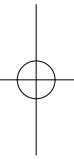

ITALIANO

SUPPORTO TECNICO

<http://www.dlink.it/support>

Supporto Tecnico dal lunedì al venerdì dalle ore 9.00 alle ore 19.00 con orario continuato

Telefono: 199400057

D-Link DAP-2360 Quick Install Guide

31

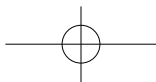

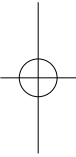
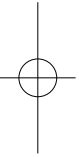
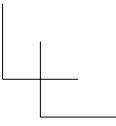
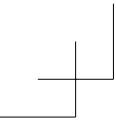
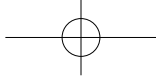

D-Link®



Ver. 1.00(EU)
2011/09/13
6AP2360QWW01G

